

myprojectorlamps.com

**The most trusted, dependable name
in projector lamp sales.**



<http://www.myprojectorlamps.com>



<http://www.myprojectorlamps.ca>



<http://www.myprojectorlamps.eu>

The following projector manual has not been modified or altered in any way.

IN100 (SERIES)

Reference Guide



InFocus
Bright Ideas Made Brilliant

Regulatory models T102, T104
5B.13201.001

Table of contents

Introduction..... 3

Projector features.....	3
Shipping contents	4
Projector exterior view	5
Controls and functions	6

Positioning your projector 9

Choosing a location	9
Obtaining a preferred projected image size.....	10

Connection..... 13

Connecting a computer or monitor	14
Connecting video source devices.....	16

Operation..... 20

Starting up the projector.....	20
Using the menus	21
Utilizing the password function	22
Switching input signal	24
Adjusting the projected image.....	25
Magnifying and searching for details.....	27
Selecting the aspect ratio.....	27
Optimizing the image	29
Setting the presentation timer	33
Hiding the image	34
Locking control keys	34
Freezing the image	35
Operating in a high altitude environment	35
Adjusting the sound	35

Personalizing the projector menu display.....	36
Shutting down the projector	36
Menu operation.....	37

Maintenance..... 44

Care of the projector	44
Lamp information	45

Troubleshooting 51

Specifications 52

Projector specifications.....	52
Dimensions	53
Timing chart	53

Copyright information 55

Introduction

Projector features

The projector integrates high-performance optical engine projection and a user-friendly design to deliver high reliability and ease of use.

The projector offers the following features.

- Wall color correction allowing projection on surfaces of several predefined colors
- Quick auto search speeding up the signal detecting process
- Selectable password protected function
- Up to 11 sets of picture modes providing multiple choices for different projection purposes
- 3D color management allowing color adjustments to your liking
- Selectable quick cooling function makes the projector cool in a shorter time
- Presentation timer for better control of time during presentations
- One-key auto-adjustment to display the best picture quality
- Digital keystone correction to correct distorted images
- Adjustable color balance control for data/video display
- High brightness projection lamp
- Ability to display 16.7 million colors
- Multi-language On-Screen Display (OSD) menus
- Switchable normal and economic modes to reduce the power consumption
- Component HDTV compatibility (YPbPr)
- High quality manual zoom lens



- **The apparent brightness of the projected image will vary depending on the ambient lighting conditions, selected input signal contrast/brightness settings, and is directly proportional to projection distance.**
- **The lamp brightness will decline over time and may vary within the lamp manufacturer's specifications. This is normal and expected behavior.**

Shipping contents

Carefully unpack and verify that you have all of the items shown below. If any of these items are missing, please contact your place of purchase.

Standard accessories

 The supplied accessories will be suitable for your region, and may differ from those illustrated.

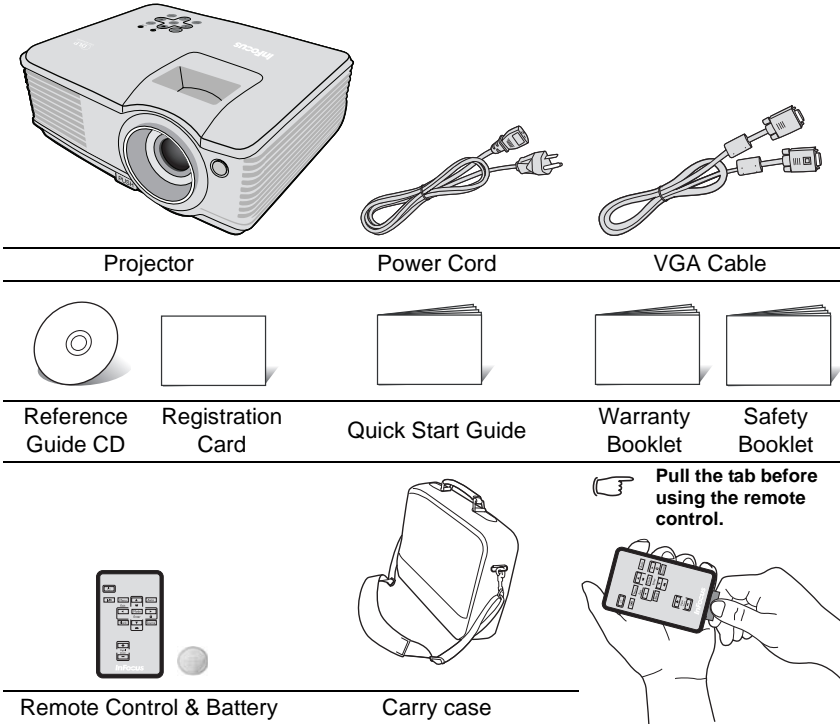

Optional accessories

1. Ceiling mount, wall mount
2. LiteShow II wireless presentation adaptor
3. Pull down and pull up 4:3 screens
4. Cables and adaptors
5. Replacement lamp
6. Optional remote
7. Projector lock system

Projector exterior view

Front/upper side

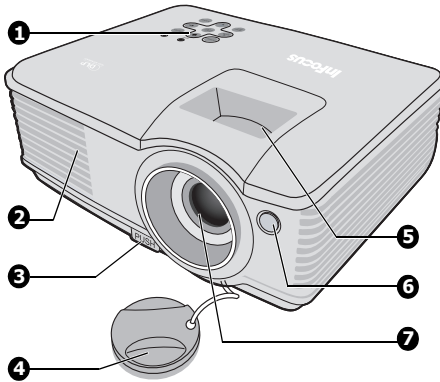

1. External control panel
(See "[Projector and remote control](#)" on page 6 for details.)
2. Vent (heated air exhaust)
3. Quick-release button
4. Lens cover
5. Focus ring and Zoom ring
6. Front IR remote sensor
7. Projection lens

Rear/lower side

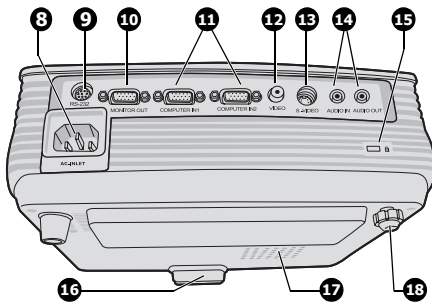

8. AC power cord inlet
9. RS-232 control port
10. RGB signal output socket
11. RGB (PC)/Component video (YPbPr/YCbCr) signal input socket
12. Video input socket
13. S-Video input socket
14. Audio signal input socket
Audio signal output socket
15. Kensington anti-theft lock slot
16. Quick-release foot
17. Lamp cover
18. Rear adjuster foot

Warning

- **THIS APPARATUS MUST BE GROUNDED.**
- **When installing the unit, make certain that the associated wall switch or AC power outlet is easily accessible, so that the unit can be quickly disconnected if needed.**

Controls and functions

Projector and remote control

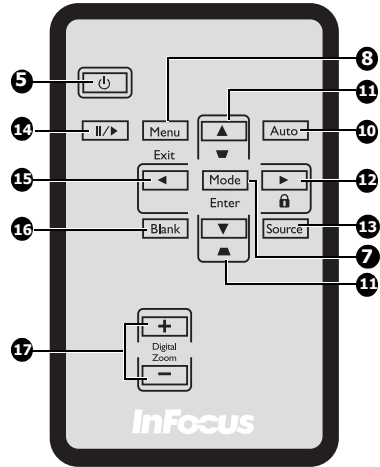
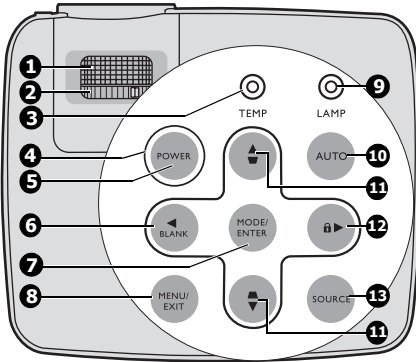

1. Focus ring

Adjusts the focus of the projected image. See "[Fine-tuning the image size and clarity](#)" on page 26 for details.

2. Zoom ring

Adjusts the size of the image. See "[Fine-tuning the image size and clarity](#)" on page 26 for details.

3. TEMPerature indicator light

Lights up red if the projector's temperature becomes too high. See "[Indicators](#)" on page 50 for details.

4. POWER indicator light

Lights up or flashes when the projector is under operation. See "[Indicators](#)" on page 50 for details.

5. POWER

Toggles the projector between standby mode and on. See "[Starting up the projector](#)" on page 20 and "[Shutting down the projector](#)" on page 36 for details.

6. ◀ Left/BLANK

Used to hide the screen picture. See "[Hiding the image](#)" on page 34 for details.

7. MODE/ENTER

Selects an available picture setup mode. See "[Selecting a picture mode](#)" on page 29 for details.

Enacts the selected On-Screen Display (OSD) menu item.

- 8. MENU/EXIT**
Turns on the On-Screen Display (OSD) menu. Goes back to previous OSD menu, exits and saves menu settings. See ["Using the menus" on page 21](#) for details.
- 9. LAMP indicator light**
Indicates the status of the lamp. Lights up or flashes when the lamp has developed a problem. See ["Indicators" on page 50](#) for details.
- 10. AUTO**
Automatically determines the best picture timings for the displayed image. See ["Auto-adjusting the image" on page 25](#) for details.
- 11. Keystone/Arrow keys (▾ / ▲ Up, ▲ / ▼ Down)**
Manually corrects distorted images resulting from an angled projection. See ["Correcting keystone" on page 26](#) for details.
- 12. ► Right / 🔒**
Activates panel key lock. See ["Locking control keys" on page 34](#) for details. When the On-Screen Display (OSD) menu is activated, the #6, #11, and #12 keys are used as directional arrows to select the desired menu items and to make adjustments. See ["Using the menus" on page 21](#) for details.
- 13. SOURCE**
Displays the source selection bar. See ["Switching input signal" on page 24](#) for details.
- 14. ||► Freeze**
Freezes the projected image. See ["Freezing the image" on page 35](#) for details.
- 15. ◀ Left**
Selects the desired menu items and makes adjustments. See ["Using the menus" on page 21](#) for details.
- 16. BLANK**
Used to hide the screen picture. See ["Hiding the image" on page 34](#) for details.
- 17. Digital Zoom keys (+, -)**
Magnifies or reduces the projected picture size. See ["Magnifying and searching for details" on page 27](#) for details.

Remote control effective range

Infra-Red (IR) remote control sensor is located on the front of the projector. The remote control must be held at an angle within 30 degrees perpendicular to the projector's IR remote control sensor to function correctly. The distance between the remote control and the sensor should not exceed 8 meters (~ 26 feet).

Make sure that there are no obstacles between the remote control and the IR sensor on the projector that might obstruct the infra-red beam.

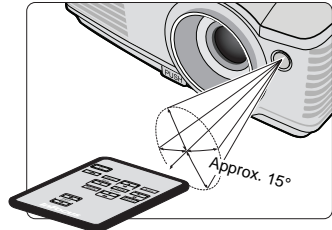

Replacing the remote control battery

1. Pull out the battery holder.

 Please follow the illustrated instructions. Push and hold the locking arm while pulling out the battery holder.

2. Insert the new battery (Type: CR-2025) in the holder. Note the positive polarity should face outward.
3. Push the holder into the remote control.

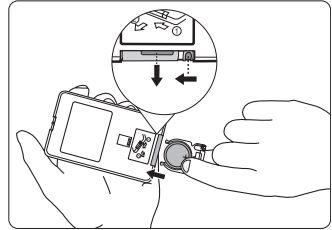

CAUTION

- Avoid excessive heat and humidity.
- There may be battery damage if the battery is incorrectly replaced.
- Replace only with the same or equivalent type recommended by the battery manufacturer.
- Dispose of the used battery according to the battery manufacturer's instructions.
- Never throw a battery into a fire. There may be danger of an explosion.
- If the battery is dead or if you will not be using the remote control for a long time, remove the battery to prevent damage to the remote control from possible battery leakage.

Positioning your projector

Choosing a location

Your room layout or personal preference will dictate which installation location you select. Take into consideration the size and position of your screen, the location of a suitable power outlet, as well as the location and distance between the projector and the rest of your equipment.

Your projector is designed to be installed in one of four possible installation locations:

1. Front Table

Select this location with the projector placed near the floor in front of the screen. This is the most common way to position the projector for quick setup and portability.

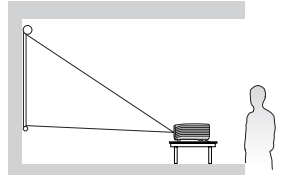

2. Front Ceiling

Select this location with the projector suspended upside-down from the ceiling in front of the screen.

Purchase the InFocus ceiling mount, SP-CEIL-UNIV, from your dealer to mount your projector on the ceiling.

Set **Front Ceiling** in the **SYSTEM SETUP: Basic > Projector Position** menu after you turn the projector on.

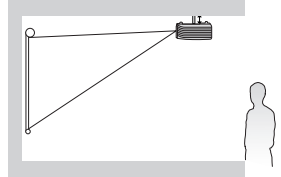

3. Rear Table

Select this location with the projector placed near the floor behind the screen.

Note that a special rear projection screen is required.

Set **Rear Table** in the **SYSTEM SETUP: Basic > Projector Position** menu after you turn the projector on.

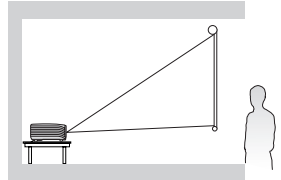

4. Rear Ceiling

Select this location with the projector suspended upside-down from the ceiling behind the screen.

Note that a special rear projection screen and the InFocus ceiling mount, SP-CEIL-UNIV, are required for this installation location.

Set **Rear Ceiling** in the **SYSTEM SETUP: Basic > Projector Position** menu after you turn the projector on.

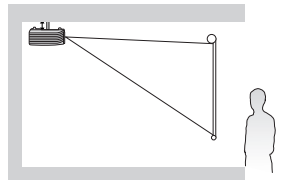

Obtaining a preferred projected image size

The distance from the projector lens to the screen, the zoom setting, and the video format all factor into the resulting projected image size.

4:3 is the native aspect ratio of this projector. To be able to project a complete 16:9 (widescreen) aspect ratio image, the projector can resize and scale a widescreen image to the projector's native aspect width. This will result in a proportionally smaller height equivalent to 75% of the projector's native aspect height.

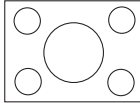

4:3 aspect image in a 4:3 aspect display area

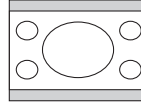

16:9 aspect image scaled to a 4:3 aspect display area

Thus, a 16:9 aspect image will not utilize 25% of the height of a 4:3 aspect image displayed by this projector. This will be seen as darkened (unlit) bars along the top and bottom (vertical 12.5% height respectively) of the 4:3 projection display area whenever displaying a scaled 16:9 aspect image in the vertical center of the 4:3 projection display area.

The projector should always be placed horizontally level (like flat on a table), and positioned directly perpendicular (90° right-angle square) to the horizontal center of the screen. This prevents image distortion caused by angled projections (or projecting onto angled surfaces).

The modern digital projector does not project directly forward (like older style reel-to-reel film projectors did). Instead, digital projectors are designed to project at a slightly upward angle above the horizontal plane of the projector. This is so that they can be readily placed on a table and will project forward and upwards onto a screen positioned so that the bottom edge of the screen is above the level of the table (and everyone in the room can see the screen).

If the projector is mounted on a ceiling, it must be mounted upside-down so that it projects at a slightly downward angle.

You can see from the diagram on page 12, that this type of projection causes the bottom edge of the projected image to be vertically offset from the horizontal plane of the projector. When ceiling mounted, this refers to the top edge of the projected image.

If the projector is positioned further away from the screen, the projected image size increases, and the vertical offset also increases proportionately.

When determining the position of the screen and projector, you will need to account for both the projected image size and the vertical offset dimension, which are directly proportional to the projection distance.

InFocus has provided a table of 4:3-aspect-ratio screen sizes to assist you in determining the ideal location for your projector. There are two dimensions to consider, the perpendicular horizontal distance from the center of the screen (projection distance), and the vertical offset height of the projector from the horizontal edge of the screen (offset).

How to determine the position of the projector for a given screen size

1. Select your screen size.
2. Refer to the table and find the closest match to your screen size in the left columns labelled "4:3 screen diagonal". Using this value, look across this row to the right to find the corresponding average distance from screen value in the column labelled "Average". This is the projection distance.
3. On that same row, look across to the right column and make note of the "Vertical offset" value. This will determine the final vertical offset placement of the projector in relation to the edge of the screen.
4. The recommended position for the projector is aligned perpendicular to the horizontal center of the screen, at the distance from the screen determined in step 2 above, and offset by the value determined in step 3 above.

For example, if you are using a 108-inch screen, the average projection distance is 4320 mm (170") and with a vertical offset of 82 mm (3.2").

If you place the projector in a different position (to that recommended), you will have to tilt it down or up to center the image on the screen. In these situations, some image distortion will occur. Use the Keystone function to correct the distortion. See "Correcting keystone" on page 26 for details.

How to determine the recommended screen size for a given distance

This method can be used for situations where you have purchased this projector and would like to know what screen size will fit in your room.

The maximum screen size is limited by the physical space available in your room.

1. Measure the distance between the projector and where you want to position the screen. This is the projection distance.
2. Refer to the table and find the closest match to your measurement in the average distance from screen column labelled "Average". If the min and max values are available on the table, check that your measured distance is between the min and max distances listed on either side of the average distance value.
3. Using this value, look across that row to the left to find the corresponding screen diagonal listed in that row. That is the projected image size of the projector at that projection distance.
4. On that same row, look across to the right column and make note of the "Vertical offset" value. This will determine the final placement of the screen in relation to the horizontal plane of the projector.

For example, if your measured projection distance was 4.5 m (177"), the closest match in the "Average" column is 4320 mm (170"). Looking across this row shows that a 108-inch screen is required.

Projection dimensions

Refer to "Dimensions" on page 53 for the center of lens dimensions of this projector before calculating the appropriate position.

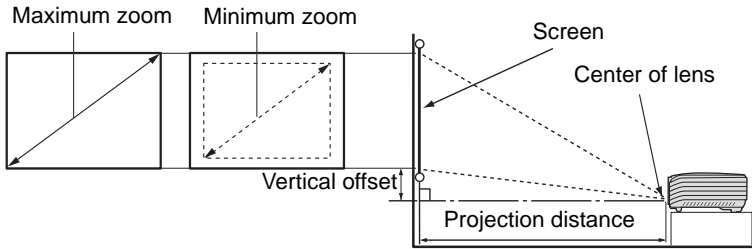

4:3 screen diagonal			Recommended projection distance from screen						Vertical offset	
			Min length (with max. zoom)		Average		Max length (with min. zoom)			
Feet	Inches	mm	mm	Inches	mm	Inches	mm	Inches	mm	Inches
4	48	1219	1829	72	1920	76	2011	79	37	1.4
	59	1500	2250	89	2362	93	2475	97	45	1.8
5	60	1524	2286	90	2400	94	2514	99	46	1.8
	72	1829	2743	108	2880	113	3017	119	55	2.2
6	79	2000	3000	118	3150	124	3300	130	60	2.4
	84	2134	3200	126	3360	132	3520	139	64	2.5
8	96	2438	3657	144	3840	151	4023	158	73	2.9
	98	2500	3750	148	3937	155	4124	162	75	3.0
9	108	2743	4114	162	4320	170	4526	178	82	3.2
	118	3000	4499	177	4724	186	4949	195	90	3.5
10	120	3048	4571	180	4800	189	5029	198	91	3.6
	138	3500	5249	207	5512	217	5774	227	105	4.1
12	144	3658	5486	216	5760	227	6034	238	110	4.3
	157	4000	5999	236	6299	248	6599	260	120	4.7
15	180	4572	6857	270	7200	283	7543	297	137	5.4
	197	5000	7499	295	7874	310	8249	325	150	5.9
18	216	5486	8229	324	8640	340	9051	356	165	6.5
	236	6000	8999	354	9449	372	9899	390	180	7.1
25	300	7620	11429	450	12000	472	12571	495	229	9.0

 There is 3% tolerance among these numbers due to optical component variations. InFocus recommends that if you intend to permanently install the projector, you should physically test the projection size and distance using the actual projector before you permanently install it, so as to make allowance for this projector's optical characteristics. This will help you determine the exact mounting position so that it best suits your installation location.

Connection

When connecting a signal source to the projector, be sure to:

1. Turn all equipment off before making any connections.
2. Use the correct signal cables for each source.
3. Ensure the cables are firmly inserted.

 In the connections shown below, some cables may not be included with the projector (see ["Shipping contents" on page 4](#)). Additional cables can be purchased from InFocus.com in select areas, your dealer and/or from a commercial electronics store.

Connecting a computer or monitor

Connecting a computer

The projector provides a VGA input socket that allows you to connect it to both IBM® compatibles and Macintosh® computers. A Mac adapter is needed if you are connecting legacy version Macintosh computers.

To connect the projector to a notebook or desktop computer:

1. Take the supplied VGA cable and connect one end to the D-Sub output socket of the computer.
2. Connect the other end of the VGA cable to the **COMPUTER IN1/COMPUTER IN2** signal input socket on the projector.
3. If you wish to make use of the projector (mixed mono) speaker in your presentations, take a suitable audio cable and connect one end of the cable to the audio output socket of the device, and the other end to the **AUDIO IN** socket of the projector.
4. If you wish, you can use another suitable audio cable and connect one end of the cable to the **AUDIO OUT** jack of the projector, and the other end to your external speakers (not supplied).

Once connected, the audio can be controlled by the projector On-Screen Display (OSD) menus. See ["Adjusting the sound" on page 35](#) for details.

The built-in speaker will be muted when the **AUDIO OUT** jack is connected.

The final connection path should be like that shown in the following diagram:

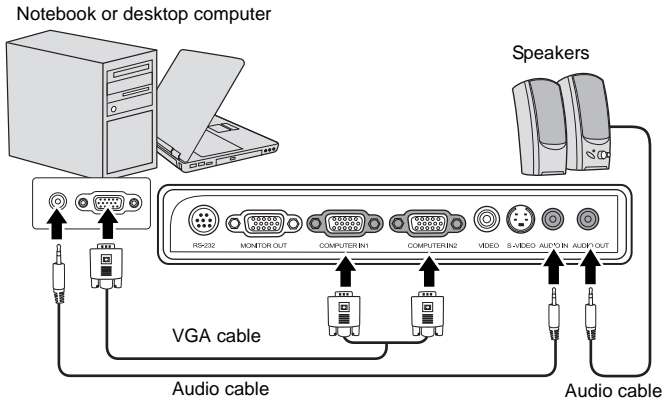

 Many notebooks do not turn on their external video ports when connected to a projector. Usually a key combo like FN + F3 or CRT/LCD key turns the external display on/off. Locate a function key labeled CRT/LCD or a function key with a monitor symbol on the notebook. Press FN and the labeled function key simultaneously. Refer to your notebook's documentation to find your notebook's key combination.

Connecting a monitor

If you want to view your presentation close-up on a monitor as well as on the screen, you can connect the **MONITOR OUT** signal output socket on the projector to an external monitor with a VGA cable following the instructions below:

To connect the projector to a monitor:

1. Connect the projector to a computer as described in "[Connecting a computer](#)" on page 14.
2. Take a suitable VGA cable (only one supplied) and connect one end of the cable to the D-Sub input socket of the video monitor.
Or if your monitor is equipped with a DVI input socket, take a VGA to DVI-A cable and connect the DVI end of the cable to the DVI input socket of the video monitor.
3. Connect the other end of the cable to the **MONITOR OUT** socket on the projector.

The final connection path should be like that shown in the following diagram:

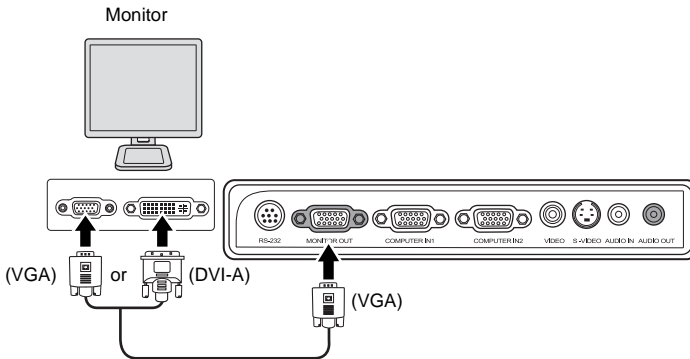

- **The D-Sub output only works when an appropriate D-Sub input is made to the COMPUTER IN1 jack.**
- **If you wish to use this connection method when the projector is in standby mode, make sure the VGA Out function is turned on in the SYSTEM SETUP: Advanced menu. See "[VGA Out](#)" on page 43 for details.**

Connecting video source devices

You can connect your projector to various video source devices that provide any one of the following output sockets:

- Component video
- S-Video
- Video (composite)

You only need to connect the projector to a single video source device; however each provides a different level of video quality. The method you choose will most likely depend upon the availability of matching terminals on both the projector and the video source device as described below:

Best video quality

The best available video connection method is Component video (not to be confused with composite video). Digital TV tuner and DVD players output Component video natively, so if available on your devices, this should be your connection method of choice in preference to (composite) video.

See "[Connecting a Component video source device](#)" on page 17 for how to connect the projector to a component video device.

Better video quality

The S-Video method provides a better quality analog video than standard composite video. If you have both composite video and S-Video output terminals on your video source device, you should elect to use the S-Video option.

See "[Connecting an S-Video source device](#)" on page 18 for how to connect the projector to an S-Video device.

Good video quality

Composite video is analog video and will result in a perfectly acceptable, but less than optimal result from your projector. The other methods described above provide better video quality.

See "[Connecting a composite video source device](#)" on page 19 for how to connect the projector to a composite video device.

Connecting audio

The projector has one built-in mono speaker which is designed to provide basic audio functionality accompanying data presentations for business purposes only. It is not designed for, nor intended for stereo audio reproduction use as might be expected in home theater or home cinema applications. Any stereo audio input (if provided), is mixed into a common mono audio output through the projector speaker.

If you have a separate sound system, you will most likely want to connect the audio output of your video source device to that sound system, instead of to the mono audio projector. The audio connections are provided for informational purposes only. You need not connect audio to the projector if there is an alternate sound system available, or if audio is not required.

Connecting a Component video source device

Examine your video source device to determine if it has a set of unused Component video output sockets available:

- If so, you can continue with this procedure.
- If not, you will need to reassess which method you can use to connect to the device.

To connect the projector to a Component video source device:

1. Take a Component video to VGA (D-Sub) adaptor cable and connect the end with 3 RCA type connectors to the Component video output sockets of the video source device. Match the color of the plugs to the color of the sockets; green to green, blue to blue, and red to red.
2. Connect the other end of the Component video to VGA (D-Sub) adaptor cable (with a D-Sub type connector) to the **COMPUTER IN1/COMPUTER IN2** socket on the projector.
3. If you wish to make use of the projector (mixed mono) speaker in your presentations, take a suitable audio cable and connect one end of the cable to the audio output socket of the device, and the other end to the **AUDIO IN** socket of the projector.
4. If you wish, you can use another suitable audio cable and connect one end of the cable to the **AUDIO OUT** jack of the projector, and the other end to your external speakers (not supplied).

Once connected, the audio can be controlled by the projector On-Screen Display (OSD) menus. See "[Adjusting the sound](#)" on page 35 for details.

The built-in speaker will be muted when the **AUDIO OUT** jack is connected.

The final connection path should be like that shown in the following diagram:

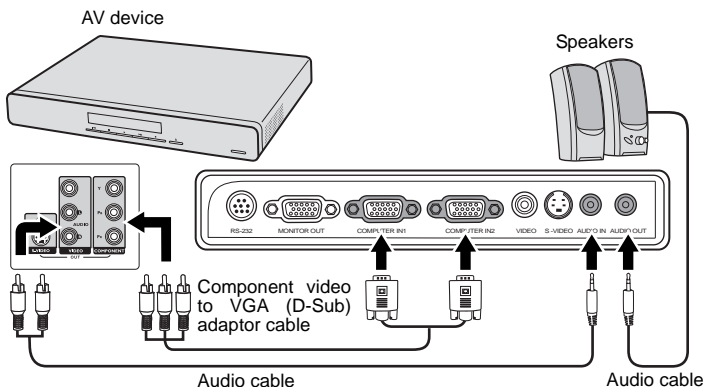

- ☞ The projector is only capable of playing mixed mono audio, even if a stereo audio input is connected. See "[Connecting audio](#)" on page 16 for details.
- If the selected video image is not displayed after the projector is turned on and the correct video source has been selected, check that the video source device is turned on and operating correctly. Also check that the signal cables have been connected correctly.

Connecting an S-Video source device

Examine your video source device to determine if it has an unused S-Video output socket available:

- If so, you can continue with this procedure.
- If not, you will need to reassess which method you can use to connect to the device.

To connect the projector to an S-Video source device:

1. Take an S-Video cable and connect one end to the S-Video output socket of the video source device.
2. Connect the other end of the S-Video cable to the **S-VIDEO** socket on the projector.
3. If you wish to make use of the projector (mixed mono) speaker in your presentations, take a suitable audio cable and connect one end of the cable to the audio output socket of the device, and the other end to the **AUDIO IN** socket of the projector.
4. If you wish, you can use another suitable audio cable and connect one end of the cable to the **AUDIO OUT** jack of the projector, and the other end to your external speakers (not supplied).

Once connected, the audio can be controlled by the projector On-Screen Display (OSD) menus. See ["Adjusting the sound" on page 35](#) for details.

The built-in speaker will be muted when the **AUDIO OUT** jack is connected.

The final connection path should be like that shown in the following diagram:

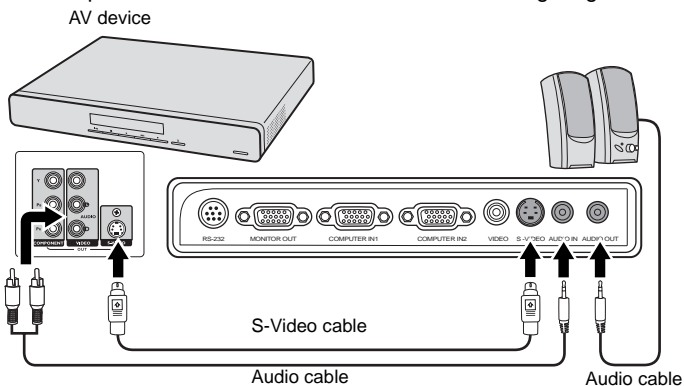

- The projector is only capable of playing mixed mono audio, even if a stereo audio input is connected. See ["Connecting audio" on page 16](#) for details.
- If the selected video image is not displayed after the projector is turned on and the correct video source has been selected, check that the video source device is turned on and operating correctly. Also check that the signal cables have been connected correctly.
- If you have already made a Component video connection between the projector and this S-Video source device using Component video connections, you need not connect to this device using an S-Video connection as this makes an unnecessary second connection of poorer picture quality. See ["Connecting video source devices" on page 16](#) for details.

Connecting a composite video source device

Examine your video source device to determine if it has a set of unused composite video output sockets available:

- If so, you can continue with this procedure.
- If not, you will need to reassess which method you can use to connect to the device.

To connect the projector to a composite video source device:

1. Take a video cable and connect one end to the composite video output socket of the video source device.
2. Connect the other end of the video cable to the **VIDEO** socket on the projector.
3. If you wish to make use of the projector (mixed mono) speaker in your presentations, take a suitable audio cable and connect one end of the cable to the audio output socket of the device, and the other end to the **AUDIO IN** socket of the projector.
4. If you wish, you can use another suitable audio cable and connect one end of the cable to the **AUDIO OUT** jack of the projector, and the other end to your external speakers (not supplied).

Once connected, the audio can be controlled by the projector On-Screen Display (OSD) menus. See ["Adjusting the sound" on page 35](#) for details.

The built-in speaker will be muted when the **AUDIO OUT** jack is connected.

The final connection path should be like that shown in the following diagram:

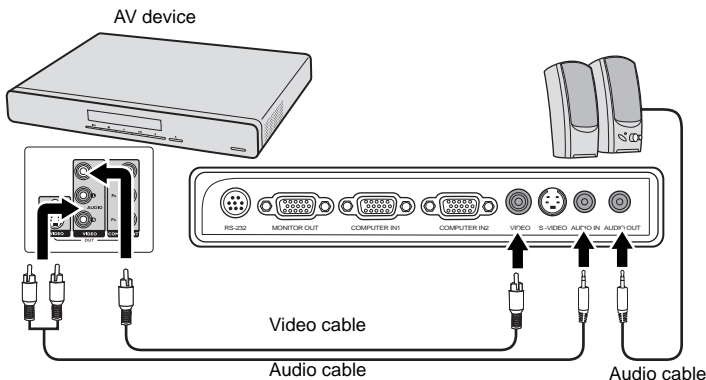

- ☞ **The projector is only capable of playing mixed mono audio, even if a stereo audio input is connected. See ["Connecting audio" on page 16](#) for details.**
- **If the selected video image is not displayed after the projector is turned on and the correct video source has been selected, check that the video source device is turned on and operating correctly. Also check that the signal cables have been connected correctly.**
- **You need only connect to this device using a composite video connection if Component video and S-Video inputs are unavailable for use. See ["Connecting video source devices" on page 16](#) for details.**

Operation

Starting up the projector

1. Plug the power cord into the projector and into a wall socket. Turn on the wall socket switch, if applicable. Check that the **POWER indicator light** on the projector lights orange after power has been applied.

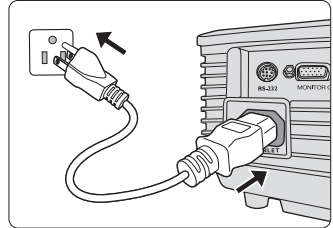

2. Remove the lens cap. If it is closed, it could become deformed due to the heat produced by the projection lamp.

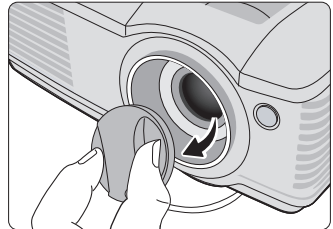

3. Press **POWER** on the projector or remote control to start the projector. The **POWER indicator light** flashes green and stays green when the projector is on. The start up procedure takes about 30 seconds. In the later stage of start up, a startup logo is projected.

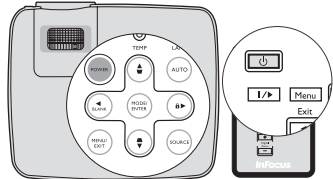

(If necessary) Rotate the focus ring to adjust the image clearness.

- If the projector is still hot from previous activity, it will run the cooling fan for approximately 90 seconds before energizing the lamp.
 - To maintain the lamp life, once you turn the projector on, wait at least 5 minutes before turning it off.
4. If you are prompted for a password, press the arrow keys to enter a six-digit password. See ["Utilizing the password function"](#) on page 22 for details.
 5. Switch all of the connected equipment on.
 6. The projector will start to search for input signals. The current input signal being scanned displays in the upper left corner of the screen. If the projector doesn't detect a valid signal, the message **No Signal** will continue displaying until an input signal is found.
You can also press **SOURCE** on the projector or remote control to select your desired input signal. See ["Switching input signal"](#) on page 24 for details.

- If the frequency/resolution of the input signal exceeds the projector's operating range, you will see the message **'Out of Range'** displayed on a blank screen. Please change to an input signal which is compatible with the projector's resolution or set the input signal to a lower setting. See ["Timing chart"](#) on page 53 for details.

Using the menus

The projector is equipped with On-Screen Display (OSD) menus for making various adjustments and settings.

Below is the overview of the OSD menu.



To use the OSD menus, please set them to your preferred language first.

1. Press **MENU/EXIT** on the projector or remote control to turn the OSD menu on.
3. Press **▼** to highlight **Language** and press **◀/▶** to select a preferred language.



2. Use **◀/▶** to highlight the **SYSTEM SETUP: Basic** menu.
4. Press **MENU/EXIT** twice* on the projector or remote control to leave and save the settings.



*The first press leads you back to the main menu and the second press closes the OSD menu.

Utilizing the password function

For security purposes and to help prevent unauthorized use, the projector includes an option for setting up password security. The password can be set through the On-Screen Display (OSD) menu. For details of the OSD menu operation, please refer to ["Using the menus" on page 21](#).

 You will be inconvenienced if you activate the password functionality and subsequently forget the password. Print this reference guide (if necessary) and write the password you used in this guide, and keep it in a safe place for later use.

Setting a password

 Once a password has been set, the projector cannot be used unless the correct password is entered every time the projector is started.

1. Open the OSD menu and go to the **SYSTEM SETUP: Advanced > Security Settings** menu. Press **MODE/ENTER**. The **Security Settings** page displays.

2. Highlight **Power on lock** and select **On** by pressing **◀/▶**.

3. As pictured to the right, the four arrow keys (**▲**, **▶**, **▼**, **◀**) respectively represent 4 digits (1, 2, 3, 4). According to the password you desire to set, press the arrow keys to enter six digits for the password.

4. Confirm the new password by re-entering the new password.

Once the password is set, the OSD menu returns to the **Security Settings** page.

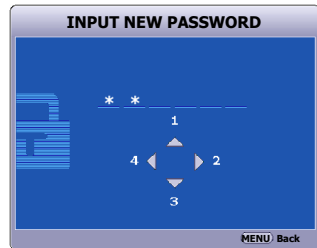

 The digits being input will display as asterisks on-screen. Write your selected password down here in this reference guide in advance or right after the password is entered so that it is available to you should you ever forget it.

Password: _ _ _ _ _ _

Keep this reference guide in a safe place.

5. To leave the OSD menu, press **MENU/EXIT**.

If you forget the password

If the password function is activated, you will be asked to enter the six-digit password every time you turn on the projector. If you enter the wrong password, the password error message as pictured to the right displays lasting for three seconds, and the message **'INPUT PASSWORD'** follows. You can retry by entering another six-digit password, or if you did not record the password in this reference guide, and you absolutely do not remember it, you can use the password recall procedure. See ["Entering the password recall procedure" on page 23](#) for details.

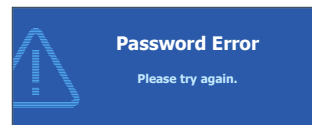

If you enter an incorrect password 5 times in succession, the projector will automatically shut down in a short time.

Entering the password recall procedure

1. Press and hold **AUTO** on the projector or remote control for 3 seconds. The projector will display a coded number on the screen.
2. Write down the number and turn off your projector.
3. Seek help from the local service center to decode the number. You may be required to provide proof of purchase documentation to verify that you are an authorized user of the projector.

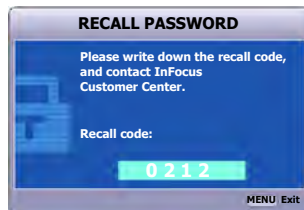

Changing the password

1. Open the OSD menu and go to the **SYSTEM SETUP: Advanced > Security Settings > Change password** menu.
2. Press **MODE/ENTER**. The message '**INPUT CURRENT PASSWORD**' displays.
3. Enter the old password.
 - If the password is correct, another message '**INPUT NEW PASSWORD**' displays.
 - If the password is incorrect, the password error message displays lasting for three seconds, and the message '**INPUT CURRENT PASSWORD**' displays for your retry. You can press **MENU/EXIT** to cancel the change or try another password.
4. Enter a new password.

 The digits being input will display as asterisks on-screen. Write your selected password down here in this reference guide in advance or right after the password is entered so that it is available to you should you ever forget it.

Password: _ _ _ _ _

Keep this reference guide in a safe place.

5. Confirm the new password by re-entering the new password.
6. You have successfully assigned a new password to the projector. Remember to enter the new password next time the projector is started.
7. To leave the OSD menu, press **MENU/EXIT**.

Disabling the password function

To disable password protection, go back to the **SYSTEM SETUP: Advanced > Security Settings > Power on lock** menu after opening the OSD menu system. Select **Off** by pressing **◀/▶**. The message '**INPUT PASSWORD**' displays. Enter the current password.

- If the password is correct, the OSD menu returns to the **Security Settings** page with '**Off**' shown in the row of **Power on lock**. You will not have to enter the password next time you turn on the projector.
- If the password is incorrect, the password error message displays lasting for three seconds, and the message '**INPUT PASSWORD**' displays for

your retry. You can press **MENU/EXIT** to cancel the change or try another password.

 Though the password function is disabled, you need to keep the old password on hand should you ever need to re-activate the password function by entering the old password.

Switching input signal

The projector can be connected to multiple devices at the same time. However, it can only display one full screen at a time.

Be sure the **Quick Auto Search** function in the **SOURCE** menu is **On** (which is the default of this projector) if you want the projector to automatically search for the signals.

You can also manually cycle through the available input signals.

1. Press **SOURCE** on the projector or remote control. A source selection bar displays.
2. Press **▲/▼** until your desired signal is selected and press **MODE/ENTER**.

Once detected, the selected source information will display on the screen for seconds. If there is multiple equipment connected to the projector, repeat steps 1-2 to search for another signal.

 • The brightness level of the projected image will change accordingly when you switch between different input signals. Data (graphic) "PC" presentations using mostly static images are generally brighter than "video" using mostly moving images (movies).

- The input signal type affects the options available for the Preset Mode. See "[Selecting a picture mode](#)" on page 29 for details.
- The native display resolution of this projector is in a 4:3 aspect ratio. For best display picture results, you should select and use an input signal which outputs at this resolution. Any other resolutions will be scaled by the projector depending upon the 'aspect ratio' setting, which may cause some image distortion or loss of picture clarity. See "[Selecting the aspect ratio](#)" on page 27 for details.

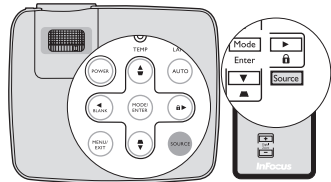

Adjusting the projected image

Adjusting the projection angle

The projector is equipped with 1 quick-release adjuster foot and 1 rear adjuster foot. These adjusters change the image height and projection angle. To adjust the projector:

1. Press the quick-release button and lift the front of the projector. Once the image is positioned where you want it, release the quick-release button to lock the foot in position.
2. Screw the rear adjuster foot to fine tune the horizontal angle.

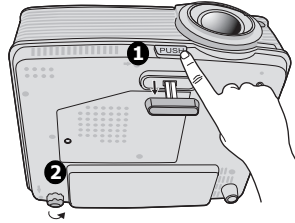

To retract the foot, hold up the projector while pressing the quick-release button, then slowly lower the projector. Screw the rear adjuster foot in a reverse direction.

If the projector is not placed on a flat surface or the screen and the projector are not perpendicular to each other, the projected image becomes trapezoidal. To correct this situation, see "[Correcting keystone](#)" on page 26 for details.



- **Do not look into the lens while the lamp is on. The strong light from the lamp may cause damage to your eyes.**
- **Be careful when you press the adjuster button as it is close to the exhaust vent where hot air comes from.**

Auto-adjusting the image

In some cases, you may need to optimize the picture quality. To do this, press **AUTO** on the projector or remote control. Within 3 seconds, the built-in Intelligent Auto Adjustment function will re-adjust the values of Frequency and Clock to provide the best picture quality.

The current source information will be displayed in the upper left corner of the screen for 3 seconds.

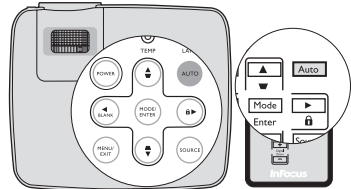

- **The screen will be blank while AUTO is functioning.**
- **This function is only available when PC signal (analog RGB) is selected.**

Fine-tuning the image size and clarity

1. Adjust the projected image to the size that you need using the zoom ring.



2. Then sharpen the image by rotating the focus ring.

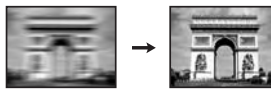

Correcting keystone

Keystoning refers to the situation where the projected image is noticeably wider at either the top or bottom. It occurs when the projector is not perpendicular to the screen.

Besides adjusting the height of the projector, you may need to follow one of these steps:

- Using the remote control

Press **▼**/**▲** on the projector control panel or remote control to display the Keystone correction page. Press **▲** to correct keystone at the top of the image. Press **▼** to correct keystone at the bottom of the image.

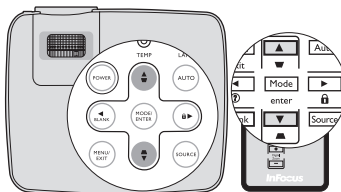

- Using the OSD menu

1. Press **MENU/EXIT** and then press **◀**/**▶** until the **DISPLAY** menu is highlighted.
2. Press **▼** to highlight **Keystone** and press **MODE/ENTER**. The **Keystone** correction page displays.
3. Press **▲** to correct keystone at the top of the image or press **▼** to correct keystone at the bottom of the image.



Magnifying and searching for details

If you need to look at specific details on the projected picture, magnify the picture. Use the direction arrow keys for navigating the picture.

- Using the remote control
 1. Press **Digital Zoom +/-** to display the Zoom bar.
 2. Press **Digital Zoom +** to magnify the center of the picture. Press the key repeatedly until the picture size is suitable for your need.
 3. Use the directional arrows (▲, ▼, ◀, ▶) on the projector or remote control to navigate the picture.
 4. To restore the picture to its original size, press **AUTO**. You can also press **Digital Zoom -**. When the key is pressed again, the picture is further reduced until it is restored to the original size.
- Using the OSD menu
 1. Press **MENU/EXIT** and then press ◀/▶ until the **DISPLAY** menu is highlighted.
 2. Press ▼ to highlight **Digital Zoom** and press **MODE/ENTER**. The Zoom bar displays.
 3. Repeat steps 2-4 in the section of "[Using the remote control](#)" above. Or if you are using the projector control panel, continue to the following steps.
 4. Press ▲ on the projector repeatedly to magnify the picture to a desired size.
 5. To navigate the picture, press **MODE/ENTER** to switch to the panning mode and press the directional arrows (▲, ▼, ◀, ▶) to navigate the picture.
 6. Use the directional arrows (▲, ▼, ◀, ▶) on the projector or remote control to navigate the picture.
 7. To reduce size of the picture, press **MODE/ENTER** to switch back to the zoom in/out functionality, and press **AUTO** to restore the picture to its original size. You can also press ▼ repeatedly until it is restored to the original size.

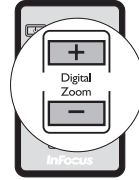

 The picture can only be navigated after the picture is magnified. You can further magnify the picture while searching for details.

Selecting the aspect ratio

The 'aspect ratio' is the ratio of the image width to the image height. Most analog TV and computers are in 4:3 ratio, which is the default for this projector, and digital TV and DVDs are usually in 16:9 ratio.

With the advent of digital signal processing, digital display devices like this projector can dynamically stretch and scale the image output to a different aspect than that of the image input signal.

To change the projected image ratio (no matter what aspect the source is):

1. Press **MENU/EXIT** and then press ◀/▶ until the **DISPLAY** menu is highlighted.
2. Press ▼ to highlight **Aspect Ratio**.

3. Press ◀/▶ to select an aspect ratio to suit the format of the video signal and your display requirements.

About the aspect ratio

 In the pictures below, the black portions are inactive areas and the white portions are active areas. OSD menus can be displayed on those unused black areas.

1. **Auto:** Scales an image proportionally to fit the projector's native resolution in its horizontal width. This is suitable for the incoming image which is neither in 4:3 nor 16:9 and you want to make most use of the screen without altering the image's aspect ratio.

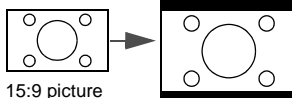
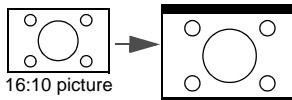

2. **Real:** The image is projected as its original resolution, and resized to fit within the display area. For input signals with lower resolutions, the projected image will display smaller than if resized to full screen. You could adjust the zoom setting or move the projector towards the screen to increase the image size if necessary. You may also need to refocus the projector after making these adjustments.

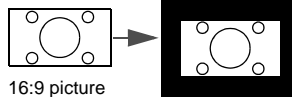
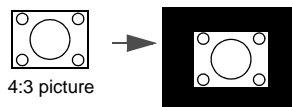

3. **4:3:** Scales an image so that it is displayed in the center of the screen with a 4:3 aspect ratio. This is most suitable for 4:3 images like computer monitors, standard definition TV and 4:3 aspect DVD movies, as it displays them without aspect alteration.

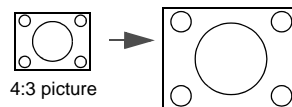

4. **16:9:** Scales an image so that it is displayed in the center of the screen with a 16:9 aspect ratio. This is most suitable for images which are already in a 16:9 aspect, like high definition TV, as it displays them without aspect alteration.

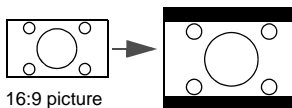

Optimizing the image

Selecting a picture mode

The projector is preset with several predefined picture modes so that you can choose one to suit your operating environment and input signal picture type.

To select an operation mode that suits your need, you can follow one of the following steps.

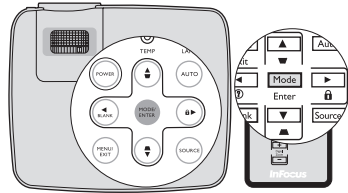

- Press **MODE/ENTER** on the remote control or projector repeatedly until your desired mode is selected.
- Go to the **PICTURE > Preset Mode** menu and press **◀/▶** to select a desired mode.

Setting the User mode

There are two user-definable modes if the current available picture modes are not suitable for your need. You can use one of the picture modes (except the **User**) as a starting point and customize the settings.

1. Press **MENU/EXIT** to open the On-Screen Display (OSD) menu.
2. Go to the **PICTURE > Preset Mode** menu.
3. Press **◀/▶** to select **User**.
4. Press **▼** to select a sub-menu item to be changed and adjust the value with **◀/▶**. See "[Fine-tuning the image quality in user modes](#)" below for details.
5. When all settings have been done, highlight **Save Settings** and press **MODE/ENTER** to store the settings.
6. The confirmation message '**Setting Saved**' displays.

Using Wall Color

In the situation where you are projecting onto a colored surface such as a painted wall which may not be white, the **Wall Color** feature can help correct the projected picture's color to prevent possible color difference between the source and projected pictures.

To use this function, go to the **DISPLAY > Wall Color** menu and press ◀/▶ to select a color which is the closest to the color of the projection surface. There are several precalibrated colors to choose from: **Light Yellow**, **Pink**, **Light Green**, **Blue**, and **Blackboard**.

Fine-tuning the image quality in user modes

According to the detected signal type, there are some user-definable functions available when **User** mode is selected. You can make adjustments to these functions based on your needs.

Adjusting Brightness

Highlight **Brightness** in the **PICTURE** menu and adjust the values by pressing ◀/▶ on the projector or remote control.

The higher the value, the brighter the image. Likewise, the lower the setting, the darker the image. Adjust this control so the black areas of the image appear just as black and that detail in the dark areas is visible.



Adjusting Contrast

Highlight **Contrast** in the **PICTURE** menu and adjust the values by pressing ◀/▶ on the projector or remote control.

The higher the value, the greater the contrast. Use this to set the peak white level after you have previously adjusted the **Brightness** setting to suit your selected input and viewing environment.



Adjusting Color

Highlight **Color** in the **PICTURE** menu and adjust the values by pressing ◀/▶ on the projector or remote control.

Lower setting produces less saturated colors. If the setting is too high, colors on the image will be overpowering, which makes the image unrealistic.

Adjusting Tint

Highlight **Tint** in the **PICTURE** menu and adjust the values by pressing ◀/▶ on the projector or remote control.

The higher the value, the more reddish the picture becomes. The lower the value, the more greenish the picture becomes.

Adjusting Sharpness

Highlight **Sharpness** in the **PICTURE** menu and adjust the values by pressing ◀/▶ on the projector or remote control.

The higher the value, the sharper the picture becomes. The lower the value, the softer the picture becomes.

Adjusting Brilliant Color

Highlight **Brilliant Color** in the **PICTURE** menu and select by pressing ◀/▶ on the projector or remote control.

This feature utilizes a new color-processing algorithm and system level enhancements to enable higher brightness while providing truer, more vibrant colors in picture. It enables a greater than 50% brightness increase in mid-tone images, which are common in video and natural scenes, so the projector reproduces images in realistic and true colors. If you prefer images with that quality, select **On**. If you don't need it, select **Off**.

On is the default and recommended selection for this projector. When **Off** is selected, the **Color Temperature** function is not available.

Selecting a Color Temperature

Highlight **Color Temperature** in the **PICTURE** menu and adjust the values by pressing ◀/▶ on the projector or remote control.

The options available for color temperature* settings vary according to the signal type selected.

1. **T1**: With the highest color temperature, T1 makes the image appear the most bluish white than other settings.
2. **T2**: Makes images appear bluish white.
3. **T3**: Maintains normal colorings for white.
4. **T4**: Makes images appear reddish white.

*About color temperatures:

There are many different shades that are considered to be "white" for various purposes. One of the common methods of representing white color is known as the "color temperature". A white color with a low color temperature appears to be reddish white. A white color with a high color temperature appears to have more blue in it.

3D Color Management

In most installation situations, color management will not be necessary, such as in classroom, meeting room, or lounge room situations where lights remain on, or where building external windows allow daylight into the room.

Only in permanent installations with controlled lighting levels such as boardrooms, lecture theaters, or home theaters, should color management be considered. **3D Color Management** provides fine color control adjustment to allow for more accurate color reproduction, should you require it.

Proper color management can only be achieved under controlled and reproducible viewing conditions. You will need to use a colorimeter (color light meter), and provide a set of suitable source images to measure color reproduction. These tools are not provided with the projector, however, your projector supplier should be able to provide you with suitable guidance, or even an experienced professional installer.

3D Color Management provides six sets (RGBCMY) of colors to be adjusted. When you select each color, you can independently adjust its range and saturation according to your preference.

If you have purchased a test disc which contains various color test patterns and can be used to test the color presentation on monitors, TVs, projectors, etc. You can project any image from the disc on the screen and enter the **3D Color Management** menu to make adjustments.

To adjust the settings:

1. Go to the **PICTURE** menu and highlight **3D Color Management**.
2. Press **MODE/ENTER** and the **3D Color Management** page displays.
3. Highlight **Primary Color** and press **◀/▶** to select a color from among Red, Yellow, Green, Cyan, Blue, or Magenta.
4. Press **▼** to highlight **Hue** and press **◀/▶** to select its range. Increase in the range will include colors consisted of more proportions of its two adjacent colors.

Please refer to the illustration to the right for how the colors relate to each other.

For example, if you select Red and set its range at 0, only pure red in the projected picture will be selected. Increasing its range will include red close to yellow and red close to magenta.

5. Press **▼** to highlight **Saturation** and adjust its values to your preference by pressing **◀/▶**. Every adjustment made will reflect to the image immediately. For example, if you select Red and set its value at 0, only the saturation of pure red will be affected.
6. Press **▼** to highlight **Gain** and adjust its values to your preference by pressing **◀/▶**. The contrast level of the primary color you select will be affected. Every adjustment made will reflect to the image immediately.
7. Repeat steps 3 to 6 for other color adjustments.
8. Make sure you have made all of the desired adjustments.

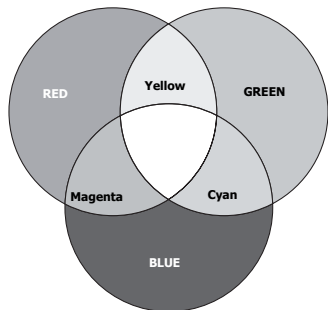

- Press **MENU/EXIT** to exit and save the settings.

 **Saturation** is the amount of that color in a video picture. Lower settings produce less saturated colors; a setting of “0” removes that color from the image entirely. If the saturation is too high, that color will be overpowering and unrealistic.

Setting the presentation timer

The presentation timer can indicate the presentation time on the screen to help you achieve better time management when giving presentations. Follow these steps to utilize this function:

- Go to the **SYSTEM SETUP: Basic > Presentation Timer** menu and press **MODE/ENTER** to display the **Presentation Timer** page.
- Highlight **Timer Period** and decide the time period by pressing **◀/▶**. The length of time can be set from 1 to 5 minutes in 1-minute increments and 5 to 240 minutes in 5-minute increments.

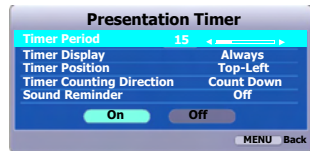

 If the timer is already on, the timer will restart whenever the **Timer Period** is reset.

- Press **▼** to highlight **Timer Display** and choose if you want the timer to show up on the screen by pressing **◀/▶**.

Selection	Description
Always	Displays the timer on screen throughout the presentation time.
1 min/2 min/3 min	Displays the timer on screen in the last 1/2/3 minute(s).
Never	Hides the timer throughout the presentation time.

- Press **▼** to highlight **Timer Position** and set the timer position by pressing **◀/▶**.

Top-Left → Bottom-Left → Top-Right → Bottom-Right

- Press **▼** to highlight **Timer Counting Direction** and select your desired counting direction by pressing **◀/▶**.

Selection	Description
Count Up	Increases from 0 to the preset time.
Count Down	Decreases from the preset time to 0.

- Press **▼** to highlight **Sound Reminder** and decide if you want to activate sound reminder by pressing **◀/▶**. If you select **On**, a double beep sound will be heard at the last 30 seconds of counting down/up, and a triple beep sound will be produced when the timer is up.
- To activate the presentation timer, press **▼** and press **◀/▶** to highlight **On** and press **MODE/ENTER**.
- A confirmation message displays. Highlight **Yes** and press **MODE/ENTER** to confirm. You will see the message “**Timer is On**” displaying on the screen. The timer starts counting at the time the timer is on.

To cancel the timer, perform the following steps.

1. Enter the **SYSTEM SETUP: Basic > Presentation Timer** menu and highlight **Off**. Press **MODE/ENTER**. A confirmation message displays.
2. Highlight **Yes** and press **MODE/ENTER** to confirm. You will see the message "Timer is Off" displaying on the screen.

Hiding the image

In order to draw the audience's full attention to the presenter, you can use **BLANK** on the projector or remote control to hide the screen image. Press any key on the projector or remote control to restore the image. The word '**BLANK**' appears at the lower right corner of the screen while the image is hidden.

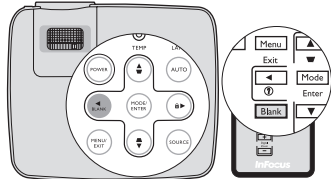

You can set the blank time in the **SYSTEM SETUP: Basic > Blank Timer** menu to let the projector return the image automatically after a period of time when there is no action taken on the blank screen.

☞ Once **BLANK** is pressed, the projector enters Economic mode automatically.

⚠ CAUTION

Do not block the projection lens from projecting as this could cause the blocking object to become heated and deformed or even cause a fire.

Locking control keys

With the control keys on the projector locked, you can prevent your projector settings from being changed accidentally (by children, for example). When the **Panel Key Lock** is on, no control keys on the projector will operate except

Ⓞ **POWER**.

1. Press **▶ / 🔒** on the projector or remote control or go to the **SYSTEM SETUP: Basic > Panel Key Lock** menu, and select **On** by pressing **◀ / ▶** on the projector or remote control.
2. A confirmation message displays. Select **Yes** to confirm.

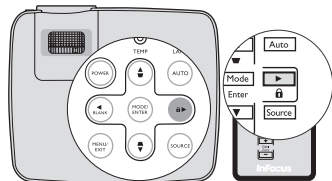

To release panel key lock, press and hold **▶ / 🔒** for 3 seconds on the projector or remote control.

You can also use the remote control to enter the **SYSTEM SETUP: Basic > Panel Key Lock** and press **◀ / ▶** to select **Off**.

- ☞
- Keys on the remote control are still in use when panel key lock is enabled.
 - If you press Ⓞ **POWER** to turn off the projector without disabling panel key lock, the projector will still be in locked status the next time it is turned on.

Freezing the image

Press **||▶** on the remote control to freeze the image. The word **'FREEZE'** will display in the upper left corner of the screen. To release the function, press any key on the projector or remote control.



Even if an image is frozen on the screen, the pictures are running on the video or other device. If the connected devices have active audio output, you will still hear the audio even though the image is frozen on screen.

Operating in a high altitude environment

We recommend you use the **High Altitude Mode** when your environment is between 1500 m–3000 m (4921'– 9843') above sea level, and temperature is between 0°C–35°C (32°F–95°F).

CAUTION

Do not use the High Altitude Mode if your altitude is between 0 m (0') and 1500 m (4921') and temperature is between 0°C (32°F) and 35°C (95°F). The projector will be over cooled, if you turn the mode on under a such condition.

To activate the **High Altitude Mode**:

1. Press **MENU/EXIT** and then press **◀/▶** until the **SYSTEM SETUP: Advanced** menu is highlighted.
2. Press **▼** to highlight **High Altitude Mode** and press **◀/▶** to select **On**. A confirmation message displays.
3. Highlight **Yes** and press **MODE/ENTER**.

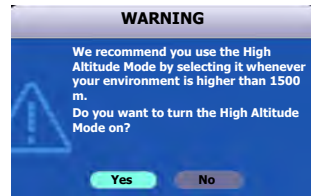

Operation under "**High Altitude Mode**" may cause a higher decibel operating noise level because of increased fan speed necessary to improve overall system cooling and performance.

If you use this projector under other extreme conditions excluding the above, it may display auto shut-down symptoms, which is designed to protect your projector from over-heating. In cases like this, you should switch to **High Altitude Mode** to solve these symptoms. However, this is not to state that this projector can operate under any and all harsh or extreme conditions.

Adjusting the sound

The sound adjustments made as below will have an effect on the projector speaker. Be sure you have made a correct connection to the projector audio input. See "[Connection](#)" on page 13 for how the audio input is connected.

Muting the sound

To temporarily turn off the sound:

1. Press **MENU/EXIT** and then press **◀/▶** until the **SYSTEM SETUP: Advanced** menu is highlighted.
2. Press **▼** to highlight **Audio Settings** and press **MODE/ENTER**. The **Audio Settings** page displays.

3. Highlight **Mute** and press ◀/▶ to select **On**.

Adjusting the sound level

To adjust the sound level:

1. Repeat steps 1-2 above.
2. Press ▼ to highlight **Volume** and press ◀/▶ to select a desired sound level.

Personalizing the projector menu display

The On-Screen Display (OSD) menus can be set according to your preferences. The following settings do not affect the projection settings, operation, or performance.

- **Menu display time** in the **SYSTEM SETUP: Advanced > Menu Settings** menu sets the length of time the OSD will remain active after your last key press. The time length ranges from 5 to 30 seconds in 5-second increments. Use ◀/▶ to select a suitable time frame.
- **Menu position** in the **SYSTEM SETUP: Advanced > Menu Settings** menu sets the OSD position in five locations. Use ◀/▶ to select a preferred position.
- **Language** in the **SYSTEM SETUP: Basic** menu sets your familiar language for the OSD menus. Use ◀/▶ to select your language.
- **Splash Screen** in the **SYSTEM SETUP: Basic** menu sets a preferred logo screen to be displayed during projector start-up. Use ◀/▶ to select a screen.

Shutting down the projector

1. Press ⏻ **POWER** and a confirmation message displays prompting you. If you don't respond in a few seconds, the message will disappear.
2. Press ⏻ **POWER** a second time. The **POWER indicator light** flashes orange, the projection lamp shuts down, and the fans will continue to run for approximately 90 seconds to cool down the projector.
3. The **POWER indicator light** is a steady orange and fans stop.
4. Disconnect the power cord from the wall socket if the projector will not be used for an extended period of time.

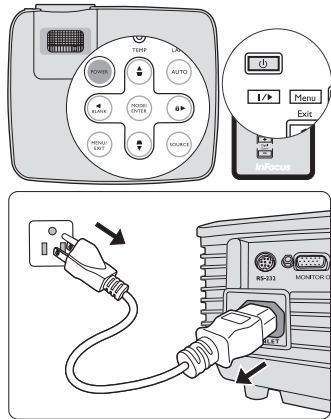

⚠ CAUTION

- To protect the lamp, the projector will not respond to any commands during the cooling process.
- To shorten the cooling time, you can also activate the Quick Cooling function. See "[Quick Cooling](#)" on page 42 for details.
- Do not unplug the power cord before the projector shutdown sequence is complete or during the 90-second cooling down process.
- If the projector is not properly shut down, to protect the lamp, when you attempt to re-start the projector, the fans will run for a few minutes to cool down. Press ⏻ **POWER** again to start the projector after the fans stop and the **POWER** indicator light turns orange.

Menu operation

Menu system





Please note that the on-screen display (OSD) menus vary according to the signal type selected.

The menu items are available when the projector detects at least one valid signal. If there is no equipment connected to the projector or no signal detected, limited menu items are accessible.

Main menu	Sub-menu	Options	
1. DISPLAY	Wall Color	Off/Light Yellow/Pink/Light Green/Blue/Blackboard	
	Aspect Ratio	Auto/Real/4:3/16:9	
	Keystone		
	Position		
	Phase		
	H. Size		
	Digital Zoom		
	3D Sync	On/Off	
3D Sync Invert	Disable/Invert		
2. PICTURE	Preset Mode	Presentation/Video/Bright/Whiteboard/Blackboard/Beige Wall/User	
	Brightness		
	Contrast		
	Color		
	Tint		
	Sharpness		
	Brilliant Color	On/Off	
	Color Temperature	T1/T2/T3/T4	
		Primary Color	R/G/B/Y/C/M
	3D Color Management	Hue	
		Saturation	
	Gain		
Save Settings			
3. SOURCE	Quick Auto Search	On/Off	
4. SYSTEM SETUP: Basic		Timer Period	1~240 minutes
		Timer Display	Always/1 min/2 min/3 min/Never
	Presentation Timer	Timer Position	Bottom-right/Top-right/Bottom-left/Top-left
		Timer Counting Direction	Count Down/Count Up
		Sound Reminder	On/Off
			On/Off

4. SYSTEM SETUP: Basic	Language	ENGLISH/ FRANÇAIS/ DEUTSCH/ ITALIANO/ 한국어/ Norsk/ Português/ РУССКИЙ/ 简体中文/ ESPAÑOL/ 繁體中文/ Svenska/ Nederlands/ Polski / Türkçe/ Dansk/ suomi	
	Projector Position	Front Table/Rear Table/Rear Ceiling/Front Ceiling	
	Auto Power Off	Disable /5 min/10 min/15 min/20 min/25 min/30 min	
	Blank Timer	Disable /5 min/10 min/15 min/20 min/25 min/30 min	
	Panel Key Lock	On/Off	
	Timer Controller	Disable /30 min/1 hr/2 hr/3 hr/4 hr/8 hr/12 hr	
	Splash Screen	Black/Blue/InFocus	
	Quick Cooling	On/Off	
	High Altitude Mode	On/Off	
	5. SYSTEM SETUP: Advanced	Audio Settings	Mute On/Off Volume
Menu Settings		Menu display time	5 sec/10 sec/15 sec/20 sec/25 sec/30 sec
		Menu position	Center/Top-left/Top-right/Bottom- right/Bottom-left
Closed Caption		Closed Caption Enable	On/Off
		Caption Version	CC1/CC2/CC3/CC4
VGA Out		On/Off	
Lamp Settings		Lamp mode	Normal/Economic
		Reset lamp timer Equivalent lamp hour	
Security Settings		Change password	
		Power on lock	On/Off
	Reset All Settings		
6. INFORMATION	Current System Status	<ul style="list-style-type: none"> • Source • Preset Mode • Resolution • Color System • Equivalent Lamp Hour 	

Description of each menu



FUNCTION	DESCRIPTION
Wall Color	Corrects the projected picture's color when the projection surface is not white. See "Using Wall Color" on page 30 for details.
Aspect Ratio	There are four options to set the image's aspect ratio depending on your input signal source. See "Selecting the aspect ratio" on page 27 for details.
Keystone	Corrects any keystone of the image. See "Correcting keystone" on page 26 for details.
Position	Displays the position adjustment page. To move the projected image, use the directional arrow keys. The values shown on the lower position of the page change with every key press you made until they reach their maximum or minimum.
Phase	<p>Adjusts the clock phase to reduce image distortion.</p>  <p> The function is only available when a PC signal (analog RGB) is selected.</p>
H. Size	<p>Adjusts the horizontal width of the image.</p> <p> The function is only available when a PC signal (analog RGB) is selected.</p>
Digital Zoom	Magnifies or reduces the projected image. See "Magnifying and searching for details" on page 27 for details.
3D Sync	<p>This projector features a 3D function which enables you to enjoy 3D movies, videos, and sporting events in a more realistic way by presenting the depth of the images. You need to wear a pair of 3D glasses to view the 3D images.</p> <ul style="list-style-type: none"> For a PC type signal: When the vertical frequency is 120Hz, and the content being projected is made with 3D technology, selecting On will present the 3D images. For a video type signal: When the content being projected is made with 3D technology, selecting On will present the 3D images. <p> When the 3D Sync function is on:</p> <ul style="list-style-type: none"> •The brightness level of the projected image will decrease. •The Preset Mode cannot be adjusted. •The Keystone can only be adjusted within limited degrees. •The Digital Zoom can only magnify the pictures to limited sizes.
3D Sync Invert	When you discover the inversion of the image depth, enable this function to correct the problem.

1. DISPLAY menu

FUNCTION	DESCRIPTION
2. PICTURE menu	Preset Mode Pre-defined picture modes are provided so you can optimize your projector image set-up to suit your program type. See "Selecting a picture mode" on page 29 for details.
	Brightness Adjusts the brightness of the image. See "Adjusting Brightness" on page 30 for details.
	Contrast Adjusts the degree of difference between dark and light in the image. See "Adjusting Contrast" on page 30 for details.
	Color Adjusts the color saturation level -- the amount of each color in a video image. See "Adjusting Color" on page 31 for details.
	Tint Adjusts the red and green color tones of the image. See "Adjusting Tint" on page 31 for details.  The function is only available when Video or S-Video with NTSC system is selected.
	Sharpness Adjusts the image to make it look sharper or softer. See "Adjusting Sharpness" on page 31 for details.
	Brilliant Color Adjusts white peaking while maintaining correct color presentation. See "Adjusting Brilliant Color" on page 31 for details.
	Color Temperature See "Selecting a Color Temperature" on page 31 for details.
	3D Color Management See "3D Color Management" on page 32 for details.
	Save Settings Saves the settings made for User mode.
3. SOURCE menu	Quick Auto Search See "Switching input signal" on page 24 for details.

		FUNCTION	DESCRIPTION
4. SYSTEM SETUP: Basic menu		Presentation Timer	Reminds the presenter to finish the presentation within a certain time frame. See "Setting the presentation timer" on page 33 for details.
		Language	Sets the language for the On-Screen Display (OSD) menus. See "Using the menus" on page 21 for details.
		Projector Position	The projector can be installed on a ceiling or behind a screen. See "Choosing a location" on page 9 for details.
		Auto Power Off	Allows the projector to turn off automatically if no input signal is detected after a set period of time. See "Setting Auto Power Off" on page 45 for details.
		Blank Timer	Sets the image blank time when the Blank feature is activated, once elapsed the image will return to the screen. See "Hiding the image" on page 34 for details.
		Panel Key Lock	Disables or enables all panel key functions except POWER on the projector and keys on the remote control. See "Locking control keys" on page 34 for details.
		Timer Controller	Sets the auto-shutdown timer. The timer can be set to a value between 30 minutes and 12 hours.
		Splash Screen	Allows you to select which logo screen will display during projector start-up. Three options are available: InFocus logo, Black screen, or Blue screen.

FUNCTION	DESCRIPTION
5. SYSTEM SETUP: Advanced menu	<p>Selecting On enables the function and the projector cooling time will be shortened to a few seconds.</p> <p> If you attempt to restart the projector right after the quick cooling process, it may not be turned on successfully and will rerun its cooling fans.</p>
	<p>High Altitude Mode</p> <p>A mode for operation in high altitude areas. See "Operating in a high altitude environment" on page 35 for details.</p>
	<p>Audio Settings</p> <p>Mute Volume See "Adjusting the sound" on page 35 for details.</p>
	<p>Menu Settings</p> <p>Menu display time Sets the length of time the OSD will remain active after your last key press. The range is from 5 to 30 seconds in 5-second increments.</p> <p>Menu position Sets the On-Screen Display (OSD) menu position.</p>
	<p>Closed Caption</p> <p>Closed Caption Enable Activates the function by selecting On when the selected input signal carries closed captions.</p> <ul style="list-style-type: none"> • Captions: An on-screen display of the dialogue, narration, and sound effects of TV programs and videos that are closed captioned (usually marked as "CC" in TV listings). <p>Caption Version Selects a preferred closed captioning mode. To view captions, select CC1, CC2, CC3, or CC4 (CC1 displays captions in the primary language in your area).</p>

FUNCTION	DESCRIPTION
5. SYSTEM SETUP: Advanced menu	<p>VGA Out</p> <p>Selecting On enables the function. The projector can output a VGA signal when it is in standby mode and the D-SUB IN and D-SUB OUT sockets are correctly connected to devices. See "Connecting a monitor" on page 15 for how to make the connection.</p> <p> Enabling this function slightly increases the standby power consumption.</p>
	<p>Lamp Settings</p> <p>Lamp mode See "Setting Lamp mode as Economic" on page 45 for details.</p> <p>Reset lamp timer See "Resetting the lamp timer" on page 49 for details.</p> <p>Equivalent lamp hour See "Getting to know the lamp hour" on page 45 for details on how the total lamp hour is calculated.</p>
	<p>Security Settings</p> <p>Change password You will be asked to enter the current password before changing to a new one.</p> <p>Power on lock See "Utilizing the password function" on page 22 for details.</p>
	<p>Reset All Settings</p> <p>Returns all settings to the factory preset values.</p> <p> The following settings will still remain: Position, Phase, H. Size, User, Language, Projector Position, High Altitude Mode, Security Settings.</p>
6. INFORMATION menu	<p>Current System Status</p> <p>Source Shows the current signal source.</p> <p>Preset Mode Shows the selected mode in the PICTURE menu.</p> <p>Resolution Shows the native resolution of the input signal.</p> <p>Color System Shows input system format, NTSC, PAL, SECAM, or RGB.</p> <p>Equivalent Lamp Hour Displays the number of hours the lamp has been used.</p>

Maintenance

Care of the projector

Your projector needs little maintenance. The only thing you need to do on a regular basis is to keep the lens clean.

Never remove any parts of the projector except the lamp. If your projector needs service, contact InFocus Corporation (www.infocus.com/support) or your dealer for assistance.

Cleaning the lens

Clean the lens whenever you notice dirt or dust on the surface.

- Use a canister of compressed air to remove dust.
- If there is dirt or smears, use lens-cleaning paper or moisten a soft cloth with lens cleaner and gently wipe the lens surface.

 **CAUTION**

Never rub the lens with abrasive materials.

Cleaning the projector case

Before you clean the case, turn the projector off using the proper shutdown procedure as described in "[Shutting down the projector](#)" on page 36 and unplug the power cord.

- To remove dirt or dust, wipe the case with a soft, lint-free cloth.
- To remove stubborn dirt or stains, moisten a soft cloth with water and a neutral pH detergent. Then wipe the case.

 **CAUTION**

Never use wax, alcohol, benzene, thinner or other chemical detergents. These can damage the case.

Storing the projector

If you need to store the projector for an extended time, please follow the instructions below:

- Make sure the temperature and humidity of the storage area are within the recommended range for the projector. Please refer to "[Specifications](#)" on page 52 or consult your dealer about the range.
- Retract the adjuster feet.
- Remove the battery from the remote control.
- Pack the projector in its original packing or equivalent.

Transporting the projector

It is recommended that you ship the projector with its original packing or equivalent.

Lamp information

Getting to know the lamp hour

When the projector is in operation, the duration (in hours) of lamp usage is automatically calculated by the built-in timer. The timer displays lamp hours used in **Normal** mode, plus equivalent **Economic** mode hours. Equivalent **Economic** mode hours are calculated as follows:

1 lamp hour (in **Normal** mode) = 1.33 lamp hours (in **Economic** mode)

 See "**Setting Lamp mode as Economic**" below for more information on **Economic** mode.

To obtain the lamp hour information:

1. Press **MENU/EXIT** and then press **◀/▶** until the **SYSTEM SETUP: Advanced** menu is highlighted.
2. Press **▼** to highlight **Lamp Settings** and press **MODE/ENTER**. The **Lamp Settings** page displays.
3. You will see the **Equivalent lamp hour** information displaying on the menu.
4. To leave the menu, press **MENU/EXIT**.

You can also get the lamp hour information on the **INFORMATION** menu.

Extending lamp life

The projection lamp is a consumable item. To keep the lamp life as long as possible, you can do the following settings via the OSD menu.

Setting Lamp mode as Economic

Using **Economic** mode reduces system noise and power consumption by 20%. If the **Economic** mode is selected, the light output will be reduced and result in darker projected pictures.

Setting the projector in **Economic** mode also extends the lamp operation life. To set **Economic** mode, go into the **SYSTEM SETUP: Advanced > Lamp Settings > Lamp mode** menu and press **◀/▶**.

Setting Auto Power Off

This function allows the projector to turn off automatically if no input source is detected after a set period of time to prevent unnecessary waste of lamp life.

To set **Auto Power Off**, go into the **SYSTEM SETUP: Basic > Auto Power Off** menu and press **◀/▶**. The time period can be set from 5 to 30 minutes in 5-minute increments. If the preset time lengths are not suitable for your presentation, select **Disable**. The projector will not automatically shut down in a certain time period.

Timing of replacing the lamp

When the **Lamp indicator** lights up red or a message appears suggesting it is time to replace the lamp, please install a new lamp or consult your dealer. An old lamp may cause a malfunction in the projector and in some instances the lamp may explode.

 **CAUTION**

The Lamp indicator light and Temperature warning light will light up if the lamp becomes too hot. Turn the power off and let the projector cool for 45 minutes. If the Lamp or Temp indicator still lights up after turning the power back on, please contact your dealer. See "[Indicators](#)" on [page 50](#) for details.

The following lamp warning displays will remind you to change the lamp.

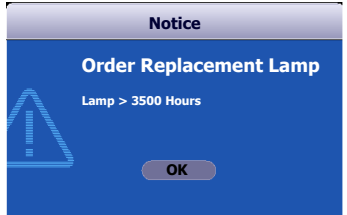
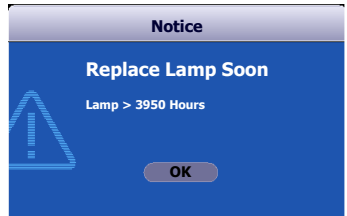
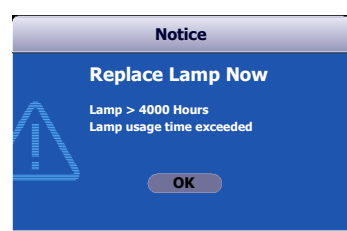
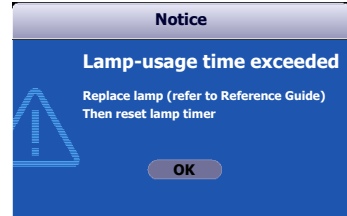
Status	Message
<p>The lamp has been in operation for 3500 hours. Install a new lamp for optimal performance. If the projector is normally run with Economic selected (See "Setting Lamp mode as Economic" on page 45), you may continue to operate the projector until the 3950 hour lamp warning appears.</p>	
<p>The lamp has been in operation for 3950 hours. A new lamp should be fitted to avoid the inconvenience when the projector runs out of lamp time.</p>	
<p>The lamp has been in operation for 4000 hours.</p> <p>It is strongly recommended that you replace the lamp at this age. The lamp is a consumable item. The lamp brightness diminishes with use. This is normal lamp behavior. You can replace the lamp whenever you notice that the brightness level has significantly diminished. If the lamp is not replaced beforehand, it must be replaced after 4000 hours usage.</p>	
<p>The lamp MUST be replaced before the projector will operate normally.</p>	

Replacing the lamp

WARNING

Hg - Lamp contains mercury. Manage in accordance with local disposal laws. See www.lamprecycle.org

- To reduce the risk of electrical shock, always turn the projector off and disconnect the power cord before changing the lamp.
- To reduce the risk of severe burns, allow the projector to cool for at least 45 minutes before replacing the lamp.
- To reduce the risk of injuries to fingers and damage to internal components, use caution when removing lamp glass that has shattered into sharp pieces. Before replacing the lamp, clean the lamp compartment and dispose of cleaning materials. Be careful of sharp edges in the lamp compartment. Wash hands after lamp replacement.
- Only InFocus certified lamps are tested with this projector. Use of other lamps may cause electrical shock and fire.

1. Turn the power off and disconnect the projector from the wall socket. If the lamp is hot, avoid burns by waiting for approximately 45 minutes until the lamp has cooled.
2. Turn the projector over. Then loosen the screws on the lamp cover.
3. Remove the lamp cover from the projector.

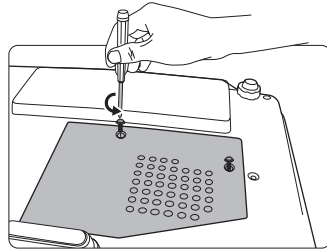

WARNING

- Do not turn the power on with the lamp cover removed.
 - Do not insert your fingers between the lamp and the projector. The sharp edges inside the projector may cause injuries.
4. Loosen the screw that secures the lamp.

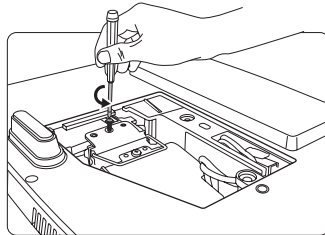
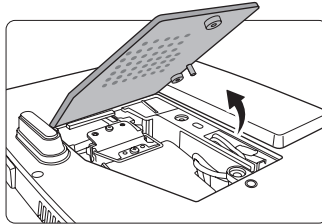

5. Pull out the lamp connector from a slot in the lamp compartment. Disconnect it from the projector as illustrated.

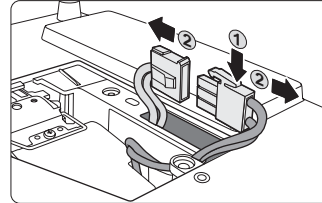
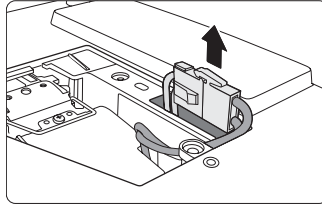

6. Lift the handle so that it stands up. Use the handle to slowly pull the lamp out of the projector.

 **CAUTION**

- Pulling it too quickly may cause the lamp to break and scatter broken glass in the projector.
- Do not place the lamp in locations where water might splash on it, children can reach it, or near flammable materials.
- Do not insert your hands into the projector after the lamp is removed. If you touch the optical components inside, it could cause color unevenness and distortion of the projected images.

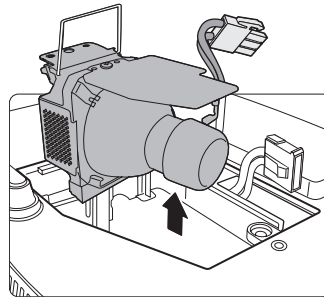

7. Insert the new lamp into the lamp compartment and make sure it fits in the projector.
8. Reconnect the lamp connector and place it back into its slot to be flush with the projector.

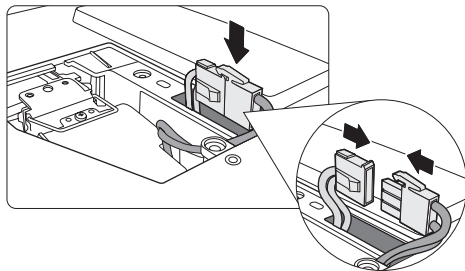

9. Tighten the screw that secures the lamp.

 **CAUTION**

- Loose screw may cause a bad connection, which could result in malfunction.
 - Do not over tighten the screw.
10. Ensure the handle is fully laid flat and locked in place.
 11. Replace the lamp cover on the projector.

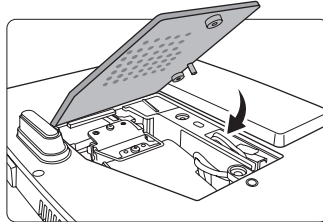
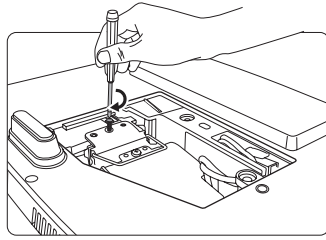

12. Tighten the screws that secure the lamp cover.

 **CAUTION**

- Loose screw may cause a bad connection, which could result in malfunction.
- Do not over tighten the screws.

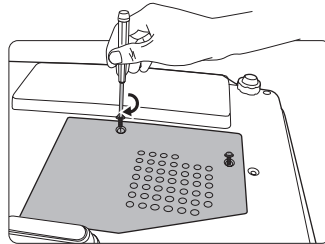

13. Restart the projector.

 **CAUTION**

Do not turn the power on with the lamp cover removed.

Resetting the lamp timer

14. After the startup logo, open the On-Screen Display (OSD) menu. Go to the **SYSTEM SETUP: Advanced > Lamp Settings** menu. Press **MODE/ENTER**. The **Lamp Settings** page displays.



Press **▼** to highlight **Reset lamp timer** and press **MODE/ENTER**. A warning message displays asking if you want to reset the lamp timer. Highlight **Reset** and press **MODE/ENTER**. The lamp time will be reset to '0'.

 **CAUTION**

Do not reset if the lamp is not new or replaced as this could cause damage.

Indicators

Light			Status & Description
Power	Temp	Lamp	
Power events			
Orange	Orange	Orange	The projector has just been connected to a power outlet.
Orange	Off	Off	Stand-by mode
Green Flashing	Off	Off	Powering up
Green	Off	Off	Normal operation
Orange Flashing	Off	Off	1. The projector needs 90 seconds to cool down as it was abnormally shut down without the normal cooling down process. Or 2. The projector needs to cool for 90 seconds after the power is turned off.
Orange Flashing	Off	Off	The projector has shutdown automatically. If you try to re-start the projector, it will shutdown again. Please contact your dealer for assistance.
Lamp events			
Orange Flashing	Off	Red	The projector has shutdown automatically. If you try to re-start the projector, it will shutdown again. Please contact your dealer for assistance.
Off	Off	Red	1. The projector needs 90 seconds to cool down. Or 2. Please contact your dealer for assistance.
Thermal events			
Off	Red	Off	The projector has shutdown automatically. If you try to re-start the projector, it will shutdown again. Please contact your dealer for assistance.
Off	Red	Red	
Off	Red	Green	
Off	Red	Orange	
Red	Red	Red	
Red	Red	Green	
Red	Red	Orange	
Green	Red	Red	
Green	Red	Green	
Green	Red	Orange	
Orange	Red	Red	
Orange	Red	Green	
Orange	Red	Orange	
Off	Green	Red	
Off	Green	Green	

Troubleshooting

① The projector does not turn on.

Cause	Remedy
There is no power from the power cable.	Plug the power cord into the AC inlet on the projector, and plug the power cord into the power outlet. If the power outlet has a switch, make sure that it is switched on.
Attempting to turn the projector on again during the cooling process.	Wait until the cooling down process has completed.

① No picture

Cause	Remedy
The video source is not turned on or connected correctly.	Turn the video source on and check that the signal cable is connected correctly.
The projector is not correctly connected to the input signal device.	Check the connection.
The input signal has not been correctly selected.	Select the correct input signal with the SOURCE key on the projector or remote control.
The lens cover is still closed.	Open the lens cover.

① Blurred image

Cause	Remedy
The projection lens is not correctly focused.	Adjust the focus of the lens using the focus ring.
The projector and the screen are not aligned properly.	Adjust the projection angle and direction as well as the height of the unit if necessary.
The lens cover is still closed.	Open the lens cover.

① Remote control does not work

Cause	Remedy
The battery is out of power.	Replace the battery with new one.
There is an obstacle between the remote control and the projector.	Remove the obstacle.
You are too far away from the projector.	Stand within 8 meters (26 feet) of the projector.

① The password is incorrect

Cause	Remedy
You do not remember the password.	Please see "Entering the password recall procedure" on page 23 for details.

Specifications

Projector specifications

 All specifications are subject to change without notice.

General		
Product name	Digital Projector	
Model name	IN102	IN104
Optical		
Resolution	800 x 600 SVGA	1024 x 768 XGA
Display system	1-CHIP DMD	
Lens F/Number	F = 2.56 to 2.8, f = 21 to 23 mm (0.83" to 0.91")	
Lamp	SHP 220 W lamp	UHP 210 W
Electrical		
Power supply	AC100–240V, 2.9 A, 50/60 Hz (Automatic)	
Power consumption	315 W (Max)	
Mechanical		
Weight	2.4 Kg (5.29 lbs)	
Input terminal		
Computer input		
RGB input	D-Sub 15-pin (female) x 2	
Video signal input		
S-VIDEO	Mini DIN 4-pin port x 1	
VIDEO	RCA jack x 1	
SD/HDTV signal input	Analog – D-Sub <-> Component RCA jack x 3 (through RGB input)	
Audio signal input	PC audio jack x 1	
Output terminal		
RGB output	D-Sub 15-pin (female) x 1	
Speaker	2 watt x 1 (Amp 1 W)	
Audio signal output	PC audio jack x 1	
Control terminal		
RS-232 serial control	8 pin x 1 (male)	
Environmental Requirements		
Operating temperature	0°C–40°C at sea level	
Operating relative humidity	10%–90% (without condensation)	
Operating altitude	<ul style="list-style-type: none">0–1499 m at 0°C–35°C1500–3000 m at 0°C–30°C (with High Altitude Mode on)	

Dimensions

264 mm x 96.1 mm x 225 mm (10.4" x 3.8" x 8.9") (W x H x D)

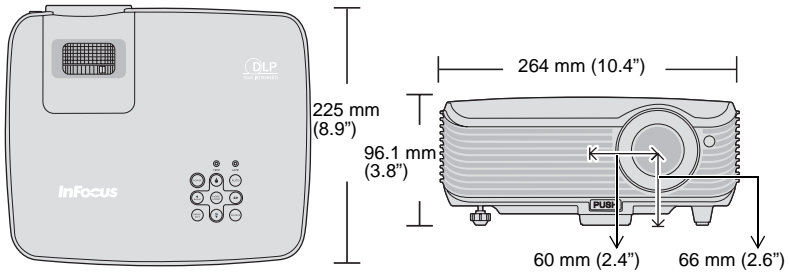

Timing chart

Supported timing for PC input

Resolution	Horizontal Frequency (kHz)	Vertical Frequency (Hz)	Pixel Frequency (MHz)
640 x 350	37.861	85.08	640 x 350_85
640 x 400	37.861	85.08	640 x 400_85
640 x 480	31.469	60.000	VGA_60
	37.861	72.809	VGA_72
	37.500	75.000	VGA_75
	43.269	85.008	VGA_85
720 x 400	31.469	59.940	720 x 400_60
	37.927	85.039	720 x 400_85
720 x 480	31.469	59.940	720 x 480_60
800 x 600	35.156	56.25	SVGA_56
	37.879	60.317	SVGA_60
	48.077	72.188	SVGA_72
	46.875	75.000	SVGA_75
	53.674	85.061	SVGA_85
1024 x 768	48.363	60.004	XGA_60
	56.476	70.069	XGA_70
	60.023	75.029	XGA_75
	68.667	84.997	XGA_85
1152 x 864	63.815	70.012	1152 x 864_70
	67.5	75	1152 x 864_75
	77.094	84.999	1152 x 864_85
1280 x 768	47.776	59.87	1280 x 768_60
	60.289	74.893	1280 x 768_75
	68.633	84.837	1280 x 768_85
1280 x 800	49.702	59.81	WXGA_60
1280 x 1024	63.981	60.020	SXGA_60
	79.976	75.025	SXGA_75
	91.146	85.024	SXGA_85

1280 x 960	60.000	60.000	1280 x 960_60
	75.000	75.000	1280 x 960_75
	85.938	85.002	1280 x 960_85
1360 x 768	47.712	60.015	1360 x 768_60
1440 x 900	55.935	59.887	WXGA+_60
1400 x 1050	65.317	59.978	SXGA+_60
1600 x 1200	75.000	60.000	UXGA_60
1680 x 1050	65.290	59.954	1680 x 1050_60
1920 x 1200	74.038	59.95	1920 x 1200_60
640 x 480@67Hz	35.000	66.667	MAC13
832 x 624@75HZ	49.722	74.546	MAC16
1024 x 768@75Hz	60.241	75.020	MAC19
1152 x 870@75Hz	68.68	75.06	MAC21
1152 x 900@66Hz	61.796	65.95	SUN1166X
1152 x 900@76Hz	71.713	76.047	SUN1176X
1024 x 576@60HZ	35.820	60.000	D1057660
1024 x 600@60Hz	37.500	60.000	DMT10600

Supported timing for Component-YPbPr input

Signal Format	Horizontal Frequency (kHz)	Vertical Frequency (Hz)
480i(525i)@60Hz	15.73	59.94
480p(525p)@60Hz	31.47	59.94
576i(625i)@50Hz	15.63	50.00
576p(625p)@50Hz	31.25	50.00
720p(750p)@60Hz	45.00	60.00
720p(750p)@50Hz	37.50	50.00
1080i(1125i)@60Hz	33.75	60.00
1080i(1125i)@50Hz	28.13	50.00
1080P@60Hz	67.5	60.00
1080P@50Hz	56.26	50.00

 Displaying a 1080i(1125i)@60Hz or 1080i(1125i)@50Hz signal may result in slight image vibration.

Supported timing for video and S-Video inputs

Video mode	Horizontal Frequency (kHz)	Vertical Frequency (Hz)	Color sub-carrier Frequency (MHz)
NTSC-M	15.73	60	3.58
PAL	15.63	50	4.43
SECAM	15.63	50	4.25 or 4.41
PAL-M	15.73	60	3.58
PAL-N	15.63	50	4.43
PAL-60	15.73	60	4.43
NTSC4.43	15.73	60	4.43

Copyright information

Copyright

Copyright 2010 by InFocus Corporation. All rights reserved. No part of this publication may be reproduced, transmitted, transcribed, stored in a retrieval system or translated into any language or computer language, in any form or by any means, electronic, mechanical, magnetic, optical, chemical, manual or otherwise, without the prior written permission of InFocus Corporation.

Disclaimer

InFocus Corporation makes no representations or warranties, either expressed or implied, with respect to the contents hereof and specifically disclaims any warranties, merchantability or fitness for any particular purpose. Further, InFocus Corporation reserves the right to revise this publication and to make changes from time to time in the contents hereof without obligation to notify any person of such revision or changes.

*DLP and Digital Micromirror Device (DMD) are trademarks of Texas Instruments. Others are copyrights of their respective companies or organizations.