

myprojectorlamps.com

**The most trusted, dependable name
in projector lamp sales.**



<http://www.myprojectorlamps.com>



<http://www.myprojectorlamps.ca>



<http://www.myprojectorlamps.eu>

The following projector manual has not been modified or altered in any way.

IBM iLC300 Conference Projector



IBM iLC300 Conference Projector User's Guide

IBM iLC300 Conference Projector



IBM iLC300 Conference Projector User's Guide

First Edition (April 2003)

© Copyright International Business Machines Corporation 2003. All rights reserved.

US Government Users Restricted Rights – Use, duplication or disclosure restricted by GSA ADP Schedule Contract with IBM Corp.

Contents

Safety	v	Picture menu	19
Preface	vii	Advanced settings	20
Registering your option	viii	Settings menu	22
Chapter 1. Introduction	1	Appendix A. Maintenance.	25
Chapter 2. Setting up the projector	3	Cleaning the lens	25
Displaying a computer image.	5	Replacing the projection lamp	25
Using the projector with Windows 98 for the first time	6	Resetting the lamp timer	26
Adjusting the image	6	Using the security lock	26
Chapter 3. Using the projector with a video device.	9	Appendix B. Troubleshooting your setup	27
Displaying a video image.	10	Appendix C. Specifications	29
Chapter 4. Using the projector features 13		Appendix D. Warranty information	31
Using the keypad buttons	13	Warranty period.	31
Using the remote control	14	Service and support	31
Troubleshooting the remote	15	Warranty information on the World Wide Web	31
Using the audio	15	Online technical support	31
Connecting external speakers	16	Telephone technical support	31
Troubleshooting audio.	16	IBM Statement of Limited Warranty Z125-4753-06 8/2000	33
Optimizing computer images	16	Part 1 - General Terms.	33
Presentation features	16	Part 2 - Country-unique Terms	35
Presentation Director	17	Appendix E. European Union warranty information.	43
Optimizing video images.	17	Appendix F. Notices	45
Customizing the projector	17	Trademarks	46
Shutting down the projector.	18	Electronic emission notices	46
Screen save	18	Federal Communications Commission (FCC) statement	46
Power save	18		
Turning off the projector	18		
Chapter 5. Using the menus	19		

Safety

Before installing this product, read the Safety Information.

مصح، يجب قراءة دات السلامة

Antes de instalar este produto, leia as Informações de Segurança.

在安装本产品之前，请仔细阅读 **Safety Information** (安全信息)。

Prije instalacije ovog produkta obavezno pročitajte Sigurnosne Upute.

Před instalací tohoto produktu si přečtěte příručku bezpečnostních instrukcí.

Læs sikkerhedsforskrifterne, før du installerer dette produkt.

Ennen kuin asennat tämän tuotteen, lue turvaohjeet kohdasta Safety Information.

Avant d'installer ce produit, lisez les consignes de sécurité.

Vor der Installation dieses Produkts die Sicherheitshinweise lesen.

Πριν εγκαταστήσετε το προϊόν αυτό, διαβάστε τις πληροφορίες ασφαλείας (safety information).

לפני שתתקינו מוצר זה, קראו את הוראות הבטיחות.

A termék telepítése előtt olvassa el a Biztonsági előírásokat!

Prima di installare questo prodotto, leggere le Informazioni sulla Sicurezza.

製品の設置の前に、安全情報をお読みください。

본 제품을 설치하기 전에 안전 정보를 읽으십시오.

Пред да се инсталира овој продукт, прочитајте информацијата за безбедност.

Lees voordat u dit product installeert eerst de veiligheidsvoorschriften.

Les sikkerhetsinformasjonen (Safety Information) før du installerer dette produktet.

Przed zainstalowaniem tego produktu, należy zapoznać się z książką "Informacje dotyczące bezpieczeństwa" (Safety Information).

Antes de instalar este produto, leia as Informações sobre Segurança.

Перед установкой продукта прочтите инструкции по технике безопасности.

Pred inštaláciou tohto zariadenia si pečítajte Bezpečnostné predpisy.

Pred namestitvijo tega proizvoda preberite Varnostne informacije.

Antes de instalar este producto lea la información de seguridad.

Läs säkerhetsinformationen innan du installerar den här produkten.

安裝本產品之前，請先閱讀「安全資訊」。

Preface

The IBM iLC300 Conference Video Projector can be used for both business presentations and home entertainment and is easy to connect, use, and maintain.

In addition to this user's guide, your option package contains the following:

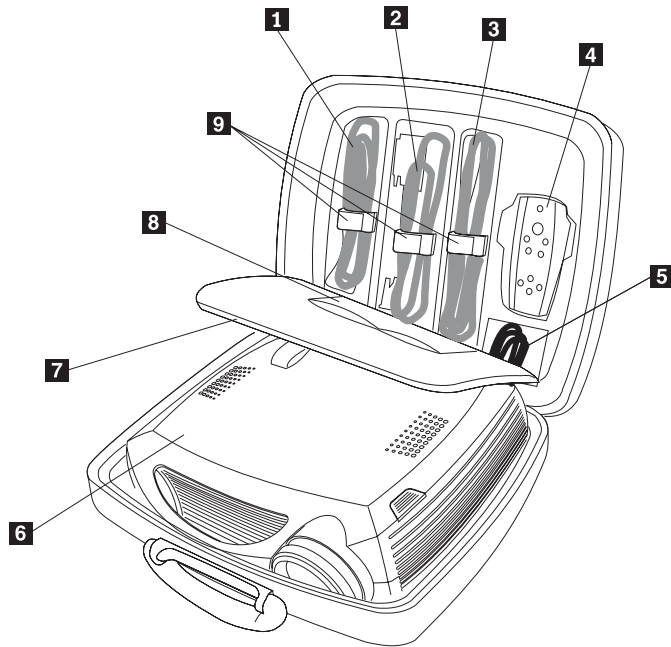

Figure 1. Standard Accessories

- 1** Computer cable
- 2** Power cable
- 3** Composite video cable
- 4** Remote
- 5** Audio cable
- 6** Projector
- 7** Quick setup card and support card
- 8** User's Guide with CD and safety card
- 9** Color-coded cable straps

If any of the items listed above are missing or damaged, contact your place of purchase. Be sure to retain your proof of purchase; it might be required to receive warranty service.

For information on optional accessories for your projector, go to the www.ibm.com/pc/support/ IBM Web site.

Registering your option

Thank you for purchasing this IBM product. Take a few moments to register your product and provide us with information that will help IBM to better serve you in the future. Your feedback is valuable to us in developing products and services that are important to you, as well as in developing better ways to communicate with you. Register your option on the www.ibm.com/pc/register/ IBM Web site.

IBM will send you information and updates on your registered product unless you indicate on the Web site questionnaire that you do not want to receive further information.

Chapter 1. Introduction

The projector comes in a carry case that also stores accessory items, such as the projector remote, color-coded cables, documentation, and CD. The color-coded cables and straps make setup easy and the case is designed to help you keep accessories organized and protected.

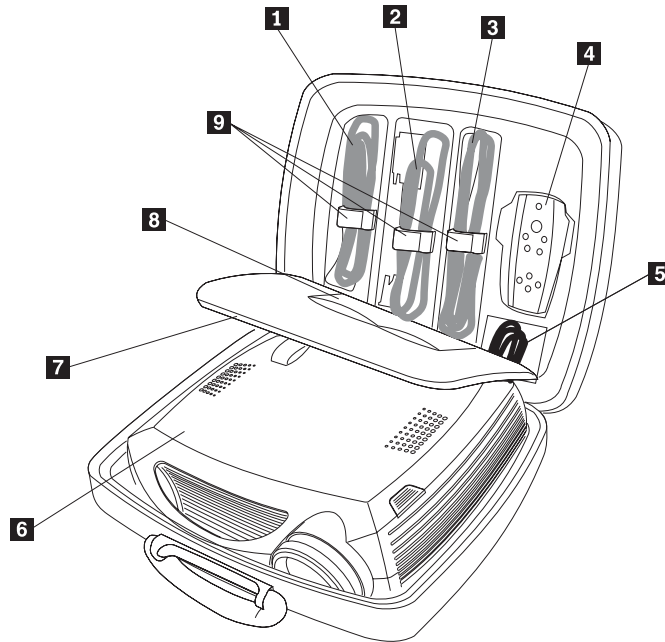

- **1** Computer cable
- **2** Power cable
- **3** Composite video cable
- **4** Remote
- **5** Audio cable
- **6** Projector
- **7** Quick setup card and support card
- **8** User's Guide with CD and safety card
- **9** Color-coded cable straps

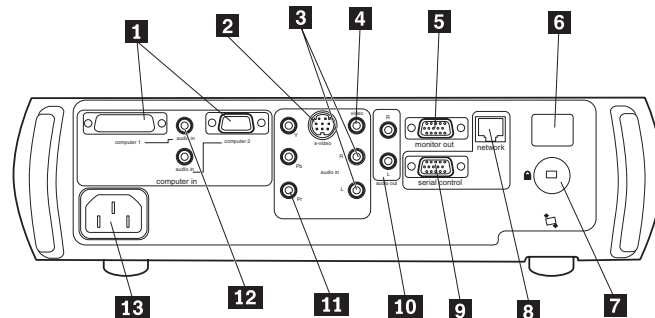

- **1** Computer 1 & 2
- **2** S-video

- **3** Audio
- **4** Composite video
- **5** Computer monitor
- **6** Remote control receiver
- **7** Lock
- **8** Network connector
- **9** Serial connector
- **10** External speakers (audio out)
- **11** Component video
- **12** Computer 1 & 2 audio
- **13** Power connector

Chapter 2. Setting up the projector

This chapter provides information on positioning the projector, connecting a computer source, using the projector with Windows[®] 98, and displaying and adjusting a computer source image.

Note: You can use your projector with Presentation Director to plan and give presentations with confidence. You can ensure that your computer and display will not turn off or go blank during a presentation, be sure your graphics and text will be crisp and clear, and save important display settings for future presentations with the same equipment. For additional information on Presentation Director, visit the www.ibm.com/pc/support Web site and search for "Presentation Director."

Required computer connections

1. Connect the black end of the computer cable to the Computer 1 connector on the projector.
2. Connect the blue end to the video port on your computer. If you are using a desktop computer, you first need to disconnect the monitor cable from the computer's video port.

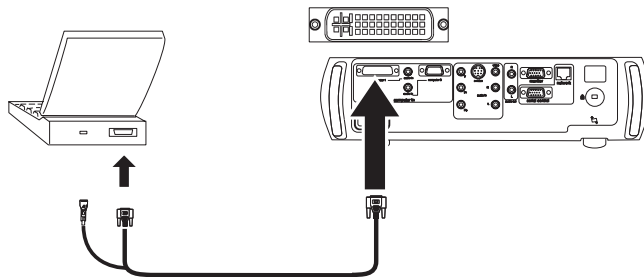

3. Connect the black power cable to the connector on the back of the projector and to your electrical outlet.

The Power LED on the projector's keypad turns solid green.

Note: Always use the power cable that shipped with the projector.

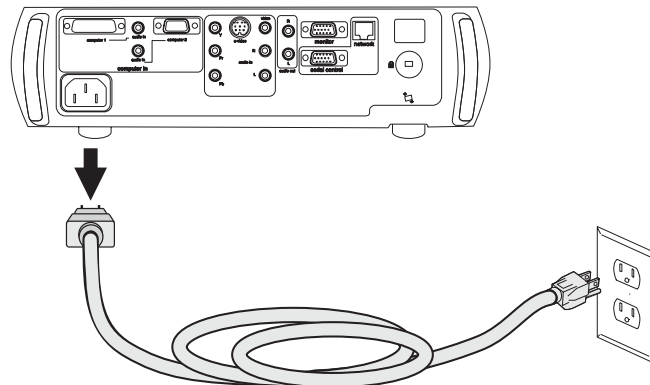

Optional computer connections

To control your computer's mouse using the projector's remote control, connect the USB connector on the computer cable to the computer. USB drivers must be installed to use the USB feature.

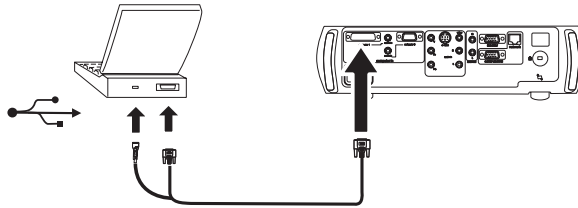

To have sound with your presentation, connect the audio cable to your computer and to the computer Audio In connector on the projector.

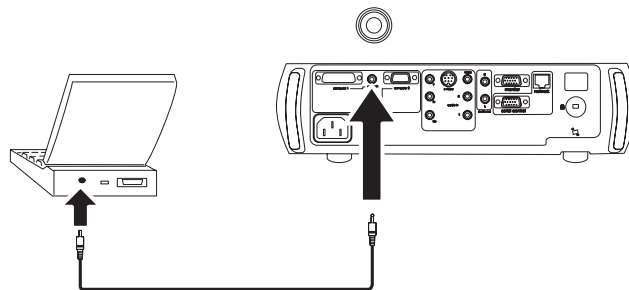

If you are using a desktop computer and want to see the image on your computer screen as well as on the projection screen, plug the monitor cable to the Monitor out connector on the projector.

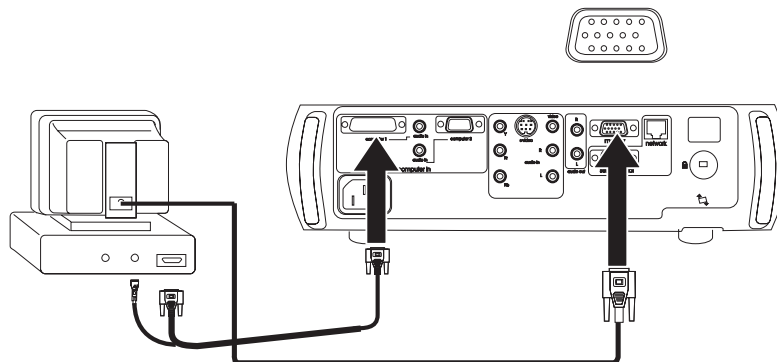

If you prefer connecting your computer to the projector with an optional VESA cable, connect one end of the cable to the VESA port on your computer, and connect the other end of the cable to the blue Computer 2 connector on the projector.

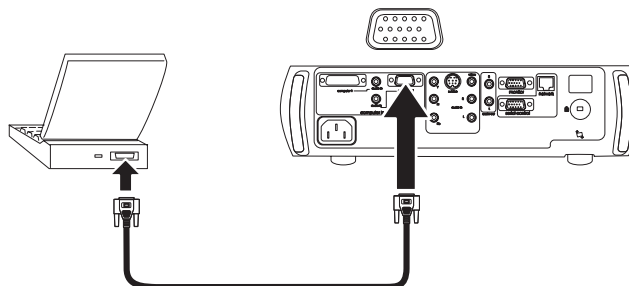

You can control the projector from a computer by connecting an RS-232 cable to the projector's Serial connector. Specific RS-232 commands can be found in the

Service and Support section of our website at www.ibm.com/pc/support.

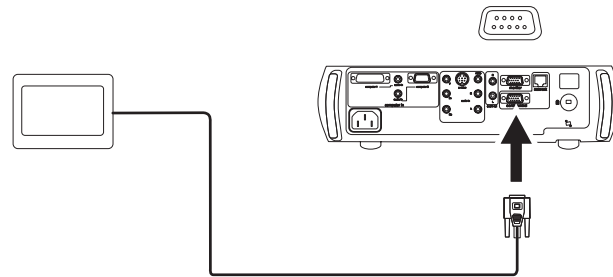

The projector can be managed by ProjectorNet networking software through its Network connector.

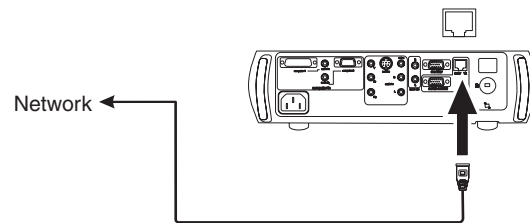

Displaying a computer image

Use the following steps to display a computer image.

1. Remove the lens cap.

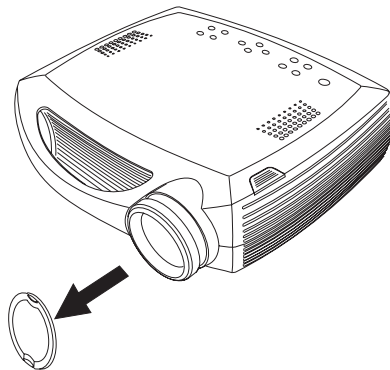

2. Press the **Power** button on the top of the projector or the remote. The LED flashes green and the fans start to run. When the lamp comes on, the startup screen is displayed and the LED is steady green. It can take a minute for the image to achieve full brightness. If you do not see a startup screen, see Appendix B, "Troubleshooting your setup", on page 27.
3. Turn on your computer. The computer's image should appear on the projection screen. If it doesn't, press the **Computer** button on the projector's keypad.
4. Make sure your laptop's external video port is active. Many laptops do not automatically turn on their external video port when a projector is connected. For IBM machines, press FN+F7 to turn the external display on and off. For other manufacturers, consult the documentation that came with your computer. If you do not see a computer image, try pressing the **Auto Image** button on the keypad.

Using the projector with Windows 98 for the first time

The first time you connect a computer running Windows 98 to the projector, the computer recognizes the projector as “new hardware” and the Add New Hardware Wizard appears. Follow these instructions to use the Wizard to load the correct driver (which was installed with your Windows operating system).

If you are running Windows 2000, Windows Me, or Windows XP, skip these steps and go to “Adjusting the image”.

1. Click **Next** to begin searching for the driver.
2. Make sure **Search for the best driver** is selected, then click **Next** again.
3. Uncheck any checked boxes, then click **Next**. Windows automatically locates the driver. If this driver has been removed, reload the driver using your Windows operating system CD.
4. When Windows finds the driver, you are ready to install it. Click **Next**.

If you connected a USB mouse cable, the Add New Hardware Wizard appears. Drivers must be installed to use the USB functionality.

The Wizard launches three times. The first time, it detects a USB Composite Device. The second time, it detects a USB Human Interface Device for the keyboard. The third time, it detects a USB Human Interface Device for the mouse.

Adjusting the image

Follow these steps to adjust the image.

1. Adjust the height of the projector, if necessary, by pressing the release button to extend the elevator foot. Rotate the leveling foot, if necessary.
2. Position the projector the desired distance from the screen at a 90 degree angle to the screen.

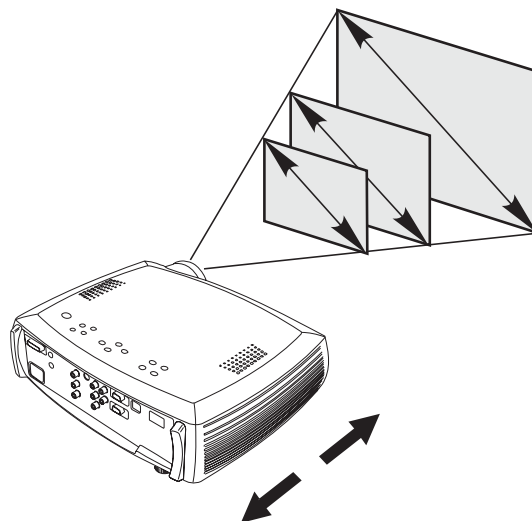

3. Adjust the zoom or focus rings by rotating them until the desired image size and sharpness are produced.

4. If the image is not square, adjust the keystone by using the buttons on the keypad.



Press the upper **Keystone** button to reduce the upper part of the image, and press the lower **Keystone** button to reduce the lower part.

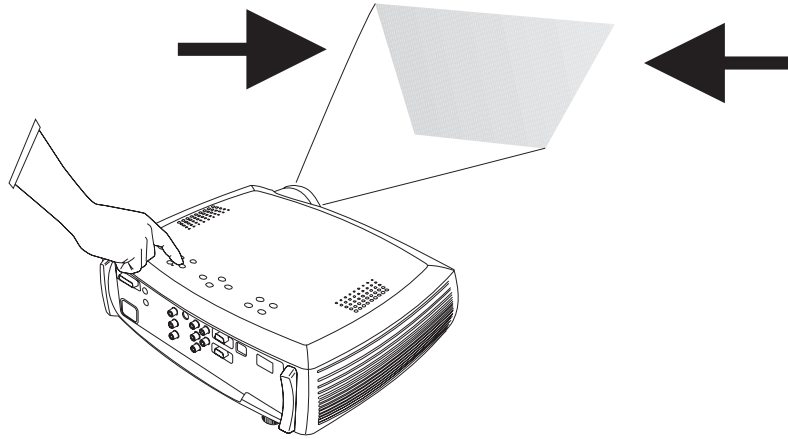

5. Adjust the Contrast or Brightness in the **Picture** menu.



Chapter 3. Using the projector with a video device

This chapter explains how to connect a video device to the projector and display video images.

Standard video connections

1. Plug the video cable's yellow connector into the video-out connector on the video device.
2. Plug the other yellow connector into the yellow Video connector on the projector.
3. Plug a white connector into the left audio out connector on the video device.
4. Plug a red connector into the right audio out connector on the video device.
5. Plug the remaining white connector into the left audio in connector on the projector.
6. Plug the red connector into the right audio in connector on the projector.

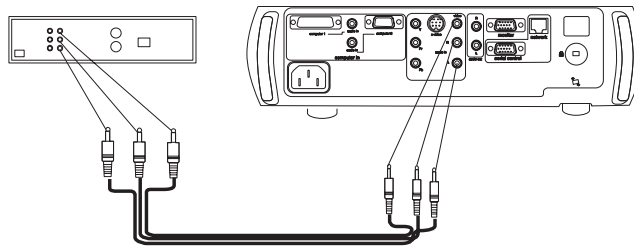

7. Connect the black power cable to the connector on the back of the projector and to your electrical outlet. The Power LED on the keypad turns solid.

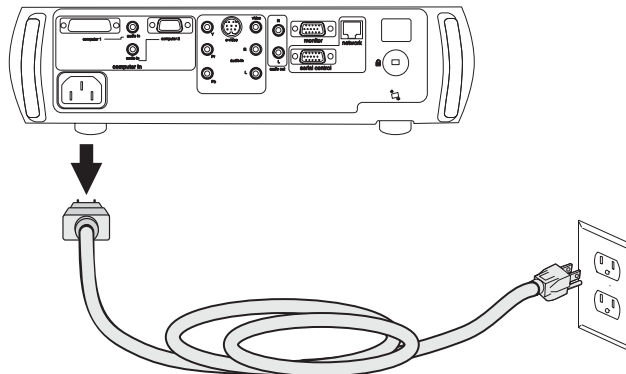

Note: Always use the power cable that shipped with the projector.

Optional video connections

If the video device uses a round, four-prong S-video connector, plug an S-video cable (sold separately) into the S-video connector on the video device and into the S-video connector on the projector. Use the video cable's audio connectors as

described directly above (the yellow connectors on the video cable are not used).

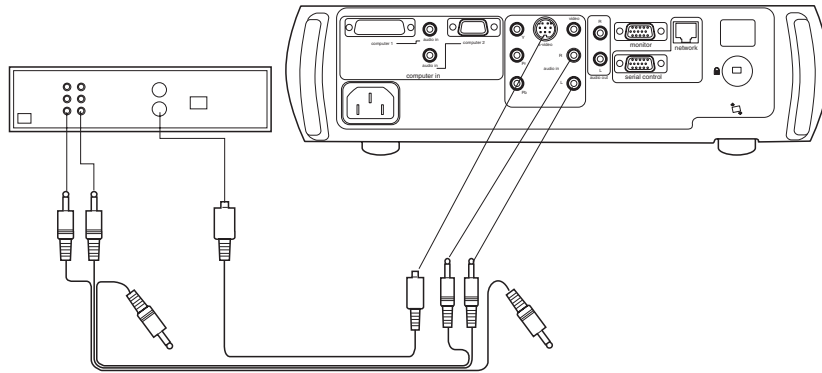

If the video device uses component cable connectors (sold separately), plug the cable's green connectors into the green component-out connector on the video device and into the green component connector (labeled **Y**) on the projector. Plug the component cable's blue connectors into the blue component-out connector on the video device and into the blue component connector (labeled **Pb**) on the projector. Plug the component cable's red connectors into the red component-out connector on the video device and into the red component connector (labeled **Pr**) on the projector. Use the video cable's audio connectors as described directly above (the yellow connectors on the video cable are not used).

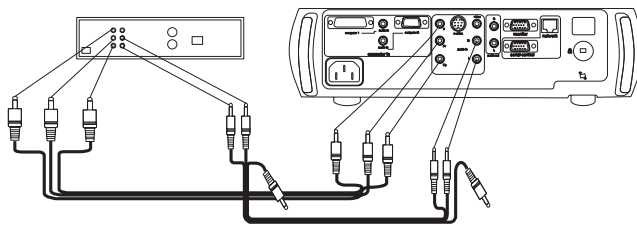

Displaying a video image

To display a video image:

1. Remove the lens cap.
2. Press the Power button on the top of the projector.

The LED flashes green and the fans start to run. When the lamp comes on, the startup screen is displayed and the LED is steady green. It can take a minute for the image to achieve full brightness. If you do not see a startup screen see Appendix B, "Troubleshooting your setup", on page 27.
3. Plug in and turn on the video device.

The video device's image should appear on the projection screen. If it does not, press the **Video** button.
4. Position the projector the desired distance from the screen at a 90 degree angle to the screen.
5. Adjust the zoom or focus rings by rotating them until the desired image size and sharpness are produced.
6. If the image is not square, adjust the keystone using the buttons on the keypad. Press the upper Keystone button to reduce the upper part of the image, and press the lower Keystone button to reduce the lower part.
7. Adjust the volume on the keypad or the remote.

8. Adjust the **Contrast**, **Brightness**, **Color**, or **Tint** in the **Picture** menu. See Chapter 5, "Using the menus", on page 19 for help with menus.

Chapter 4. Using the projector features

This chapter explains how to use projector features such as the remote, audio, menus, and Presentation Director.

Using the keypad buttons

Most buttons are described in detail in other sections. Below is an overview of their functions:

power—turns the projector on and off.

menu—opens the on-screen menus.

select—confirms choices made in the menus.

up/down arrows—navigates to and adjusts settings in the menus.

auto image—resets the projector to the source.

presets—cycles through the available preset settings.

keystone—adjusts squareness of the image.

volume—adjusts sound.

video and computer—changes the active source.

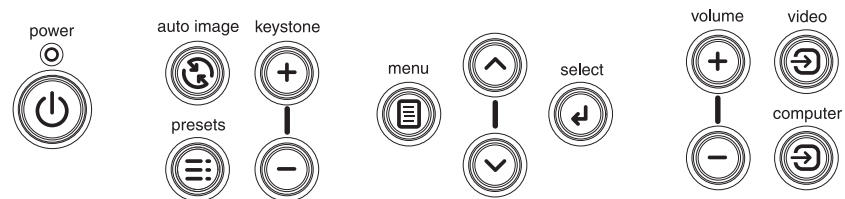

Using the remote control

The remote uses two (2) provided AAA batteries. They are easily installed by sliding the cover off the remote's back, aligning the + and - ends of the batteries, sliding them into place, and then replacing the cover.

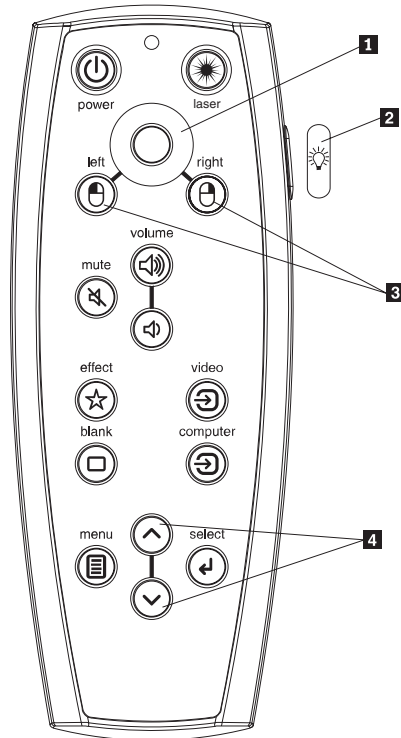

- **1** Cursor control
- **2** Backlight button
- **3** Mouse buttons
- **4** Navigation buttons

Attention: When replacing the batteries, be aware that using batteries other than the type provided with the projector may risk severe damage to the remote. When disposing of the batteries, be sure to do so in an environmentally proper manner.

To operate the remote control, point the remote at the projection screen or at the projector (not at the computer). The range of optimum operation is about 15 feet (4.5m).



CAUTION:

To reduce the risk of injury to the eyes, do not look directly into the remote control laser light and do not point the laser light into anyone's eyes. The remote control is equipped with a Class II laser that emits radiation.

To use the laser pointer, press and hold the **Laser** button. The laser turns off when the button is released, or times out after two (2) minutes of continuous operation.

Left and right remote mouse buttons are used to mimic the actions of the left/right mouse buttons on your computer. Mouse cursor movement is managed via the remote's Cursor control. Connect the USB connector on the computer cable to your computer to use these buttons and control your computer's mouse. When you do this for the first time, the Add New Hardware wizard may appear.

Press the remote's **Menu** button to open the projector's menu system. Use the arrow buttons to navigate, and the Select button to select features and adjust values in the menus. See Chapter 5, "Using the menus", on page 19.

The remote also has a power button to turn the projector on and off (see "Shutting down the projector" on page 18 for shutdown info), volume and mute buttons to control the sound, a backlight button to light the remote's buttons in the dark, and video and computer buttons to switch between sources.

Two presentation-specific features are also provided. Use the blank button to display a blank screen instead of the current slide; use the effect button to invoke a user-definable action, such as freeze or zoom.

If you are displaying presentations in Microsoft® PowerPoint®, you can use the remote's mouse buttons to navigate through your presentation while in Slide Show mode. To configure PowerPoint for this, choose **Options** from the **PowerPoint Tools** menu, click the **View** tab, de-select the "Popup Menu on Right Mouse Click" option in the Slide Show section, then click **OK**. Then, when you're in PowerPoint's Slide Show mode, a left click advances to the next slide and a right click returns to the previous slide (other PowerPoint modes are not affected).

Troubleshooting the remote

- Make sure the batteries are installed in the proper orientation and are not dead.
- Make sure you're pointing the remote at the projector, not the computer, and are within the remote range of 30 feet (9.14m).
- If you are trying to control your computer's mouse, make sure the USB cable is connected. If using a USB cable, make sure the correct drivers are installed.

Using the audio

To play sound from the projector, connect your source to the **Audio In** connector on the projector.

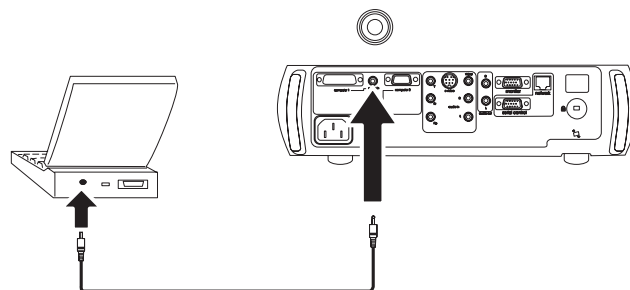

To adjust the volume, use the buttons on the keypad or remote.

To mute the sound, press the **Mute** button.

Connecting external speakers

The projector can be attached to external speakers that have their own power source by plugging speaker cables into the projector's left and right **Audio Out** connectors.

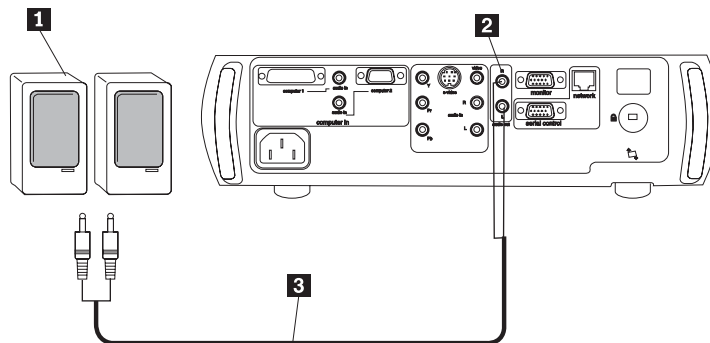

Troubleshooting audio

If there is no sound, check the following:

- Make sure the audio cable is connected.
- Make sure mute isn't active.
- Make sure the volume is turned up enough. Press the volume button on the keypad or remote.
- Make sure that if you are connected to **Computer 1** on the back of the projector, that you are also connected to the corresponding **audio in**. If you are connected to **Computer 2**, be sure you are connected to its corresponding **audio in**.
- Adjust the audio source.
- If playing a video, make sure the playback has not been paused.

Optimizing computer images

After your computer is connected properly and the computer's image is on the screen, you can optimize the image using the onscreen menus. For general information on using the menus, see Chapter 5, "Using the menus", on page 19.

- Adjust the **Keystone**, **Contrast**, or **Brightness** in the **Picture** menu.
- Change the Aspect Ratio. Aspect Ratio is the ratio of the image width to image height. TV screens are usually 1.33:1, also known as 4:3. HDTV and most DVDs are 1.78:1, or 16:9. Choose the option that best fits your input source.
- Adjust the **Color Space** or **Color Temperature** in the **Advanced** menu.
- Adjust the **Phase**, **Tracking**, **Horizontal**, or **Vertical** position in the **Advanced** menu.

Once you have optimized the image for a particular source, you can save the settings using Presets. This allows you to quickly recall these settings later.

Presentation features

Several features are provided to make giving presentation easier. The following is an overview, details are found in Chapter 5, "Using the menus", on page 19.

- The remote's **Effect** button allows you to assign various features to the key. The default effect is **About**, which displays information about the projector and

current source. You can select from **Blank**, **Mute**, **Aspect Ratio**, **Source**, **Auto Image**, **Freeze**, **Zoom**, and **About**. See Chapter 5, "Using the menus", on page 19 for details.

- The **Freeze** effect allows you to freeze the displayed image. This is useful if you want to make changes on your computer without your audience seeing them.
- The **Blank** button on the remote allows you to display a blank screen instead of the active source.
- The **Startup Logo** menu option lets you change the default startup screen to a black, white, or blue screen.
- Two menu options, **Power Save** and **Screen Save**, are provided to automatically shut down the projector after several minutes of inactivity or display a black screen. This helps preserve lamp life.
- A **Low Power** menu option is also available to help lower the projector's fan sound volume.

Presentation Director

Presentation Director helps you create and save presentation schemes that setup your ThinkPad computer to use an external monitor, projector, or television. It also allows you to expand the size of your desktop display by extending the contents of the display across two monitors. For more information on Presentation Director, visit the www.ibm.com/pc/support Web site and search for "Presentation Director."

Optimizing video images

After the video device is connected properly and the image is on the screen, you can optimize the image using the onscreen menus. For general information on using the menus, see Chapter 5, "Using the menus", on page 19.

- Adjust the **Keystone**, **Contrast**, **Brightness**, **Color**, or **Tint** in the **Picture** menu.
- Change the **Aspect ratio**. Aspect ratio is the ratio of the image width to image height. TV screens are usually 1.33:1, also known as 4:3. HDTV and most DVDs are 1.78:1, or 16:9. Choose the option that best fits your input source.
- Select a **Sharpness** setting.
- Adjust the **Color Temperature**. Select a listed value, or select **User** and individually adjust the intensity of the red, green, and blue color.
- Select a different **Video Standard**. **Auto** tries to determine the standard of the incoming video. Select a different standard if necessary.
- Turn overscan on to remove noise around the video image.

Customizing the projector

You can customize the projector for your specific setup and needs.

- For rear projection, turn **Rear** mode on in the **Settings -> System** menu.
- For ceiling mounted projection, turn **Ceiling** mode on in the **Settings -> System** menu.
- Specify which source the projector checks first for active video during power-up.
- Specify the function of the **Effect Key** on the remote.
- Turn the projector's display messages on and off.
- Turn on power saving features.

- Specify blank screen colors and startup logos.
- Specify the menu language.

Shutting down the projector

The projector automatically displays a black screen after no active source is detected for 30 minutes. This black screen helps preserve the life of the projector. The image returns when an active source is detected or a remote or keypad button is pressed.

Screen save

You can make the black screen appear after five minutes by turning on **Screen Save** in the **Settings** -> **System** menu. There are six time options for the Screen Save feature. They range from five minutes to 30 minutes with five minute intervals.

Power save

The projector also has a **Power Save** feature that automatically turns the lamp off after no signals are detected for 20 minutes. After 10 additional minutes with no signal, the projector powers down. If an active signal is received before the projector powers down, the image is displayed. You must press the **Power** button to display an image after 30 minutes have passed. When Power Save is enabled, Screen Save is disabled.

Turning off the projector

To turn off the projector, press the power button and verify that you want to turn the projector off by pressing the power button again within 3 seconds. You can cancel the shutdown by not pressing the power button a second time. The lamp turns off and the LED blinks green for 1 minute while the fans continue to run to cool the lamp. When the lamp has cooled, the LED lights green and the fans stop. Unplug the power cable to completely power off the projector.

Chapter 5. Using the menus

To open the menus, press the menu button on the keypad or remote. (The menus automatically close after 60 seconds if no buttons are pressed.) The Main menu appears. Use the arrow buttons to move up and down to highlight the desired submenu, then press the **Select** button.

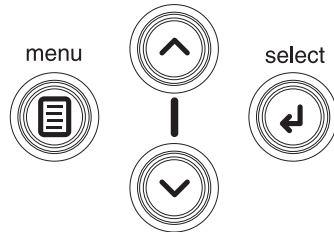

To change a menu setting, highlight it, press **Select**, then use the up and down arrow buttons to adjust the value, select an option using radio buttons, or turn the feature on or off using check boxes. Press **Select** to confirm your changes. Use the arrows to navigate to another setting. When your adjustments are complete, navigate to **Exit**, then press **Select** to go to the previous menu; press the **Menu** button at any time to close the menus.

Dots appear before the menu name. The number of dots indicate the menu's level, ranging from one (the Main menu) to four (the most nested menus).

The menus are grouped by usage:

- The **Picture** menu provides image adjustments.
- The **Settings** menu provides set-up type adjustments that are not changed often.
- The **About** menu provides a read-only display of information about the projector and source.

Certain menu items may be hidden until a particular source is connected. For example, **Sharpness** is only available for video sources and will be hidden when a computer source is active. Other menu items may be grayed out when they are not available. For example, **Brightness** is grayed out until an image is active.

Picture menu

To adjust the following five settings, highlight the setting, press **Select**, use the up and down arrows to adjust the values, then press select to confirm the changes.

Keystone: adjusts the image vertically and makes a squarer image. You can also adjust keystone from the keypad.

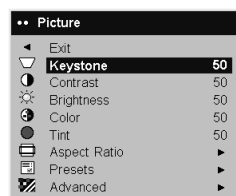

Contrast: controls the degree of difference between the lightest and darkest parts of the picture and changes the amount of black and white in the image.

Brightness: changes the intensity of the image.

Color: (video sources only) adjusts a video image from black and white to fully saturated color.

Tint: (NTSC video sources only) adjusts the red-green color balance in the image.

Aspect Ratio: Aspect ratio is the ratio of the image width to image height. TV screens are usually 1.33:1, also known as 4:3. HDTV and most DVDs are 1.78:1, or 16:9. The default is 4:3, which displays the input resized up or down to fill the display area.

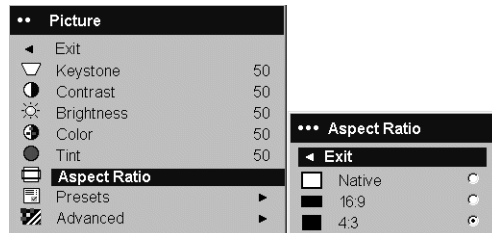

Presets: The provided Presets optimize the projector for displaying computer presentations, photographs, film images, and video images. (Film input is material originally captured on a film camera, like a movie; video input is material originally captured on a video camera, like a TV show or sporting event.) You can use the preset as a starting point, then further customize the settings for each source. The settings you customize are saved in the preset for each source. To restore the factory default settings, choose **Factory Reset** in the **Settings -> Service** menu.

There are also three user-definable presets. To set a preset for the current source, adjust the image, select **Save Settings** in the **Presets** menu, then choose **Save User 1, 2, or 3**. You can recall these settings in the future by selecting the appropriate user presets.

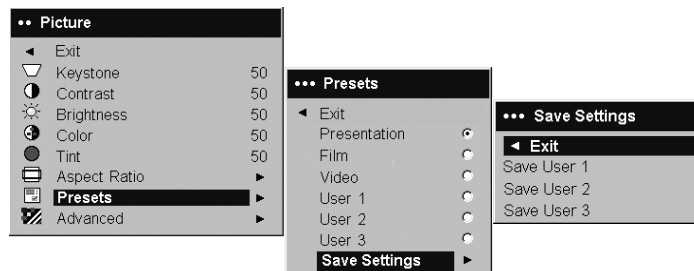

Advanced settings

To adjust the following advanced settings, go to **Main Menu -> Picture -> Advanced**.

Sharpness: (video sources only) Changes the clarity of the edges of a video image. Select a sharpness setting.

Color Space: This option applies to computer and component video sources (it won't appear in the menu for S-video or composite video sources). It allows you to select a color space that has been specifically tuned for the video input. When Auto is selected, the projector automatically determines the standard. To choose a different setting, turn off Auto, then choose **RGB** for computer sources, choose

either REC709 or REC601 for component video sources.

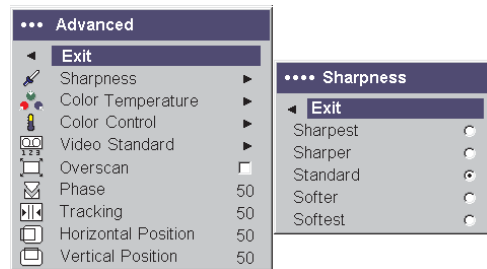

Color Temperature: Changes the intensity of the colors. Select a listed value, or select **User** and individually adjust the intensity of the red, green, and blue colors.

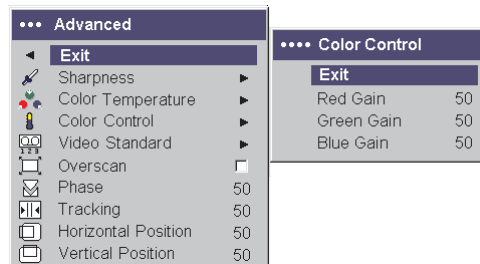
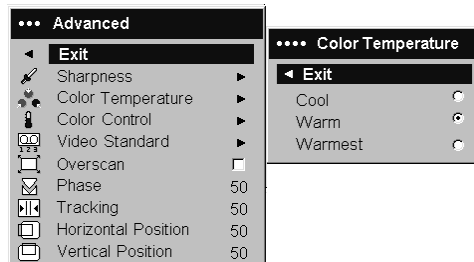

Video Standard: When it is set to Auto, the projector attempts to pick the video standard automatically based on the input signal it receives. (The video standard options may vary depending on your region of the world.) If the projector is unable to detect the correct standard, the colors may not look right or the image may appear “torn.” If this happens, manually select a video standard by selecting **NTSC**, **PAL**, or **SECAM** from the **Video Standard** menu.

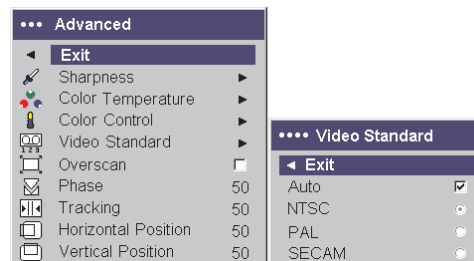

Overscan: (video sources only) Removes noise around the video image.

The following four options are for computer sources only:

Phase: Adjusts the horizontal phase of a computer source.

Tracking: Adjusts the horizontal phase of a computer source.

Horizontal/Vertical Position: Adjusts the position of a computer source.

Settings menu

To adjust the following Settings options, go to **Main Menu -> Settings**.

Audio: Allows adjustments to the sound balance between speakers and speaker volume. The Internal speakers and projector startup Chime can be turned on or off by placing or removing a check in the respective checkboxes.

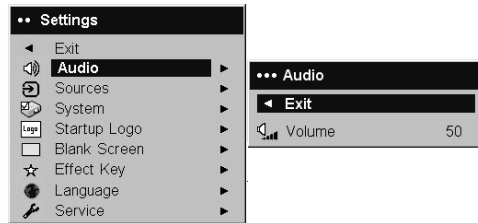

Sources -> Power-up Source: This determines which source the projector checks first for active video during power-up.

Sources: Allows you to assign a particular input to a specific source key as an optional full-featured remote. Also allows selection of a default **Power-up Source** and enables or disables **Autosource**. When Autosource is not checked, the projector defaults to the source selected in Power-up Source. If no source is found, a blank screen displays. When Autosource is checked, Power-up Source determines which source the projector defaults to at power-up. If no signal is present, the projector checks the sources in order until a source is found or until power down.

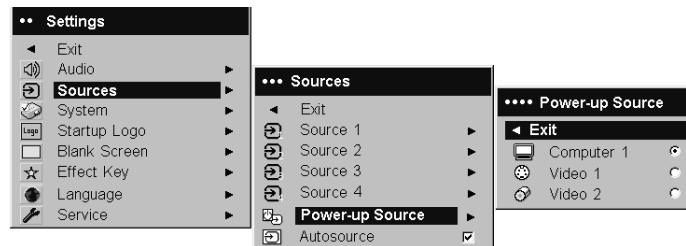

System -> Rear: Reverses the image so you can project from behind a translucent screen.

Ceiling: Turns the image upside down for ceiling-mounted projection.

Note: It is recommended that all final image adjustments in Ceiling mode are made once the unit has fully warmed up.



Auto Power: When Auto Power is checked, the projector automatically goes into the startup state after the projector is powered on. This allows control of ceiling mounted projectors with a wall power switch.

Display Messages: displays status messages (such as “Searching” or “Mute”) in the lower-left corner of the screen.

Low Power: Toggles between on and off. Turn it on to lower the light output of the lamp. This also lowers the fan speed, making the projector quieter.

NND: Prevents your notebook computer from going into Screen Save mode.

Power Save: Automatically turns the lamp off after no signals are detected for 20 minutes. After 10 additional minutes with no signal, the projector powers down. If an active signal is received before the projector powers down, the image will be displayed.

Screen Save: Automatically blanks the screen with a black color after no signals are detected for a preset number of minutes. The image returns when an active source is detected or a remote or keypad button is pressed. Screen Save is disabled when Power Save is enabled.

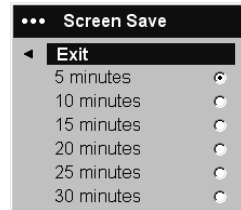

Startup Logo: Allows you to display a blank Black, White, or Blue screen instead of the default screen at startup and when no source is detected.

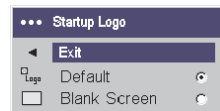

Blank Screen: Determines what color displays when you press the Blank button on the remote or there is a blank screen when no source is active.

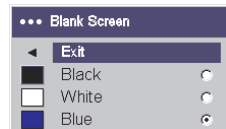

Effect Key: Allows you to assign a different function to the Effect button on the remote to quickly and easily use the effect. Only one effect can be enabled at a time. Highlight an effect and press **Select** to choose a different one.

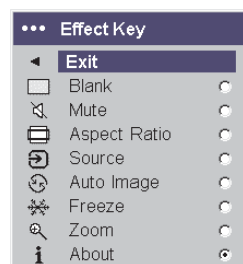

- **Blank:** Shows an empty screen.
- **Mute:** Turns off all sound.
- **Aspect Ratio:** Sets the ratio of the image width to image height.
- **Source:** Cycles through the available sources.
- **Auto Image:** Causes computer sources to be re-acquired.
- **Freeze:** Pauses the projected image.
- **Zoom:** Lets you magnify a part of the screen. To use the Zoom effect, press **Effect**, then press the remote's mouse left-click to zoom the image, press the mouse right-click to decrease the magnification. You can use the cursor control

to pan the image, displaying different parts of it (only if the image is magnified). To return to the original size and cancel Zoom, press the Effect button a second time.

- **About:** The default effect. It displays the **About** menu.

Network: The projector has an RJ45 Ethernet connector that supports network connections and TCP/IP protocols. This will allow for the control and management of the projector over a corporate network. The following fields are accessible when DHCP is not checked and available for manual entry of data.

- **IP Address:** Identifies the projector on the network.
- **Subnet mask:** Separates the network address part of the IP address.
- **Default gateway:** The IP address of the local router.
- **DHCP:** Select this to automatically obtain an IP address, subnet mask, and default gateway.
- **Network Info:** Provides information on the network configuration.

The **Network Info** menu is informational and cannot be edited. It displays the current IP address, subnet mask, default gateway, and the projector's MAC address.

Language: Allows you to select a language for the onscreen display of menus and messages.

Service: To use these features, highlight them and press **Select**.

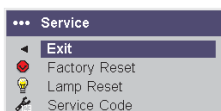

- **Factory Reset:** Restores all settings (except **Lamp Hours** and **Network** settings) to their default after displaying a confirmation dialog box.
- **Lamp Reset:** Resets the lamp hours counter in the **About** menu to zero. Do this only after changing the lamp. It displays a confirmation dialog box.
- **Service Code:** Only used by authorized service personnel.

Appendix A. Maintenance

This chapter describes how to clean the lens, replace the projection lamp, and use the security lock.

Cleaning the lens

To clean the lens:

1. Apply a non-abrasive camera lens cleaner to a soft, dry cloth.

Avoid using an excessive amount of cleaner. Do not apply the cleaner directly to the lens. Abrasive cleaners, solvents, or other harsh chemicals might scratch the lens.

2. Lightly wipe the cleaning cloth over the lens in a circular motion. If you do not intend to use the projector immediately, replace the lens cap.

Replacing the projection lamp

The lamp hour timer in the **About** menu counts the number of hours the lamp has been in use. After 1,980 hours, the message “Change lamp” briefly appears on the screen at each startup. When the timer reaches 2,000 hours, the lamp will no longer light. You can order new lamp modules from your dealer.

To change the projection lamp:

1. Turn off the projector and unplug the power cable.
2. Wait 60 minutes to allow the projector to cool thoroughly.
3. Turn the projector upside down and remove the lamp door by removing the two screws and sliding the lamp door tabs out of the three tab bays.

CAUTION:

Never operate the projector with the lamp door removed. This disrupts the air flow and causes the projector to overheat.

4. Loosen the captive screw on the lamp module.

CAUTION:

- **This product contains a Metal Arc lamp which contains Mercury. Dispose of as required by local ordinances and regulations.**
- **To avoid burns, allow the projector to cool for at least 60 minutes before you replace the lamp.**
- **Do not drop the lamp module. The glass may shatter and cause injury.**
- **Do not touch the glass lamp screen. Fingerprints can obscure projection sharpness.**
- **Be extremely careful when removing the lamp housing. In the unlikely event that the lamp ruptures, small glass fragments may be generated. The lamp module is designed to contain most of these fragments, but use caution when removing it.**

5. Carefully remove the lamp module by grasping and lifting the metal bail wire. Dispose of the lamp in an environmentally proper manner.
6. Install the new lamp module, making sure that it is properly seated.
7. Tighten the single screw.

8. Replace the lamp door by sliding the tabs into the tab bays and tightening the two screws.
9. Plug in the power cable, then press the Power button to turn the projector back on.
10. Reset the lamp hour timer.

Resetting the lamp timer

If the lamp timer has reached the maximum number of hours for the projector lamp (2,000 hours), the LED on the projector's keypad will show a lamp error (see Appendix B, "Troubleshooting your setup", on page 27). To reset the lamp age, simultaneously hold down the two **Volume** keys on the projector's keypad for 10 seconds. At that point the LED will turn green and you can power on the projector.

You can also navigate to the **Settings -> Service** menu and select **Lamp Reset** to reset the lamp timer.

Using the security lock

The projector has a security lock for use with a PC Guardian Cable Lock. Refer to the information that came with the lock for instructions on how to use it.

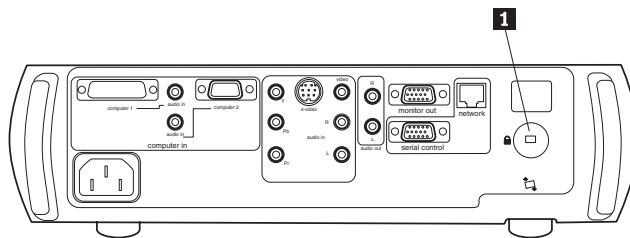

1 Security lock

Appendix B. Troubleshooting your setup

This section provides information on setup troubleshooting.

The LED on top of the projector's keypad indicates the state of the projector and can help you troubleshoot. The following table describes LED behavior and meaning.

LED color/behavior	Meaning
solid green	The projector is plugged in, or the projector has been turned on and the software has initialized. The projector has been turned off and the fans have stopped.
blinking green	The power button has been pressed and the software is initializing, or the projector is powering down and the fans are running to cool the lamp.
blinking red	A fan or lamp failure has occurred. Make sure the vents aren't blocked. Turn off the projector and wait one minute, then turn the projector on again. If the projector has been working for 2000 hours or more, replace the lamp and reset the lamp timer. Contact Technical Support if the problem persists.
solid red	An unidentifiable error: please contact Technical Support.

The following table shows common problems. In some cases, more than one solution is possible. Try the solutions in the order they are presented.

Problem	Solution
No startup screen	<ul style="list-style-type: none">• Plug in power cable and remove lens cap.• Press Power button
Only startup screen appears	<ul style="list-style-type: none">• Press the Computer button.• Activate laptop's external port.• Restart laptop.
No computer image	Set your computer's display resolution to the native resolution of the projector (Start -> Settings -> Control Panel -> Display -> Settings tab, select 1024x768). For a laptop, turn on dual-display mode.
Image fuzzy or cropped	Set your computer's display resolution to the native resolution of the projector (Start -> Settings -> Control Panel -> Display -> Settings tab, select 1024x768). For a laptop, turn on dual-display mode.
Remote control not controlling my computer's mouse	Connect computer cable, then load USB drivers, if needed.
Image not square	Adjust keystone on keypad.

Problem	Solution
Edges of image distorted	Turn overscan on in the Picture -> Advanced menu.
Image not sharp	Adjust sharpness in the Picture -> Advanced menu.
Image does not fit 16:9 screen	Change aspect ratio to 16:9 in the Picture -> Aspect Ratio menu.
Image upside down	Turn off Ceiling in Settings -> System menu.
Image reversed	Turn off Rear in Settings -> System menu.
Video image "torn" or fragmented	Change Video Standard in Picture -> Advance menu.
Projected colors do not match source	Adjust color, tint, color temperature, brightness, and/or contrast in the menus.
Lamp won't turn on; LED blinking red	<ul style="list-style-type: none"> • Make sure vents are not blocked; allow projector to cool for one minute, or • Replace lamp (see "Replacing the projection lamp" on page 25).
Image not centered on screen	<ul style="list-style-type: none"> • Move projector; adjust zoom and/or height, or • Adjust horizontal or vertical position in the Picture -> Advanced menu.

Appendix C. Specifications

Temperature	<ul style="list-style-type: none"> • Operating: 10-35° C (50-95° F) at 0-10,000 feet • Non-operating: -20-+70° C -4-+150° F) at 0-20,000 feet
Altitude	<ul style="list-style-type: none"> • Operating: 3.048 meters (0-10,000 feet) • Non-operating: 6,096 meters (0-20,000 feet)
Humidity	<ul style="list-style-type: none"> • Operating: 10% -95% relative humidity, non-condensing • Non-operating: 10% - 90% relative humidity, non-condensing
Dimensions	351W x 325L x 110H mm (13.8 x 12.8 x 4.3 in.)
Weight	4.24 kg (9.3 lbs.) unpacked
Optics	Focus Range: 5-32.8 feet (1.5-10 meters)
Lamp Type	250-watt UHP lamp
Input Power Requirements	<ul style="list-style-type: none"> • 100V-120V 4A, 50/60 Hz • 200V-240V 2A 50 Hz
Ceiling Mount	UL tested/listed ceiling mount with minimum capacity of 20.87 kg (46 lbs.)

Appendix D. Warranty information

This section contains the warranty period for your product, information about obtaining warranty service and support, and the IBM Statement of Limited Warranty.

Warranty period

Contact your place of purchase for warranty service information.

Machine - IBM iLC300 Conference Video Projector

Warranty period	Service delivery method
Projector - parts: 3 years, labor: 3 years	CCE (customer carry in or mail in)
Projector lamp - parts: 3 months	CCE (customer carry in or mail in)

Service and support

The following information describes the technical support that is available for your product, during the warranty period or throughout the life of the product. Refer to your IBM Statement of Limited Warranty for a full explanation of IBM warranty terms.

For information on European Union legal rights under applicable national legislation governing the sale of consumer goods, see Appendix E, "European Union warranty information", on page 43.

Warranty information on the World Wide Web

The IBM Machine Warranties Web site at www.ibm.com/servers/support/machine_warranties/ contains a worldwide overview of the IBM Limited Warranty for IBM Machines, a glossary of terms used in the Statement of Limited Warranty, Frequently Asked Questions (FAQ), and links to Product Support Web pages. The IBM Statement of Limited Warranty is available from this Web site in 29 languages in Portable Document Format (PDF).

Online technical support

Online technical support is available during the life of your product through the Personal Computing Support Web site at <http://www.ibm.com/pc/support/>.

During the warranty period, assistance for replacement or exchange of defective components is available. In addition, if your IBM option is installed in an IBM computer, you might be entitled to service at your location. Your technical support representative can help you determine the best alternative.

Telephone technical support

Installation and configuration support through the IBM HelpCenter® will be withdrawn or made available for a fee, at IBM's discretion, 90 days after the option has been withdrawn from marketing. Additional support offerings, including step-by-step installation assistance, are available for a nominal fee.

To assist the technical support representative, have available as much of the following information as possible:

- Option name
- Option number
- Proof of purchase
- Computer manufacturer, model, serial number (if IBM), and manual
- Exact wording of the error message (if any)
- Description of the problem
- Hardware and software configuration information for your system

If possible, be at your computer. Your technical support representative might want to walk you through the problem during the call.

For the support telephone number and support hours by country, refer to the following table. If the number for your country or region is not listed, contact your IBM reseller or IBM marketing representative. Response time may vary depending on the number and nature of the calls received.

Support 24 hours a day, 7 days a week	
Canada (Toronto only)	416-383-3344
Canada (all other)	1-800-565-3344
U.S.A. and Puerto Rico	1-800-772-2227
All other countries and regions	Go to http://www.ibm.com/pc/support/ , and click Support Phone List .

IBM Statement of Limited Warranty Z125-4753-06 8/2000

Part 1 - General Terms

This Statement of Limited Warranty includes Part 1 - General Terms and Part 2 - Country-unique Terms. The terms of Part 2 replace or modify those of Part 1. The warranties provided by IBM in this Statement of Limited Warranty apply only to Machines you purchase for your use, and not for resale, from IBM or your reseller. The term "Machine" means an IBM machine, its features, conversions, upgrades, elements, or accessories, or any combination of them. The term "Machine" does not include any software programs, whether pre-loaded with the Machine, installed subsequently or otherwise. Unless IBM specifies otherwise, the following warranties apply only in the country where you acquire the Machine. Nothing in this Statement of Limited Warranty affects any statutory rights of consumers that cannot be waived or limited by contract. If you have any questions, contact IBM or your reseller.

The IBM Warranty for Machines: IBM warrants that each Machine 1) is free from defects in materials and workmanship and 2) conforms to IBM's Official Published Specifications ("Specifications"). The warranty period for a Machine is a specified, fixed period commencing on its Date of Installation. The date on your sales receipt is the Date of Installation unless IBM or your reseller informs you otherwise.

If a Machine does not function as warranted during the warranty period, and IBM or your reseller are unable to either 1) make it do so or 2) replace it with one that is at least functionally equivalent, you may return it to your place of purchase and your money will be refunded.

Extent of Warranty: The warranty does not cover the repair or exchange of a Machine resulting from misuse, accident, modification, unsuitable physical or operating environment, improper maintenance by you, or failure caused by a product for which IBM is not responsible. The warranty is voided by removal or alteration of Machine or parts identification labels.

THESE WARRANTIES ARE YOUR EXCLUSIVE WARRANTIES AND REPLACE ALL OTHER WARRANTIES OR CONDITIONS, EXPRESS OR IMPLIED, INCLUDING, BUT NOT LIMITED TO, THE IMPLIED WARRANTIES OR CONDITIONS OF MERCHANTABILITY AND FITNESS FOR A PARTICULAR PURPOSE. THESE WARRANTIES GIVE YOU SPECIFIC LEGAL RIGHTS AND YOU MAY ALSO HAVE OTHER RIGHTS WHICH VARY FROM JURISDICTION TO JURISDICTION. SOME JURISDICTIONS DO NOT ALLOW THE EXCLUSION OR LIMITATION OF EXPRESS OR IMPLIED WARRANTIES, SO THE ABOVE EXCLUSION OR LIMITATION MAY NOT APPLY TO YOU. IN THAT EVENT, SUCH WARRANTIES ARE LIMITED IN DURATION TO THE WARRANTY PERIOD. NO WARRANTIES APPLY AFTER THAT PERIOD.

Items Not Covered by Warranty: IBM does not warrant uninterrupted or error-free operation of a Machine. Any technical or other support provided for a Machine under warranty, such as assistance via telephone with "how-to" questions and those regarding Machine set-up and installation, will be provided **WITHOUT WARRANTIES OF ANY KIND.**

Warranty Service: To obtain warranty service for a Machine, contact IBM or your reseller. If you do not register your Machine with IBM, you may be required to present proof of purchase.

During the warranty period, IBM or your reseller, if approved by IBM to provide warranty service, provides without charge certain types of repair and exchange service to keep Machines in, or restore them to, conformance with their Specifications. IBM or your reseller will inform you of the available types of service for a Machine based on its country of installation. At its discretion, IBM or your reseller will 1) either repair or exchange the failing Machine and 2) provide the service either at your location or a service center. IBM or your reseller will also manage and install selected engineering changes that apply to the Machine.

Some parts of IBM Machines are designated as Customer Replaceable Units (called "CRUs"), e.g., keyboards, memory, or hard disk drives. IBM ships CRUs to you for replacement by you. You must return all defective CRUs to IBM within 30 days of your receipt of the replacement CRU. You are responsible for downloading designated Machine Code and Licensed Internal Code updates from an IBM Internet Web site or from other electronic media, and following the instructions that IBM provides.

When warranty service involves the exchange of a Machine or part, the item IBM or your reseller replaces becomes its property and the replacement becomes yours. You represent that all removed items are genuine and unaltered. The replacement may not be new, but will be in good working order and at least functionally equivalent to the item replaced. The replacement assumes the warranty service status of the replaced item. Many features, conversions, or upgrades involve the removal of parts and their return to IBM. A part that replaces a removed part will assume the warranty service status of the removed part.

Before IBM or your reseller exchanges a Machine or part, you agree to remove all features, parts, options, alterations, and attachments not under warranty service.

You also agree to

1. ensure that the Machine is free of any legal obligations or restrictions that prevent its exchange;
2. obtain authorization from the owner to have IBM or your reseller service a Machine that you do not own; and
3. where applicable, before service is provided:
 - a. follow the problem determination, problem analysis, and service request procedures that IBM or your reseller provides;
 - b. secure all programs, data, and funds contained in a Machine;
 - c. provide IBM or your reseller with sufficient, free, and safe access to your facilities to permit them to fulfill their obligations; and
 - d. inform IBM or your reseller of changes in a Machine's location.

IBM is responsible for loss of, or damage to, your Machine while it is 1) in IBM's possession or 2) in transit in those cases where IBM is responsible for the transportation charges.

Neither IBM nor your reseller is responsible for any of your confidential, proprietary or personal information contained in a Machine which you return to IBM or your reseller for any reason. You should remove all such information from the Machine prior to its return.

Limitation of Liability: Circumstances may arise where, because of a default on IBM's part or other liability, you are entitled to recover damages from IBM. In each such instance, regardless of the basis on which you are entitled to claim damages from IBM (including fundamental breach, negligence, misrepresentation, or other

contract or tort claim), except for any liability that cannot be waived or limited by applicable laws, IBM is liable for no more than

1. damages for bodily injury (including death) and damage to real property and tangible personal property; and
2. the amount of any other actual direct damages, up to the charges (if recurring, 12 months' charges apply) for the Machine that is subject of the claim. For purposes of this item, the term "Machine" includes Machine Code and Licensed Internal Code.

This limit also applies to IBM's suppliers and your reseller. It is the maximum for which IBM, its suppliers, and your reseller are collectively responsible.

UNDER NO CIRCUMSTANCES IS IBM LIABLE FOR ANY OF THE FOLLOWING: 1) THIRD-PARTY CLAIMS AGAINST YOU FOR DAMAGES (OTHER THAN THOSE UNDER THE FIRST ITEM LISTED ABOVE); 2) LOSS OF, OR DAMAGE TO, YOUR RECORDS OR DATA; OR 3) SPECIAL, INCIDENTAL, OR INDIRECT DAMAGES OR FOR ANY ECONOMIC CONSEQUENTIAL DAMAGES, LOST PROFITS OR LOST SAVINGS, EVEN IF IBM, ITS SUPPLIERS OR YOUR RESELLER IS INFORMED OF THEIR POSSIBILITY. SOME JURISDICTIONS DO NOT ALLOW THE EXCLUSION OR LIMITATION OF INCIDENTAL OR CONSEQUENTIAL DAMAGES, SO THE ABOVE LIMITATION OR EXCLUSION MAY NOT APPLY TO YOU.

Governing Law

Governing Law: Both you and IBM consent to the application of the laws of the country in which you acquired the Machine to govern, interpret, and enforce all of your and IBM's rights, duties, and obligations arising from, or relating in any manner to, the subject matter of this Agreement, without regard to conflict of law principles.

Part 2 - Country-unique Terms

AMERICAS

BRAZIL

Governing Law: *The following is added after the first sentence:*

Any litigation arising from this Agreement will be settled exclusively by the court of Rio de Janeiro.

NORTH AMERICA

Warranty Service: *The following is added to this Section:*

To obtain warranty service from IBM in Canada or the United States, call 1-800-IBM-SERV (426-7378).

CANADA

Governing Law: *The following replaces "laws of the country in which you acquired the Machine" in the first sentence:*

laws in the Province of Ontario.

UNITED STATES

Governing Law: *The following replaces “laws of the country in which you acquired the Machine” in the first sentence:*
laws of the State of New York.

ASIA PACIFIC

AUSTRALIA

The IBM Warranty for Machines: *The following paragraph is added to this Section:*
The warranties specified in this Section are in addition to any rights you may have under the Trade Practices Act 1974 or other similar legislation and are only limited to the extent permitted by the applicable legislation.

Limitation of Liability: *The following is added to this Section:*
Where IBM is in breach of a condition or warranty implied by the Trade Practices Act 1974 or other similar legislation, IBM’s liability is limited to the repair or replacement of the goods or the supply of equivalent goods. Where that condition or warranty relates to right to sell, quiet possession or clear title, or the goods are of a kind ordinarily acquired for personal, domestic or household use or consumption, then none of the limitations in this paragraph apply.

Governing Law: *The following replaces “laws of the country in which you acquired the Machine” in the first sentence:*
laws of the State or Territory.

CAMBODIA, LAOS, AND VIETNAM

Governing Law: *The following replaces “laws of the country in which you acquired the Machine” in the first sentence:*
laws of the State of New York.

The following is added to this Section:
Disputes and differences arising out of or in connection with this Agreement shall be finally settled by arbitration which shall be held in Singapore in accordance with the rules of the International Chamber of Commerce (ICC). The arbitrator or arbitrators designated in conformity with those rules shall have the power to rule on their own competence and on the validity of the Agreement to submit to arbitration. The arbitration award shall be final and binding for the parties without appeal and the arbitral award shall be in writing and set forth the findings of fact and the conclusions of law.

All proceedings shall be conducted, including all documents presented in such proceedings, in the English language. The number of arbitrators shall be three, with each side to the dispute being entitled to appoint one arbitrator.

The two arbitrators appointed by the parties shall appoint a third arbitrator before proceeding upon the reference. The third arbitrator shall act as chairman of the proceedings. Vacancies in the post of chairman shall be filled by the president of the ICC. Other vacancies shall be filled by the respective nominating party. Proceedings shall continue from the stage they were at when the vacancy occurred.

If one of the parties refuses or otherwise fails to appoint an arbitrator within 30 days of the date the other party appoints its, the first appointed arbitrator shall be the sole arbitrator, provided that the arbitrator was validly and properly appointed.

The English language version of this Agreement prevails over any other language version.

HONG KONG AND MACAU

Governing Law: *The following replaces “laws of the country in which you acquired the Machine” in the first sentence:*

laws of Hong Kong Special Administrative Region.

INDIA

Limitation of Liability: *The following replaces items 1 and 2 of this Section:*

1. liability for bodily injury (including death) or damage to real property and tangible personal property will be limited to that caused by IBM’s negligence;
2. as to any other actual damage arising in any situation involving nonperformance by IBM pursuant to, or in any way related to the subject of this Statement of Limited Warranty, IBM’s liability will be limited to the charge paid by you for the individual Machine that is the subject of the claim.

JAPAN

Governing Law: *The following sentence is added to this Section:*

Any doubts concerning this Agreement will be initially resolved between us in good faith and in accordance with the principle of mutual trust.

NEW ZEALAND

The IBM Warranty for Machines: *The following paragraph is added to this Section:*

The warranties specified in this Section are in addition to any rights you may have under the Consumer Guarantees Act 1993 or other legislation which cannot be excluded or limited. The Consumer Guarantees Act 1993 will not apply in respect of any goods which IBM provides, if you require the goods for the purposes of a business as defined in that Act.

Limitation of Liability: *The following is added to this Section:*

Where Machines are not acquired for the purposes of a business as defined in the Consumer Guarantees Act 1993, the limitations in this Section are subject to the limitations in that Act.

PEOPLE’S REPUBLIC OF CHINA (PRC)

Governing Law: *The following replaces this Section:*

Both you and IBM consent to the application of the laws of the State of New York (except when local law requires otherwise) to govern, interpret, and enforce all your and IBM’s rights, duties, and obligations arising from, or relating in any manner to, the subject matter of this Agreement, without regard to conflict of law principles.

Any disputes arising from or in connection with this Agreement will first be resolved by friendly negotiations, failing which either of us has the right to submit the dispute to the China International Economic and Trade Arbitration Commission in Beijing, the PRC, for arbitration in accordance with its arbitration rules in force at the time. The arbitration tribunal will consist of three arbitrators. The language to be used therein will be English and Chinese. An arbitral award will be final and binding on all the parties, and will be enforceable under the Convention on the Recognition and Enforcement of Foreign Arbitral Awards (1958).

The arbitration fee will be borne by the losing party unless otherwise determined by the arbitral award.

During the course of arbitration, this Agreement will continue to be performed except for the part which the parties are disputing and which is undergoing arbitration.

EUROPE, MIDDLE EAST, AFRICA (EMEA)

THE FOLLOWING TERMS APPLY TO ALL EMEA COUNTRIES:

The terms of this Statement of Limited Warranty apply to Machines purchased from IBM or an IBM reseller.

Warranty Service: If you purchase an IBM Machine in Austria, Belgium, Denmark, Estonia, Finland, France, Germany, Greece, Iceland, Ireland, Italy, Latvia, Lithuania, Luxembourg, Netherlands, Norway, Portugal, Spain, Sweden, Switzerland or United Kingdom, you may obtain warranty service for that Machine in any of those countries from either (1) an IBM reseller approved to perform warranty service or (2) from IBM. If you purchase an IBM Personal Computer Machine in Albania, Armenia, Belarus, Bosnia and Herzegovina, Bulgaria, Croatia, Czech Republic, Georgia, Hungary, Kazakhstan, Kirghizia, Federal Republic of Yugoslavia, Former Yugoslav Republic of Macedonia (FYROM), Moldova, Poland, Romania, Russia, Slovak Republic, Slovenia, or Ukraine, you may obtain warranty service for that Machine in any of those countries from either (1) an IBM reseller approved to perform warranty service or (2) from IBM.

If you purchase an IBM Machine in a Middle Eastern or African country, you may obtain warranty service for that Machine from the IBM entity within the country of purchase, if that IBM entity provides warranty service in that country, or from an IBM reseller, approved by IBM to perform warranty service on that Machine in that country. Warranty service in Africa is available within 50 kilometers of an IBM authorized service provider. You are responsible for transportation costs for Machines located outside 50 kilometers of an IBM authorized service provider.

Governing Law: The applicable laws that govern, interpret and enforce rights, duties, and obligations of each of us arising from, or relating in any manner to, the subject matter of this Statement, without regard to conflict of laws principles, as well as Country-unique terms and competent court for this Statement are those of the country in which the warranty service is being provided, except that in 1) Albania, Bosnia-Herzegovina, Bulgaria, Croatia, Hungary, Former Yugoslav Republic of Macedonia, Romania, Slovakia, Slovenia, Armenia, Azerbaijan, Belarus, Georgia, Kazakhstan, Kyrgyzstan, Moldova, Russia, Tajikistan, Turkmenistan, Ukraine, and Uzbekistan, the laws of Austria apply; 2) Estonia, Latvia, and Lithuania, the laws of Finland apply; 3) Algeria, Benin, Burkina Faso, Cameroon, Cape Verde, Central African Republic, Chad, Congo, Djibouti, Democratic Republic of Congo, Equatorial Guinea, France, Gabon, Gambia, Guinea, Guinea-Bissau, Ivory Coast, Lebanon, Mali, Mauritania, Morocco, Niger, Senegal, Togo, and Tunisia, this Agreement will be construed and the legal relations between the parties will be determined in accordance with the French laws and all disputes arising out of this Agreement or related to its violation or execution, including summary proceedings, will be settled exclusively by the Commercial Court of Paris; 4) Angola, Bahrain, Botswana, Burundi, Egypt, Eritrea, Ethiopia, Ghana, Jordan, Kenya, Kuwait, Liberia, Malawi, Malta, Mozambique, Nigeria, Oman, Pakistan, Qatar, Rwanda, Sao Tome, Saudi Arabia, Sierra Leone, Somalia, Tanzania, Uganda, United Arab Emirates, United Kingdom, West Bank/Gaza, Yemen, Zambia, and Zimbabwe, this Agreement will be governed by English Law and

disputes relating to it will be submitted to the exclusive jurisdiction of the English courts; and 5) in Greece, Israel, Italy, Portugal, and Spain any legal claim arising out of this Statement will be brought before, and finally settled by, the competent court of Athens, Tel Aviv, Milan, Lisbon, and Madrid, respectively.

THE FOLLOWING TERMS APPLY TO THE COUNTRY SPECIFIED:

AUSTRIA AND GERMANY

The IBM Warranty for Machines: *The following replaces the first sentence of the first paragraph of this Section:*

The warranty for an IBM Machine covers the functionality of the Machine for its normal use and the Machine's conformity to its Specifications.

The following paragraphs are added to this Section:

The minimum warranty period for Machines is six months. In case IBM or your reseller is unable to repair an IBM Machine, you can alternatively ask for a partial refund as far as justified by the reduced value of the unrepaired Machine or ask for a cancellation of the respective agreement for such Machine and get your money refunded.

Extent of Warranty: *The second paragraph does not apply.*

Warranty Service: *The following is added to this Section:*

During the warranty period, transportation for delivery of the failing Machine to IBM will be at IBM's expense.

Limitation of Liability: *The following paragraph is added to this Section:*

The limitations and exclusions specified in the Statement of Limited Warranty will not apply to damages caused by IBM with fraud or gross negligence and for express warranty.

The following sentence is added to the end of item 2:

IBM's liability under this item is limited to the violation of essential contractual terms in cases of ordinary negligence.

EGYPT

Limitation of Liability: *The following replaces item 2 in this Section:*

as to any other actual direct damages, IBM's liability will be limited to the total amount you paid for the Machine that is the subject of the claim. For purposes of this item, the term "Machine" includes Machine Code and Licensed Internal Code.

Applicability of suppliers and resellers (unchanged).

FRANCE

Limitation of Liability: *The following replaces the second sentence of the first paragraph of this Section:*

In such instances, regardless of the basis on which you are entitled to claim damages from IBM, IBM is liable for no more than: *(items 1 and 2 unchanged).*

IRELAND

Extent of Warranty: *The following is added to this Section:*

Except as expressly provided in these terms and conditions, all statutory conditions, including all warranties implied, but without prejudice to the generality of the foregoing all warranties implied by the Sale of Goods Act 1893 or the Sale of Goods and Supply of Services Act 1980 are hereby excluded.

Limitation of Liability: *The following replaces items one and two of the first paragraph of this Section:*

1. death or personal injury or physical damage to your real property solely caused by IBM's negligence; and
2. the amount of any other actual direct damages, up to 125 percent of the charges (if recurring, the 12 months' charges apply) for the Machine that is the subject of the claim or which otherwise gives rise to the claim.

Applicability of suppliers and resellers (unchanged).

The following paragraph is added at the end of this Section:

IBM's entire liability and your sole remedy, whether in contract or in tort, in respect of any default shall be limited to damages.

ITALY

Limitation of Liability: *The following replaces the second sentence in the first paragraph:* In each such instance unless otherwise provided by mandatory law, IBM is liable for no more than:

1. *(unchanged)*
2. as to any other actual damage arising in all situations involving nonperformance by IBM pursuant to, or in any way related to the subject matter of this Statement of Warranty, IBM's liability, will be limited to the total amount you paid for the Machine that is the subject of the claim.

Applicability of suppliers and resellers (unchanged).

The following replaces the third paragraph of this Section:

Unless otherwise provided by mandatory law, IBM and your reseller are not liable for any of the following: *(items 1 and 2 unchanged)* 3) indirect damages, even if IBM or your reseller is informed of their possibility.

SOUTH AFRICA, NAMIBIA, BOTSWANA, LESOTHO AND SWAZILAND

Limitation of Liability: *The following is added to this Section:*

IBM's entire liability to you for actual damages arising in all situations involving nonperformance by IBM in respect of the subject matter of this Statement of Warranty will be limited to the charge paid by you for the individual Machine that is the subject of your claim from IBM.

UNITED KINGDOM

Limitation of Liability: *The following replaces items 1 and 2 of the first paragraph of this Section:*

1. death or personal injury or physical damage to your real property solely caused by IBM's negligence;
2. the amount of any other actual direct damages or loss, up to 125 percent of the charges (if recurring, the 12 months' charges apply) for the Machine that is the subject of the claim or which otherwise gives rise to the claim;

The following item is added to this paragraph:

3. breach of IBM's obligations implied by Section 12 of the Sale of Goods Act 1979 or Section 2 of the Supply of Goods and Services Act 1982.

Applicability of suppliers and resellers (unchanged).

The following is added to the end of this Section:

IBM's entire liability and your sole remedy, whether in contract or in tort, in respect of any default shall be limited to damages.

Appendix E. European Union warranty information

Consumers in the European Union have legal rights under applicable national legislation governing the sale of consumer goods. This legislation may apply to you if you purchased this product as a consumer (that is, as a natural person, and for personal use which is not related to your trade, business or profession). To obtain warranty service under this legislation, you will need to present the proof of purchase to IBM, together with an indication that you are a consumer.

Dans l'Union européenne, les consommateurs disposent de droits selon la loi en vigueur nationale régissant la vente de biens de consommation. Cette loi peut vous être applicable si vous avez acheté ce produit en tant que consommateur (c'est-à-dire, en tant que personne physique, et pour un usage privé qui n'a aucun rapport avec votre commerce, votre métier ou profession). Pour bénéficier du service prévu par la Garantie dans le cadre de cette loi, vous devez présenter la preuve d'achat correspondante à IBM, en lui indiquant que vous êtes un consommateur.

I consumatori dell'Unione Europea sono tutelati dalla legislazione nazionale che regola la vendita dei beni al consumatore. Tale legislazione può essere applicata se il prodotto è stato acquistato da un consumatore (vale a dire, una persona fisica e per uso personale non legato al commercio, all'azienda o alla professione svolta). Per ottenere il servizio di garanzia con questa legislazione, occorre presentare una prova di acquisto alla IBM, insieme con l'indicazione che il richiedente è un consumatore.

In der Europäischen Union haben die Verbraucher nach der geltenden nationalen Gesetzgebung Rechte hinsichtlich des Verbrauchsgüterkaufs. Diese Gesetzgebung kann für Sie gelten, wenn Sie dieses Produkt als Privatkunde erworben haben (d. h. als natürliche Person und für den persönlichen Gebrauch, der nicht mit Ihrem Gewerbe, Ihrem Unternehmen oder Ihrer beruflichen Tätigkeit zusammenhängt). Um unter dieser Gesetzgebung Garantieservice zu erhalten, müssen Sie IBM den Kaufnachweis zusammen mit einem Nachweis dafür, dass Sie Privatkunde sind, vorlegen.

Los consumidores de la Unión europea tienen derechos legales de acuerdo con la legislación nacional aplicable que regula la venta de bienes de consumo. Esta legislación puede aplicarse en su caso si ha adquirido este producto como un consumidor (es decir, como una persona natural y para uso personal que no esté relacionado con su comercio, negocio o profesión). Para obtener servicio de garantía de acuerdo con esta legislación, tendrá que presentar el justificante de compra a IBM, junto con información indicando que es un consumidor.

Na União Europeia, os consumidores gozam de direitos legais nos termos da legislação nacional aplicável que rege a venda de bens de consumo. Esta legislação poderá ser-lhe aplicável caso tenha adquirido este produto na qualidade de consumidor (ou seja, um indivíduo, para utilização pessoal, não relacionada com a sua actividade profissional, comercial ou negócio). Para obter serviço de garantia nos termos desta legislação, terá que apresentar a prova de compra à IBM, em conjunto com a indicação de que adquiriu o produto na qualidade de consumidor.

Forbrugere i EU har via gældende national lovgivning visse rettigheder i forbindelse med salg af forbrugsvarer. Denne lovgivning gælder muligvis for dig,

hvis du har anskaffet dette produkt som forbruger, dvs. som fysisk person og til personlig brug og ikke i forbindelse med dit fag, din forretning eller din profession. For at opnå garantiservice i henhold til denne lovgivning skal du vise kvitteringen for købet af produktet til IBM og angive, at du er forbruger.

Klanten in de Europese Unie hebben wettelijke rechten onder toepasselijke landelijke wetgeving die van toepassing is op de verkoop van consumptiegoederen. Deze wetgeving is mogelijk op u van toepassing als u dit product als consument hebt aangeschaft (dat is als natuurlijk persoon en voor persoonlijk gebruik dat niet in verband staat tot uw handel, zaken of beroep). Voor het verkrijgen van garantiservice onder deze wetgeving moet u het bewijs van aankoop kunnen tonen aan IBM, samen met een indicatie dat u een consument bent.

EU-maissa kuluttajilla on kulutustavaroiden myyntiä koskevan paikallisen lainsäädännön mukaiset oikeudet. Tämä lainsäädäntö saattaa koskea teitä, jos olette hankkinut tämän tuotteen kuluttajana (luonnollisena henkilönä kaupankäyntiin, liiketoimintaan tai ammatinharjoittamiseen liittymättömä henkilökohtaiseen käyttöön). Täyttäkää tässä tapauksessa alla olevat tie ja toimittakaa kortti IBM:lle rekisteröintiä varten. IBM käyttää tietoja varmistaakseen, että teille kuuluvat kuluttajan oikeudet toteutuvat.

Konsumenter inom EU har lagliga rättigheter i enlighet med tillämplig lagstiftning i varje land, avseende försäljning av konsumentvaror. Denna lagstiftning kan gälla dig, om du har köpt varan i egenskap av konsument (med konsument avses en fysisk person som köper en vara för personligt bruk, ej relaterat till personens yrkesmässiga verksamhet). Om du vill ha garantiservice i enlighet med denna lagstiftning, måste du visa upp ett inköpsbevis för IBM, tillsammans med något som tyder på att du är konsument.

Οι καταναλωτές στην Ευρωπαϊκή Ένωση έχουν νόμιμα δικαιώματα βάσει της ισχύουσας εθνικής νομοθεσίας που διέπει την πώληση καταναλωτικών αγαθών. Η νομοθεσία αυτή εφαρμόζεται στην περίπτωση σας εάν αγοράσατε αυτό το προϊόν ως καταναλωτής (δηλαδή ως φυσικό πρόσωπο και για προσωπική χρήση που δεν σχετίζεται με την επιχείρησή ή το επάγγελμά σας). Για να λάβετε υπηρεσίες εγγύησης βάσει της εν λόγω νομοθεσίας, θα πρέπει να προσκομίσετε στην IBM την απόδειξη αγοράς και να δηλώσετε ότι είστε καταναλωτής.

Appendix F. Notices

IBM may not offer the products, services, or features discussed in this document in all countries. Consult your local IBM representative for information on the products and services currently available in your area. Any reference to an IBM product, program, or service is not intended to state or imply that only that IBM product, program, or service may be used. Any functionally equivalent product, program, or service that does not infringe any IBM intellectual property right may be used instead. However, it is the user's responsibility to evaluate and verify the operation of any non-IBM product, program, or service.

IBM may have patents or pending patent applications covering subject matter described in this document. The furnishing of this document does not give you any license to these patents. You can send license inquiries, in writing, to:

*IBM Director of Licensing
IBM Corporation
North Castle Drive
Armonk, NY 10504-1785
U.S.A.*

INTERNATIONAL BUSINESS MACHINES CORPORATION PROVIDES THIS PUBLICATION "AS IS" WITHOUT WARRANTY OF ANY KIND, EITHER EXPRESS OR IMPLIED, INCLUDING, BUT NOT LIMITED TO, THE IMPLIED WARRANTIES OF NON-INFRINGEMENT, MERCHANTABILITY OR FITNESS FOR A PARTICULAR PURPOSE. Some jurisdictions do not allow disclaimer of express or implied warranties in certain transactions, therefore, this statement may not apply to you.

This information could include technical inaccuracies or typographical errors. Changes are periodically made to the information herein; these changes will be incorporated in new editions of the publication. IBM may make improvements and/or changes in the product(s) and/or the program(s) described in this publication at any time without notice.

The products described in this document are not intended for use in implantation or other life support applications where malfunction may result in injury or death to persons. The information contained in this document does not affect or change IBM product specifications or warranties. Nothing in this document shall operate as an express or implied license or indemnity under the intellectual property rights of IBM or third parties. All information contained in this document was obtained in specific environments and is presented as an illustration. The result obtained in other operating environments may vary.

IBM may use or distribute any of the information you supply in any way it believes appropriate without incurring any obligation to you.

Any references in this publication to non-IBM Web sites are provided for convenience only and do not in any manner serve as an endorsement of those Web sites. The materials at those Web sites are not part of the materials for this IBM product, and use of those Web sites is at your own risk.

Any performance data contained herein was determined in a controlled environment. Therefore, the result obtained in other operating environments may

vary significantly. Some measurements may have been made on development-level systems and there is no guarantee that these measurements will be the same on generally available systems. Furthermore, some measurements may have been estimated through extrapolation. Actual results may vary. Users of this document should verify the applicable data for their specific environment.

Trademarks

The following terms are trademarks of International Business Machines Corporation in the United States, other countries, or both:

IBM
IBM logo
HelpCenter

Microsoft, Windows, and Windows NT are trademarks of Microsoft Corporation in the United States, other countries, or both.

Other company, product, or service names may be trademarks or service marks of others.

Electronic emission notices

Machine - iLC300 Conference Video Projector

Federal Communications Commission (FCC) statement

IBM Conference Projector

Note: This equipment has been tested and found to comply with the limits for a Class A digital device, pursuant to Part 15 of the FCC Rules. These limits are designed to provide reasonable protection against harmful interference when the equipment is operated in a commercial environment. This equipment generates, uses, and can radiate radio frequency energy and, if not installed and used in accordance with the instruction manual, may cause harmful interference to radio communications. Operation of this equipment in a residential area is likely to cause harmful interference, in which case the user will be required to correct the interference at his own expense.

Properly shielded and grounded cables and connectors must be used in order to meet FCC emission limits. IBM is not responsible for any radio or television interference caused by using other than recommended cables and connectors or by unauthorized changes or modifications to this equipment. Unauthorized changes or modifications could void the user's authority to operate the equipment.

This device complies with Part 15 of the FCC Rules. Operation is subject to the following two conditions: (1) this device may not cause harmful interference, and (2) this device must accept any interference received, including interference that may cause undesired operation.

Industry Canada Class A emission compliance statement

This Class A digital apparatus complies with Canadian ICES-003.

Avis de conformité a la réglementation d'Industrie Canada

Cet appareil numérique de la classe A est conform à la norme NMB-003 du Canada.

Deutsche EMV-Direktive (electromagnetische Verträglichkeit)

Dieses Gerät ist berechtigt in Übereinstimmung mit dem deutschen EMVG vom 9.Nov.92 das EG-Konformitätszeichen zu führen.

Der Aussteller der Konformitätserklärung ist die IBM UK, Greenock.

Dieses Gerät erfüllt die Bedingungen der EN 55022 Klasse A. Für diese Klasse von Geräten gilt folgende Bestimmung nach dem EMVG:

Geräte dürfen an Orten, für die sie nicht ausreichend entstört sind, nur mit besonderer Genehmigung des Bundesministers für Post und Telekommunikation oder des Bundesamtes für Post und Telekommunikation betrieben werden. Die Genehmigung wird erteilt, wenn keine elektromagnetischen Störungen zu erwarten sind.

(Auszug aus dem EMVG vom 9.Nov.92, Para.3. Abs.4)

Hinweis: Dieses Genehmigungsverfahren ist von der Deutschen Bundespost noch nicht veröffentlicht worden.

European Union - EMC directive

This product is in conformity with the protection requirements of EU Council Directive 89/336/ECC on the approximation of the laws of the Member States relating to electromagnetic compatibility.

IBM cannot accept responsibility for any failure to satisfy the protection requirements resulting from a non-recommended modification of the product, including the fitting of non-IBM option cards.

This product has been tested and found to comply with the limits for Class A Information Technology Equipment according to CISPR 22/European Standard EN 55022. The limits for Class A equipment were derived for commercial and industrial environments to provide reasonable protection against interference with licensed communication equipment.

Warning: This is a Class A product. In a domestic environment this product may cause radio interference in which case the user may be required to take adequate measures.
--

Union Européenne - Directive Conformité électromagnétique

Ce produit est conforme aux exigences de protection de la Directive 89/336/EEC du Conseil de l'UE sur le rapprochement des lois des États membres en matière de compatibilité électromagnétique.

IBM ne peut accepter aucune responsabilité pour le manquement aux exigences de protection résultant d'une modification non recommandée du produit, y compris l'installation de cartes autres que les cartes IBM.

Ce produit a été testé et il satisfait les conditions de l'équipement informatique de Classe A en vertu de CISPR22/Standard européen EN 55022. Les conditions pour

l'équipement de Classe A ont été définies en fonction d'un contexte d'utilisation commercial et industriel afin de fournir une protection raisonnable contre l'interférence d'appareils de communication autorisés.

Avvertissement : Ceci est un produit de Classe A. Dans un contexte résidentiel, ce produit peut causer une interférence radio exigeant que l'utilisateur prenne des mesures adéquates.

Union Europea - Normativa EMC

Questo prodotto è conforme alle normative di protezione ai sensi della Direttiva del Consiglio dell'Unione Europea 89/336/CEE sull'armonizzazione legislativa degli stati membri in materia di compatibilità elettromagnetica.

IBM non accetta responsabilità alcuna per la mancata conformità alle normative di protezione dovuta a modifiche non consigliate al prodotto, compresa l'installazione di schede e componenti di marca diversa da IBM.

Le prove effettuate sul presente prodotto hanno accertato che esso rientra nei limiti stabiliti per le apparecchiature di informatica Classe A ai sensi del CISPR 22/Norma Europea EN 55022. I limiti delle apparecchiature della Classe A sono stati stabiliti al fine di fornire ragionevole protezione da interferenze mediante dispositivi di comunicazione in concessione in ambienti commerciali ed industriali.

Avvertimento: Questo è un prodotto appartenente alla Classe A. In ambiente domestico, tale prodotto può essere causa di interferenze radio, nel qual caso l'utente deve prendere misure adeguate.

Unione Europea - Directiva EMC (Conformidad electromagnética)

Este producto satisface los requisitos de protección del Consejo de la UE, Directiva 89/336/CEE en lo que a la legislación de los Estados Miembros sobre compatibilidad electromagnética se refiere.

IBM no puede aceptar responsabilidad alguna si este producto deja de satisfacer dichos requisitos de protección como resultado de una modificación no recomendada del producto, incluyendo el ajuste de tarjetas de opción que no sean IBM.

Este producto ha sido probado y satisface los límites para Equipos Informáticos Clase A de conformidad con el Estándar CISPR22 y el Estándar Europeo EN 55022. Los límites para los equipos de Clase A se han establecido para entornos comerciales e industriales a fin de proporcionar una protección razonable contra las interferencias con dispositivos de comunicación licenciados.

Advertencia: Este es un producto de Clase A. En un entorno doméstico este producto podría causar radiointerferencias en cuyo caso el usuario deberá tomar las medidas adecuadas.

この装置は、情報処理装置等電波障害自主規制協議会（VCCI）の基準に基づきクラスA情報技術装置です。この装置を家庭環境で使用すると電波妨害を引き起こすことがあります。この場合には使用者が適切な対策を講ずるよう要求されることがあります。

警告使用者：
這是甲類的資訊產品，在
居住的環境中使用時，可
能會造成射頻干擾，在這
種情況下，使用者會被要
求採取某些適當的對策。



Part Number: 31P9922

Printed in U.S.A.

(1P) P/N: 31P9922

