

myprojectorlamps.com

**The most trusted, dependable name
in projector lamp sales.**



<http://www.myprojectorlamps.com>



<http://www.myprojectorlamps.ca>



<http://www.myprojectorlamps.eu>

The following projector manual has not been modified or altered in any way.



i n v e n t

HP vp6200 Series Digital Projector

User's Guide

Notice

© Copyright 2004 Hewlett-Packard Development Company, L.P.

The information contained herein is subject to change without notice. The only warranties for HP products and services are set forth in the express warranty statements accompanying such products and services. Nothing herein should be construed as constituting an additional warranty. HP shall not be liable for technical or editorial errors or omissions contained herein. Reproduction, adaptation, or translation without prior written permission is prohibited except as allowed under the copyright laws.

Consumer transactions in Australia and the United Kingdom: The above disclaimers and limitations shall not apply to consumer transactions in Australia and the United Kingdom and shall not affect the statutory rights of consumers.

Hewlett-Packard Company

Digital Projection and Imaging

1000 NE Circle Blvd.

Corvallis, OR 97330

Second Edition October 2004

Contents

1. Safety Instructions	5
2. Introduction	7
Projector Features	7
Shipping Contents	8
Accessories	9
Projector Exterior View	9
Front / Upper Side	9
Rear Side	9
Connector Panel	10
Controls and Functions	11
Projector	11
Remote Control	12
Aiming the Remote Control	13
Replacing the Battery in the Remote Control	13
3. Installation	14
Choosing a Location	14
Adjusting the Height	15
Screen Size	15
4. Connection	17
Connecting to a Laptop or Desktop Computer	17
Connecting Component-Video Devices	17
Connecting S-Video Devices	18
Connecting Composite-Video Devices	18
Connecting to Display Devices	19
5. Operation	20
Startup	20
Shutdown	21
Source Selection	21
Keystone Correction	22
Auto Sync Adjustment	23
Hide the Picture	23
Zoom / Focusing	23
Picture Mode	24
Slide Operation	24

Menu Operation	25
Using the Menus	25
1. Picture Menu	26
2. Advanced Picture Menu	27
3. Setup Menu	28
4. Advanced Setup Menu	29
5. Information Menu	30
6. Maintenance	31
Care of the Projector	31
Cleaning the Lens	31
Cleaning the Projector Case	31
Storing the Projector	31
Transporting the projector	31
Lamp Information	32
Warning Messages	32
Replacing the Lamp	32
Indicators	34
Power indicator	34
Lamp indicator	34
Temperature indicator	34
Updating the firmware	34
7. Troubleshooting.....	35
8. Specifications	36
Projector Specifications	36
Timing Chart	37
Supported Timing for PC Input	37
Supported Timing for Component-YPbPr Input	37
Supported Timing for Composite-Video and S-Video Inputs	37
9. Dimensions.....	38
10. Regulation Statements	39
Safety information	39
Safety Precautions	39
Mercury Safety	39
Regulatory information	39
U.S.A.	39
Canada	40
Japan	40
Korea	40
International	40

1. Safety Instructions

Your projector is designed and tested to meet the latest standards for safety of information technology equipment. However, to ensure safe use of this product, it is important that you follow the instructions mentioned in this manual and marked on the product.

Warning

- **To prevent shock, do not open the cabinet.** There are no user serviceable parts inside.
 - **Please read this user's manual before you operate your projector.** Save this user's manual for future reference.
 - **Do not look straight at the projector lens during operation.** The intense light beam may damage your eyes.
 - **Refer servicing to qualified service personnel.**
 - **Always open the lens shutter or remove the lens cap when the projector lamp is on.**
 - In some countries, the line voltage is NOT stable. This projector is designed to operate safely within a mains voltage between 100 to 240 volts AC, but could fail if power cuts or surges of ± 10 volts occur. **In areas where the mains voltage may fluctuate or cut out, it is recommended that you connect your projector through a power stabilizer, surge protector or uninterruptible power supply (UPS).**
-
- The lamp becomes extremely hot during operation. Allow the projector to cool for approximately 45 minutes prior to removing the lamp assembly for replacement.
 - Do not operate lamps beyond the rated lamp life. Excessive operation of lamps beyond the rated life could cause them to break on rare occasions.
 - Never replace the lamp assembly or any electronic components unless the projector is unplugged.
 - Do not place this product on an unstable cart, stand, or table. The product may fall, sustaining serious damage.
 - To reduce the risk of electric shock, do not disassemble this appliance. Take it to a qualified technician when service or repair is required. Incorrect reassembly can cause malfunction of the projector or electric shock when the appliance is subsequently used.
 - This product is capable of displaying inverted images for ceiling mount installation. Use the HP L1704A ceiling mount for mounting the unit and ensure it is securely installed.

- Do not block the ventilation holes.
 - Do not place this unit on a blanket, bedding or any other soft surface.
 - Do not cover this unit with a cloth or any other item.
 - Do not place inflammables near the projector.If the ventilation holes are seriously obstructed, overheating inside the unit may result in damage.

- Do not place this unit in any of the following environments.
 - Space that is poorly ventilated or confined. Allow at least 50 cm clearance from walls and free flow of air around the projector.
 - Locations where temperatures may become excessively high, such as the inside of a car with all windows rolled up.
 - Locations where excessive humidity, dust, or cigarette smoke may contaminate optical components, shortening the projector's life span and darkening the image.
 - Locations near fire alarms
 - Locations with an ambient temperature above 35°C / 95°F
- Always place the unit on a level, horizontal surface during operation.
- Do not stand the unit on end vertically. Doing so may cause the unit to fall over, causing injury or resulting in damage to the unit.
- Do not step on this unit or place any objects upon it. Besides probable physical damage to the unit, doing so may result in accidents and possible injury.
- Do not place liquids near or on the projector. Liquids spilled into the projector may cause it to fail. If the projector does become wet, disconnect it from the power supply's wall socket and contact HP to have the projector serviced.

2. Introduction

Projector Features

The projector integrates high-performance projection and a user-friendly design to deliver high reliability and ease of use.

The projector offers the following features:

- Compact and portable unit
- High quality manual zoom lens
- One-key auto-adjustment to display the best picture quality
- Digital keystone correction to correct distorted images
- Adjustable color balance control for data/video display
- Ultra-high brightness projection lamp
- Ability to display 16.7 million colors
- Switchable normal and Economic modes to reduce the power consumption
- Powerful AV function
- HDTV compatibility

 **Note: The apparent brightness of the projected image will vary depending on the ambient lighting conditions and contrast/brightness settings.**

Shipping Contents

The projector is shipped with the cables required for connection to a PC. Carefully unpack and verify that you have all of the items shown below. If any of these items are missing, please contact your place of purchase.

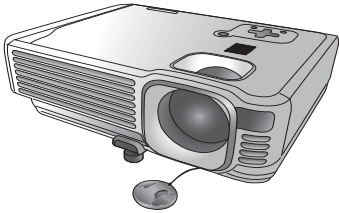

Projector

Power cord

VGA cable

USB Cable

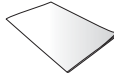
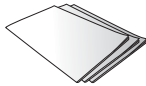

Remote Control

Warranty and Support

Quick Setup Guide

User's Guide CD

 Pull the tab before using the remote control.

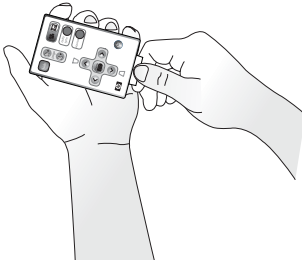

Accessories

Get more from your presentations with HP projector accessories. You can purchase accessories at www.hp.com or through your projector dealer.

- HP ceiling mount kit enables you to simply and discreetly install your projector on the ceiling.
- HP mobile screens with built-in handles are easy to carry and set up anywhere you need them.
- HP premium remote control allows you to control every aspect of your presentation.
- HP power cables allow you to connect in any region.
- HP cables allow you to connect all audio-video equipment.
- HP replacement lamp brings your projector up to factory-fresh brightness.

Projector Exterior View

Front / Upper Side

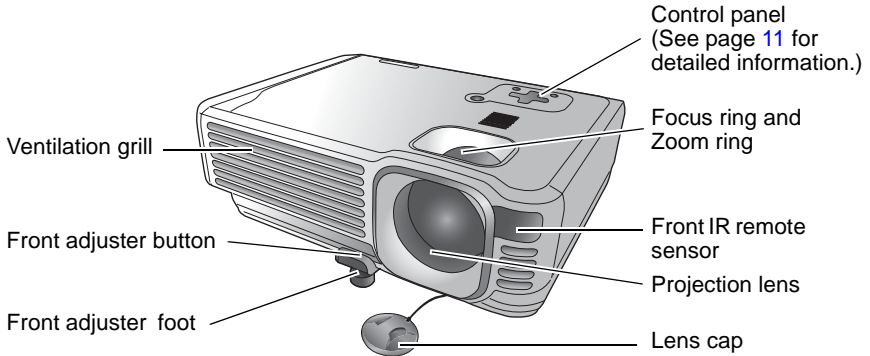

Rear Side

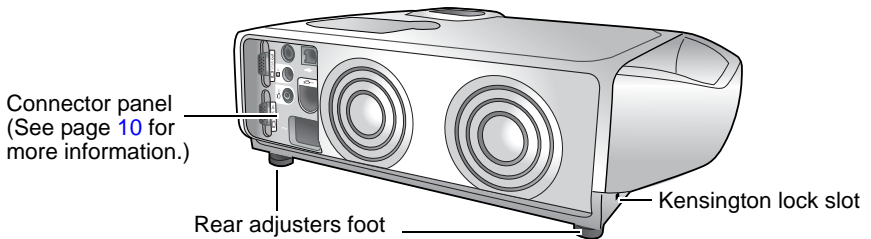

Connector Panel

Refer to page 17 for more information on making connections to various equipment.

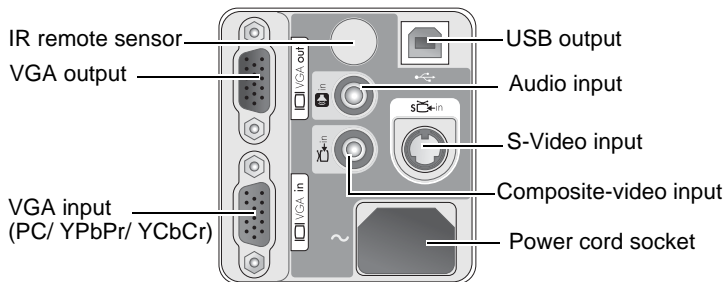

Controls and Functions

Projector

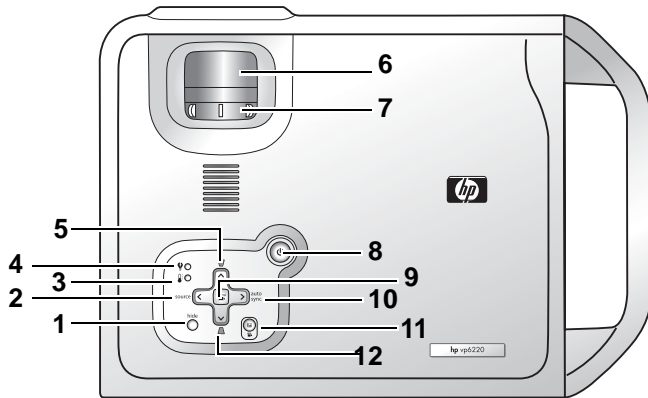

1. **Hide button (Refer to page 23 for more information.)**
Hides the display.
2. **Source button (Refer to page 21 for more information.)**
Switches to the next input source. Cycles through VGA, composite video, and S-video inputs.
3. **Temperature-warning light (Refer to page 34 for more information.)**
Turns on when the internal temperature is too high.
4. **Lamp-warning light (Refer to page 32 for more information.)**
Turns on when lamp fails.
5. **Keystone buttons (Refer to page 22 for more information.)**
Adjust the picture to eliminate slanted sides.
6. **Focus ring**
Adjusts the focus of the picture.
7. **Zoom ring**
Adjusts the size of the picture.
8. **Power button (Refer to pages 20 and 21 for more information.)**
Turns the projector on or off.
9. **Menu button and directional arrows (Refer to page 25 for more information.)**
Change projector settings using the on-screen menu.
10. **Auto sync button (Refer to page 23 for more information.)**
Resynchronizes the projector to a PC input signal.
11. **Picture mode button (Refer to page 24 for more information.)**
Adjusts the picture so it is optimized for different types of inputs.
12. **Keystone buttons (Refer to page 22 for more information.)**
Adjust the picture to eliminate slanted sides.

Remote Control

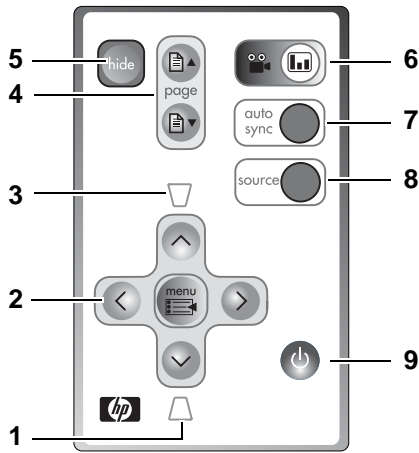

1. **Keystone button (Refer to page 22 for more information.)**
Adjust the picture to eliminate slanted sides.
2. **Menu button and directional arrows (Refer to page 25 for more information.)**
Change projector settings using the on-screen menu.
3. **Keystone button (Refer to page 22 for more information.)**
Adjust the picture to eliminate slanted sides.
4. **Page-up and page-down buttons (Refer to page 24 for more information.)**
Scroll up and down through pages on a connected PC.
5. **Hide button (Refer to page 23 for more information.)**
Hides the display.
6. **Picture mode button (Refer to page 24 for more information.)**
Adjusts the picture so it is optimized for different types of inputs.
7. **Auto sync button (Refer to page 23 for more information.)**
Resynchronizes the projector to a PC input signal.
8. **Source button (Refer to page 21 for more information.)**
Switches to the next input source. Cycles through VGA, composite video, and S-video inputs.
9. **Power button (Refer to pages 20 and 21 for more information.)**
Turns the projector on or off.

Aiming the Remote Control

Infrared (IR) remote control sensors are located on the front and the back of the projector. The remote control must be held at an angle within 30 degrees of the projection screen or the projector's IR remote control sensors to function correctly. The distance between the remote control and the sensors should not exceed 6 meters (19.5 feet).

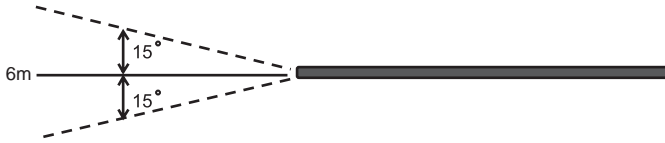

Notes on Remote Control Operation:

Make sure that there are no obstacles between the remote control and the IR sensors on the projector that might obstruct the infra-red beam.

Replacing the Battery in the Remote Control

1. Using a ballpoint pen, push and hold the battery latch toward the center, then pull out the battery holder.
2. Remove the old battery from the battery holder.

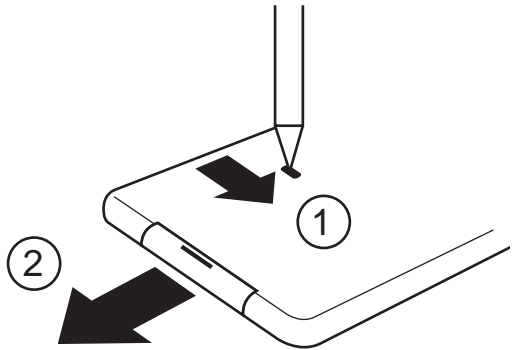

3. Insert the new battery in the holder.
4. Push the holder into the remote control.

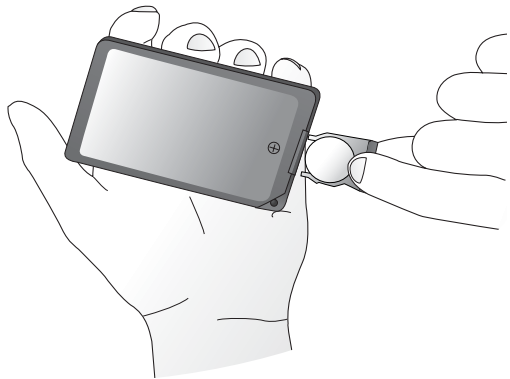

 **Avoid excessive heat and humidity.** There may be danger of an explosion if the battery is incorrectly replaced. Replace only with the same or equivalent type recommended by the manufacturer. Dispose of the used battery according to the manufacturer's instructions.

3. Installation

Choosing a Location

Your projector is designed to be installed in the four installation configurations shown here. Your room layout or personal preference will dictate which installation configuration you use.

I. Table front

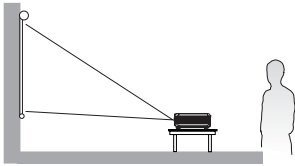

II. Ceiling front

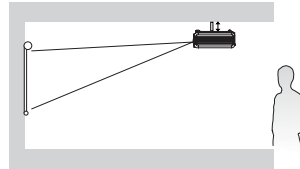

III. Table rear

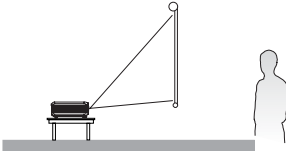

IV. Ceiling rear

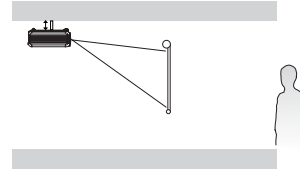

For further information on the four configurations, please refer to page [29](#).

If you place the projector above or below the screen, you have to tilt it down or up to center the image on the screen, in these situations image distortion will occur. Use the Keystone function to correct the distortion. See page [22](#) for keystone correction.

Adjusting the Height

The projector is equipped with 1 quick-release adjuster foot and 2 rear adjuster feet. These adjusters change the image height and projection angle. To adjust the projector,

1. Lift the projector up and press the adjuster button to release the adjuster. The adjuster will drop into position and be locked. It can lift the projector by up to 15 degrees.
2. Screw the rear adjuster feet to fine tune the horizontal angle.

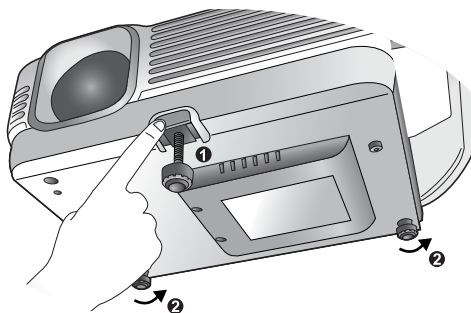

Press the adjuster button again to retract the foot.

 If the screen and the projector are not perpendicular to each other, the projected image becomes trapezoidal. To correct this situation, adjust the value of Keystone in the Picture menu, on the projector control panel or on the remote control.

Screen Size

Place the projector at the required distance from the screen according to the required picture size (see the table on the next page).

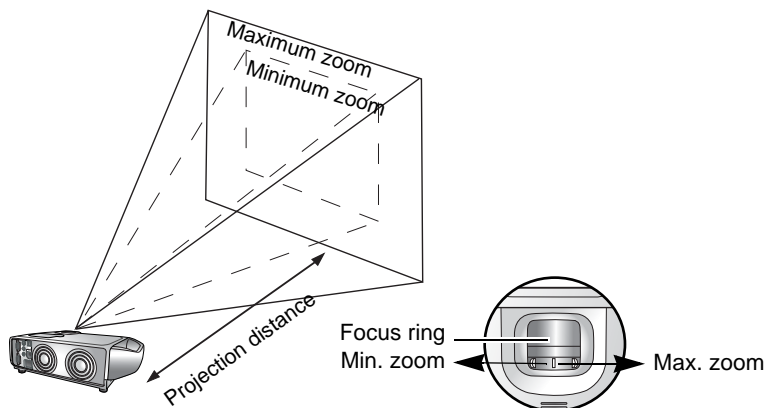

Screen size chart (4:3 aspect ratio)

Distance from screen		Diagonal measurement			
		Minimum zoom		Maximum zoom	
feet	inch	feet	inch	feet	inch
4	48	2.49	29.9	3.05	36.6
6	72	3.73	44.8	4.57	54.9
8	96	4.98	59.7	6.10	73.2
10	120	6.22	74.7	7.62	91.4
12	144	7.47	89.6	9.14	109.7
14	168	8.71	104.5	10.67	128.0
16	192	9.96	119.5	12.19	146.3
18	216	11.20	134.4	13.72	164.6
20	240	12.45	149.4	15.24	182.9
22	264	13.69	164.3	16.76	201.2
24	288	14.94	179.2	18.29	219.5
26	312	16.18	194.2	19.81	237.7
28	336	17.42	209.1	21.34	256.0
30	360	18.67	224.0	22.86	274.3
32	384	19.91	239.0	24.38	292.6

Distance from screen		Diagonal measurement			
		Minimum zoom		Maximum zoom	
meter	cm	meter	cm	meter	cm
1	100	0.62	62.2	0.76	76.2
1.5	150	0.93	93.3	1.14	114.3
2	200	1.24	124.5	1.52	152.4
2.5	250	1.56	155.6	1.91	190.5
3	300	1.87	186.7	2.29	228.6
3.5	350	2.18	217.8	2.67	266.7
4	400	2.49	248.9	3.05	304.8
4.5	450	2.80	280.0	3.43	342.9
5	500	3.11	311.2	3.81	381.0
5.5	550	3.42	342.3	4.19	419.1
6	600	3.73	373.4	4.57	457.2
6.5	650	4.04	404.5	4.95	495.3
7	700	4.36	435.6	5.33	533.4
7.5	750	4.67	466.7	5.72	571.5
8	800	4.98	497.8	6.10	609.6

Screen size chart (16:9 aspect ratio)

Distance from screen		Diagonal measurement			
		Minimum zoom		Maximum zoom	
feet	inch	feet	inch	feet	inch
4	48	2.29	27.5	2.80	33.6
6	72	3.44	41.3	4.20	50.4
8	96	4.59	55.1	5.60	67.2
10	120	5.74	68.8	7.00	84.0
12	144	6.88	82.6	8.40	100.8
14	168	8.03	96.4	9.80	117.6
16	192	9.18	110.1	11.20	134.4
18	216	10.32	123.9	12.60	151.2
20	240	11.47	137.7	14.00	167.9
22	264	12.62	151.4	15.39	184.7
24	288	13.77	165.2	16.79	201.5
26	312	14.91	179.0	18.19	218.3
28	336	16.06	192.7	19.59	235.1
30	360	17.21	206.5	20.99	251.9
32	384	18.35	220.3	22.39	268.7

Distance from screen		Diagonal measurement			
		Minimum zoom		Maximum zoom	
meter	cm	meter	cm	meter	cm
1	100	0.57	57.4	0.70	70.0
1.5	150	0.86	86.0	1.05	105.0
2	200	1.15	114.7	1.40	140.0
2.5	250	1.43	143.4	1.75	179.4
3	300	1.72	172.1	2.10	209.9
3.5	350	2.01	200.8	2.45	244.9
4	400	2.29	229.4	2.80	279.9
4.5	450	2.58	258.1	3.15	314.9
5	500	2.87	286.8	3.50	349.9
5.5	550	3.15	315.5	3.85	384.9
6	600	3.44	344.1	4.20	419.9
6.5	650	3.73	372.8	4.55	454.9
7	700	4.02	401.5	4.90	489.8
7.5	750	4.30	430.2	5.25	524.8
8	800	4.59	458.9	5.60	559.8

 There is 3% ~ 5% tolerance among these numbers due to optical component variations.

4. Connection

When connecting a signal source to the projector, be sure to:

1. Turn all equipment off before making any connections.
2. Use the correct signal cables for each source.
3. Ensure the cables are firmly inserted.

 In the connections shown below, only certain cables are included with the projector (see page 8). Other cables are available from HP or from electronics stores.

Connecting to a Laptop or Desktop Computer

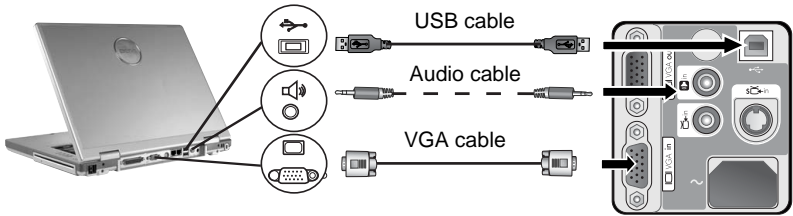

Connecting Component-Video Devices

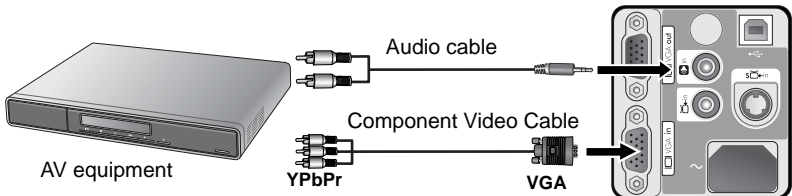

The projector is capable of displaying various High Definition TV display modes. Some of these sources are:

- Digital-VHS (D-VHS) player
- DVD player
- Satellite Dish HDTV receiver
- Digital TV tuners

Most of these sources will provide an analog component video output, a standard VGA output, or a YPbPr (default) format.

The projector is capable of accepting HDTV data through a Component Video connector. Use a Component Video cable (an optional accessory) to display these images.

The following standards are supported in the HDTV function:

- 480i
- 480p
- 576i
- 576p
- 720p (50/ 60 Hz)
- 1080i (50/ 60 Hz)

Connecting S-Video Devices

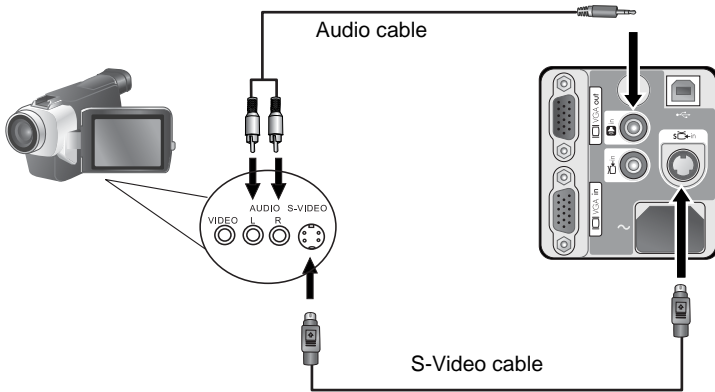

Connecting Composite-Video Devices

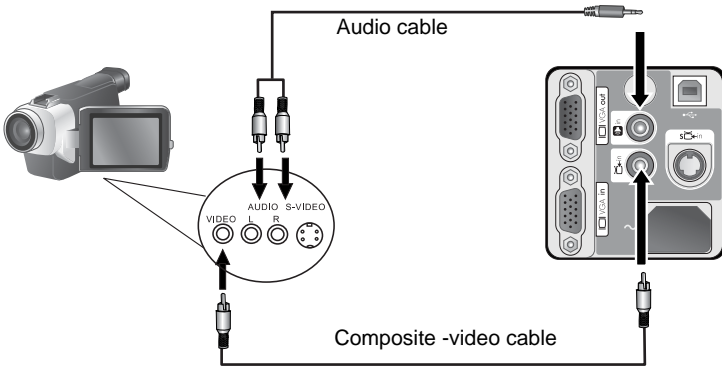

 If the selected video image is not displayed after the projector is turned on and the correct video source has been selected, check that the video source is turned on and operating correctly. Also check that the signal cables have been connected correctly.

Connecting to Display Devices

If you want to monitor your presentation close-up on a monitor as well as on the screen, you can connect the VGA signal output port on the projector to an external monitor with a VGA cable.

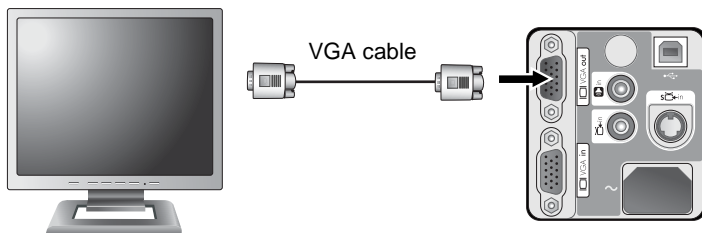

5. Operation

Startup

1. Switch all of the connected equipment on.
2. Plug the power cord into the projector and into a wall socket.

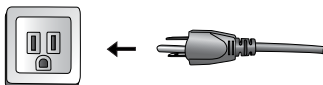

3. Turn on the wall socket switch (where fitted).
4. Press **Power** on the remote control or projector to start the unit. The Power button flashes during warm up, then turns on solid.

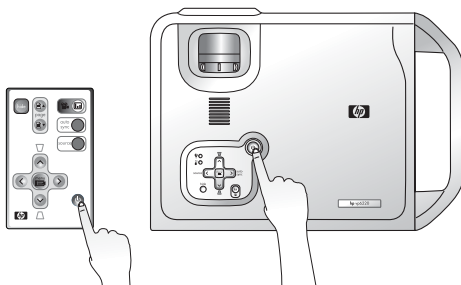

5. The projector searches the input ports for an input signal. A message on the screen shows the ports being searched.

You can also press **source** on the projector or remote control to select your desired input signal. For more information, please refer to page [21](#).

 If the frequency or resolution of the input signal exceeds the projector's operating range, you will see the message "Out of Range" displayed on a blank screen.

Shutdown

1. Press the **Power** button on the projector or remote control. The **Power** button flashes and the lamp shuts down, the fans continue to run for approximately 2 minutes to cool down the projector.

 To protect the lamp, the projector will not respond to any commands during the cooling process.

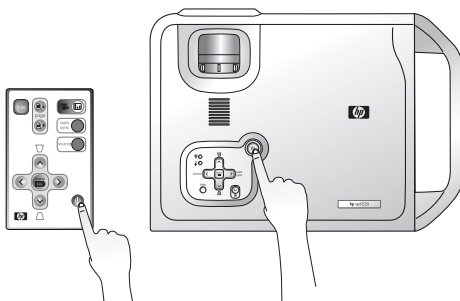

2. Disconnect the power cord from the wall socket.

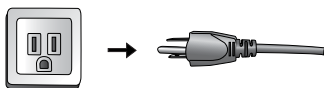

 Do not unplug the power cord before the projector shutdown sequence is complete or during the 2-minute cooling down process. If the projector is not properly shut down, and you attempt to restart it soon after, the fans may run for a few minutes to cool down. Press Power again to start the projector after the fans stop.

Source Selection

To sequentially select input sources, press **source** on the projector control panel or the remote control. It may take you a few seconds when the projector is searching for input signals. The selected source will be displayed at the bottom right of the screen for 3 seconds. For a quick search, you can also press the key repeatedly until your desired signal is displayed.

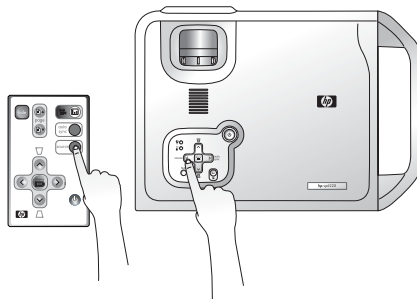

Keystone Correction

Keystoning refers to the situation where the projected image is noticeably wider at either the top or bottom. It occurs when the projector is not perpendicular to the screen.

To correct this, besides adjusting the height of the projector, you will need to manually correct it following one of these steps.

- Press the ▽ keystone up or ▲ keystone down button on the remote control or remote control to display the status bar labelled Keystone, then press the ▽ keystone up

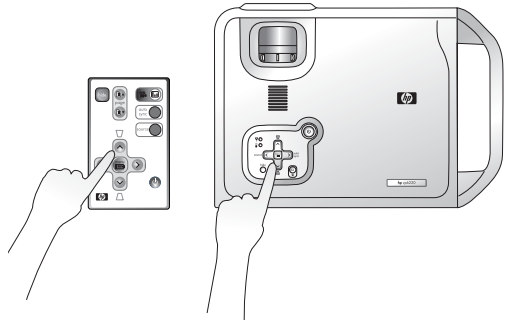

button to correct keystoning at the top of the image or press the ▲ keystone down button to correct keystoning at the bottom of the image.

- Press the **menu** button on the projector or remote control. Go to  **Picture > Keystone** and adjust the values by pressing the < left or > right button.

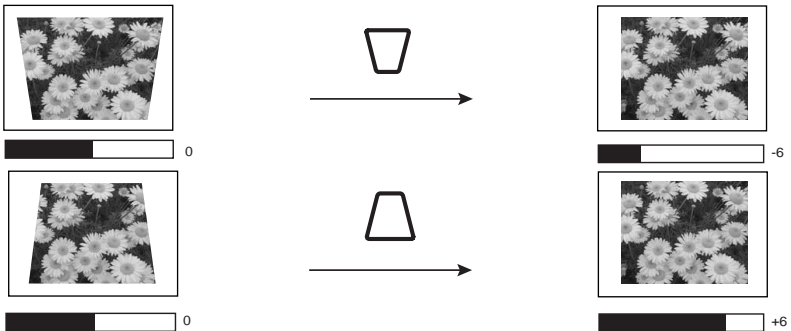

Auto Sync Adjustment

In some situations when showing a PC display, the picture may be cut off at the edges. To correct this, press **auto sync** on the the projector or remote control. Within 3 seconds, the projector will re-adjust the values of Frequency and Tracking to provide the best picture quality.

The current source information will be displayed at the bottom right of the screen for 3 seconds.

 The screen will be blank while auto sync is functioning.

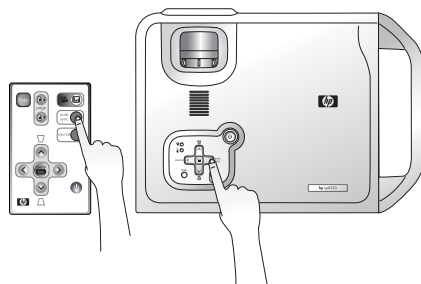

Hide the Picture

In order to draw the audience's full attention to the presenter, you can use **hide** to hide the screen image. Press **hide** again to restore the image. When this function is activated with an audio signal connected, the background sound still can be heard.

If the picture remains hidden for a long time, the projector automatically shuts down. To set the delay, press menu and go to Advanced Setup > Power timeout.

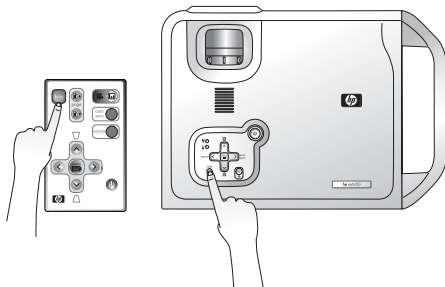

Zoom / Focusing

Adjust the projected image to your desired size using the zoom ring. Then focus the image by rotating the focus ring. Refer to the screen size tables on page 16.

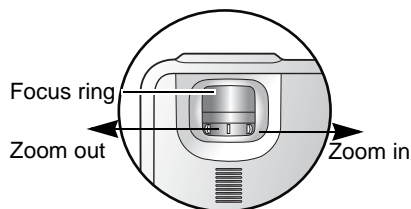

Picture Mode

Press the  **picture mode** button on the projector or remote control to select a operation mode that suits your need. There are several operation modes available for different types of signals.

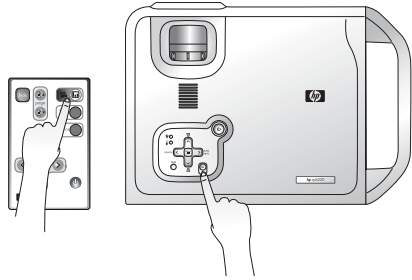

PC Signal Input			
Graphics	Vivid	Video	Economy
YPbPr / S-Video / Composite-Video Signal Input			
Gaming	Video	Cinema	Economy

Refer to page [26](#) for more information.

Slide Operation

You can operate your PowerPoint presentation moving forwards and backwards by pressing Page Up and Page Down on the remote control.

 You must connect the projector to your PC or notebook with a USB cable prior to using this function.



Menu Operation

Using the Menus

The projector is equipped with on-screen menus for making various adjustments and settings.

The following example describes the adjustment of the keystone setting.

1. Press **menu** on the projector or remote control to open the on-screen menu.

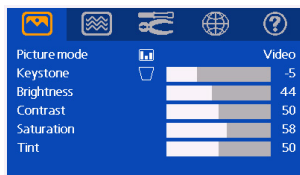

4. Adjust keystone values by pressing the **< left** or **> right** button on the projector or remote control.

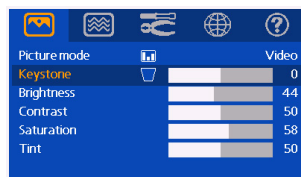



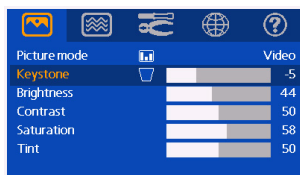



2. Press the **< left** or **> right** button on the projector or remote control to select the  **Picture** menu.
3. Press the **▲ up** or **▼ down** button on the projector or remote control to select **Keystone**.
5. Press the **menu** button on the projector or remote control to leave and save the setting.



1. Picture Menu

 Some picture adjustments are available only when certain input ports are in use. Unavailable adjustments are not shown on the screen.

FUNCTION	DESCRIPTION
<p>Picture mode</p>	<p>Picture mode is provided so you can optimize your projector image set-up to suit your program type.</p> <p>PC Signal Input</p> <ol style="list-style-type: none"> Graphics Mode: Is designed for presentations. The brightness is emphasized in this mode. Vivid Mode: Is perfect for playing games. The color saturation and brightness are well-balanced. Video Mode: Is suitable for cinematic enjoyment displaying images in their natural color. Economy Mode: Use this mode to reduce system noise and reduce power consumption by 20%. The lamp life is also extended with lower light output. <p>YPbPr/ S-Video/ Composite-Video Signal Input</p> <ol style="list-style-type: none"> Gaming Mode: Is suitable for playing video games in a bright living room. Video Mode: With a higher color temperature, it is suitable for enjoying TV movies. Cinema Mode: With a lower color temperature, it is suitable for enjoying cinematic movies. Economy Mode: Use this mode to reduce system noise and reduce power consumption by 20%. The lamp life is also extended with lower light output.
<p>Keystone</p>	<p>Corrects any keystone of the image. Refer to page 22 for more information.</p>
<p>Brightness</p>	<p>Adjusts the brightness of the image. The higher the value, the brighter the image. And lower the setting, darker the image. Adjust this control so the black areas of the image appear black but detail in the dark areas is visible.</p> <div style="display: flex; justify-content: space-around; align-items: flex-end;"> <div style="text-align: center;">  <p>▬ -30</p> </div> <div style="text-align: center;">  <p>▬ 50</p> </div> <div style="text-align: center;">  <p>▬ +70</p> </div> </div>
<p>Contrast</p>	<p>Adjusts the degree of difference between dark and light in the image. The higher the value, the greater the contrast.</p> <div style="display: flex; justify-content: space-around; align-items: flex-end;"> <div style="text-align: center;">  <p>▬ -30</p> </div> <div style="text-align: center;">  <p>▬ 50</p> </div> <div style="text-align: center;">  <p>▬ +70</p> </div> </div>



Saturation	Increases or decreases the color intensity of the image.
Tint	Adjusts the color tones of the image. The higher the value, the more reddish the image becomes. The lower the value, the more greenish the image becomes.

2. Advanced Picture Menu

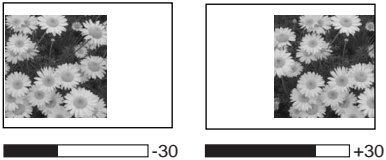
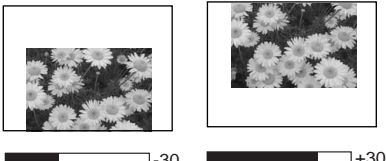
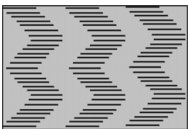



 Some picture adjustments are available only when certain input ports are in use. Unavailable adjustments are not shown on the screen.

FUNCTION	DESCRIPTION
Aspect ratio	Sets how the picture fits the screen. 1. Fill 2. Best fit
Widescreen input	Sets whether a widescreen (16:9) input device is in use. 1. No 2. Yes
Horizontal offset	Adjusts the horizontal position of the projected image. 
Vertical offset	Adjusts the vertical position of the projected image. 
Tracking	This function allows you to adjust the clock phase to reduce image distortion. 
Frequency	Adjusts the horizontal width of the image.
Sharpness	Adjusts the image to make it look sharper or softer.

3. Setup Menu

FUNCTION	DESCRIPTION
Mute	Turns sound on or off. Not muted Muted  
Volume	Adjusts the volume level. 
Timeout for menu	Sets the length of time the OSD will remain active after your last button press. The range is from 5 to 100 seconds.
Reset all settings	Returns all settings to the factory preset values.
Color temperature	Adjusts the appearance of white. 1. Cool: Makes images appear bluish white. 2. Neutral: Maintains normal colorings for white. 3. Warm: Makes images appear reddish white.

4. Advanced Setup Menu

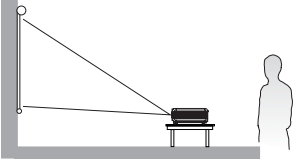
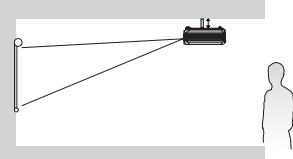
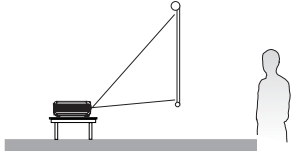
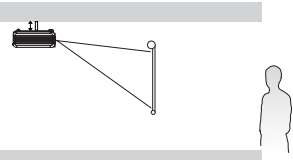
FUNCTION	DESCRIPTION
<p>Projector position</p>	<p>The projector can be installed on a ceiling or behind a screen, or with one or more mirrors.</p> <ul style="list-style-type: none"> <li data-bbox="356 296 692 443"> <p> Table front: Select this setting with the projector set on the floor and audience viewing the projected images from the front side of the screen. This is the most common setting.</p> <li data-bbox="356 480 692 627"> <p> Ceiling front: Select this setting with the projector suspended from the ceiling and audience viewing the projected images from the front side.</p> <li data-bbox="356 663 692 778"> <p> Table rear: Select this setting when the projector is placed near the floor and behind the screen. A special rear projection screen is required.</p> <li data-bbox="356 847 692 994"> <p> Ceiling rear: Select this setting when the projector is suspended from the ceiling and placed behind the screen. A special rear projection screen is required.</p> <div style="display: flex; justify-content: space-around; align-items: center;">     </div>
<p>Power timeout</p>	<p>Determines the length of time before the projector will automatically shut down when the picture is hidden.</p>
<p>Scan inputs</p>	<p>Sets whether the projector searches automatically for input signals. If scanning is on, the projector will scan for input signals in the following order: VGA/YPbPr --> Composite-video --> S-Video until it acquires a signal. If the function is not activated, the projector selects the last input signal.</p>
<p>Language</p>	<p>Sets the language for the on-screen menus.</p>
<p>Password</p>	<p>Sets whether a password is required to turn on the projector.</p>
<p>Change password</p>	<p>Sets or changes the current password.</p>

5. Information Menu

This menu shows you the current operating status of the projector.

6. Maintenance

Care of the Projector

Your projector needs little maintenance. Keep it clean for best performance.

Never remove any parts of the projector except the lamp. Contact your dealer if other parts need replacing.

Cleaning the Lens

Clean the lens whenever you notice dirt or dust on the surface.

- Use a canister of compressed air to remove dust.
- If there is dirt or smears, use lens-cleaning paper or moisten a soft cloth with lens cleaner to gently wipe the lens surface.

 **Never rub the lens with abrasive materials.**

Cleaning the Projector Case

Before you clean the case, turn the projector off and unplug the power cord.

- To remove dirt or dust, wipe the case with a soft, dry, lint-free cloth.
- To remove stubborn dirt or stains, moisten a soft cloth with water and a neutral detergent. Then wipe the case.

 **Never use wax, alcohol, benzene, thinner or other chemical detergents. These can damage the case.**

Storing the Projector

If you need to store the projector for an extended time, please follow the instructions below.

- Make sure the temperature and humidity of the storage area are within the recommended range for the projector. Please refer to page [36](#) in the manual.
- Retract the adjuster feet.
- Remove the batteries from the remote control.
- Pack the projector in its original packing or equivalent.

Transporting the projector

It is recommended that you ship the projector with its original packing or equivalent.

Lamp Information

Warning Messages

When the **Lamp indicator** lights up red or a message appears suggesting it is time to replace the lamp, please install a new lamp or consult your dealer. An old lamp may cause a malfunction in the projector and in some instances the lamp may break.

For more detailed information on the lamp indicator, please refer to page 34.

 **The Lamp indicator light and Temperature warning light will light up if the lamp becomes too hot. Turn the power off and let the projector cool for 45 minutes. If the Lamp or Temp indicator still lights up after turning the power back on, please contact your dealer.**

The following Lamp warning messages will remind you to change the lamp.

Message	Status
Lamp is getting old. Buy a spare lamp.	The lamp has been in operation for a long time, and you should have a spare lamp available. For optimal performance, install a new lamp.
End of lamp life Install a new lamp. Then hold [▲] to reset lamp hours.	The lamp has reached the end of its life, and the projector will not operate normally until you change the lamp.

Replacing the Lamp

 **To reduce the risk of electrical shock, always turn the projector off and disconnect the power cord before changing the lamp.**

To reduce the risk of severe burns, allow the projector to cool for at least 45 minutes before replacing the lamp.

To reduce the risk of injuries to fingers and damage to internal components, use caution when removing lamp glass that has shattered into sharp pieces.

To reduce the risk of injuries to fingers and/or compromising image quality by touching the lens, do not touch the empty lamp compartment when the lamp is removed.

The lamp contains a small amount of mercury. If the lamp breaks, adequately ventilate the area where the breakage occurred. Disposal of this lamp might be regulated due to environmental considerations. For disposal or recycling information, contact your local authorities or the Electronic Industries Alliance (<http://www.eiae.org>).

1. Turn off the projector.
2. After the power button stops flashing, unplug the power cord from the wall socket.
3. Turn the projector over. Then loosen the screws and remove the lamp cover. If the lamp is hot, avoid burns by waiting for 45 minutes until the lamp has cooled.

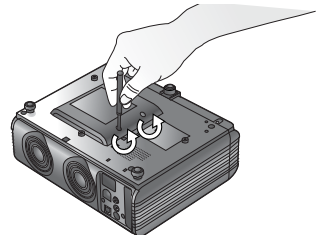

- Loosen the screw that holds the lamp to the projector. If the screw is not loosened completely, they could injure your fingers. It is strongly recommended that you use a magnetic-head screwdriver.

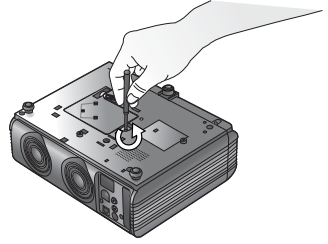

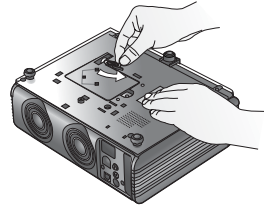

- Slide the latch to release the lamp.



- Lift the handle so that it stands up. Use the handle to slowly pull the lamp out of the projector.

 Pulling it too quickly may cause the lamp to break and scatter broken glass in the projector.

 Do not place the lamp in locations where water might splash on it, children can reach it, or near flammable materials.

 Do not insert your hands into the projector after the lamp is removed. If you touch the optical components inside, it could cause color unevenness and distortion of the projected images.

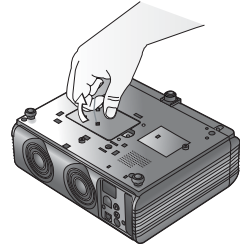

- Insert a new lamp. Make sure the handle is fully locked and tighten the screw firmly. Slide the latch so it holds the lamp.

 If the screw is loose, it could result in a malfunction.

 Do not over tighten the screw.

- Re-install the lamp cover and tighten the screw. **Do not turn the power on with the lamp cover removed.**
- Plug in the projector and turn it on.
- Unplug all input cables.
- Reset the lamp counter. Do not reset if the lamp is not replaced as this could cause damage.**
 - Press and hold the **▲ up** button on the projector for 5 seconds to display the reset message.
 - Press **auto sync** on the projector or on the remote control to reset the lamp hours to "0".
 - Wait about 5 seconds to let the message disappear.

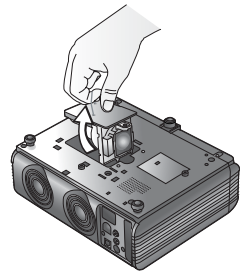

Indicators

Power indicator

- Off** The projector is off.
- Flashing** The projector is warming up or cooling down.
- On** The projector is on and operating normally.

Lamp indicator

- Off** The projector is operating normally.
- On** The lamp is bad or has reached the end of its life.

Temperature indicator

- Off** The projector is operating normally.
- Flashing** The fans are not working, and the projector will shut down. Contact HP about repairs.
- On** The internal temperature is too high, and the projector will shut down. Allow the projector to cool down. If this continues, contact HP about repairs.

Updating the firmware

HP may periodically release updated versions of the projector firmware to enhance the projector performance. The projector firmware version is shown in the on-screen menu in the Information menu. Check for updated versions at http://www.hp.com/go/proj_firmware.

1. On a computer with a USB port, go to the HP projector upgrade website (see introduction for this section) and download the latest file intended for a USB upgrade.
2. Connect the USB cable between the USB port on the projector and the USB port on the computer.
3. On the computer, run the file you downloaded by double-clicking the file. Follow the on-screen instructions.

7. Troubleshooting

⑦ The projector does not turn on.

Cause	Remedy
There is no power from the power cord.	Plug the power cord into the AC inlet on the projector, and plug the power cord into the power outlet. If the power outlet has a switch, make sure that it is switched on.
Attempting to turn the projector on again during the cooling process.	Wait until the cooling down process has completed.

⑦ No picture

Cause	Remedy
The video source is not turned on.	Turn the video source on.
The projector is not correctly connected to the input source device.	Check that the signal cable is connected correctly.
The input signal has not been correctly selected.	Select the correct input signal with the source button on the projector or remote control.
The lens cap is still attached to the lens.	Remove the lens cap.

⑦ Blurred image

Cause	Remedy
The projection lens is not correctly focused.	Adjust the focus of the lens using the focus ring.
The projector and the screen are not aligned properly.	Adjust the projection angle and direction as well as the height of the unit if necessary.
The lens cap is still attached to the lens	Remove the lens cap.

⑦ Remote control does not work.

Cause	Remedy
The battery is out of power.	Replace the battery in the remote control with a new one.
There is an obstacle between the remote control and the projector.	Remove the obstacle.
You are too far away from the projector.	Stand within 6 meters (19.5 feet) of the projector.
For a PC connection, the USB cable is not connected.	To use the page up and page down functions, connect the USB cable between the PC and projector.

8. Specifications

Projector Specifications

 All specifications are subject to change without notice.

General

Product name	Digital Projector
Model name	vp6220 (XGA) vp6210 (SVGA)

Optical

Display system	1-CHIP DMD
Lens F/Number	vp6220 F=2.4 to 2.6, f= 24.0 to 29.1 mm vp6210 F=2.4 to 2.6, f= 18.6 to 22.7 mm
Lamp	200W lamp

Electrical

Power supply	AC100 ~ 240V, 3.5A, 50/60 Hz (Automatic)
Power consumption	265W (Max)

Mechanical

Dimensions	311 mm (W) x 90 mm (H) x 215 mm (D)
Weight	2.8 Kg (6.1 lbs)

Input terminal

Computer input	
VGA input	D-sub 15-pin (female)
Video signal input	
S-video	Mini DIN 4-pin port x1
Composite-video	RCA jack x1
HDTV signal input	D-sub to YPbPr RCA jack x3, through VGA input
Audio signal input	
Audio in	Mini jack stereo port

Output

USB mouse connector	A/B series x1
Speaker	1 watt x 1

Environment

Operating	
Temperature	10 to 35 °C (50 to 95 °F)
Humidity	80% RH max, non-condensing
Altitude	up to 3,000 m (10,000 ft), up to 25 °C (77 °F)
Storage	
Temperature	-25 to 55 °C (-4 to 131 °F)
Humidity	80% RH max, non-condensing
Altitude	up to 12,000 m (40,000 ft)

Timing Chart

Supported Timing for PC Input

Resolution	Horizontal Frequency (kHz)	Vertical Frequency (Hz)	Pixel Frequency (MHz)	Mode
720x400	37.927	85.039	35.500	720x400_85
640x480	31.469	59.940	25.175	VGA_60
	37.861	72.809	31.500	VGA_72
	37.500	75.000	31.500	VGA_75
	43.269	85.008	36.000	VGA_85
800x600	37.879	60.317	40.000	SVGA_60
	48.077	72.188	50.000	SVGA_72
	46.875	75.000	49.500	SVGA_75
	53.674	85.061	56.250	SVGA_85
1024x768	48.363	60.004	65.000	XGA_60
	56.476	70.069	75.000	XGA_70
	60.023	75.029	78.750	XGA_75
	68.667	84.997	94.500	XGA_85
1280x1024	63.981	60.020	108.000	SXGA3_60

Supported Timing for Component-YPbPr Input

Signal Format	Horizontal Frequency (kHz)	Vertical Frequency (Hz)
480i(525i)@60Hz	15.73	59.94
480p(525p)@60Hz	31.47	59.94
576i(625i)@50Hz	15.63	50.00
576p(625p)@50Hz	31.25	50.00
720p(750p)@60Hz	45.00	60.00
720p(750p)@50Hz	37.50	50.00
1080i(1125i)@60Hz	33.75	60.00
1080i(1125i)@50Hz	28.13	50.00

Supported Timing for Composite-Video and S-Video Inputs

Video mode	Horizontal Frequency (kHz)	Vertical Frequency (Hz)	Color sub-carrier Frequency (MHz)
NTSC	15.73	60	3.58
PAL	15.63	50	4.43
SECAM	15.63	50	4.25 or 4.41
PAL-M	15.73	60	3.58
PAL-N	15.63	50	3.58
PAL-60	15.73	60	4.43
NTSC4.43	15.73	60	4.43

9. Dimensions

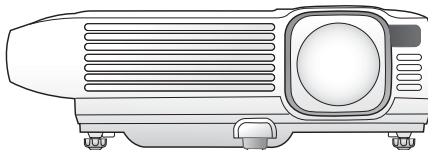
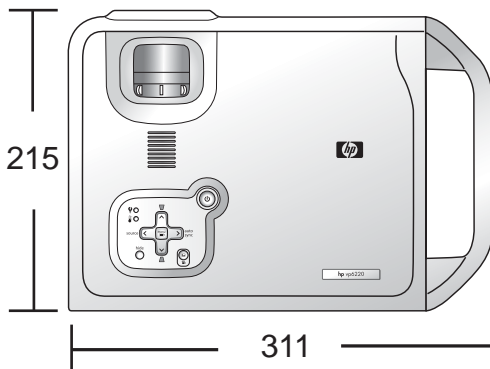
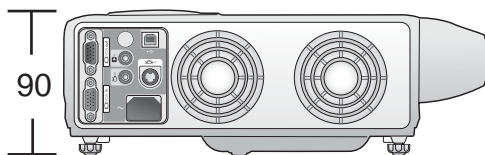

Unit: mm

10. Regulation Statements

Safety information

Safety Precautions

- Prevent eye injury. Do not look into the projector's lens when the lamp is on. Do not point any laser light at anyone's eyes.
- Prevent electrical shock. Do not expose the projector or rain or moisture. Do not open the projector except as instructed by the manual.
- Allow the projector to cool before removing the lamp cover and touching internal components, as instructed by the manual.
- Keep paper, plastic, and combustible material at least 0.5 meter (2 feet) away from the projector lens and exhaust vents.
- Use only an approved power cord rated for the voltage and current marked on the product label. Do not overload any outlet or extension cord.

Mercury Safety

 Warning: This digital projector lamp contains a small amount of mercury. If the lamp breaks, adequately ventilate the area where the breakage occurred. Disposal of this lamp may be regulated due to environmental considerations. For disposal or recycling information, please contact your local authorities or the Electronic Industries Alliance (www.eiae.org).

Regulatory information

This section presents information that shows how your digital projector complies with regulations in certain regions. Any modifications to your digital projector not expressly approved by Hewlett-Packard could void the authority to operate the digital projector in these regions.

U.S.A.

This digital projector has been tested and found to comply with the limits for a Class B digital device, pursuant to Part 15 of the FCC Rules. These limits are designed to provide reasonable protection against harmful interference in a residential installation.

This digital projector generates, uses, and can radiate radio frequency energy. If not installed and used in accordance with the instructions, it may cause harmful interference to radio communications. However, there is no guarantee that interference will not occur in a particular installation. If this digital projector does cause harmful interference to radio or television reception (which can be determined by unplugging the unit), try the following:

- Reorienting or relocating the receiving antenna.
- Relocating the digital projector with respect to the receiver.
- Connecting the digital projector's power cord to another power outlet.

Connections to Peripheral Devices. To maintain compliance with FCC Rules and Regulations, use properly shielded cables with this device.

For more information, consult your dealer, an experienced radio/television technician, or the following booklet, prepared by the Federal Communications Commission: How to Identify and Resolve Radio-TV Interference Problems. This booklet is available from the U.S. Government Printing Office, Washington, DC 20402, Stock Number 004-000-00345-4. At the first printing of this manual, the telephone number was (202) 512-1800.

Canada

This Class B digital apparatus complies with Canadian ICES-003.

Japan

この装置は、情報処理装置等電波障害自主規制協議会（VCCI）の基準に基づくクラスB情報技術装置です。この装置は、家庭環境で使用することを目的としていますが、この装置がラジオやテレビジョン受信機に近接して使用されると受信障害を引き起こすことがあります。
取り扱い説明書に従って正しい取り扱いをして下さい。

製品には、同梱された電源コードをお使い下さい。
同梱された電源コードは、他の製品では使用出来ません。

Korea

사용자 안내문 : B 급 기기

이 기기는 비업무용으로 전자파적합등록을 받은 기기이오니, 주거지역에서는 물론, 모든 지역에서 사용 하실 수 있습니다.

International

NOTE: For regulatory identification purposes, your product is assigned a Regulatory Model number. The Regulatory Model number for your product is listed in the declaration below. This regulatory model is different from the marketing name and product number.

DECLARATION OF CONFORMITY

According to ISO/IEC Guide 22 and EN 45014

Manufacturer's Name: Hewlett Packard Company
Manufacturer's Address: Hewlett Packard Company
Digital Projection & Imaging
1000 NE Circle Blvd.
Corvallis, OR 97330-4239

Declares, that the product(s):
Product Name: Digital Projector
Model Number(s): vp6210, vp6220
Regulatory Model: CRVSB-04CI

Conforms to the following product specifications:

Safety: IEC 60950:1999 / EN 60950:2000
GB4943-1995
EMC: EN 55022: 1998 +A1, +A2 Class B [1]
CISPR 24:1997 / EN 55024: 1998 +A1, +A2
EN 61000-3-2:2000
EN 61000-3-3:A1:2001
GB9254-1998
FCC Title 47 CFR, Part 15 Class B/ANSI C63.4:1992
AS/NZS 3548:1995 Rules and Regulations of Class B

Supplementary information:

The product herewith complies with the requirements of following Directives and carries the CE marking accordingly:

-Low Voltage Directive: 73/23/EEC

-EMC Directive: 89/336/EEC

[1] The product was tested in a typical configuration with Hewlett Packard Personal Computer peripherals.

This device complies with Part 15 of the FCC Rules. Operation is subject to the following two conditions: (1) this device may not cause harmful interference, and (2) this device must accept any interference received, including interference that may cause undesired operation.

Corvallis, Oregon, October 1, 2004



A handwritten signature in black ink, appearing to read 'Steve Brown'.

Steve Brown, General Manager

European Contact for regulatory topics only: Hewlett Packard GmbH, HQ-TRE, Herrenberger Strasse 140, 71034 Boeblingen, Germany. (FAX:+49-7031-143143).

USA Contact: Hewlett Packard Co., Corporate Product Regulations Manager, 3000 Hanover Street, Palo Alto, CA 94304. Phone: (650) 857-1501.