

myprojectorlamps.com

**The most trusted, dependable name
in projector lamp sales.**



<http://www.myprojectorlamps.com>



<http://www.myprojectorlamps.ca>



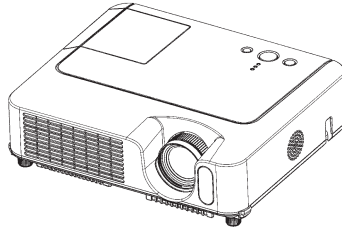
<http://www.myprojectorlamps.eu>

The following projector manual has not been modified or altered in any way.

Projector

ED-X10/ED-X12

User's Manual – Operating Guide



Thank you for purchasing this projector.

⚠ WARNING ▶ Before using this product, please read the "User's Manual - Safety Guide" and related manuals to ensure the proper use of this product. After reading them, store them in a safe place for future reference.

About this manual

Various symbols are used in this manual. The meanings of these symbols are described below.

⚠ WARNING This symbol indicates information that, if ignored, could possibly result in personal injury or even death due to incorrect handling.

⚠ CAUTION This symbol indicates information that, if ignored, could possibly result in personal injury or physical damage due to incorrect handling.

 Please refer to the pages written following this symbol.

NOTE • The information in this manual is subject to change without notice.



- The manufacturer assumes no responsibility for any errors that may appear in this manual.
- The reproduction, transfer or copy of all or any part of this document is not permitted without express written consent.

Trademark acknowledgment

- VGA and XGA are registered trademarks of International Business Machines Corporation.
- Apple and Mac are registered trademarks of Apple Computer, Inc.
- VESA and SVGA are trademarks of Video Electronics Standard Association.
- Windows is a registered trademark of Microsoft Corporation.

All other trademarks are the properties of their respective owners.

Content

About this manual	1		EASY Menu	25	
Content	2		Aspect, Auto keystone Execute,		
Projector features	3		Keystone, Picture mode, Brightness,		
Preparations	3		Contrast, Color, Tint, Sharpness,		
About contents of package	3		Whisper, Mirror, Reset, Filter time,		
Fastening the lens cover	3		Language, Go to advanced menu		
Part names	4		PICTURE Menu	27	
Projector	4		Brightness, Contrast, Gamma,		
Control buttons	6		Color temp, Color, Tint, Sharpness,		
Remote control	6		My memory		
Setting up	7		IMAGE Menu	30	
Arrangement	8		Aspect, Over scan, V. position, H. position,		
Adjusting the projector's elevator	9		H. phase, H. size, Auto adjust execute		
Using the Security Bar	10		INPUT Menu	32	
Connecting your devices	11		Progressive, Video NR, Color space,		
Connecting power supply	14		Component, Video format, Frame lock,		
Remote control	15		RGB in, Resolution		
Putting batteries	15		SETUP Menu	35	
Using the remote control	16		Auto keystone Execute, Keystone,		
Power on/off	17		Whisper, Mirror, Volume, Audio		
Turning on the power	17		SCREEN Menu	37	
Turning off the power	17		Language, Menu position, Blank,		
Operating	18		Start up, MyScreen, MyScreen lock,		
Adjusting the volume	18		Message, Source name		
Temporarily muting the sound	18		OPTION Menu	40	
Selecting an input signal	18		Auto search, Auto keystone, Auto on,		
Searching an input signal	19		Auto off, Lamp time, Filter time,		
Selecting an aspect ratio	19		My button, Service, Security		
Adjusting the zoom and focus	19		Maintenance	50	
Using the automatic adjustment feature	20		Lamp	50	
Adjusting the position	20		Air filter	52	
Correcting the keystone distortions	21		Other care	54	
Using the magnify feature	21		Troubleshooting	55	
Freezing the screen	22		Related messages	55	
Temporarily blanking the screen	22		Regarding the indicator lamps	56	
Operating the computer screen	23		Phenomena that may be easy to be		
Multifunctional settings	24		mistaken for machine defects	58	
Using the menu function	24		Warranty and after-service	61	
			Specifications	61	

Projector features

This projector is used to project various computer signals as well as NTSC/PAL/SECAM, Component (SD, HD) video signals onto a screen. It requires just a little space for installation and gets a large image from short distance.

- High Brightness
Newly developed 200W UHB (Ultra High Brightness) lamp gives you a higher brightness image on a screen. The image can be still kept as bright and clean enough for use in bright rooms.
- Low Noise
WHISPER function is available for reducing acoustic noise to realize quieter operation. It is perfect for use in low luminance rooms where low noise is more important than brightness.
- Rich Connectivity
This projector has a variety of I/O ports. It can be easily connected to many signal sources like PC, DVD and so on. The rich connectivity provides you more options to make your presentation impressive.
- Compact Body
Even with its many features, this projector is extremely compact and slim, which gives you more flexibility and usability to use it where you want.

Preparations

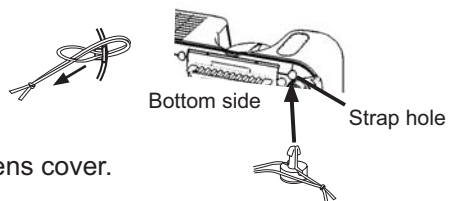
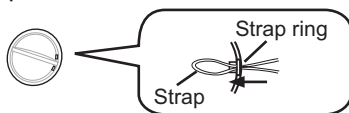
About contents of package

Please see the "Contents of package" of the "User's Manual - Quick Guide". Your projector should come with the items shown there. Contact immediately your dealer if anything is missing.

NOTE • Keep the original packing materials for future reshipment. For moving the projector, be sure to use the original packing materials. Use special caution for the lens part.

Fastening the lens cover

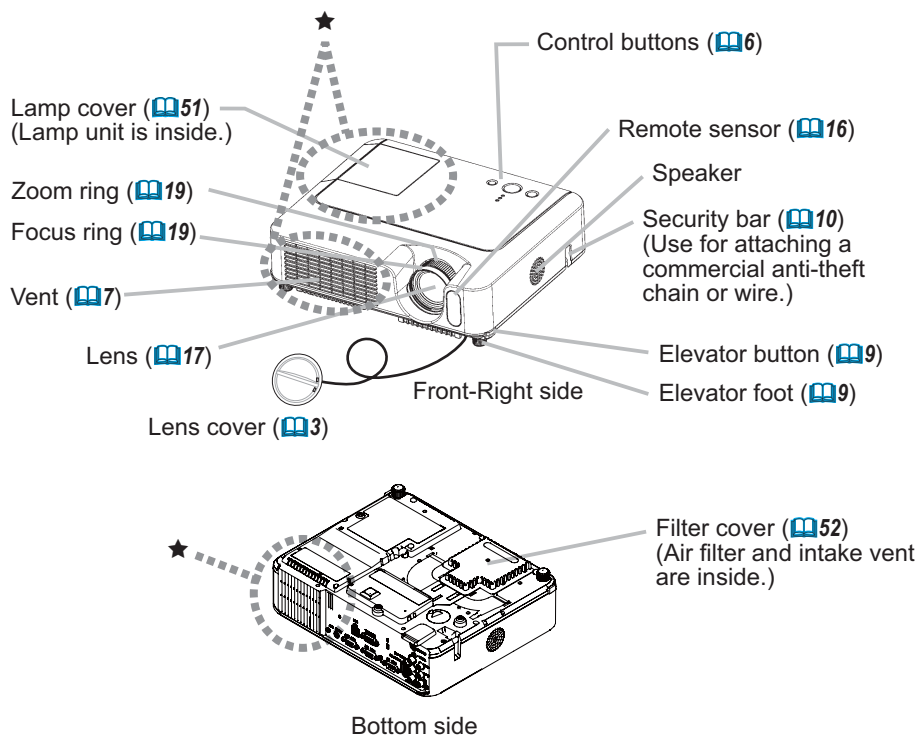
To avoid losing the lens cover, please fasten it the lens cap to the projector using the strap.



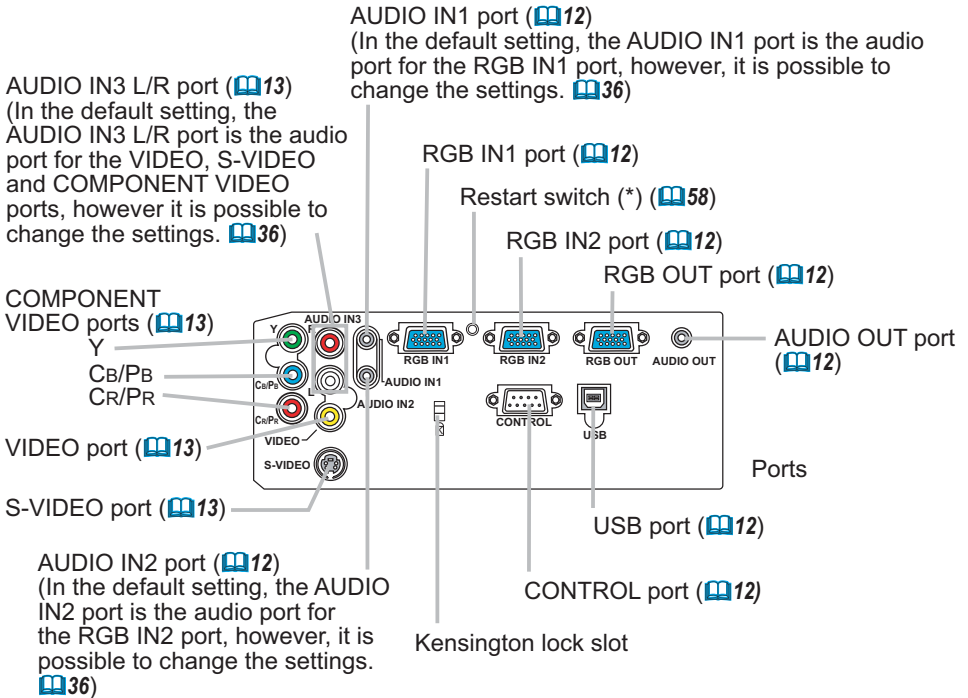
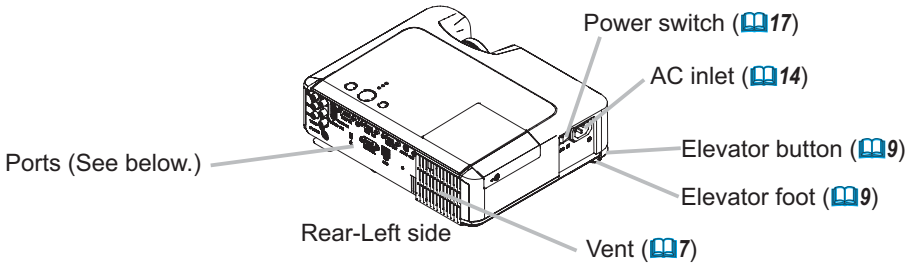
1. Fix the strap to the strap ring of the lens cover.
2. Put the strap into the groove on the rivet.
3. Push the rivet into the strap hole.

Part names

Projector

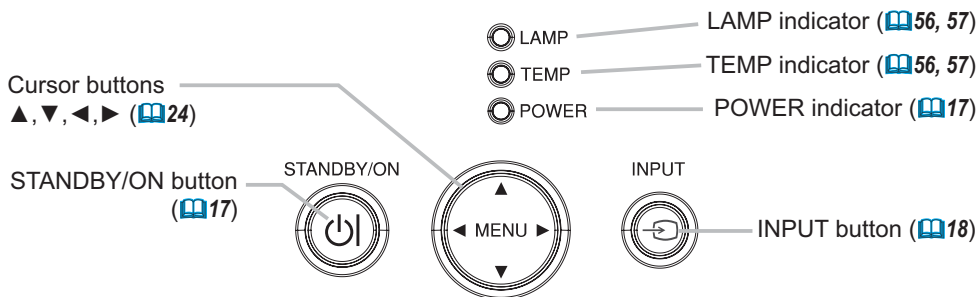


⚠ WARNING ▶ During use or immediately after use, do not touch around the lamp and vents of the projector. (★) It could cause a burn.

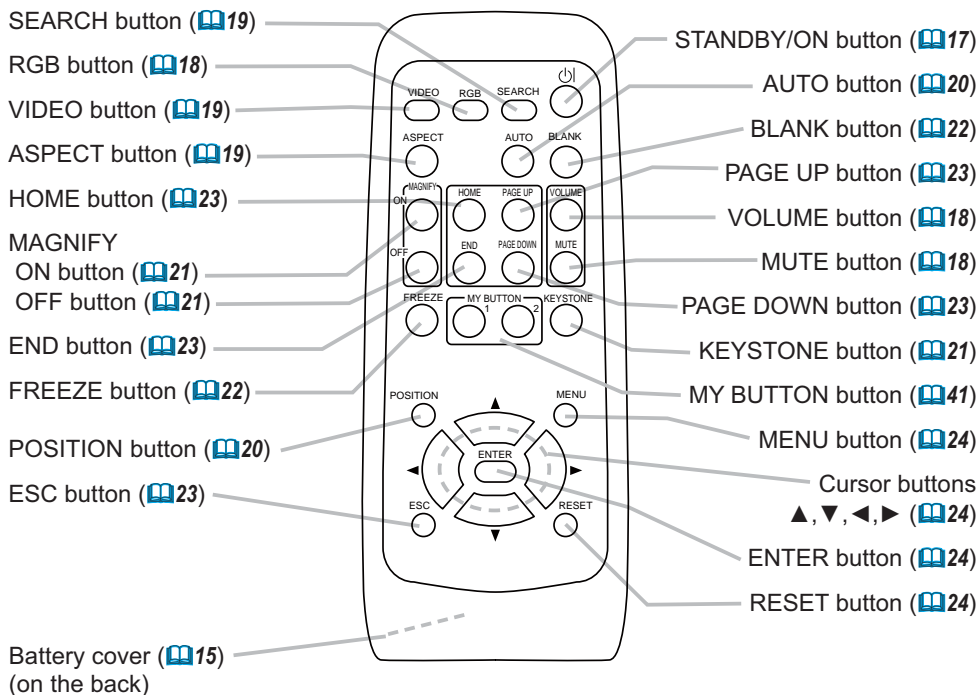


NOTE (*) About Restart switch: This projector is controlled by an internal microprocessor. Under certain exceptional circumstances, the projector may not operate correctly and the microprocessor will need to be reset. In such a case, please push the Restart switch by using a cocktail stick or similar, and before turning on again, make the projector cool down at least 10 minutes without operating. Only push the Restart switch in these exceptional instances.

Control buttons



Remote control



Setting up

⚠ WARNING ► Place the projector in a stable position horizontally. A fall or a turnover could cause an injury and/or damage to the projector. Then using damaged projector could result in a fire and/or an electric shock.

- Do not place the projector on an unstable, slant or vibrant surface such as a wobbly or inclined stand.
- Do not place the projector in the side/front/rear-up position, except cleaning the air filter.

► Place the projector in a cool place, and pay attention enough to ventilation. The high temperature of the projector could cause a fire, a burn and/or malfunction to the projector.

- Do not stop up, block and cover the projector's vents.
- Keep a space of 30 cm or more between the sides and other objects such as walls.
- Do not place the projector on a metallic thing or anything weak in heat.
- Do not place the projector on a carpet, cushion or bedding.
- Do not place the projector in direct sunlight or near a hot object such as a heater.
- Put nothing about lens and vents of the projector. Put nothing on the projector.
- Put nothing that is sucked or sticks to the bottom of projector. This projector has some intake vents also on the bottom.

► Do not place the projector on the place that gets wet. Damping the projector or inserting liquid in the projector could cause a fire, an electric shock and/or malfunction to the projector.

- Do not place the projector in a bathroom or the outdoors.
- Put nothing containing the liquid near the projector.

⚠ CAUTION ► Avoid a smoky, humid or dusty place. Placing the projector in such place could cause a fire, an electric shock and/or malfunction to the projector.

- Do not place the projector near a humidifier, a smoking space or a kitchen.

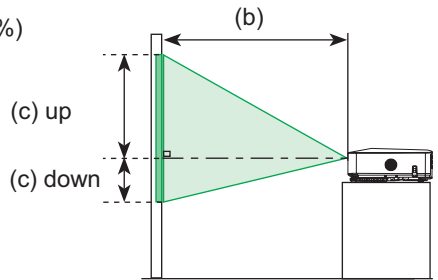
► Adjust the direction of the projector to keep the light from directly hitting the projector's remote sensor.

Arrangement

Refer to the illustrations and tables below to determine the screen size and projection distance.

The values shown in the table are calculated for a full size screen: 1024×768

- (a) The screen size (diagonal)
- (b) Distance from the projector to the screen ($\pm 10\%$)
- (c) The height of the screen ($\pm 10\%$)



(a) Screen size [inch (m)]	4 : 3 screen				16 : 9 screen			
	(b) Projection distance [m (inch)]		(c) Screen height [cm (inch)]		(b) Projection distance [m (inch)]		(c) Screen height [cm (inch)]	
	min.	max.	down	up	min.	max.	down	up
30 (0.8)	0.9 (34)	1.1 (41)	5 (2)	41 (16)	1.0 (38)	1.1 (45)	-1 (0)	39 (15)
40 (1.0)	1.2 (46)	1.4 (56)	6 (2)	55 (22)	1.3 (50)	1.5 (61)	-2 (-1)	51 (20)
50 (1.3)	1.5 (58)	1.8 (70)	8 (3)	69 (27)	1.6 (63)	1.9 (76)	-2 (-1)	64 (25)
60 (1.5)	1.8 (70)	2.1 (84)	9 (4)	82 (32)	1.9 (76)	2.3 (91)	-2 (-1)	77 (30)
70 (1.8)	2.1 (81)	2.5 (98)	11 (4)	96 (38)	2.3 (89)	2.7 (107)	-3 (-1)	90 (35)
80 (2.0)	2.4 (93)	2.8 (112)	12 (5)	110 (43)	2.6 (102)	3.1 (122)	-3 (-1)	103 (41)
90 (2.3)	2.7 (105)	3.2 (126)	14 (5)	123 (49)	2.9 (115)	3.5 (138)	-4 (-1)	116 (46)
100 (2.5)	3.0 (117)	3.6 (140)	15 (6)	137 (54)	3.2 (127)	3.9 (153)	-4 (-2)	129 (51)
120 (3.0)	3.6 (140)	4.3 (169)	18 (7)	165 (65)	3.9 (153)	4.7 (184)	-5 (-2)	154 (61)
150 (3.8)	4.5 (176)	5.4 (211)	23 (9)	206 (81)	4.9 (192)	5.8 (230)	-6 (-2)	193 (76)
200 (5.1)	6.0 (235)	7.2 (282)	30 (12)	274 (108)	6.5 (256)	7.8 (307)	-8 (-3)	257 (101)
250 (6.4)	7.5 (294)	9.0 (353)	38 (15)	343 (135)	8.1 (320)	9.8 (384)	-10 (-4)	322 (127)
300 (7.6)	9.0 (352)	10.8 (423)	46 (18)	411 (162)	9.8 (384)	11.7 (461)	-12 (-5)	386 (152)

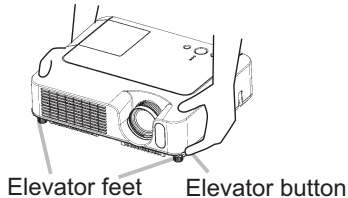
Adjusting the projector's elevator

⚠ CAUTION ▶ If you press the elevator button without holding the projector, the projector might crash down, overturn, smash your fingers and possibly result in malfunction. To prevent damaging the projector and injuring yourself, always hold the projector whenever using the elevator buttons to adjust the elevator feet.

▶ Do not incline the projector rightward or leftward. Also do not incline it backward or forward exceeding 30 degrees. Exceeding these range could cause malfunction, and could shorten the lifetime of the consumables.

▶ Except for inclining by the elevator feet adjustment, place the projector horizontally.

You can use the elevator feet to make adjustments if the surface on which you need to set the projector is uneven or if you otherwise need to adjust the angle of projection. The adjustment range of the elevator feet is 0 to 9 degrees.



1. After making sure that the projector is cool adequately, press and hold in the elevator buttons while holding the projector.
The elevator buttons and the elevator feet are on the both sides.
2. Raise or lower the projector to the desired height and release the elevator buttons.
When you release the elevator buttons, the elevator feet will lock into position.
3. If necessary, you can also finely adjust the height of the projector by twisting the elevator feet by hand.

Using the Security Bar

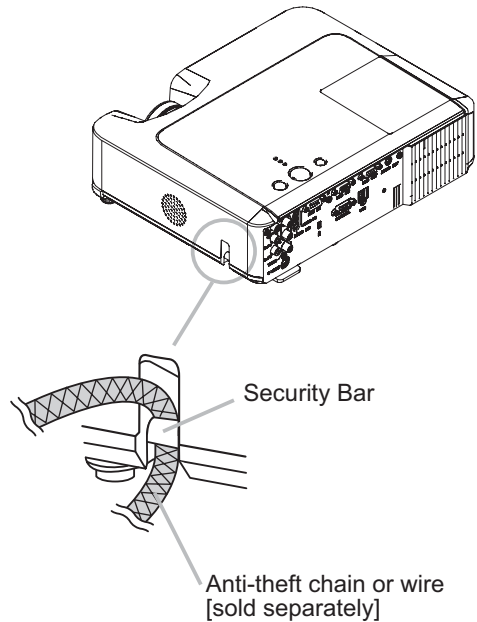
⚠ WARNING ► Do not use the security bar to prevent the projector from falling. Dropping or knocking over the projector may cause damage or injury.

⚠ CAUTION ► The security bar is not a comprehensive theft prevention measure. It is intended to be used as an extra theft prevention measure.

A commercial anti-theft chain or wire can be attached to the security bar on the projector.

1. How to attach

An anti-theft chain or wire can be attached as shown in the illustration. (Anti-theft chains or wires of up to 10mm in diameter can be used)



Connecting your devices

⚠ CAUTION ▶ Turn off all devices prior to connecting them to the projector. Attempting to connect a live device to the projector may generate extremely loud noises or other abnormalities that may result in malfunction and/or damage to the device and/or projector.

▶ Use the accessory cable or a designated-type cable for the connection. Some cables have to be used with core set. A too long cable may cause a certain picture degradation. Please consult with your dealer for details. For cables that have a core only at one end, connect the core to the projector.

▶ Make sure that you connect devices to the correct port. Incorrect connection may result in malfunction and/or damage to the device and/or projector.

NOTE • Whenever attempting to connect a laptop computer to the projector, be sure to activate the laptop's RGB external image output (set the laptop to CRT display or to simultaneous LCD and CRT display). For details on how this is done, please refer to the instruction manual of the corresponding laptop computer.

- Secure the screws on the connectors and tighten.
- Some computers may have multiple display screen modes. Use of some of these modes will not be possible with this projector.
- For some RGB signal modes, the optional Mac adapter is necessary.
- When the image resolution is changed on a computer, depending on an input, automatic adjustment function may take some time and may not be completed. In this case, you may not be able to see a check box to select "Yes/No" for the new resolution on Windows. Then the resolution will go back to the original. It might be recommended to use other CRT or LCD monitors to change the resolution.

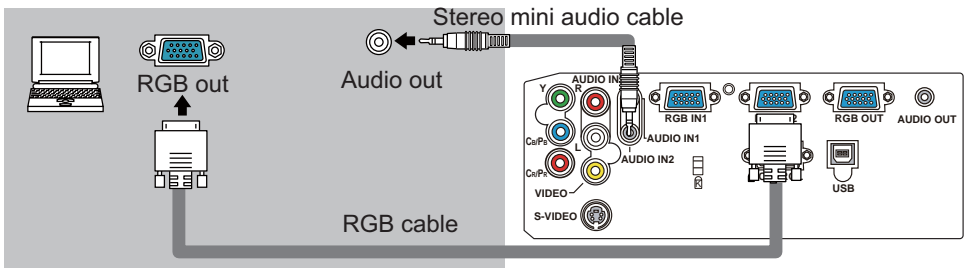
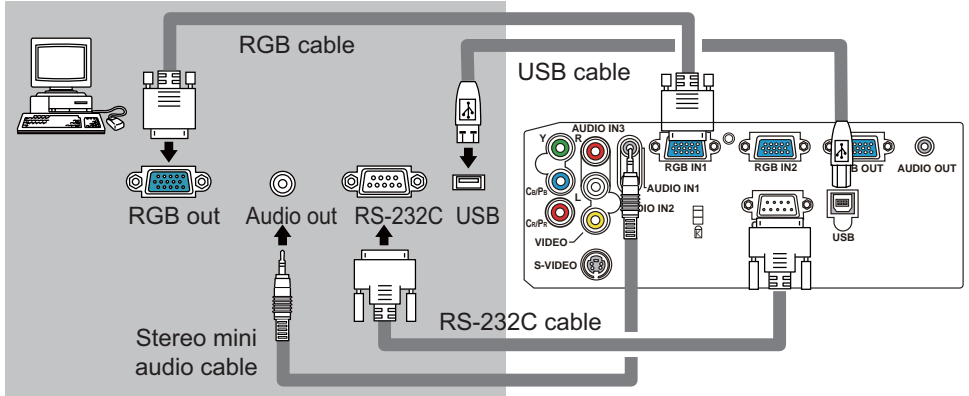
About Plug-and-Play capability

Plug-and-Play is a system composed of the computer, its operating system and peripheral equipment (i.e. display devices). This projector is compatible with VESA DDC 2B. Plug-and-Play can be achieved by connecting this projector to a computer is VESA DDC (display data channel) compatible.

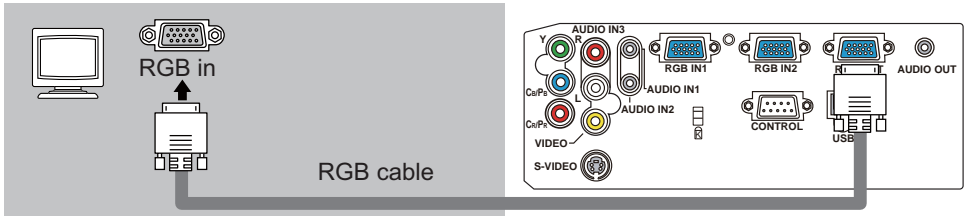
- Please take advantage of this function by connecting the accessory RGB cable to the RGB IN1 port (DDC 2B compatible). Plug-and-Play may not work properly if any other type of connection is attempted.
- Please use the standard drivers in your computer as this projector is a Plug-and-Play monitor.

Examples of connection with a computer

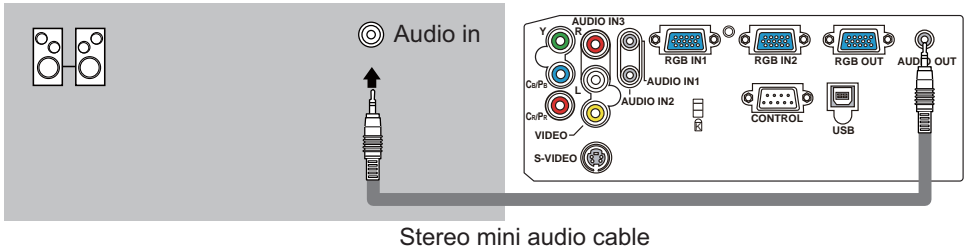
* In the default setting, the AUDIO IN1 port is the audio port for the RGB IN1, and the AUDIO IN2 port is the audio port for the RGB IN2 ports. To change the settings, refer to the AUDIO item in the SETUP menu. (p.36)



Connecting to a monitor (output)

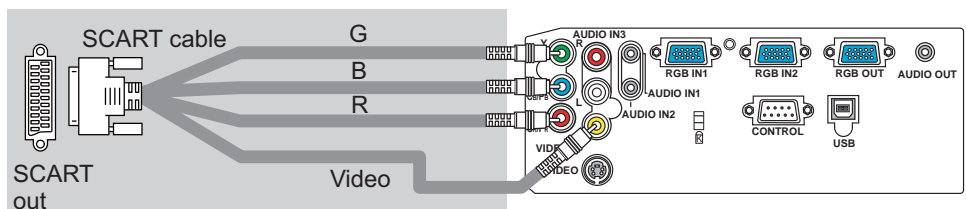
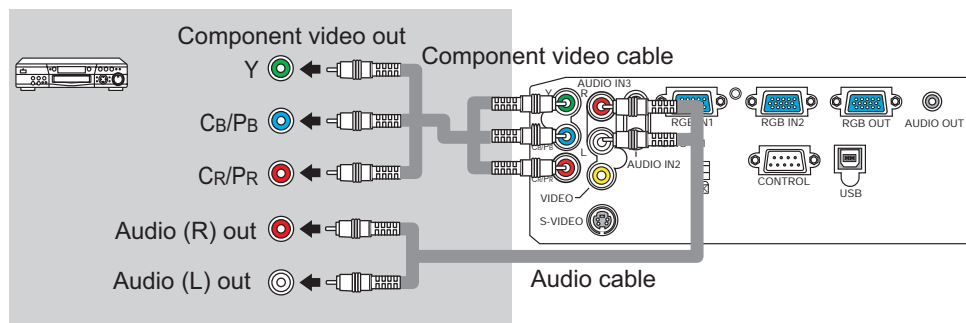
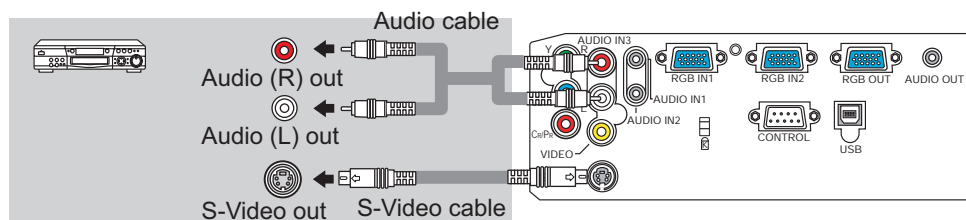
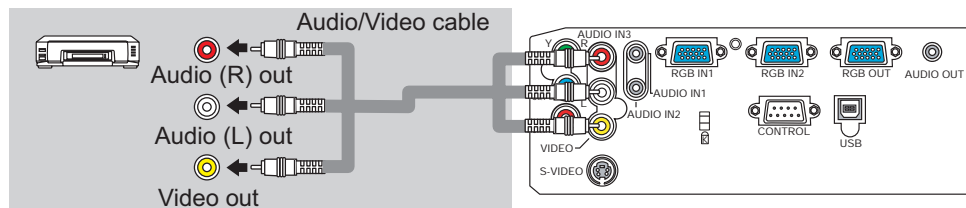


Connecting to a speaker with amplifier (output)



Examples of connection with a VCR/DVD player

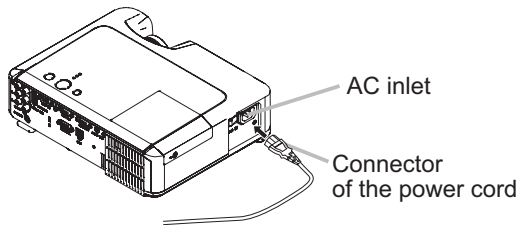
* In the default setting, the AUDIO IN3 L/R port is the audio port for the VIDEO, S-VIDEO and COMPONENT VIDEO ports. To change the settings, refer to the AUDIO item in the SETUP menu. (p.36)



Connecting power supply

⚠WARNING ▶ Please use extra caution when connecting the power cord, as incorrect or faulty connections may result in fire and/or electrical shock.

- Only use the power cord that came with the projector. If it is damaged, contact your dealer to newly get correct one.
- Only plug the power cord into an outlet rated for use with the power cord's specified voltage range.
- Never modify the power cord. Never attempt to defeat the ground connection of the three-pronged plug.



1. Connect the connector of the power cord to the AC inlet of the projector.
2. Firmly plug the power cord's plug into the outlet.

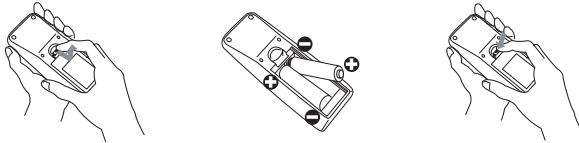
Remote control

Putting batteries

⚠WARNING ▶ Always handle the batteries with care and use them only as directed. Battery may explode if mistreated. Do not recharge, disassemble or dispose of in fire.

And also improper use may result in cracking or leakage, which could result in fire, injury and/or pollution of the surrounding environment.

- Be sure to use only the batteries specified. Do not use batteries of different types at the same time. Do not mix a new battery with used one.
- Make sure the plus and minus terminals are correctly aligned when loading a battery.
- Keep a battery away from children and pets. If swallowed consult a physician immediately for emergency treatment.
- Do not short circuit or solder a battery.
- Do not allow a battery in a fire or water. Keep batteries in a dark, cool and dry place.
- If you observe a leakage of a battery, wipe out the flower and then replace a battery. If the liquid adheres to your body or clothes, rinse well with water immediately.
- Obey the local laws on disposing the battery.



1. Remove the battery cover.
Slide back and remove the battery cover in the direction of the arrow.
2. Insert the batteries.
Align and insert the two AA batteries according to their plus and minus terminals as indicated in the remote control.
3. Close the battery cover.
Replace the battery cover in the direction of the arrow and snap it back into place.

Using the remote control

⚠ CAUTION ▶ Be careful in handling the remote control.

- Do not drop or expose the remote control to physical impact.
- Do not get the remote control wet or place it on wet objects. It may result in malfunction.
- Remove the batteries from the remote control and store them in a safe place if you won't be using the remote control for an extended period.
- Replace the batteries whenever the remote control starts malfunctioning.
- When strong lights (such as direct sunlight) or light from an extremely close range (such as from an inverter fluorescent lamp), hit the projector's remote sensor, the remote control may cause to function. Adjust the direction of the projector to keep the light from directly hitting the projector's remote sensor.

The signal settings for the remote control transmitter and the projector's remote sensor can be changed. If the remote control does not function properly try changing the signal setting.

Changing the signal setting for the remote control transmitter

(1) Setting 1 (FREQ. : NORMAL)

Simultaneously press and hold the MUTE and RESET buttons for about 3 seconds.

(2) Setting 2 (FREQ. : HIGH)

Simultaneously press and hold the MAGNIFY OFF and ESC buttons for about 3 seconds.

- Setting 1 is the factory default setting.
- When the batteries are removed from the remote control, user-specified settings are saved for about half a day. If the batteries are removed from the remote control for longer than half a day, the remote will reset to Setting 1.

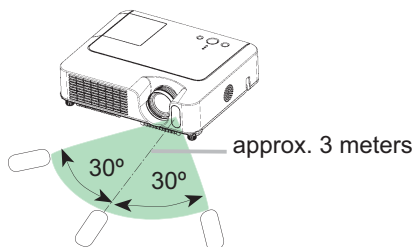
Changing the signal setting for the projector's remote sensor

Switch between Setting 1 and 2 using the SERVICE/REMOTE FREQ. item found in OPTION MENU. (p.43)

If the remote control does not seem to function properly, try changing the settings for the remote control and the projector's remote sensor.

The remote control will not function properly if the remote control transmitter settings and the projector's remote sensor settings are not the same.

The remote control works with the projector's remote sensor.



- The range of the remote sensor is 3 meters with a 60 degree range (30 degrees to the left and right of the remote sensor).
- Also a remote signal reflected in the screen etc. may be available. If it is difficult to send a remote signal to the sensor directly, please try to use the reflected signal.
- Since the remote control uses infrared light to send signals to the projector (Class 1 LED), be sure to use the remote control in an area free from obstacles that could block the remote control's output signal to the projector.

Power on/off

⚠ WARNING ▶ When the power is on, a strong light is emitted. Do not look into the lens of projector. Also do not peep at the inside of projector through a hole.

NOTE • Turn the power on/off in right order. Please power on the projector prior to the connected devices. Power off the projector later than the connected devices.

Turning on the power

1. Make sure that the power cord is firmly and correctly connected to the projector and the outlet.
2. Remove the lens cover, and set the power switch to the ON position.

The power indicator will light up in steady orange. Then wait several seconds because the buttons may not function for these several seconds.

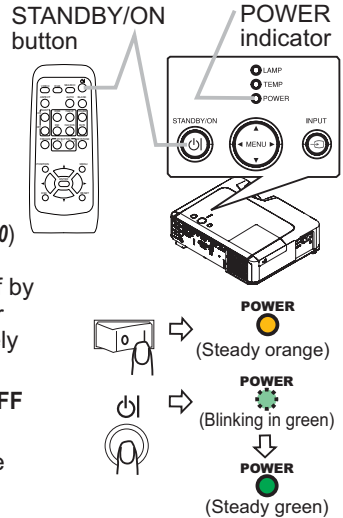
(1) When AUTO ON in the OPTION menu is set to TURN ON: (140)

The lamp will only be automatically turned on when the Power switch is turned on after the power was turned off by Power switch last time. Afterwards the POWER indicator will begin blinking in green. When the power is completely on, the indicator will stop blinking and light in green.

(2) When AUTO ON in the OPTION menu is set to TURN OFF please see step 3.

3. Press the STANDBY/ON button on the projector or the remote control.

To display the picture, select an input signal according to the section "Selecting an input signal" (118).

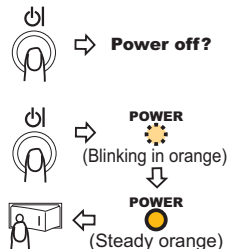


Turning off the power

Please pay special attention to below two points when you do:

- (1) Please do not turn the projector on again for at least 10 minute in this case. Neglect could shorten the lifetime of the lamp.
- (2) During use or immediately after use, do not touch around the lamp and vents of the projector (14 ★) It could cause a burn.

1. Press the STANDBY/ON button on the projector or the remote control.
The message "Power off?" will appear on the screen for about 5 seconds.
2. Press the STANDBY/ON button on the projector or the remote control again while the message appears.
The projector lamp will go off, and the POWER indicator will begin blinking in orange.
Then the POWER indicator will stop blinking and light in steady orange when the lamp cooling is complete.

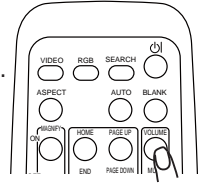


3. Make sure that the power indicator lights in steady orange, and set the power switch to the OFF position. The POWER indicator will go off. Attach the lens cover.

Operating

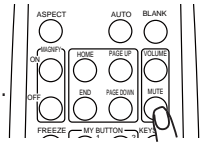
Adjusting the volume

1. Press the VOLUME button on the remote control.
 - A dialog will appear on the screen to aid you in adjusting the volume.
2. Use the cursor buttons ▲/▼ to adjust the volume.
 - To close the dialog and complete the operation, press the VOLUME button again. Even if you don't do anything, the dialog will automatically disappear after a few seconds.



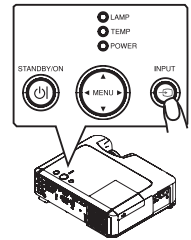
Temporarily muting the sound

1. Press the MUTE button on the remote control.
 - A dialog will appear on the screen indicating that you have muted the sound.
 - To restore the sound, press the MUTE or VOLUME button.
 - Even if you don't do anything, the dialog will automatically disappear after a few seconds.



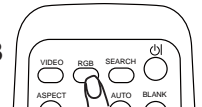
Selecting an input signal

1. Press the INPUT button on the projector.
 - Each time you press the button, the projector switches its input port as below.



1. Press the RGB button on the remote control to select an input port for the RGB signal.
 - Each time you press the button, the projector switches its RGB input port as below.

RGB IN1 ↔ RGB IN2



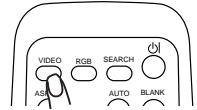
- If the RGB button is pushed (when switching from VIDEO to RGB signals) when TURN ON is selected for the AUTO SEARCH item in the OPTION menu the projector will check the RGB IN1 port first. If no input is detected at the port, the projector will check the RGB IN2 port.

Selecting an input signal (continued)

1. Press the VIDEO button on the remote control to select an input for video signal.

Each time you press the button, the projector switches its video input port as below.

COMPONENT VIDEO → S-VIDEO → VIDEO



- If the VIDEO button is pushed (when switching from RGB to VIDEO signals) when TURN ON is selected for the AUTO SEARCH item in the OPTION menu the projector will check the COMPONENT VIDEO port first. If no input is detected at the port, projector will begin to check other ports in above order.

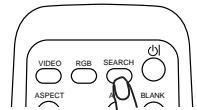
Searching an input signal

1. Press the SEARCH button on the remote control.

The projector will start to check its input ports in order to find any input signals.

When an input is found, the projector will stop searching and display the image. If no signal is found, the projector will return to the state selected before the operation.

RGB IN 1 → RGB IN 2 → COMPONENT VIDEO → S-VIDEO → VIDEO



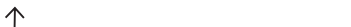
Selecting an aspect ratio

1. Press the ASPECT button on the remote control.

Each time you press the button, the projector switches the mode for aspect ratio in turn.

- For an RGB signal

NORMAL → 4:3 → 16:9 → SMALL



- For a video signal, s-video signal or component video signal

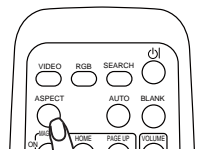
4:3 → 16:9 → 14:9 → SMALL



- For a no signal

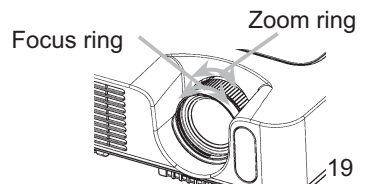
4:3 (fixed)

- The NORMAL mode keeps the original aspect ratio of the signal.
- Performing the automatic adjustment initializes the aspect ratio setting.



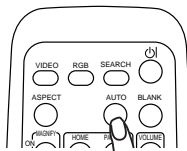
Adjusting the zoom and focus

1. Use the zoom ring to adjust the screen size.
2. Use the focus ring to focus the picture.



Using the automatic adjustment feature

1. Press the AUTO button on the remote control.



○ For an RGB signal

The vertical position, the horizontal position, the horizontal phase and the horizontal size will be automatically adjusted.

And the aspect ratio will be automatically set to default. Make sure that the application window is set to its maximum size prior to attempting to use this feature. A dark picture may still be incorrectly adjusted. Use a bright picture when adjusting.

○ For a video signal or s-video signal

The video format best suited for the respective input signal will be selected automatically.

This function is available only when the AUTO mode is selected to the VIDEO FORMAT item in the INPUT menu (133). For a component video signal, the signal type is identified automatically independently of this function.

○ For a video signal, s-video signal or component video signal

The vertical position, horizontal position and aspect ratio will be automatically set to default.

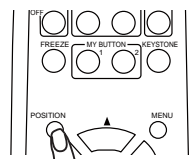
○ For a component video signal

The horizontal phase will be automatically set to default.

- The automatic adjustment operation requires about 10 seconds. Also please note that it may not function correctly with some input.

Adjusting the position

1. Press the POSITION button on the remote control.
The "POSITION" indication will appear on the screen.
2. Use the cursor buttons ▲/▼/◀/▶ to adjust the picture position.



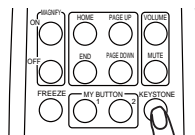
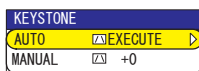
When you want to reset the operation, press the RESET button on the remote control during the operation.

To complete this operation, press the POSITION button again. Even if you don't do anything, the dialog will automatically disappear after a few seconds.

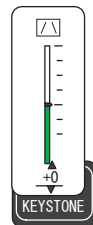
- When this function is performed at a video signal, a certain extra such as a line may appear outside a picture.

Correcting the keystone distortions

1. Press the KEYSTONE button on the remote control. A dialog will appear on the screen to aid you in correcting the distortion.
2. Use the cursor buttons ▲/▼ to select AUTO or MANUAL operation, and press the button ► to perform the following.



- 1) AUTO executes automatic vertical keystone correction.
- 2) MANUAL displays a dialog for vertical keystone correction. Use the buttons ▲/▼ for adjustment.

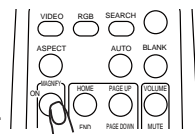


To close the dialog and complete this operation, press the KEYSTONE button again. Even if you don't do anything, the dialog will automatically disappear after a few seconds.

- The adjustable range for correction will vary among inputs. For some input, this function may not work well.
- When V:INVERT or H&V:INVERT is selected to the MIRROR item in the SETUP menu, if the projector screen is inclined or angled downward, the Auto Keystone function may not work correctly.
- When the zoom adjustment is set to the TELE (telephoto focus), this correction may be excessive. This function should be used when the zoom adjustment is set to the WIDE (wide-angle focus) whenever possible.
- When vertical degree is almost 0 degree, the automatic keystone distortion correction may not work.
- When vertical degree is almost ± 30 degree, the automatic keystone distortion correction may not work well.
- This function will be unavailable when Transition Detector is on (48).

Using the magnify feature

1. Press the ON button of MAGNIFY on the remote control. The "MAGNIFY" indication will appear on the screen (although the indication will disappear in several seconds with no operation), and the projector will enter the MAGNIFY mode.



2. Use the cursor buttons ▲/▼ to adjust the zoom level. To move the zoom area, press the POSITION button in the MAGNIFY mode, then use the cursor buttons ▲/▼/◀/▶ to move the area. And to finalize the zoom area, press the POSITION button again.

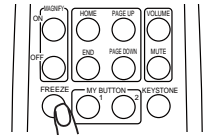
To exit the MAGNIFY mode and restore the screen to normal, press the OFF button of MAGNIFY on the remote control.

- The projector automatically exits the MAGNIFY mode when the input signal is changed, or when the display condition is changed.
- Although in the MAGNIFY mode, the keystone distortion condition may vary, it will be restored when the projector exits the MAGNIFY mode.

Freezing the screen

1. Press the FREEZE button on the remote control.
 - The “FREEZE” indication will appear on the screen, and the projector will enter the FREEZE mode.

To exit the FREEZE mode and restore the screen to normal, press the FREEZE button again.

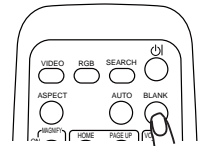


- The projector automatically exits the FREEZE mode when the input signal changes, or when one of the projector’s buttons or the remote control buttons of STANDBY/ON, SEARCH, RGB, VIDEO, BLANK, AUTO, ASPECT, VOLUME, MUTE, KEYSTONE, POSITION, MENU, MAGNIFY and MY BUTTON is pressed.
- If the projector continues projecting a still image for a long time, the LCD panel might possibly be printed. Do not leave the projector in the FREEZE mode for too long.

Temporarily blanking the screen

1. Press the BLANK button on the remote control.
 - The blank screen will be displayed instead of the screen of input signal. Please refer to the BLANK item in the SCREEN menu (p.37).

To exit the blank screen and return to the input signal screen, press the BLANK button again.

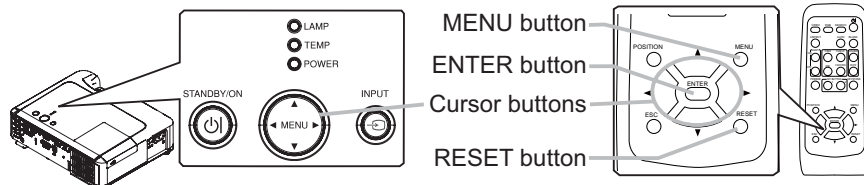


- The projector automatically returns to the input signal screen when one of the projector’s buttons or the remote control buttons is pressed or one of the commands (except get commands) is transmitted from the control port.

Multifunctional settings

Using the menu function

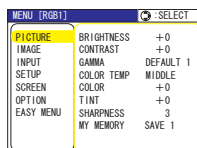
This projector has the following menus: PICTURE, IMAGE, INPUT, SETUP, SCREEN, OPTION, and EASY MENU. EASY MENU consists of functions often used, and the other menus are classified into each purpose. Each of these menus is operated using the same methods. The basic operations of these menus are as follows.



1. Press the MENU button on the remote control or one of the cursor buttons on the projector.
The Advanced MENU or EASY MENU will appear.

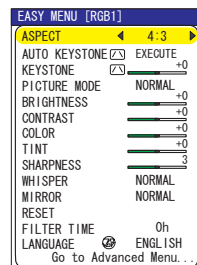
In the EASY MENU

2. If you want to change it to the Advanced MENU, select the "Go to Advanced Menu"
3. Use the cursor buttons ▲/▼ to select an item to operate.
4. Use the cursor buttons ◀/▶ to operate the item.



In the Advanced MENU

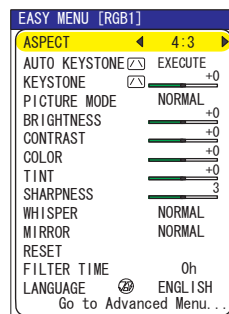
2. Use the cursor buttons ▲/▼ to select a menu.
If you want to change it to the EASY MENU, select the EASY MENU.
Then press the cursor button ▶ on the projector or remote control, or the ENTER button on the remote control to select an item. The display of the selected menu will be active.
3. Use the cursor buttons ▲/▼ to select an item to operate.
Then press the cursor button ▶ on the projector or remote control, or the ENTER button on the remote control to progress. The operation menu of the selected item will appear.
4. Use the cursor buttons ▲/▼ to operate the item.
 - When you want to reset the operation, press the RESET button on the remote control during the operation. Note that items whose functions are performed simultaneously with operation (ex. LANGUAGE, H PHASE, VOLUME etc.) cannot be reset.
 - In the advanced menu, when you want to return to the previous display, press the cursor button ◀ on the projector or remote control, or the ESC button on the remote control.
5. Press the MENU button on the remote control again to close the menu and complete this operation. Even if you don't do anything, the dialog will automatically disappear after about 10 seconds.
 - Some functions cannot be performed when a certain input port is selected, or when a certain input signal is displayed.



EASY Menu

With the EASY MENU, items shown in the table below can be performed.

Select an item using the cursor buttons ▲/▼ on the projector or remote control. Then perform it referring to the following table.



Item	Description
ASPECT	Using the buttons ◀/▶ switches the mode for aspect ratio. See the ASPECT item in the IMAGE menu (📖30).
AUTO KEYSTONE EXECUTE	Using the button ▶ executes the auto keystone function. See the AUTO KEYSTONE EXECUTE item in the SETUP menu (📖35). This function will be unavailable when Transition Detector is on (📖48).
KEYSTONE	Using the buttons ◀/▶ corrects the keystone distortion. See the item KEYSTONE of section SETUP menu. (📖35) This function will be unavailable when Transition Detector is on (📖48).
PICTURE MODE	Using the buttons ◀/▶ switches the mode of picture type. The modes of picture type are combinations of a mode of GAMMA and a mode of COLOR TEMP. Choose a suitable mode according to the projected source. <div style="text-align: center;"> </div> <p>NORMAL: (COLOR TEMP = MID DEFAULT) + (GAMMA = #1 DEFAULT) CINEMA: (COLOR TEMP = LOW DEFAULT) + (GAMMA = #2 DEFAULT) DYNAMIC: (COLOR TEMP = HIGH DEFAULT) + (GAMMA = #3 DEFAULT) BOARD(BLACK): (COLOR TEMP = Hi-BRIGHT-1 DEFAULT) + (GAMMA = #4 DEFAULT) BOARD(GREEN): (COLOR TEMP = Hi-BRIGHT-2 DEFAULT) + (GAMMA = #4 DEFAULT) WHITEBOARD: (COLOR TEMP = MID DEFAULT) + (GAMMA = #5 DEFAULT)</p> <ul style="list-style-type: none"> • When the combination of GAMMA and COLOR TEMP differs from pre-assigned modes above, the display on the menu for the PICTURE MODE is "CUSTOM". Please refer to the GAMMA (📖27) and COLOR TEMP (📖28) items in the PICTURE menu. • When this function is performed, a certain extra such as a line may appear.
BRIGHTNESS	Using the buttons ◀/▶ adjusts the brightness. See the item BRIGHTNESS in the PICTURE menu (📖27).

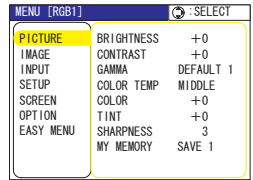
EASY Menu (continued)

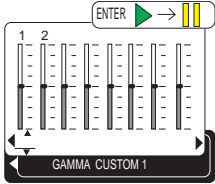
Item	Description
CONTRAST	Using the buttons ◀/▶ adjusts the contrast. See the item CONTRAST of section PICTURE menu (📖27).
COLOR	Using the buttons ◀/▶ adjusts the strength of whole color. See the COLOR item in the PICTURE menu (📖28).
TINT	Using the buttons ◀/▶ adjusts the tint. See the TINT item in the PICTURE menu (📖28).
SHARPNESS	Using the buttons ◀/▶ adjusts the sharpness. See the SHARPNESS item in the PICTURE menu (📖28). • There may be some noise when an adjustment is made. This is not a malfunction.
WHISPER	Using the buttons ◀/▶ turns off/on the whisper function. See the WHISPER item in the SETUP menu (📖35).
MIRROR	Using the buttons ◀/▶ switches the mode for mirror status. See the MIRROR item in the SETUP menu (📖36). If Transition Detector is TURN ON and MIRROR status is changed, Transition Detector Alarm (📖48) will be displayed when projector is restarted after the power switch is turned off.
RESET	Performing this item resets all of the items of EASY MENU except FILTER TIME and LANGUAGE. A dialog is displayed for confirmation. Selecting RESET using the button ▲ performs resetting.
FILTER TIME	Performing this item resets the filter timer which counts usage time of the air filter. A dialog is displayed for confirmation. Selecting RESET using the button ▲ performs resetting. See the FILTER TIME item in the OPTION menu (📖41).
LANGUAGE	Using the buttons ◀/▶ selects the LANGUAGE item to toggle the menu language. Refer to description of LANGUAGE in the SCREEN menu (📖37).
Go to Advanced Menu	Select “Go to Advanced Menu” and press the button ▶ or the ENTER button to use the menu of PICTURE, IMAGE, INPUT, SETUP, SCREEN or OPTION.

PICTURE Menu

With the PICTURE menu, the items shown in the table below can be performed.

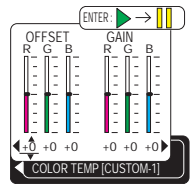
Select an item using the cursor buttons ▲/▼ on the projector or remote control, and press the cursor button ► on the projector or remote control, or the ENTER button on the remote control to execute the item. Then perform it referring to the following table.



Item	Description
BRIGHTNESS	Using the buttons ▲/▼ adjusts the brightness. : Light ⇔ Dark
CONTRAST	Using the buttons ▲/▼ adjusts the contrast. : Strong ⇔ Weak
GAMMA	<p>Using the buttons ▲/▼ switches the GAMMA mode. #1 DEFAULT ⇔ #1 CUSTOM ⇔ #2 DEFAULT ⇔ #2 CUSTOM ⇔ #3 DEFAULT ⇕ ⇕ #5 CUSTOM ⇔ #5 DEFAULT ⇔ #4 CUSTOM ⇔ #4 DEFAULT ⇔ #3 CUSTOM</p> <p>To adjust CUSTOM</p> <p>Selecting a mode of CUSTOM and then pressing the button ► or the ENTER button displays a dialog to aid you in adjusting the mode. This function is useful when you want to change the brightness of particular tones.</p> <p>Choose an item using the buttons ◀/▶, and adjust the level using the buttons ▲/▼.</p>  <p>You can display a test pattern for checking the effect of your adjustment by pressing the ENTER button. Each time you press the ENTER button, the pattern changes as below.</p> <p>No pattern ⇔ Gray scale of 9 steps ⇐ ⇐⇐⇐ Ramp ⇔ Gray scale of 15 steps</p> <p>The eight equalizing bars correspond to eight tone levels of the test pattern except the darkest in the left end. If you want to adjust the 2nd tone from left end on the test pattern (Gray scale of 9 steps), use the equalizing adjustment bar "1". The darkest tone at the left end of the test pattern cannot be controlled with any of equalizing adjustment bar.</p> <ul style="list-style-type: none"> • When this function is performed, a certain extra such as a line may appear.

PICTURE Menu (continued)

Item	Description
<p>COLOR TEMP</p>	<p>Using the buttons ▲/▼ switches the mode of color temperature.</p> <p>→ HIGH DEFAULT ⇔ HIGH CUSTOM ⇔ MID DEFAULT ⇔ MID CUSTOM ← ↳ LOW DEFAULT ⇔ LOW CUSTOM ⇔ H BRIGHT 1 DEFAULT ⇔ H BRIGHT 1 CUSTOM ← ↳ H BRIGHT 2 DEFAULT ⇔ H BRIGHT 2 CUSTOM ←</p> <p>To adjust CUSTOM</p> <p>Selecting the CUSTOM and then pressing the button ► or the ENTER button displays a dialog to aid you in adjusting the OFFSET and/or GAIN of the CUSTOM mode.</p> <p>OFFSET adjustments change the color intensity on the whole tones of the test pattern.</p> <p>GAIN adjustments mainly affect color intensity on the brighter tones of the test pattern.</p> <p>Choose an item using the buttons ◀/▶, and adjust the level using the buttons ▲/▼.</p> <p>You can display a test pattern for checking the effect of your adjustment by pressing the ENTER button. Each time you press the ENTER button, the pattern changes as below.</p> <p>No pattern ⇔ Gray scale of 9 steps ⇐ ↳ Ramp ⇔ Gray scale of 15 steps</p> <ul style="list-style-type: none"> • When this function is performed, a certain extra such as a line may appear.
<p>COLOR</p>	<p>Using the buttons ▲/▼ adjusts the strength of whole color.</p> <p>Strong ⇔ Weak</p> <ul style="list-style-type: none"> • This item can be selected only for a video signal, s-video or component video signal.
<p>TINT</p>	<p>Using the buttons ▲/▼ adjusts the tint.</p> <p>Greenish ⇔ Redish</p> <ul style="list-style-type: none"> • This item can be selected only for a video signal, s-video or component video signal.
<p>SHARPNESS</p>	<p>Using the buttons ▲/▼ adjusts the sharpness.</p> <p>Strong ⇔ Weak</p> <ul style="list-style-type: none"> • There may be some noise and/or the screen may flicker for a moment when an adjustment is made. This is not a malfunction.



PICTURE Menu (continued)

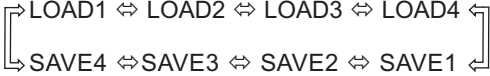
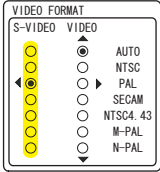
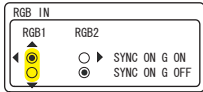
Item	Description
<p>MY MEMORY</p>	<p>Selecting a mode of MY MEMORY using the buttons ▲/▼ and then pressing the button ► or the ENTER button performs each function.</p> <p style="text-align: center;">  </p> <p>This projector has 4 numbered memories for adjustment data. Performing the LOAD1, LOAD2, LOAD3 or LOAD4 loads the data on the memory whose number corresponds to the command's number, and adjusts the picture automatically depending on the data. Performing the SAVE1, SAVE2, SAVE3 or SAVE4 saves the current adjustment data on the memory whose number corresponds to the command's number.</p> <ul style="list-style-type: none"> • The current adjustment data of the items in the PICTURE menu is stored. • There may be some noise and/or the screen may flicker for a moment when data is loaded to memory. This is not a malfunction. <p>When the current settings are not saved to memory the following dialog is displayed.</p> <div data-bbox="658 735 981 810" style="border: 1px solid black; background-color: #000080; color: white; padding: 5px;"> <p>Temporary condition</p> <p>MEMORY : Recall saved parameters</p> <p>◀ : Quit</p> </div> <p>To load saved adjustment settings press the MEMORY button. When there are no saved adjustment settings the following dialog is displayed.</p> <div data-bbox="762 906 894 927" style="border: 1px solid black; background-color: #000080; color: white; padding: 2px; text-align: center;"> <p>No saved data</p> </div>

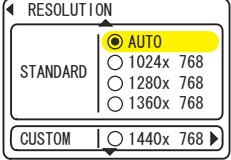



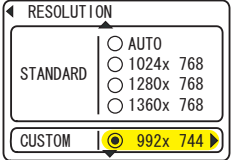
IMAGE Menu (continued)

Item	Description
H SIZE	<p>Using the buttons ▲/▼ adjusts the horizontal size. Large ↔ Small</p> <ul style="list-style-type: none"> • This item can be selected only for an RGB signal. • When this adjustment is excessive, the picture may not be displayed correctly. In such a case, please reset the adjustment by pressing the RESET button on the remote control during this operation.
AUTO ADJUST EXECUTE	<p>Selecting this item performs the automatic adjustment feature.</p> <p>For an RGB signal The vertical position, the horizontal position, the horizontal phase and the horizontal size will be automatically set to default. And the aspect ratio will be automatically selected. Make sure that the application window is set to its maximum size prior to attempting to use this feature. A dark picture may still be incorrectly adjusted. Use a bright picture when adjusting.</p> <p>For a video signal or s-video signal The video format best suited for the respective input signal will be selected automatically. This function is available only when the AUTO mode is selected to the VIDEO FORMAT item in the INPUT menu. For a component video signal, the signal type is identified automatically independently of this function.</p> <p>For a video signal, s-video signal or component video signal The vertical position, horizontal position and aspect ratio will be automatically set to default.</p> <p>For a component video signal The horizontal phase will be automatically set to default.</p> <ul style="list-style-type: none"> • The automatic adjustment operation requires about 10 seconds. Also please note that it may not function correctly with some input.

INPUT Menu (continued)

Item	Description
<p>COMPONENT</p>	<p>Using the buttons ▲/▼ switches the function of COMPONENT VIDEO port. COMPONENT ⇔ SCART RGB</p> <p>When the SCART RGB is selected, the COMPONENT VIDEO port function as a port for a SCART RGB signal input and VIDEO port function as a port for SCART RGB sync input. A SCART adapter and SCART cable realize a SCART RGB input to the projector. For details, contact your dealer.</p>
<p>VIDEO FORMAT</p>	<p>Set the video format for the s-video port and video port. (1) Use the ◀/▶ buttons to select the input port. (2) Using the buttons ▲/▼ switches the mode for video format.</p> <p>AUTO ⇔ NTSC ⇔ PAL ⇔ SECAM ↵ N-PAL ⇔ M-PAL ⇔ NTSC4.43 ↗</p> <ul style="list-style-type: none"> • This item is performed only for a video signal from the VIDEO port or the S-VIDEO port. • The AUTO mode automatically selects the optimum mode. • The AUTO operation may not work well for some signals. If the picture becomes unstable (ex. an irregular picture, a color lack), please select the mode depending on the input signal.  <p>The diagram shows a control panel for VIDEO FORMAT. It has two columns: S-VIDEO and VIDEO. Each column has a vertical row of seven circular buttons. The top button in each column is highlighted with a yellow bar. To the right of the buttons are labels: AUTO, NTSC, PAL, SECAM, NTSC4.43, M-PAL, and N-PAL. Arrows indicate that the top button is selected.</p>
<p>FRAME LOCK</p>	<p>Using the buttons ▲/▼ turns the frame lock function on/off. TURN ON ⇔ TURN OFF</p> <ul style="list-style-type: none"> • This item performs only at a RGB signal with vertical frequency of 50 to 60 Hz. • When the TURN ON is selected, a moving picture is displayed more smoothly. • This function may cause a certain degradation of the picture. In such a case, please select the TURN OFF.
<p>RGB IN</p>	<p>Set the RGB input signal type for the RGB port. (1) Use the ◀/▶ buttons to select the RGB port to be set. RGB1 ⇔ RGB2</p> <p>(2) Use the ▲/▼ buttons to select the RGB input signal type. SYNC ON G ON ⇔ SYNC ON G OFF</p> <ul style="list-style-type: none"> • Selecting TURN ON turns on the SYNC ON G mode. The SYNC ON G mode allows reception of SYNC ON G. • In the SYNC ON G mode, the picture may be distorted with certain input signals. In such a case, remove the signal connector so that no signal is received and turn SYNC ON G off, and then reconnect the signal.  <p>The diagram shows a control panel for RGB IN. It has two columns: RGB1 and RGB2. Each column has a vertical row of three circular buttons. The top button in each column is highlighted with a yellow bar. To the right of the buttons are labels: SYNC ON G ON and SYNC ON G OFF. Arrows indicate that the top button is selected.</p>

INPUT Menu (continued)

Item	Description
<p>RESOLUTION *2</p>	<p>The resolution for the RGB1 and RGB2 input signals can be set on this projector.</p> <p>(1) In the INPUT menu select RESOLUTION using the ▲/▼ buttons and press the ► button. The RESOLUTION menu will be displayed.</p>  <p>RESOLUTION MENU</p> <p>(2) In the RESOLUTION menu select the resolution you wish to display using the ▲/▼ buttons. Selecting AUTO will set a resolution appropriate to the input signal.</p> <p>(3) Pressing the ► or Enter button when selecting a STANDARD resolution will automatically adjust the horizontal and vertical positions, clock phase and horizontal size and automatically select an aspect ratio. The INFORMATION dialog (43) will be displayed.</p>  <p>(4) To set a custom resolution use the ▲/▼ buttons to select CUSTOM and the CUSTOM RESOLUTION BOX will be displayed. Set the horizontal (HORZ) and vertical (VERT) resolutions using the ▲/▼/◀/▶ buttons. *1</p>  <p>CUSTOM RESOLUTION BOX</p> <p>(5) To save the setting place the cursor on the right-most digit and press the ► button. The horizontal and vertical positions, clock phase and horizontal size will be automatically adjusted and an aspect ratio will be automatically selected. After the INFORMATION(43) dialog has displayed for about 10 seconds the screen will return to the RESOLUTION menu displaying the changed resolution.</p>  <p>(6) To revert back to the previous resolution without saving changes place the cursor on the left-most digit and press the ◀ button. The screen will then return to the RESOLUTION menu displaying the previous resolution.</p> 

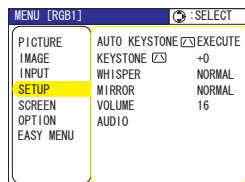
*1 Not all resolutions are guaranteed.

*2 For some pictures, this function may not work well.

SETUP Menu


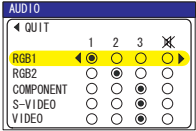
With the SETUP menu, the items shown in the table below can be performed.

Select an item using the cursor buttons ▲/▼ on the projector or remote control, and press the cursor button ► on the projector or remote control, or the ENTER button on the remote control to execute the item. Then perform it referring to the following table.



Item	Description
AUTO KEYSTONE EXECUTE	<p>Selecting this item performs the Automatic keystone distortion correction. Projector automatically corrects vertical keystone distortion due to the (forward/backward) setup angle by itself.</p> <ul style="list-style-type: none"> • This function will be executed only once when selected in the Menu. When the slant of the projector is changed, executes this function again. • When V:INVERT or H&V:INVERT is selected to the MIRROR item in the SETUP menu, if the projector screen is inclined or angled downward, this function may not work correctly. • When the zoom adjustment is set to the TELE (telephoto focus), this correction may be excessive. This function should be used when the zoom adjustment is set to the WIDE (wide-angle focus) whenever possible. • When vertical degree is almost 0 degree, the automatic keystone distortion correction may not work. • When vertical degree is over ± 30 degree, the automatic keystone distortion correction may not work well. • This function will be unavailable when Transition Detector is on (📖48).
KEYSTONE	<p>Using the buttons ▲/▼ corrects the keystone distortion. Upper in the data ⇄ Lower in the data</p> <ul style="list-style-type: none"> • The adjustable range of this function will vary with the type of input signal. At some signals, this function may not work well. • This function will be unavailable when Transition Detector is on (📖48).
WHISPER	<p>Using the buttons ▲/▼ turns off/on the whisper function. BRIGHT ⇄ NORMAL</p> <ul style="list-style-type: none"> • When the NORMAL is selected, acoustic noise and screen brightness are reduced.

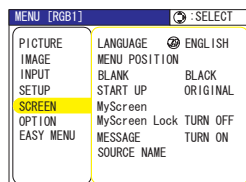
SETUP Menu (continued)

Item	Description
<p>MIRROR</p>	<p>Using the buttons ▲/▼ switches the mode for mirror status.</p>  <p>NORMAL ⇔ H:INVERT ⇔ V:INVERT ⇔ H&V:INVERT</p> <p>↑ _____ ↑</p> <p>If Transition Detector is TURN ON and MIRROR status is changed, Transition Detector Alarm (🔊48) will be displayed when projector is restarted after the power switch is turned off.</p>
<p>VOLUME</p>	<p>Using the buttons ▲/▼ adjusts the volume. High ⇔ Low</p>
<p>AUDIO</p>	<p>Allocates the audio ports. Choose a picture input port using the buttons ▲/▼ (1), then select the audio port to be interlocked with the input port using the buttons ◀/▶ (2). When off is selected, all audio ports do not work for the input port.</p> <p>(1) RGB1 ⇔ RGB2 ⇔ COMPONENT ⇔ S-VIDEO ⇔ VIDEO</p> <p>(2) 1 ⇔ 2 ⇔ 3 ⇔ ✕</p> 

SCREEN Menu


With the SCREEN menu, the items shown in the table below can be performed.

Select an item using the cursor buttons ▲/▼ on the projector or remote control, and press the cursor button ► on the projector or remote control, or the ENTER button on the remote control to execute the item. Then perform it referring to the following table.



Item	Description
LANGUAGE	<p>Using the buttons ▲/▼ switches the OSD (On Screen Display) language.</p> <p>ENGLISH ⇄ FRANÇAIS ⇄ DEUTSCH ⇄ ESPAÑOL ⇄ ITALIANO</p> <p>↕</p> <p>NORSK ⇄ NEDERLANDS ⇄ PORTUGUÊS ⇄ 日本語</p> <p>↕</p> <p>简体中文 ⇄ 繁體中文 ⇄ 한글 ⇄ SVENSKA ⇄ РУССКИЙ</p> <p>↕</p> <p>SUOMI ⇄ POLSKI ⇄ TÜRKÇE</p>
MENU POSITION	<p>Using the buttons ◀/▶/▲/▼ adjusts the menu position. To quit the operation, press the MENU button on the remote control or keep no operation for about 10 seconds.</p>
BLANK	<p>Using the buttons ▲/▼ switches the mode for the blank screen. The blank screen is a screen for the temporarily blanking feature (📺22). It is displayed by pressing the BLANK button on the remote control.</p> <p>MyScreen ⇄ ORIGINAL ⇄ BLUE ⇄ WHITE ⇄ BLACK</p> <p>↕</p> <p>MyScreen is a screen you can register as a desired screen. The ORIGINAL screen is the existing standard screen. BLUE, WHITE and BLACK are non-patterned (plain) screens in each color.</p> <ul style="list-style-type: none"> • To avoid remaining as an afterimage, the MyScreen and the ORIGINAL screens will change to the BLACK screen after several minutes. • For the MyScreen, please refer to the MyScreen item (📺38).

SCREEN Menu (continued)

Item	Description
<p>START UP</p>	<p>Using the buttons ▲/▼ switches the mode for the start-up screen. The start-up screen is a screen displayed when no signal or an unsuitable signal is detected. MyScreen ⇔ ORIGINAL ⇔ TURN OFF</p>  <p>MyScreen is a screen you can register as a desired screen. The ORIGINAL screen is the existing standard screen. When TURN OFF is selected, the BLACK screen is used.</p> <ul style="list-style-type: none"> • To avoid remaining as an afterimage, the MyScreen and the ORIGINAL screens will change to the BLANK screen after several minutes. If also the BLANK screen is the MyScreen or ORIGINAL, it will change to the BLACK screen. • For the MyScreen, please refer to the item MyScreen below. For the BLANK screen, please refer to the BLANK item (p.37). • This function will be unavailable and fixed to Myscreen when MyScreen Password in the Security Menu is on.
<p>MyScreen</p>	<p>This item functions for capturing the MyScreen of the blank screen and the start-up screen. Please execute displaying the input including the picture you want to capture.</p> <ol style="list-style-type: none"> 1. Selecting this item displays a dialog titled “MyScreen”. It will ask you if you start capturing the picture from the current screen. Please wait for the target picture to be displayed, and press the ENTER button on the remote control when the picture is displayed. The picture will freeze and the frame for capturing appears. To stop performing, press the RESET or ESC button on the remote control. 2. Using the buttons ◀/▶/▲/▼ adjusts the frame position. Please move the frame to the position of the picture which you want to use. The frame may not be able to be moved for some input signals. To start registration, press the ENTER button on the remote control. To restore the screen and return to the previous dialog, press the RESET or ESC button on the remote control. <p>Registration takes several minutes. When the registration is completed, the registered screen and the message “MyScreen registration is finished.” are displayed for several seconds. If the registration failed, the message “A capturing error has occurred. Please try again.” is displayed.</p> <ul style="list-style-type: none"> • This function will be unavailable when MyScreen Password in the Security Menu is on. <p>NOTE : The KEYSTONE cannot be adjusted while using the MyScreen function.</p>
<p>MyScreen Lock</p>	<p>Using the buttons ▲/▼ turns on/off the MyScreen lock function. TURN ON ⇔ TURN OFF</p> <p>When the TURN ON is selected, the item MyScreen is locked. Use this function for protecting the current MyScreen.</p> <ul style="list-style-type: none"> • This function will be unavailable when MyScreen Password in the Security Menu is on.

SCREEN Menu (continued)

Item	Description
<p>MESSAGE</p>	<p>Using the buttons ▲/▼ turns on/off the message function. TURN ON ⇔ TURN OFF</p> <p>When the TURN ON is selected, the following message function works. "AUTO IN PROGRESS" while automatically adjusting "NO INPUT IS DETECTED" "SYNC IS OUT OF RANGE" "Searching...." while searching for the input "Detecting...." while an input signal is detected The indication of the input signal displayed by changing The indication of the aspect ration displayed by changing The indication of the My Memory displayed by changing The indication of the Picture Mode displayed by changing The indication of "FREEZE" and "II" while freezing the screen by pressing the FREEZE button.</p> <ul style="list-style-type: none"> • When the TURN OFF is selected, please remember if the picture is freezing. Do not mistake freezing for a malfunction (22).
<p>SOURCE NAME</p>	<p>Each input port for this projector can have a name applied to it.</p> <p>(1) Use the ▲/▼ buttons on the SCREEN menu to select SOURCE NAME and press the ► button. The SOURCE NAME menu will be displayed.</p> <p>(2) Use the ▲/▼ buttons on the SCREEN NAME menu to select the port to be named and press the ► button. The SOURCE NAME dialog will be displayed.</p> <p>(3) The current name will be displayed on the first line. Use the ◀/▶/▲/▼ and ENTER or INPUT buttons to select and enter characters. The RESET button can be used to erase 1 character at a time. The name can be a maximum of 16 characters.</p> <p>(4) To change an already inserted character, press the ▲ button while the cursor is on the [A-N] row to move the cursor to the name displayed on the first line and use the ◀/▶ buttons to select character to be changed. Once a character in the name is selected use the ▼ button to move the cursor back down to the character entry area to select and enter characters as described above.</p> <p>(5) Select and press the ENTER or INPUT buttons when finished entering text. To revert to the previous name without saving changes press the ESC or ◀ button and the INPUT button simultaneously.</p> <div data-bbox="800 715 1031 858" style="border: 1px solid black; padding: 5px;"> <p>◀SOURCE NAME</p> <p>RGB1 : </p> <p>RGB2 : DESKTOP PC</p> <p>COMPONENT : DVD</p> <p>S-VIDEO : CAMERA</p> <p>VIDEO : VTR</p> </div> <p style="text-align: center;">SOURCE NAME MENU</p> <p>*Right side of the menu is blank until a name is specified</p> <div data-bbox="792 943 1031 1114" style="border: 1px solid black; padding: 5px;"> <p>NAME: RGB1 SELECT</p> <p>R G B 1</p> <p>A B C D E F G H I J K L M N</p> <p>O P Q R S T U V W X Y Z</p> <p>a b c d e f g h i j k l m n</p> <p>o p q r s t u v w x y z</p> <p>0 1 2 3 4 5 6 7 8 9</p> <p>- . # ! ? &</p> <p>ESC. ◀ : QUIT ENTER. : NEXT</p> </div> <div data-bbox="792 1134 1031 1305" style="border: 1px solid black; padding: 5px;"> <p>NAME: RGB1 SELECT</p> <p>R G B 1</p> <p>A B C D E F G H I J K L M N</p> <p>O P Q R S T U V W X Y Z</p> <p>a b c d e f g h i j k l m n</p> <p>o p q r s t u v w x y z</p> <p>0 1 2 3 4 5 6 7 8 9</p> <p>- . # ! ? &</p> <p>ESC. ◀ : QUIT</p> </div> <div data-bbox="792 1326 1031 1497" style="border: 1px solid black; padding: 5px;"> <p>NAME: RGB1 SELECT</p> <p>R G B 1</p> <p>A B C D E F G H I J K L M N</p> <p>O P Q R S T U V W X Y Z</p> <p>a b c d e f g h i j k l m n</p> <p>o p q r s t u v w x y z</p> <p>0 1 2 3 4 5 6 7 8 9</p> <p>- . # ! ? &</p> <p>ESC. ◀ : QUIT ENTER. : NEXT</p> </div>

OPTION Menu



With the OPTION menu, the items shown in the table below can be performed.

Select an item using the cursor buttons ▲/▼ on the projector or remote control, and press the cursor button ► on the projector or remote control, or the ENTER button on the remote control to execute the item, except for the items LAMP TIME and FILTER TIME. Then perform it referring to the following table.

MENU [RGB1]		SELECT
PICTURE	AUTO SEARCH	TURN OFF
IMAGE	AUTO KEYSTONE	TURN OFF
INPUT	AUTO ON	TURN OFF
SETUP	AUTO OFF	0min
SCREEN	LAMP TIME	0h
OPTION	FILTER TIME	0h
EASY MENU	MY BUTTON	
	SERVICE	
	SECURITY	

Item	Description
AUTO SEARCH	<p>Using the buttons ▲/▼ turns on/off the automatic signal search function. TURN ON ⇔ TURN OFF</p> <p>When the TURN ON is selected, detecting no signal automatically cycles through input ports in the following order. The search is started from the current port. Then when an input is found, the projector will stop searching and display the image.</p> <p>RGB IN1 ⇨ RGB IN2 ⇨ COMPONENT VIDEO ⇨ S-VIDEO ⇨ VIDEO</p> <p style="text-align: center;">↑ └──┘</p>
AUTO KEYSTONE	<p>Using the buttons ▲/▼ turns on/off the automatic keystone function. TURN ON ⇔ TURN OFF</p> <p>TURN ON : Automatic keystone distortion correction will be executed whenever changing the slant of the projector.</p> <p>TURN OFF : This function is disabled. Please execute the AUTO KEYSTONE EXECUTE in the SETUP Menu for automatic keystone distortion correction.</p> <p>When the projector is suspended from the ceiling this feature will not function properly so select TURN OFF. This function will be unavailable when Transition Detector is on (48).</p>
AUTO ON	<p>Using the buttons ▲/▼ turns on/off the AUTO ON function. TURN ON ⇔ TURN OFF</p> <p>When set to TURN ON, the lamp will only be automatically turned on when the Power switch is turned on after the power was turned off by Power switch last time.</p> <p>The lamp will not be automatically turned on when the Power switch is turned on if the lamp was turned off with the following procedures.</p> <ul style="list-style-type: none"> • The lamp was turned off with a remote control, projector button, or power turn off command. • The lamp was turned off with an AUTO OFF function (41). • The lamp was turned on by an AUTO ON function and was turned off about 30 minutes after no signal had been detected. <p>When no input is detected after the power on and AUTO OFF time is set to 0, the projector will be turned off after about 30 minutes passed.</p> <p>When no input is detected after the power on and AUTO OFF time is set to 1 to 99, the projector will be turned off after the passed time reaches at the set time.</p> <p>If one of the projector's buttons or the remote control buttons is pressed or one of the commands (except get commands) is transmitted from the control port during the corresponding time, projector will not be turned off.</p>


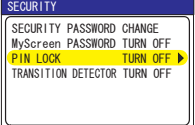



OPTION Menu (continued)

Item	Description
<p>AUTO OFF</p>	<p>Using the buttons ▲/▼ adjusts the time to count down to automatically turn the projector off. Long (max. 99 minutes) ⇔ Short (min. 0 minute = DISABLE)</p> <div style="display: flex; justify-content: space-around; align-items: center;">   </div> <p>When the time is set to 0, the projector is not turned off automatically. When the time is set to 1 to 99, and when the passed time with no-signal or an unsuitable signal reaches at the set time, the projector lamp will be turned off. If one of the projector's buttons or the remote control buttons is pressed or one of the commands (except get commands) is transmitted from the control port during the corresponding time, projector will not be turned off. Please refer to the section "Turning off the power" (17).</p>
<p>LAMP TIME</p>	<p>The lamp time is the time counted after the last resetting. It is shown in the OPTION menu as the usage time of the lamp. Pressing the RESET button on the remote control or the button ► of the projector displays a dialog. To reset the lamp time, select the RESET using the button ▲.</p> <p>RESET ⇔ CANCEL</p> <ul style="list-style-type: none"> • Please reset the lamp time only when you have replaced the lamp, for a suitable indication about the lamp. • For the lamp replacement, see the section "Lamp" (50, 51).
<p>FILTER TIME</p>	<p>The filter time is the time counted after the last resetting. It is shown in the OPTION menu as the usage time of the air filter. Pressing the RESET button on the remote control or the button ► of the projector displays a dialog. To reset the filter time, select the RESET using the button ▲.</p> <p>RESET ⇔ CANCEL</p> <ul style="list-style-type: none"> • Please reset the filter time only when you have cleaned or replaced the air filter, for a suitable indication about the air filter. • For the air filter cleaning, see the section "Air filter" (52, 53).
<p>MY BUTTON</p>	<p>Sets the assigned function for the MY BUTTON1 and 2 buttons on the included remote control.</p> <ul style="list-style-type: none"> • RGB1: Sets port to RGB1. • RGB2: Sets port to RGB2. • COMPONENT: Sets port to COMPONENT. • S-VIDEO: Sets port to S-VIDEO. • VIDEO: Sets port to VIDEO. • INFORMATION: Displays INPUT INFORMATION (43). • AUTO KEYSTONE EXECUTE: Performs automatic KEYSTONE correction (35). • MY MEMORY: Loads MY MEMORY settings (29). • PICTURE MODE: Changes the PICTURE mode (25). • FILTER RESET: Displays the filter time reset confirmation dialogue (41).

OPTION Menu (continued)

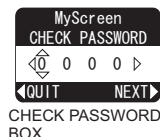
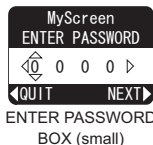
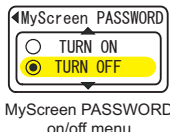
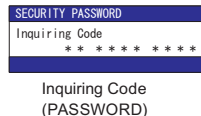
Item	Description
<p>SERVICE</p>	<p>REMOTE FREQ. Use the ▲/▼ button to change the Projector's remote sensor setting (16).</p> <p>1:NORMAL ⇔ 2:HIGH</p> <p>Items with a checkmark are on. The factory default setting is for both 1:NORMAL and 2:HIGH to be on. If the remote control does not function correctly set the this to either only 1 or only 2 as described in Remote Control Settings (16). Neither can be turned off at the same time.</p> <p>INFORMATION Selecting this item displays a dialog titled "INPUT INFORMATION". It shows the information about the current input.</p> <div style="display: flex; justify-content: space-around; align-items: flex-start;"> <div style="border: 1px solid black; padding: 5px; text-align: center; width: 30%;"> <p>◀ INPUT-INFORMATION</p> <p>RGB</p> <p>1024x768 @60Hz</p> <p>FRAME LOCK</p> </div> <div style="border: 1px solid black; padding: 5px; text-align: center; width: 30%;"> <p>◀ INPUT-INFORMATION</p> <p>S-VIDEO</p> <p>SECAM</p> <p>AUTO</p> </div> <div style="border: 1px solid black; padding: 5px; text-align: center; width: 30%;"> <p>◀ INPUT-INFORMATION</p> <p>COMPONENT</p> <p>576i @50</p> <p>SCART RGB</p> </div> </div> <ul style="list-style-type: none"> • The "FRAME LOCK" message on the dialog means the frame lock function is working. • The "SCART RGB" message means the COMPONENT VIDEO port is working as a SCART RGB input port. Please refer to the COMPONENT item in this menu. (33) • This item can't be selected for no signal and sync out. <p>FACTORY RESET Selecting RESET using the button ▲ performs this function. By this function, all the items in all of menus will collectively return to the initial setting. Note that the items LAMP TIME, FILTER TIME, LANGUAGE and OPTION_SECURITY are not reset.</p> <p>RESET ⇔ CANCEL</p>

OPTION Menu (continued)

Item	Description
<p align="center">SECURITY</p>	<p>This projector is equipped with security functions. User registration is required before using the security functions. Please contact your local dealer.</p> <p>1. Using Security Features</p> <p>1.1 Inputting the PASSWORD</p> <p>1.1-1 Use the ▲/▼ buttons on the OPTION menu to select SECURITY and press the ► button. The ENTER PASSWORD box will be displayed. The factory default PASSWORD is 3046. This PASSWORD can be changed (1.2 Changing the PASSWORD).</p> <div data-bbox="311 517 770 600" style="border: 1px solid black; padding: 5px; margin: 10px 0;"> <p>NOTE : It is strongly recommended the factory default PASSWORD to be changed as soon as possible.</p> </div> <p>1.1-2 Use the ▲/▼/◀/▶ buttons to enter the registered PASSWORD. Move the cursor to the right side of the ENTER PASSWORD BOX and press the ► button to display the SECURITY menu. If an incorrect PASSWORD is input the ENTER PASSWORD BOX will be displayed again. If incorrect PASSWORD is input 3 times the projector will turn off. Afterwards the projector will turn off every time an incorrect PASSWORD is input.</p> <p>1.2 Changing the PASSWORD</p> <p>1.2-1 Use the ▲/▼ buttons on the SECURITY menu to select SECURITY PASSWORD CHANGE and press the ► button to display the ENTER NEW PASSWORD BOX.</p> <p>1.2-2 Use the ▲/▼/◀/▶ buttons to enter the new PASSWORD.</p> <p>1.2-3 Move the cursor to the right side of the ENTER NEW PASSWORD BOX and press the ► button to display the NEW PASSWORD AGAIN BOX, enter the same PASSWORD again.</p> <p>1.2-4 Move the cursor to the right side of the NEW PASSWORD AGAIN BOX and press the ► button and the NOTE NEW PASSWORD BOX will be displayed for about 20 seconds, please make note of the PASSWORD during this time. Pressing the ENTER button on the remote controll or INPUT button on the projector will close the NOTE NEW PASSWORD BOX.</p> <div data-bbox="311 1474 781 1506" style="border: 1px solid black; padding: 5px; margin: 10px 0;"> <p>NOTE : Please do not forget your PASSWORD.</p> </div>
	 <p>ENTER PASSWORD BOX</p>
	 <p>SECURITY MENU</p>
	 <p>ENTER NEW PASSWORD BOX</p>
	 <p>NEW PASSWORD AGAIN BOX</p>
 <p>NOTE NEW PASSWORD BOX</p>	

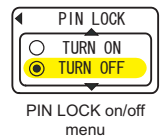
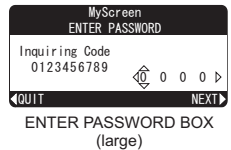
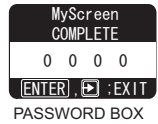
OPTION Menu (continued)

Item	Description
<p style="text-align: center;">SECURITY</p>	<p>1.3 If you have forgotten your PASSWORD</p> <p>1.3-1 Follow the procedure in 1.1-1 to display the ENTER PASSWORD BOX.</p> <p>1.3-2 While the ENTER PASSWORD BOX is displayed, press and hold the RESET button on the remote control for about 3 seconds or press and hold the INPUT and ► buttons on the projector for about 3 seconds. The 10 digit Inquiring Code will be displayed. NOTE: If there is no key input for about 55 seconds while the Inquiring Code is displayed the menu will close. If necessary repeat the process from 1.3-1.</p> <p>1.3-3 Contact your dealer with the 10 digit Inquiring Code. Your PASSWORD will be sent after your user registration information is confirmed.</p>
	<p>2. Using the MyScreen PASSWORD Function</p> <p>The MyScreen PASSWORD function can be used to prohibit access to the MyScreen function and prevent the currently registered MyScreen image from being overwritten.</p> <p>2.1 Turning on the MyScreen PASSWORD Function</p> <p>2.1-1 Use the ▲/▼ buttons on the SECURITY menu to select MyScreen PASSWORD and press the ► button to display the MyScreen PASSWORD on/off menu.</p>
	<p>2.2 Setting the PASSWORD</p> <p>2.2-1 Display the MyScreen on/off menu using the procedure in 2.1-1.</p> <p>2.2-2 Use the ▲/▼ buttons on the MyScreen PASSWORD on/off menu to select TURN ON. The ENTER PASSWORD BOX (small) will be displayed.</p>
	<p>2.2-3 Use the ▲/▼/◀/▶ buttons to enter the PASSWORD. Move the cursor to the right side of the ENTER PASSWORD BOX (small) and press the ► button to display the CHECK PASSWORD BOX, enter the same PASSWORD again.</p>

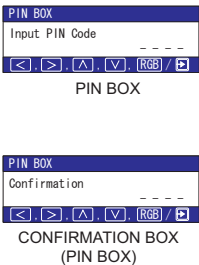
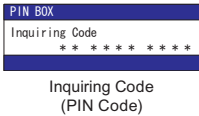


OPTION Menu (continued)

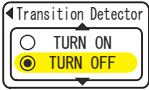



Item	Description
<p style="text-align: center;">SECURITY</p>	<p>2.2-4 Move the cursor to the right side of the CHECK PASSWORD BOX and press the ► button to display the PASSWORD for about 20 seconds, please make note of the PASSWORD during this time. After the PASSWORD has displayed for about 20 seconds the screen will return to the MyScreen PASSWORD on/off menu.</p> <p>Pressing the ENTER button on the remote control or INPUT button on the projector will close the PASSWORD box.</p> <p>When a PASSWORD is set for MyScreen:</p> <ul style="list-style-type: none"> • The MyScreen registration function (and menu) will be unavailable. • The START UP setting will be locked on MyScreen (and the menu will be unavailable). <p>Turning the MyScreen PASSWORD off will allow normal operation of both functions.</p> <div style="border: 1px solid black; padding: 5px; margin: 10px 0;"> <p>NOTE : Please do not forget your MyScreen PASSWORD.</p> </div>
	<p>2.3 Turning the PASSWORD off</p> <p>2.3-1 Follow the procedure in 2.1-1 to display the MyScreen PASSWORD on/off menu.</p> <p>2.3-2 Select TURN OFF to display the ENTER PASSWORD BOX (large). Enter the registered PASSWORD and the screen will return to the MyScreen on/off menu.</p> <p>If an incorrect PASSWORD is input the menu will close. If necessary repeat the process from 2.3-1.</p>
	<p>2.4 If you have forgotten your PASSWORD</p> <p>2.4-1 Follow the procedure in 2.1-1 to display the MyScreen PASSWORD on/off menu.</p> <p>2.4-2 Select TURN OFF to display the ENTER PASSWORD BOX (large). The 10 digit Inquiring Code will be displayed inside the BOX.</p> <p>2.4-3 Contact your dealer with the 10 digit Inquiring Code. Your PASSWORD will be sent after your user registration information is confirmed.</p>
	<p>3. Using the PIN LOCK Function</p> <p>PIN LOCK is a function which prevents the projector from being used unless a registered Code is input.</p> <p>3.1 Registering the PIN Code</p> <p>3.1-1 Use the ▲/▼ buttons on the SECURITY menu to select PIN LOCK and press the ► button or the ENTER button to display the PIN LOCK on/off menu.</p> <p>3.1-2 Use the ▲/▼ buttons on the PIN LOCK on/off menu to select TURN ON and the PIN BOX will be displayed.</p>



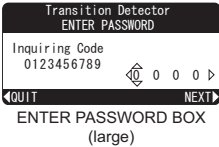
OPTION Menu (continued)

Item	Description
<p>SECURITY</p>	<p>3.1-3 Input a 4 part PIN Code using the ▲/▼/◀/▶ /RGB and INPUT buttons. A CONFIRMATION BOX will appear. Reenter the same PIN Code. This will complete the PIN Code registration.</p> <p>NOTE: If there is no key input for about 55 seconds while the PIN BOX or the CONFIRMATION BOX are displayed the menu will close. If necessary repeat the process from 3.1-1.</p> <p>Afterwards, anytime the projector is restarted after the power switch is turned off the PIN BOX will be displayed. Enter the registered PIN Code. The projector can be used after entering the registered PIN Code. If an incorrect PIN Code is input the PIN BOX will be displayed again. If an incorrect PIN Code is input 3 times the projector will turn off. Afterwards the projector will turn off every time an incorrect PIN Code is input. The projector will also turn off if there is no key input for about 5 minutes while the PIN BOX is displayed. This function will activate only when the projector is started after the power switch was turned off.</p> <div style="border: 1px solid black; padding: 2px; width: fit-content; margin: 10px auto;"> <p>NOTE : Please do not forget your PIN Code.</p> </div> <p>3.2 Turning Off the PIN LOCK Function</p> <p>3.2-1 Follow the procedure in 3.1-1 to display the PIN LOCK on/off menu. Use the ▲/▼ buttons to select TURN OFF and the PIN BOX will be displayed. Enter the registered PIN Code to turn the PIN LOCK function off. If an incorrect PASSWORD is entered the menu will close.</p> <p>3.3 If you have forgotten your PIN Code</p> <p>3.3-1 While the PIN BOX is displayed, press and hold the RESET button for three seconds or press and hold the INPUT and ► buttons for three seconds. The 10 digit Inquiring Code will be displayed.</p> <p>NOTE: If there is no key input for about 5 minutes while the Inquiring Code is displayed the projector will turn off.</p> <p>3.3-2 Contact your dealer with the 10 digit Inquiring Code. Your PASSWORD will be sent after your user registration information is confirmed.</p>
	 <p>The image shows two screenshots of the projector's menu interface. The first screenshot is titled 'PIN BOX' and shows 'Input PIN Code' followed by four dashes. Below the input field are navigation buttons: left arrow, right arrow, up arrow, down arrow, and a button labeled 'RGB' with a right arrow. The second screenshot is titled 'PIN BOX' and shows 'Confirmation' followed by four dashes. It has the same navigation buttons as the first screenshot. Below the second screenshot is the text 'CONFIRMATION BOX (PIN BOX)'.</p>
 <p>The image shows a screenshot of the projector's menu interface titled 'PIN BOX'. It displays 'Inquiring Code' followed by ten asterisks. Below the input field are navigation buttons: left arrow, right arrow, up arrow, down arrow, and a button labeled 'RGB' with a right arrow. Below the screenshot is the text 'Inquiring Code (PIN Code)'.</p>	

OPTION Menu (continued)

Item	Description
<p style="text-align: center;">SECURITY</p>	<p>4. Using the Transition Detector Function</p> <p>While the Transition Detector function is ON, when power switch is started to supply to the projector, it might react as below.</p> <ul style="list-style-type: none"> • Transition Detector alarm shown below might appear on screen, if the projector has been moved or re-installed. • Transition Detector alarm might appear on screen, if the MIRROR setting has been changed. • Keystone adjustment feature has been prohibited as long as the Transition Detector function is ON. <p>4.1 Turning On the Transition Detector Function</p> <p>4.1-1 Use the ▲/▼ buttons on the SECURITY menu to select Transition Detector and press the ► or the ENTER button to display the Transition Detector on/off menu. Select TURN ON and the current angle, mirror and keystone setting will be recorded.</p> <p>NOTE: This feature may not function properly if the projector is not in a stable position when TURN ON is selected.</p> <p>4.1-2 If this function is set to TURN ON when the vertical angle of the projector, mirror or keystone setting at which the projector is turned on is different than the previously recorded the Transition Detector Alarm will be displayed and the projector will not display the input signal.</p> <p>Either set the Transition Detector off in the SECURITY menu or set the projector at the recorded angle, mirror and keystone setting to display the input signal. If the Transition Detector ALARM is displayed for about 5 minutes the lamp will turn off. This function will activate only when the projector is started after the power switch was turned off.</p> <p>4.2 Setting the Transition Detector PASSWORD</p> <p>4.2-1 Use the ▲/▼ buttons on the SECURITY menu to select Transition Detector and press the ► or the ENTER button to display the Transition Detector on/off menu.</p> <p>4.2-2 Use the ▲/▼ buttons on the Transition Detector on/off menu to select TURN ON. The ENTER PASSWORD BOX (small) will be displayed.</p> <p>4.2-3 Use the ▲/▼/◀/▶ buttons to enter a PASSWORD. Move the cursor to the right side of the ENTER PASSWORD BOX (small) and press the ► button to display the CHECK PASSWORD BOX, enter the same PASSWORD again.</p> <p>4.2-4 Move the cursor to the right side of the CHECK PASSWORD BOX and press the ► button to display the PASSWORD for about 20 seconds, please make note of the PASSWORD during this time. After the PASSWORD has displayed for about 20 seconds the screen will return to the Transition Detector on/off menu.</p> <p>Pressing the ENTER button on the remote control or the INPUT button on the projector will close the PASSWORD BOX.</p> <p>NOTE : Please do not forget your Transition Detector PASSWORD.</p>
	<div style="display: flex; justify-content: space-between;"> <div style="width: 65%;">  <p style="text-align: center;">Transition Detector on/off menu</p> </div> <div style="width: 30%;"> <p style="text-align: center;"><<TRANSITION DETECTOR ON>></p> <p style="font-size: small;">The projector has been transferred from previously installed position.</p> <p style="font-size: x-small;">If you wish to have a square image on screen again, disable Transition Detector on Menu.</p> <p style="text-align: center;">Transition Detector Alarm</p> </div> </div> <div style="display: flex; justify-content: space-between;"> <div style="width: 65%;"> <p>4.2-1 Use the ▲/▼ buttons on the SECURITY menu to select Transition Detector and press the ► or the ENTER button to display the Transition Detector on/off menu.</p> <p>4.2-2 Use the ▲/▼ buttons on the Transition Detector on/off menu to select TURN ON. The ENTER PASSWORD BOX (small) will be displayed.</p> <p>4.2-3 Use the ▲/▼/◀/▶ buttons to enter a PASSWORD. Move the cursor to the right side of the ENTER PASSWORD BOX (small) and press the ► button to display the CHECK PASSWORD BOX, enter the same PASSWORD again.</p> <p>4.2-4 Move the cursor to the right side of the CHECK PASSWORD BOX and press the ► button to display the PASSWORD for about 20 seconds, please make note of the PASSWORD during this time. After the PASSWORD has displayed for about 20 seconds the screen will return to the Transition Detector on/off menu.</p> </div> <div style="width: 30%;">  <p style="text-align: center;">ENTER PASSWORD BOX (small)</p>  <p style="text-align: center;">CHECK PASSWORD BOX</p>  <p style="text-align: center;">PASSWORD BOX</p> </div> </div>

OPTION Menu (continued)

Item	Description
<p>SECURITY</p>	<p>4.3 Setting the Transition Detector off</p>
	<p>4.3-1 Follow the procedure in 4.1-1 to display the Transition Detector on/off menu.</p>
	<p>4.3-2 Select TURN OFF to display the ENTER PASSWORD BOX (large). Enter the registered PASSWORD and the screen will return to the Transition Detector on/off menu. If an incorrect PASSWORD is input the menu will close. If necessary repeat the process from 4.3-1.</p>
	<p>4.4 If you have forgotten your PASSWORD</p>
<p>4.4-1 Follow the procedure in 4.1-1 to display the Transition Detector on/off menu.</p>	
<p>4.4-2 Select TURN OFF to display the ENTER PASSWORD BOX (large). The 10 digit Inquiring Code will be displayed inside the BOX.</p>	
<p>4.4-3 Contact your dealer with the 10 digit Inquiring Code. Your PASSWORD will be sent after your user registration information is confirmed.</p>	

Maintenance

Lamp

 **WARNING** HIGH VOLTAGE HIGH TEMPERATURE HIGH PRESSURE

► The projector uses a high-pressure mercury glass lamp. The lamp can break with a loud bang, or burn out, if jolted or scratched, handled while hot, or worn over time. Note that each lamp has a different lifetime, and some may burst or burn out soon after you start using them. In addition, when the bulb bursts, it is possible for shards of glass to fly into the lamp housing, and for gas containing mercury to escape from the projector's vent holes.

► **About disposal of a lamp** • This product contains a mercury lamp; do not put it in a trash. Dispose of it in accordance with environmental laws. For lamp recycling, go to www.lamprecycle.org. (in the US) For product disposal, contact your local government agency or www.eiae.org (in the US) or www.epsc.ca (in Canada). For more information, call your dealer.



Disconnect the plug from the power outlet

- If the lamp should break (it will make a loud bang when it does), unplug the power cord from the outlet, and make sure to request a replacement lamp from your local dealer. Note that shards of glass could damage the inside of the projector, or cause injury during handling, so please do not try to clean the projector or replace the lamp yourself.

- If the lamp should break (it will make a loud bang when it does), ventilate the room well, and make sure not to breathe the gas that comes out of the projector vents, or get it in your eyes or mouth.
- Before replacing the lamp, turn the projector off and unplug the power cord, then wait at least 45 minutes for the lamp to cool sufficiently. Handling the lamp while hot can cause burns, as well as damaging the lamp.



- Never unscrew except the appointed (marked by an arrow) screws.
- Do not open the lamp cover while the projector is suspended from the ceiling. This is dangerous, since if the lamp's bulb has broken, the shards will fall out when the cover is opened. In addition, working in high places is dangerous, so ask your local dealer to have the lamp replaced even if the bulb is not broken.

- Do not use the projector with the lamp cover removed. To replace the lamp, make sure that the screws are tightened firmly. Loose screws could result in damage or injury.



- Use only the lamp of the specified type.
- If the lamp breaks soon after the first time it is used, it is possible that there are electrical problems elsewhere besides the lamp. If this happens, contact your local dealer or a service representative.
- Handle with care: jolting or scratching could cause the lamp bulb to burst during use.
- Using the lamp for long periods of time, could cause it dark, not to light up or to burst. When the pictures appear dark, or when the color tone is poor, please replace the lamp as soon as possible. Do not use old (used) lamps; this is a cause of breakage.

Lamp (continued)

A lamp has a finite product life. Using the lamp for long periods of time could cause the pictures darker or the color tone poor. Note that each lamp has a different lifetime, and some may burst or burn out soon after you start using them. Preparation of a new lamp and early replacement are recommended.

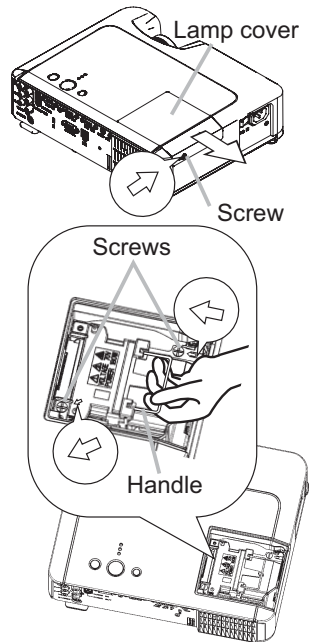
To prepare a new lamp, contact your dealer and tell the lamp type number.

Type number = DT00757.

1. Turn the projector off, and unplug the power cord. Allow the lamp to cool for at least 45 minutes.
2. Prepare a new lamp.
 - If the projector is mounted on the ceiling, or if the lamp has broken, also ask the dealer to replace the lamp.

In the case of replacement by yourself,

3. Loosen the lamp cover screw (marked by arrow) and then slide the lamp cover to the side to remove it.
4. Loosen the 2 screws (marked by arrow) of the lamp, and slowly pick up the lamp by the handles.
5. Insert the new lamp, and retighten firmly the two screws that are loosened in the previous process to lock it in place.
6. Slide the lamp cover back in place and firmly fasten the lamp cover a screw.
7. Turn the projector on and reset the lamp time using the LAMP TIME function in the OPTION menu (41).



- (1) Press the MENU button to display a menu. Only when the EASY MENU has appeared, please perform the next step (2).
- (2) Point at the "Go to Advanced Menu ..." in the menu using ▼/▲ button, then press the ► button.
- (3) Point at the "OPTION" in the left column of the menu using ▼/▲ button, then press the ► button.
- (4) Point at the "LAMP TIME" using ▼/▲ button, then press the ► button. A dialog will appear.
- (5) Press the ▲ button to select "RESET" on the dialog. It performs resetting the lamp time.

NOTE • Please reset the lamp time only when you have replaced the lamp, for a suitable indication about the lamp.

Air filter

⚠WARNING ▶ Before caring, make sure the power switch is off and the power cable is not plugged in, then allow the projector to cool sufficiently. The care in a high temperature state of the projector could cause an electric shock, a burn and/or malfunction to the projector.

▶ Use only the air filter of the specified type. Do not use the projector with the air filter and the filter cover removed. It could result in a fire and/or malfunction to the projector.

▶ The air filter should be cleaned periodically. If the air filter becomes clogged by dust or the like, internal temperatures rise and could cause a fire, a burn and/or malfunction to the projector.

NOTE • Please replace the air filter when it is damaged or too soiled, and also when you replace the lamp.

• Please reset the filter time only when you have cleaned or replaced the air filter, for a suitable indication about the air filter. (41)

• The projector may display the message such as “CHECK THE AIR FLOW” or turn off the projector, to prevent the internal heat level rising.

If the air filter becomes clogged by dust or the like, internal temperatures rise and could cause a fire, a burn and/or malfunction to the projector. When the indicators or a message prompts you to clean the air filter, clean the air filter as soon as possible.

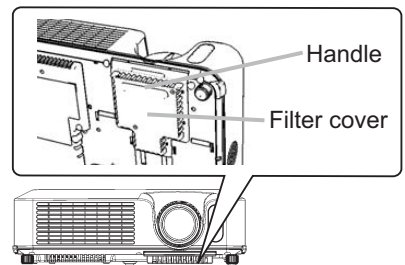
Please check and clean the air filter periodically, even if there is no message. Please replace the air filter when it is damaged or too soiled. Preparation of a new air filter is recommended.

To prepare a new air filter, contact your dealer and tell the air filter type number.

Type number = NJ22222

And also when you replace the lamp, please replace the air filter. An air filter of specified type will come together with a replacement lamp for this projector.

1. Turn the projector off, and unplug the power cord. Allow the lamp to cool for at least 45 minutes.
2. When the projector is suspended from the ceiling, apply the vacuum cleaner to and around the filter cover first, to prevent penetration of dust or the like.
3. While supporting the projector with one hand, use your other hand to pull the filter cover forward in the direction of the arrow. Remove the air filter.



Air filter (continued)

4. Apply a vacuum cleaner to the air filter and the filter cover. Please replace the air filter when it is damaged or too soiled.

5. Replace the air filter in its original position. Secure the air filter in place by pressing each of the six ▶ locations. Make sure there is no dust or dirt remaining after the cover is in place. If any dust or dirt remains use a vacuum cleaner to remove it as when placing the filter cover on the air filter.

Reattach the filter cover to the projector by aligning the filter cover with the grooves on the projector. While holding the handle, push down on the filter cover until it locks firmly in place.

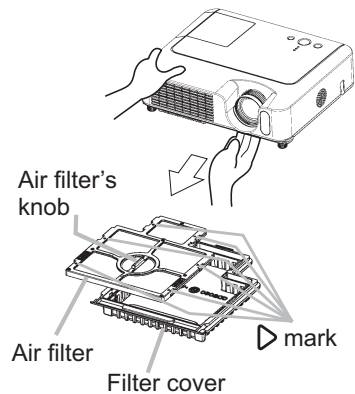
6. Turn the projector on and reset the filter time using the FILTER TIME function in the OPTION menu (41).

(1) Press the MENU button to display a menu. When the EASY MENU has appeared, please skip the next step (2).

(2) Point at the "OPTION" in the left column of the menu using ▼/▲ button, then press the ▶ button.

(3) Point at the "FILTER TIME" using ▼/▲ button, then press the ▶ button. A dialog will appear.

(4) Press the ▲ button to select "RESET" on the dialog. It performs resetting the filter time.



Other care

⚠ WARNING ▶ Before caring, make sure the power switch is off and the power cable is not plugged in, and then allow the projector to cool sufficiently. The care in a high temperature state of the projector could cause a burn and/or malfunction to the projector.

▶ Never try to care for the inside of the projector personally. Doing is so dangerous.

▶ Avoid wetting the projector or inserting liquids in the projector. It could result in a fire, an electric shock, and/or malfunction to the projector.

- Do not put a container containing water, cleaner or chemicals near the projector.

- Do not use aerosols or sprays.

⚠ CAUTION ▶ Please take right care of the projector according to the following. Incorrect care could cause not only an injury but adverse influence such as discoloration, peeling paint, etc.

▶ Do not use cleaner or chemicals other than those listed below.

▶ Do not polish or wipe with hard objects.

Inside of the projector

In order to ensure the safe use of your projector, please have it cleaned and inspected by your dealer about once every year.

Caring for the lens

If the lens is flawed, soiled or fogged, it could cause deterioration of display quality. Please take care of the lens, being cautious of handling.

1. Turn the projector off, and unplug the power cord. Allow the projector to cool sufficiently.
2. After making sure that the projector is cool adequately, lightly wipe the lens with a commercially available lens-cleaning wipe. Do not touch the lens directly with your hand.

Caring for the cabinet and remote control

Incorrect care could have adverse influence such as discoloration, peeling paint, etc.

1. Turn the projector off, and unplug the power cord. Allow the projector to cool sufficiently.
2. After making sure that the projector is cool adequately, lightly wipe with gauze or a soft cloth.

If soiling is severe, dip soft cloth in water or a neutral cleaner diluted in water, and wipe lightly after wringing well. Then, wipe lightly with a soft, dry cloth.

Troubleshooting

Related messages

When the unit's power is on, messages such as those shown below may be displayed. When any such message is displayed on the screen, please follow the instructions described below. If the same message is displayed after the remedy, or if a message other than the following appears, please contact your dealer or service company.

Although these messages will be automatically disappeared around several minutes, it will be reappeared every time the power is turned on.

Message	Description
<div style="border: 1px solid black; padding: 5px; text-align: center;"> NO INPUT IS DETECTED *** </div>	<p>There is no input signal. Please confirm the signal input connection, and the status of the signal source.</p>
<div style="border: 1px solid black; padding: 5px;"> <p>SYNC IS OUT OF RANGE *** [fH] **kHz [V] **Hz</p> </div>	<p>The horizontal or vertical frequency of the input signal is not within the specified range. Please confirm the specs for your projector or the signal source specs.</p>
<p style="text-align: center;">CHECK THE AIR FLOW</p>	<p>The internal temperature is rising. Please turn the power off, and allow the projector to cool down at least 20 minutes. After having confirmed the following items, please turn the power ON again.</p> <ul style="list-style-type: none"> • Is there blockage of the air passage aperture? • Is the air filter dirty? • Does the peripheral temperature exceed 35°C? <p>If the same indication is displayed after the remedy, please set FAN SPEED of the SERVICE item in the OPTION menu to HIGH.</p>
<p style="text-align: center;">REMINDER *** HRS PASSED AFTER THE LAST FILTER CHECK. FILTER MAINTENANCE IS ESSENTIAL TO REMOVE WARNING MESSAGE, RESET FILTER TIMER. SEE MANUAL FURTHER INFO.</p>	<p>A note of precaution when cleaning the air filter. Please immediately turn the power off, and clean or change the air filter referring to the "Air Filter" section of this manual (452). After you have cleaned or changed the air filter, please be sure to reset the filter timer (441).</p>

Regarding the indicator lamps

Lighting and flashing of the POWER indicator, the LAMP indicator, and the TEMP indicator have the meanings as described in the table below. Please follow the instructions within the table. If the same indication is displayed after the remedy, or if an indication other than the following is displayed, please contact your dealer or service company.

POWER indicator	LAMP indicator	TEMP indicator	Description
Lighting In Orange	Turned off	Turned off	The projector is in a standby state. Please refer to the section "Power On/Off".
<i>Blinking</i> In Green	Turned off	Turned off	The projector is warming up. Please wait.
Lighting In Green	Turned off	Turned off	The projector is in an on state. Ordinary operations may be performed.
<i>Blinking</i> In Orange	Turned off	Turned off	The projector is cooling down. Please wait.
<i>Blinking</i> In Red	(discretionary)	(discretionary)	The projector is cooling down. A certain error has been detected. Please wait until the POWER indicator finishes blinking, and then perform the proper measure using the item descriptions below.
<i>Blinking</i> In Red or Lighting In Red	Lighting In Red	Turned off	The lamp does not light, and there is a possibility that interior portion has become heated. Please turn the power off, and allow the projector to cool down at least 20 minutes. After the projector has sufficiently cooled down, please make confirmation of the following items, and then turn the power on again. <ul style="list-style-type: none"> • Is there blockage of the air passage aperture? • Is the air filter dirty? • Does the peripheral temperature exceed 35°C? If the same indication is displayed after the remedy, please change the lamp referring to the section "Lamp".
<i>Blinking</i> In Red or Lighting In Red	<i>Blinking</i> In Red	Turned off	The lamp cover has not been properly fixed. Please turn the power off, and allow the projector to cool down at least 45 minutes. After the projector has sufficiently cooled down, please make confirmation of the attachment state of the lamp cover. After performing any needed maintenance, turn the power on again. If the same indication is displayed after the remedy, please contact your dealer or service company.

Regarding the indicator lamps (continued)

POWER indicator	LAMP indicator	TEMP indicator	Description
Blinking In Red or Lighting In Red	Turned off	Blinking In Red	The cooling fan is not operating. Please turn the power off, and allow the projector to cool down at least 20 minutes. After the projector has sufficiently cooled down, please make confirmation that no foreign matter has become caught in the fan, etc., and then turn the power on again. If the same indication is displayed after the remedy, please contact your dealer or service company.
Blinking In Red or Lighting In Red	Turned off	Lighting In Red	There is a possibility that the interior portion has become heated. Please turn the power off, and allow the projector to cool down at least 20 minutes. After the projector has sufficiently cooled down, please make confirmation of the following items, and then turn the power on again. <ul style="list-style-type: none"> • Is there blockage of the air passage aperture? • Is the air filter dirty? • Does the peripheral temperature exceed 35°C? If the same indication is displayed after the remedy, please set FAN SPEED of the SERVICE item in the OPTION menu to HIGH.
Lighting In Green	Simultaneous blinking in Red		It is time to clean the air filter. Please immediately turn the power off, and clean or change the air filter referring to the section "Air Filter". After cleaning or changing the air filter, please be sure to reset the filter timer. After the remedy, reset the power to ON.
Lighting In Green	Alternative blinking in Red		There is a possibility that the interior portion has become overcooled. Please use the unit within the usage temperature parameters (5°C to 35°C). After the treatment, reset the power to ON.

NOTE • When the interior portion has become overheated, for safety purposes, the power source is automatically turned off, and the indicator lamps may also be turned off. In such a case, press the "O" (OFF) side of the power switch, and wait at least 45 minutes. After the projector has sufficiently cooled down, please make confirmation of the attachment state of the lamp and lamp cover, and then turn the power on again.

Phenomena that may be easy to be mistaken for machine defects

⚠WARNING ▶ Never use the projector if abnormal operations such as smoke, strange odor, excessive sound, damaged casing or elements or cables, penetration of liquids or foreign matter, etc. should occur. In such cases, immediately turn off the power switch and then disconnect the power plug from the power outlet. After making sure that the smoke or odor has stopped, contact your dealer or service company.

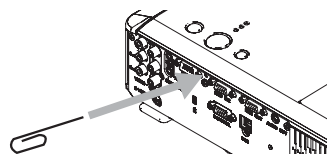
1. Before requesting repair, please check in accordance with the following chart. This operation sometimes resolves your problem.

If the situation cannot be corrected,

2. The projector's microprocessor may need to be reset. Please push the Restart switch by using a cocktail stick or similar and the projector will restart.

3. Some setting may be wrong. Please use the FACTORY RESET function of the SERVICE item in the OPTION menu (U43) to reset all settings to factory default.

Then, if the problem is not removed after the remedy, please contact your dealer or service company.



Phenomenon	Cases not involving a machine defect	Reference page
Power does not come on.	The electrical power cord is not plugged in. Correctly connect the power cord.	14
	The power switch is not set to the on position. Set the power switch to [] (On).	17
	The main power source has been interrupted during operation such as by a power outage (blackout), etc. Please turn the power off, and allow the projector to cool down at least 2 minutes, then turn the power on again.	17
	Either there is no lamp and/or lamp cover, or either of these has not been properly fixed. Please turn the power off, and allow the projector to cool down at least 45 minutes. After the projector has sufficiently cooled down, please make confirmation of the attachment state of the lamp and lamp cover, and then turn the power on again.	56, 57
Neither sounds nor pictures are outputted.	The signal cables are not correctly connected. Correctly connect the connection cables.	12, 13
	Signal source does not correctly work. Correctly set up the signal source device by referring to the manual of the source device.	—
	The input changeover settings are mismatched. Select the input signal, and correct the settings.	18, 19

Phenomena that may be easy to be mistaken for machine defects (continued)

Phenomenon	Cases not involving a machine defect	Reference page
Sound does not come out.	<p>The signal cables are not correctly connected. Correctly connect the audio cables.</p>	12,13
	<p>The MUTE function is working. Restore the sound pressing the MUTE or VOLUME button on the remote control.</p>	18
	<p>The volume is adjusted to an extremely low level. Adjust the volume to a higher level using the menu function or the remote control.</p>	18
	<p>The AUDIO setting is not correct. Correctly set the AUDIO item in the SETUP menu.</p>	36
No pictures are displayed.	<p>The lens cap is attached. Remove the lens cover.</p>	17
	<p>The signal cables are not correctly connected. Correctly connect the connection cables.</p>	12, 13
	<p>The brightness is adjusted to an extremely low level. Adjust BRIGHTNESS to a higher level using the menu function or the remote control.</p>	25
	<p>The computer cannot detect the projector as a plug and play monitor. Make sure that the computer can detect a plug and play monitor using another plug and play monitor.</p>	11
	<p>The BLANK screen is displayed. Press the BLANK button on the remote control.</p>	22
Video screen display freezes.	<p>The FREEZE function is working. Press the FREEZE button to restore the screen to normal.</p>	22
Colors have a faded- out appearance, or Color tone is poor.	<p>Color settings are not correctly adjusted. Perform picture adjustments by changing the COLOR TEMP, COLOR, TINT and/or COLOR SPACE settings, using the menu functions.</p>	26, 28, 32
	<p>COLOR SPACE setting is not suitable. Change the COLOR SPACE setting to AUTO, RGB, SMPTE240, REC709 or REC601.</p>	32

Phenomena that may be easy to be mistaken for machine defects (continued)

Phenomenon	Cases not involving a machine defect	Reference page
Pictures appear dark.	The brightness and/or contrast are adjusted to an extremely low level. Adjust BRIGHTNESS and/or CONTRAST settings to a higher level using the menu function.	25, 26
	The WHISPER function is working. Select BRIGHT for the WHISPER item in the SETUP menu.	26, 35
	The lamp is approaching the end of its product lifetime. Replace the lamp.	50, 51
Pictures appear blurry.	Either the focus and/or horizontal phase settings are not properly adjusted. Adjust the focus using the focus ring, and/or H PHASE using the menu function.	19, 30
	The lens is dirty or misty. Clean the lens referring to the section "Caring for the lens".	54

NOTE • Although bright spots or dark spots may appear on the screen, this is a unique characteristic of liquid crystal displays, and it does not constitute or imply a machine defect.

Warranty and after-service

If a problem occurs with the equipment, first refer to the “Troubleshooting” and run through the suggested checks. If this does not resolve the problem, please contact your dealer or service company. They will tell you what warranty condition is applied.

Specifications

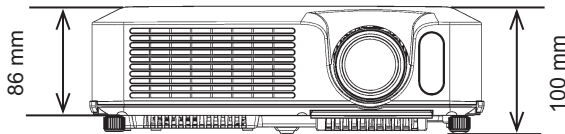
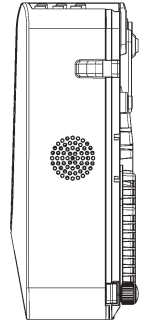
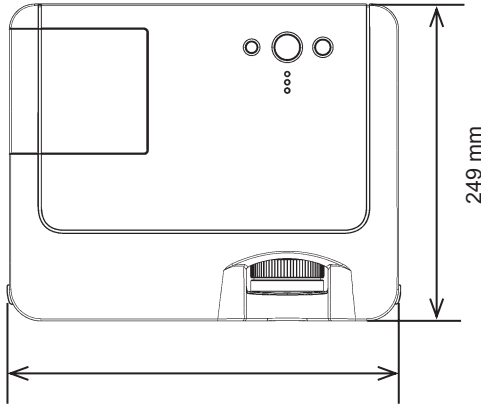
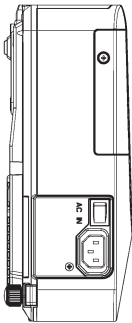
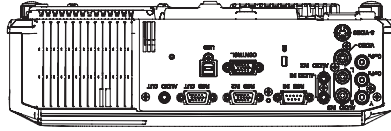
Specifications

NOTE • These specifications are subject to change without notice.

Item		Specification
Product name		Liquid crystal projector
Liquid Crystal panel	Panel size	1.6 cm (0.63 type)
	Drive system	TFT active matrix
	Pixels	786,432 pixels (1024 horizontal x 768 vertical)
Lens		Zoom lens F=1.7 ~ 1.9 f=18.9 ~ 22.6 mm
Lamp		200W UHB
Speaker		1W x 1
Power Supply		AC100-120V/3.3A, AC220-240V/1.4A
Power Consumption		310W
Temperature range		5 ~ 35°C (Operating)
Size		306 (W) x 86 (H) x 249 (D) mm (Not including protruding parts) • Please refer to the following figure.
Weight (mass)		3.0 kg
Ports		RGB input: RGB IN1 ..D-sub 15pin mini x1 RGB IN2 ..D-sub 15pin mini x1 RGB output: RGB OUT ..D-sub 15pin mini x1 Audio input: AUDIO 1Stereo mini x1 AUDIO 2Stereo mini x1 AUDIO 3 RCA x2 Audio output: AUDIO OUTStereo mini x1 Video input: COMPONENT VIDEO (Y, Cb/Pb, Cr/Pr)..... RCA x3 S-VideoMini DIN x1 Video RCA x1 Communication port: CONTROL..... D-sub 9pin x1 USBUSB(B) x1
Optional parts	Lamp	DT00757
	Air filter	NJ22222
	Others	• Please consult your dealer.

Specifications

Specifications (continued)



Projector

ED-X10/ED-X12

User's Manual – Operating Guide

Technical

Example of computer signal

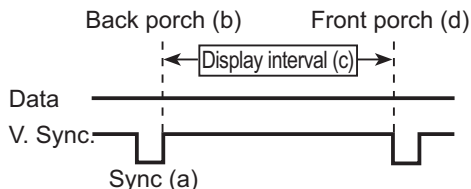
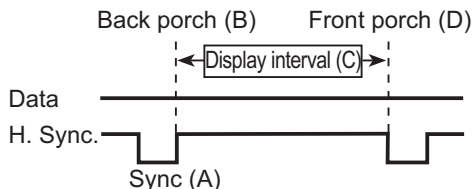
Resolution (H x V)	H. frequency (kHz)	V. frequency (Hz)	Rating	Signal mode
720 x 400	37.9	85.0	VESA	TEXT
640 x 480	31.5	59.9	VESA	VGA (60Hz)
640 x 480	37.9	72.8	VESA	VGA (72Hz)
640 x 480	37.5	75.0	VESA	VGA (75Hz)
640 x 480	43.3	85.0	VESA	VGA (85Hz)
800 x 600	35.2	56.3	VESA	SVGA (56Hz)
800 x 600	37.9	60.3	VESA	SVGA (60Hz)
800 x 600	48.1	72.2	VESA	SVGA (72Hz)
800 x 600	46.9	75.0	VESA	SVGA (75Hz)
800 x 600	53.7	85.1	VESA	SVGA (85Hz)
832 x 624	49.7	74.5		Mac 16" mode
1024 x 768	48.4	60.0	VESA	XGA (60Hz)
1024 x 768	56.5	70.1	VESA	XGA (70Hz)
1024 x 768	60.0	75.0	VESA	XGA (75Hz)
1024 x 768	68.7	85.0	VESA	XGA (85Hz)
1152 x 864	67.5	75.0	VESA	1152 x 864 (75Hz)
1280 x 960	60.0	60.0	VESA	1280 x 960 (60Hz)
1280 x 1024	64.0	60.0	VESA	SXGA (60Hz)
1280 x 1024	80.0	75.0	VESA	SXGA (75Hz)
1280 x 1024	91.1	85.0	VESA	SXGA (85Hz)
1600 x 1200	75.0	60.0	VESA	UXGA (60Hz)
1280 x 768	47.7	60.0	VESA	W-XGA (60Hz)
1400 x 1050	65.2	60.0	VESA	SXGA+ (60Hz)

- NOTE**
- Be sure to check jack type, signal level, timing and resolution before connecting this projector to a computer.
 - Some computers may have multiple display screen modes. Use of some of these modes will not be possible with this projector.
 - Depending on the input signal, full-size display may not be possible in some cases. Refer to the number of display pixels above.
 - Although the projector can display signals with resolution up to UXGA (1600x1200), the signal will be converted to the projector's panel resolution before being displayed. The best display performance will be achieved if the resolutions of the input signal and projector panel are identical.
 - Automatically adjustment may not function correctly with some input signals.
 - The image may not be displayed correctly when the input sync signal is a composite sync or a sync on G.

Example of computer signal

Initial set signals

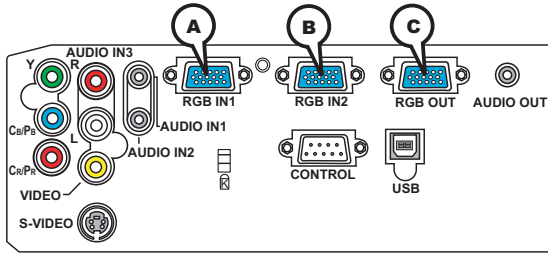
The following signals are used for the initial settings. The signal timing of some computer models may be different. In such case, adjust the items V POSITION and H POSITION in the IMAGE menu.



Computer/ Signal	Horizontal signal timing (μs)			
	(A)	(B)	(C)	(D)
TEXT	2.0	3.0	20.3	1.0
VGA (60Hz)	3.8	1.9	25.4	0.6
VGA (72Hz)	1.3	4.1	20.3	0.8
VGA (75Hz)	2.0	3.8	20.3	0.5
VGA (85Hz)	1.6	2.2	17.8	1.6
SVGA (56Hz)	2.0	3.6	22.2	0.7
SVGA (60Hz)	3.2	2.2	20.0	1.0
SVGA (72Hz)	2.4	1.3	16.0	1.1
SVGA (75Hz)	1.6	3.2	16.2	0.3
SVGA (85Hz)	1.1	2.7	14.2	0.6
Mac 16" mode	1.1	3.9	14.5	0.6
XGA (60Hz)	2.1	2.5	15.8	0.4
XGA (70Hz)	1.8	1.9	13.7	0.3
XGA (75Hz)	1.2	2.2	13.0	0.2
XGA (85Hz)	1.0	2.2	10.8	0.5
1152 x 864 (75Hz)	1.2	2.4	10.7	0.6
1280 x 960 (60Hz)	1.0	2.9	11.9	0.9
SXGA (60Hz)	1.0	2.3	11.9	0.4
SXGA (75Hz)	1.1	1.8	9.5	0.1
SXGA (85Hz)	1.0	1.4	8.1	0.4
UXGA (60Hz)	1.2	1.9	9.9	0.4
W-XGA (60Hz)	1.7	2.5	16.0	0.8
SXGA+ (60Hz)	1.2	2.0	11.4	0.7

Computer/ Signal	Vertical signal timing (lines)			
	(a)	(b)	(c)	(d)
TEXT	3	42	400	1
VGA (60Hz)	2	33	480	10
VGA (72Hz)	3	28	480	9
VGA (75Hz)	3	16	480	1
VGA (85Hz)	3	25	480	1
SVGA (56Hz)	2	22	600	1
SVGA (60Hz)	4	23	600	1
SVGA (72Hz)	6	23	600	37
SVGA (75Hz)	3	21	600	1
SVGA (85Hz)	3	27	600	1
Mac 16" mode	3	39	624	1
XGA (60Hz)	6	29	768	3
XGA (70Hz)	6	29	768	3
XGA (75Hz)	3	28	768	1
XGA (85Hz)	3	36	768	1
1152 x 864 (75Hz)	3	32	864	1
1280 x 960 (60Hz)	3	36	960	1
SXGA(60Hz)	3	38	1024	1
SXGA (75Hz)	3	38	1024	1
SXGA (85Hz)	3	44	1024	1
UXGA (60Hz)	3	46	1200	1
W-XGA (60Hz)	3	23	768	1
SXGA+ (60Hz)	3	33	1050	1

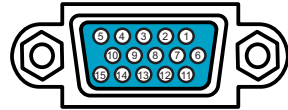
Connection to the ports



Ⓐ RGB IN1, Ⓑ RGB IN2, Ⓒ RGB OUT

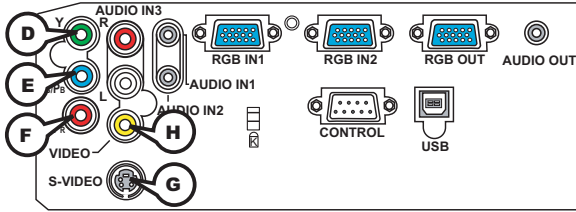
D-sub 15pin mini shrink jack

- Video signal: RGB separate, Analog, 0.7Vp-p, 75Ω terminated (positive)
- H/V. sync. Signal: TTL level (positive/negative)
- Composite sync. Signal: TTL level



At RGB signal

Pin	Signal
1	Video Red
2	Video Green
3	Video Blue
4	(No connection)
5	Ground
6	Ground Red
7	Ground Green
8	Ground Blue
9	(No connection)
10	Ground
11	(No connection)
12	Ⓐ: SDA (DDC data), Ⓑ/Ⓒ : (No connection)
13	H. sync / Composite sync.
14	V. sync.
15	Ⓐ: SCL (DDC clock), Ⓑ/Ⓒ : (No connection)



COMPONENT VIDEO (D)Y, (E)CB/PB, (F)CR/PR

RCA jack x3

- System: 525i(480i), 525p(480p), 625i(576i), 750p(720p), 1125i(1080i)

Port	Signal
Y	Component video Y, $1.0 \pm 0.1V_{p-p}$, 75Ω terminator with composite
CB/PB	Component video CB/PB, $0.7 \pm 0.1V_{p-p}$, 75Ω terminator
CR/PR	Component video CR/PR, $0.7 \pm 0.1V_{p-p}$, 75Ω terminator

(G)S-VIDEO

Mini DIN 4pin jack

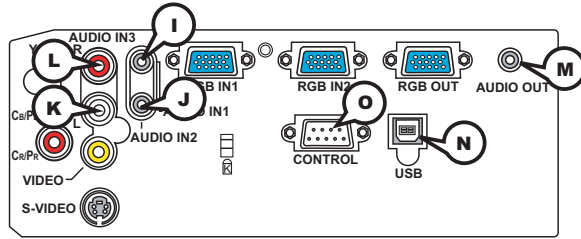


Pin	Signal
1	Color signal $0.286V_{p-p}$ (NTSC, burst), 75Ω terminator Color signal $0.300V_{p-p}$ (PAL/SECAM, burst) 75Ω terminator
2	Brightness signal, $1.0V_{p-p}$, 75Ω terminator
3	Ground
4	Ground

(H)VIDEO

RCA jack

- System: NTSC, PAL, SECAM, PAL-M, PAL-N, NTSC4.43
- $1.0 \pm 0.1V_{p-p}$, 75Ω terminator



I **AUDIO IN-1** (Ø3.5 stereo mini jack), **J** **AUDIO IN-2**, **K** **L** **AUDIO 3 L/R** (RCA jack)

- 200mVrms(max.) 35kΩ termination

M **AUDIO OUT** (Ø3.5 stereo mini jack)

- 200mVrms(max.) 1kΩ output impedance

N **USB**

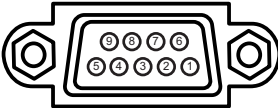
USB B type jack



Pin	Signal
1	+5V
2	- Data
3	+ Data
4	Ground

O **CONTROL**

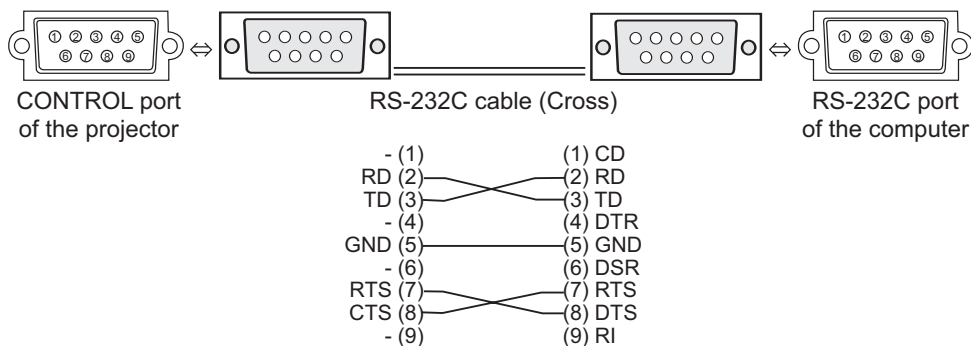
D-sub 9pin plug



- About the details of RS-232C communication, please refer to the following page.

Pin	Signal	Pin	Signal	Pin	Signal
1	(No connection)	4	(No connection)	7	RTS
2	RD	5	Ground	8	CTS
3	TD	6	(No connection)	9	(No connection)

RS-232C Communication



Connecting the cable

1. Turn off the projector and the computer.
2. Connect the CONTROL port of the projector with a RS-232C port of the computer by a RS-232C cable (cross). Use the cable that fulfills the specification shown in the previous page.
3. Turn the computer on, and after the computer has started up turn the projector on.

Communications setting

19200bps, 8N1

1. Protocol

Consist of header (7 bytes) + command data (6 bytes).

2. Header

BE + EF + 03 + 06 + 00 + CRC_low + CRC_high

CRC_low : Lower byte of CRC flag for command data

CRC_high : Upper byte of CRC flag for command data

3. Command data

Command data chart

byte_0	byte_1	byte_2	byte_3	byte_4	byte_5
Action		Type		Setting code	
low	high	low	high	low	high

Action (byte_0 - 1)

Action	Classification	Content
1	SET	Change setting to desired value.
2	GET	Read projector internal setup value.
4	INCREMENT	Increment setup value by 1.
5	DECREMENT	Decrement setup value by 1.
6	EXECUTE	Run a command.

Requesting projector status (Get command)

- (1) Send the request code Header + Command data ('02H'+ '00H'+ type (2 bytes)+ '00H' + '00H') from the computer to the projector.
- (2) The projector returns the response code '1DH'+ data (2 bytes) to the computer.

Changing the projector settings (Set command)

- (1) Send the setting code Header + Command data ('01H'+ '00H'+ type (2 bytes) + setting code (2 bytes)) from the computer to the projector.
- (2) The projector changes the setting based on the above setting code.
- (3) The projector returns the response code '06H' to the computer.

Using the projector default settings (Reset Command)

- (1) The computer sends the default setting code Header + Command data ('06H'+ '00H' + type (2 bytes) + '00H'+ '00H') to the projector.
- (2) The projector changes the specified setting to the default value.
- (3) The projector returns the response code '06H' to the computer.

Increasing the projector setting value (Increment command)

- (1) The computer sends the increment code Header + Command data ('04H'+ '00H'+ type (2 bytes) + '00H'+ '00H') to the projector.
- (2) The projector increases the setting value on the above setting code.
- (3) The projector returns the response code '06H' to the computer.

Decreasing the projector setting value (Decrement command)

- (1) The computer sends the decrement code Header + Command data ('05H'+ '00H'+ type (2 bytes) + '00H' + '00H') to the projector.
- (2) The projector decreases the setting value on the above setting code.
- (3) The projector returns the response code '06H' to the computer.

When the projector cannot understand the received command

When the projector cannot understand the received command, the error code '15H' is sent back to the computer.

Sometimes the projector cannot properly receive the command. In such a case, the command is not executed and the error code '15H' is sent back to the computer. If this error code is returned, send the same command again.

When the projector cannot execute the received command.

When the projector cannot execute the received command, the error code '1CH' + 'xxxxH' is sent back to the computer. When the data length is greater than indicated by the data length code, the projector ignore the excess data code.

Conversely when the data length is shorter than indicated by the data length code, an error code will be returned to the computer.

NOTE • Operation cannot be guaranteed when the projector receives an undefined command or data.

- Provide an interval of at least 40ms between the response code and any other code.
- The projector outputs test data when the power supply is switched ON, and when the lamp is lit. Ignore this data.
- Commands are not accepted during warm-up.

RS-232C Communication (continued)

Names	Operation Type	Header				Command Data			
						CRC	Action	Type	Setting Code
Power	Set	Turn off	BE EF	03	06 00	2A D3	01 00	00 60	00 00
		Turn on	BE EF	03	06 00	BA D2	01 00	00 60	01 00
	Get		BE EF	03	06 00	19 D3	02 00	00 60	00 00
		(Example return)	00 00 (Off)	01 00 (On)	02 00 (Cool down)				
Input Source	Set	RGB IN 1	BE EF	03	06 00	FE D2	01 00	00 20	00 00
		RGB IN 2	BE EF	03	06 00	3E D0	01 00	00 20	04 00
		VIDEO	BE EF	03	06 00	6E D3	01 00	00 20	01 00
		S-VIDEO	BE EF	03	06 00	9E D3	01 00	00 20	02 00
	COMPONENT	BE EF	03	06 00	AE D1	01 00	00 20	05 00	
	Get		BE EF	03	06 00	CD D2	02 00	00 20	00 00
Error Status	Get		BE EF	03	06 00	D9 D8	02 00	20 60	00 00
		(Example return)	00 00 (Normal)	01 00 (Cover error)	02 00 (Fan error)	03 00 (Lamp error)			
			04 00 (Temp error)	05 00 (Air flow error)	06 00 (Lamp time error)	07 00 (Cool error)			
			08 00 (Filter error)						
BRIGHTNESS	Get		BE EF	03	06 00	89 D2	02 00	03 20	00 00
	Increment		BE EF	03	06 00	EF D2	04 00	03 20	00 00
	Decrement		BE EF	03	06 00	3E D3	05 00	03 20	00 00
BRIGHTNESS Reset	Execute		BE EF	03	06 00	58 D3	06 00	00 70	00 00
CONTRAST	Get		BE EF	03	06 00	FD D3	02 00	04 20	00 00
	Increment		BE EF	03	06 00	9B D3	04 00	04 20	00 00
	Decrement		BE EF	03	06 00	4A D2	05 00	04 20	00 00
CONTRAST Reset	Execute		BE EF	03	06 00	A4 D2	06 00	01 70	00 00
PICTURE MODE	Set	NORMAL	BE EF	03	06 00	23 F6	01 00	BA 30	00 00
		CINEMA	BE EF	03	06 00	B3 F7	01 00	BA 30	01 00
		DYNAMIC	BE EF	03	06 00	E3 F4	01 00	BA 30	04 00
		BOARD(BLACK)	BE EF	03	06 00	E3 EF	01 00	BA 30	20 00
		BOARD(GREEN)	BE EF	03	06 00	73 EE	01 00	BA 30	21 00
	WHITEBOARD	BE EF	03	06 00	83 EE	01 00	BA 30	22 00	
	Get		BE EF	03	06 00	10 F6	02 00	BA 30	00 00
	(Example return)	00 00 (Normal)	01 00 (Cinema)	04 00 (Dynamic)	10 00 (Custom)				
		20 00 BOARD(BLACK)	21 00 BOARD(GREEN)	22 00 WHITEBOARD)					
GAMMA	Set	#1 DEFAULT	BE EF	03	06 00	07 E9	01 00	A1 30	20 00
		#1 CUSTOM	BE EF	03	06 00	07 FD	01 00	A1 30	10 00
		#2 DEFAULT	BE EF	03	06 00	97 E8	01 00	A1 30	21 00
		#2 CUSTOM	BE EF	03	06 00	97 FC	01 00	A1 30	11 00
		#3 DEFAULT	BE EF	03	06 00	67 E8	01 00	A1 30	22 00
		#3 CUSTOM	BE EF	03	06 00	67 FC	01 00	A1 30	12 00
		#4 DEFAULT	BE EF	03	06 00	F7 E9	01 00	A1 30	23 00
		#4 CUSTOM	BE EF	03	06 00	F7 FD	01 00	A1 30	13 00
	#5 DEFAULT	BE EF	03	06 00	C7 EB	01 00	A1 30	24 00	
	#5 CUSTOM	BE EF	03	06 00	C7 FF	01 00	A1 30	14 00	
	Get		BE EF	03	06 00	F4 F0	02 00	A1 30	00 00

Names	Operation Type	Header				Command Data			
						CRC	Action	Type	Setting Code
User Gamma Pattern	Set	Off	BE EF	03	06 00	FB FA	01 00	80 30	00 00
		9 step gray scale	BE EF	03	06 00	6B FB	01 00	80 30	01 00
		15 steps gray scale	BE EF	03	06 00	9B FB	01 00	80 30	02 00
		Ramp	BE EF	03	06 00	0B FA	01 00	80 30	03 00
	Get	BE EF	03	06 00	C8 FA	02 00	80 30	00 00	
User Gamma Point 1	Get	BE EF	03	06 00	08 FE	02 00	90 30	00 00	
	Increment	BE EF	03	06 00	6E FE	04 00	90 30	00 00	
	Decrement	BE EF	03	06 00	BF FF	05 00	90 30	00 00	
User Gamma Point 2	Get	BE EF	03	06 00	F4 FF	02 00	91 30	00 00	
	Increment	BE EF	03	06 00	92 FF	04 00	91 30	00 00	
	Decrement	BE EF	03	06 00	43 FE	05 00	91 30	00 00	
User Gamma Point 3	Get	BE EF	03	06 00	B0 FF	02 00	92 30	00 00	
	Increment	BE EF	03	06 00	D6 FF	04 00	92 30	00 00	
	Decrement	BE EF	03	06 00	07 FE	05 00	92 30	00 00	
User Gamma Point 4	Get	BE EF	03	06 00	4C FE	02 00	93 30	00 00	
	Increment	BE EF	03	06 00	2A FE	04 00	93 30	00 00	
	Decrement	BE EF	03	06 00	FB FF	05 00	93 30	00 00	
User Gamma Point 5	Get	BE EF	03	06 00	38 FF	02 00	94 30	00 00	
	Increment	BE EF	03	06 00	5E FF	04 00	94 30	00 00	
	Decrement	BE EF	03	06 00	8F FE	05 00	94 30	00 00	
User Gamma Point 6	Get	BE EF	03	06 00	C4 FE	02 00	95 30	00 00	
	Increment	BE EF	03	06 00	A2 FE	04 00	95 30	00 00	
	Decrement	BE EF	03	06 00	73 FF	05 00	95 30	00 00	
User Gamma Point 7	Get	BE EF	03	06 00	80 FE	02 00	96 30	00 00	
	Increment	BE EF	03	06 00	E6 FE	04 00	96 30	00 00	
	Decrement	BE EF	03	06 00	37 FF	05 00	96 30	00 00	
User Gamma Point 8	Get	BE EF	03	06 00	7C FF	02 00	97 30	00 00	
	Increment	BE EF	03	06 00	1A FF	04 00	97 30	00 00	
	Decrement	BE EF	03	06 00	CB FE	05 00	97 30	00 00	
COLOR TEMP	Set	LOW	BE EF	03	06 00	6B F4	01 00	B0 30	01 00
		MIDDLE	BE EF	03	06 00	9B F4	01 00	B0 30	02 00
		HIGH	BE EF	03	06 00	0B F5	01 00	B0 30	03 00
		Hi-BRIGHT-1	BE EF	03	06 00	3B F2	01 00	B0 30	08 00
		Hi-BRIGHT-2	BE EF	03	06 00	AB F3	01 00	B0 30	09 00
		CUSTOM-LOW	BE EF	03	06 00	AB F9	01 00	B0 30	11 00
		CUSTOM-MID	BE EF	03	06 00	5B F9	01 00	B0 30	12 00
		CUSTOM-HIGH	BE EF	03	06 00	CB F8	01 00	B0 30	13 00
		CUSTOM-Hi-BRIGHT-1	BE EF	03	06 00	FB FF	01 00	B0 30	18 00
	CUSTOM-Hi-BRIGHT-2	BE EF	03	06 00	6B FE	01 00	B0 30	19 00	
	Get	BE EF	03	06 00	C8 F5	02 00	B0 30	00 00	
COLOR TEMP GAIN R	Get	BE EF	03	06 00	34 F4	02 00	B1 30	00 00	
	Increment	BE EF	03	06 00	52 F4	04 00	B1 30	00 00	
	Decrement	BE EF	03	06 00	83 F5	05 00	B1 30	00 00	

RS-232C Communication (continued)

Names	Operation Type	Header				Command Data			
						CRC	Action	Type	Setting Code
COLOR TEMP GAIN G	Get	BE EF	03	06 00	70 F4	02 00	B2 30	00 00	
	Increment	BE EF	03	06 00	16 F4	04 00	B2 30	00 00	
	Decrement	BE EF	03	06 00	C7 F5	05 00	B2 30	00 00	
COLOR TEMP GAIN B	Get	BE EF	03	06 00	8C F5	02 00	B3 30	00 00	
	Increment	BE EF	03	06 00	EA F5	04 00	B3 30	00 00	
	Decrement	BE EF	03	06 00	3B F4	05 00	B3 30	00 00	
COLOR TEMP OFFSET R	Get	BE EF	03	06 00	04 F5	02 00	B5 30	00 00	
	Increment	BE EF	03	06 00	62 F5	04 00	B5 30	00 00	
	Decrement	BE EF	03	06 00	B3 F4	05 00	B5 30	00 00	
COLOR TEMP OFFSET G	Get	BE EF	03	06 00	40 F5	02 00	B6 30	00 00	
	Increment	BE EF	03	06 00	26 F5	04 00	B6 30	00 00	
	Decrement	BE EF	03	06 00	F7 F4	05 00	B6 30	00 00	
COLOR TEMP OFFSET B	Get	BE EF	03	06 00	BC F4	02 00	B7 30	00 00	
	Increment	BE EF	03	06 00	DA F4	04 00	B7 30	00 00	
	Decrement	BE EF	03	06 00	0B F5	05 00	B7 30	00 00	
COLOR	Get	BE EF	03	06 00	B5 72	02 00	02 22	00 00	
	Increment	BE EF	03	06 00	D3 72	04 00	02 22	00 00	
	Decrement	BE EF	03	06 00	02 73	05 00	02 22	00 00	
COLOR Reset	Execute	BE EF	03	06 00	80 D0	06 00	0A 70	00 00	
TINT	Get	BE EF	03	06 00	49 73	02 00	03 22	00 00	
	Increment	BE EF	03	06 00	2F 73	04 00	03 22	00 00	
	Decrement	BE EF	03	06 00	FE 72	05 00	03 22	00 00	
TINT Reset	Execute	BE EF	03	06 00	7C D1	06 00	0B 70	00 00	
SHARPNESS	Get	BE EF	03	06 00	F1 72	02 00	01 22	00 00	
	Increment	BE EF	03	06 00	97 72	04 00	01 22	00 00	
	Decrement	BE EF	03	06 00	46 73	05 00	01 22	00 00	
SHARPNESS Reset	Execute	BE EF	03	06 00	C4 D0	06 00	09 70	00 00	
PROGRESSIVE	Set	TURN OFF	BE EF	03	06 00	4A 72	01 00	07 22	00 00
		TV	BE EF	03	06 00	DA 73	01 00	07 22	01 00
		FILM	BE EF	03	06 00	2A 73	01 00	07 22	02 00
	Get	BE EF	03	06 00	79 72	02 00	07 22	00 00	
VIDEO NR	Set	LOW	BE EF	03	06 00	26 72	01 00	06 22	01 00
		MIDDLE	BE EF	03	06 00	D6 72	01 00	06 22	02 00
		HIGH	BE EF	03	06 00	46 73	01 00	06 22	03 00
	Get	BE EF	03	06 00	85 73	02 00	06 22	00 00	
MY MEMORY Load	Set	1	BE EF	03	06 00	0E D7	01 00	14 20	00 00
		2	BE EF	03	06 00	9E D6	01 00	14 20	01 00
		3	BE EF	03	06 00	6E D6	01 00	14 20	02 00
		4	BE EF	03	06 00	FE D7	01 00	14 20	03 00
MY MEMORY Save	Set	1	BE EF	03	06 00	F2 D6	01 00	15 20	00 00
		2	BE EF	03	06 00	62 D7	01 00	15 20	01 00
		3	BE EF	03	06 00	92 D7	01 00	15 20	02 00
		4	BE EF	03	06 00	02 D6	01 00	15 20	03 00

Names	Operation Type	Header				Command Data			
						CRC	Action	Type	Setting Code
ASPECT	Set	4:3	BE EF	03	06 00	9E D0	01 00	08 20	00 00
		16:9	BE EF	03	06 00	0E D1	01 00	08 20	01 00
		14:9	BE EF	03	06 00	CE D6	01 00	08 20	09 00
		SMALL	BE EF	03	06 00	FE D1	01 00	08 20	02 00
	Get	BE EF	03	06 00	5E DD	01 00	08 20	10 00	
OVER SCAN	Get	BE EF	03	06 00	91 70	02 00	09 22	00 00	
	Increment	BE EF	03	06 00	F7 70	04 00	09 22	00 00	
	Decrement	BE EF	03	06 00	26 71	05 00	09 22	00 00	
OVER SCAN Reset	Execute	BE EF	03	06 00	EC D9	06 00	27 70	00 00	
V POSITION	Get	BE EF	03	06 00	0D 83	02 00	00 21	00 00	
	Increment	BE EF	03	06 00	6B 83	04 00	00 21	00 00	
	Decrement	BE EF	03	06 00	BA 82	05 00	00 21	00 00	
V POSITION Reset	Execute	BE EF	03	06 00	E0 D2	06 00	02 70	00 00	
H POSITION	Get	BE EF	03	06 00	F1 82	02 00	01 21	00 00	
	Increment	BE EF	03	06 00	97 82	04 00	01 21	00 00	
	Decrement	BE EF	03	06 00	46 83	05 00	01 21	00 00	
H POSITION Reset	Execute	BE EF	03	06 00	1C D3	06 00	03 70	00 00	
H PHASE	Get	BE EF	03	06 00	49 83	02 00	03 21	00 00	
	Increment	BE EF	03	06 00	2F 83	04 00	03 21	00 00	
	Decrement	BE EF	03	06 00	FE 82	05 00	03 21	00 00	
H SIZE	Get	BE EF	03	06 00	B5 82	02 00	02 21	00 00	
	Increment	BE EF	03	06 00	D3 82	04 00	02 21	00 00	
	Decrement	BE EF	03	06 00	02 83	05 00	02 21	00 00	
H SIZE Reset	Execute	BE EF	03	06 00	68 D2	06 00	04 70	00 00	
AUTO ADJUST	Execute	BE EF	03	06 00	91 D0	06 00	0A 20	00 00	
COLOR SPACE	Set	AUTO	BE EF	03	06 00	0E 72	01 00	04 22	00 00
		RGB	BE EF	03	06 00	9E 73	01 00	04 22	01 00
		SMPTE240	BE EF	03	06 00	6E 73	01 00	04 22	02 00
		REC709	BE EF	03	06 00	FE 72	01 00	04 22	03 00
	REC601	BE EF	03	06 00	CE 70	01 00	04 22	04 00	
Get	BE EF	03	06 00	3D 72	02 00	04 22	00 00		
COMPONENT	Set	COMPONENT	BE EF	03	06 00	4A D7	01 00	17 20	00 00
		SCART RGB	BE EF	03	06 00	DA D6	01 00	17 20	01 00
	Get	BE EF	03	06 00	79 D7	02 00	17 20	00 00	
C-VIDEO FORMAT	Set	AUTO	BE EF	03	06 00	A2 70	01 00	11 22	0A 00
		NTSC	BE EF	03	06 00	C2 74	01 00	11 22	04 00
		PAL	BE EF	03	06 00	52 75	01 00	11 22	05 00
		SECAM	BE EF	03	06 00	52 70	01 00	11 22	09 00
		NTSC4.43	BE EF	03	06 00	62 77	01 00	11 22	02 00
		M-PAL	BE EF	03	06 00	C2 71	01 00	11 22	08 00
	N-PAL	BE EF	03	06 00	32 74	01 00	11 22	07 00	
Get	BE EF	03	06 00	31 76	02 00	11 22	00 00		
S-VIDEO FORMAT	Set	AUTO	BE EF	03	06 00	E6 70	01 00	12 22	0A 00
		NTSC	BE EF	03	06 00	86 74	01 00	12 22	04 00
		PAL	BE EF	03	06 00	16 75	01 00	12 22	05 00
		SECAM	BE EF	03	06 00	16 70	01 00	12 22	09 00
		NTSC4.43	BE EF	03	06 00	26 77	01 00	12 22	02 00
		M-PAL	BE EF	03	06 00	86 71	01 00	12 22	08 00
	N-PAL	BE EF	03	06 00	76 74	01 00	12 22	07 00	
Get	BE EF	03	06 00	75 76	02 00	12 22	00 00		

RS-232C Communication (continued)

Names	Operation Type	Header				Command Data			
						CRC	Action	Type	Setting Code
FRAME LOCK	Set	TURN OFF	BE EF	03	06 00	CB D6	01 00	14 30	00 00
		TURN ON	BE EF	03	06 00	5B D7	01 00	14 30	01 00
	Get	BE EF	03	06 00	F8 D6	02 00	14 30	00 00	
RGB1 IN-1	Set	SYNC ON G OFF	BE EF	03	06 00	5E D7	01 00	10 20	02 00
		SYNC ON G ON	BE EF	03	06 00	CE D6	01 00	10 20	03 00
	Get	BE EF	03	06 00	0D D6	02 00	10 20	00 00	
RGB IN-2	Set	SYNC ON G OFF	BE EF	03	06 00	A2 D6	01 00	11 20	02 00
		SYNC ON G ON	BE EF	03	06 00	32 D7	01 00	11 20	03 00
	Get	BE EF	03	06 00	F1 D7	02 00	11 20	00 00	
KEYSTONE V	Get	BE EF	03	06 00	B9 D3	02 00	07 20	00 00	
	Increment	BE EF	03	06 00	DF D3	04 00	07 20	00 00	
	Decrement	BE EF	03	06 00	0E D2	05 00	07 20	00 00	
KEYSTONE V Reset	Execute	BE EF	03	06 00	08 D0	06 00	0C 70	00 00	
WHISPER	Set	NORMAL	BE EF	03	06 00	AB 22	01 00	00 33	01 00
		BRIGHT	BE EF	03	06 00	3B 23	01 00	00 33	00 00
	Get	BE EF	03	06 00	08 23	02 00	00 33	00 00	
MIRROR	Set	NORMAL	BE EF	03	06 00	C7 D2	01 00	01 30	00 00
		H:INVERT	BE EF	03	06 00	57 D3	01 00	01 30	01 00
		V:INVERT	BE EF	03	06 00	A7 D3	01 00	01 30	02 00
		H&V:INVERT	BE EF	03	06 00	37 D2	01 00	01 30	03 00
	Get	BE EF	03	06 00	F4 D2	02 00	01 30	00 00	
AUDIO - RGB1	Set	TURN OFF	BE EF	03	06 00	FE DD	01 00	30 20	00 00
		Audio1	BE EF	03	06 00	6E DC	01 00	30 20	01 00
		Audio2	BE EF	03	06 00	9E DC	01 00	30 20	02 00
		Audio3	BE EF	03	06 00	0E DD	01 00	30 20	03 00
	Get	BE EF	03	06 00	CD DD	02 00	30 20	00 00	
AUDIO - RGB2	Set	TURN OFF	BE EF	03	06 00	CE DC	01 00	34 20	00 00
		Audio1	BE EF	03	06 00	5E DD	01 00	34 20	01 00
		Audio2	BE EF	03	06 00	AE DD	01 00	34 20	02 00
		Audio3	BE EF	03	06 00	3E DC	01 00	34 20	03 00
	Get	BE EF	03	06 00	FD DC	02 00	34 20	00 00	
AUDIO - Video	Set	TURN OFF	BE EF	03	06 00	02 DC	01 00	31 20	00 00
		Audio1	BE EF	03	06 00	92 DD	01 00	31 20	01 00
		Audio2	BE EF	03	06 00	62 DD	01 00	31 20	02 00
		Audio3	BE EF	03	06 00	F2 DC	01 00	31 20	03 00
	Get	BE EF	03	06 00	31 DC	02 00	31 20	00 00	
AUDIO - S-Video	Set	TURN OFF	BE EF	03	06 00	46 DC	01 00	32 20	00 00
		Audio1	BE EF	03	06 00	D6 DD	01 00	32 20	01 00
		Audio2	BE EF	03	06 00	26 DD	01 00	32 20	02 00
		Audio3	BE EF	03	06 00	B6 DC	01 00	32 20	03 00
	Get	BE EF	03	06 00	75 DC	02 00	32 20	00 00	
AUDIO - Component	Set	TURN OFF	BE EF	03	06 00	32 DD	01 00	35 20	00 00
		Audio1	BE EF	03	06 00	A2 DC	01 00	35 20	01 00
		Audio2	BE EF	03	06 00	52 DC	01 00	35 20	02 00
		Audio3	BE EF	03	06 00	C2 DD	01 00	35 20	03 00
	Get	BE EF	03	06 00	01 DD	02 00	35 20	00 00	

Names	Operation Type	Header				Command Data			
						CRC	Action	Type	Setting Code
MUTE	Set	TURN OFF	BE EF	03	06 00	46 D3	01 00	02 20	00 00
		TURN ON	BE EF	03	06 00	D6 D2	01 00	02 20	01 00
	Get	BE EF	03	06 00	75 D3	02 00	02 20	00 00	
LANGUAGE	Set	ENGLISH	BE EF	03	06 00	F7 D3	01 00	05 30	00 00
		FRANÇAIS	BE EF	03	06 00	67 D2	01 00	05 30	01 00
		DEUTSCH	BE EF	03	06 00	97 D2	01 00	05 30	02 00
		ESPAÑOL	BE EF	03	06 00	07 D3	01 00	05 30	03 00
		ITALIANO	BE EF	03	06 00	37 D1	01 00	05 30	04 00
		NORSK	BE EF	03	06 00	A7 D0	01 00	05 30	05 00
		NEDERLANDS	BE EF	03	06 00	57 D0	01 00	05 30	06 00
		PORTUGUÉS	BE EF	03	06 00	C7 D1	01 00	05 30	07 00
		日本語	BE EF	03	06 00	37 D4	01 00	05 30	08 00
		简体中文	BE EF	03	06 00	A7 D5	01 00	05 30	09 00
		繁體中文	BE EF	03	06 00	37 DE	01 00	05 30	10 00
		한글	BE EF	03	06 00	57 D5	01 00	05 30	0A 00
		SVENSKA	BE EF	03	06 00	C7 D4	01 00	05 30	0B 00
		РУССКИЙ	BE EF	03	06 00	F7 D6	01 00	05 30	0C 00
	SUOMI	BE EF	03	06 00	67 D7	01 00	05 30	0D 00	
POLSKI	BE EF	03	06 00	97 D7	01 00	05 30	0E 00		
TÜRKÇE	BE EF	03	06 00	07 D6	01 00	05 30	0F 00		
MENU POSITION H	Get	BE EF	03	06 00	04 D7	02 00	15 30	00 00	
	Increment	BE EF	03	06 00	62 D7	04 00	15 30	00 00	
	Decrement	BE EF	03	06 00	B3 D6	05 00	15 30	00 00	
MENU POSITION H Reset	Execute	BE EF	03	06 00	DC C6	06 00	43 70	00 00	
MENU POSITION V	Get	BE EF	03	06 00	40 D7	02 00	16 30	00 00	
	Increment	BE EF	03	06 00	26 D7	04 00	16 30	00 00	
	Decrement	BE EF	03	06 00	F7 D6	05 00	16 30	00 00	
MENU POSITION V Reset	Execute	BE EF	03	06 00	A8 C7	06 00	44 70	00 00	

RS-232C Communication (continued)

Names	Operation Type	Header				Command Data			
						CRC	Action	Type	Setting Code
BLANK	Set	My Screen	BE EF	03	06 00	FB CA	01 00	00 30	20 00
		ORIGINAL	BE EF	03	06 00	FB E2	01 00	00 30	40 00
		BLUE	BE EF	03	06 00	CB D3	01 00	00 30	03 00
		WHITE	BE EF	03	06 00	6B D0	01 00	00 30	05 00
		BLACK	BE EF	03	06 00	9B D0	01 00	00 30	06 00
	Get		BE EF	03	06 00	08 D3	02 00	00 30	00 00
BLANK On/Off	Set	TURN OFF	BE EF	03	06 00	FB D8	01 00	20 30	00 00
		TURN ON	BE EF	03	06 00	6B D9	01 00	20 30	01 00
		Get	BE EF	03	06 00	C8 D8	02 00	20 30	00 00
START UP	Set	My Screen	BE EF	03	06 00	CB CB	01 00	04 30	20 00
		ORIGINAL	BE EF	03	06 00	0B D2	01 00	04 30	00 00
		TURN OFF	BE EF	03	06 00	9B D3	01 00	04 30	01 00
		Get	BE EF	03	06 00	38 D2	02 00	04 30	00 00
My Screen LOCK	Set	TURN OFF	BE EF	03	06 00	3B EF	01 00	C0 30	00 00
		TURN ON	BE EF	03	06 00	AB EE	01 00	C0 30	01 00
		Get	BE EF	03	06 00	08 EF	02 00	C0 30	00 00
MESSAGE	Set	TURN OFF	BE EF	03	06 00	8F D6	01 00	17 30	00 00
		TURN ON	BE EF	03	06 00	1F D7	01 00	17 30	01 00
		Get	BE EF	03	06 00	BC D6	02 00	17 30	00 00
AUTO SEARCH	Set	TURN OFF	BE EF	03	06 00	B6 D6	01 00	16 20	00 00
		TURN ON	BE EF	03	06 00	26 D7	01 00	16 20	01 00
		Get	BE EF	03	06 00	85 D6	02 00	16 20	00 00
AUTO ON	Set	TURN OFF	BE EF	03	06 00	3B 89	01 00	20 31	00 00
		TURN ON	BE EF	03	06 00	AB 88	01 00	20 31	01 00
		Get	BE EF	03	06 00	08 89	02 00	20 31	00 00
AUTO KEYSTONE EXECUTE	Execute	BE EF	03	06 00	E5 D1	06 00	0D 20	00 00	
AUTO KEYSTONE	Set	TURN OFF	BE EF	03	06 00	EAD1	01 00	0F 20	00 00
		TURN ON	BE EF	03	06 00	7A D0	01 00	0F 20	01 00
		Get	BE EF	03	06 00	D9 D1	02 00	0F 20	00 00
AUTO OFF	Get	BE EF	03	06 00	08 86	02 00	10 31	00 00	
	Increment	BE EF	03	06 00	6E 86	04 00	10 31	00 00	
	Decrement	BE EF	03	06 00	BF 87	05 00	10 31	00 00	
LAMP TIME	Get	BE EF	03	06 00	C2 FF	02 00	90 10	00 00	
LAMP TIME Reset	Execute	BE EF	03	06 00	58 DC	06 00	30 70	00 00	
FILTER TIME	Get	BE EF	03	06 00	C2 F0	02 00	A0 10	00 00	
FILER TIME Reset	Execute	BE EF	03	06 00	98 C6	06 00	40 70	00 00	
MAGNIFY	Get	BE EF	03	06 00	7C D2	02 00	07 30	00 00	
	Increment	BE EF	03	06 00	1A D2	04 00	07 30	00 00	
	Decrement	BE EF	03	06 00	CB D3	05 00	07 30	00 00	
FREEZE	Set	NORMAL	BE EF	03	06 00	83 D2	01 00	02 30	00 00
		FREEZE	BE EF	03	06 00	13 D3	01 00	02 30	01 00
	Get	BE EF	03	06 00	B0 D2	02 00	02 30	00 00	

Names	Operation Type	Header					Command Data		
					CRC	Action	Type	Setting Code	
REMOTE FREQ NORMAL	Set	Disable	BE EF	03	06 00	FF 3D	01 00	30 26	00 00
		Enable	BE EF	03	06 00	6F 3C	01 00	30 26	01 00
	Get	BE EF	03	06 00	CC 3D	02 00	30 26	00 00	
REMOTE FREQ HIGH	Set	Disable	BE EF	03	06 00	03 3C	01 00	31 26	00 00
		Enable	BE EF	03	06 00	93 3D	01 00	31 26	01 00
	Get	BE EF	03	06 00	30 3C	02 00	31 26	00 00	
MY BUTTON-1	Set	RGB1	BE EF	03	06 00	3A 33	01 00	00 36	00 00
		RGB2	BE EF	03	06 00	FA 31	01 00	00 36	04 00
		COMPONENT	BE EF	03	06 00	6A 30	01 00	00 36	05 00
		S-VIDEO	BE EF	03	06 00	5A 32	01 00	00 36	02 00
		Video	BE EF	03	06 00	AA 32	01 00	00 36	01 00
		INFORMATION	BE EF	03	06 00	FA 3E	01 00	00 36	10 00
		AUTO KEYSTONE EXECUTE	BE EF	03	06 00	6A 3F	01 00	00 36	11 00
		MY MEMORY	BE EF	03	06 00	9A 3F	01 00	00 36	12 00
		PICTURE MODE	BE EF	03	06 00	0A 3E	01 00	00 36	13 00
	FILTER RESET	BE EF	03	06 00	3A 3C	01 00	00 36	14 00	
Get	BE EF	03	06 00	09 33	02 00	00 36	00 00		
MY BUTTON-2	Set	RGB1	BE EF	03	06 00	C6 32	01 00	01 36	00 00
		RGB2	BE EF	03	06 00	06 30	01 00	01 36	04 00
		COMPONENT	BE EF	03	06 00	96 31	01 00	01 36	05 00
		S-VIDEO	BE EF	03	06 00	A6 33	01 00	01 36	02 00
		Video	BE EF	03	06 00	56 33	01 00	01 36	01 00
		INFORMATION	BE EF	03	06 00	06 3F	01 00	01 36	10 00
		AUTO KEYSTONE EXECUTE	BE EF	03	06 00	96 3E	01 00	01 36	11 00
		MY MEMORY	BE EF	03	06 00	66 3E	01 00	01 36	12 00
		PICTURE MODE	BE EF	03	06 00	F6 3F	01 00	01 36	13 00
	FILTER RESET	BE EF	03	06 00	C6 3D	01 00	01 36	14 00	
Get	BE EF	03	06 00	F5 32	02 00	01 36	00 00		
VOLUME-RGB1	Get	BE EF	03	06 00	CD CC	02 00	60 20	00 00	
	Increment	BE EF	03	06 00	AB CC	04 00	60 20	00 00	
	Decrement	BE EF	03	06 00	7A CD	05 00	60 20	00 00	
VOLUME-RGB2	Get	BE EF	03	06 00	FD CD	02 00	64 20	00 00	
	Increment	BE EF	03	06 00	9B CD	04 00	64 20	00 00	
	Decrement	BE EF	03	06 00	4A CC	05 00	64 20	00 00	
VOLUME-Video	Get	BE EF	03	06 00	31 CD	02 00	61 20	00 00	
	Increment	BE EF	03	06 00	57 CD	04 00	61 20	00 00	
	Decrement	BE EF	03	06 00	86 CD	05 00	61 20	00 00	
VOLUME-S-Video	Get	BE EF	03	06 00	75 CD	02 00	62 20	00 00	
	Increment	BE EF	03	06 00	13 CD	04 00	62 20	00 00	
	Decrement	BE EF	03	06 00	C2 CC	05 00	62 20	00 00	
VOLUME-Component	Get	BE EF	03	06 00	01 CC	02 00	65 20	00 00	
	Increment	BE EF	03	06 00	67 CC	04 00	65 20	00 00	
	Decrement	BE EF	03	06 00	B6 CD	05 00	65 20	00 00	

HITACHI

Inspire the Next

Hitachi, Ltd. Japan
292 Yoshida-cho
Totsuka-ku, Yokohama-city
Kanagawa 244-0817

HITACHI EUROPE LTD.

Consumer Affairs Department
PO Box 3007
Maidenhead
SL6 8ZE

UNITED KINGDOM

Tel: 0870 405 4405
Email: consumer.mail@Hitachi-eu.com

HITACHI EUROPE GmbH

Munich Office
Dornacher Strasse 3
D-85622 Feldkirchen bei München

GERMANY

Tel: +49 -89-991 80-0
Fax: +49 - 89 - 991 80 -224
Hotline: +49 - 180 - 551 25 51 (12ct/min.)
Email: HSE-DUS.Service@Hitachi-eu.com

HITACHI EUROPE SRL

Via T. Gulli n.39
20147 MILAN

ITALY

Tel: 02 487861
Fax: 02 48786381
Servizio Clienti
Tel. 02 38073415
Email: customerservice.italy@hitachi-eu.com

HITACHI EUROPE S.A.S

Lyon Office
B.P.45, 4 Allée des Sorbiers 69671 Bron Cedex

FRANCE

Tel: 04 72 14 29 70
Fax: 04 72 14 29 99
Email: france.consommateur@hitachi-eu.com

HITACHI EUROPE S.A.

364, Kifissias Ave. & 1, Delfon Str.
152 33 Chalandri
Athens

GREECE

Tel: 1-6837200
Fax: 1-6835694
Email: service.hellas@hitachi-eu.com

HITACHI EUROPE S.A.

Gran Via Carlos III
86 Planta 5a Edificios
Trade - Torre Este
08028 Barcelona

SPAIN

Tel: 93 409 2550
Fax: 93 491 3513
Email: atencion.cliente@hitachi-eu.com

HITACHI EUROPE AB

Box 77
S-164 94 KISTA

SWEDEN

Tel: 08 562 711 00
Fax: 08 562 711 11
Email: csgswe@hitachi-eu.com

HITACHI EUROPE LTD.

Norwegian Branch Office
Strandveien 18
1366 Lysaker

NORWAY

Tel: 02205 9060
Fax: 02205 9061
Email: csgnor@hitachi-eu.com

HITACHI EUROPE LTD. BENELUX BRANCHE OFFICE BERGENSESTEENWEG 421 1600 SINT-PIETERS-LEEUV BELGIUM

Tel:0032/2 363 99 01
Fax:0032/2 363 99 00
Email:info@hitachi.be

www.hitachidigitalmedia.com