

myprojectorlamps.com

**The most trusted, dependable name
in projector lamp sales.**



<http://www.myprojectorlamps.com>



<http://www.myprojectorlamps.ca>



<http://www.myprojectorlamps.eu>

The following projector manual has not been modified or altered in any way.

Projector

CP-X205/CP-X305 User's Manual (detailed) Operating Guide

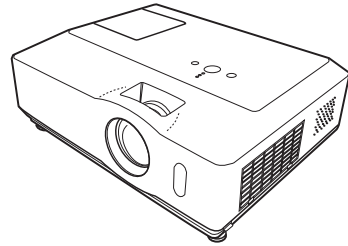

Thank you for purchasing this projector.

⚠ WARNING ▶ Before using this product, please read all manuals for this product. Be sure to read “Safety Guide” first. After reading them, store them in a safe place for future reference.

About this manual

Various symbols are used in this manual. The meanings of these symbols are described below.

⚠ WARNING This symbol indicates information that, if ignored, could possibly result in personal injury or even death due to incorrect handling.

⚠ CAUTION This symbol indicates information that, if ignored, could possibly result in personal injury or physical damage due to incorrect handling.

 Please refer to the pages written following this symbol.

NOTE • The information in this manual is subject to change without notice.

- The manufacturer assumes no responsibility for any errors that may appear in this manual.
- The reproduction, transfer or copy of all or any part of this document is not permitted without express written consent.

Trademark acknowledgment

- Mac is registered trademarks of Apple Computer, Inc.
- VESA and SVGA are trademarks of the Video Electronics Standard Association.
- Windows is a registered trademark of Microsoft Corporation.

All other trademarks are the properties of their respective owners.

Projector

User's Manual - Safety Guide



Thank you for purchasing this projector.

⚠ WARNING • Before using, read these user's manuals of this projector to ensure correct usage through understanding. After reading, store them in a safe place for future reference. Incorrect handling of this product could possibly result in personal injury or physical damage. The manufacturer assumes no responsibility for any damage caused by mishandling that is beyond normal usage defined in these manuals of this projector.

- NOTE** • The information in this manual is subject to change without notice.
- The manufacturer assumes no responsibility for any errors that may appear in this manual.
 - The reproduction, transmission or use of this document or contents is not permitted without express written authority.

About The Symbols

Various symbols are used in this manual, the user's manual and on the product itself to ensure correct usage, to prevent danger to the user and others, and to prevent property damage. The meanings of these symbols are described below. It is important that you read these descriptions thoroughly and fully understand the contents.

 WARNING	This symbol indicates information that, if ignored, could possibly result in personal injury or even death due to incorrect handling.
 CAUTION	This symbol indicates information that, if ignored, could result possibly in personal injury or physical damage due to incorrect handling.

Typical Symbols



This symbol indicates an additional warning (including cautions). An illustration is provided to clarify the contents.



This symbol indicates a prohibited action. The contents will be clearly indicated in an illustration or nearby (the symbol to the left indicates that disassembly is prohibited).



This symbol indicates a compulsory action. The contents will be clearly indicated in an illustration or nearby (the symbol to the left indicates that the power plug should be disconnected from the power outlet).

Safety Precautions

WARNING

Never use the projector if a problem should occur.

Abnormal operations such as smoke, strange odor, no image, no sound, excessive sound, damaged casing or elements or cables, penetration of liquids or foreign matter, etc. can cause a fire or electrical shock.

In such case, immediately turn off the power switch and then disconnect the power plug from the power outlet. After making sure that the smoke or odor has stopped, contact your dealer. Never attempt to make repairs yourself because this could be dangerous.

- The power outlet should be close to the projector and easily accessible.

Use special caution for children and pets.

Incorrect handling could result in fire, electrical shock, injury, burn or vision problem.

Use special caution in households where children and pets are present.

Do not insert liquids or foreign object.

Penetration of liquids or foreign objects could result in fire or electrical shock.

Use special caution in households where children are present.

If liquids or foreign object should enter the projector, immediately turn off the power switch, disconnect the power plug from the power outlet and contact your dealer.

- Do not place the projector near water (ex. a bathroom, a beach, etc.).
- Do not expose the projector to rain or moisture. Do not place the projector outdoors.
- Do not place flower vases, pots, cups, cosmetics, liquids such as water, etc on or around the projector.
- Do not place metals, combustibles, etc on or around the projector.
- To avoid penetration of foreign objects, do not put the projector into a case or bag together with any thing except the accessories of the projector, signal cables and connectors.

Never disassemble and modify.

The projector contains high voltage components. Modification and/or disassembly of the projector or accessories could result in fire or electrical shock.

- Never open the cabinet.
- Ask your dealer to repair and clean insider.

Do not give the projector any shock or impact.

If the projector should be shocked and/or broken, it could result in an injury, and continued use could result in fire or electrical shock.

If the projector is shocked, immediately turn off the power switch, disconnect the power plug from the power outlet and contact your dealer.

Do not place the projector on an unstable surface.

If the projector should be dropped and/or broken, it could result in an injury, and continued use could result in fire or electrical shock.

- Do not place the projector on an unstable, slant or vibrant surface such as a wobbly or inclined stand.
- Use the caster brakes placing the projector on a stand with casters.
- Do not place the projector in the side up position, the lens up position or the lens down position.
- In the case of a ceiling installation or the like, contact your dealer before installation.



Disconnect the plug from the power outlet.



Do not disassemble.



Safety Precautions (continued)

WARNING

Be cautious of High temperatures of the projector.

High temperatures are generated when the lamp is lit. It could result in fire or burn. Use special caution in households where children are present.

Do not touch about the lens, air fans and ventilation openings during use or immediately after use, to prevent a burn. Take care of ventilation.

- Keep a space of 30 cm or more between the sides and other objects such as walls.
- Do not place the projector on a metallic table or anything weak in heat.
- Do not place anything about the lens, air fans and ventilation openings of the projector.
- Never block the air fan and ventilation openings.
- Do not cover the projector with a tablecloth, etc.
- Do not place the projector on a carpet or bedding.



Never look through the lens or openings when the lamp is on.

The powerful light could adversely affect vision.

Use special caution in households where children are present.



Use only the correct power cord and the correct power outlet.

Incorrect power supply could result in fire or electrical shock.

- Use only the correct power outlet depending on the indication on the projector and the safety standard.
- The enclosed power cord must be used depending on the power outlet to be used.



Be cautious of the power cord connection.

Incorrect connection of the power cord could result in fire or electrical shock.

- Do not touch the power cord with a wet hand.
- Check that the connecting portion of the power cord is clean (with no dust), before using. Use a soft and dry cloth to clean the power plug.
- Insert the power plug into a power outlet firmly. Avoid using a loose, unsound outlet or contact failure.



Be sure to connect with ground wire.

Connect the ground terminal of AC inlet of this unit with the ground terminal provided at the building using the correct power cord; otherwise, fire or electric shock can result.

- Don't take the core of power cord away.



Surely connect the ground wire.

Safety Precautions (continued)

WARNING

Be careful in handling the light source lamp.

The projector uses a high-pressure mercury glass lamp made of glass. The lamp can break with a loud bang, or burn out. When the bulb bursts, it is possible for shards of glass to fly into the lamp housing, and for gas containing mercury to escape from the projector's vent holes.

Please carefully read the section "Lamp".

Be careful in handling the power cord and external connection cables.

If you keep using a damaged the power cord or cables, it can cause a fire or electrical shock. Do not apply too much heat, pressure or tension to the power cord and cables.

If the power cord or cables is damaged (exposed or broken core wires, etc.), contact your dealer.

- Do not place the projector or heavy objects on the power cord and cables. Also, do not place a spread, cover, etc, over them because this could result in the inadvertent placing of heavy objects on the concealed power cord or cables.

- Do not pull the power cord and cables. When connecting and disconnecting the power cord or cables, do it with your hand holding the plug or connector.

- Do not place the cord near the heater.

- Avoid bending the power cord sharply.

- Do not attempt to work on the power cord.

Be careful in handling the battery of the remote control.

Incorrect handling of the battery could result in fire or personal injury. The battery may explode if not handled properly.

- Keep the battery away from children and pets. If swallowed consult a physician immediately for emergency treatment.

- Do not allow the battery in a fire or water.

- Avoid fire or high-temperature environment.

- Do not hold the battery with the metallic tweezers.

- Keep the battery in a dark, cool and dry place.

- Do not short circuit the battery.

- Do not recharge, disassemble or solder the battery.

- Do not give the battery a physical impact.

- Use only the battery specified in the other manual of this projector.

- Make sure the plus and minus terminals are correctly aligned when loading the battery.

- If you observe a leakage of the battery, wipe out the flower and then replace the battery. If the flower adheres your body or clothes, rinse well with water.

- Obey the local laws on disposing the battery.



Safety Precautions (continued)

CAUTION

Be careful in moving the projector.

Neglect could result in an injury or damage.

- Do not move the projector during use. Before moving, disconnect the power cord and all external connections, and close the slide lens door or attach the lens cap.
- Avoid any impact or shock to the projector.
- Do not drag the projector.
- For moving the projector, use the enclosed case or bag if provided.



Do not put anything on top of the projector.

Placing anything on the projector could result in loss of balance or falling, and cause an injury or damage. Use special caution in households where children are present.



Do not attach anything other than specified things to the projector.

Neglect could result in an injury or damage.

- Some projector has a screw thread in a lens part. Do not attach anything other than specified options (such as conversion lens) to the screw thread.



Avoid a smoky, humid or dusty place.

Placing the projector in a smoke, a highly humid, dusty place, oily soot or corrosive gas could result in fire or electrical shock.

- Do not place the projector near a smoky, humid or dusty place (ex. a smoking space, a kitchen, a beach, etc.). Do not place the projector outdoors.
- Do not use a humidifier near the projector.



Take care of the air filter to normal ventilate.

The air filter should be cleaned periodically. If the air filter becomes clogged by dust or the like, internal temperature rises and could cause malfunction. The projector may display the message such as "CHECK THE AIR FLOW" or turn off the projector, to prevent the internal heat level rising.

- When the indicators or a message prompts you to clean the air filter, clean the air filter as soon as possible.
- If the soiling will not come off the air filter, or it becomes damaged, replace the air filter.
- Use the air filter of the specified type only. Please order the air filter specified in the other manual of this projector to your dealer.
- When you replace the lamp, replace also the air filter. The air filter may be attached when you buy a replacement lamp for this projector.
- Do not turn on the projector without air filter.



Avoid a high temperature environment.

The heat could have adverse influence on the cabinet of the projector and other parts. Do not place the projector, the remote control and other parts in direct sunlight or near a hot object such as heater, etc.



Avoid Magnetism.

Manufacture strongly recommends to avoid any magnetic contact that is not shielded or protected on or near the projector itself. (ie., Magnetic Security Devices, or other projector accessory that contains magnetic material that has not been provided by the manufacture etc.) Magnetic objects may cause interruption of the projector's internal mechanical performance which may interfere with cooling fans speed or stopping, and may cause the projector to completely shut down.



Safety Precautions (continued)

CAUTION

Remove the power cord for complete separation.

- For safety purposes, disconnect the power cord if the projector is not to be used for prolonged periods of time.
- Before cleaning, turn off and unplug the projector. Neglect could result in fire or electrical shock.



Disconnect the plug from the power outlet.

Ask your dealer to cleaning inside of the projector about every year.

Accumulations of dust inside the projector cause result in fire or malfunction. Cleaning inside is more effective if performed before every humid periods such as rainy season.

- Do not clean inside yourself because it is dangerous.



NOTE

Do not give the remote control any physical impact.

A physical impact could cause damage or malfunction of the remote control.

- Take care not to drop the remote control.
- Do not place the projector or heavy objects on the remote control.

Take care of the lens.

- Close the slide lens door or attach the lens cap to prevent the lens surface being scratched when the projector is not used.
- Do not touch the lens to prevent fog or dirt of the lens that cause deterioration of display quality.
- Use commercially available lens tissue to clean the lens (used to clean cameras, eyeglasses, etc.). Be careful not to scratch the lens with hard objects.

Take care of the cabinet and the remote control.

Incorrect care could have adverse influence such as discoloration, peeling paint, etc.

- Use a soft cloth to clean the cabinet and control panel of the projector and the remote control. When excessively soiled dilute a neutral detergent in water, wet and wring out the soft cloth and afterward wipe with a dry soft cloth. Do not use undiluted detergent directly.
- Do not use an aerosol sprays, solvents, volatile substances or abrasive cleaner.
- Before using chemical wipes, be sure to read and observe the instructions.
- Do not allow long-term close contact with rubber or vinyl.

About bright spots or dark spots.

Although bright spots or dark spots may appear on the screen, this is a unique characteristic of liquid crystal displays, and such do not constitute or imply a machine defect.

Be careful of printing of the LCD panel.

If the projector continues projecting a still image, inactive images or 16:9 aspect images in case of 4:3 panel, etc., for long time, the LCD panel might possibly be printed.

Safety Precautions (continued)

NOTE

About consumables.

Lamp, LCD panels, polarizers and other optical components, and air filter and cooling fans have a different lifetime in each. These parts may need to be replaced after a long usage time.

- This product isn't designed for continuous use of long time. In the case of continuous use for 6 hours or more, or use for 6 hours or more every day (even if it isn't continuous), or repetitious use, the lifetime may be shortened, and these parts may need to be replaced even if one year has not passed since the beginning of using.
- Any inclining use beyond the adjustment range explained in these user's manuals may shorten the lifetimes of the consumables.

Before turning on the power, make the projector cool down adequately.

After turning the projector off, pushing the restart switch or interrupting of the power supply, make the projector cool down adequately. Operation in a high temperature state of the projector causes a damage of the electrode and un-lighting of the lamp.

Avoid strong rays.

Any strong ray (such as direct rays of the sun or room lighting) onto the remote control sensors could invalidate the remote control.

Avoid radio interference.

Any interfering radiation could cause disordered image or noises.

- Avoid radio generator such as a mobile telephone, transceiver, etc. around the projector.

About displaying characteristic.

The display condition of the projector (such as color, contrast, etc.) depends on characteristic of the screen, because the projector uses a liquid crystal display panel. The display condition can differ from the display of CRT.

- Do not use a polarized screen. It can cause red image.

Turn the power on/off in right order.

To prevent any trouble, turn on/off the projector in right order mentioned below unless specifying.

- Power on the projector before the computer or video tape recorder.
- Power off the projector after the computer or video tape recorder.

Take care not to fatigue your eyes.

Rest the eyes periodically.

Set the sound volume at a suitable level to avoid bothering other people.

- It is better to keep the volume level low and close the windows at night to protect the neighborhood environment.

Connecting with notebook computer

When connecting with notebook computer, set to valid the RGB external image output (setting CRT display or simultaneous display of LCD and CRT).

Please read instruction manual of the notebook for more information.

Lamp

WARNING



HIGH VOLTAGE



HIGH TEMPERATURE



HIGH PRESSURE

The projector uses a high-pressure mercury glass lamp. The lamp can **break with a loud bang, or burn out**, if jolted or scratched, handled while hot, or worn over time. Note that each lamp has a different lifetime, and some may burst or burn out soon after you start using them. In addition, when the bulb bursts, it is possible for **shards of glass** to fly into the lamp housing, and for **gas containing mercury** to escape from the projector's vent holes.

About disposal of a lamp • This product contains a mercury lamp; do not put in trash. Dispose of in accord with environmental laws.

For lamp recycling, go to www.lamprecycle.org. (in USA)

For product disposal, contact your local government agency or www.eiae.org (in the US) or www.epsc.ca (in Canada).

For more information, call your dealer.



Disconnect
the plug from
the power
outlet

- If the lamp should break (it will make a loud bang when it does), unplug the power cord from the outlet, and make sure to request a replacement lamp from your local dealer. Note that shards of glass could damage the projector's internals, or cause injury during handling, so please do not try to clean the projector or replace the lamp yourself.
- If the lamp should break (it will make a loud bang when it does), ventilate the room well, and make sure not to breathe the gas that comes out of the projector vents, or get it in your eyes or mouth.
- Before replacing the lamp, make sure the power switch is off and the power cable is not plugged in, then wait at least 45 minutes for the lamp to cool sufficiently. Handling the lamp while hot can cause burns, as well as damaging the lamp.



- Do not open the lamp cover while the projector is suspended from above. This is dangerous, since if the lamp's bulb has broken, the shards will fall out when the cover is opened. In addition, working in high places is dangerous, so ask your local dealer to have the lamp replaced even if the bulb is not broken.
- Do not use the projector with the lamp cover removed. At the lamp replacing, make sure that the screws are screwed in firmly. Loose screws could result in damage or injury.



- Use the lamp of the specified type only.
- If the lamp breaks soon after the first time it is used, it is possible that there are electrical problems elsewhere besides the lamp. If this happens, contact your local dealer or a service representative.
- Handle with care: jolting or scratching could cause the lamp bulb to burst during use.
- Using the lamp for long periods of time, could cause it dark, not to light up or to burst. When the pictures appear dark, or when the color tone is poor, please replace the lamp as soon as possible. Do not use old (used) lamps; this is a cause of breakage.

Regulatory Notices

FCC Statement Warning

This device complies with part 15 of the FCC Rules. Operation is subject to the following two conditions: (1) This device may not cause harmful interference, and (2) this device must accept any interference received, including interference that may cause undesired operation.

WARNING: This equipment has been tested and found to comply with the limits for a Class B digital device, pursuant to Part 15 of the FCC Rules. These limits are designed to provide reasonable protection against harmful interference in a residential installation. This equipment generates, uses, and can radiate radio frequency energy and, if not installed and used in accordance with the instructions, may cause harmful interference to radio communications. However, there is no guarantee that interference will not occur in a particular installation. If this equipment does cause harmful interference to radio or television reception, which can be determined by turning the equipment off and on, the user is encouraged to try to correct the interference by one or more of the following measures:

- Reorient or relocate the receiving antenna.
- Increase the separation between the equipment and receiver.
- Connect the equipment into an outlet on a circuit different from that to which the receiver is connected.
- Consult the dealer or an experienced radio/TV technician for help.

INSTRUCTIONS TO USERS: This equipment complies with the requirements of FCC (Federal Communication Commission) equipment provided that the following conditions are met. Some cables have to be used with the core set. Use the accessory cable or a designated-type cable for the connection. For cables that have a core only at one end, connect the core to the projector.

CAUTION: Changes or modifications not expressly approved by the party responsible for compliance could void the user's authority to operate the equipment.

For the Customers in CANADA

NOTICE: This Class B digital apparatus complies with Canadian ICES-003.

Warranty And After-Service

Unless seen any abnormal operations (mentioned with the first paragraph of WARNING in this manual), when a problem occurs with the equipment, first refer to the "Troubleshooting" section of the "Operating Guide", and run through the suggested checks. If this does not resolve the problem contact your dealer or service company. They will tell you what warranty condition is applied.

Contents



About this manual	1	EASY MENU	24
Contents	2	ASPECT, AUTO KEYSTONE EXECUTE,	
Projector features	3	KEYSTONE , PICTURE MODE, BRIGHTNESS,	
Preparations	3	CONTRAST, COLOR, TINT, SHARPNESS,	
Contents of package	3	WHISPER, MIRROR, RESET, FILTER TIME,	
Fastening the lens cover	3	LANGUAGE, Go to Advanced Menu...	
Part names	4	PICTURE menu	26
Projector	4	BRIGHTNESS, CONTRAST, GAMMA, COLOR TEMP,	
Control panel	5	COLOR, TINT, SHARPNESS, MY MEMORY	
Rear panel	5	IMAGE menu	29
Remote control	6	ASPECT, OVER SCAN, V POSITION, H POSITION,	
Setting up	7	H PHASE, H SIZE, AUTO ADJUST EXECUTE	
Arrangement	7	INPUT menu	31
Connecting your devices	10	PROGRESSIVE, VIDEO NR, COLOR SPACE,	
Connecting power supply	12	COMPONENT, VIDEO FORMAT,	
Using the security bar and slot	12	FRAME LOCK, COMPUTER IN,	
Remote control	13	RESOLUTION	
Putting batteries	13	SETUP menu	34
About the remote control signal	13	AUTO KEYSTONE EXECUTE, KEYSTONE ,	
Changing the frequency of remote		WHISPER, MIRROR, VOLUME,	
control signal	14	SPEAKER, AUDIO	
Using as a		SCREEN menu	36
simple PC mouse & keyboard	14	LANGUAGE, MENU POSITION, BLANK,	
Power on/off	15	START UP, MyScreen, MyScreen Lock,	
Turning on the power	15	MESSAGE, SOURCE NAME	
Turning off the power	15	OPTION menu	40
Operating	16	AUTO SEARCH, AUTO KEYSTONE ,	
Adjusting the volume	16	AUTO ON, AUTO OFF, LAMP TIME,	
Temporarily muting the sound	16	FILTER TIME, MY BUTTON, SERVICE,	
Selecting an input signal	16	SECURITY	
Searching an input signal	17	NETWORK menu	51
Selecting an aspect ratio	17	DHCP, IP ADDRESS, SUBNET MASK,	
Adjusting the projector's elevator	18	DEFAULT GATEWAY, TIME DEFERENCE,	
Adjusting the zoom and focus	18	DATE AND TIME, e-SHOT, INFORMATION,	
Using the automatic adjustment feature	19	SERVICE	
Adjusting the position	19	Maintenance	54
Correcting the keystone distortions	20	Lamp	54
Using the magnify feature	20	Air filter	56
Freezing the screen	21	Internal clock battery	57
Temporarily blanking the screen	21	Other care	58
Using the menu function	22	Troubleshooting	59
		Related messages	59
		Regarding the indicator lamps	60
		Shutting the projector down	61
		Resetting all settings	61
		Phenomena that may be easy	
		to be mistaken for machine defects	62
		Specifications	64

Projector features

This projector has a capability to project various picture signals onto a screen. This projector requires only a minimal amount of space for installation and can produce a large projected image from even a short distance. This projector boasts a variety of I/O port and low noise. These features provide you with the broad use of this projector.

Preparations

Contents of package

Please see the “Contents of package” section in the User’s Manual (concise) which is a book. Your projector should come with the items shown there. Contact immediately your dealer if anything is missing.

NOTE • Keep the original packing materials, for future reshipment. Be sure to use the original packing materials when moving the projector. Use special caution for the lens.

Fastening the lens cover

To avoid losing the lens cover, please fasten the lens cover to the projector using the enclosed strap.

1. Fix the strap to the strap hole of the lens cover.
 - Thread one end of the strap through the strap hole of the lens cover and make the loop at the end, and let the other end of the strap through the loop. Not have a knot in the strap at either end.
2. Fix the strap to the strap hole of the projector.
 - Thread the other end of the strap through the strap hole of the projector and make the loop there. Let the lens cover with the one end of strap though the loop.

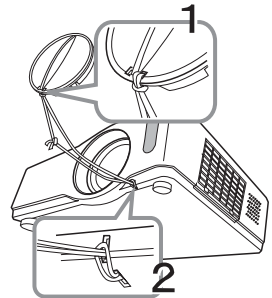

Part names

Projector

- (1) Lamp cover (📖54)
The lamp unit is inside.
- (2) Focus ring (📖18)
- (3) Zoom ring (📖18)
- (4) Control panel (📖5)
- (5) Elevator buttons (x 2) (📖18)
- (6) Elevator feet (x 2) (📖18)
- (7) Remote sensor (📖13)
- (8) Lens (📖18, 58)
- (9) Lens cover (📖3)
- (10) Intake vents
- (11) Filter cover (📖56)
The air filter and intake vent are inside.
- (12) Speaker (📖35)
- (13) Exhaust vent
- (14) AC inlet (📖12)
- (15) Power switch (📖15)
- (16) Rear panel (📖5)
- (17) Security bar (📖12)
- (18) Security slot (📖12)
- (19) Slot cover (📖57)
The internal clock battery is inside.

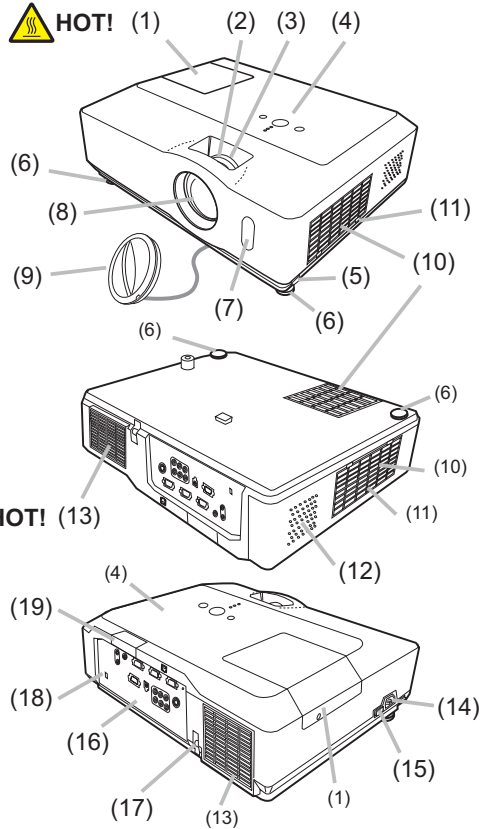

⚠️ WARNING ► HOT! : Do not touch around the lamp cover and the exhaust vents during use or just after use, since it is too hot.

- Do not look into the lens or vents while the lamp is on, since the strong light is not good for your eyes.
- Do not handle the elevator buttons without holding the projector, since the projector may drop down.

⚠️ CAUTION ► Maintain normal ventilation to prevent the projector from heating up. Do not cover, block or plug up the vents. Do not place anything that can stick or be sucked to the vents, around the intake vents. Clean the air filter periodically.

- Do not use the security bar and slot to prevent the projector from falling down, since it is not designed for it.

Control panel

- (1) STANDBY/ON button (📖15)
- (2) INPUT button (📖16, 22)
- (3) MENU button (📖22)
It consists of four cursor buttons.
- (4) POWER indicator (📖15, 60)
- (5) TEMP indicator (📖60)
- (6) LAMP indicator (📖60)

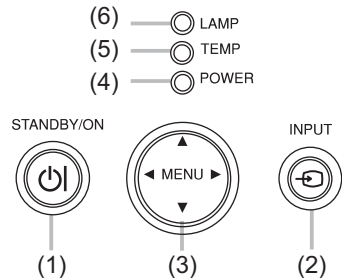

Rear panel

- (1) AUDIO IN1 port (📖10)
- (2) AUDIO IN2 port (📖10)
- (3) AUDIO OUT port (📖10)
- (4) COMPUTER IN1 port (📖10)
- (5) COMPUTER IN2 port (📖10)
- (6) MONITOR OUT port (📖10)
- (7) Shutdown switch (📖61)
- (8) CONTROL port (📖10)
- (9) USB port (📖10)
- (10) COMPONENT (Y, Cb/Pb, Cr/Pr) port (📖10)
- (11) VIDEO port (📖10)
- (12) S-VIDEO port (📖10)
- (13) AUDIO IN3 (L,R) ports (📖10)
- (14) LAN port (📖10)

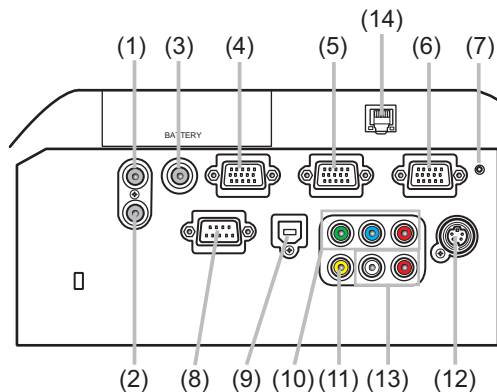

⚠ CAUTION ► Use the shutdown switch only when the projector is not turned off by normal procedure, since pushing this switch stops operation of the projector without cooling it down.

Remote control

- (1) VIDEO button (📖17)
- (2) COMPUTER button (📖16)
- (3) SEARCH button (📖17)
- (4) STANDBY/ON button (📖15)
- (5) ASPECT button (📖17)
- (6) AUTO button (📖19)
- (7) BLANK button (📖21)
- (8) MAGNIFY - ON button (📖20)
- (9) MAGNIFY - OFF button (📖14, 20)
- (10) HOME button (📖14)
- (11) END button (📖14)
- (12) PAGE UP button (📖14)
- (13) PAGE DOWN button (📖14)
- (14) VOLUME button (📖16)
- (15) MUTE button (📖14, 16)
- (16) FREEZE button (📖21)
- (17) MY BUTTON - 1 button (📖42)
- (18) MY BUTTON - 2 button (📖42)
- (19) KEYSTONE button (📖20)
- (20) POSITION button (📖19, 22)
- (21) MENU button (📖22)
- (22) ▲/▼/◀/▶ cursor buttons (📖14, 22, 23)
- (23) ENTER button (📖14, 22, 23)
- (24) ESC button (📖14, 22)
- (25) RESET button (📖14, 22, 23)
- (26) Battery cover (📖13)

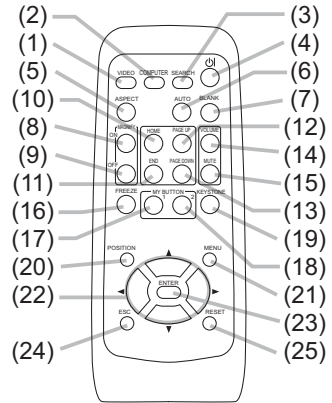

Back of the remote control

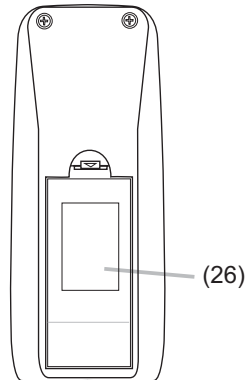

Setting up

Install the projector according to the environment and manner the projector will be used in.

Arrangement

Refer to the illustrations and tables below to determine screen size and projection distance.

<CP-X205>

The values shown in the table are calculated for a full size screen: 1024×768

- (a) Screen size (diagonal)
- (b) Projection distance ($\pm 10\%$)
- (c1), (c2) Screen height ($\pm 10\%$)

On a horizontal surface

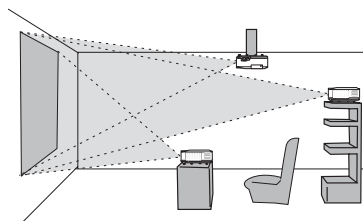
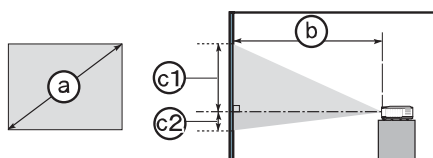

Suspended from the ceiling

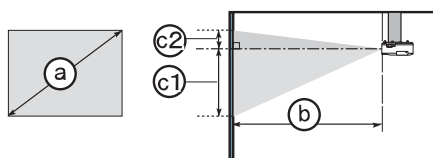

- Keep a space of 30 cm or more between the sides of the projector and other objects such as walls.
- Consult with your dealer before a special installation such as suspending from a ceiling.

(a) Screen size (diagonal)		4 : 3 screen								16 : 9 screen							
		(b) Projection distance				(c1) Screen height		(c2) Screen height		(b) Projection distance				(c1) Screen height		(c2) Screen height	
		min.		max.						min.		max.					
inch	m	m	inch	m	inch	cm	inch	cm	inch	m	inch	m	inch	cm	inch	cm	inch
30	0.8	0.9	34	1.1	41	41	16	5	2	1.0	38	1.1	45	39	15	-1	0
40	1.0	1.2	46	1.4	56	55	22	6	2	1.3	50	1.5	61	51	20	-2	-1
50	1.3	1.5	58	1.8	70	69	27	8	3	1.6	63	1.9	76	64	25	-2	-1
60	1.5	1.8	70	2.1	84	82	32	9	4	1.9	76	2.3	91	77	30	-2	-1
70	1.8	2.1	81	2.5	98	96	38	11	4	2.3	89	2.7	107	90	35	-3	-1
80	2.0	2.4	93	2.8	112	110	43	12	5	2.6	102	3.1	122	103	41	-3	-1
90	2.3	2.7	105	3.2	126	123	49	14	5	2.9	115	3.5	138	116	46	-4	-1
100	2.5	3.0	117	3.6	140	137	54	15	6	3.2	127	3.9	153	129	51	-4	-2
120	3.0	3.6	140	4.3	169	165	65	18	7	3.9	153	4.7	184	154	61	-5	-2
150	3.8	4.5	176	5.4	211	206	81	23	9	4.9	192	5.8	230	193	76	-6	-2
200	5.1	6.0	235	7.2	282	274	108	30	12	6.5	256	7.8	307	257	101	-8	-3
250	6.4	7.5	294	9.0	353	343	135	38	15	8.1	320	9.8	384	322	127	-10	-4
300	7.6	9.0	352	10.8	423	411	162	46	18	9.8	384	11.7	461	386	152	-12	-5

Arrangement (continued)

<CP-X305>

The values shown in the table are calculated for a full size screen: 1024×768

- (a) Screen size (diagonal)
- (b) Projection distance (±10%)
- (c1), (c2) Screen height (±10%)

On a horizontal surface

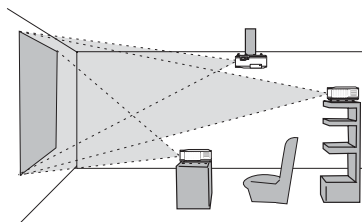
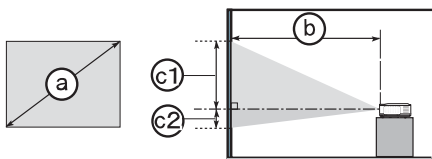

Suspended from the ceiling

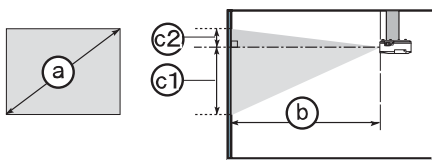

- Keep a space of 30 cm or more between the sides of the projector and other objects such as walls.
- Consult with your dealer before a special installation such as suspending from a ceiling.

(a) Screen size (diagonal)		4 : 3 screen								16 : 9 screen							
		(b) Projection distance				(c1) Screen height		(c2) Screen height		(b) Projection distance				(c1) Screen height		(c2) Screen height	
		min.		max.		cm		inch		min.		max.		cm		inch	
inch	m	m	inch	m	inch	cm	inch	cm	inch	m	inch	m	inch	cm	inch	cm	inch
30	0.8	0.9	35	1.1	43	41	16	5	2	1.0	39	1.2	47	39	15	-1	0
40	1.0	1.2	47	1.4	57	55	22	6	2	1.3	52	1.6	62	51	20	-2	-1
50	1.3	1.5	59	1.8	71	69	27	8	3	1.6	65	2.0	78	64	25	-2	-1
60	1.5	1.8	71	2.2	86	82	32	9	4	2.0	78	2.4	94	77	30	-2	-1
70	1.8	2.1	83	2.5	100	96	38	11	4	2.3	91	2.8	109	90	35	-3	-1
80	2.0	2.4	95	2.9	115	110	43	12	5	2.6	104	3.2	125	103	41	-3	-1
90	2.3	2.7	107	3.3	129	123	49	14	5	3.0	117	3.6	141	116	46	-4	-1
100	2.5	3.0	119	3.6	144	137	54	15	6	3.3	130	4.0	156	129	51	-4	-2
120	3.0	3.6	143	4.4	172	165	65	18	7	4.0	156	4.8	188	154	61	-5	-2
150	3.8	4.6	179	5.5	216	206	81	23	9	4.9	195	6.0	235	193	76	-6	-2
200	5.1	6.1	239	7.3	288	274	108	30	12	6.6	261	8.0	314	257	101	-8	-3
250	6.4	7.6	299	9.1	360	343	135	38	15	8.3	326	10.0	392	322	127	-10	-4
300	7.6	9.1	359	11.0	432	411	162	46	18	9.9	391	12.0	471	386	152	-12	-5

⚠WARNING ► Place the projector in a stable horizontal position. If the projector falls or is knocked over it could cause injury and/or damage to the projector. Using a damaged projector could then result in fire and/or electric shock.

- Do not place the projector on an unstable, slanted or vibrational surface such as a wobbly or inclined stand.
- Do not place the projector on its side, front or rear position.
- Consult with your dealer before a special installation such as suspending from a ceiling.

► Place the projector in a cool place, and ensure that there is sufficient ventilation. The high temperature of the projector could cause fire, burns and/or malfunction of the projector.

- Do not stop-up, block or otherwise cover the projector's vents.
- Keep a space of 30 cm or more between the sides of the projector and other objects such as walls.
- Do not place the projector on metallic thing or anything weak in heat.
- Do not place the projector on carpet, cushions or bedding.
- Do not place the projector in direct sunlight or near hot objects such as heaters.
- Do not anything near the projector lens or vents, or on top of the projector.
- Do not place anything that may be sucked into or stick to the vents on the bottom of the projector. This projector has some intake vents also on the bottom.

► Do not place the projector anyplace where it may get wet. Getting the projector wet or inserting liquid into the projector could cause fire, electric shock and/or malfunction of the projector.

- Do not place the projector in a bathroom or the outdoors.
- Do not place anything containing liquid near the projector.

⚠CAUTION ► Avoid placing the projector in smoky, humid or dusty place. Placing the projector in such places could cause fire, electric shock and/or malfunction of the projector.

- Do not place the projector near humidifiers, smoking spaces or a kitchen.
- Position the projector to prevent light from directly hitting the projector's remote sensor.

Connecting your devices

Be sure to read the manuals for devices before connecting them to the projector. Make sure that all the devices are suitable to be connected with this product, and prepare the cables required to connect. Please refer to the following illustrations to connect them.

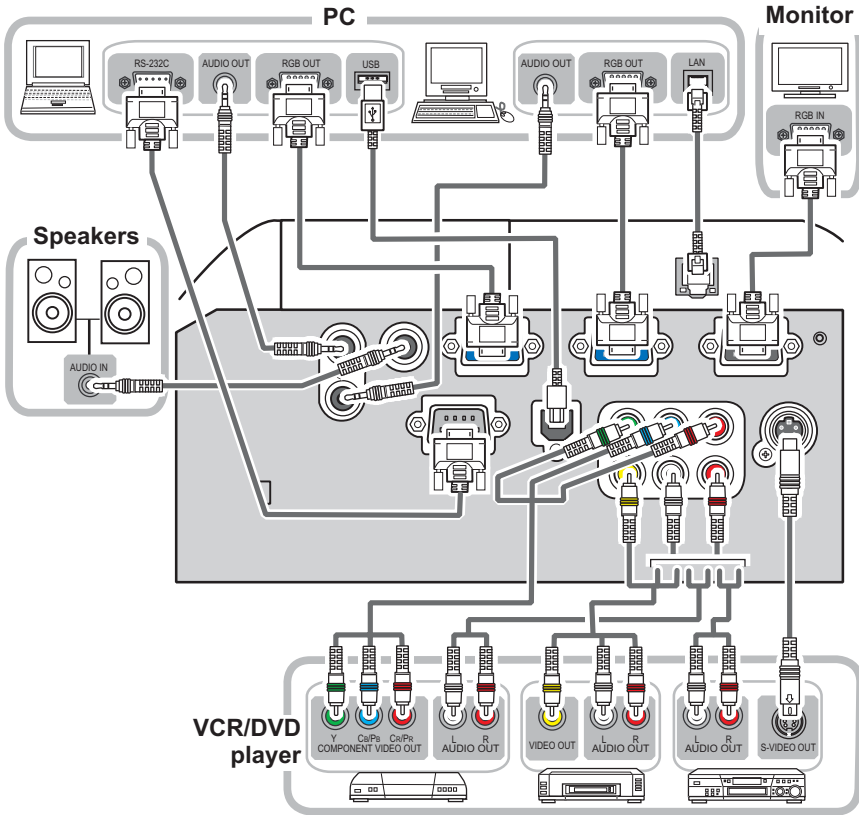

- ⚠ **WARNING** ▶ Do not disassemble or modify the projector and accessories.
- ▶ Be careful not to damage the cables, and do not use damaged cables.
- ⚠ **CAUTION** ▶ Turn off all devices and unplug their power cords prior to connecting them to projector. Connecting a live device to the projector may generate extremely loud noises or other abnormalities that may result in malfunction or damage to the device and the projector.
- ▶ Use appropriate accessory or otherwise designed cables. Ask your dealer about non-accessory cables which may have to be of a specific length or equipped with a core. For cables with a core only at one end, connect the end with the core to the projector.
- ▶ Make sure that devices are connected to the correct ports. An incorrect connection may result in malfunction or damage to the device and the projector.

Connecting your devices (continued)

NOTE • Be sure to read the manuals for devices before connecting them to the projector, and make sure that all the devices are suitable to be connected with this product. Before connecting to a PC, check the signal level, the signal timing, and the resolution.

- Some signal may need an adapter to input this projector.
- Some PCs have multiple screen display modes that may include some signals which are not supported by this projector.
- Although the projector can display signals with resolution up to UXGA (1600X1200), the signal will be converted to the projector's panel resolution before being displayed. The best display performance will be achieved if the resolutions of the input signal and the projector panel are identical.
- While connecting, make sure that the shape of the cable's connector fits the port to connect with. And be sure to tighten the screws on connectors with screws.
- When connecting a laptop PC to the projector, be sure to activate the PC's external RGB output. (Set the laptop PC to CRT display or to simultaneous LCD and CRT display.) For details on how this is done, please refer to the instruction manual of the corresponding laptop PC.
- When the picture resolution is changed on a pc depending on an input, automatic adjustment function may take some time and may not be completed. In this case, you may not be able to see a check box to select "Yes/No" for the new resolution on Windows. Then the resolution will go back to the original. It might be recommended to use other CRT or LCD monitors to change the resolution.
- In some cases, this projector may not display a proper picture or display any picture on screen. For example, automatic adjustment may not function correctly with some input signals. An input signal of composite sync or sync on G may confuse this projector, so the projector may not display a proper picture.

About Plug-and-Play capability

Plug-and-Play is a system composed of a PC, its operating system and peripheral equipment (i.e. display devices). This projector is VESA DDC 2B compatible. Plug-and-Play can be used by connecting this projector to a pc that is VESA DDC (display data channel) compatible.

- Take advantage of this feature by connecting an RGB cable to the COMPUTER IN1 port (DDC 2B compatible). Plug-and-Play may not work properly if any other type of connection is attempted.
- Please use the standard drivers in your pc as this projector is a Plug-and-Play monitor.

Connecting power supply

At first, make sure that the power switch of the projector is set to OFF position (marked "O").

1. Put the connector of the power cord into the AC inlet of the projector.
2. Firmly plug the power cord's plug into the outlet.

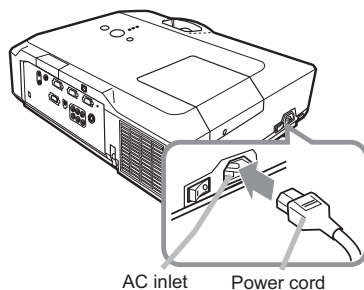

⚠WARNING ► Please use extra caution when connecting the power cord, as incorrect or faulty connections may result in fire and/or electrical shock.

- Only use the power cord that came with the projector. If it is damaged, contact your dealer to newly get correct one.
- Only plug the power cord into an outlet rated for use with the power cord's specified voltage range. The power outlet should be close to the projector and easily accessible. Remove the power cord for complete separation.
- Never modify the power cord.

Using the security bar and slot

A commercial anti-theft chain or wire up to 10 mm in diameter can be attached to the security bar on the projector.

Also this product has the security slot for the Kensington lock.

For details, see the manual of the security tool.

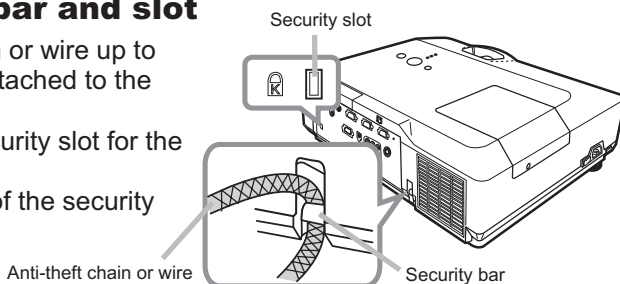

⚠WARNING ► Do not use the security bar and slot to prevent the projector from falling down, since it is not designed for it.

⚠CAUTION ► Do not place anti-theft chain or wire near the exhaust vents. It may become too hot.

NOTE • The security bar and slot is not comprehensive theft prevention measures. It is intended to be used as supplemental theft prevention measure.

Remote control

Putting batteries

Please set the batteries to the remote control before using it. If the remote control starts to malfunction, try to replace the batteries. If you will not use the remote control for long period, remove the batteries from the remote control and store them in a safe place.

1. Holding the hook part of the battery cover, remove it.
2. Align and insert the two AA batteries according to their plus and minus terminals as indicated in the remote control.
3. Replace the battery cover in the direction of the arrow and snap it back into place.

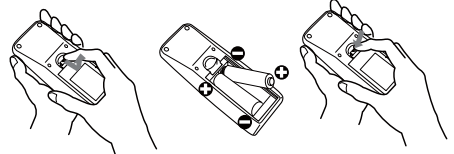

⚠ WARNING ► Always handle the batteries with care and use them only as directed. Improper use may result in battery explosion, cracking or leakage, which could result in fire, injury and/or pollution of the surrounding environment.

- Be sure to use only the batteries specified. Do not use batteries of different types at the same time. Do not mix a new battery with used one.
- Make sure the plus and minus terminals are correctly aligned when loading a battery.
- Keep a battery away from children and pets.
- Do not recharge, short circuit, solder or disassemble a battery.
- Do not allow a battery in a fire or water. Keep batteries in a dark, cool and dry place.
- If you observe battery leakage, wipe out the leakage and then replace a battery. If the leakage adheres to your body or clothes, rinse well with water immediately.
- Obey the local laws on disposing the battery.

About the remote control signal

The remote control works with the projector's remote sensor. This projector has a remote sensor on the front.

The sensor senses the signal within the following range when the sensor is active:

60 degrees (30 degrees to the left and right of the sensor) within 3 meters about.

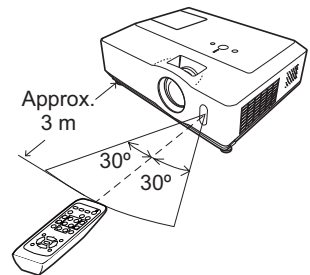

NOTE • The remote control signal reflected in the screen or the like may be available. If it is difficult to send the signal to the sensor directly, attempt to make the signal reflect.

- The remote control uses infrared light to send signals to the projector (Class 1 LED), so be sure to use the remote control in an area free from obstacles that could block the remote control's signal to the projector.
- The remote control may not work correctly if strong light (such as direct sun light) or light from an extremely close range (such as from an inverter fluorescent lamp) shines on the remote sensor of the projector. Adjust the position of projector avoiding those lights.

Changing the frequency of remote control signal

The accessory remote control has the two choices on signal frequency Mode 1:NORMAL and Mode 2:HIGH. If the remote control does not function properly, attempt to change the signal frequency.

In order to set the Mode, please keep pressing the combination of two buttons listed below simultaneously for about 3 seconds.

- (1) Set to Mode 1:NORMAL... MUTE and RESET buttons
 - (2) Set to Mode 2:HIGH... MAGNIFY OFF and ESC buttons
- Please remember that the REMOTE FREQ. in the SERVICE item of the OPTION menu ( 44) of the projector to be controlled should be set to the same mode as the remote control.

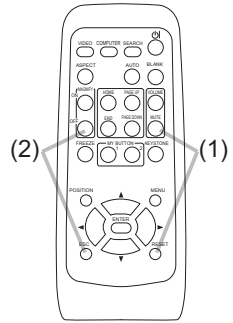

Using as a simple PC mouse & keyboard

The enclosed remote control works as a simple mouse and keyboard of the PC, when the projector's USB port (B type) connects with the PC's USB port (A type) port via a mouse cable.

- (1) **HOME key:** Press HOME button.
- (2) **END key:** Press END button.
- (3) **PAGE UP key:** Press PAGE UP button.
- (4) **PAGE DOWN key:** Press PAGE DOWN button.
- (5) **Mouse left button:** Press ENTER button.
- (6) **Move pointer:** Use the cursor buttons ▲, ▼, ◀ and ▶.
- (7) **ESC key:** Press ESC button.
- (8) **Mouse right button:** Press RESET button.

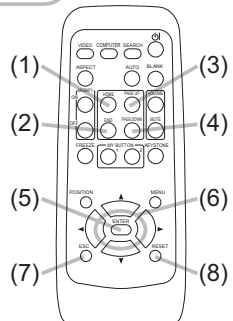
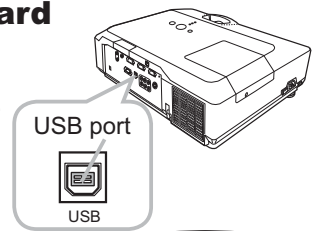

⚠ CAUTION ▶ Improper use of the simple mouse & keyboard function could damage your equipment. While using this function, please connect this product only to a PC. Be sure to check your PC's manuals before connecting this product to the PC.

NOTE • When the simple mouse & keyboard function of this product does not work correctly, please check the following.

- When the mouse cable connects this projector with a PC having a built-in pointing device (e.g. track ball) like a notebook PC, open BIOS setup menu, then select the external mouse and disable the built-in pointing device, because the built-in pointing device may have priority to this function.
- Windows 95 OSR 2.1 or higher is required for this function. And also this function may not work depending on the PC's configurations and mouse drivers.
- You cannot do things like press two buttons at once (for instance, pressing two buttons at the same time to move the mouse pointer diagonally).
- This function is activated only when the projector is working properly. This function is not available while the lamp is warming up (the POWER indicator blinks green), and while adjusting the volume and display, correcting for keystone, zooming in on the screen, using the BLANK function, or displaying the menu screen.

Power on/off

Turning on the power

1. Make sure that the power cord is firmly and correctly connected to the projector and the outlet.
2. Remove the lens cover, and set the power switch to ON position (marked "I").

The POWER indicator will light up in steady orange (📖60). Then wait several seconds because the buttons may not function for these several seconds.

3. Press STANDBY/ON button on the projector or the remote control.

The projection lamp will light up and POWER indicator will begin blinking in green. When the power is completely on, the indicator will stop blinking and light in steady green (📖60).

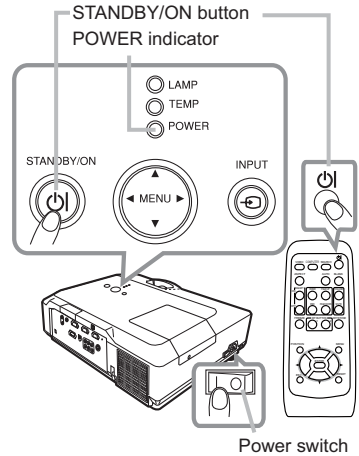

To display the picture, select an input signal according to the section "Selecting an input signal" (📖16).

Turning off the power

1. Press the STANDBY/ON button on the projector or the remote control. The message "Power off?" will appear on the screen for about 5 seconds.
2. Press the STANDBY/ON button again while the message appears. The projector lamp will go off, and the POWER indicator will begin blinking in orange. Then POWER indicator will stop blinking and light in steady orange when the lamp cooling is complete(📖60).
3. Make sure that POWER indicator lights in steady orange, and set the power switch to OFF position (marked "O"). POWER indicator will go off. Attach the lens cover.



Do not turn the projector on for about 10 minutes or more after turning it off. Turning the projector on again too soon could shorten the lifetime of some consumable parts of the projector.

Power switch

⚠️WARNING ▶ A strong light is emitted when the projector's power is on. Do not look into the lens of the projector or look inside of the projector through any of the projector's openings.

▶ Do not touch around the lamp cover and the exhaust vents during use or just after use, since it is too hot.

NOTE • Turn the power on/off in right order. Please power on the projector prior to the connected devices. Power off the projector after all of connected devices are powered off.

• The projector has the AUTO ON function, which can make the projector automatically turn on. For more information, please see AUTO ON item of OPTION menu (📖40).

• Use the shutdown switch (📖61) only when the projector is not turned off by normal procedure.

Operating

Adjusting the volume

1. Press VOLUME button on the remote control.
 - A dialog will appear on the screen to aid you in adjusting the volume.
2. Use the ▲/▼ cursor buttons to adjust the volume.
 - To close the dialog and complete the operation, press the VOLUME button again. Even if you do not do anything, the dialog will automatically disappear after a few seconds.
 - When \times is selected for current picture input port, the volume adjustment is disable. Please see AUDIO item of SETUP menu (35).

VOLUME button

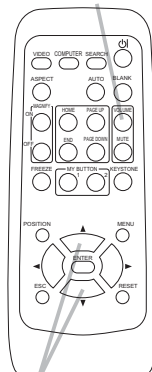

▲/▼ button

Temporarily muting the sound

1. Press MUTE button on the remote control.
 - A dialog will appear on the screen indicating that you have muted the sound. To restore the sound, press the MUTE or VOLUME button. Even if you do not do anything, the dialog will automatically disappear after a few seconds.
 - When \times is selected for current picture input port, the sound is always muted. Please see AUDIO item of SETUP menu (35).

MUTE button

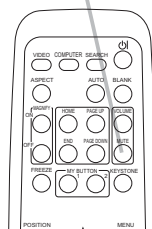

Selecting an input signal

1. Press INPUT button on the projector.
 - Each time you press the button, the projector switches its input port from the current port as below.
 - COMPUTER IN 1 → COMPUTER IN 2 → VIDEO ← S-VIDEO ← COMPONENT (Y, Cb/Pb, Cr/Pr) ←
 - While TURN ON is selected for AUTO SEARCH item in OPTION menu (40), the projector will keep checking the ports in above order repeatedly till an input signal is detected.

INPUT button

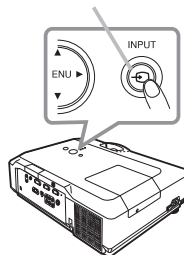

1. Press COMPUTER button on the remote control.
 - Each time you press the button, the projector switches its input port from the current port as below.
 - COMPUTER IN 1 → COMPUTER IN 2 →
 - While TURN ON is selected for AUTO SEARCH item in OPTION menu, the projector will keep checking every port sequentially till an input signal is detected (40). If COMPUTER button is pushed when VIDEO, S-VIDEO or COMPONENT port is selected, the projector will check COMPUTER IN1 port first.

COMPUTER button

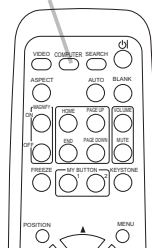

Selecting an input signal (continued)

1. Press VIDEO button on the remote control.
 - Each time you press the button, the projector switches its input port from the current port as below.



VIDEO button

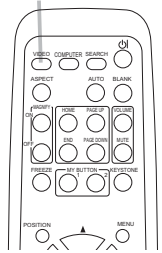

- While TURN ON is selected for AUTO SEARCH item in OPTION menu, the projector will keep checking every port sequentially till an input signal is detected (40). If COMPUTER button is pushed when VIDEO, S-VIDEO or COMPONENT port is selected, the projector will check COMPUTER IN1 port first.

Searching an input signal

1. Press SEARCH button on the remote control.
 - The projector will start to check its input ports as below in order to find any input signals. When an input is found, the projector will stop searching and display the image. If no signal is found, the projector will return to the state selected before the operation.



SEARCH button

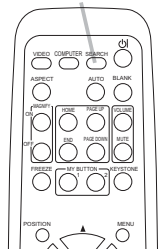

- While TURN ON is selected for AUTO SEARCH item in OPTION menu (40), the projector will keep checking the ports in above order repeatedly till an input signal is detected.

Selecting an aspect ratio

1. Press ASPECT button on the remote control.
 - Each time you press the button, the projector switches the mode for aspect ratio in turn.

○ For a computer signal

NORMAL → 4:3 → 16:9 → SMALL



○ For a video signal, s-video signal or component video signal

4:3 → 16:9 → 14:9 → SMALL



○ For no signal

4:3 (fixed)

ASPECT button

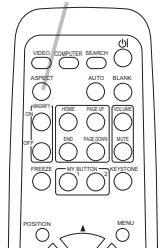

- ASPECT button does not work when no proper signal is inputted.
- NORMAL mode keeps the original aspect ratio setting.

Adjusting the projector's elevator

When the place to put the projector is slightly uneven to the left or right, use the elevator feet to place the projector horizontally.

Using the feet can also tilt the projector in order to project at a suitable angle to the screen, elevating the front side of the projector within 10 degrees.

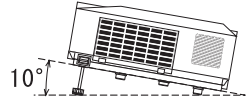

This projector has 2 elevator feet and 2 elevator buttons. An elevator foot is adjustable while pushing the elevator button on the same side as it.

1. Holding the projector, push the elevator buttons to loose the elevator feet.
2. Position the front side of the projector to the desired height.
3. Release the elevator buttons in order to lock the elevator feet.
4. After making sure that the elevator feet are locked, put the projector gently.
5. If necessary, the elevator feet can be manually twisted to make more precise adjustments. Hold the projector when twisting the feet.

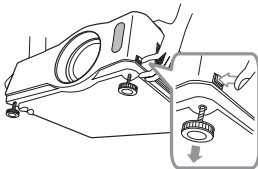

To loose an elevator foot, push the elevator button on the same side as it.

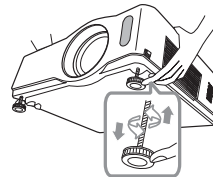

To finely adjust, twist the foot.

⚠ CAUTION ▶ Do not handle the elevator buttons without holding the projector, since the projector may drop down.

▶ Do not tilt the projector other than it elevating its front within 10 degrees using the adjuster feet. A tilt of the projector exceeding the restriction could cause malfunction or shortening the lifetime of consumables, or the projector itself.

Adjusting the zoom and focus

1. Use the zoom ring to adjust the screen size.
2. Use the focus ring to focus the picture.

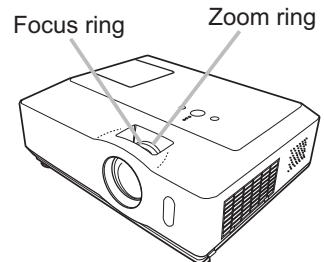

Using the automatic adjustment feature

1. Press AUTO button on the remote control.

AUTO button

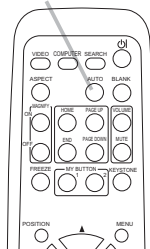

○ For a computer signal

The vertical position, the horizontal position and the horizontal phase will be automatically adjusted. And the horizontal size will be automatically set to the default.

Make sure that the application window is set to its maximum size prior to attempting to use this feature. A dark picture may still be incorrectly adjusted. Use a bright picture when adjusting.

○ For a video signal, s-video signal or component video signal

The video format best suited for the respective input signal will be selected automatically. This function is available only when AUTO is selected for VIDEO FORMAT item in INPUT menu (M32).

The vertical position and horizontal position will be automatically set to the default. For a component video signal, also the horizontal phase will be automatically set to the default.

- The automatic adjustment operation requires approx. 10 seconds. Also please note that it may not function correctly with some input. When this function is performed for a video signal, a certain extra such as a line may appear outside a picture.
- The items adjusted by this function may vary when FINE or DISABLE is selected for AUTO ADJUST item of SERVICE item in OPTION menu (M43).

Adjusting the position

1. Press POSITION button on the remote control when no menu is indicated.

The "POSITION" indication will appear on the screen.

2. Use the ▲/▼/◀/▶ cursor buttons to adjust the picture position.

When you want to reset the operation, press RESET button on the remote control during the operation.

To complete this operation, press POSITION button again. Even if you do not do anything, the dialog will automatically disappear after a few seconds.

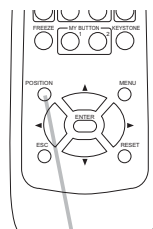

POSITION button

- When this function is performed on a video signal, s-video signal or component video signal, some image such as an extra-line may appear at outside of the picture.
- When this function is performed on a video signal, s-video signal or component video signal, the range of this adjustment depends on OVER SCAN in IMAGE menu (M29) setting. It is not possible to adjust when OVER SCAN is set to 10.
- If POSITION button is pressed when a menu is indicated on screen, the displayed picture does not move its position but the menu does.

Correcting the keystone distortions

KEYSTONE button

1. Press KEYSTONE button on the remote control. A dialog will appear on the screen to aid you in correcting the distortion.
2. Use the ▲/▼ cursor buttons to select AUTO or MANUAL operation, and press the ► button to perform the following.
 - (1) AUTO executes automatic vertical keystone correction.
 - (2) MANUAL displays a dialog for keystone correction. Use the ▲/▼ buttons for adjustment.

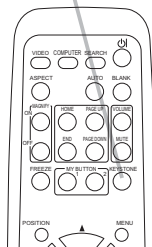

To close the dialog and complete this operation, press KEYSTONE button again. Even if you do not do anything, the dialog will automatically disappear after a few seconds.

- The adjustable range of this correction will vary among inputs. For some input, this function may not work well.
- When V:INVERT or H&V:INVERT is selected for MIRROR item in SETUP menu, if the projector screen is inclined or angled downward, this function may not work correctly.
- When the zoom adjustment is set to TELE (telephoto focus), the automatic keystone distortion correction may be excessive. This function should be used when the zoom adjustment is set to the full WIDE (wide-angle focus) whenever possible.
- When the projector is placed on the level (about $\pm 0^\circ$), the automatic keystone distortion correction may not work.
- When the projector is inclined to near ± 30 degree or over, this function may not work well.
- This function will be unavailable when Transition Detector is on (49).

Using the magnify feature

1. Press the ON button of MAGNIFY on the remote control. The “MAGNIFY” indication will appear on the screen and the projector will go into the MAGNIFY mode. When the ON button of MAGNIFY is pressed first after the projector is started, the picture will be zoomed twice. The indication will disappear in several seconds with no operation.
2. Use the ▲/▼ cursor buttons to adjust the zoom level. The picture of video, s-video or component video signal can be zoomed in up to 2 times, and the one of computer signal can be zoomed in up to 4 times. To move the zoom area, press POSITION button in the MAGNIFY mode, then use the ▲/▼/◀/▶ cursor buttons to move the area. And to finalize the zoom area, press POSITION button again.

MAGNIFY ON/OFF button

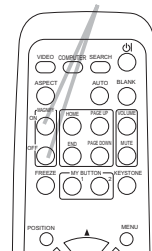

To exit from the MAGNIFY mode and restore the screen to normal, press the OFF button of MAGNIFY on the remote control.

- The projector automatically exits from the MAGNIFY mode when the input signal is changed or when the display condition is changed.
- In the MAGNIFY mode, the keystone distortion condition may vary, it will be restored when the projector exits from the MAGNIFY mode.

NOTE • The zoom level can be finely adjusted. Closely watch the screen to find the level you want.

Freezing the screen

1. Press FREEZE button on the remote control.
 - The “FREEZE” indication will appear on the screen (however, the indication will not appear when TURN OFF is selected for MESSAGE item in SCREEN menu (439)), and the projector will go into the FREEZE mode, which the picture is frozen. To exit the FREEZE mode and restore the screen to normal, press FREEZE button again.
 - The projector automatically exits from the FREEZE mode when one of the projector’s buttons or remote control buttons of STANDBY/ON, SEARCH, COMPUTER, VIDEO, BLANK, AUTO, VOLUME, MUTE, KEYSTONE, MENU, MAGNIFY and MY BUTTON1/2(except MY MEMORY or PICTURE MODE is assigned to) (442) is pressed.
 - If the projector continues projecting a still image for a long time, the LCD panel might possibly be burned in. Do not leave the projector in the FREEZE mode for too long.

FREEZE button

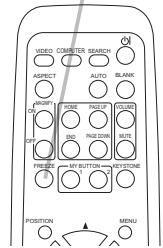

Temporarily blanking the screen

1. Press BLANK button on the remote control.
 - The BLANK screen will be displayed instead of the screen of input signal. Please refer to BLANK item in SCREEN menu (436).

To exit from the BLANK screen and return to the input signal screen, press BLANK button again.

- The projector automatically returns to the input signal screen when one of the projector’s buttons or the remote control buttons (except ASPECT, POSITION, MAGNIFY or FREEZE button, also except MY BUTTON1/2 if AUTO KEYSTONE \square EXECUTE or MY MEMORY or PICTURE MODE is assigned to) (442) is pressed.

BLANK button

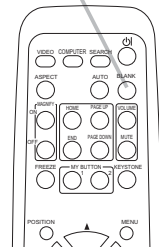

NOTE • The sound is not connected with the BLANK screen function. If necessary, set the volume or mute first.

Using the menu function

This projector has the following menus:

PICTURE, IMAGE, INPUT, SETUP, SCREEN, OPTION, NETWORK and EASY MENU.

EASY MENU consists of functions often used, and the other menus are classified into each purpose and brought together as Advanced Menu.

Each of these menus is operated using the same methods. The basic operations of these menus are as follows.

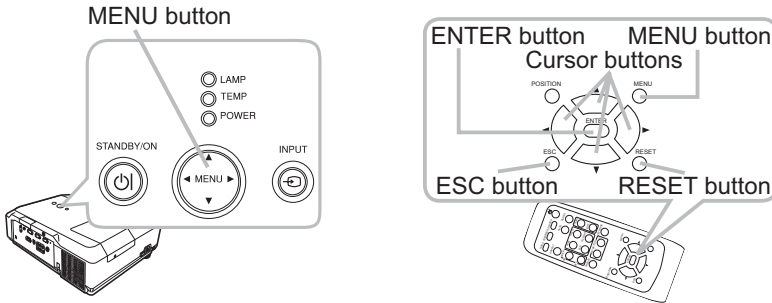

1. Press the MENU button on the remote control or the projector.
The Advanced Menu or EASY MENU, which has priority just after powered on will appear.

If you want to move the menu position, use the cursor buttons after pressing the POSITION button. While the projector is displaying any menu, MENU button on the projector works as the cursor buttons.

In the EASY MENU

2. If you want to change it to the Advanced Menu, select the Go to Advanced Menu...
3. Use the ▲/▼ cursor buttons to select an item to operate.
4. Use the ◀/▶ cursor buttons to operate the item.



EASY MENU

(continued on next page)

Using the menu function (continued)

In the Advanced Menu

2. Use the ▲/▼ cursor buttons to select a menu.
If you want to change it to the EASY MENU, select EASY MENU.
Then press the ► cursor button, or ENTER button to select an item. The lower layer menu of the selected item will appear.

MENU [COMPUTER 1]		◀SELECT
PICTURE	BRIGHTNESS	+0
IMAGE	CONTRAST	+0
INPUT	GAMMA	DEFAULT-1
SETUP	COLOR TEMP	HIGH
SCREEN	COLOR	+0
OPTION	TINT	+0
NETWORK	SHARPNESS	4
EASY MENU	MY MEMORY	SAVE-1

Advanced Menu

3. Use the ▲/▼ cursor buttons to select an item to operate.
Then press the ► cursor button, or ENTER button to progress. The operation menu of the selected item will appear.
4. Use the ▲/▼ cursor buttons to operate the item.
 - Some functions cannot be performed when a certain input port is selected, or when a certain input signal is displayed.
 - When you want to reset the operation, press RESET button on the remote control during the operation. Note that some items (ex. LANGUAGE, H PHASE, VOLUME) cannot be reset.
 - In the Advanced Menu, when you want to return to the previous display, press the ◀ cursor button or ESC button on the remote control.
5. Press MENU button on the remote control again to close the menu and complete this operation. Even if you do not do anything, the dialog will automatically disappear after about 10 seconds.

EASY MENU

From the EASY MENU, items shown in the table below can be performed.

Select an item using the ▲/▼ cursor buttons. Then perform it according to the following table.



Item	Description																								
ASPECT	Using the ◀/▶ buttons switches the mode for aspect ratio. See the ASPECT item in IMAGE menu (📖 29).																								
AUTO KEYSTONE EXECUTE [↘]	Using the ▶ button executes the auto keystone function. See AUTO KEYSTONE [↘] EXECUTE item in SETUP menu (📖 34).																								
KEYSTONE [↘]	Using the ◀/▶ buttons corrects the vertical keystone distortion. See KEYSTONE [↘] item in SETUP menu (📖 34).																								
PICTURE MODE	Using the ◀/▶ buttons switches the picture mode. The picture modes are combinations of GAMMA and COLOR TEMP settings. Choose a suitable mode according to the projected source.																								
	<p> ↪ NORMAL ↔ CINEMA ↔ DYNAMIC ↔ BOARD(BLACK) ↪ ↪ DAYTIME ↔ WHITEBOARD ↔ BOARD(GREEN) ↪ </p>																								
	<table border="1"> <thead> <tr> <th></th> <th>COLOR TEMP</th> <th>GAMMA</th> </tr> </thead> <tbody> <tr> <td>NORMAL</td> <td>#2 MID DEFAULT</td> <td>#1 DEFAULT</td> </tr> <tr> <td>CINEMA</td> <td>#3 LOW DEFAULT</td> <td>#2 DEFAULT</td> </tr> <tr> <td>DYNAMIC</td> <td>#1 HIGH DEFAULT</td> <td>#3 DEFAULT</td> </tr> <tr> <td>BOARD(BLACK)</td> <td>#4 Hi-BRIGHT-1 DEFAULT</td> <td>#4 DEFAULT</td> </tr> <tr> <td>BOARD(GREEN)</td> <td>#5 Hi-BRIGHT-2 DEFAULT</td> <td>#4 DEFAULT</td> </tr> <tr> <td>WHITEBOARD</td> <td>#2 MID DEFAULT</td> <td>#5 DEFAULT</td> </tr> <tr> <td>DAYTIME</td> <td>#6 Hi-BRIGHT-3 DEFAULT</td> <td>#6 DEFAULT</td> </tr> </tbody> </table>		COLOR TEMP	GAMMA	NORMAL	#2 MID DEFAULT	#1 DEFAULT	CINEMA	#3 LOW DEFAULT	#2 DEFAULT	DYNAMIC	#1 HIGH DEFAULT	#3 DEFAULT	BOARD(BLACK)	#4 Hi-BRIGHT-1 DEFAULT	#4 DEFAULT	BOARD(GREEN)	#5 Hi-BRIGHT-2 DEFAULT	#4 DEFAULT	WHITEBOARD	#2 MID DEFAULT	#5 DEFAULT	DAYTIME	#6 Hi-BRIGHT-3 DEFAULT	#6 DEFAULT
		COLOR TEMP	GAMMA																						
NORMAL	#2 MID DEFAULT	#1 DEFAULT																							
CINEMA	#3 LOW DEFAULT	#2 DEFAULT																							
DYNAMIC	#1 HIGH DEFAULT	#3 DEFAULT																							
BOARD(BLACK)	#4 Hi-BRIGHT-1 DEFAULT	#4 DEFAULT																							
BOARD(GREEN)	#5 Hi-BRIGHT-2 DEFAULT	#4 DEFAULT																							
WHITEBOARD	#2 MID DEFAULT	#5 DEFAULT																							
DAYTIME	#6 Hi-BRIGHT-3 DEFAULT	#6 DEFAULT																							
<ul style="list-style-type: none"> • When the combination of GAMMA and COLOR TEMP differs from pre-assigned modes above, the display on the menu for the PICTURE MODE is “CUSTOM”. Please refer to GAMMA (📖 26) and COLOR TEMP (📖 26) items in PICTURE menu. • When this function is performed, a certain extra such as a line may appear. 																									

(continued on next page)

EASY MENU (continued)

Item	Description
BRIGHTNESS	Using the ◀/▶ buttons adjusts the brightness. See BRIGHTNESS item in PICTURE menu (📖26).
CONTRAST	Using the ◀/▶ buttons adjusts the contrast. See CONTRAST item in PICTURE menu (📖26).
COLOR	Using the ◀/▶ buttons adjusts the strength of whole color. See COLOR item in PICTURE menu (📖26).
TINT	Using the ◀/▶ buttons adjusts the tint. See TINT item in PICTURE menu (📖26).
SHARPNESS	Using the ◀/▶ buttons adjusts the sharpness. See SHARPNESS item in PICTURE menu (📖27).
WHISPER	Using the ◀/▶ buttons turns off/on the whisper mode. See WHISPER item in SETUP menu (📖35).
MIRROR	Using the ◀/▶ buttons switches the mode for mirror status. See MIRROR item in SETUP menu (📖35).
RESET	Performing this item resets all of EASY MENU items except FILTER TIME and LANGUAGE. A dialog is displayed for confirmation. Selecting RESET using the ▲ button performs resetting.
FILTER TIME	Performing this item resets the filter time which counts usage time of the air filter. A dialog is displayed for confirmation. Selecting RESET using the ▲ button performs resetting. See FILTER TIME item in OPTION menu (📖41).
LANGUAGE	Using the ◀/▶ buttons changes the display language. See LANGUAGE item in SCREEN menu (📖36).
Go to Advanced Menu...	Select Go to Advanced Menu... on the menu, and press the ▶ or ENTER button to use the menu of PICTURE, IMAGE, INPUT, SETUP, SCREEN, OPTION or NETWORK.

PICTURE menu

From the PICTURE menu, items shown in the table below can be performed.

Select an item using the ▲/▼ cursor buttons, and press the ► cursor button or ENTER button to execute the item. Then perform it according to the following table.



Item	Description
BRIGHTNESS	Using the ▲/▼ buttons adjusts the brightness. Light ⇔ Dark
CONTRAST	Using the ▲/▼ buttons adjusts the contrast. Strong ⇔ Weak
GAMMA	Using the ▲/▼ buttons switches the gamma mode. #1 DEFAULT ⇔ #1 CUSTOM ⇔ #2 DEFAULT ⇔ #2 CUSTOM ⇕ #6 CUSTOM #3 DEFAULT ⇕ #6 DEFAULT #3 CUSTOM ⇕ #5 CUSTOM ⇔ #5 DEFAULT ⇔ #4 CUSTOM ⇔ #4 DEFAULT To adjust the "CUSTOM" modes, see "To adjust CUSTOM function in GAMMA and COLOR TEMP" (p.28).
COLOR TEMP	Using the ▲/▼ buttons switches the color temperature mode. #1 HIGH DEFAULT ⇔ #1 HIGH CUSTOM ⇔ #2 MID DEFAULT ⇕ #6 HI-BRIGHT-3 CUSTOM #2 MID CUSTOM ⇕ #6 HI-BRIGHT-3 DEFAULT #3 LOW DEFAULT ⇕ #5 HI-BRIGHT-2 CUSTOM #3 LOW CUSTOM ⇕ #5 HI-BRIGHT-2 DEFAULT ⇔ #4 HI-BRIGHT-1 CUSTOM ⇔ #4 HI-BRIGHT-1 DEFAULT To adjust the "CUSTOM" modes, see "To adjust CUSTOM function in GAMMA and COLOR TEMP" (p.28).
COLOR	Using the ▲/▼ buttons adjusts the strength of whole color. Strong ⇔ Weak • This item can be selected only for a video signal, s-video or component video signal.
TINT	Using the ▲/▼ buttons adjusts the tint. Greenish ⇔ Reddish • This item can be selected only for a video signal, s-video or component video signal.

(continued on next page)

PICTURE menu (continued)

Item	Description
<p>SHARPNESS</p>	<p>Using the ▲/▼ buttons adjusts the sharpness. Strong ⇄ Weak</p> <ul style="list-style-type: none"> • There may be some noise and/or the screen may flicker for a moment when an adjustment is made. This is not a malfunction.
<p>MY MEMORY</p>	<p>This projector has 4 memories for adjustment data (for all the items of PICTURE menu). Selecting a function using the ▲/▼ buttons and pressing the ► or ENTER button performs each function.</p> <div style="text-align: center;"> <p>LOAD-1 ⇄ LOAD-2 ⇄ LOAD-3 ⇄ LOAD-4 SAVE-4 ⇄ SAVE-3 ⇄ SAVE-2 ⇄ SAVE-1</p> </div> <p><u>LOAD-1, LOAD-2, LOAD-3, LOAD-4</u></p> <p>Performing a LOAD function loads the data from the memory linked in the number included in the function's name, and adjusts the picture automatically depending on the data.</p> <ul style="list-style-type: none"> • The LOAD functions whose linked memory has no data are skipped. • Remember that the current adjusted condition will be lost by loading data. If you want to keep the current adjustment, please save it before performing a LOAD function. • There may be some noise and the screen may flicker for a moment when loading data. This is not malfunction. • You can perform the LOAD function using MY BUTTONs. Please see MY BUTTON item in OPTION menu (42). <p><u>SAVE-1, SAVE-2, SAVE-3, SAVE-4</u></p> <p>Performing a SAVE function saves the current adjustment data into the memory linked in the number included in the function's name.</p> <ul style="list-style-type: none"> • Remember that the current data being stored of a memory will be lost by saving a new data into the memory.

PICTURE menu (continued)

To adjust CUSTOM function in GAMMA and COLOR TEMP

Selecting a mode whose name includes CUSTOM in GAMMA or COLOR TEMP item and then pressing the ► button or ENTER button displays a dialog to aid you in adjusting the mode.



GAMMA



COLOR TEMP

Choose an item using the ◀/▶ buttons, and adjust the level using the ▲/▼ buttons.

- When this function is performed, lines or other distortion may appear.

You can display a test pattern on the top of the screen for checking the effect of your adjustment by pressing the ENTER button. Each time you press the ENTER button, the pattern changes as below.

No pattern ⇔ Gray scale of 9 steps



Ramp ⇔ Gray scale of 15 steps

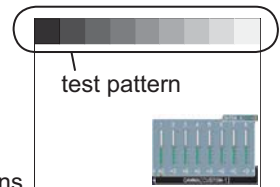

- You can also adjust each function without displaying test patterns.

for adjusting GAMMA

You can change the brightness of particular tones.

The eight equalizing bars correspond to eight tone levels of the test pattern (Gray scale of 9 steps) except the darkest in the left end. If you want to adjust the 2nd tone from left end on the test pattern, use the equalizing adjustment bar “1”. The darkest tone at the left end of the test pattern cannot be controlled with any of equalizing adjustment bar.

for adjusting COLOR TEMP

You can change the intensity of each of 3 colors (Red, Green, Blue).

OFFSET adjustments change the color intensity on the whole tones of the test pattern. GAIN adjustments mainly affect color intensity on the brighter tones of the test pattern.

IMAGE menu

From the IMAGE menu, items shown in the table below can be performed.

Select an item using the ▲/▼ cursor buttons, and press the ► cursor button or ENTER button to execute the item. Then perform it according to the following table.

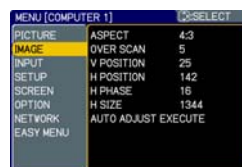

Item	Description
ASPECT	<p>Using the ▲/▼ buttons switches the mode for aspect ratio.</p> <p>For a computer signal NORMAL ⇔ 4:3 ⇔ 16:9 ⇔ SMALL ↑—————↑</p> <p>For a video signal, s-video signal or component video signal 4:3 ⇔ 16:9 ⇔ 14:9 ⇔ SMALL ↑—————↑</p> <p>For no signal 4:3 (fixed)</p> <ul style="list-style-type: none"> • This item can be selected only for a proper signal. • NORMAL mode keeps the original aspect ratio setting.
OVER SCAN	<p>Using the ▲/▼ buttons adjusts the over-scan ratio.</p> <p>Large (It reduces picture) ⇔ Small (It magnifies picture)</p> <ul style="list-style-type: none"> • This item can be selected only for a video, s-video and component video signal. • When this adjustment is too large, certain degradation may appear at the frame area of the picture. In such a case, please adjust small.
V POSITION	<p>Using the ▲/▼ buttons adjusts the vertical position.</p> <p>Up ⇔ Down</p> <ul style="list-style-type: none"> • Over-adjusting the vertical position may cause noise to appear on the screen. If this occurs please reset the vertical position to the default setting. Pressing RESET button when V POSITION is selected will reset V POSITION to the default setting. • When this function is performed on a video signal, s-video signal, or component video signal, the range of this adjustment depends on OVER SCAN (🔲above) setting. It is not possible to adjust when OVER SCAN is set to 10.
H POSITION	<p>Using the ▲/▼ buttons adjusts the horizontal position.</p> <p>Left ⇔ Right</p> <ul style="list-style-type: none"> • Over-adjusting the horizontal position may cause noise to appear on the screen. If this occurs please reset the horizontal position to the default setting. Pressing RESET button when H POSITION is selected will reset H POSITION to the default setting. • When this function is performed on a video signal, s-video signal, or component video signal, the range of this adjustment depends on OVER SCAN (🔲above) setting. It is not possible to adjust when OVER SCAN is set to 10.

(continued on next page)

IMAGE menu (continued)

Item	Description
<p>H PHASE</p>	<p>Using the ▲/▼ buttons adjusts the horizontal phase to eliminate flicker. Right ⇄ Left</p> <ul style="list-style-type: none"> • This item can be selected only for a computer signal or component video signal.
<p>H SIZE</p>	<p>Using the ▲/▼ buttons adjusts the horizontal size. Large ⇄ Small</p> <ul style="list-style-type: none"> • This item can be selected only for a computer signal. • When this adjustment is excessive, the picture may not be displayed correctly. In such a case, please reset the adjustment by pressing the RESET button during this operation.
<p>AUTO ADJUST EXECUTE</p>	<p>Executing this item performs the automatic adjustment feature.</p> <p>For a computer signal The vertical position, the horizontal position and the horizontal phase (43) will be automatically adjusted. And the horizontal size will be automatically set to the default. Make sure that the application window is set to its maximum size prior to attempting to use this feature. A dark picture may still be incorrectly adjusted. Use a bright picture when adjusting.</p> <p>For a video signal, s-video signal or component video signal The video format best suited for the respective input signal will be selected automatically. This function is available only when the AUTO mode is selected to VIDEO FORMAT item in INPUT menu (32). The vertical position and horizontal position will be automatically set to the the default.</p> <p>For a component video signal, also the horizontal phase will be automatically set to the default.</p> <ul style="list-style-type: none"> • The automatic adjustment operation requires approx. 10 seconds. Also please note that it may not function correctly with some input. When this function is performed for a video signal, a certain extra such as a line may appear outside a picture. • The items adjusted by this function may vary when FINE or DISABLE is selected for AUTO ADJUST item of SERVICE item in OPTION menu (43).

INPUT menu

From the INPUT menu, items shown in the table below can be performed.

Select an item using the ▲/▼ cursor buttons, and press the ► cursor button or ENTER button to execute the item. Then perform it according to the following table.



Item	Description
PROGRESSIVE	<p>Using the ▲/▼ buttons switches the progress mode. TV ⇄ FILM ⇄ TURN OFF ↑—————↑</p> <ul style="list-style-type: none"> • This function is performed only for an interlaced signal of a video, s-video or component video of 525i (480i) or 625i (576i) signal. • When TV or FILM is selected, the screen image will be sharp. FILM adapts to the 2-3 Pull-Down conversion system. But these may cause a certain defect (for example, jagged line) of the picture for a quick moving object. In such a case, please select TURN OFF, even though the screen image may lose the sharpness.
VIDEO NR	<p>Using the ▲/▼ buttons switches the noise reduction mode. HIGH ⇄ MID ⇄ LOW ↑—————↑</p> <ul style="list-style-type: none"> • This function performs only for a video, s-video or component video of 525i(480i) or 625i(576i) signal. • When this function is excessive, it may cause a certain degradation of the picture.
COLOR SPACE	<p>Using the ▲/▼ buttons switches the mode for color space. AUTO ⇄ RGB ⇄ SMPTE240 ⇄ REC709 ⇄ REC601 ↑—————↑</p> <ul style="list-style-type: none"> • This item can be selected only for a computer signal or component video signal except SCART RGB signal. • The AUTO mode automatically selects the optimum mode. • The AUTO operation may not work well at some signals. In such a case, it might be good to select a suitable mode except AUTO.
COMPONENT	<p>Using the ▲/▼ buttons switches the function of the COMPONENT (Y, Cb/Pb, Cr/Pr) port. COMPONENT ⇄ SCART RGB</p> <p>When the SCART RGB is selected, COMPONENT (Y, Cb/Pb, Cr/Pr) and VIDEO ports will function as a SCART RGB port. A SCART cable is required for a SCART RGB input to the projector. For your reference, see the TECHNICAL part.</p>

(continued on next page)

INPUT menu (continued)

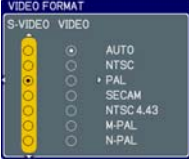
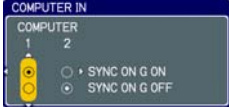
Item	Description
<p>VIDEO FORMAT</p>	<p>The video format for S-VIDEO port and VIDEO port can be set. (1) Use the ◀/▶ buttons to select the input port. (2) Using the ▲/▼ buttons switches the mode for video format.</p> <p>AUTO ⇔ NTSC ⇔ PAL ⇔ SECAM ↕ N-PAL ⇔ M-PAL ⇔ NTSC4.43 ↕</p> <ul style="list-style-type: none"> • This item is performed only for a video signal from VIDEO port or S-VIDEO port. • The AUTO mode automatically selects the optimum mode. • The AUTO operation may not work well for some signals. If the picture becomes unstable (e.g. an irregular picture, lack of color), please select the mode according to the input signal. 
<p>FRAME LOCK</p>	<p>Using the ▲/▼ buttons turns the frame lock function on/off. TURN ON ⇔ TURN OFF</p> <ul style="list-style-type: none"> • This item can be performed only on a computer signal with a vertical frequency of 50 to 60 Hz. • When the TURN ON is selected, a moving pictures are displayed more smoothly. • This function may cause a certain degradation of the picture. In such a case, please select TURN OFF.
<p>COMPUTER IN</p>	<p>The computer input signal type for COMPUTER IN1 and IN2 ports can be set. (1) Use the ◀/▶ buttons to select the input port to be set. COMPUTER (IN)1 ⇔ COMPUTER (IN)2 (2) Use the ▲/▼ buttons to select the computer input signal type.</p> <p>SYNC ON G ON ⇔ SYNC ON G OFF</p> <p>Selecting SYNC ON G ON allows reception of sync on Green signal.</p> <ul style="list-style-type: none"> • When SYNC ON G ON is selected, the picture may be distorted with certain input signals. In such a case, remove the signal connector first and select SYNC ON G OFF on the menu, and then reconnect the signal. 

(continued on next page)

INPUT menu (continued)

Item	Description
<p>RESOLUTION</p>	<p>The resolution for the COMPUTER IN1 and IN2 input signals can be set on this projector.</p> <p>(1) In INPUT menu select RESOLUTION using the ▲/▼ buttons and press the ► button. The RESOLUTION menu will be displayed.</p> <p>(2) In the RESOLUTION menu, select the resolution you wish to display using the ▲/▼ buttons. Selecting AUTO will set a resolution appropriate to the input signal.</p> <p>(3) STANDARD Pressing the ► or ENTER button when selecting a STANDARD resolution will automatically adjust the horizontal and vertical positions, clock phase and horizontal size and automatically select an aspect ratio.</p> <p>(3) CUSTOM (3)-1 To set a custom resolution use the ▲/▼ buttons to select the CUSTOM and the CUSTOM RESOLUTION box will be displayed. Set the horizontal (HORZ) and vertical (VERT) resolutions using the ▲/▼/◀/▶ buttons. Although not all resolutions are guaranteed.</p> <p>(3)-2 To save the setting place the cursor on the right-most digit and press the ► button. The horizontal and vertical positions, clock phase and horizontal size will be automatically adjusted and an aspect ratio will be automatically selected.</p> <p>(3)-3 To revert back to the previous resolution without saving changes place the cursor on the left-most digit and press the ◀ button. The screen will then return to the RESOLUTION menu displaying the previous resolution.</p> <p>• For some pictures, this function may not work well.</p>

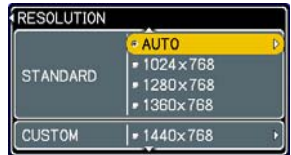

STANDARD



CUSTOM

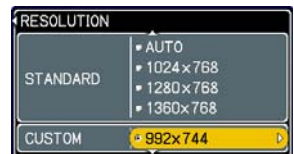

SETUP menu

From the SETUP menu, items shown in the table below can be performed.

Select an item using the ▲/▼ cursor buttons, and press the ► cursor button or the ENTER button to execute the item. Then perform it according to the following table.



Item	Description
<p>AUTO KEYSTONE (Z) EXECUTE</p>	<p>Selecting this item performs the automatic keystone distortion correction. Projector automatically corrects vertical keystone distortion due to the (forward/backward) setup angle by itself.</p> <p>This function will be executed only once when selected in the menu. When the slant of the projector is changed, execute this function again.</p> <ul style="list-style-type: none"> • The adjustable range for correction will vary among inputs. For some input, this function may not work well. • When V:INVERT or H&V:INVERT is selected to the MIRROR item in the SETUP menu, if the projector screen is inclined or angled downward, this function may not work correctly. • When the zoom adjustment is set to the TELE (telephoto focus), this function may be excessive. This function should be used when the zoom adjustment is set to the full WIDE (wide-angle focus) whenever possible. • When the projector is placed on the level (about $\pm 0^\circ$), this function may not work. • When the projector is inclined to near ± 30 degree or over, this function may not work well. • This function will be unavailable when the Transition Detector is on (49).
<p>KEYSTONE (Z)</p>	<p>Using the ▲/▼ buttons corrects the vertical keystone distortion.</p> <p>Shrink the top of the image ⇔ Shrink the bottom of the image</p> <ul style="list-style-type: none"> • The adjustable range of this function will vary with the type of input signal. For some input, this function may not work well. • This function will be unavailable when the Transition Detector is on (49).

(continued on next page)

SETUP menu (continued)

Item	Description
WHISPER	Using the ▲/▼ buttons turns off/on the whisper mode. NORMAL ⇔ WHISPER • When WHISPER is selected, acoustic noise and screen brightness are reduced.
MIRROR	Using the ▲/▼ buttons switches the mode for mirror status.  NORMAL ⇔ H:INVERT ⇔ V:INVERT ⇔ H&V:INVERT ↑—————↑ If the Transition Detector is TURN ON and MIRROR status is changed, Transition Detector Alarm (📖49) will be displayed when projector is restarted after the power switch is turned off.
VOLUME	Using the ▲/▼ buttons adjusts the volume. High ⇔ Low
SPEAKER	Using the ▲/▼ buttons turns on/off the built-in speaker. TURN ON ⇔ TURN OFF When TURN OFF is selected, the built-in speaker does not work.
AUDIO	Allocates the audio ports. (1) Choose a picture input port using the ▲/▼ buttons. ⇨COMPUTER (IN)1 ⇔ COMPUTER (IN)2⇩ VIDEO ⇔ S-VIDEO ⇔ COMPONENT (2) Select the audio port to be interlocked with the input port using the ◀/▶ buttons. 1 ⇔ 2 ⇔ 3 ⇔ ✕ ↑—————↑ When ✕ is selected to an input port, any audio ports do not work interlocking with the input port.



SCREEN menu (continued)

Item	Description								
START UP	Using the ▲/▼ buttons switches the mode for the start-up screen. The start-up screen is a screen displayed when no signal or an unsuitable signal is detected.								
	MyScreen ⇄ ORIGINAL ⇄ TURN OFF 								
	<table border="1" style="width: 100%; border-collapse: collapse;"> <thead> <tr> <th style="width: 50%;"></th> <th style="width: 50%;">Feature</th> </tr> </thead> <tbody> <tr> <td data-bbox="318 416 535 472">MyScreen</td> <td data-bbox="535 416 1021 472">Screen can be registered by the MyScreen item (□38).</td> </tr> <tr> <td data-bbox="318 472 535 499">ORIGINAL</td> <td data-bbox="535 472 1021 499">Screen preset as the standard screen.</td> </tr> <tr> <td data-bbox="318 499 535 528">TURN OFF</td> <td data-bbox="535 499 1021 528">Plain black screen.</td> </tr> </tbody> </table>		Feature	MyScreen	Screen can be registered by the MyScreen item (□38).	ORIGINAL	Screen preset as the standard screen.	TURN OFF	Plain black screen.
		Feature							
	MyScreen	Screen can be registered by the MyScreen item (□38).							
ORIGINAL	Screen preset as the standard screen.								
TURN OFF	Plain black screen.								
<ul style="list-style-type: none"> • To avoid remaining as an afterimage, the MyScreen or ORIGINAL screen will change to the BLANK screen (□36) after several minutes. If also the BLANK screen is the MyScreen or ORIGINAL, the plain black screen is instead used. 									
<ul style="list-style-type: none"> • When the TURN ON is selected to the MyScreen PASSWORD of SECURITY item in OPTION menu (□46), the START UP is fixed to MyScreen. 									

(continued on next page)

SCREEN menu (continued)

Item	Description
<p>MyScreen</p>	<p>This item allows you to capture an image for use as a MyScreen image which can be used as the BLANK screen and START UP screen. Display the image you want to capture before executing the following procedure.</p> <ol style="list-style-type: none"> 1. Selecting this item displays a dialog titled “MyScreen”. It will ask you if you start capturing an image from the current screen. <div data-bbox="748 357 1021 416" data-label="Image"> </div> <p>Please wait for the target image to be displayed, and press the ENTER button when the image is displayed. The image will freeze and the frame for capturing will appear. To stop performing, press the RESET or ESC button.</p> 2. Using the ▲/▼/◀/▶ buttons adjusts the frame position. Please move the frame to the position of the image which you want to use. The frame may not be able to be moved for some input signals. To start registration, press the ENTER button. <div data-bbox="748 576 1021 783" data-label="Image"> </div> <p>To restore the screen and return to the previous dialog, press the RESET or ESC button. Registration takes several minutes. When the registration is completed, the registered screen and the following message are displayed for several seconds: “MyScreen registration is finished.” If the registration failed, the following message is displayed: “A capturing error has occurred. Please try again.”</p> <ul style="list-style-type: none"> • This function cannot be selected when the TURN ON is selected to the MyScreen Lock item (see below). • This function cannot be selected when TURN ON is selected to the MyScreen PASSWORD of SECURITY item in OPTION menu (see 46).
<p>MyScreen Lock</p>	<p>Using the ▲/▼ buttons turns on/off the MyScreen lock function. TURN ON ⇔ TURN OFF</p> <p>When the TURN ON is selected, the MyScreen item is locked. Use this function for protecting the current MyScreen.</p> <ul style="list-style-type: none"> • This function cannot be selected when TURN ON is selected to the MyScreen PASSWORD of SECURITY item in OPTION menu (see 46).

(continued on next page)

SCREEN menu (continued)

Item	Description
MESSAGE	<p>Using the ▲/▼ buttons turns on/off the message function. TURN ON ⇔ TURN OFF</p> <p>When the TURN ON is selected, the following message function works. “AUTO IN PROGRESS” while automatically adjusting “NO INPUT IS DETECTED” “SYNC IS OUT OF RANGE” “Searching...” while searching for the input “Detecting...” while an input signal is detected The indication of the input signal displayed by changing The indication of the aspect ratio displayed by changing The indication of the PICTURE MODE displayed by changing The indication of the MY MEMORY displayed by changing The indication of “FREEZE” and “II” while the projector is in the FREEZE mode.</p> <ul style="list-style-type: none"> • If the projector goes into the FREEZE mode while the TURN OFF is selected, the picture on screen is frozen without any messages, which is not a malfunction. (U21)
SOURCE NAME	<p>Each input port for this projector can have a name applied to it.</p> <ol style="list-style-type: none"> (1) Use the ▲/▼ buttons on the SCREEN menu to select SOURCE NAME and press the ► button. The SOURCE NAME menu will be displayed. (2) Use the ▲/▼ buttons on the SOURCE NAME menu to select the port to be named and press the ► button. Right side of the menu is blank until a name is specified. The SOURCE NAME dialog will be displayed. (3) The current name will be displayed on the first line. Use the ▲/▼/◀/▶ buttons and the ENTER or INPUT button to select and enter characters. The RESET button can be used to erase 1 character at a time. The name can be a maximum of 16 characters. (4) To change an already inserted character, press the ▲ button while the cursor is on the [A-N] row to move the cursor to the name displayed on the first line and use the ◀/▶ buttons to select character to be changed. Once a character in the name is selected use the ▼ button to move the cursor back down to the character entry area to select and enter characters as described above. (5) Select <input type="checkbox"/> and press ENTER or INPUT buttons when finished entering text. <p>To revert to the previous name without saving changes press the ESC or ◀ button and the INPUT button simultaneously.</p>







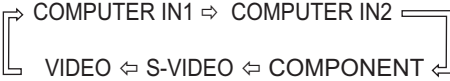

OPTION menu

From the OPTION menu, items shown in the table below can be performed.

Select an item using the ▲/▼ cursor buttons, and press the ► cursor button or ENTER button to execute the item, except for the items LAMP TIME and FILTER TIME. Then perform it according to the following table.



Item	Description
<p>AUTO SEARCH</p>	<p>Using the ▲/▼ buttons turns on/off the automatic signal search function. TURN ON ⇔ TURN OFF</p> <p>When the TURN ON is selected, detecting no signal automatically cycles through input ports in the following order. The search is started from the current port. Then when an input is found, the projector will stop searching and display the image.</p> <p style="text-align: center;">  </p>
<p>AUTO KEYSTONE </p>	<p>Using the ▲/▼ buttons turns on/off the automatic keystone function. TURN ON ⇔ TURN OFF</p> <p>TURN ON : Automatic keystone distortion correction will be executed whenever changing the slant of the projector. TURN OFF : This function is disabled. Please execute the AUTO KEYSTONE  EXECUTE in the SETUP Menu for automatic keystone distortion correction.</p> <ul style="list-style-type: none"> • When the projector is suspended from the ceiling this feature will not function properly so select the TURN OFF. • This function will be unavailable when the Transition Detector is on (49).
<p>AUTO ON</p>	<p>Using the ▲/▼ buttons turns on/off the AUTO ON function. TURN ON ⇔ TURN OFF</p> <p>When set to the TURN ON, the lamp in projector will be automatically turned on without the usual procedure (15), only when the projector is supplied with the power after the power was cut while the lamp was on.</p> <ul style="list-style-type: none"> • This function does not work as long as the power has been supplied to the projector while the lamp is off. • After turning the lamp on by the AUTO ON function, if neither input nor operation is detected for about 30 minutes, the projector is turned off, even though the AUTO OFF function (41) is disabled.

(continued on next page)

OPTION menu (continued)

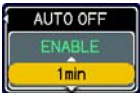
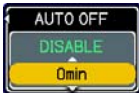
Item	Description
<p>AUTO OFF</p>	<p>Using the ▲/▼ buttons adjusts the time to count down to automatically turn the projector off. Long (max. 99 minutes) ⇔ Short (min. 0 minute = DISABLE)</p> <div style="display: flex; justify-content: space-around; align-items: center;">   </div> <p>When the time is set to 0, the projector is not turned off automatically. When the time is set to 1 to 99, and when the passed time with no-signal or an unsuitable signal reaches at the set time, the projector lamp will be turned off. If one of the projector's buttons or the remote control buttons is pressed or one of the commands (except get commands) is transmitted to the CONTROL port during the corresponding time, projector will not be turned off. Please refer to the section "Turning off the power" (15).</p>
<p>LAMP TIME</p>	<p>The lamp time is the time counted after the last resetting. It is shown in OPTION menu as the usage time of the lamp. Pressing RESET button or the ► button displays a dialog. To reset the lamp time, select RESET using the ▲ button. RESET ⇔ CANCEL</p> <ul style="list-style-type: none"> • Please reset the lamp time only when you have replaced the lamp, for a suitable indication about the lamp. • For the lamp replacement, see the section "Lamp" (54).
<p>FILTER TIME</p>	<p>The filter time is the time counted after the last resetting. It is shown in the OPTION menu as the usage time of the air filter. Pressing the RESET button or the ► button displays a dialog. To reset the filter time, select the RESET using the ▲ button. RESET ⇔ CANCEL</p> <ul style="list-style-type: none"> • Please reset the filter time only when you have cleaned or replaced the air filter, for a suitable indication about the air filter. • For the air filter cleaning, see the section "Air filter" (56).



(continued on next page)

OPTION menu (continued)

Item	Description
<p>MY BUTTON</p>	<p>This item is to assign one of the following functions to MY BUTTON 1 and 2 on the remote control (46). Choose 1 or 2 on the MY BUTTON menu using the ◀/▶ button first. Then using the ▲/▼ buttons sets one of the following functions to the chosen button.</p> <ul style="list-style-type: none"> • COMPUTER1: Sets port to COMPUTER IN1. • COMPUTER2: Sets port to COMPUTER IN2. • COMPONENT: Sets port to COMPONENT(Y, Cb/Pb, Cr/Pr) • S-VIDEO: Sets port to S-VIDEO. • VIDEO: Sets port to VIDEO. • e-SHOT: Displays the e-SHOT menu (52). • INFORMATION: Displays a dialog of INPUT -INFORMATION- or NETWORK -INFORMATION- (44, 53). <p>The displayed dialog is switched as below every time the MY BUTTON is pushed.</p> <p>When an input signal is found: INPUT -INFORMATION- ⇄ NETWORK -INFORMATION- ⇄ OFF</p> <p>When an input signal is not found: NETWORK -INFORMATION- ⇄ OFF</p> <ul style="list-style-type: none"> • AUTO KEYSTONE [] EXECUTE: Performs automatic keystone distortion correction (34). • MY MEMORY: Loads one of adjustment data stored (27). <p>When more than one data are saved, the adjustment changes every time the MY BUTTON is pushed.</p> <p>When no data is saved in memory, the dialog "No saved data" appears.</p> <p>When the current adjustment is not saved to memory, the dialog as shown in the right appears.</p> <p>If you want to keep the current adjustment, please press the ◀ button to quit. Otherwise loading a data will lose the current adjusted condition.</p> <ul style="list-style-type: none"> • PICTURE MODE: Changes the PICTURE MODE (24). • FILTER RESET: Displays the filter time reset confirmation dialogue (41). • VOLUME+: Set the volume up. • VOLUME-: Set the volume down.
<p>SERVICE</p>	<p>Selecting this item displays the SERVICE menu. Select an item using the ▲/▼ buttons, and press the ▶ button or the ENTER button to execute the item.</p> <p>FAN SPEED ⇄ AUTO ADJUST ⇄ GHOST ⇄ FILTER MESSAGE ⇄ KEY LOCK</p> <p>↳ FACTORY RESET ⇄ I NFORMATION ⇄ REMOTE FREQ. ◀</p> <p>FAN SPEED</p> <p>Using the ▲/▼ buttons switches the rotation speed of the cooling fans. The HIGH is the mode for use at highlands etc. Note that the projector is noisier when the HIGH is selected.</p> <p>HIGH ⇄ NORMAL</p> 



(continued on next page)

OPTION menu (continued)

Item	Description
<p>SERVICE (continued)</p>	<p>AUTO ADJUST Using the ▲/▼ buttons enables/disables the automatic adjustment. When DISABLE is selected, the automatic adjustment feature is disabled, although rough adjustment is automatically performed depending on the basic setting.</p> <p>FINE ⇄ FAST ⇄ DISABLE</p>  <p>FINE: Finer tuning including H.SIZE adjustment. FAST: Faster tuning, setting H.SIZE to prearranged data for the input signal.</p> <ul style="list-style-type: none"> Depending on conditions, such as input image, signal cable to the projector, environment around the projector, etc., the automatic adjustment may not work correctly. In such a case, please choose DISABLE to disable the automatic adjustment, and make adjustment manually.
	<p>GHOST</p> <ol style="list-style-type: none"> Select a color element of ghost using the ◀/▶ buttons. Adjust the selected element using the ▲/▼ buttons to disappear ghost.
	<p>FILTER MESSAGE Use the ▲/▼ button to set the timer for the interval to show the message for cleaning up the air filter.</p> <p>50h ⇄ 100h ⇄ 200h ⇄ 300h ⇄ 400h ⇄ 500h TURN OFF ⇄ 800h ⇄ 700h ⇄ 600h</p>  <p>After choosing a choice except TURN OFF, the message “REMINDER *** HRS PASSED AFTER THE LAST FILTER CHECK” will appear after the timer reaches the interval time set by this feature (59).</p> <p>When the TURN OFF is chosen, the message will not appear. Utilize this feature to keep the air filter clean, setting the suitable time according to your environment of this projector.</p> <ul style="list-style-type: none"> Please check and clean the air filter periodically, even if there is no message. If the air filter becomes to be blocked by dust or others, the internal temperature will rise, which could cause malfunction, or reduce the lifetime of the projector. Please be careful with the operating environment of the projector and the condition of the air filter.





(continued on next page)

OPTION menu (continued)

Item	Description
<p>SERVICE (continued)</p>	<p>KEY LOCK Using the ▲/▼ buttons turns on/off the key lock feature. When TURN ON is selected, the buttons on the projector except the STANDBY/ON button are locked. TURN ON ⇔ TURN OFF</p> <ul style="list-style-type: none"> • Please use to avoid a mischief and touching accidentally. This function does not have any effect on the remote control. <p>REMOTE FREQ. Use the ▲/▼ button to change the projector's remote sensor setting. 1:NORMAL ⇔ 2:HIGH</p> <p>Items with a checkmark are on. The factory default setting is for both 1:NORMAL and 2: HIGH to be on. If the remote control does not function correctly set this to either only 1 or only 2 (📖14).</p> <p>Neither can be turned off at the same time.</p>  <p>INFORMATION Selecting this item displays a dialog titled "INPUT -INFORMATION-". It shows the information about the current input.</p>  <ul style="list-style-type: none"> • The "FRAME LOCK" message on the dialog means the frame lock function is working (📖32). • This item can't be selected for no signal and sync out. <p>FACTORY RESET Selecting RESET using the button ▲ performs this function. By this function, all the items in all of menus will collectively return to the initial setting. Note that the items LAMP TIME, FILTER TIME, LANGUAGE, SECURITY and NETWORK settings are not reset. RESET ⇔ CANCEL</p>

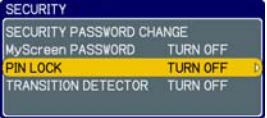

(continued on next page)

OPTION menu (continued)

Item	Description
<p>SECURITY</p>	<p>This projector is equipped with security functions. User registration is required before using the security functions. Please contact your local dealer.</p> <p>1. Using Security Features</p> <p>1.1 Inputting the PASSWORD</p> <p>1.1-1 Use the ▲/▼ buttons on the OPTION menu to select SECURITY and press the ► button. The ENTER PASSWORD box will be displayed.</p>  <p>The factory default PASSWORD is 8471. This PASSWORD can be changed (1.2 Changing the PASSWORD (below)).</p> <ul style="list-style-type: none"> It is strongly recommended the factory default PASSWORD to be changed as soon as possible. <p>1.1-2 Use the ▲/▼/◀/▶ buttons to enter the registered PASSWORD. Move the cursor to the right side of the ENTER PASSWORD box and press the ► button to display the SECURITY menu.</p>  <p>If an incorrect PASSWORD is input the ENTER PASSWORD box will be displayed again. If incorrect PASSWORD is input 3 times the projector will turn off. Afterwards the projector will turn off every time an incorrect PASSWORD is input.</p> <p>1.2 Changing the PASSWORD</p> <p>1.2-1 Use the ▲/▼ buttons on the SECURITY menu to select SECURITY PASSWORD CHANGE and press the ► button to display the ENTER NEW PASSWORD box.</p>  <p>1.2-2 Use the ▲/▼/◀/▶ buttons to enter the new PASSWORD.</p> <p>1.2-3 Move the cursor to the right side of the ENTER NEW PASSWORD box and press the ► button to display the NEW PASSWORD AGAIN box, enter the same PASSWORD again.</p>  <p>1.2-4 Move the cursor to the right side of the NEW PASSWORD AGAIN box and press the ► button and the NOTE NEW PASSWORD box will be displayed for about 20 seconds, please make note of the PASSWORD during this time.</p>  <p>Pressing the ENTER button will close the NOTE NEW PASSWORD box.</p> <ul style="list-style-type: none"> Please do not forget your PASSWORD.

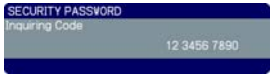
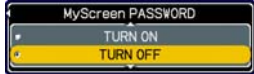

(continued on next page)

OPTION menu (continued)

Item	Description
<p>SECURITY (continued)</p>	<p>1.3 If you have forgotten your PASSWORD</p> <p>1.3-1 Follow the procedure in 1.1-1 to display the ENTER PASSWORD box.</p> <p>1.3-2 While the ENTER PASSWORD box is displayed, press and hold the RESET button for about 3 seconds or press and hold the INPUT and ► buttons on the projector for about 3 seconds. The 10-digit Inquiring Code will be displayed.</p> <ul style="list-style-type: none"> • If there is no key input for about 55 seconds while the Inquiring Code is displayed the menu will close. If necessary repeat the process from 1.3-1. <p>1.3-3 Contact your dealer with the 10-digit Inquiring Code. Your PASSWORD will be sent after your user registration information is confirmed.</p> <p>2. Using the MyScreen PASSWORD Function</p> <p>The MyScreen PASSWORD function can be used to prohibit access to the MyScreen function and prevent the currently registered MyScreen image from being overwritten.</p> <p>2.1 Turning on the MyScreen PASSWORD Function</p> <p>2.1-1 Use the ▲/▼ buttons on the SECURITY menu to select MyScreen PASSWORD and press the ► button to display the MyScreen PASSWORD on/off menu.</p> <p>2.2 Setting the PASSWORD</p> <p>2.2-1 Display the MyScreen PASSWORD on/off menu using the procedure in 2.1-1.</p> <p>2.2-2 Use the ▲/▼ buttons on the MyScreen PASSWORD on/off menu to select TURN ON. The ENTER PASSWORD box (small) will be displayed.</p> <p>2.2-3 Use the ▲/▼/◀/▶ buttons to enter the PASSWORD. Move the cursor to the right side of the ENTER PASSWORD box (small) and press the ► button to display the PASSWORD AGAIN box, enter the same PASSWORD again.</p>
	   



(continued on next page)

OPTION menu (continued)

Item	Description
<p>SECURITY (continued)</p>	<p>2.2-4 Move the cursor to the right side of the PASSWORD AGAIN box and press the ► button to display the PASSWORD for about 20 seconds, please make note of the PASSWORD during this time.</p>  <p>Pressing the ENTER button will return to MyScreen PASSWORD on/off menu.</p> <p>When a PASSWORD is set for MyScreen:</p> <ul style="list-style-type: none"> • The MyScreen registration function (and menu) will be unavailable. • The MyScreen Lock function (and menu) will be unavailable. • The START UP setting will be locked on MyScreen (and the menu will be unavailable). <p>Turning the MyScreen PASSWORD off will allow normal operation of both functions.</p> <ul style="list-style-type: none"> • Please do not forget your MyScreen PASSWORD. <p>2.3 Turning the PASSWORD off</p> <p>2.3-1 Follow the procedure in 2.1-1 to display the MyScreen PASSWORD on/off menu.</p> <p>2.3-2 Select TURN OFF to display the ENTER PASSWORD box (large). Enter the registered PASSWORD and the screen will return to the MyScreen on/off menu.</p> <p>If an incorrect PASSWORD is input the menu will close. If necessary repeat the process from 2.3-1.</p> <p>2.4 If you have forgotten your PASSWORD</p> <p>2.4-1 Follow the procedure in 2.1-1 to display the MyScreen PASSWORD on/off menu.</p> <p>2.4-2 Select TURN OFF to display the ENTER PASSWORD box (large). The 10-digit Inquiring Code will be displayed inside the box.</p>  <p>2.4-3 Contact your dealer with the 10-digit Inquiring Code. Your PASSWORD will be sent after your user registration information is confirmed.</p> <p>3. Using the PIN LOCK Function</p> <p>PIN LOCK is a function which prevents the projector from being used unless a registered Code is input.</p> <p>3.1 Registering the PIN Code</p> <p>3.1-1 Use the ▲/▼ buttons on the SECURITY menu to select PIN LOCK and press the ► button or the ENTER button to display the PIN LOCK on/off menu.</p> 





(continued on next page)

OPTION menu (continued)

Item	Description
<p>SECURITY (continued)</p>	<p>3.1-2 Use the ▲/▼ buttons on the PIN LOCK on/off menu to select TURN ON and the PIN BOX will be displayed.</p>  <p>3.1-3 Input a 4 part PIN Code using the ▲, ▼, ◀, ▶, COMPUTER and INPUT buttons. A PIN Code again box will appear. Reenter the same PIN Code. This will complete the PIN Code registration.</p> <ul style="list-style-type: none"> • If there is no key input for about 55 seconds while the PIN BOX or the PIN Code again box are displayed the menu will close. If necessary repeat the process from 3.1-1. <p>Afterwards, anytime the projector is restarted after AC power is turned off the PIN BOX will be displayed. Enter the registered PIN Code. The projector can be used after entering the registered PIN Code. If an incorrect PIN Code is input the PIN BOX will be displayed again. If an incorrect PIN Code is input 3 times the projector will turn off. Afterwards the projector will turn off every time an incorrect PIN Code is input. The projector will also turn off if there is no key input for about 5 minutes while the PIN BOX is displayed.</p> <p>This function will activate only when the projector is started after AC power is turned off.</p> <ul style="list-style-type: none"> • Please do not forget your PIN Code. <p>3.2 Turning Off the PIN LOCK Function</p> <p>3.2-1 Follow the procedure in 3.1-1 to display the PIN LOCK on/off menu. Use the ▲/▼ buttons to select TURN OFF and the PIN BOX will be displayed. Enter the registered PIN Code to turn the PIN LOCK function off. If an incorrect PASSWORD is entered the menu will close.</p> <p>3.3 If you have forgotten your PIN Code</p> <p>3.3-1 While the PIN BOX is displayed, press and hold the RESET button for 3 seconds or press and hold the INPUT and ▶ buttons for 3 seconds. The 10-digit Inquiring Code will be displayed.</p> <ul style="list-style-type: none"> • If it passes for about 5 minutes after the PIN BOX is displayed the projector will turn off. <p>3.3-2 Contact your dealer with the 10-digit Inquiring Code. Your PASSWORD will be sent after your user registration information is confirmed.</p> 

(continued on next page)

OPTION menu (continued)

Item	Description
<p>SECURITY (continued)</p>	<p>4. Using the Transition Detector Function</p> <p>While the Transition Detector function is ON, when power switch is started to supply to the projector, it might react as below.</p> <ul style="list-style-type: none"> • Transition Detector alarm shown below might appear on screen, if the projector has been moved or re-installed. • Transition Detector alarm might appear on screen, if the MIRROR setting has been changed. • Keystone adjustment feature has been prohibited as long as the Transition Detector function is ON. <p>4.1 Turning On the Transition Detector Function</p> <p>4.1-1 Use the ▲/▼ buttons on the SECURITY menu to select TRANSITION DETECTOR and press the ► or the ENTER button to display the TRANSITION DETECTOR on/off menu. Select TURN ON and the current angle and mirror setting will be recorded.</p>  <ul style="list-style-type: none"> • This feature may not function properly if the projector is not in a stable position when TURN ON is selected. <p>4.1-2 If this function is set to TURN ON when the vertical angle of the projector or mirror setting at which the projector is turned on is different than the previously recorded the Transition Detector alarm will be displayed and the projector will not display the input signal.</p>  <p>Set the Transition Detector off in the SECURITY menu to display the input signal.</p> <p>If the Transition Detector alarm is displayed for about 5 minutes the lamp will turn off. This function will activate only when the projector is started after turning off the AC power.</p> <p>4.2 Setting the Transition Detector PASSWORD</p> <p>4.2-1 Use the ▲/▼ buttons on the SECURITY menu to select TRANSITION DETECTOR and press the ► or the ENTER button to display the TRANSITION DETECTOR on/off menu.</p> <p>4.2-2 Use the ▲/▼ buttons on the TRANSITION DETECTOR on/off menu to select TURN ON. The ENTER PASSWORD box (small) will be displayed.</p>  <p>4.2-3 Use the ▲/▼/◀/▶ buttons to enter a PASSWORD. Move the cursor to the right side of the ENTER PASSWORD box (small) and press the ► button to display the PASSWORD AGAIN box, enter the same PASSWORD again.</p> 

(continued on next page)

OPTION menu (continued)

Item	Description
<p>SECURITY (continued)</p>	<p>4.2-4 Move the cursor to the right side of the PASSWORD AGAIN box and press the ► button to display the PASSWORD for about 20 seconds, please make note of the PASSWORD during this time.</p> <p>Pressing the ENTER button will return to the TRANSITION DETECTOR on/off menu.</p> <ul style="list-style-type: none"> • Please do not forget your Transition Detector PASSWORD.
	<p>4.3 Setting the Transition Detector off</p> <p>4.3-1 Follow the procedure in 4.1-1 to display the TRANSITION DETECTOR on/off menu.</p> <p>4.3-2 Select TURN OFF to display the ENTER PASSWORD box (large). Enter the registered PASSWORD and the screen will return to the TRANSITION DETECTOR on/off menu. If an incorrect PASSWORD is input the menu will close. If necessary repeat the process from 4.3-1.</p>
	<p>4.4 If you have forgotten your PASSWORD</p> <p>4.4-1 Follow the procedure in 4.1-1 to display the TRANSITION DETECTOR on/off menu.</p> <p>4.4-2 Select TURN OFF to display the ENTER PASSWORD box (large). The 10-digit Inquiring Code will be displayed inside the box.</p>
	<p>4.4-3 Contact your dealer with the 10-digit Inquiring Code. Your PASSWORD will be sent after your user registration information is confirmed.</p>



NETWORK menu

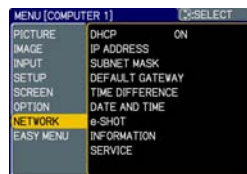

Remember that incorrect network settings on this projector may cause trouble on the network. Be sure to consult with your network administrator before connecting to an existing access point on your network.



From the NETWORK menu, items shown in the table below can be performed.

Select an item using the ▲/▼ cursor buttons, and press the ► cursor button or ENTER button to execute the item. Then perform it according to the following table.



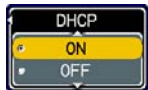

See the **User's Manual - Network Guide** for details of network operation.

NOTE • The factory default setting for DHCP is ON. You do not have to set up DHCP, IP ADDRESS, SUBNET MASK or DEFAULT GATEWAY if your network has DHCP enabled. (📖 **User's Manual - Network Guide**)

• If you are not utilizing SNTP (📖 **User's Manual - Network Guide**), then you must set the date and time during the initial installation. Please refer to the item DATE AND TIME in the following table (📖52).

Item	Operation
<p>DHCP (Dynamic Host Configuration Protocol)</p>	<p>Use the ▲/▼ buttons to turn DHCP on/off ON ⇔ OFF</p>  <ul style="list-style-type: none"> • Select OFF when the network does not have DHCP enabled. • When the DHCP setting changes to ON, it takes a little time to obtain IP address from DHCP server. • Auto IP function will be assigned an IP address if the projector could not obtain an IP address from server even if DHCP is ON.
<p>IP ADDRESS</p>	<p>Use the ▲/▼/◀/▶ buttons to enter the IP address. This function can only be used when DHCP is set to OFF.</p>  <ul style="list-style-type: none"> • The IP address is the number that identifies this projector on the network. You cannot have two devices with the same IP address on the same network. • The IP ADDRESS "0.0.0.0" is prohibited.
<p>SUBNET MASK</p>	<p>Use the ▲/▼/◀/▶ buttons to enter the same subnet mask used by your PC. This function can only be used when DHCP is set to OFF.</p>  <ul style="list-style-type: none"> • The SUBNET MASK "0.0.0.0" is prohibited.

NETWORK menu (continued)

Item	Operation
<p>DEFAULT GATEWAY</p>	<p>Use the ▲/▼/◀/▶ buttons to enter the default gateway (a node on a computer network that serves as an access point to another network) address. This function can only be used when DHCP is set to OFF.</p> 
<p>TIME DIFFERENCE</p>	<p>Use the ▲/▼ buttons to enter the time difference. Set the same time difference as the one set on your PC. If unsure, consult your IT manager. Use the ◀ button to return to the menu after setting the TIME DIFFERENCE.</p> 
<p>DATE AND TIME</p>	<p>Use the ▲/▼/◀/▶ buttons to enter the Year (last two digits), Month, Date, Hour and Minute. • The projector will override this setting and retrieve the date and time information from the Time server when SNTP is enabled. (📘) “Date/Time Settings” section of the User’s Manual - Network Guide)</p>
<p>e-SHOT</p>	<p>Use the ▲/▼ buttons to select an item and the ▶ or ENTER button to display the image.</p> <ul style="list-style-type: none"> Image1 Image2 Image3 Image4 <p>File names of registered images are displayed by 16 characters or less. Example: DEMONSTRATION-01 "NEW" stamp is added to the head of line when the image is registered newly. After the image is displayed, "NEW" stamp will be erased. Once an image is displayed, you can use the ▲/▼ buttons to page through the images. Use the ◀ or ESC button to return to the menu.</p> <p>Pressing the RESET button on the remote control while an image is being displayed will display the RESET menu. The displayed image can be deleted from the RESET menu using the ENTER button on the remote control or the INPUT button on the projector. If you do not wish to delete the image use the ESC button on the remote control or push the ◀ and INPUT buttons on the projector at the same time.</p> <ul style="list-style-type: none"> • Items with no image stored cannot be selected. • Images can be changed using the ▲/▼ buttons while the image data downloads.   

NETWORK menu (continued)

Item	Operation														
<p>INFORMATION</p>	<p>Selecting this item displays the NETWORK -INFORMATION- dialog for confirming the network settings.</p> <div data-bbox="719 245 1021 384" style="border: 1px solid black; padding: 5px; margin: 10px 0;"> <p style="text-align: center; margin: 0;">NETWORK -INFORMATION-</p> <table border="0" style="width: 100%; border-collapse: collapse;"> <tr><td style="padding: 2px;">NAME</td><td style="padding: 2px;"></td></tr> <tr><td style="padding: 2px;">IP ADDRESS</td><td style="padding: 2px;">192.168.1.254</td></tr> <tr><td style="padding: 2px;">SUBNET MASK</td><td style="padding: 2px;">255.255.255.0</td></tr> <tr><td style="padding: 2px;">DEFAULT GATEWAY</td><td style="padding: 2px;">0.0.0.0</td></tr> <tr><td style="padding: 2px;">MAC ADDRESS</td><td style="padding: 2px;">00-00-87-56-AC-7C</td></tr> <tr><td style="padding: 2px;">TIME DIFFERENCE</td><td style="padding: 2px;">GMT 00:00</td></tr> <tr><td style="padding: 2px;">DATE AND TIME</td><td style="padding: 2px;">2000/1/1 8:15</td></tr> </table> </div> <ul style="list-style-type: none"> • Only the first 16 characters of the projector name are displayed. • Nothing (blank) is shown in the NAME field until you setup the item. For setup, please refer to “Network Settings” section of User’s Manual - Network Guide. • When the voltage level of the battery for the internal clock decreases, set time may become incorrect even though accurate date and time are input. Replace a battery through the following the instructions. (p57) • IP ADDRESS, SUBNET MASK and DEFAULT GATEWAY indicate “0.0.0.0” when DHCP is ON and the projector has not gotten address from DHCP server. 	NAME		IP ADDRESS	192.168.1.254	SUBNET MASK	255.255.255.0	DEFAULT GATEWAY	0.0.0.0	MAC ADDRESS	00-00-87-56-AC-7C	TIME DIFFERENCE	GMT 00:00	DATE AND TIME	2000/1/1 8:15
NAME															
IP ADDRESS	192.168.1.254														
SUBNET MASK	255.255.255.0														
DEFAULT GATEWAY	0.0.0.0														
MAC ADDRESS	00-00-87-56-AC-7C														
TIME DIFFERENCE	GMT 00:00														
DATE AND TIME	2000/1/1 8:15														
<p>SERVICE</p>	<p>Executing this item restarts and initializes the network functions. Choose the RESTART using the button ►.</p> <div data-bbox="549 772 819 855" style="border: 1px solid black; padding: 5px; margin: 10px 0;"> <p style="text-align: center; margin: 0;">SERVICE</p> <div style="border: 1px solid black; background-color: yellow; padding: 2px; text-align: center; margin: 2px 0;">RESTART</div> </div> <p>Then use the button ▲ to execute.</p> <div data-bbox="568 901 794 1018" style="border: 1px solid black; padding: 5px; margin: 10px 0;"> <p style="text-align: center; margin: 0;">RESTART</p> <div style="border: 1px solid black; background-color: gray; padding: 2px; text-align: center; margin: 2px 0;">EXECUTE</div> <div style="border: 1px solid black; background-color: yellow; padding: 2px; text-align: center; margin: 2px 0;">CANCEL</div> </div> <p>Network will be once cut off when choose restart. If DHCP is selected on, IP address may be changed. After selecting RESTART, NETWORK menu may not be controlled approx. 30 seconds.</p>														

Maintenance

Lamp

A lamp has finite product life. Using the lamp for long periods of time could cause the pictures darker or the color tone poor. Note that each lamp has a different lifetime, and some may burst or burn out soon after you start using them.

Preparation of a new lamp and early replacement are recommended. To prepare a new lamp, contact your dealer and tell the lamp type number.

Type number : DT00841

Replacing the lamp

1. Turn the projector off, and unplug the power cord.
Allow the projector to cool for at least 45 minutes.
2. Prepare a new lamp.
If the projector is mounted on a ceiling, or if the lamp has broken, also ask the dealer to replace the lamp.

In case of replacement by yourself, follow the following procedure.

3. Loosen the screw (marked by arrow) of the lamp cover and then slide the lamp cover to the side to remove it.
4. Loosen the 2 screws (marked by arrow) of the lamp, and slowly pick up the lamp by the handles.
5. Insert the new lamp, and retighten firmly the 2 screws of the lamp that are loosened in the previous process to lock it in place.
6. Slide the lamp cover back in place and firmly fasten the screw of the lamp cover.
7. Turn the projector on and reset the lamp time using the LAMP TIME item in the OPTION menu.
 - (1) Press the MENU button to display a menu.
 - (2) Point at the Go to Advanced Menu ... in the menu using the ▼/▲ button, then press the ► button.
 - (3) Point at the OPTION in the left column of the menu using the ▼/▲ button, then press the ► button.
 - (4) Point at the LAMP TIME using the ▼/▲ button, then press the ► button. A dialog will appear.
 - (5) Press the ▲ button to select RESET on the dialog. It performs resetting the lamp time.

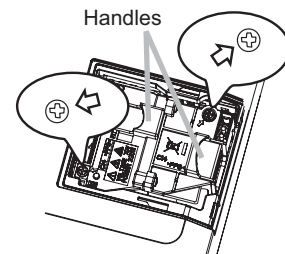
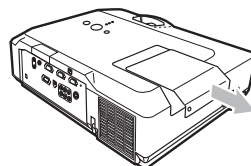
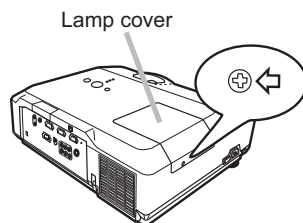

⚠ CAUTION ► Do not touch any inner space of the projector, while the lamp is taken out.

NOTE • Please reset the lamp time only when you have replaced the lamp, for a suitable indication about the lamp.

Lamp (continued)**Lamp warning**

 **HIGH VOLTAGE**  **HIGH TEMPERATURE**  **HIGH PRESSURE**

⚠ WARNING ▶ The projector uses a high-pressure mercury glass lamp. The lamp can break with a loud bang, or burn out, if jolted or scratched, handled while hot, or worn over time. Note that each lamp has a different lifetime, and some may burst or burn out soon after you start using them. In addition, when the bulb bursts, it is possible for shards of glass to fly into the lamp housing, and for gas containing mercury to escape from the projector's vent holes.

▶ **About disposal of a lamp:** This product contains a mercury lamp; do not put it in a trash. Dispose of it in accordance with environmental laws.

- For lamp recycling, go to www.lamprecycle.org. (in the US)
- For product disposal, contact your local government agency or www.eiae.org (in the US) or www.epsc.ca (in Canada).

For more information, call your dealer.



Disconnect
the plug
from the
power
outlet

- If the lamp should break (it will make a loud bang when it does), unplug the power cord from the outlet, and make sure to request a replacement lamp from your local dealer. Note that shards of glass could damage the projector's internals, or cause injury during handling, so please do not try to clean the projector or replace the lamp yourself.
- If the lamp should break (it will make a loud bang when it does), ventilate the room well, and make sure not to breathe the gas that comes out of the projector vents, or get it in your eyes or mouth.
- Before replacing the lamp, turn the projector off and unplug the power cord, then wait at least 45 minutes for the lamp to cool sufficiently. Handling the lamp while hot can cause burns, as well as damaging the lamp.



- Never unscrew except the appointed (marked by an arrow) screws.
- Do not open the lamp cover while the projector is suspended from above. This is dangerous, since if the lamp's bulb has broken, the shards will fall out when the cover is opened. In addition, working in high places is dangerous, so ask your local dealer to have the lamp replaced even if the bulb is not broken.
- Do not use the projector with the lamp cover removed. At the lamp replacing, make sure that the screws are screwed in firmly. Loose screws could result in damage or injury.



- Use only the lamp of the specified type.
- If the lamp breaks soon after the first time it is used, it is possible that there are electrical problems elsewhere besides the lamp. If this happens, contact your local dealer or a service representative.
- Handle with care: jolting or scratching could cause the lamp bulb to burst during use.
- Using the lamp for long periods of time could cause it dark, not to light up or to burst. When the pictures appear dark, or when the color tone is poor, please replace the lamp as soon as possible. Do not use old (used) lamps; this is a cause of breakage.

Air filter

Please check and clean the air filter periodically. When the indicators or a message prompts you to clean the air filter, comply with it as soon as possible. Replace the air filter when it is damaged or too soiled. To prepare a new air filter, contact your dealer and tell the air filter type number.

Type number : MU04951

When you replace the lamp, please replace the air filter. An air filter of specified type will come together with a replacement lamp for this projector.

Cleaning the air filter

1. Turn the projector off, and unplug the power cord. Allow the projector to sufficiently cool down.
2. Use a vacuum cleaner on and around the filter cover.
3. Pull the filter cover knobs while lifting it. The filter unit which consists of the filter' cover, air filter and filter frame will come off.
4. Use a vacuum cleaner for the filter vent of the projector and the filter frame side of the filter unit. If the air filter is damaged or too soiled, replace it according to the following procedure number 5 to 7. Otherwise, please jump to the procedure number 8.
5. Pull the filter frame' knob up while holding the filter cover. The filter frame will come off and the air filter will appear.
6. Replace the air filter with new one.
7. Put the filter frame back.
8. Put the filter unit back into the projector.
9. Turn the projector on and reset the filter time using the FILTER TIME item in the EASY MENU.
 - (1) Press the MENU button to display a menu.
 - (2) Point at the FILTER TIME using the ▼/▲ button, then press the ► button. A dialog will appear.
 - (3) Press the ▲ button to select RESET on the dialog. It performs resetting the filter time.

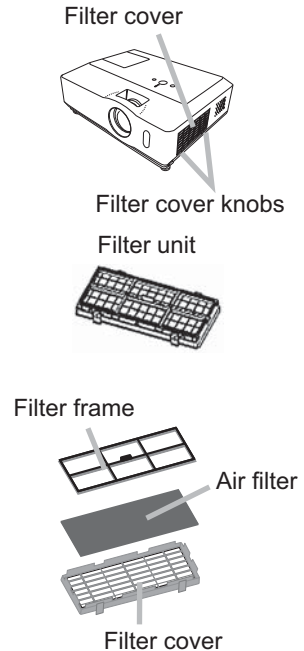

⚠WARNING ► Before taking care of the air filter, make sure the power cord is not plugged in, then allow the projector to cool sufficiently.
 ► Use only the air filter of the specified type. Do not use the projector without the air filter or the filter cover. It could result in a fire or malfunction to the projector.
 ► Clean the air filter periodically. If the air filter becomes clogged by dust or the like, internal temperatures rise and could cause a fire, a burn or malfunction to the projector.

NOTE • Please reset the filter time only when you have cleaned or replaced the air filter, for a suitable indication about the air filter.
 • The projector may display the message such as “CHECK THE AIR FLOW” or turn off the projector, to prevent the internal heat level rising.

Internal clock battery

Consumption of the battery makes the internal clock not to work correctly. When the internal clock is wrong or it has stopped, please replace the battery according to the following procedures.

1. Turn the projector off, and unplug the power cord. Allow the projector to cool sufficiently.
2. After making sure that the projector has cooled adequately, pull the slot cover forward, pushing slightly its edge up, and remove it from the projector.
3. Remove the battery case.
 - Hold the battery case gutter by finger nail or other thing and pull out the battery case slowly from the battery slot. While the projector is installed upside down, such as a ceiling mount, please remember the battery will drop down as soon as pulling the battery case out.
4. Take the old battery out from the battery case.
5. Replace a new battery.
 - Replace battery with **HITACHI MAXELL, Part No.CR2032** only. Use of another battery may present a risk of fire or explosion.
 - Put a new battery into battery case. Please make sure that the + is facing upward. Insert the battery case slowly into the battery slot until you hear the snap.
6. Close the slot cover.
 - Replace the slot cover by reversing the procedure used when removing the cover.

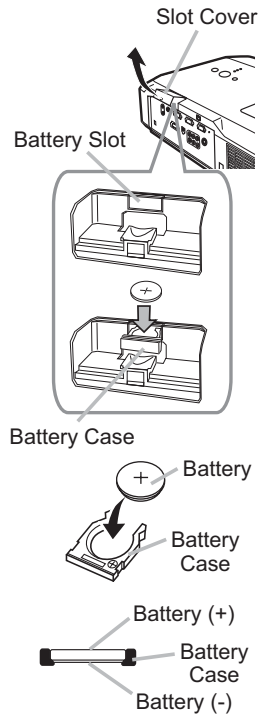

⚠ WARNING ► Always handle the batteries with care and use them only as directed. Battery may explode if mistreated. Do not recharge, disassemble or dispose of in fire.

And also improper use may result in cracking or leakage, which could result in fire, injury and/or pollution of the surrounding environment.

- Be sure to use only the batteries specified. Do not use batteries of different types at the same time. Do not mix a new battery with used one.
- Make sure the plus and minus terminals are correctly aligned when loading a battery.
- Keep a battery away from children and pets. If swallowed consult a physician immediately for emergency treatment.
- Do not short circuit or solder a battery.
- Do not allow a battery in a fire or water. Keep batteries in a dark, cool and dry place.
- If you observe a leakage of a battery, wipe out the flower and then replace a battery. If the liquid adheres to your body or clothes, rinse well with water immediately.
- Obey the local laws on disposing the battery.

NOTE • The internal clock's time will be reset when the battery is removed. Please reconfigure the time via the menu or a web browser after replacing the battery.
 (📖 "Date/Time Settings" of the User's Manual - Network Guide)

Other care

Inside of the projector

In order to ensure the safe use of your projector, please have it cleaned and inspected by your dealer about once every year.

Caring for the lens

If the lens is flawed, soiled or fogged, it could cause deterioration of display quality. Please take care of the lens, being cautious of handling.

1. Turn the projector off, and unplug the power cord. Allow the projector to cool sufficiently.
2. After making sure that the projector is cool adequately, lightly wipe the lens with a commercially available lens-cleaning wipe. Do not touch the lens directly with your hand.

Caring for the cabinet and remote control

Incorrect care could have adverse influence such as discoloration, peeling paint, etc.

1. Turn the projector off, and unplug the power cord. Allow the projector to cool sufficiently.
2. After making sure that the projector is cool adequately, lightly wipe with gauze or a soft cloth.
If the projector is extremely dirty, dip soft cloth in water or a neutral cleaner diluted in water, and wipe lightly after wringing well. Then, wipe lightly with a soft, dry cloth.

⚠WARNING ▶ Before caring, make sure the power cord is not plugged in, and then allow the projector to cool sufficiently. The care in a high temperature state of the projector could cause a burn and/or malfunction to the projector.

▶ Never try to care for the inside of the projector personally. Doing is so dangerous.

▶ Avoid wetting the projector or inserting liquids in the projector. It could result in a fire, an electric shock, and/or malfunction to the projector.

• Do not put anything containing water, cleaners or chemicals near the projector.

• Do not use aerosols or sprays.

⚠CAUTION ▶ Please take right care of the projector according to the following. Incorrect care could cause not only an injury but adverse influence such as discoloration, peeling paint, etc.

▶ Do not use cleaners or chemicals other than those specified in this manual.

▶ Do not polish or wipe with hard objects.

Troubleshooting

If an abnormal operation should occur, stop using the projector immediately.

⚠ WARNING ▶ Never use the projector if abnormal operations such as smoke, strange odor, excessive sound, damaged casing or elements or cables, penetration of liquids or foreign matter, etc. should occur. In such cases, immediately disconnect the power plug from the power outlet. After making sure that the smoke or odor has stopped, contact your dealer or service company.

Otherwise if a problem occurs with the projector, the following checks and measures are recommended before requesting repair.

If this does not resolve the problem, please contact your dealer or service company. They will tell you what warranty condition is applied.

Related messages

When some message appears, check and cope with it according to the following table. Although these messages will be automatically disappeared around several minutes, it will be reappeared every time the power is turned on.

Message	Description
<div style="border: 1px solid black; padding: 5px; text-align: center;"> NO INPUT IS DETECTED *** </div>	<p>There is no input signal. Please confirm the signal input connection, and the status of the signal source.</p>
<div style="border: 1px solid black; padding: 5px; text-align: center;"> SYNC IS OUT OF RANGE *** [fH] **kHz [fV] **Hz </div>	<p>The horizontal or vertical frequency of the input signal is not within the specified range. Please confirm the specs for your projector or the signal source specs.</p>
<p style="text-align: center;">CHECK THE AIR FLOW</p>	<p>The internal temperature is rising. Please turn the power off, and allow the projector to cool down at least 20 minutes. After having confirmed the following items, please turn the power ON again.</p> <ul style="list-style-type: none"> • Is there blockage of the air passage aperture? • Is the air filter dirty? • Does the peripheral temperature exceed 35°C? <p>If the same indication is displayed after the remedy, please set FAN SPEED of the SERVICE item in the OPTION menu to HIGH.</p>
<p style="text-align: center;">REMINDER *** HRS PASSED AFTER THE LAST FILTER CHECK. FILTER MAINTENANCE IS ESSENTIAL TO REMOVE WARNING MESSAGE, RESET FILTER TIMER. SEE MANUAL FURTHER INFO.</p>	<p>A note of precaution when cleaning the air filter. Please immediately turn the power off, and clean or change the air filter referring to the “Air Filter” section of this manual. After you have cleaned or changed the air filter, please be sure to reset the filter timer (📖56).</p>

Regarding the indicator lamps

When operation of the LAMP, TEMP and POWER indicators differs from usual, check and cope with it according to the following table.

POWER indicator	LAMP indicator	TEMP indicator	Description
Lighting In Orange	Turned off	Turned off	The projector is in a standby state. Please refer to the section "Power on/off".
<i>Blinking</i> In Green	Turned off	Turned off	The projector is warming up. Please wait.
Lighting In Green	Turned off	Turned off	The projector is in an on state. Ordinary operations may be performed.
<i>Blinking</i> In Orange	Turned off	Turned off	The projector is cooling down. Please wait.
<i>Blinking</i> In Red	(discretionary)	(discretionary)	The projector is cooling down. A certain error has been detected. Please wait until POWER indicator finishes blinking, and then perform the proper measure using the item descriptions below.
<i>Blinking</i> In Red or Lighting In Red	Lighting In Red	Turned off	The lamp does not light, and there is a possibility that interior portion has become heated. Please turn the power off, and allow the projector to cool down at least 20 minutes. After the projector has sufficiently cooled down, please make confirmation of the following items, and then turn the power on again. <ul style="list-style-type: none"> • Is there blockage of the air passage aperture? • Is the air filter dirty? • Does the peripheral temperature exceed 35°C? If the same indication is displayed after the remedy, please change the lamp referring to the section "Lamp".
<i>Blinking</i> In Red or Lighting In Red	<i>Blinking</i> In Red	Turned off	The lamp cover has not been properly fixed. Please turn the power off, and allow the projector to cool down at least 45 minutes. After the projector has sufficiently cooled down, please make confirmation of the attachment state of the lamp cover. After performing any needed maintenance, turn the power on again. If the same indication is displayed after the remedy, please contact your dealer or service company.
<i>Blinking</i> In Red or Lighting In Red	Turned off	<i>Blinking</i> In Red	The cooling fan is not operating. Please turn the power off, and allow the projector to cool down at least 20 minutes. After the projector has sufficiently cooled down, please make confirmation that no foreign matter has become caught in the fan, etc., and then turn the power on again. If the same indication is displayed after the remedy, please contact your dealer or service company.

(continued on next page)

Regarding the indicator lamps (continued)

POWER indicator	LAMP indicator	TEMP indicator	Description
Blinking In Red or Lighting In Red	Turned off	Lighting In Red	<p>There is a possibility that the interior portion has become heated.</p> <p>Please turn the power off, and allow the projector to cool down at least 20 minutes. After the projector has sufficiently cooled down, please make confirmation of the following items, and then turn the power on again.</p> <ul style="list-style-type: none"> • Is there blockage of the air passage aperture? • Is the air filter dirty? • Does the peripheral temperature exceed 35°C? <p>If the same indication is displayed after the remedy, please set FAN SPEED of SERVICE item in OPTION menu to HIGH (📖42).</p>
Lighting In Green	Simultaneous blinking in Red		<p>It is time to clean the air filter.</p> <p>Please immediately turn the power off, and clean or change the air filter referring to the section “Air Filter”. After cleaning or changing the air filter, please be sure to reset the filter timer. After the remedy, reset the power to ON.</p>
Lighting In Green	Alternative blinking in Red		<p>There is a possibility that the interior portion has become overcooled.</p> <p>Please use the unit within the usage temperature parameters (5°C to 35°C). After the treatment, reset the power to ON.</p>
Blinking in Green for approx. 3 seconds	Turned off	Turned off	<p>At least 1 Power ON schedule is saved to the projector.</p> <p>Please refer to “Schedule Settings” section of User’s Manual-Network Guide.</p>

NOTE • When the interior portion has become overheated, for safety purposes, the projector is automatically shut down, and the indicator lamps may also be turned off. In such a case, disconnect the power cord, and wait at least 45 minutes. After the projector has sufficiently cooled down, please make confirmation of the attachment state of the lamp and lamp cover, and then turn the power on again.

Shutting the projector down

Only when the projector can not be turned off by usual procedure (📖15), please push the shutdown switch using a pin or similar, and disconnect the power plug from the power outlet. Before turning it on again, wait at least 10 minutes to make the projector cool down enough.

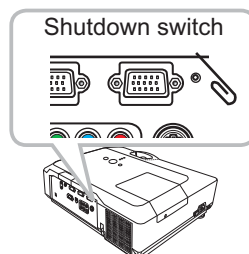

Resetting all settings

When it is hard to correct some wrong settings, the FACTORY RESET function of SERVICE item in OPTION menu (📖44) can reset all settings(except LANGUAGE, FILTER TIME, LAMP TIME, FILTER MESSAGE, NETWORK settings and etc.) to the factory default.

Phenomena that may be easy to be mistaken for machine defects

About the phenomenon confused with a machine defect, check and cope with it according to the following table.

Phenomenon	Cases not involving a machine defect	Reference page
Power does not come on.	The electrical power cord is not plugged in. Correctly connect the power cord.	12
	The main power source has been interrupted during operation such as by a power outage (blackout), etc. Please disconnect the power plug from the power outlet, and allow the projector to cool down at least 10 minutes, then turn the power on again.	12, 15
	Either there is no lamp and/or lamp cover, or either of these has not been properly fixed. Please turn the power off and disconnect the power plug from the power outlet, and allow the projector to cool down at least 45 minutes. After the projector has sufficiently cooled down, please make confirmation of the attachment state of the lamp and lamp cover, and then turn the power on again.	54, 55
Neither sounds nor pictures are outputted.	The signal cables are not correctly connected. Correctly connect the connection cables.	10
	Signal source does not correctly work. Correctly set up the signal source device by referring to the manual of the source device.	—
	The input changeover settings are mismatched. Select the input signal, and correct the settings.	16, 17
Sound does not come out.	The signal cables are not correctly connected. Correctly connect the audio cables.	10
	The MUTE function is working. Restore the sound pressing MUTE or VOLUME button on the remote control.	16
	The volume is adjusted to an extremely low level. Adjust the volume to a higher level using the menu function or the remote control.	16
	The AUDIO/SPEAKER setting is not correct. Correctly set the AUDIO/SPEAKER in SETUP menu.	35
No pictures are displayed.	The lens cover is attached. Remove the lens cover.	4, 15
	The signal cables are not correctly connected. Correctly connect the connection cables.	10

(continued on next page)

Phenomena that may be easy to be mistaken for machine defects (continued)

Phenomenon	Cases not involving a machine defect	Reference page
No pictures are displayed. (continued)	The brightness is adjusted to an extremely low level. Adjust BRIGHTNESS to a higher level using the menu function.	25, 26
	The computer cannot detect the projector as a plug and play monitor. Make sure that the computer can detect a plug and play monitor using another plug and play monitor.	11
	The BLANK screen is displayed. Press BLANK button on the remote control.	21
Video screen display freezes.	The FREEZE function is working. Press FREEZE button to restore the screen to normal.	21
Colors have a faded- out appearance, or Color tone is poor.	Color settings are not correctly adjusted. Perform picture adjustments by changing the COLOR TEMP, COLOR, TINT and/or COLOR SPACE settings, using the menu functions.	25, 26, 31
	COLOR SPACE setting is not suitable. Change the COLOR SPACE setting to AUTO, RGB, SMPTE240, REC709 or REC601.	31
Pictures appear dark.	The brightness and/or contrast are adjusted to an extremely low level. Adjust BRIGHTNESS and/or CONTRAST settings to a higher level using the menu function.	25, 26
	The WHISPER function is working. Select NORMAL for WHISPER item in the SETUP menu.	25, 35
	The lamp is approaching the end of its product lifetime. Replace the lamp.	54, 55
Pictures appear blurry.	Either the focus and/or horizontal phase settings are not properly adjusted. Adjust the focus using the focus ring, and/or H PHASE using the menu function.	18, 30
	The lens is dirty or misty. Clean the lens referring to the section "Caring for the lens".	58

NOTE • Although bright spots or dark spots may appear on the screen, this is a unique characteristic of liquid crystal displays, and it does not constitute or imply a machine defect.

Specifications

Specification

Item		Specification
Product name		Liquid crystal projector
Liquid Crystal Panel	Panel size	1.6 cm (0.63 type)
	Drive system	TFT active matrix
	Pixels	786,432 pixels (1024 horizontal x 768 vertical)
Lens		Zoom lens, <div style="display: flex; justify-content: space-around;"> <div style="text-align: center;"> <CP-X205> F=1.7 ~ 1.9 f = 18.9~ 22.6 mm </div> <div style="text-align: center;"> <CP-X305> F=1.7 ~ 1.9 f = 19.5~ 23.4 mm (approximately) </div> </div>
Lamp		220W UHB
Audio output		7 W
Power supply		AC 100-120V/3.5A, AC220-240V/1.5A
Power consumption		320 W
Temperature range		5 ~ 35°C (Operating)
Size		340 (W) x 117 (H) x 270 (D) mm * Not including protruding parts. Please refer to the following figure.
Weight (mass)		approx. 4.0 kg
Ports		Computer input port COMPUTER IN1D-sub 15 pin mini x1 COMPUTER IN2D-sub 15 pin mini x1 Computer output port MONITOR OUTD-sub 15 pin mini x1 Video input port Y, Cb/Pb, Cr/Pr (Component video) RCA x3 S-VIDEO mini DIN 4 pin x1 VIDEO RCA x1 Audio input/output port AUDIO IN1Stereo mini x1 AUDIO IN2Stereo mini x1 AUDIO IN3 RCA x2 AUDIO OUTStereo mini x1 Others USBUSB-B x1 CONTROL D-sub 9 pin x1 LAN RJ45 x1
Optional parts		Lamp: DT00841 Air filter: MU04951 * For more information, please consult your dealer.

Specifications (continued)

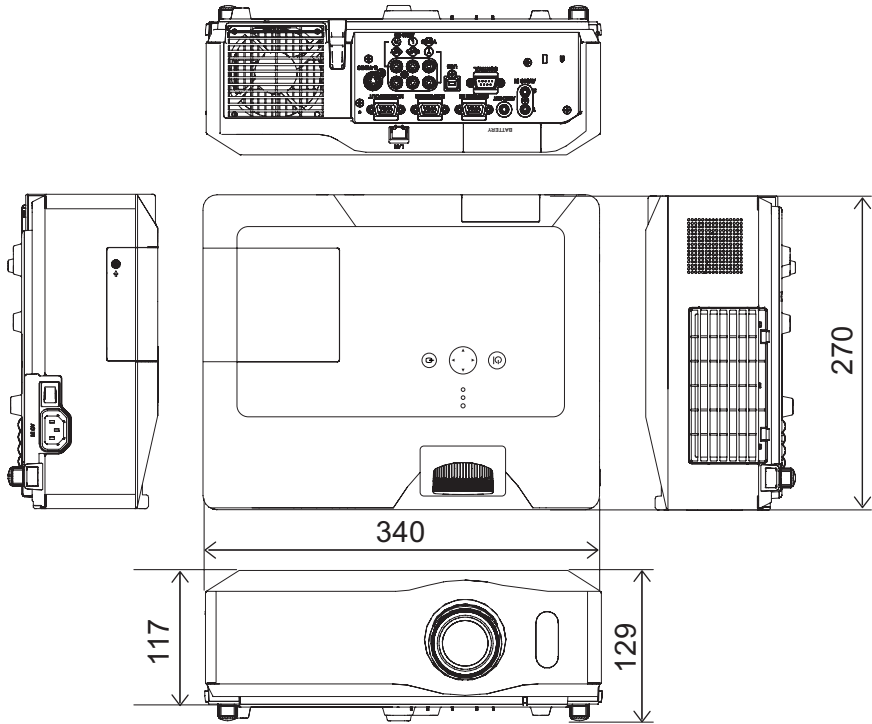

[unit: mm]

Projector

CP-X205/CP-X305

User's Manual (detailed)

Network Guide

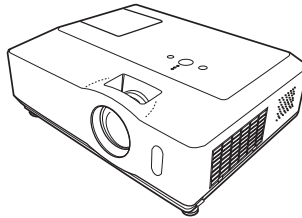

This manual is only intended to explain Network Functions.
For safety, operations or any other issues, refer to the Safety Guide or Operating Guide.

⚠ WARNING • Before using this product, please read all manuals for this product. Be sure to read Safety Guide first. After reading, keep the manuals in a safe place for future reference.

NOTE • The information in this manual is subject to change without notice.
• The manufacturer assumes no responsibility for any errors that may appear in this manual.
• The reproduction, transfer or copy of all or any part of this document is not permitted without express written consent.

Trademark acknowledgement

- Windows is a registered trademark of Microsoft Corporation.
 - Netscape is a registered trademark of Netscape Communications Corporation.
 - JavaScript is a registered trademark of Sun Microsystems, Inc.
- All other trademarks are the properties of their respective owners.

Contents

Network Functions	2
Configuring and Controlling the Projector via a Web Browser ...	4
E-mail Alerts	23
Projector Management using SNMP.....	25
Event Scheduling	26
e-SHOT (Still Image Transfer) Display	29
Command Control via the Network.....	31



Network Functions

This projector is equipped with the following network functions.

Configuring and Controlling the Projector via a Web Browser

You can change the settings of or control the projector via a network by using a web browser from a PC that is connected to the same network.

4

E-mail Alerts

The projector can automatically send an alert to specified e-mail addresses when the projector requires maintenance or has encountered an error.

23

Projector Management using SNMP

This projector is SNMP (Simple Network Management Protocol) compliant, allowing you to monitor it from a remote location using SNMP software. In addition, the projector is able to send failure & warning alerts to a specified PC.

25

Event Scheduling

You can schedule the projector to perform various functions according to the date and time.

26

e-SHOT (Still Image Transfer) Display

The projector can display still images that are transferred via the network.

29

Command Control via the Network

The projector can be controlled using RS-232C commands over a network.

31

Before Using the Network Functions...

To use the network functions of this projector, the projector must be configured to suit your network. Consult with your network administrator before connecting the projector to your network. Incorrect network configuration of this projector may cause problems on your network.

Connect the gateway (The router/PC that forwards traffic to a destination outside of the subnet of the transmitting device) to the LAN port on the projector using a CAT-5 cable and configure the following settings.

If using a network with DHCP enabled:

The projector's network settings can be configured automatically when DHCP on the NETWORK menu is set to ON. Please refer to DHCP and INFORMATION in NETWORK menu ( "NETWORK menu" section of the User's Manual - Operating Guide). If a fixed / static IP address is required, please configure your projector according to the steps in the following section.

If using a network without DHCP enabled or using a fixed IP address on a network with DHCP enabled:

Configure the following settings on the NETWORK menu ( "NETWORK menu" section of the User's Manual - Operating Guide).

1. **DHCP** : Set DHCP to OFF (disabled).
2. **IP ADDRESS** : Enter an appropriate IP address for the projector to connect to your network.
3. **SUBNET MASK** : Enter an appropriate subnet mask for the projector to connect to your network.
4. **DEFAULT GATEWAY** : Enter an appropriate gateway address for the projector to connect to your network.

Configuring and Controlling the Projector via a Web Browser

You can adjust or control the projector via a network from a web browser on a PC that is connected to the same network.

- NOTE**
- Internet Explorer 5.5 or later or Netscape 6.2 or later are required.
 - If JavaScript is disabled in your web browser configuration, you must enable JavaScript in order to use the projector web pages properly. See the Help files for your web browser for details on how to enable JavaScript.
 - If projector is disconnected from network approx. 50 seconds, system will automatically log off. Please Re-log on to continue operations via a web browser.
 - After you logon, a small, blank window will appear behind the main operation window. Please do not close this small, blank window. If this window is closed, the system will automatically log off after approx. 50 seconds even if an operation is being performed.
The small, blank window will close when the main operation window is closed.
 - The small, blank window may be considered a pop-up and be blocked if you are using Windows XP Service Pack 2, or using other security software. If Service Pack 2 blocks the window the following message will appear: "Pop-up blocked. To see this pop-up or additional options click here..." Please select "Temporarily Allow Pop-ups" or "Always Allow Pop-ups From This Site..." to allow the window to open.
 - You can communicate using SSL (Secure Socket Layer) if you are using Windows XP Service Pack 2 or earlier versions of Microsoft Windows. Please specify "https://" when you enter the IP address of the projector on the web browser. You can't communicate the projector using SSL on Windows Vista.
 - It is recommended to install all web browser updates to communicate using SSL. It is especially recommended that users using Internet Explorer install security update Q832894 (MS04-004) or the web browser interface may not be displayed correctly.
And when using an earlier version of Internet Explorer than version 5.5, during operations the browser will log out after 50 seconds.

When configuring or controlling the projector via a web browser, an ID and password are required. There are two types of IDs, Administrator and User. The following chart describes the differences between User and Administrator IDs.

Item	Description	Administrator	User
Network Information	Displays the projector's current network configuration settings. (17)	√	√
Network Settings	Displays and configures network settings. (18)	√	N/A
Port Settings	Displays and configures communication port settings. (19)	√	N/A
Mail Settings	Displays and configures e-mail addressing settings. (20)	√	N/A
Alert Settings	Displays and configures failure & warning alerts. (21)	√	N/A
Schedule Settings	Displays and configures schedule settings. (23)	√	N/A
Date/Time Settings	Displays and configures the date and time settings. (25)	√	N/A
Security Settings	Displays and configures passwords and other security settings. (27)	√	N/A
Projector Control	Controls the projector. (29)	√	√
Projector Status	Displays and configures the current projector status. (32)	√	√
Network Restart	Restarts the projector's network connection. (33)	√	N/A

Below are the factory default settings of IDs and passwords for Administrator and User.

Item	ID	Password
Administrator	Administrator	<blank>
User	User	<blank>

Refer to the following for configuring or controlling the projector via a web browser.

Example: If the IP address of the projector is set to 192.168.1.10:

- 1) Enter "**http://192.168.1.10/**" into the address bar of the web browser and press "Enter" key or click "Go" button. The screen in Fig. 1 will be displayed.
- 2) Enter your ID and password and click [**Logon**].

Fig. 1

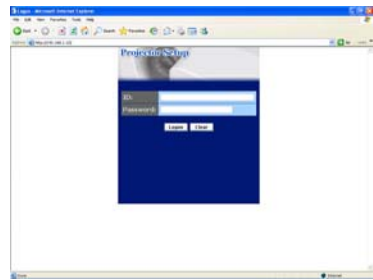

If the logon is successful, either the Fig.2 or Fig.3 screen will be displayed.

Fig. 2 (Logon with Administrator ID)

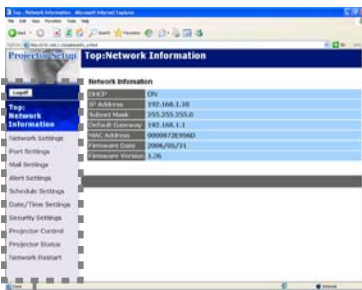

main menu

Fig. 3 (Logon with User ID)

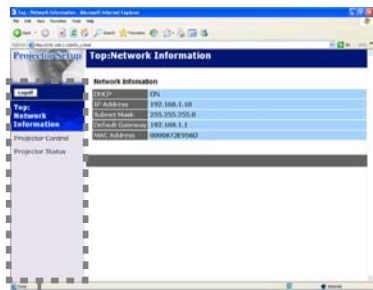

main menu

- 3) Click the desired operation or configuration item on the main menu located on the left side of the screen.

Network Information

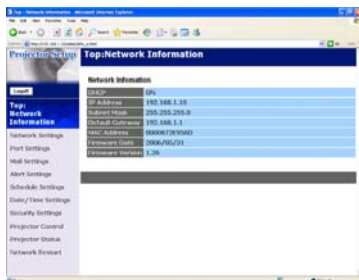

All screen images displayed in this manual are screens of a logon using an Administrator ID. Any Administrator only functions will not be displayed when using a User ID. Refer to the descriptions in each table.

Displays the projector's current network configuration settings.

Item	Description
DHCP	Displays the DHCP configuration settings.
IP Address	Displays the current IP address.
Subnet Mask	Displays the subnet mask.
Default Gateway	Displays the default gateway.
MAC Address	Displays the MAC address.
Firmware Date	Displays the network firmware time stamp. This information is only displayed when logged on using an Administrator ID.
Firmware Version	Displays the network firmware version number. This information is only displayed when logged on using an Administrator ID.

Network Settings



Displays and configures network settings.

Item	Description
IP Configuration	Configures network settings.
DHCP ON	Enables DHCP.
DHCP OFF	Disables DHCP.
IP Address	Configures the IP address when DHCP is disabled.
Subnet Mask	Configures the subnet mask when DHCP is disabled.
Default Gateway	Configures the default gateway when DHCP is disabled.
Projector Name	Configures the name of the projector. The length of the Projector Name can be up to 64 alphanumeric characters. Numbers '0-9' and alphabet 'a-z', 'A-Z' and symbols can be used.
sysLocation (SNMP)	Configures the location to be referred to when using SNMP. The length of the sysLocation can be up to 255 alphanumeric characters. Only numbers '0-9' and alphabet 'a-z', 'A-Z' can be used.
sysContact (SNMP)	Configures the contact information to be referred to when using SNMP. The length of the sysContact can be up to 255 alphanumeric characters. Only numbers '0-9' and alphabet 'a-z', 'A-Z' can be used.
DNS Server Address	Configures the DNS server address.

Click the **[Apply]** button to save the settings.

NOTE • The new configuration settings are activated after restarting the network connection. When the configuration settings are changed, you must restart the network connection. You can restart the network connection by clicking **[Network Restart]** on the main menu.

- If you connect the projector to an existing network, consult a network administrator before setting server addresses.

Port Settings

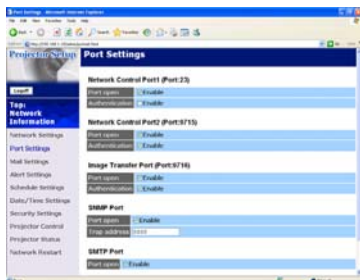

Displays and configures communication port settings.

Item	Description
Network Control Port1 (Port:23)	Configures command control port 1 (Port:23).
Port open	Click the [Enable] check box to use port 23.
Authentication	Click the [Enable] check box when authentication is required for this port.
Network Control Port2 (Port:9715)	Configures command control port 2 (Port:9715).
Port open	Click the [Enable] check box to use port 9715.
Authentication	Click the [Enable] check box when authentication is required for this port.
Image Transfer Port (Port:9716)	Configures the image transfer port (Port:9716).
Port open	Click the [Enable] check box to use port 9716.
Authentication	Click the [Enable] check box when authentication is required for this port.
SNMP Port	Configures the SNMP port.
Port open	Click the [Enable] check box to use SNMP.
Trap address	Configures the destination of the SNMP trap in IP format.
SMTP Port	Configures the SMTP port.
Port open	Click the [Enable] check box to use the e-mail function.

Click the **[Apply]** button to save the settings.

NOTE • The new configuration settings are activated after restarting the network connection. When the configuration settings are changed, you must restart the network connection. You can restart the network connection by clicking **[Network Restart]** on the main menu.

Mail Settings

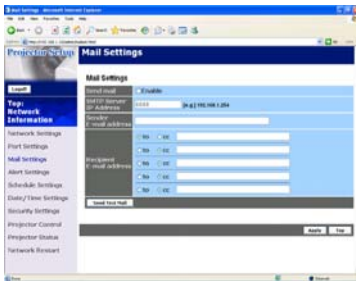

Displays and configures e-mail addressing settings.

Item	Description
Send mail	Click the [Enable] check box to use the e-mail function. Configure the conditions for sending e-mail under Alert Settings .
SMTP Server IP Address	Configures the address of the mail server in IP format. <ul style="list-style-type: none"> The address allows not only IP address but also domain name if the valid DNS server is setup in the Network Settings. The maximum length of host or domain name is up to 255 characters.
Sender E-mail address	Configures the sender e-mail address. The length of the sender e-mail address can be up to 255 alphanumeric characters.
Recipient E-mail address	Configures the e-mail address of up to five recipients. You can also specify [TO] or [CC] for each address. The length of the recipient e-mail address can be up to 255 alphanumeric characters.

Click the **[Apply]** button to save the settings.

NOTE • You can confirm whether the mail settings work correctly using the **[Send Test Mail]** button. Please enable Send mail setting before clicking **[Send Test Mail]**.

- If you connect the projector to an existing network, consult a network administrator before setting server addresses.

Alert Settings

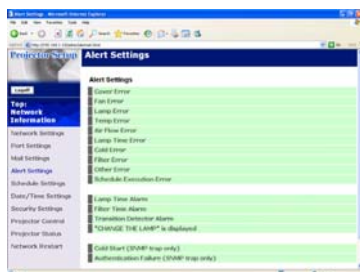

Displays and configures failure & warning alert settings.

Alert Item	Description
Cover Error	The lamp cover has not been properly fixed.
Fan Error	The cooling fan is not operating.
Lamp Error	The lamp does not light, and there is a possibility that interior portion has become heated.
Temp Error	There is a possibility that the interior portion has become heated.
Air Flow Error	The internal temperature is rising.
Lamp Time Error	Lamp time over.
Cold Error	There is a possibility that the interior portion has become overcooled.
Filter Error	Filter time over.
Other Error	Other error. If displaying this error, please contact your dealer.
Schedule Execution Error	Schedule Execution error. (📖13)
Lamp Time Alarm	Lamp time over Alarm Time setting.
Filter Time Alarm	Filter time over Alarm Time setting.
Transition Detector Alarm	Transition Detector Alarm. (📖"OPTION menu" section of the User's Manual - Operating Guide)
"CHANGE THE LAMP" is displayed.	"CHANGE THE LAMP" is displayed.
Cold Start	The power switch is turned on. (Off → standby mode)
Authentication Failure	The SNMP access is detected from the invalid SNMP community.

Refer to "**Troubleshooting**" section of the **User's Manual - Operating Guide** for further detailed explanation of Error except Other Error and Schedule Execution Error.

Alert Settings (Continued)

The Alert Items are shown below.

Setting Item	Description
Alarm Time	Configures the time to alert. (Only Lamp Time Alarm and Filter Time Alarm.)
SNMP Trap	Click the [Enable] check box to enable SNMP trap alerts.
Send Mail	Click the [Enable] check box to enable e-mail alerts. (Except Cold Start and Authentication Failure .)
Mail Subject	Configures the subject line of the e-mail to be sent. The length of the subject line can be up to 255 alphanumeric characters. (Except Cold Start and Authentication Failure .)
Mail Text	Configures the text of the e-mail to be sent. The length of the text can be up to 1024 alphanumeric characters. (Except Cold Start and Authentication Failure .)

Click the **[Apply]** button to save the settings.

NOTE • The trigger of Filter Error e-mail is depending on the FILTER MESSAGE setting in the SERVICE item of the OPTION menu which defines the period until filter message is displayed on the projector screen. The e-mail will be sent when the filter timer exceeds 50, 100, 200, 300, 400, 500, 600, 700 or 800 hours based on the configuration. No notification e-mail will be sent if the FILTER MESSAGE is set to TURN OFF. ( "OPTION menu" section of the User's Manual - Operating Guide)

- Lamp Time Alarm is defined as a threshold for e-mail notification (reminder) of the lamp timer. When the lamp hour exceeds this threshold that is configured through the Web page, the e-mail will be sent out.
- Filter Time Alarm is defined as a threshold for e-mail notification (reminder) of the filter timer. When the filter hour exceeds this threshold, the e-mail will be sent out.

Schedule Settings

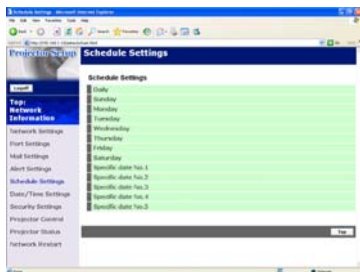

Displays and configures schedule settings.

Item	Description
Daily	Configures the daily schedule.
Sunday	Configures the Sunday schedule.
Monday	Configures the Monday schedule.
Tuesday	Configures the Tuesday schedule.
Wednesday	Configures the Wednesday schedule.
Thursday	Configures the Thursday schedule.
Friday	Configures the Friday schedule.
Saturday	Configures the Saturday schedule.
Specific date No.1	Configures the specific date (No.1) schedule.
Specific date No.2	Configures the specific date (No.2) schedule.
Specific date No.3	Configures the specific date (No.3) schedule.
Specific date No.4	Configures the specific date (No.4) schedule.
Specific date No.5	Configures the specific date (No.5) schedule.

Schedule Settings (Continued)

The daily and weekly event items are shown below.

Item	Daily & Weekly Description
Schedule	Click the [Enable] check box to enable the schedule.
Schedule List	Displays the current schedule.

The specific date event items are shown below.

Item	Specific date (No.1-5) Description
Schedule	Click the [Enable] check box to enable specific date (No.1-5) schedule.
Date (Month/Day)	Configures the month and day.
Schedule List	Displays the current specific date (No.1-5) schedule.

Click the **[Apply]** button to save the settings.

To add additional functions and events click the **[Add]** button and set the following items.

Item	Description
Time	Configures the time to execute commands.
Command Parameter	Configures the commands to be executed.
Power	Configures the parameters for power control.
Input Source	Configures the parameters for input switching.
Display Image	Configures the parameters for display of transfer image data.

Click the **[Register]** button to add new commands to the Schedule List.

Click the **[Delete]** button to delete commands from the Schedule List.

NOTE • After the projector is moved, check the date and time set for the projector before configuring the schedules. Strong shock may make the date and time settings (📅15) get out of tune.

Date/Time Settings

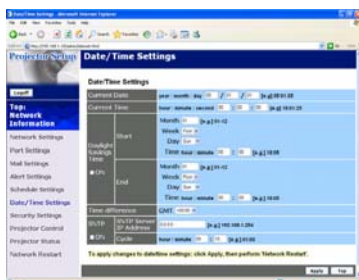

Displays and configures the date and time settings.

Item	Description				
Current Date	Configures the current date in year/month/day format.				
Current Time	Configures the current time in hour:minute:second format.				
Daylight Savings Time	Click the [ON] check box to enable daylight savings time and set the following items.				
Start	Configures the date and time daylight savings time begins.				
Month	Configures the month daylight savings time begins (1~12).				
Week	Configures the week of the month daylight savings time begins (First, 2, 3, 4, Last).				
Day	Configures the day of the week daylight savings time begins (Sun, Mon, Tue, Wed, Thu, Fri, Sat).				
Time	<table border="1"> <tr> <td>hour</td> <td>Configures the hour daylight savings time begins (0 ~ 23).</td> </tr> <tr> <td>minute</td> <td>Configures the minute daylight savings time begins (0 ~ 59).</td> </tr> </table>	hour	Configures the hour daylight savings time begins (0 ~ 23).	minute	Configures the minute daylight savings time begins (0 ~ 59).
hour	Configures the hour daylight savings time begins (0 ~ 23).				
minute	Configures the minute daylight savings time begins (0 ~ 59).				
End	Configures the date and time daylight savings time ends.				
Month	Configures the month daylight savings time ends (1 ~ 12).				
Week	Configures the week of the month daylight savings time ends (First, 2, 3, 4, Last).				
Day	Configures the day of the week daylight savings time ends (Sun, Mon, Tue, Wed, Thu, Fri, Sat).				
Time	<table border="1"> <tr> <td>hour</td> <td>Configures the hour daylight savings time ends (0 ~ 23).</td> </tr> <tr> <td>minute</td> <td>Configures the minute daylight savings time ends (0 ~ 59).</td> </tr> </table>	hour	Configures the hour daylight savings time ends (0 ~ 23).	minute	Configures the minute daylight savings time ends (0 ~ 59).
hour	Configures the hour daylight savings time ends (0 ~ 23).				
minute	Configures the minute daylight savings time ends (0 ~ 59).				

Date/Time Settings (Continued)

Item	Description
Time difference	Configures the time difference. Set the same time difference as the one set on your PC. If unsure, consult your IT manager.
SNTP	Click the [ON] check box to retrieve Date and Time information from the SNTP server and set the following items.
SNTP Server IP Address	Configures the SNTP server address in IP format. • The address allows not only IP address but also domain name if the valid DNS server is setup in the Network Settings . The maximum length of host or domain name is up to 255 characters.
Cycle	Configures the interval at which to retrieve Date and Time information from the SNTP server (hours:minutes).

Click the **[Apply]** button to save the settings.

NOTE • The new configuration settings are activated after restarting the network connection. When the configuration settings are changed, you must restart the network connection. You can restart the network connection by clicking **[Network Restart]** on the main menu.

- If you connect the projector to an existing network, consult a network administrator before setting server addresses.
- To enable the SNTP function, the time difference must be set.
- The projector will retrieve Date and Time information from the time server and override time settings when SNTP is enabled.
- The internal clock's time may not remain accurate. Using SNTP is recommended to maintain accurate time.

Security Settings

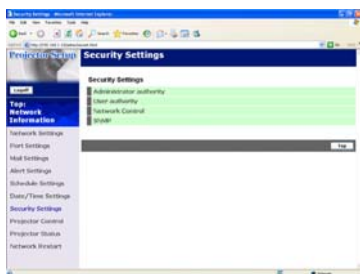

Displays and configures passwords and other security settings.

Item	Description
Administrator authority	Configures the Administrator ID and password.
Administrator ID	Configures the Administrator ID. The length of the text can be up to 32 alphanumeric characters.
Administrator Password	Configures the Administrator password. The length of the text can be up to 255 alphanumeric characters.
Re-enter Administrator Password	Re-enter the above password for verification.
User authority	Configures the User ID and password.
User ID	Configures the User ID. The length of the text can be up to 32 alphanumeric characters.
User Password	Configures the User password. The length of the text can be up to 255 alphanumeric characters.
Re-enter User Password	Re-enter the above password for verification.

Security Settings (Continued)

Item	Description
Network Control	Configures the authentication password for the command control.
Authentication Password	Configures the authentication password. The length of the text can be up to 32 alphanumeric characters.
Re-enter Authentication Password	Re-enter the above password for verification.
SNMP	Configures the community name if SNMP is used.
Community Name	Configures the community name. The length of the text can be up to 64 alphanumeric characters.

Click the **[Apply]** button to save the settings.

NOTE • The new configuration settings are activated after restarting the network connection. When the configuration settings are changed, you must restart the network connection. You can restart the network connection by clicking **[Network Restart]** on the main menu.

- Only numbers '0-9' and alphabet 'a-z', 'A-Z' can be used.

Projector Control

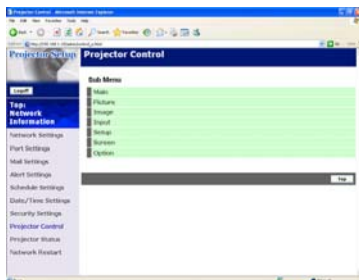

The items shown in the table below can be performed using the **Projector Control** menu. Select an item using the up and down arrow keys on the PC.

Most of the items have a submenu. Refer to the table below for details.

NOTE • The setting value may not match with the actual value if the user changes the value manually. In that case, please refresh the page by clicking [Refresh] button.

Controls the projector.

Item	Description
Main	
Power	Turns the power on/off.
Input Source	Selects the input source.
Picture Mode	Selects the picture mode setting.
Blank On/Off	Turns Blank on/off.
Mute	Turns Mute on/off.
Freeze	Turns Freeze on/off.
Magnify	Controls the Magnify setting. In some input signal sources, it might stop “Magnify” even though it does not reach to maximum setting value. The variable range: • For a computer signal 0-48 • For a video, s-video or component video signal 0-16
Picture	
Brightness	Adjusts the brightness setting.
Contrast	Adjusts the contrast setting.
Gamma	Selects the gamma setting.
Color Temp	Selects the color temperature setting.
Color	Adjusts the color setting.
Tint	Adjusts the tint setting.
Sharpness	Adjusts the sharpness setting.
MyMemory Save	Saves the MyMemory data.
MyMemory Recall	Recalls the MyMemory data.

Projector Control (Continued)

Item	Description
Image	
Aspect	Selects the aspect ratio.
Over Scan	Adjusts the over-scan setting.
V Position	Adjusts the vertical position.
H Position	Adjusts the horizontal position.
H Phase	Adjusts the horizontal phase.
H Size	Adjusts the horizontal size.
Auto Adjust Execute	Performs the automatic adjustment.
Input	
Progressive	Selects the progressive setting.
Video NR	Selects the video noise reduction setting.
Color Space	Selects the color space setting.
Component	Selects the COMPONENT port setting.
C-Video Format	Selects the video format setting.
S-Video Format	Selects the s-video format setting.
Frame Lock	Turns the frame lock function on/off.
Computer in-1	Selects the COMPUTER IN1 input signal type.
Computer in-2	Selects the COMPUTER IN2 input signal type.
Setup	
Auto Keystone Execute	Performs the automatic keystone distortion correction.
Keystone	Adjusts the keystone distortion setting.
Whisper	Selects the whisper mode.
Mirror	Selects the mirror status.
Volume	Adjusts the volume setting.
Speaker	Turns the built-in speaker on/off.
Audio-Computer1	Assigns the AUDIO-COMPUTER IN1 input port.
Audio-Computer2	Assigns the AUDIO-COMPUTER IN2 input port.
Audio-Video	Assigns the AUDIO-VIDEO input port.
Audio-S-Video	Assigns the AUDIO-S-VIDEO input port.
Audio-Component	Assigns the AUDIO-COMPONENT input port.

Projector Control (Continued)

Item	Description
Screen	
Language	Selects the language for the OSD.
Menu Position V	Adjusts the vertical Menu position.
Menu Position H	Adjusts the horizontal Menu position.
Blank	Selects the Blank mode.
Startup	Selects the start-up screen mode.
MyScreen Lock	Turns MyScreen lock function on/off.
Message	Turns the message function on/off.
Option	
Auto Search	Turns the automatic signal search function on/off.
Auto Keystone	Turns the automatic keystone distortion correction function on/off.
Auto on	Turns the AUTO ON function on/off.
Auto off	Configures the timer to shut off the projector when no signal is detected.
My Button-1	Assigns the function for the MY BUTTON1 button on the included remote control.
My Button-2	Assigns the function for the MY BUTTON2 button on the included remote control.
Remote Freq. Normal	Enables/Disables remote control signal frequency normal.
Remote Freq. High	Enables/Disables remote control signal frequency high.

Projector Status

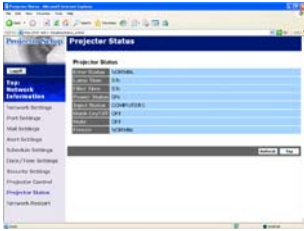

Displays and configures the current projector status.

Item	Description
Error Status	Displays the current error status.
Lamp Time	Displays the usage time for the current lamp.
Filter Time	Displays the usage time for the current filter.
Power Status	Displays the current power status.
Input Status	Displays the current input signal source.
Blank On/Off	Displays the current Blank on/off status.
Mute	Displays the current Mute on/off status.
Freeze	Displays the current Freeze status.

Network Restart



Restarts the projector's network connection.

Item	Description
Restart	Restarts the projector's network connection in order to activate new configuration settings.

NOTE • Restarting requires you to re-login in order to further control or configure the projector via a web browser. Wait 1 minute or more after clicking **[Restart]** button to log on again in order to further control or configure the projector via a web browser.
 • A link to the logon screen (📖6 : Fig. 1) is displayed after restarting the projector's network connection if the DHCP is set to ON.

Logoff

22 When **[Logoff]** is clicked, the logon screen is displayed (📖6 : Fig. 1).

E-mail Alerts

The projector can automatically send an alert message to the specified e-mail addresses when the projector detects a certain condition that is requiring maintenance or detected an error.

NOTE • Up to five e-mail addresses can be specified.
• The projector may be not able to send e-mail if the projector suddenly loses power.

Mail Settings

To use the projector's e-mail alert function please configure the following items through a web browser.

Example: If the IP address of the projector is set to 192.168.1.10:

- 1) Enter "**http://192.168.1.10/**" into the address bar of the web browser.
- 2) Enter the Administrator ID and password and click **[Logon]**.
- 3) Click **[Port Settings]** on the main menu.
- 4) Click the **[Enable]** check box to open the **SMTP Port**.
- 5) Click the **[Apply]** button to save the settings.

NOTE • A Network Restart is required after the **SMTP Port** configuration settings have changed. Click **[Network Restart]** and configure the following items.

- 6) Click **[Mail Settings]** and configure each item. Refer to the **Mail Settings** item in "**Configuring and Controlling the Projector via a Web Browser**" for further information ([10](#)).
- 7) Click the **[Apply]** button to save the settings.

NOTE • Click the **[Send Test Mail]** button in **Mail Settings** to confirm that the e-mail settings are correct. The following mail will be delivered to the specified addresses.

Subject line	: Test Mail	<Projector name>
Text	: Send Test Mail	
	Date	<Testing date>
	Time	<Testing time>
	IP Address	<Projector IP address>
	MAC Address	<Projector MAC address>

Mail Settings (Continued)

- 8) Configure the Failure/Warning Alerts via E-mail settings. Click **[Alert Settings]** on the main menu.
- 9) Select and configure each alert item. Refer to **Alert Settings** in "**Configuring and Controlling the Projector via a Web Browser**" for further information ([📖](#) 11).
- 10) Click the **[Apply]** button to save the settings.

Failure/Warning e-mails are formatted as follows:

Subject line	: <Mail title>	<Projector name>
Text	: <Mail text>	
	Date	<Failure/Warning date>
	Time	<Failure/Warning time>
	IP Address	<Projector IP address>
	MAC Address	<Projector MAC address>

Projector Management using SNMP

The SNMP (Simple Network Management Protocol) enables to manage the projector information, which is a failure or warning status, from the computer on the network. The SNMP management software will be required on the computer to use this function.

NOTE • It is recommended that SNMP functions be carried out by a network administrator.
 • SNMP management software must be installed on the computer to monitor the projector via SNMP.

SNMP Settings

Configure the following items via a web browser to use SNMP.

Example: If the IP address of the projector is set to 192.168.1.10:

- 1) Enter "**http://192.168.1.10/**" into the address bar of the web browser.
- 2) Enter the Administrator ID and password and click **[Logon]**.
- 3) Click **[Port Settings]** on the main menu.
- 4) Click the **[Enable]** check box to open the **SNMP Port**.
 Set the IP address to send the SNMP trap to when a Failure/Warning occurs.

NOTE • A Network Restart is required after the **SNMP Port** configuration settings have been changed. Click **[Network Restart]** and configure the following items.

- 5) Click **[Security Settings]** on the main menu.
- 6) Click **[SNMP]** and set the **Community Name** on the screen that is displayed.

NOTE • A Network Restart is required after the **Community Name** has been changed. Click **[Network Restart]** and configure the following items.

- 7) Configure the settings for Trap transmission of Failures/Warnings. Click **[Alert Settings]** on the main menu and select the Failure/Warning item to be configured.
- 8) Click the **[Enable]** check box to send out the SNMP trap for Failures/Warnings.
 Clear the **[Enable]** check box when SNMP trap transmission is not required.
- 9) Click the **[Apply]** button to save the settings.

Event Scheduling

The scheduling function enables to setup scheduled events including power on / power off. It enables to be “self-management” projector.

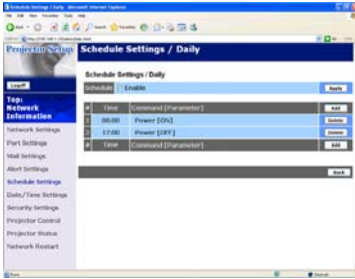

- NOTE** • You can schedule the following control events: Power ON/OFF, Input Source and Transferred Image Display.
- The power on / off event has the lowest priority among the all events that are defined at the same time.
 - There are 3 types of Scheduling, 1) Daily 2) Weekly 3) Specific date (📖 27).
 - The priority for scheduled events is as follows 1) Specific date 2) Weekly 3) Daily.
 - Up to five specific dates are available for scheduled events. Priority is given to those with the lower numbers when more than one event has been scheduled for the same date and time (e.g., ‘Specific date No. 1’ has priority over ‘Specific date No. 2’ and so on).
 - Be sure to set the date and time before enabling scheduled events (📖 28).

Schedule Settings

Schedule settings can be configured from a web browser.

Example: If the IP address of the projector is set to 192.168.1.10:

- 1) Enter "**http://192.168.1.10/**" into the address bar of the web browser.
- 2) Enter the Administrator ID and password and click **[Logon]**.
- 3) Click **[Schedule Settings]** on the main menu and select the required schedule item. For example, if you want to perform the command every Sunday, please select the **[Sunday]**.
- 4) Click the **[Enable]** check box to enable scheduling.
- 5) Enter the date (month/day) for specific date scheduling.
- 6) Click the **[Apply]** button to save the settings.
- 7) Click **[Add]** to create new event. After configure the time, command and parameters, click **[Register]** to add the new event. To return the previous page, click **[Cancel]** button.
- 8) Click the **[Delete]** button when you want to delete a schedule.

There are three types of scheduling.

- 1) Daily: Perform the specified operation at a specified time every day.
- 2) Weekly (Sunday ~ Saturday): Perform the specified operation at the specified time on a specified day of the week.
- 3) Specific date: Perform the specified operation on the specified date and time.

NOTE • In Standby mode the POWER indicator will flash green for approx. 3 seconds when at least 1 "Power ON" schedule is saved.
• When the schedule function is used, the power cord must be connected to the projector and the outlet and the power switch must be turned on, [|]. The schedule function does not work when the power switch is turned off, [O] or the breaker in a room is tripped. The POWER indicator will lights orange or green when the projector is receiving the power.

Date/Time Settings

The Date/Time setting can be adjusted via a web browser.

Example: If the IP address of the projector is set to 192.168.1.10:

- 1) Enter "**http://192.168.1.10/**" into the address bar of the web browser.
Enter the Administrator ID and password and click **[Login]**.
- 2) Click **[Date/Time Settings]** on the main menu and configure each item.
Refer to the **Date/Time Settings** item in "**Configuring and Controlling the Projector via a Web Browser**" for further information.
- 3) Click the **[Apply]** button to save the settings.

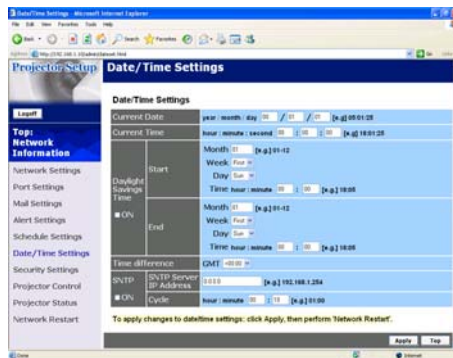

NOTE • A Network Restart is required after the **Daylight Savings Time** or **SNTP** configuration settings have been changed.

- The battery for the built in clock may be dead if the clock loses time even when the date and time have been set correctly. Replace the battery by following the instructions on replacing the battery.

( **"Internal clock battery"** section of the **User's Manual - Operating Guide**)

- The internal clock's time may not remain accurate. Using SNTP is recommended to maintain accurate time.

e-SHOT (Still Image Transfer) Display

The projector can display a still image that is transferred via the network.

Communication Port

The following port is used for e-SHOT.
TCP #9716

NOTE • e-SHOT is not available via communication ports (TCP #23 and TCP #9715) () which are used for the command control.

e-SHOT (Still Image Transfer) Settings

Configure the following items from a web browser when e-SHOT is used.

Example: If the IP address of the projector is set to 192.168.1.10:

- 1) Enter "**http://192.168.1.10/**" into the address bar of the web browser.
- 2) Enter the Administrator ID and password and click [**Logon**].
- 3) Click [**Port Settings**] on the main menu.
- 4) Click the [**Enable**] check box to open the **Image Transfer Port (Port: 9716)**. Click the [**Enable**] check box for the [**Authentication**] setting when authentication is required, otherwise clear the check box.
- 5) Click the [**Apply**] button to save the settings.

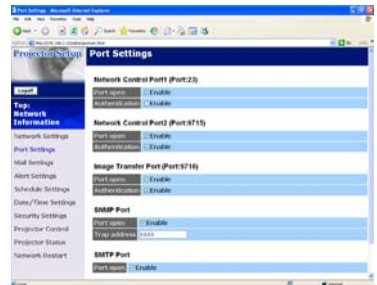

e-SHOT (Still Image Transfer) Settings (Continued)

When the authentication setting is enabled, the following settings are required.

- 6) Click [**Security Settings**] on the main menu.
- 7) Select [**Network Control**] and enter the desired authentication password.
- 8) Click the [**Apply**] button to save the settings.

NOTE • The Authentication Password will be the same for **Network Control Port1 (Port: 23)**, **Network Control Port2 (Port: 9715)**, and **Image Transfer Port (Port: 9716)**.

• The new configuration settings are activated after restarting the network connection. When the configuration settings are changed, you must restart the network connection. You can restart the network connection by clicking [**Network Restart**] on the main menu.

e-SHOT (Still Image Transfer) Transmission

e-SHOT transmission requires an exclusive application for your PC. You can download it from the Hitachi web site. Refer to the manual for the application for instructions.

To display the transferred image, select the e-SHOT item in the NETWORK menu ([📖](#) "NETWORK menu" section of the User's Manual - Operating Guide).

NOTE • It is possible to allocate the image file up to 4 in the maximum.

• The image file also can be displayed by using schedule function from the web browser. Refer to "Event Scheduling" ([📖](#) 26) in detail.

Command Control via the Network

You can configure and control the projector via the network using RS-232C commands.

Communication Port

The following two ports are assigned for the command control.

- TCP #23
- TCP #9715

NOTE • Command control is not available via communication port (TCP #9716) (📄9) that is used for the e-SHOT transmission function.

Command Control Settings

Configure the following items from a web browser when command control is used.

Example: If the IP address of the projector is set to 192.168.1.10:

- 1) Enter "**http://192.168.1.10/**" into the address bar of the web browser.
- 2) Enter the Administrator ID and password and click **[Logon]**.
- 3) Click **[Port Settings]** on the main menu.

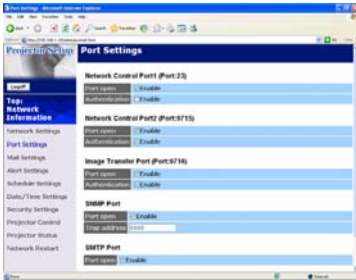

- 4) Click the **[Enable]** check box to open **Network Control Port1 (Port: 23)** to use TCP #23. Click the **[Enable]** check box for the **[Authentication]** setting when authentication is required, otherwise clear the check box.
- 5) Click the **[Enable]** check box to open **Network Control Port2 (Port: 9715)** to use TCP #9715. Click the **[Enable]** check box for the **[Authentication]** setting when authentication is required, otherwise clear the check box.
- 6) Click the **[Apply]** button to save the settings.

Command Control Settings (Continued)

When the authentication setting is enabled, the following settings are required.
(17)

- 7) Click [**Security Settings**] on the main menu.
- 8) Click [**Network Control**] and enter the desired authentication password.
- 9) Click the [**Apply**] button to save the settings.

NOTE • The Authentication Password will be the same for **Network Control Port1 (Port: 23)**, **Network Control Port2 (Port: 9715)**, and **Image Transfer Port (Port: 9716)**.

• The new configuration settings are activated after restarting the network connection. When the configuration settings are changed, you must restart the network connection. You can restart the network connection by clicking [**Network Restart**] on the main menu.

Command Format

Command formats differ among the different communication ports.

- TCP #23

You can use the RS-232C commands without any changes. The reply data format is the same as the RS-232C commands. However, the following reply will be sent back in the event of authentication failure when authentication is enabled.

<Reply in the event of an authentication error>

Reply	Error code	
0x1F	0x04	0x00

- TCP #9715

Send Data format

The following formatting is added to the header (0x02), Data length (0x0D), Checksum (1byte) and Connection ID (1 byte) of the RS-232C commands.

Header	Data length	RS-232Ccommand	Checksum	Connection ID
0x02	0x0D	13 bytes	1 byte	1 byte

Header → 0x02, Fixed

Data length → RS-232C commands byte length (0x0D, Fixed)

RS-232C commands → RS-232C commands that start with 0xBE 0xEF (13 bytes)

Check Sum → This is the value to make zero on the addition of the lower 8 bits from the header to the checksum.

Connection ID → Random value from 0 to 255 (This value is attached to the reply data)

Command Format (Continued)

Reply Data format

The connection ID (the data is same as the connection ID data on the sending data format) is attached to the RS-232C commands reply data.

<ACK reply>

Reply	Connection ID
0x06	1 byte

<NAK reply>

Reply	Connection ID
0x15	1 byte

<Error reply>

Reply	Error code	Connection ID
0x1C	2 bytes	1 byte

<Data reply>

Reply	Data	Connection ID
0x1D	2 bytes	1 byte

<Projector busy reply>

Reply	Status code	Connection ID
0x1F	2 bytes	1 byte

<Authentication error reply>

Reply	Authentication Error code		Connection ID
0x1F	0x04	0x00	1 byte

Automatic Connection Break

The TCP connection will be automatically disconnected after there is no communication for 30 seconds after being established.

Authentication

The projector does not accept commands without authentication success when authentication is enabled. The projector uses a challenge response type authentication with an MD5 (Message Digest 5) algorithm.

When the projector is using a LAN, a random 8 bytes will be returned if authentication is enabled. Bind this received 8 bytes and the Authentication Password and digest this data with the MD5 algorithm and add this in front of the commands to send.

Following is a sample if the Authentication Password is set to “password” and the random 8 bytes are “a572f60c”.

- 1) Select the projector.
- 2) Receive the random 8 bytes “a572f60c” from the projector.
- 3) Bind the random 8 bytes “a572f60c” and the Authentication Password “password” and it becomes “a572f60cpassword”.
- 4) Digest this bind “a572f60cpassword” with MD5 algorithm.
It will be “e3d97429adffa11bce1f7275813d4bde”.
- 5) Add this “e3d97429adffa11bce1f7275813d4bde” in front of the commands and send the data.
Send “e3d97429adffa11bce1f7275813d4bde”+command.
- 6) When the sending data is correct, the command will be performed and the reply data will be returned. Otherwise, an authentication error will be returned.

NOTE • As for the transmission of the second or subsequent commands, the authentication data can be omitted when the same connection.

Projector

CP-X205/CP-X305

User's Manual (detailed)

Technical

Example of PC signal

Resolution (H x V)	H. frequency (kHz)	V. frequency (Hz)	Rating	Signal mode
720 x 400	37.9	85.0	VESA	TEXT
640 x 480	31.5	59.9	VESA	VGA (60Hz)
640 x 480	37.9	72.8	VESA	VGA (72Hz)
640 x 480	37.5	75.0	VESA	VGA (75Hz)
640 x 480	43.3	85.0	VESA	VGA (85Hz)
800 x 600	35.2	56.3	VESA	SVGA (56Hz)
800 x 600	37.9	60.3	VESA	SVGA (60Hz)
800 x 600	48.1	72.2	VESA	SVGA (72Hz)
800 x 600	46.9	75.0	VESA	SVGA (75Hz)
800 x 600	53.7	85.1	VESA	SVGA (85Hz)
832 x 624	49.7	74.5		Mac 16" mode
1024 x 768	48.4	60.0	VESA	XGA (60Hz)
1024 x 768	56.5	70.1	VESA	XGA (70Hz)
1024 x 768	60.0	75.0	VESA	XGA (75Hz)
1024 x 768	68.7	85.0	VESA	XGA (85Hz)
1152 x 864	67.5	75.0	VESA	1152 x 864 (75Hz)
1280 x 960	60.0	60.0	VESA	1280 x 960 (60Hz)
1280 x 1024	64.0	60.0	VESA	SXGA (60Hz)
1280 x 1024	80.0	75.0	VESA	SXGA (75Hz)
1280 x 1024	91.1	85.0	VESA	SXGA (85Hz)
1600 x 1200	75.0	60.0	VESA	UXGA (60Hz)
1280 x 768	47.7	60.0	VESA	W-XGA (60Hz)
1400 x 1050	65.2	60.0	VESA	SXGA+ (60Hz)

- NOTE**
- Be sure to check jack type, signal level, timing and resolution before connecting this projector to a PC.
 - Some PCs may have multiple display screen modes. Use of some of these modes will not be possible with this projector.
 - Depending on the input signal, full-size display may not be possible in some cases. Refer to the number of display pixels above.
 - Although the projector can display signals with resolution up to UXGA (1600x1200), the signal will be converted to the projector's panel resolution before being displayed. The best display performance will be achieved if the resolutions of the input signal and projector panel are identical.
 - Automatically adjustment may not function correctly with some input signals.
 - The image may not be displayed correctly when the input sync signal is a composite sync or a sync on G.

Initial set signals

Initial set signals

The following signals are used for the initial settings. The signal timing of some PC models may be different. In such case, adjust the items V POSITION and H POSITION in IMAGE menu.

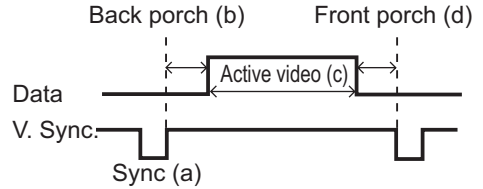
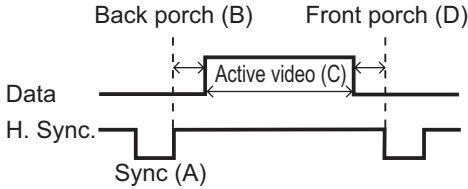

computer Signal	Horizontal signal timing (μs)			
	(A)	(B)	(C)	(D)
TEXT	2.0	3.0	20.3	1.0
VGA (60Hz)	3.8	1.9	25.4	0.6
VGA (72Hz)	1.3	4.1	20.3	0.8
VGA (75Hz)	2.0	3.8	20.3	0.5
VGA (85Hz)	1.6	2.2	17.8	1.6
SVGA (56Hz)	2.0	3.6	22.2	0.7
SVGA (60Hz)	3.2	2.2	20.0	1.0
SVGA (72Hz)	2.4	1.3	16.0	1.1
SVGA (75Hz)	1.6	3.2	16.2	0.3
SVGA (85Hz)	1.1	2.7	14.2	0.6
Mac 16" mode	1.1	3.9	14.5	0.6
XGA (60Hz)	2.1	2.5	15.8	0.4
XGA (70Hz)	1.8	1.9	13.7	0.3
XGA (75Hz)	1.2	2.2	13.0	0.2
XGA (85Hz)	1.0	2.2	10.8	0.5
1152 x 864 (75Hz)	1.2	2.4	10.7	0.6
1280 x 960 (60Hz)	1.0	2.9	11.9	0.9
SXGA (60Hz)	1.0	2.3	11.9	0.4
SXGA (75Hz)	1.1	1.8	9.5	0.1
SXGA (85Hz)	1.0	1.4	8.1	0.4
UXGA (60Hz)	1.2	1.9	9.9	0.4
W-XGA (60Hz)	1.7	2.5	16.0	0.8
SXGA+ (60Hz)	1.2	2.0	11.4	0.7

computer Signal	Vertical signal timing (lines)			
	(a)	(b)	(c)	(d)
TEXT	3	42	400	1
VGA (60Hz)	2	33	480	10
VGA (72Hz)	3	28	480	9
VGA (75Hz)	3	16	480	1
VGA (85Hz)	3	25	480	1
SVGA (56Hz)	2	22	600	1
SVGA (60Hz)	4	23	600	1
SVGA (72Hz)	6	23	600	37
SVGA (75Hz)	3	21	600	1
SVGA (85Hz)	3	27	600	1
Mac 16" mode	3	39	624	1
XGA (60Hz)	6	29	768	3
XGA (70Hz)	6	29	768	3
XGA (75Hz)	3	28	768	1
XGA (85Hz)	3	36	768	1
1152 x 864 (75Hz)	3	32	864	1
1280 x 960 (60Hz)	3	36	960	1
SXGA(60Hz)	3	38	1024	1
SXGA (75Hz)	3	38	1024	1
SXGA (85Hz)	3	44	1024	1
UXGA (60Hz)	3	46	1200	1
W-XGA (60Hz)	3	23	768	1
SXGA+ (60Hz)	3	33	1050	1

Connection to the ports

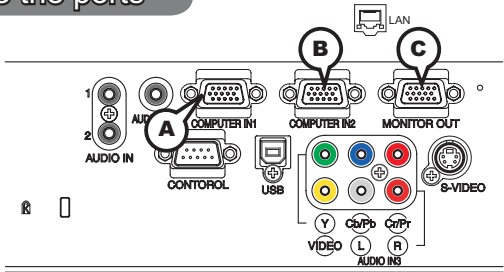

ⒶCOMPUTER IN1, ⒷCOMPUTER IN2, ⒸMONITOR OUT

D-sub 15pin mini shrink jack

- Video signal: RGB separate, Analog, 0.7Vp-p, 75Ω terminated (positive)
- H/V. sync. Signal: TTL level (positive/negative)
- Composite sync. Signal: TTL level

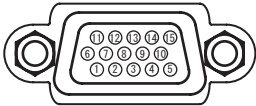

Pin	Signal	Pin	Signal
1	Video Red	10	Ground
2	Video Green	11	(No connection)
3	Video Blue	12	Ⓐ: SDA (DDC data) Ⓑ, Ⓒ: (No connection)
4	(No connection)		
5	Ground	13	H. sync / Composite sync.
6	Ground Red	14	V. sync.
7	Ground Green	15	Ⓐ: SCL (DDC clock) Ⓑ, Ⓒ: (No connection)
8	Ground Blue		
9	(No connection)	-	-

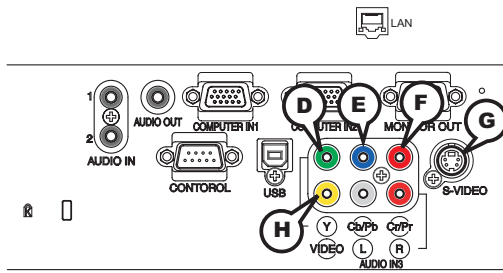

COMPONENT VIDEO **D** Y, **E** Pb/Cb, **F** Pr/Cr

RCA jack x3

- System: 525i(480i), 525p(480p), 625i(576i), 750p(720p), 1125i(1080i)

Port	Signal
Y	Component video Y, $1.0 \pm 0.1V_{p-p}$, 75Ω terminator with composite
Pb/Cb	Component video Pb/Cb, $0.7 \pm 0.1V_{p-p}$, 75Ω terminator
Pr/Cr	Component video Pr/Cr, $0.7 \pm 0.1V_{p-p}$, 75Ω terminator

GS-VIDEO

Mini DIN 4pin jack



Pin	Signal
1	Color signal $0.286V_{p-p}$ (NTSC, burst), 75Ω terminator Color signal $0.300V_{p-p}$ (PAL/SECAM, burst) 75Ω terminator
2	Brightness signal, $1.0V_{p-p}$, 75Ω terminator
3	Ground
4	Ground

HVIDEO

RCA jack

- System: NTSC, PAL, SECAM, PAL-M, PAL-N, NTSC4.43
- $1.0 \pm 0.1V_{p-p}$, 75Ω terminator

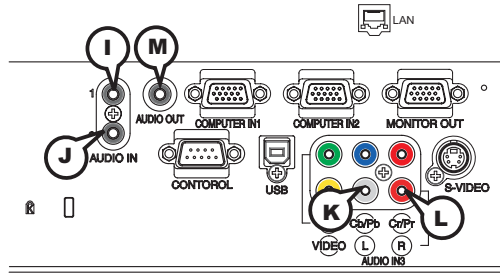

ⓐAUDIO IN1, ⓑAUDIO IN2

Ø3.5 stereo mini jack

- 200 mVrms 47kΩ terminator

AUDIO IN3 ⓑ, ⓓ

RCA jack x2

- 200 mVrms 47kΩ terminator

ⓓAUDIO OUT

Ø3.5 stereo mini jack

- 200 mVrms 1kΩ output impedance

To input SCART RGB signal;

ex.:

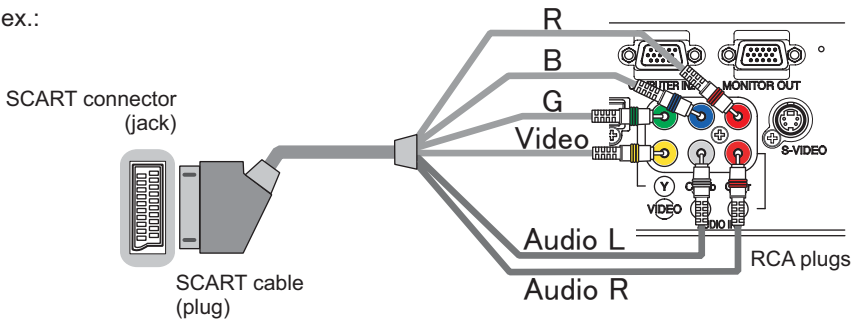

To input SCART RGB signal to the projector, use a SCART to RCA cable.

Connect the plugs refer to above ex.. For more reference, please consult your dealer.

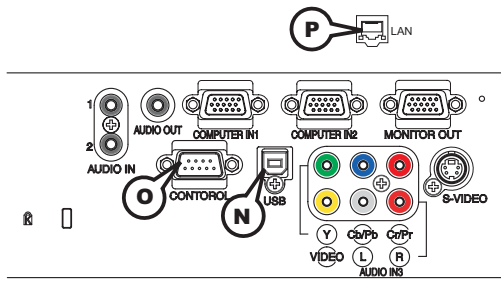

N USB

USB B type jack



Pin	Signal
1	+5V
2	- Data
3	+ Data
4	Ground

O CONTROL

D-sub 9pin plug

• About the details of RS-232C communication, please refer to the following page.

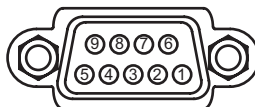

Pin	Signal	Pin	Signal	Pin	Signal
1	(No connection)	4	(No connection)	7	RTS
2	RD	5	Ground	8	CTS
3	TD	6	(No connection)	9	(No connection)

P LAN

RJ-45 jack

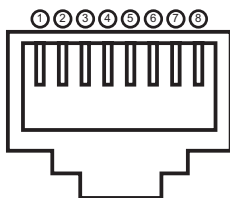

Pin	Signal	Pin	Signal	Pin	Signal
1	TX +	4	-	7	-
2	TX -	5	-	8	-
3	RX +	6	RX -	-	-

RS-232C Communication

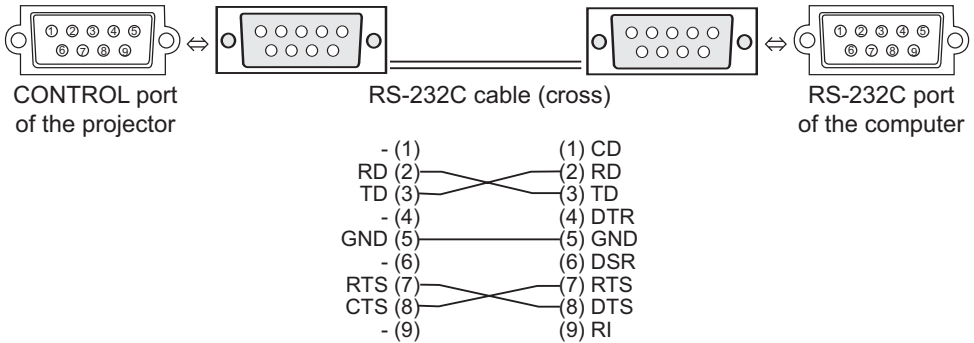

Connecting the cable

1. Turn off the projector and the computer.
2. Connect the CONTROL port of the projector with a RS-232C port of the computer by a RS-232C cable (cross). Use the cable that fulfills the specification shown in the previous page.
3. Turn the computer on, and after the computer has started up turn the projector on.

Communications setting

19200bps, 8N1

1. Protocol

Consist of header (7 bytes) + command data (6 bytes)

2. Header

BE + EF + 03 + 06 + 00 + CRC_low + CRC_high

CRC_low: Lower byte of CRC flag for command data

CRC_high: Upper byte of CRC flag for command data

3. Command data

Command data chart

byte_0	byte_1	byte_2	byte_3	byte_4	byte_5
Action		Type		Setting code	
low	high	low	high	low	high

Action (byte_0 - 1)

Action	Classification	Content
1	Set	Change setting to desired value.
2	Get	Read projector internal setup value.
4	Increment	Increment setup value by 1.
5	Decrement	Decrement setup value by 1.
6	Execute	Run a command.

Requesting projector status (Get command)

- (1) Send the following request code from the PC to the projector.
Header + Command data ('02H' + '00H' + type (2 bytes) + '00H' + '00H')
- (2) The projector returns the response code '1DH' + data (2 bytes) to the PC.

Changing the projector settings (Set command)

- (1) Send the following setting code from the PC to the projector.
Header + Command data ('01H' + '00H' + type (2 bytes) + setting code (2 bytes))
- (2) The projector changes the setting based on the above setting code.
- (3) The projector returns the response code '06H' to the PC.

Using the projector default settings (Reset Command)

- (1) The PC sends the following default setting code to the projector.
Header + Command data ('06H' + '00H' + type (2 bytes) + '00H' + '00H')
- (2) The projector changes the specified setting to the default value.
- (3) The projector returns the response code '06H' to the PC.

Increasing the projector setting value (Increment command)

- (1) The PC sends the following increment code to the projector.
Header + Command data ('04H' + '00H' + type (2 bytes) + '00H' + '00H')
- (2) The projector increases the setting value on the above setting code.
- (3) The projector returns the response code '06H' to the PC.

Decreasing the projector setting value (Decrement command)

- (1) The PC sends the following decrement code to the projector.
Header + Command data ('05H' + '00H' + type (2 bytes) + '00H' + '00H')
- (2) The projector decreases the setting value on the above setting code.
- (3) The projector returns the response code '06H' to the PC.

When the projector cannot understand the received command

When the projector cannot understand the received command, the error code '15H' is sent back to the PC.

Sometimes the projector cannot properly receive the command. In such a case, the command is not executed and the error code '15H' is sent back to the PC. If this error code is returned, send the same command again.

When the projector cannot execute the received command.

When the projector cannot execute the received command, the error code '1CH' + 'xxxxH' is sent back to the PC.

When the data length is greater than indicated by the data length code, the projector ignore the excess data code. Conversely when the data length is shorter than indicated by the data length code, an error code will be returned to the PC.

NOTE • Operation cannot be guaranteed when the projector receives an undefined command or data.

- Provide an interval of at least 40ms between the response code and any other code.
- The projector outputs test data when the power supply is switched ON, and when the lamp is lit. Ignore this data.
- Commands are not accepted during warm-up.

RS-232C communication command table

Names	Operation Type	Header				Command Data			
						CRC	Action	Type	Setting Code
Power	Set	Turn off	BE EF	03	06 00	2A D3	01 00	00 60	00 00
		Turn on	BE EF	03	06 00	BA D2	01 00	00 60	01 00
	Get		BE EF	03	06 00	19 D3	02 00	00 60	00 00
		[Example return]				01 00 00 00 [Off]		02 00 [Cool down]	
Input Source	Set	COMPUTER1	BE EF	03	06 00	FE D2	01 00	00 20	00 00
		COMPUTER2	BE EF	03	06 00	3E D0	01 00	00 20	04 00
		COMPONENT	BE EF	03	06 00	AE D1	01 00	00 20	05 00
		S-VIDEO	BE EF	03	06 00	9E D3	01 00	00 20	02 00
		VIDEO	BE EF	03	06 00	6E D3	01 00	00 20	01 00
	Get	BE EF	03	06 00	CD D2	02 00	00 20	00 00	
Error Status	Get		BE EF	03	06 00	D9 D8	02 00	20 60	00 00
		[Example return]				01 00 [Cover error]	02 00 [Fan error]	03 00 [Lamp error]	04 00 [Temp error]
					05 00 [Air flow error]	06 00 [Lamp time error]	07 00 [Cold error]	08 00 [Filter error]	
BRIGHTNESS	Get	BE EF	03	06 00	89 D2	02 00	03 20	00 00	
	Increment	BE EF	03	06 00	EF D2	04 00	03 20	00 00	
	Decrement	BE EF	03	06 00	3E D3	05 00	03 20	00 00	
BRIGHTNESS Reset	Execute	BE EF	03	06 00	58 D3	06 00	00 70	00 00	
CONTRAST	Get	BE EF	03	06 00	FD D3	02 00	04 20	00 00	
	Increment	BE EF	03	06 00	9B D3	04 00	04 20	00 00	
	Decrement	BE EF	03	06 00	4A D2	05 00	04 20	00 00	
CONTRAST Reset	Execute	BE EF	03	06 00	A4 D2	06 00	01 70	00 00	
PICTURE MODE	Set	NORMAL	BE EF	03	06 00	23 F6	01 00	BA 30	00 00
		CINEMA	BE EF	03	06 00	B3 F7	01 00	BA 30	01 00
		DYNAMIC	BE EF	03	06 00	E3 F4	01 00	BA 30	04 00
		BOARD(BLACK)	BE EF	03	06 00	E3 EF	01 00	BA 30	20 00
		BOARD(GREEN)	BE EF	03	06 00	73 EE	01 00	BA 30	21 00
		WHITEBOARD	BE EF	03	06 00	83 EE	01 00	BA 30	22 00
		DAYTIME	BE EF	03	06 00	E3 C7	01 00	BA 30	40 00
	Get	BE EF	03	06 00	10 F6	02 00	BA 30	00 00	
	[Example return]				01 00 [Normal]	04 00 [Cinema]	10 00 [Dynamic]	22 00 [Custom]	
					20 00 [BOARD(BLACK)]	21 00 [BOARD(GREEN)]	40 00 [WHITEBOARD]	[DAY TIME]	
GAMMA	Set	#1 DEFAULT	BE EF	03	06 00	07 E9	01 00	A1 30	20 00
		#1 CUSTOM	BE EF	03	06 00	07 FD	01 00	A1 30	10 00
		#2 DEFAULT	BE EF	03	06 00	97 E8	01 00	A1 30	21 00
		#2 CUSTOM	BE EF	03	06 00	97 FC	01 00	A1 30	11 00
		#3 DEFAULT	BE EF	03	06 00	67 E8	01 00	A1 30	22 00
		#3 CUSTOM	BE EF	03	06 00	67 FC	01 00	A1 30	12 00
		#4 DEFAULT	BE EF	03	06 00	F7 E9	01 00	A1 30	23 00
		#4 CUSTOM	BE EF	03	06 00	F7 FD	01 00	A1 30	13 00
		#5 DEFAULT	BE EF	03	06 00	C7 EB	01 00	A1 30	24 00
		#5 CUSTOM	BE EF	03	06 00	C7 FF	01 00	A1 30	14 00
		#6 DEFAULT	BE EF	03	06 00	57 EA	01 00	A1 30	25 00
	#6 CUSTOM	BE EF	03	06 00	57 FE	01 00	A1 30	15 00	
Get	BE EF	03	06 00	F4 F0	02 00	A1 30	00 00		

RS-232C communication command table (continued)

Names	Operation Type	Header				Command Data			
						CRC	Action	Type	Setting Code
User Gamma Pattern	Set	Off	BE EF	03	06 00	FB FA	01 00	80 30	00 00
		9 step gray scale	BE EF	03	06 00	6B FB	01 00	80 30	01 00
		15 steps gray scale	BE EF	03	06 00	9B FB	01 00	80 30	02 00
		Ramp	BE EF	03	06 00	0B FA	01 00	80 30	03 00
	Get	BE EF	03	06 00	C8 FA	02 00	80 30	00 00	
User Gamma Point 1	Get	BE EF	03	06 00	08 FE	02 00	90 30	00 00	
	Increment	BE EF	03	06 00	6E FE	04 00	90 30	00 00	
	Decrement	BE EF	03	06 00	BF FF	05 00	90 30	00 00	
User Gamma Point 2	Get	BE EF	03	06 00	F4 FF	02 00	91 30	00 00	
	Increment	BE EF	03	06 00	92 FF	04 00	91 30	00 00	
	Decrement	BE EF	03	06 00	43 FE	05 00	91 30	00 00	
User Gamma Point 3	Get	BE EF	03	06 00	B0 FF	02 00	92 30	00 00	
	Increment	BE EF	03	06 00	D6 FF	04 00	92 30	00 00	
	Decrement	BE EF	03	06 00	07 FE	05 00	92 30	00 00	
User Gamma Point 4	Get	BE EF	03	06 00	4C FE	02 00	93 30	00 00	
	Increment	BE EF	03	06 00	2A FE	04 00	93 30	00 00	
	Decrement	BE EF	03	06 00	FB FF	05 00	93 30	00 00	
User Gamma Point 5	Get	BE EF	03	06 00	38 FF	02 00	94 30	00 00	
	Increment	BE EF	03	06 00	5E FF	04 00	94 30	00 00	
	Decrement	BE EF	03	06 00	8F FE	05 00	94 30	00 00	
User Gamma Point 6	Get	BE EF	03	06 00	C4 FE	02 00	95 30	00 00	
	Increment	BE EF	03	06 00	A2 FE	04 00	95 30	00 00	
	Decrement	BE EF	03	06 00	73 FF	05 00	95 30	00 00	
User Gamma Point 7	Get	BE EF	03	06 00	80 FE	02 00	96 30	00 00	
	Increment	BE EF	03	06 00	E6 FE	04 00	96 30	00 00	
	Decrement	BE EF	03	06 00	37 FF	05 00	96 30	00 00	
User Gamma Point 8	Get	BE EF	03	06 00	7C FF	02 00	97 30	00 00	
	Increment	BE EF	03	06 00	1A FF	04 00	97 30	00 00	
	Decrement	BE EF	03	06 00	CB FE	05 00	97 30	00 00	
COLOR TEMP	Set	HIGH	BE EF	03	06 00	0B F5	01 00	B0 30	03 00
		CUSTOM-1 (HIGH)	BE EF	03	06 00	CB F8	01 00	B0 30	13 00
		MID	BE EF	03	06 00	9B F4	01 00	B0 30	02 00
		CUSTOM-2 (MID)	BE EF	03	06 00	5B F9	01 00	B0 30	12 00
		LOW	BE EF	03	06 00	6B F4	01 00	B0 30	01 00
		CUSTOM-3 (LOW)	BE EF	03	06 00	AB F9	01 00	B0 30	11 00
		Hi-BRIGHT-1	BE EF	03	06 00	3B F2	01 00	B0 30	08 00
		CUSTOM-4 (Hi-BRIGHT-1)	BE EF	03	06 00	FB FF	01 00	B0 30	18 00
		Hi-BRIGHT-2	BE EF	03	06 00	AB F3	01 00	B0 30	09 00
		CUSTOM-5 (Hi-BRIGHT-2)	BE EF	03	06 00	6B FE	01 00	B0 30	19 00
	Hi-BRIGHT-3	BE EF	03	06 00	5B F3	01 00	B0 30	0A 00	
CUSTOM-6 (Hi-BRIGHT-3)	BE EF	03	06 00	9B FE	01 00	B0 30	1A 00		
	Get	BE EF	03	06 00	C8 F5	02 00	B0 30	00 00	
COLOR TEMP GAIN R	Get	BE EF	03	06 00	34 F4	02 00	B1 30	00 00	
	Increment	BE EF	03	06 00	52 F4	04 00	B1 30	00 00	
	Decrement	BE EF	03	06 00	83 F5	05 00	B1 30	00 00	
COLOR TEMP GAIN G	Get	BE EF	03	06 00	70 F4	02 00	B2 30	00 00	
	Increment	BE EF	03	06 00	16 F4	04 00	B2 30	00 00	
	Decrement	BE EF	03	06 00	C7 F5	05 00	B2 30	00 00	

RS-232C communication command table (continued)

Names	Operation Type	Header				Command Data			
						CRC	Action	Type	Setting Code
COLOR TEMP GAIN B	Get	BE EF	03	06 00	8C F5	02 00	B3 30	00 00	
	Increment	BE EF	03	06 00	EA F5	04 00	B3 30	00 00	
	Decrement	BE EF	03	06 00	3B F4	05 00	B3 30	00 00	
COLOR TEMP OFFSET R	Get	BE EF	03	06 00	04 F5	02 00	B5 30	00 00	
	Increment	BE EF	03	06 00	62 F5	04 00	B5 30	00 00	
	Decrement	BE EF	03	06 00	B3 F4	05 00	B5 30	00 00	
COLOR TEMP OFFSET G	Get	BE EF	03	06 00	40 F5	02 00	B6 30	00 00	
	Increment	BE EF	03	06 00	26 F5	04 00	B6 30	00 00	
	Decrement	BE EF	03	06 00	F7 F4	05 00	B6 30	00 00	
COLOR TEMP OFFSET B	Get	BE EF	03	06 00	BC F4	02 00	B7 30	00 00	
	Increment	BE EF	03	06 00	DA F4	04 00	B7 30	00 00	
	Decrement	BE EF	03	06 00	0B F5	05 00	B7 30	00 00	
COLOR	Get	BE EF	03	06 00	B5 72	02 00	02 22	00 00	
	Increment	BE EF	03	06 00	D3 72	04 00	02 22	00 00	
	Decrement	BE EF	03	06 00	02 73	05 00	02 22	00 00	
COLOR Reset	Execute	BE EF	03	06 00	80 D0	06 00	0A 70	00 00	
TINT	Get	BE EF	03	06 00	49 73	02 00	03 22	00 00	
	Increment	BE EF	03	06 00	2F 73	04 00	03 22	00 00	
	Decrement	BE EF	03	06 00	FE 72	05 00	03 22	00 00	
TINT Reset	Execute	BE EF	03	06 00	7C D1	06 00	0B 70	00 00	
SHARPNESS	Get	BE EF	03	06 00	F1 72	02 00	01 22	00 00	
	Increment	BE EF	03	06 00	97 72	04 00	01 22	00 00	
	Decrement	BE EF	03	06 00	46 73	05 00	01 22	00 00	
SHARPNESS Reset	Execute	BE EF	03	06 00	C4 D0	06 00	09 70	00 00	
MY MEMORY Load	Set	1	BE EF	03	06 00	0E D7	01 00	14 20	00 00
		2	BE EF	03	06 00	9E D6	01 00	14 20	01 00
		3	BE EF	03	06 00	6E D6	01 00	14 20	02 00
		4	BE EF	03	06 00	FE D7	01 00	14 20	03 00
MY MEMORY Save	Set	1	BE EF	03	06 00	F2 D6	01 00	15 20	00 00
		2	BE EF	03	06 00	62 D7	01 00	15 20	01 00
		3	BE EF	03	06 00	92 D7	01 00	15 20	02 00
		4	BE EF	03	06 00	02 D6	01 00	15 20	03 00
PROGRESSIVE	Set	TURN OFF	BE EF	03	06 00	4A 72	01 00	07 22	00 00
		TV	BE EF	03	06 00	DA 73	01 00	07 22	01 00
		FILM	BE EF	03	06 00	2A 73	01 00	07 22	02 00
	Get	BE EF	03	06 00	79 72	02 00	07 22	00 00	
VIDEO NR	Set	LOW	BE EF	03	06 00	26 72	01 00	06 22	01 00
		MID	BE EF	03	06 00	D6 72	01 00	06 22	02 00
		HIGH	BE EF	03	06 00	46 73	01 00	06 22	03 00
	Get	BE EF	03	06 00	85 73	02 00	06 22	00 00	
ASPECT	Set	4:3	BE EF	03	06 00	9E D0	01 00	08 20	00 00
		16:9	BE EF	03	06 00	0E D1	01 00	08 20	01 00
		14:9	BE EF	03	06 00	CE D6	01 00	08 20	09 00
		SMALL	BE EF	03	06 00	FE D1	01 00	08 20	02 00
		NORMAL	BE EF	03	06 00	5E DD	01 00	08 20	10 00
	Get	BE EF	03	06 00	AD D0	02 00	08 20	00 00	

(continued on next page)

RS-232C communication command table (continued)

Names	Operation Type	Header				Command Data			
						CRC	Action	Type	Setting Code
OVER SCAN	Get	BE EF	03	06 00	91 70	02 00	09 22	00 00	
	Increment	BE EF	03	06 00	F7 70	04 00	09 22	00 00	
	Decrement	BE EF	03	06 00	26 71	05 00	09 22	00 00	
OVER SCAN Reset	Execute	BE EF	03	06 00	EC D9	06 00	27 70	00 00	
V POSITION	Get	BE EF	03	06 00	0D 83	02 00	00 21	00 00	
	Increment	BE EF	03	06 00	6B 83	04 00	00 21	00 00	
	Decrement	BE EF	03	06 00	BA 82	05 00	00 21	00 00	
V POSITION Reset	Execute	BE EF	03	06 00	E0 D2	06 00	02 70	00 00	
H POSITION	Get	BE EF	03	06 00	F1 82	02 00	01 21	00 00	
	Increment	BE EF	03	06 00	97 82	04 00	01 21	00 00	
	Decrement	BE EF	03	06 00	46 83	05 00	01 21	00 00	
H POSITION Reset	Execute	BE EF	03	06 00	1C D3	06 00	03 70	00 00	
H PHASE	Get	BE EF	03	06 00	49 83	02 00	03 21	00 00	
	Increment	BE EF	03	06 00	2F 83	04 00	03 21	00 00	
	Decrement	BE EF	03	06 00	FE 82	05 00	03 21	00 00	
H SIZE	Get	BE EF	03	06 00	B5 82	02 00	02 21	00 00	
	Increment	BE EF	03	06 00	D3 82	04 00	02 21	00 00	
	Decrement	BE EF	03	06 00	02 83	05 00	02 21	00 00	
H SIZE Reset	Execute	BE EF	03	06 00	68 D2	06 00	04 70	00 00	
AUTO ADJUST	Execute	BE EF	03	06 00	91 D0	06 00	0A 20	00 00	
COLOR SPACE	Set	AUTO	BE EF	03	06 00	0E 72	01 00	04 22	00 00
		RGB	BE EF	03	06 00	9E 73	01 00	04 22	01 00
		SMPTE240	BE EF	03	06 00	6E 73	01 00	04 22	02 00
		REC709	BE EF	03	06 00	FE 72	01 00	04 22	03 00
		REC601	BE EF	03	06 00	CE 70	01 00	04 22	04 00
	Get	BE EF	03	06 00	3D 72	02 00	04 22	00 00	
COMPONENT	Set	COMPONENT	BE EF	03	06 00	4A D7	01 00	17 20	00 00
		SCART RGB	BE EF	03	06 00	DA D6	01 00	17 20	01 00
	Get	BE EF	03	06 00	79 D7	02 00	17 20	00 00	
C-VIDEO FORMAT	Set	AUTO	BE EF	03	06 00	A2 70	01 00	11 22	0A 00
		NTSC	BE EF	03	06 00	C2 74	01 00	11 22	04 00
		PAL	BE EF	03	06 00	52 75	01 00	11 22	05 00
		SECAM	BE EF	03	06 00	52 70	01 00	11 22	09 00
		NTSC4.43	BE EF	03	06 00	62 77	01 00	11 22	02 00
		M-PAL	BE EF	03	06 00	C2 71	01 00	11 22	08 00
	N-PAL	BE EF	03	06 00	32 74	01 00	11 22	07 00	
Get	BE EF	03	06 00	31 76	02 00	11 22	00 00		
S-VIDEO FORMAT	Set	AUTO	BE EF	03	06 00	E6 70	01 00	12 22	0A 00
		NTSC	BE EF	03	06 00	86 74	01 00	12 22	04 00
		PAL	BE EF	03	06 00	16 75	01 00	12 22	05 00
		SECAM	BE EF	03	06 00	16 70	01 00	12 22	09 00
		NTSC4.43	BE EF	03	06 00	26 77	01 00	12 22	02 00
		M-PAL	BE EF	03	06 00	86 71	01 00	12 22	08 00
	N-PAL	BE EF	03	06 00	76 74	01 00	12 22	07 00	
Get	BE EF	03	06 00	75 76	02 00	12 22	00 00		
FRAME LOCK	Set	TURN OFF	BE EF	03	06 00	CB D6	01 00	14 30	00 00
		TURN ON	BE EF	03	06 00	5B D7	01 00	14 30	01 00
	Get	BE EF	03	06 00	F8 D6	02 00	14 30	00 00	

RS-232C communication command table (continued)

Names	Operation Type	Header				Command Data			
						CRC	Action	Type	Setting Code
COMPUTER IN1	Set	SYNC ON G ON	BE EF	03	06 00	CE D6	01 00	10 20	03 00
		SYNC ON G OFF	BE EF	03	06 00	5E D7	01 00	10 20	02 00
	Get	BE EF	03	06 00	0D D6	02 00	10 20	00 00	
COMPUTER IN2	Set	SYNC ON G ON	BE EF	03	06 00	32 D7	01 00	11 20	03 00
		SYNC ON G OFF	BE EF	03	06 00	A2 D6	01 00	11 20	02 00
	Get	BE EF	03	06 00	F1 D7	02 00	11 20	00 00	
KEYSTONE V	Get	BE EF	03	06 00	B9 D3	02 00	07 20	00 00	
	Increment	BE EF	03	06 00	DF D3	04 00	07 20	00 00	
	Decrement	BE EF	03	06 00	0E D2	05 00	07 20	00 00	
KEYSTONE V Reset	Execute	BE EF	03	06 00	08 D0	06 00	0C 70	00 00	
AUTO KEYSTONE EXECUTE	Execute	BE EF	03	06 00	E5 D1	06 00	0D 20	00 00	
WHISPER	Set	NORMAL	BE EF	03	06 00	3B 23	01 00	00 33	00 00
		WHISPER	BE EF	03	06 00	AB 22	01 00	00 33	01 00
	Get	BE EF	03	06 00	08 23	02 00	00 33	00 00	
MIRROR	Set	NORMAL	BE EF	03	06 00	C7 D2	01 00	01 30	00 00
		H:INVERT	BE EF	03	06 00	57 D3	01 00	01 30	01 00
		V:INVERT	BE EF	03	06 00	A7 D3	01 00	01 30	02 00
		H&V:INVERT	BE EF	03	06 00	37 D2	01 00	01 30	03 00
	Get	BE EF	03	06 00	F4 D2	02 00	01 30	00 00	
VOLUME-COMPUTER1	Get	BE EF	03	06 00	CD CC	02 00	60 20	00 00	
	Increment	BE EF	03	06 00	AB CC	04 00	60 20	00 00	
	Decrement	BE EF	03	06 00	7A CD	05 00	60 20	00 00	
VOLUME-COMPUTER2	Get	BE EF	03	06 00	FD CD	02 00	64 20	00 00	
	Increment	BE EF	03	06 00	9B CD	04 00	64 20	00 00	
	Decrement	BE EF	03	06 00	4A CC	05 00	64 20	00 00	
VOLUME-COMPONENT	Get	BE EF	03	06 00	01 CC	02 00	65 20	00 00	
	Increment	BE EF	03	06 00	67 CC	04 00	65 20	00 00	
	Decrement	BE EF	03	06 00	B6 CD	05 00	65 20	00 00	
VOLUME-S-Video	Get	BE EF	03	06 00	75 CD	02 00	62 20	00 00	
	Increment	BE EF	03	06 00	13 CD	04 00	62 20	00 00	
	Decrement	BE EF	03	06 00	C2 CC	05 00	62 20	00 00	
VOLUME-Video	Get	BE EF	03	06 00	31 CD	02 00	61 20	00 00	
	Increment	BE EF	03	06 00	57 CD	04 00	61 20	00 00	
	Decrement	BE EF	03	06 00	86 CC	05 00	61 20	00 00	
MUTE	Set	TURN OFF	BE EF	03	06 00	46 D3	01 00	02 20	00 00
		TURN ON	BE EF	03	06 00	D6 D2	01 00	02 20	01 00
	Get	BE EF	03	06 00	75 D3	02 00	02 20	00 00	
SPEAKER	Set	TURN ON	BE EF	03	06 00	FE D4	01 00	1C 20	01 00
		TURN OFF	BE EF	03	06 00	6E D5	01 00	1C 20	00 00
	Get	BE EF	03	06 00	5D D5	02 00	1C 20	00 00	

(continued on next page)

RS-232C communication command table (continued)

Names	Operation Type	Header				Command Data			
						CRC	Action	Type	Setting Code
AUDIO-COMPUTER1	Set	AUDIO1	BE EF	03	06 00	6E DC	01 00	30 20	01 00
		AUDIO2	BE EF	03	06 00	9E DC	01 00	30 20	02 00
		AUDIO3	BE EF	03	06 00	0E DD	01 00	30 20	03 00
		Turn off	BE EF	03	06 00	FE DD	01 00	30 20	00 00
	Get	BE EF	03	06 00	CD DD	02 00	30 20	00 00	
AUDIO-COMPUTER2	Set	AUDIO1	BE EF	03	06 00	5E DD	01 00	34 20	01 00
		AUDIO2	BE EF	03	06 00	AE DD	01 00	34 20	02 00
		AUDIO3	BE EF	03	06 00	3E DC	01 00	34 20	03 00
		Turn off	BE EF	03	06 00	CE DC	01 00	34 20	00 00
	Get	BE EF	03	06 00	FD DC	02 00	34 20	00 00	
AUDIO-COMPONENT	Set	AUDIO1	BE EF	03	06 00	A2 DC	01 00	35 20	01 00
		AUDIO2	BE EF	03	06 00	52 DC	01 00	35 20	02 00
		AUDIO3	BE EF	03	06 00	C2 DD	01 00	35 20	03 00
		Turn off	BE EF	03	06 00	32 DD	01 00	35 20	00 00
	Get	BE EF	03	06 00	01 DD	02 00	35 20	00 00	
AUDIO-S-VIDEO	Set	AUDIO1	BE EF	03	06 00	D6 DD	01 00	32 20	01 00
		AUDIO2	BE EF	03	06 00	26 DD	01 00	32 20	02 00
		AUDIO3	BE EF	03	06 00	B6 DC	01 00	32 20	03 00
		Turn off	BE EF	03	06 00	46 DC	01 00	32 20	00 00
	Get	BE EF	03	06 00	75 DC	02 00	32 20	00 00	
AUDIO-VIDEO	Set	AUDIO1	BE EF	03	06 00	92 DD	01 00	31 20	01 00
		AUDIO2	BE EF	03	06 00	62 DD	01 00	31 20	02 00
		AUDIO3	BE EF	03	06 00	F2 DC	01 00	31 20	03 00
		Turn off	BE EF	03	06 00	02 DC	01 00	31 20	00 00
	Get	BE EF	03	06 00	31 DC	02 00	31 20	00 00	
IR REMOTE FREQ. NORMAL	Set	Off	BE EF	03	06 00	FF 3D	01 00	30 26	00 00
		On	BE EF	03	06 00	6F 3C	01 00	30 26	01 00
	Get	BE EF	03	06 00	CC 3D	02 00	30 26	00 00	
IR REMOTE FREQ. HIGH	Set	Off	BE EF	03	06 00	03 3C	01 00	31 26	00 00
		On	BE EF	03	06 00	93 3D	01 00	31 26	01 00
	Get	BE EF	03	06 00	30 3C	02 00	31 26	00 00	

(continued on next page)

RS-232C communication command table (continued)

Names	Operation Type	Header					Command Data		
							CRC	Action	Type
LANGUAGE	Set	ENGLISH	BE EF	03	06 00	F7 D3	01 00	05 30	00 00
		FRANÇAIS	BE EF	03	06 00	67 D2	01 00	05 30	01 00
		DEUTSCH	BE EF	03	06 00	97 D2	01 00	05 30	02 00
		ESPAÑOL	BE EF	03	06 00	07 D3	01 00	05 30	03 00
		ITALIANO	BE EF	03	06 00	37 D1	01 00	05 30	04 00
		NORSK	BE EF	03	06 00	A7 D0	01 00	05 30	05 00
		NEDERLANDS	BE EF	03	06 00	57 D0	01 00	05 30	06 00
		PORTUGUÊS	BE EF	03	06 00	C7 D1	01 00	05 30	07 00
		日本語	BE EF	03	06 00	37 D4	01 00	05 30	08 00
		简体中文	BE EF	03	06 00	A7 D5	01 00	05 30	09 00
		繁體中文	BE EF	03	06 00	37 DE	01 00	05 30	10 00
		한글	BE EF	03	06 00	57 D5	01 00	05 30	0A 00
		SVENSKA	BE EF	03	06 00	C7 D4	01 00	05 30	0B 00
		РУССКИЙ	BE EF	03	06 00	F7 D6	01 00	05 30	0C 00
	SUOMI	BE EF	03	06 00	67 D7	01 00	05 30	0D 00	
POLSKI	BE EF	03	06 00	97 D7	01 00	05 30	0E 00		
TÜRKÇE	BE EF	03	06 00	07 D6	01 00	05 30	0F 00		
	Get	BE EF	03	06 00	C4 D3	02 00	05 30	00 00	
MENU POSITION H	Get	BE EF	03	06 00	04 D7	02 00	15 30	00 00	
	Increment	BE EF	03	06 00	62 D7	04 00	15 30	00 00	
	Decrement	BE EF	03	06 00	B3 D6	05 00	15 30	00 00	
MENU POSITION H Reset	Execute	BE EF	03	06 00	DC C6	06 00	43 70	00 00	
MENU POSITION V	Get	BE EF	03	06 00	40 D7	02 00	16 30	00 00	
	Increment	BE EF	03	06 00	26 D7	04 00	16 30	00 00	
	Decrement	BE EF	03	06 00	F7 D6	05 00	16 30	00 00	
MENU POSITION V Reset	Execute	BE EF	03	06 00	A8 C7	06 00	44 70	00 00	
BLANK	Set	MyScreen	BE EF	03	06 00	FB CA	01 00	00 30	20 00
		ORIGINAL	BE EF	03	06 00	FB E2	01 00	00 30	40 00
		BLUE	BE EF	03	06 00	CB D3	01 00	00 30	03 00
		WHITE	BE EF	03	06 00	6B D0	01 00	00 30	05 00
	BLACK	BE EF	03	06 00	9B D0	01 00	00 30	06 00	
	Get	BE EF	03	06 00	08 D3	02 00	00 30	00 00	
BLANK On/Off	Set	TURN OFF	BE EF	03	06 00	FB D8	01 00	20 30	00 00
		TURN ON	BE EF	03	06 00	6B D9	01 00	20 30	01 00
	Get	BE EF	03	06 00	C8 D8	02 00	20 30	00 00	
START UP	Set	MyScreen	BE EF	03	06 00	CB CB	01 00	04 30	20 00
		ORIGINAL	BE EF	03	06 00	0B D2	01 00	04 30	00 00
		TURN OFF	BE EF	03	06 00	9B D3	01 00	04 30	01 00
	Get	BE EF	03	06 00	38 D2	02 00	04 30	00 00	
MyScreen LOCK	Set	TURN OFF	BE EF	03	06 00	3B EF	01 00	C0 30	00 00
		TURN ON	BE EF	03	06 00	AB EE	01 00	C0 30	01 00
	Get	BE EF	03	06 00	08 EF	02 00	C0 30	00 00	
MESSAGE	Set	TURN OFF	BE EF	03	06 00	8F D6	01 00	17 30	00 00
		TURN ON	BE EF	03	06 00	1F D7	01 00	17 30	01 00
	Get	BE EF	03	06 00	BC D6	02 00	17 30	00 00	
AUTO SEARCH	Set	TURN OFF	BE EF	03	06 00	B6 D6	01 00	16 20	00 00
		TURN ON	BE EF	03	06 00	26 D7	01 00	16 20	01 00
	Get	BE EF	03	06 00	85 D6	02 00	16 20	00 00	

(continued on next page)

RS-232C communication command table (continued)

Names	Operation Type	Header				Command Data			
						CRC	Action	Type	Setting Code
AUTO KEYSTONE	Set	TURN OFF	BE EF	03	06 00	EA D1	01 00	0F 20	00 00
		TURN ON	BE EF	03	06 00	7A D0	01 00	0F 20	01 00
	Get	BE EF	03	06 00	D9 D1	02 00	0F 20	00 00	
AUTO ON	Set	TURN OFF	BE EF	03	06 00	3B 89	01 00	20 31	00 00
		TURN ON	BE EF	03	06 00	AB 88	01 00	20 31	01 00
	Get	BE EF	03	06 00	08 89	02 00	20 31	00 00	
AUTO OFF	Get	BE EF	03	06 00	08 86	02 00	10 31	00 00	
	Increment	BE EF	03	06 00	6E 86	04 00	10 31	00 00	
	Decrement	BE EF	03	06 00	BF 87	05 00	10 31	00 00	
LAMP TIME	Get	BE EF	03	06 00	C2 FF	02 00	90 10	00 00	
LAMP TIME Reset	Execute	BE EF	03	06 00	58 DC	06 00	30 70	00 00	
FILTER TIME	Get	BE EF	03	06 00	C2 F0	02 00	A0 10	00 00	
FILER TIME Reset	Execute	BE EF	03	06 00	98 C6	06 00	40 70	00 00	
MY BUTTON-1	COMPUTER1	BE EF	03	06 00	3A 33	01 00	00 36	00 00	
	COMPUTER2	BE EF	03	06 00	FA 31	01 00	00 36	04 00	
	COMPONENT	BE EF	03	06 00	6A 30	01 00	00 36	05 00	
	S-VIDEO	BE EF	03	06 00	5A 32	01 00	00 36	02 00	
	VIDEO	BE EF	03	06 00	AA 32	01 00	00 36	01 00	
	INFORMATION	BE EF	03	06 00	FA 3E	01 00	00 36	10 00	
	AUTO KEYSTONE EXECUTE	BE EF	03	06 00	6A 3F	01 00	00 36	11 00	
	MY MEMORY	BE EF	03	06 00	9A 3F	01 00	00 36	12 00	
	PICTURE MODE	BE EF	03	06 00	0A 3E	01 00	00 36	13 00	
	FILTER RESET	BE EF	03	06 00	3A 3C	01 00	00 36	14 00	
	e-SHOT	BE EF	03	06 00	5A 3D	01 00	00 36	16 00	
	VOLUME +	BE EF	03	06 00	CA 3C	01 00	00 36	17 00	
	VOLUME -	BE EF	03	06 00	3A 39	01 00	00 36	18 00	
	Get	BE EF	03	06 00	09 33	02 00	00 36	00 00	
	MY BUTTON-2	COMPUTER1	BE EF	03	06 00	C6 32	01 00	01 36	00 00
		COMPUTER2	BE EF	03	06 00	06 30	01 00	01 36	04 00
		COMPONENT	BE EF	03	06 00	96 31	01 00	01 36	05 00
S-VIDEO		BE EF	03	06 00	A6 33	01 00	01 36	02 00	
VIDEO		BE EF	03	06 00	56 33	01 00	01 36	01 00	
INFORMATION		BE EF	03	06 00	06 3F	01 00	01 36	10 00	
AUTO KEYSTONE EXECUTE		BE EF	03	06 00	96 3E	01 00	01 36	11 00	
MY MEMORY		BE EF	03	06 00	66 3E	01 00	01 36	12 00	
PICTURE MODE		BE EF	03	06 00	F6 3F	01 00	01 36	13 00	
FILTER RESET		BE EF	03	06 00	C6 3D	01 00	01 36	14 00	
e-SHOT		BE EF	03	06 00	A6 3C	01 00	01 36	16 00	
VOLUME +		BE EF	03	06 00	36 3D	01 00	01 36	17 00	
VOLUME -		BE EF	03	06 00	C6 38	01 00	01 36	18 00	
Get		BE EF	03	06 00	F5 32	02 00	01 36	00 00	
MAGNIFY		Get	BE EF	03	06 00	7C D2	02 00	07 30	00 00
		Increment	BE EF	03	06 00	1A D2	04 00	07 30	00 00
		Decrement	BE EF	03	06 00	CB D3	05 00	07 30	00 00
FREEZE	Set	NORMAL	BE EF	03	06 00	83 D2	01 00	02 30	00 00
		FREEZE	BE EF	03	06 00	13 D3	01 00	02 30	01 00
	Get	BE EF	03	06 00	B0 D2	02 00	02 30	00 00	

RS-232C communication command table (continued)

Names	Operation Type	Header				Command Data			
						CRC	Action	Type	Setting Code
e-SHOT	Set	OFF	BE EF	03	06 00	3A C3	01 00	00 35	00 00
		IMAGE1	BE EF	03	06 00	AA C2	01 00	00 35	01 00
		IMAGE2	BE EF	03	06 00	5A C2	01 00	00 35	02 00
		IMAGE3	BE EF	03	06 00	CA C3	01 00	00 35	03 00
	IMAGE4	BE EF	03	06 00	FA C1	01 00	00 35	04 00	
	Get	BE EF	03	06 00	09 C3	02 00	00 35	00 00	
e-SHOT IMAGE1 Delete	Execute	BE EF	03	06 00	71 C3	06 00	01 35	00 00	
e-SHOT IMAGE2 Delete	Execute	BE EF	03	06 00	35 C3	06 00	02 35	00 00	
e-SHOT IMAGE3 Delete	Execute	BE EF	03	06 00	C9 C2	06 00	03 35	00 00	
e-SHOT IMAGE4 Delete	Execute	BE EF	03	06 00	BD C3	06 00	04 35	00 00	

HITACHI

Inspire the Next

Hitachi, Ltd. Japan
292 Yoshida-cho
Totsuka-ku, Yokohama-city
Kanagawa 244-0817

HITACHI EUROPE LTD.

Consumer Affairs Department
PO Box 3007
Maidenhead
SL6 8ZE

UNITED KINGDOM

Tel: 0870 405 4405
Email: consumer.mail@Hitachi-eu.com

HITACHI EUROPE GmbH

Munich Office
Dornacher Strasse 3
D-85622 Feldkirchen bei München

GERMANY

Tel: +49 -89-991 80-0
Fax: +49 - 89 - 991 80 -224
Hotline: +49 - 180 - 551 25 51 (12ct/min.)
Email: HSE-DUS.Service@Hitachi-eu.com

HITACHI EUROPE SRL

Via T. Gulli n.39
20147 MILAN

ITALY

Tel: 02 487861
Fax: 02 48786381
Servizio Clienti
Tel. 02 38073415
Email: customerservice.italy@hitachi-eu.com

HITACHI EUROPE S.A.S

Lyon Office
B.P.45, 4 Allée des Sorbiers 69671 Bron Cedex

FRANCE

Tel: 04 72 14 29 70
Fax: 04 72 14 29 99
Email: france.consommateur@hitachi-eu.com

HITACHI EUROPE S.A.

364, Kifissias Ave. & 1, Delfon Str.
152 33 Chalandri
Athens

GREECE

Tel: 1-6837200
Fax: 1-6835694
Email: service.hellas@hitachi-eu.com

HITACHI EUROPE S.A.

Gran Via Carlos III
86 Planta 5a Edificios
Trade - Torre Este
08028 Barcelona

SPAIN

Tel: 93 409 2550
Fax: 93 491 3513
Email: atencion.cliente@hitachi-eu.com

HITACHI EUROPE AB

Box 77
S-164 94 KISTA

SWEDEN

Tel: 08 562 711 00
Fax: 08 562 711 11
Email: csgswe@hitachi-eu.com

HITACHI EUROPE LTD.

Norwegian Branch Office
Strandveien 18
1366 Lysaker

NORWAY

Tel: 02205 9060
Fax: 02205 9061
Email: csgnor@hitachi-eu.com

HITACHI EUROPE LTD.

BENELUX BRANCHE OFFICE

BERGENSESTEENWEG 421
1600 SINT-PIETERS-LEEUEW

BELGIUM

Tel:0032/2 363 99 01
Fax:0032/2 363 99 00
Email:info@hitachi.be

www.hitachidigitalmedia.com