

myprojectorlamps.com

**The most trusted, dependable name
in projector lamp sales.**



<http://www.myprojectorlamps.com>



<http://www.myprojectorlamps.ca>



<http://www.myprojectorlamps.eu>

The following projector manual has not been modified or altered in any way.

Projector CP-X1200/CP-X1250 User's Manual - Operating Guide

HITACHI
Inspire the Next

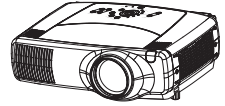

Thank you for purchasing this projector.



WARNING Before using, read the "User's Manual - Safety Guide" and these manuals to ensure correct usage through understanding. After reading, store them in a safe place for future reference.

NOTE

- The information in this manual is subject to change without notice.
- The manufacturer assumes no responsibility for any errors that may appear in this manual.
- The reproduction, transmission or use of this document or contents is not permitted without express written authority.

TRADEMARK ACKNOWLEDGMENT :

- VGA and XGA are registered trademarks of the International Business Machines Corporation.
- Apple and Mac are registered trademarks of Apple Computer, Inc.
- VESA and SVGA are trademarks of the Video Electronics Standard Association.
- Windows is a registered trademark of Microsoft Corporation.
- Internet Explorer is a trademark of Microsoft Corporation.

All other trademarks are the property of their respective owners.

Projector Features

This multimedia projector is used to project various computer signals as well as NTSC/PAL/SECAM video signals onto a screen. Little space is required for installation and large images can easily be realized.

● **Ultra High Brightness**

Crisp, ultra-bright presentations is achieved by using a UHB (ultra high brightness) lamp and a highly efficient optical system.

● **Whisper Mode Equipped**

Special mode is available for reducing projector noise to achieve quieter operation.

● **User Memory Function**

This projector can memorize 4 settings by MY MEMORY function.

● **Partial Magnification Function**

Interesting parts of images can be magnified for closer viewing.

● **Keystone Distortion Correction**

Quick correction of distorted images electrically.

● **Optical Lens Shift**

The lens of this projector can be shifted vertically. When you want to finely adjust the picture position, use the LENS SHIFT buttons.

Preparation

Please see the "Contents Of Package" of the "User's Manual – Quick Guide". Your projector should come with the items shown there. Contact your dealer anything is missing.

NOTE • Keep the original packing material for future reshipment. For moving the projector, be sure to use the original packing material. Use special caution for the lens part.

Contents

Projector Features	2
Preparation	2
Part Names	4
Projector	4
Control Buttons	5
Remote control	5
Setting Up	6
Arrangement	6
Adjusting The Projector's Elevator	7
Using The Lens shift Buttons	7
Connecting Your Devices	8
Connecting The Power Supply	11
Remote Control	12
About The Laser Pointer	12
Putting Batteries	12
Operating The Remote Control	13
Using The Remote ID Feature	13
Using The Mouse/Keyboard Control Function	14
Power ON/OFF	15
Turning On The Power	15
Turning Off The Power	15
Operating	16
Selecting An Input Signal	16
Selecting The Aspect Ratio	17
Using The Automatic Adjustment Feature	17
Adjusting The Picture Position	18
Correcting The Keystone Distortion	18
Adjusting The Volume	19
Muting The Sound	19
Temporarily Blanking The Screen	19
Freezing The Screen	20
Using The Magnify Feature	20
Displaying The Child Window	21
Selecting An Audio Input	21
Multifunctional Settings	22
Using The Menu Functions	22
MAIN Menu	23
PICTURE-1 Menu	24
PICTURE-2 Menu	26
INPUT Menu	27
AUTO Menu	29
SCREEN Menu	31
OPTION Menu	33
NETWORK Menu	35
Network Setting Up	36
Lamp	37
Replacing The Lamp	38
Air Filter	39
Caring For The Air Filter	39
Other Care	40
Caring For The Inside Of The Projector	40
Caring For The Lens	40
Caring For The Cabinet And Remote Control	40
Troubleshooting	41
Related Messages	41
Regarding The Indicator Lamps	43
Phenomena That May Easily Be Mistaken For Machine Defects	45
Warranty And After-Service	47
Specifications	47
TECHNICAL	

Part Names

Projector

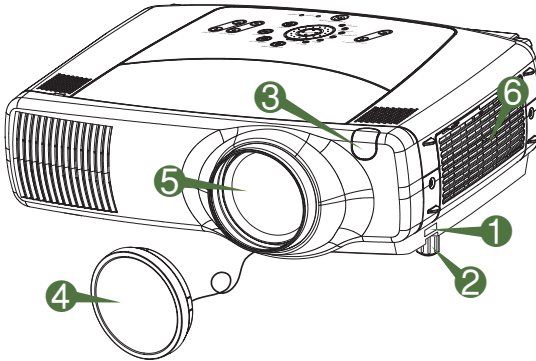

Projector (Front/Right)

- ① Elevator button
- ② Elevator foot
- ③ Remote sensor
- ④ Lens cap
- ⑤ Lens

The picture is projected from here.

- ⑥ Filter cover
An air filter is inside.

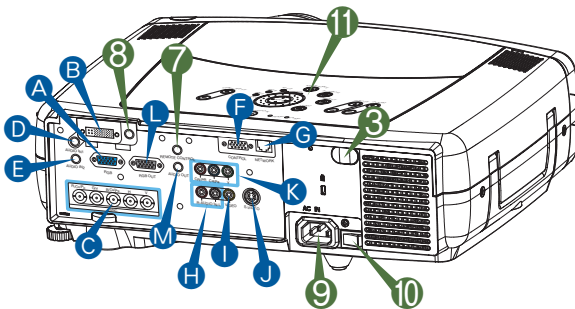

Projector (Rear/Left)

- Ⓐ RGB port
- Ⓑ M1-D port
- Ⓒ BNC port
- Ⓓ AUDIO IN 1 port
- Ⓔ AUDIO IN 2 port
- Ⓕ CONTROL port
- Ⓖ NETWORK port
- Ⓗ AUDIO IN R/L port
- Ⓘ VIDEO IN port
- Ⓙ S-VIDEO port
- Ⓚ COMPONENT port
- Ⓛ RGB OUT port
- Ⓜ AUDIO OUT port
- ⑦ REMOTE CONTROL port
- ⑧ DC OUT port
- ⑨ AC Inlet
- ⑩ Power switch
- Ⓜ Control buttons

See the following page.

Part Names (continued)

Control Buttons

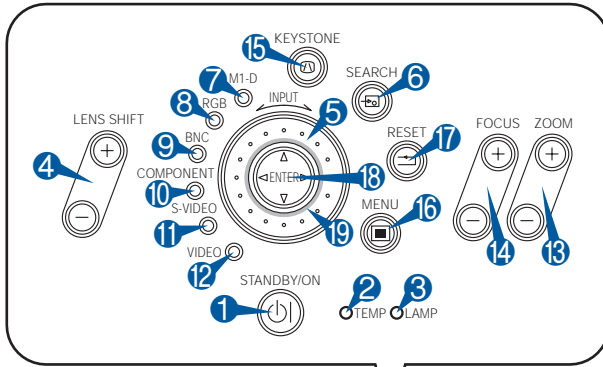

Control Panel
on the Projector

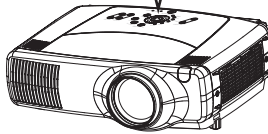

- 1 STANDBY/ON button and STANDBY/ON indicator
- 2 TEMP indicator
- 3 LAMP indicator
- 4 LENS SHIFT buttons
- 5 INPUT dial
- 6 SEARCH button
- 7 M1-D indicator
- 8 RGB indicator
- 9 BNC indicator
- 10 COMPONENT indicator
- 11 S-VIDEO indicator
- 12 VIDEO indicator
- 13 ZOOM buttons
- 14 FOCUS buttons
- 15 KEYSTONE button
- 16 MENU button
- 17 RESET button
- 18 ENTER button
- 19 Cursor buttons ▲/▼/◀/▶

Remote Control

- 1 STANDBY/ON button
- 4 LENS SHIFT buttons
- 6 SEARCH button
- 13 ZOOM buttons
- 14 FOCUS buttons
- 15 KEYSTONE button
- 16 MENU button
- 17 RESET button
- 18 ENTER button
(⏏ Mouse left button)

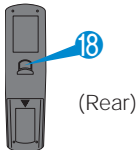

- 19 Cursor buttons
▲/▼/◀/▶
(⌨ Keyboard
Arrow keys ⏏/⏏/⏏/⏏)

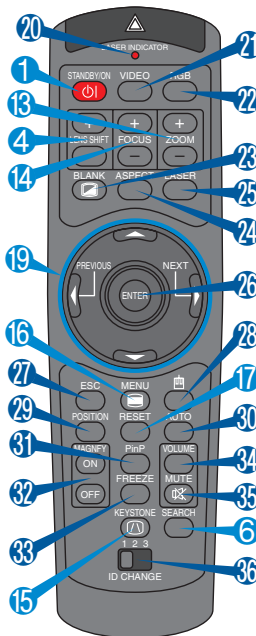

- 20 LASER INDICATOR
- 21 VIDEO button
- 22 RGB button
- 23 BLANK button
- 24 ASPECT button
- 25 LASER button
- 26 Cursor buttons ▲/▼/◀/▶
(⏏ Mouse move pointer)
- 27 ESC button
(⌨ Keyboard [ESC] key)
- 28 (⏏ Mouse right button)
- 29 POSITION button
- 30 AUTO button
- 31 PinP button
- 32 MAGNIFY buttons
- 33 FREEZE button
- 34 VOLUME button
- 35 MUTE button
- 36 ID CHANGE switch

Remote Control

Setting Up

Arrangement

⚠ WARNING • Before installation, make sure that the projector is turned off and the power cord is disconnected.

- Do not set up and move the projector, while it is hot.
- Install the projector in a suitable environment according to instructions of the “User’s Manual – Safety Guide” and this manual.
- The power outlet should be close to the projector and easily accessible.

Refer to the illustrations and tables below to determine the screen size and projection distance. The values shown in the table are calculated for a full size screen. ($\pm 10\%$)

Reference for the 4:3 aspect ratio

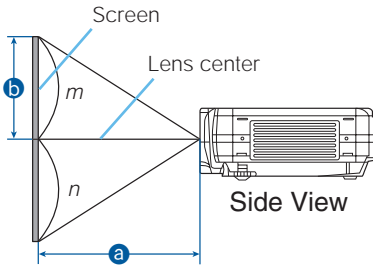

Screen Size [inch (m)]	a [inch (m)]		b [inch (cm)]	
	Min.	Max.	m:n=1:1	m:n=10:0
40 (1.0)	46(1.2)	71(1.8)	12(30)	24(61)
60 (1.5)	71(1.8)	107(2.7)	18(46)	36(91)
70 (1.8)	83(2.1)	126(3.2)	21(53)	42(107)
80 (2.0)	95(2.4)	144(3.7)	24(61)	48(122)
100 (2.5)	120(3.0)	181(4.6)	30(76)	60(152)
120 (3.0)	144(3.7)	217(5.5)	36(91)	72(183)
150 (3.8)	181(4.6)	272(6.9)	45(114)	90(229)
200 (5.1)	243(6.2)	364(9.2)	60(152)	120(305)
250 (6.4)	304(7.7)	455(11.6)	75(191)	150(381)
300 (7.6)	366(9.3)	547(13.9)	90(229)	180(457)
350 (8.9)	427(10.9)	638(16.2)	105(267)	210(533)
400 (10.2)	489(12.4)	730(18.5)	120(305)	240(610)
500 (12.7)	612(15.5)	913(23.2)	150(381)	300(762)

Reference for the 16:9 aspect ratio

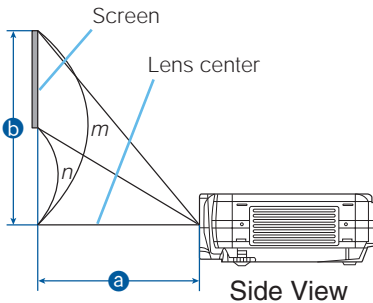

Screen Size [inch (m)]	a [inch (m)]		b [inch (cm)]	
	Min.	Max.	m:n=1:1	m:n=10:0
40 (1.0)	50(1.3)	77(2.0)	10(25)	23(58)
60 (1.5)	77(2.0)	117(3.0)	15(37)	34(87)
70 (1.8)	91(2.3)	137(3.5)	17(44)	40(102)
80 (2.0)	104(2.6)	157(4.0)	20(50)	46(116)
100 (2.5)	131(3.3)	197(5.0)	25(62)	57(145)
120 (3.0)	158(4.0)	237(6.0)	29(75)	69(174)
150 (3.8)	198(5.0)	297(7.5)	37(93)	86(218)
200 (5.1)	265(6.7)	396(10.1)	49(125)	114(291)
250 (6.4)	332(8.4)	496(12.6)	61(156)	143(363)
300 (7.6)	399(10.1)	596(15.1)	74(187)	172(436)
350 (8.9)	466(11.8)	696(17.7)	86(218)	200(508)
400 (10.2)	533(13.5)	795(20.2)	98(249)	229(581)
450 (11.4)	600(15.2)	895(22.7)	110(280)	257(654)

Setting Up (continued)

Adjusting The Projector's Elevator

- WARNING** • Do not touch about the lens and ventilation openings during use or immediately after use to prevent a burn.
- CAUTION** • To prevent damaging the projector and injuring yourself, always hold the projector whenever using the elevator buttons to adjust the elevator feet.

You can use the elevator feet to make adjustments if the surface on which you need to set the projector is uneven or if you otherwise need to adjust the angle of projection. The adjustment range of the elevator feet is 0 to 9 degrees.

- 1 Press and hold in the elevator buttons.
- 2 Raise or lower the projector to the desired height and then release the elevator buttons.
When you release the elevator buttons, the elevator feet will lock into position.
- 3 As necessary, you can also finely adjust the height of the projector by twisting the elevator feet by hand.

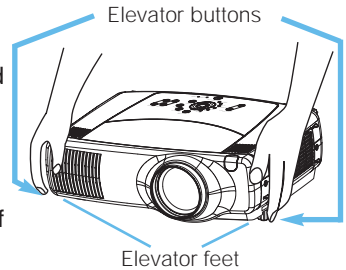

Using The Lens Shift Buttons

NOTE • Generally, better quality of a picture is available when the lens shift is set to the center.

The lens of this projector can be shifted vertically. When you want to finely adjust the picture position, use the LENS SHIFT buttons of the projector.

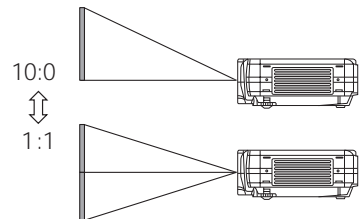
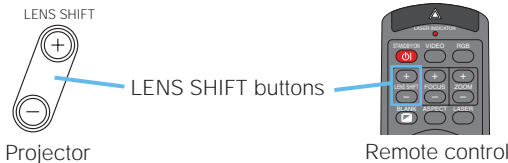

Setting Up (continued)

Connecting Your Devices

⚠ WARNING • Whenever attempting to connect other devices to the projector, read thoroughly the "User's Manual - Safety Guide", this manual and the manual of each device to be connected. Incorrect connecting could result in fire or electrical shock.

⚠ CAUTION • **TURN OFF ALL DEVICES** prior to connecting them to the projector. Attempting to connect a live device to the projector may generate extremely loud noises or other abnormalities that may result in malfunction and/or damage to the device and/or projector.

ATTENTION • Make sure that you connect devices to the correct port. Incorrect connection may result in malfunction and/or damage to the device and/or projector. Refer to the section "Technical" of this manual for the pin assignment of connectors and RS-232C communication data.

- Some cables have to be used with core set. Use the accessory cable or a designated-type cable for the connection. For cables that have a core only at one end, connect the core to the projector.
- Secure the screws on the connectors and tighten.
- Whenever attempting to connect a laptop computer to the projector, be sure to activate the laptop's RGB external image output (set the laptop to CRT display or to simultaneous LCD and CRT display). For details on how this is done, please refer to the instruction manual of the corresponding laptop computer.

NOTE • Some computers may have multiple display screen modes. Use of some of these modes may not be compatible with this projector.

- For some RGB input modes, the optional Mac adapter is necessary.
- When the image resolution is changed on a computer, depending on an input, automatic adjust function may take some time and may not be completed. In this case, you may not be able to see a check box to select "Yes/No" for the new resolution on Windows. Then the resolution will go back to the original. It might be recommended to use other CRT or TFT monitors to change the resolution.

NOTE Plug-and-Play Capability

- Plug-and-Play is a system incorporated in the computer, its operating system and peripheral equipment (i.e. display devices).
- This projector is compatible with VESA DDC 1/2B. Plug-and-Play can be achieved by connecting this projector to computers that are VESA DDC (display data channel) compatible.
- Please take advantage of this function by connecting the accessory RGB cable to the RGB port (DDC 1/2B compatible). Plug-and-Play may not work properly if any other type of connection is attempted.
- Please use the standard drivers in your computer as this projector is a Plug-and-Play monitor.

Setting Up (continued)

Please refer to the following (for example) for connecting your devices. See the rear of the projector. You can see the ports.

Examples of connection with a computer



Computer

Projector

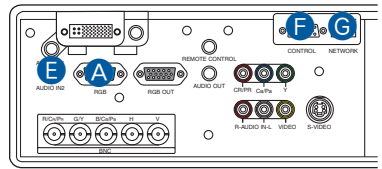
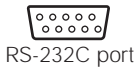

■ If using a M1-D input (to mouse control)

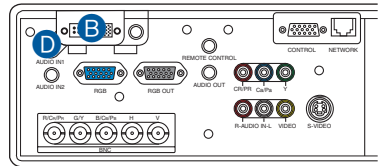
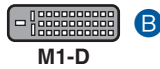

■ If using a BNC input

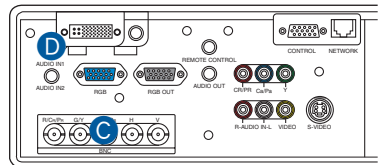
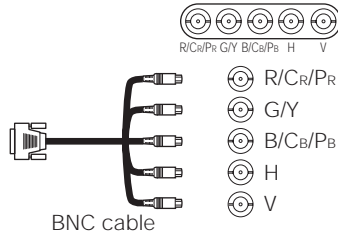

Setting Up (continued)

Examples of connection with a VCR/DVD Player



VCR/DVD Player

Projector



H
I

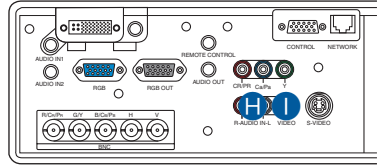

■ If using a s-video signal

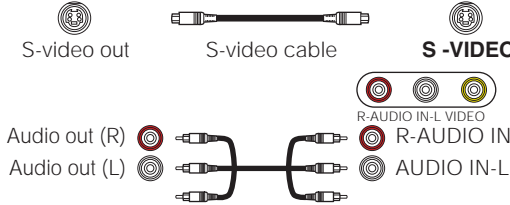

J
H

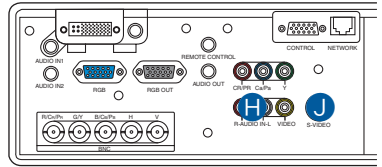

■ If using a component signal

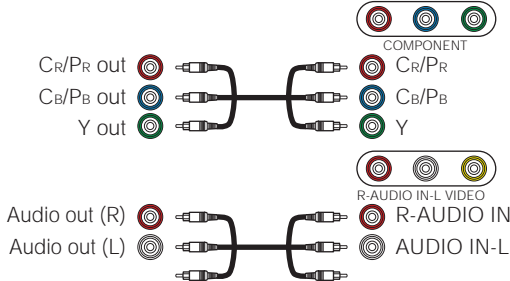

K
H

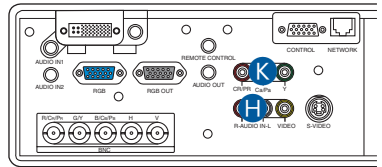

■ If using a SCART RGB input

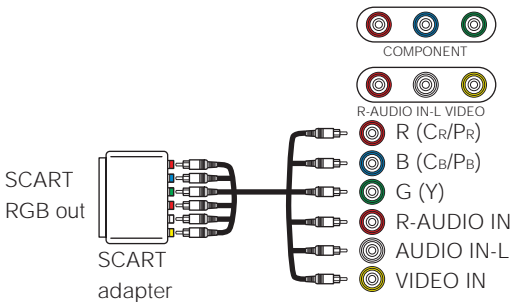

K
H
I

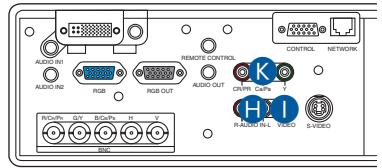

Setting Up (continued)

Connecting to a monitor



Monitor



RGB in



RGB cable

Projector



RGB OUT

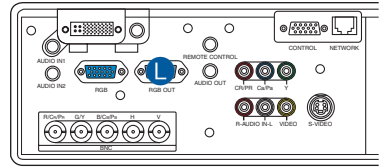

Connecting to a speaker (with amplifier)



Speaker



Audio in



Stereo Mini cable

Projector



AUDIO OUT

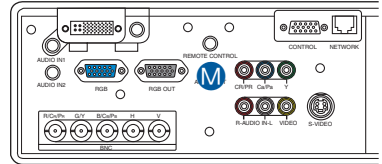

Connecting The Power Supply

WARNING • Use extra caution when connecting the power cord as incorrect or faulty connections may result in fire and/or electrical shock. Please adhere to the "User's manual – Safety Guide" and the following.

- Only plug the power cord into outlets rated for use with the power cord's specified voltage range.
- Only use the power cord that came with the projector. If it is damaged, contact your dealer to newly get correct one.
- Never modify the power cord. Never attempt to defeat the ground connection of the three-pronged plug.
- Make sure that you firmly connect the power cord to the projector and wall outlet.

1 Connect the connector of the power cord to the AC inlet of the projector.

2 Firmly plug the power cord's plug into the outlet.

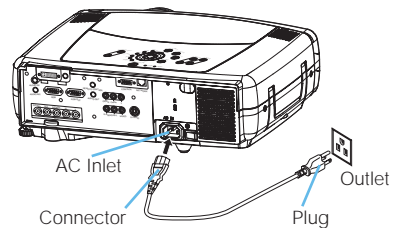

Remote Control (continued)

Operating The Remote Control



CAUTION • Do not disassemble the remote control.

- Do not place the remote control near the projector's lens, fan, or vents.
- Do not drop or otherwise expose the remote control to physical impact.
- Do not get the remote control wet or place it on wet objects on it. Doing so may result in malfunction.
- Remove the batteries from the remote control and store them in a safe place if you won't be using the remote control for an extended period.

NOTE

- Replace the batteries whenever the remote control starts to malfunction.
- When strong light, such as direct sunlight or light from an extremely close range (such as from an inverter fluorescent lamp), hits the projector's remote sensor, the remote control may cease to function. Adjust the direction of the projector to keep light from directly hitting the projector's remote sensor.

- The remote control works with the projector's remote sensor.
- **Front remote sensor** is 3 meters with a 60 degree range (30 degrees to the left and right of a remote sensor).

Rear remote sensor is 3 meters with a 40 degree range (20 degrees to the left and right of a remote sensor).

- Also a remote signal reflected in the screen etc.

may be available. If it is difficult to send a remote signal to the sensor directly, please try.

- Since the remote control uses infrared light to send signals to the projector (Class1 LED), be sure to use the remote control in an area free from obstacles that could block the remote control's output signal to the projector.

memo You can use the remote control as a wired remote control, by connecting the REMOTE CONTROL ports of the main unit and remote control via an audio cable (3.5 dia. stereo mini cable with plugs).

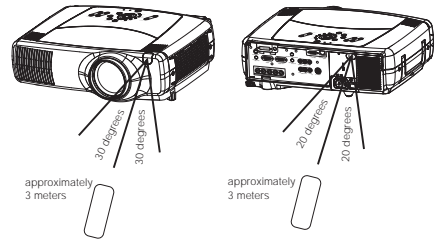

Using The Remote ID Feature

This is the function to properly use when you use two or three same type projectors at the same time. This function should be used combining a setup of a projector.

- 1** Set the ID number to the projector beforehand, referring to the item "IR REMOTE ID" of the section "OPTION Menu".

memo When the ALL is selected to the item "IR REMOTE ID" of the OPTION menu, the projector is controlled by a remote control irrespective of the position of the ID CHANGE switch.

- 2** Slide the knob of the switch into the position of the ID number of the projector you want to control.

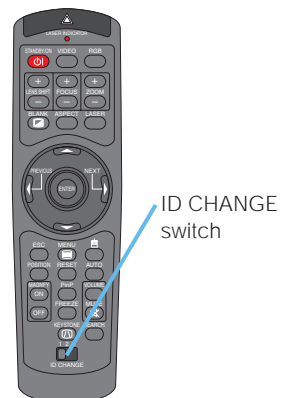

Remote Control (continued)

Using The Mouse/Keyboard Control Function

⚠ CAUTION • Before connecting, read the manuals of the device you will connect. Mistaken use of the mouse/keyboard control could damage your equipment.

- Only connect to a PC.
- Do not unplug the connector cables while the computer is operating.

Using the USB control feature, you can use the remote control as a simplified mouse or keyboard of the computer.

Connect the M1-D port of the projector to the computer via the M1-D cable. Then functions illustrated below will be enabled.

memo The USB control can be used with Windows 95 OSR 2.1 or higher. It may not be possible to use the remote control, depending on the computer's configurations and mouse drivers.

memo The function can be used only for the functions illustrated on the right.

memo The projector would be enumerated as a mouse and a keyboard of HID (Human Interface Device) class devices, after connecting cable.

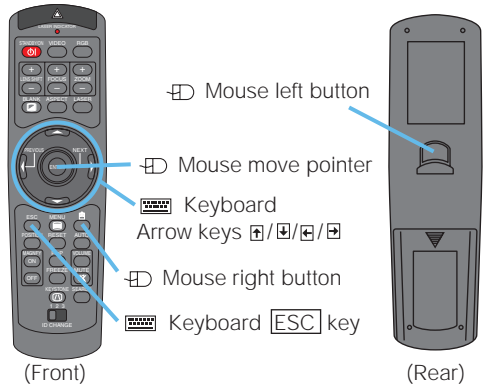

Power ON/OFF

WARNING • When the power is ON, a strong light is emitted. Do not look into the lens or vents of the projector.

NOTE • Turn the power on/off in right order. Please power on the projector before the connected devices. Power off the projector after the connected devices.

Turning On The Power

- 1 Remove the lens cap.
- 2 Set the power switch to [I] (ON).
The STANDBY/ON indicator will light to solid orange.
- 3 Press the STANDBY/ON button.
The projector lamp will light up and the STANDBY/ON indicator will begin blinking green. When the power is completely on, the indicator will stop blinking and light green.
- 4 Use the LENS SHIFT buttons to shift the picture upward or downward.
- 5 Select an input signal according to the section “Selecting An Input Signal” of the following page.

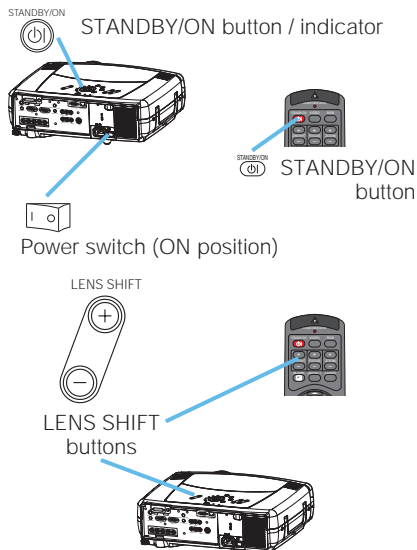

Turning Off The Power

- 1 Press the STANDBY/ON button.
The message “Power off?” will appear on the screen for approximately 5 seconds.
- 2 Press the STANDBY/ON button again while “Power off?” the message is visible.
The projector lamp will go off, and the STANDBY/ON indicator will begin blanking orange. Then the STANDBY/ON indicator will stop blinking and light to solid orange when the lamp cooling is complete.
- 3 Switch the power switch to [O] (OFF).
The STANDBY/ON indicator will go off.
- 4 Attached the lens cap.

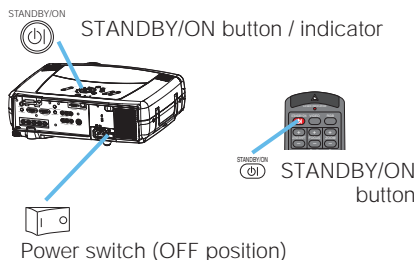

Operating

Selecting An Input Signal

1 Select an input signal.

■ Using the INPUT dial

Turn the INPUT dial of the projector. Turning the dial cycles through the input ports as shown below. Select the signal you wish to project.

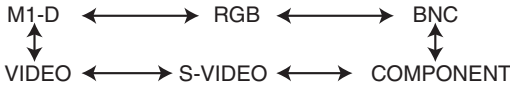

■ Using SEARCH button

Press the SEARCH button of the projector or the remote control. Pressing the button automatically cycles through input ports and displays the picture of retrieved signal.

memo If no signal is found or the projector is unstable to find an input signal at any of its ports, it will turn to the state it was in prior to the search.



■ Using RGB button

Press the RGB button of the remote control. Pressing the button toggles between the RGB ports as shown below. Select the signal you wish to project.



■ Using VIDEO button

Press the VIDEO button of the remote control. Pressing the button toggles between the VIDEO ports as shown below. Select the signal you wish to project.

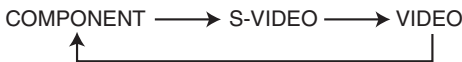

2 Use the ZOOM buttons to adjust the screen size.

3 Use the FOCUS buttons to adjust the focus.

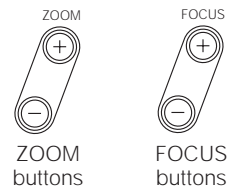
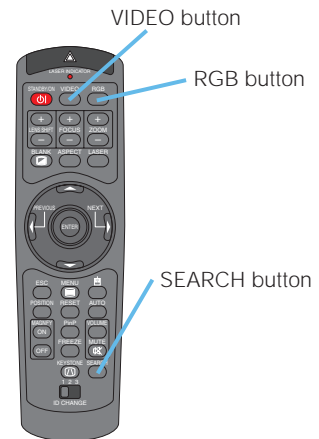
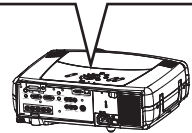
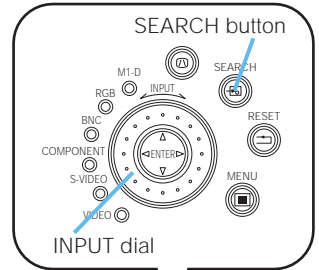

Operating (continued)

Selecting The Aspect Ratio

- 1 Press the Aspect button to toggle between the modes for aspect ratio.

■ At a M1-D signal

NORMAL ↔ 4:3 ↔ 16:9

memo NORMAL keeps the original aspect ratio of the input signal.

■ At a RGB signal (not M1-D)

4:3 ↔ 16:9

■ At a video signal

4:3 ↔ 16:9 ↔ SMALL

memo At a HDTV signal of 1125i or 750p, only 16:9 can be selected.



ASPECT button

Using The Automatic Adjustment Feature

memo The automatic adjustment operation requires approximately 10 seconds. Also, please note that it may not function correctly with some input.

- 1 Press the AUTO button.

■ At a RGB signal

The Vertical position (V POSITION), the horizontal position (H POSITION), the clock phase (H PHASE) and horizontal size (H SIZE) will be automatically adjusted.

memo Make sure that the application window is set to its maximum size prior to attempting to use this feature. Dark pictures may still be incorrectly adjusted. Use a bright screen when adjusting.

■ At a video signal

The signal type mode best suited for the respective input signal will be selected automatically.

memo This function is available only when the AUTO is selected to the item VIDEO of the INPUT menu. For a component video signal, the signal type is identified automatically independently of this function.



AUTO button

Operating (continued)

Adjusting The Picture Position

memo This function is available only for RGB signals.

- 1 Press the POSITION button.
As illustrated on the right, a dialog will appear on the screen to aid you in adjusting the position.



- 2 Use the cursor buttons ▲/▼/◀/▶ to adjust the position.

memo When you want to initialize the position, press the RESET button during adjustment.

- 3 Press the POSITION button again to close the dialog and complete this operation.

memo Even if you don't do anything, the dialog will automatically disappear after a few seconds.



Cursor buttons

POSITION button

RESET button

Correcting The Keystone Distortion

- 1 Press the KEYSTONE button.
As illustrated on the right, a dialog will appear on the screen to aid you in correcting the keystone distortion.

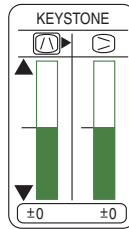

- 2 Use the cursor buttons ◀/▶ to select the direction of distortion to correct (◀ or ▶).

- 3 Use the cursor buttons ▲/▼ to correct the distortion.

- 4 Press the KEYSTONE button again to close the dialog and complete this operation.

memo Even if you don't do anything, the dialog will automatically disappear after a few seconds.

memo When this adjustment is excessive, certain degradation may appear on the picture. Also, please note that it may not function correctly with some input.



Cursor buttons

KEYSTONE button

Operating (continued)

Adjusting The Volume

- 1 Press the VOLUME button.
As illustrated on the right, a dialog will appear on the screen to aid you in adjusting the volume.
- 2 Use the cursor buttons ▲/▼ to adjust the volume.
- 3 Press the VOLUME button again to close the dialog and complete this operation.

memo Even if you don't do anything, the dialog will automatically disappear after a few seconds.

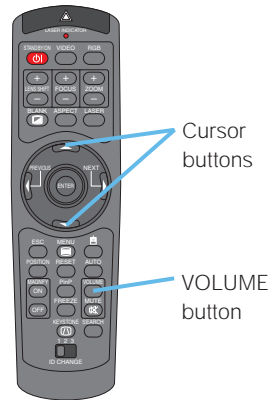
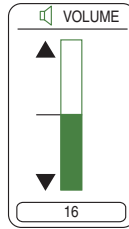

Cursor buttons

VOLUME button

Muting The Sound

- 1 Press the MUTE button.
As illustrated on the right, a dialog will appear on the screen indicating that you have muted the sound.
- 2 Press the MUTE or VOLUME button to restore the sound.

memo Even if you don't do anything, the dialog will automatically disappear after a few seconds.

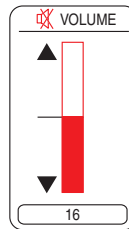

MUTE button

Temporarily Blanking The Screen

- 1 Press the BLANK button.
The input signal screen will shut off, and a BLANK screen will appear.
- memo** You can set the BLANK screen using the menu. Please refer to the item "BLANK" of the table of the section "SCREEN Menu".
- 2 Press the BLANK button again to remove the blank screen, and return to the input signal screen.

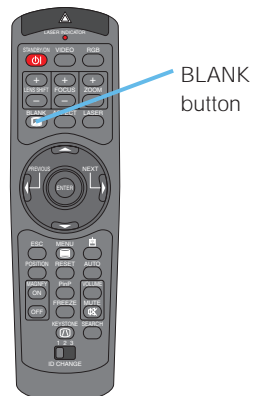

BLANK button

Operating (continued)

Freezing The Screen

- 1 Press the FREEZE button.
As illustrated on the right, a dialog will appear on the screen, and the screen will freeze at the current image.



- 2 Press the FREEZE button again to restore the screen to normal.
The icon "II" will change to the icon "▶". And after a couple of seconds, the dialog will be closed and the screen will be restored to normal.

memo The freezing feature will automatically finish if a remote control's button that changes some display state (ex. blanking the screen, displaying a dialog or a menu, adjusting the picture, changing the input signal) is pressed, or a button of projector is pressed.



FREEZE button

NOTE • If the projector continues projecting the same image for a long time (i.e. you forget to exit FREEZE mode), the image might possibly remain as an afterimage. Do not leave the projector in FREEZE mode for too long.

Using The Magnify Feature

- 1 Press the MAGNIFY **ON** button.
As illustrated on the right, a dialog will appear on the screen to aid you in magnifying the picture.



- 2 Press the POSITION button, then use the cursor buttons ▲/▼/◀/▶ to select the area to zoom.

- 3 Press the POSITION button again to finalize the zoom area.

- 4 Use the cursor buttons ▲/▼ to adjust the zoom level.

- 5 Press the MAGNIFY **OFF** button again to close the dialog and complete this operation.

memo The magnify feature will automatically finish if the automatic adjustment is executed, or the aspect, the signal type mode of video or the signal input state is changed.



Cursor buttons

POSITION button

MAGNIFY buttons

Operating (continued)

Displaying The Child Window

memo This feature called "PinP (Picture in Picture)" is available only when a RGB signal is selected to main screen.

- 1 Press the PinP button.
The child window with a picture of a video signal will appear.

- 2 Press the PinP button again to change the size of the child window or close the window.

Small child window → Large child window
↑ No child window ↓

memo You can select the video signal to display in the child window, and the position of the child window. Please refer to the items "P.INP. INPUT" and "P.INP. POSIT." of the table of the section "INPUT Menu".



PinP button

Selecting An Audio Input

memo This feature is available only when the child window is on the screen.

- 1 When the child window is on the screen, press the VOLUME button.
As illustrated on the right, a dialog will appear on the screen.

- 2 Use the cursor buttons ◀/▶ to select an audio input.

RGB (Audio input for the main screen)



Video (Audio input for the child window)

memo You also can adjust the volume using the cursor buttons ◀/▶. Please refer to the section "Adjusting The Volume".

- 3 Press the VOLUME button again to close the dialog and complete this operation.

memo Even if you don't do anything, the dialog will automatically disappear after a few seconds.

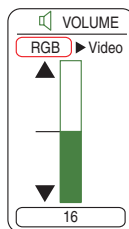

Cursor buttons

VOLUME button

Multifunctional Settings

Using The Menu Functions

This projector has the following menus: MAIN, PICTURE-1, PICTURE-2, INPUT, AUTO, SCREEN, OPTION and NETWORK. Each of these menus is operated using the same methods. The basic operations of these menus are as follows.

- 1 Press the MENU button.
The menu will appear on the screen.

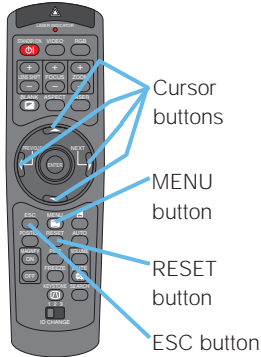

- 2 Use the cursor buttons ▲/▼ to select a menu, then press the ► (or the ENTER) button to progress.
The display of the selected menu will appear.

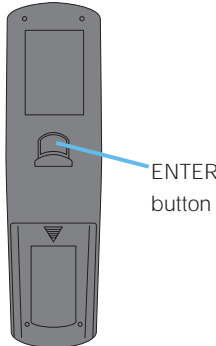

- 3 Use the cursor buttons ▲/▼ to select an item, then press the ► (or the ENTER) button to progress.
The operation display of the selected item will appear.

- 4 Use the cursor buttons ▲/▼ to operate the item.

memo When you want to reset the adjustment, press the RESET button during the operation. Note that the items whose functions are performed simultaneously with operating (ex. LANGUAGE, WHISPER, H PHASE etc.) are not reset.

memo When you want to return to the previous display, press the ◀ or ESC button.

- 5 Press the MENU button again to close the menu display and complete this operation.

memo Even if you don't do anything, the menu will automatically disappear after a few seconds

ex. Turning off the built-in speaker

- 1) Press the MENU button.

MENU	BRIGHT	➔0
MAIN	CONTRAST	➔0
PICTURE-1	ASPECT	4:3
PICTURE-2		
INPUT	WHISPER	NORMAL
AUTO	MIRROR	NORMAL
SCREEN	LANGUAGE	ENGLISH
OPTION	[Language]	
NETWORK	RESET	
[◀] SELECT		

- 2) Select the "OPTION" using the ▼ button, then press the ► button.

MENU	VOLUME	➔16
MAIN	SPEAKER	TURN ON
PICTURE-1	IR REMOTE	ALL
PICTURE-2	IR REMOTE ID	ALL
INPUT	LAMP TIME	1234 h
AUTO	FILTER TIME	4321 h
SCREEN	SERVICE	
OPTION	RESET	
NETWORK		
[◀] SELECT		

- 3) Select the "SPEAKER" using the ▼ button, then press the ► button.

MENU	VOLUME	➔16
MAIN	SPEAKER	TURN ON
PICTURE-1	IR REMOTE	ALL
PICTURE-2	IR REMOTE ID	ALL
INPUT	LAMP TIME	1234 h
AUTO	FILTER TIME	4321 h
SCREEN	SERVICE	
OPTION	RESET	
NETWORK		
[◀] SELECT		

- 4) Use the cursor button ▼ to select the "TURN OFF".

◀ OPTION
SPEAKER
TURN OFF
TURN ON

- 5) Press the MENU button.

Multifunctional Settings (continued)

MAIN Menu

With the MAIN menu, the items shown in the table below can be performed. Perform each operation in accordance with the instructions in the table below.

MENU		
MAIN	BRIGHT	+0
PICTURE-1	CONTRAST	+0
PICTURE-2	ASPECT	4:3
INPUT	WHISPER	NORMAL
AUTO	MIRROR	NORMAL
SCREEN	LANGUAGE	ENGLISH
OPTION	[Language]	
NETWORK	RESET	
[OK]: SELECT		

Item	Description
BRIGHT	Adjust the brightness using the ▲ / ▼ buttons. : Light ⇔ Dark
CONTRAST	Adjust the contrast using the ▲ / ▼ buttons. : Strong ⇔ Weak
ASPECT	Select an aspect ratio using the ▲ / ▼ buttons. : ■ At a M1-D signal NORMAL ⇔ 4:3 ⇔ 16:9 The NORMAL keeps the original aspect ratio of the input signal. ■ At a RGB signal (not M1-D) 4:3 ⇔ 16:9 ■ At a video signal 4:3 ⇔ 16:9 ⇔ SMALL <i>memo</i> At a HDTV signal of 1125i or 750p, only the 16:9 can be selected.
WHISPER	Select the NORMAL or the WHISPER using the ▲ / ▼ buttons. : NORMAL ⇔ WHISPER When the WHISPER is selected, acoustic noise and screen brightness are reduced.
MIRROR	Select a mirror status using the ▲ / ▼ buttons. : NORMAL ⇔ H:INVERT ⇔ V:INVERT ⇔ H&V:INVERT ex. 
LANGUAGE	Select a menu language using the ▲ / ▼ buttons. : ENGLISH ⇔ FRANÇAIS ⇔ DEUTSCH ⇔ ESPAÑOL ⇔ ITALIANO NORSK ⇔ NEDERLANDS ⇔ 日本語 ⇔ PORTUGUÊS ⇔ 中文 한글 ⇔ SVENSKA ⇔ РУССКИЙ ⇔ SUOMI ⇔ POLSKI
RESET	Select the EXECUTE using the ▲ button to reset the MAIN menu items. : EXECUTE ⇔ CANCEL The items of the MAIN menu are collectively returned to the initial setting. Note that the items "WHISPER" and "LANGUAGE" are not reset.

Multifunctional Settings (continued)

PICTURE-1 Menu

With the PICTURE-1 menu, the items shown in the table below can be performed. Perform each operation in accordance with the instructions in the table below.

MENU ▲		
MAIN	GAMMA	NORMAL
PICTURE-1	COLOR BAL R	+0
PICTURE-2	COLOR BAL G	+0
INPUT	COLOR BAL B	+0
AUTO	SHARPNESS	+0
SCREEN	COLOR	+0
OPTION	TINT	+0
NETWORK	MY MEMORY	LOAD1
[C]:SELECT ▼		

Item	Description	
GAMMA	Select a gamma mode using the ▲ / ▼ buttons. : NORMAL ⇄ CINEMA ⇄ DYNAMIC ⇄ CUSTOM Selecting the CUSTOM and then pressing the ► (or the ENTER) button calls the CUSTOM menu. CUSTOM Menu Select an item using the ▲ / ▼ buttons, and press the ► (or the ENTER) button to perform each function. GAMMA ⇄ COLOR TEMP ⇄ R ⇄ G ⇄ B <i>memo</i> The R, G and B can be selected only when the USER is selected under the COLOR TEMP.	
	GAMMA	Adjust the gamma data using the ▲ / ▼ buttons. : Up ⇄ Down
	COLOR TEMP	Select a color temperature using the ▲ / ▼ buttons. : HIGH ⇄ MIDDLE ⇄ LOW ⇄ USER
	R	Adjust the red color level for the USER mode of the COLOR TEMP using the ▲ / ▼ buttons. : Strong ⇄ Weak
	G	Adjust the green color level for the USER mode of the COLOR TEMP using the ▲ / ▼ buttons. : Strong ⇄ Weak
	B	Adjust the blue color level for the USER mode of the COLOR TEMP using the ▲ / ▼ buttons. : Strong ⇄ Weak
COLOR BAL R	Adjust the red color balance using the ▲ / ▼ buttons. : Strong ⇄ Weak	
COLOR BAL G	Adjust the green color balance using the ▲ / ▼ buttons. : Strong ⇄ Weak	
COLOR BAL B	Adjust the blue color balance using the ▲ / ▼ buttons. : Strong ⇄ Weak	
SHARPNESS	Adjust the sharpness using the ▲ / ▼ buttons. : Clear ⇄ Soft <i>memo</i> This item can be selected only at a video signal.	
COLOR	Adjust the whole color using the ▲ / ▼ buttons. : Strong ⇄ Weak <i>memo</i> This item can be selected only at a video signal.	
TINT	Adjust the tint using the ▲ / ▼ buttons. : Green ⇄ Red <i>memo</i> This item can be selected only at a video signal.	

(This table is continued to the following page.)

Multifunctional Settings (continued)

PICTURE-2 Menu

MENU	
MAIN	V POSITION 20
PICTURE-1	H POSITION 142
PICTURE-2	H PHASE 31
INPUT	H SIZE 1344
AUTO	OVER SCAN 95
SCREEN	RESET
OPTION	
NETWORK	
[C]: SELECT	

With the PICTURE-2 menu, the items shown in the table below can be performed. Perform each operation in accordance with the instructions in the table below.

memo This menu cannot be selected at a M1-D signal.

Item	Description
V POSITION	Adjust the vertical position using the ▲ / ▼ buttons. : Up ⇄ Down memo This item can be selected only at a RGB signal.
H POSITION	Adjust the horizontal position using the ▲ / ▼ buttons. : Left ⇄ Right memo This item can be selected only at a RGB signal.
V POSITION	Adjust the horizontal phase to eliminate flicker using the ▲ / ▼ buttons. : Right ⇄ Left memo This item can be selected only at a RGB signal or a component video signal other than a COMPONENT port input of 525i/625i/SCART RGB.
H SIZE	Adjust the horizontal size using the ▲ / ▼ buttons. : Large ⇄ Small memo This item can be selected only at a RGB signal. memo When this adjustment is excessive, the picture may not be displayed correctly. In such a case, please reset the adjustment pressing the RESET button during this operation.
OVER SCAN	Adjust the over-scan ratio using the ▲ / ▼ buttons. : Small ⇄ Large memo This item can be selected only at a video signal. memo When this adjustment is too large, certain degradation may appear at the frame area of the picture. In such a case, please adjust small.
RESET	Select the EXECUTE using the ▲ button to reset the PICTURE-2 menu items. : EXECUTE ⇄ CANCEL The items of the PICTURE-2 menu are collectively returned to the initial setting. Note that the item "H PHASE" is not reset.

Multifunctional Settings (continued)

INPUT Menu

With the INPUT menu, the items shown in the table below can be performed. Perform each operation in accordance with the instructions in the table below.

MENU		
MAIN	COLOR SPACE	AUTO
PICTURE-1	COMPONENT	COMPONENT
PICTURE-2	VIDEO	AUTO
INPUT	3D-YCS	TURN OFF
AUTO	VIDEO NR	LOW
SCREEN	P. INP. INPUT	VIDEO
OPTION	P. INP. POSIT.	[]
NETWORK	POWERUP INPUT	RGB
[]: SELECT		

Item	Description
COLOR SPACE	<p>Select a color space mode using the ▲ / ▼ buttons. : AUTO ⇄ RGB ⇄ SMPTE240 ⇄ REC709 ⇄ REC601</p> <p>Selecting the AUTO automatically selects the optimum mode.</p> <p>memo This item can be selected only at a RGB signal or a component video signal other than a COMPONENT port input of 525i/625i/SCART RGB.</p> <p>memo The AUTO operation may not work well at some signals. In such a case, select the SMPTE240 or the REC709 for a HDTV signal.</p>
COMPONENT	<p>Select a function of COMPONENT port using the ▲ / ▼ buttons. : COMPONENT ⇄ SCART RGB</p> <p>When the SCART RGB is selected, the COMPONENT port function as a port for a SCART RGB signal input. Please refer to the section "Connecting Your Devices".</p>
VIDEO	<p>Select a signal type mode using the ▲ / ▼ buttons. : AUTO ⇄ NTSC ⇄ PAL ⇄ SECAM ⇄ NTSC4.43 ⇄ M-PAL ⇄ N-PAL</p> <p>Selecting the AUTO automatically selects the optimum mode.</p> <p>memo This item is performs only at a video signal from the VIDEO port or the S-VIDEO port. For a component video signal, the signal type is identified automatically independently of this function.</p> <p>memo The AUTO operation may not work well at some signals. If the picture becomes unstable (ex. a irregular picture, a color lack), please select the mode depending on the input signal.</p>
3D-YCS	<p>Select the TURN ON or the TURN OFF using the ▲ / ▼ buttons. : TURN ON ⇄ TURN OFF</p> <p>When the TURN ON is selected, the 3D-YCS mode works for a completely still image, or images with few motions.</p> <p>memo This item performs only at a video signal of NTSC3.58.</p> <p>memo When this function performs, the setting of the item "VIDEO NR" of this INPUT menu is not effective.</p>
VIDEO NR	<p>Select a noise reduction level using the ▲ / ▼ buttons. : HIGH ⇄ MIDDLE ⇄ LOW</p> <p>The noise on screen is reduced according to the selected level.</p> <p>memo This item performs only at a video signal from the VIDEO port or the S-VIDEO port. At a video signal of NTSC3.58, this function performs only when the TURN OFF is selected to the item "3D-YCS" of this INPUT menu.</p> <p>memo When this adjustment is excessive, certain degradation may appear on the picture.</p>

(This table is continued to the following page.)

Multifunctional Settings (continued)

INPUT Menu (continued)



Item	Description
P.IN P. INPUT	Select a signal input port for the child window using the ▲ / ▼ buttons. : VIDEO ⇄ S-VIDEO <i>memo</i> About the child window, please refer to the section "Displaying the Child Window".
P.IN P. POSIT.	Select the display position of the child window using the ▲ / ▼ buttons. :  <i>memo</i> About the child window, please refer to the section "Displaying the Child Window".
POWERUP INPUT	Select a signal input port to display just when the projector is turned on, using the ▲ / ▼ buttons. : LAST INPUT ⇄ M1-D ⇄ RGB ⇄ BNC ⇄ COMPONENT ⇄ S-VIDEO ⇄ VIDEO Selecting the LAST INPUT selects the port that was used at the last time.
INFORMATION	Pressing the ► (or the ENTER) button displays the INPUT INFORMATION menu. The INPUT INFORMATION menu shows the information about the current signal input as illustrated below. <div style="display: flex; justify-content: space-around; margin: 10px 0;"> <div style="border: 1px solid black; padding: 5px; text-align: center;"> ◀ INPUT-INFORMATION RGB 1024x768 @60.0 FRAME LOCK </div> <div style="border: 1px solid black; padding: 5px; text-align: center;"> ◀ INPUT-INFORMATION S-VIDEO SECAM AUTO </div> <div style="border: 1px solid black; padding: 5px; text-align: center;"> ◀ INPUT-INFORMATION COMPONENT 575i @50 SCART RGB </div> </div> <i>memo</i> The "FRAME LOCK" message means the frame lock function is working. This function automatically works when a RGB signal with vertical frequency of 50 to 60 is input, and it displays a moving picture more smoothly. <i>memo</i> The "SCART RGB" message means the COMPONENT port is working as a SCART RGB port. Please refer to the item "COMPONENT" in this table.
S2-ASPECT	Select the TURN ON or the TURN OFF using the ▲ / ▼ buttons. : TURN ON ⇄ TURN OFF When the TURN ON is selected, an S2-video signal can be identified and the optimum aspect ratio is automatically selected. <i>memo</i> This item is performs only at a S-VIDEO signal. <i>memo</i> When the ASPECT button is used or the item "ASPECT" of the MAIN menu is operated, the TURN OFF will be automatically selected to this item.
RESET	Select the EXECUTE using the ▲ button to reset the INPUT menu items. : EXECUTE ⇄ CANCEL The items of the INPUT menu are collectively returned to the initial setting. Note that the item "INFORMATION" is not reset.

Multifunctional Settings (continued)

AUTO Menu

With the AUTO menu, the items shown in the table below can be performed. Perform each operation in accordance with the instructions in the table below.

MENU		
MAIN	ADJUST	
PICTURE-1	POWER OFF	0 min
PICTURE-2	POWER ON	TURN ON
INPUT	SEARCH	TURN ON
AUTO	RESET	
SCREEN		
OPTION		
NETWORK		
[OK]: SELECT		

Item	Description
ADJUST	<p>Pressing the ▶ (or the ENTER) button performs the automatic adjustment.</p> <ul style="list-style-type: none"> ■ At a RGB signal The vertical position (V POSITION), the horizontal position (H POSITION), the clock phase (H PHASE) and the horizontal size (H SIZE) will be automatically adjusted. memo Make sure that the application window is set to its maximum size prior to attempting to use this feature. Dark pictures may still be incorrectly adjusted. Use a bright screen when adjusting. ■ At a video signal The signal type mode best suited for the respective input signal will be selected automatically. memo This function is available only when the AUTO is selected to the item "VIDEO" of the INPUT menu. For a component video signal, the signal type is identified automatically independently of this function. memo This operation requires approximately 10 seconds, and the message "AUTO IN PROGRESS" is displayed during the operation. memo This operation may not work well at some signals. If the picture becomes unstable (ex. a irregular picture, a color lack), please select the suitable mode to the item "VIDEO" of the INPUT menu.
POWER OFF	<p>Set the time using the ▲ / ▼ buttons. :</p> <p>Long (max. 99 minutes) ⇔ Short (min. 0 minute = DISABLE)</p> <div style="display: flex; justify-content: space-around; align-items: center;"> <div style="text-align: center;">  <p>ex.</p> </div> <div style="text-align: center;">  </div> </div> <p>When the time is set to 1 to 99, the projector lamp will go off and the STANDBY/ON indicator begins blinking when the passed time with a proper signal (without no-signal and an unsuitable signal) reaches at the set time. Please refer to the section "Turning Off The Power".</p>
POWER ON	<p>Select the TURN ON or the TURN OFF using the ▲ / ▼ buttons.:</p> <p>TURN ON ⇔ TURN OFF</p> <p>When the TURN ON is selected, you can turn the projector on without pressing the STANDBY/ON button. Please refer to the section "Turning Off The Power".</p>

(This table is continued to the following page.)

Multifunctional Settings (continued)

AUTO Menu (continued)

Item	Description
SEARCH	<p>Select the TURN ON or the TURN OFF using the ▲ / ▼ buttons. : TURN ON ⇔ TURN OFF</p> <p>When the TURN ON is selected, detecting no signal cycles through input ports and displays the picture of retrieved signal.</p> <pre> M1-D → RGB → BNC ↑ ↓ VIDEO ← S-VIDEO ← COMPONENT </pre> <p>memo When the TURN ON is selected, pressing the RGB button selects the M1-D ports, and pressing the VIDEO button selects the COMPONENT port.</p> <p>memo If no signal is found or the projector is unstable to find an input signal at any of its ports, it will return to the state it was in prior to the search.</p>
RESET	<p>Select the EXECUTE using the ▲ button to reset the AUTO menu items. : EXECUTE ⇔ CANCEL</p> <p>The items of the AUTO menu are collectively returned to the initial setting. Note that the item "ADJUST" is not reset.</p>

Multifunctional Settings (continued)

SCREEN Menu

With the SCREEN menu, the items shown in the table below can be performed. Perform each operation in accordance with the instructions in the table below.

MENU		
MAIN	BLANK	BLACK
PICTURE-1	START UP	ORIGINAL
PICTURE-2	MyScreen	
INPUT	MyScreen SIZE	x1
AUTO	MyScreen LOCK	TURN OFF
SCREEN	MENU POSITION	
OPTION	MESSAGE	TURN ON
NETWORK	RESET	
[F4]: SELECT		

Item	Description
BLANK	<p>Select a type of the BLANK screen using the ▲ / ▼ buttons. : MyScreen ⇄ ORIGINAL ⇄ BLUE ⇄ WHITE ⇄ BLACK</p> <p>The BLANK screen is the screen, which is displayed by pressing the BLANK button. The MyScreen is the screen you can register a desired screen, and the ORIGINAL is the existing standard screen. The BLUE, the WHITE and the BLACK are the non-pattered (plain) screens in each color.</p> <p>memo To avoid remaining as an afterimage, the MyScreen and the ORIGINAL screens will change to the BLACK screen after several minutes.</p> <p>memo For the MyScreen, please refer to the item "MyScreen" in this table.</p>
START UP	<p>Select a type of the START UP screen using the ▲ / ▼ buttons. : MyScreen ⇄ ORIGINAL ⇄ TURN OFF</p> <p>The START UP screen is the screen, which is displayed by detecting no signal or an unsuitable signal.</p> <p>The MyScreen is the screen you can register a desired screen, and the ORIGINAL is the existing standard screen. When the TURN OFF is selected, the BLUE is used.</p> <p>memo To avoid remaining as an afterimage, the MyScreen and the ORIGINAL screens will change to the BLANK after several minutes. If also the BLANK screen is the MyScreen or the ORIGINAL, it will change to the BLACK screen.</p> <p>memo About the MyScreen, please refer to the item "MyScreen" in this table. About the BLUE, BLACK and BLANK screens, please refer to the item "BLANK" in this table.</p>
MyScreen	<p>Pressing the ► (or the ENTER) button starts the MyScreen registration. Please see the flow chart on the following page.</p>
MyScreen SIZE	<p>Select the size of the MyScreen using the ▲ / ▼ buttons. : x1 ⇄ FULL</p>
MyScreen LOCK	<p>Select the TURN ON or the TURN OFF using the ▲ / ▼ buttons.: TURN ON ⇄ TURN OFF</p> <p>The TURN ON disables the operation of the item "MyScreen" of this SCREEN menu.</p>
MENU POSITION	<p>After pressing the ► (or ENTER) button, adjust the menu position using the ▲ / ▼ / ◀ / ▶ buttons.:</p> <p style="text-align: center;">Up ↑ Left ⇄ + ⇄ Right ↓ Down</p> <p>memo To finish this operation, press the ESC button but not the ◀ button.</p>

(This table is continued to the following page.)

Multifunctional Settings (continued)

SCREEN Menu (continued)

Item	Description
MESSAGE	<p>Select the TURN ON or the TURN OFF using the ▲ / ▼ buttons. : TURN ON ⇔ TURN OFF</p> <p>When the TURN ON is selected, the following message function works.</p> <p>The message of the "AUTO IN PROGRESS" for the auto adjustment.</p> <p>The message of the "NO INPUT IS DETECTED"</p> <p>The message of the "SYNC IS OUT OF RANGE"</p> <p>The message of the "Searching ..."</p> <p>The message of the "Detecting ..."</p> <p>The indication of the input signal by input change.</p> <p>The indication of the aspect ratio by changing the aspect ratio.</p> <p>The indication of "FOCUS" by adjusting the focus.</p>
RESET	<p>Select the EXECUTE using the ▲ button to reset the SCREEN menu items. : EXECUTE ⇔ CANCEL</p> <p>The items of the SCREEN menu are collectively returned to the initial setting.</p>

How to register your picture as the MyScreen

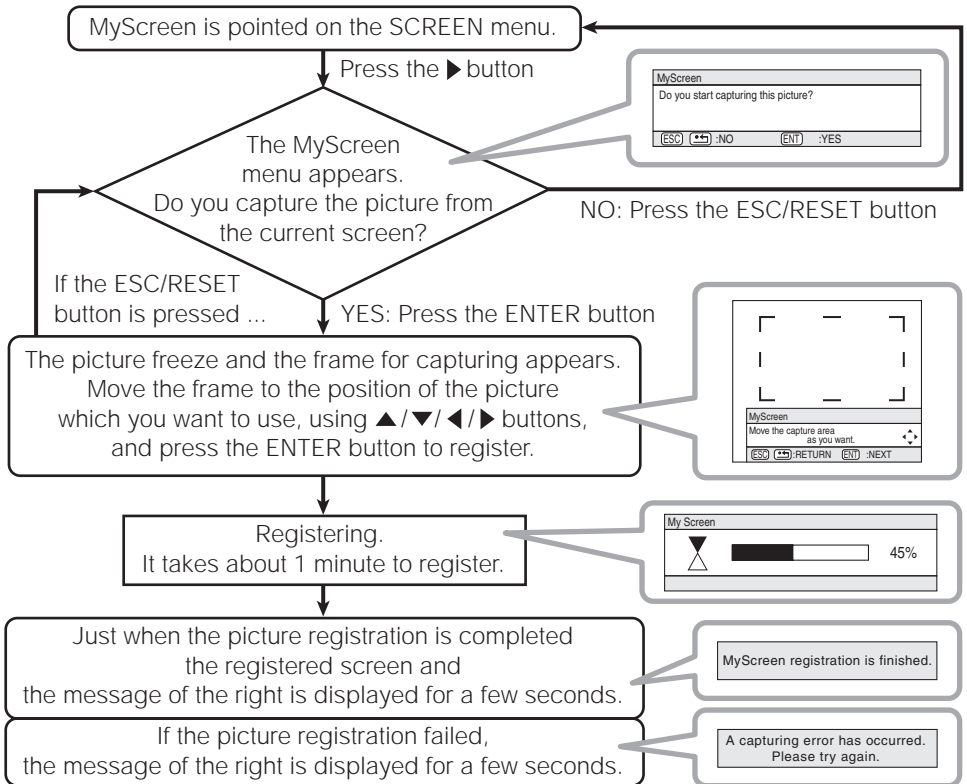

Multifunctional Settings (continued)

OPTION Menu

With the OPTION menu, the items shown in the table below can be performed. Perform each operation in accordance with the instructions in the table below.

MENU		▲	
MAIN	VOLUME	16	
PICTURE-1	SPEAKER	TURN ON	
PICTURE-2	IR REMOTE		
INPUT	IR REMOTE ID	ALL	
AUTO	LAMP TIME	1234 h	
SCREEN	FILTER TIME	4321 h	
OPTION	SERVICE		
NETWORK	RESET		
() SELECT			▼

Item	Description
VOLUME	Adjust the volume using the ▲ / ▼ buttons. : High ⇄ Low
SPEAKER	Select the TURN ON or the TURN OFF using the ▲ / ▼ buttons. : TURN ON ⇄ TURN OFF When the TURN ON is selected, the built-in speaker works.
IR REMOTE	Select a remote sensor using the ▲ / ▼ button (1), then switch it using the ENTER button (2). : (1) FRONT ⇄ TOP ⇄ REAR (2) <input type="checkbox"/> (Off) ⇄ <input checked="" type="checkbox"/> (On) memo A sensor cannot be turned off when the other two are off. Always at least one sensor is on.
IR REMOTE ID	Select a number as an ID number for remote control using the ▲ / ▼ buttons. : ALL ⇄ 1 ⇄ 2 ⇄ 3 The projector is controlled by the remote control whose ID CHANGE switch is set into the position of the same number as this number. When the ALL is selected, the projector is controlled by a remote control irrespective of the position of the ID CHANGE switch. memo Please refer to the section "Using The Remote ID Feature".
LAMP TIME	Pressing the RESET button for about 3 seconds displays the LAMP TIME menu. Select the RESET using ▲ button to reset the timer. : RESET ⇄ CANCEL Selecting the RESET resets the count of the lamp timer to 0. memo Perform this function only when you have replaced the lamp. The lamp timer counts the used time of the current lamp, to display the messages about the lamp. Incorrect performing causes incorrect operation of the messages. memo About replacing the lamp, please refer to the section "Lamp".
FILTER TIME	Pressing the RESET button for about 3 seconds displays the FILTER TIME menu. Select the RESET using ▲ button to reset the timer. : RESET ⇄ CANCEL Selecting the RESET resets the count of the lamp timer to 0. memo Perform this function only when you have cleaned or replaced the air filter. The filter timer counts the used time of the air filter after cleaning or replacement, to display the messages about the air filter. Incorrect performing causes incorrect operation of the messages. memo About caring for the air filter, please refer to the section "Air Filter".



(This table is continued to the following page.)

Multifunctional Settings (continued)

OPTION Menu (continued)

Item	Description												
SERVICE	Pressing the ▶ (or the ENTER) button calls the SERVICE menu. SERVICE Menu Select an item using the ▲ / ▼ buttons, and press the ▶ (or the ENTER) button to per form each function. : FANSPEED ⇔ AUTO ADJUST ⇔ LENS TYPE ⇔ LENS LOCK <table border="1" data-bbox="874 236 1028 347" style="float: right; margin-top: 10px;"> <tr><td colspan="2" style="text-align: center;">SERVICE</td></tr> <tr><td>FANSPEED</td><td style="text-align: right;">▶NORMAL</td></tr> <tr><td>AUTO ADJUST</td><td style="text-align: right;">ENABLE</td></tr> <tr><td>LENS TYPE</td><td style="text-align: right;">AUTO</td></tr> <tr><td>LENS LOCK</td><td style="text-align: right;">TURN OFF</td></tr> <tr><td colspan="2" style="text-align: center;">⊙:SELECT</td></tr> </table>	SERVICE		FANSPEED	▶NORMAL	AUTO ADJUST	ENABLE	LENS TYPE	AUTO	LENS LOCK	TURN OFF	⊙:SELECT	
	SERVICE												
	FANSPEED	▶NORMAL											
	AUTO ADJUST	ENABLE											
	LENS TYPE	AUTO											
LENS LOCK	TURN OFF												
⊙:SELECT													
FANSPEED	Select the fan speed level using the ▲ / ▼ buttons. : HIGH ⇔ NORMAL The HIGH ups rotation speeds of fans, though. Please use this function in using a projector at highlands etc. <i>memo</i> Note that the projector is noisier when the HIGH is selected.												
AUTO ADJUST	Select the ENABLE or the DISABLE using the ▲ / ▼ buttons. : ENABLE ⇔ DISABLE When you want to keep the current adjustment state, select the DISABLE. When the ENABLE is selected, detecting a signal change to a RGB signal performs the automatic adjustment of the vertical position (V POSITION), the horizontal position (H POSITION), the clock phase (H PHASE) and the horizontal size (H SIZE).												
LENS TYPE	Select the lens type currently used using the ▲ / ▼ buttons. : AUTO ⇔ 1 ⇔ 2 ⇔ 3 ⇔ 4 ⇔ 5 Please select depending on the following. AUTO: automatically selects optimum mode. 1: for a standard lens (Type NL-500 etc.) 2: for a fixed short throw lens (Type FL-501 etc.) 3: for a short throw lens (Type SL-502 etc.) 4: for a long throw lens (Type LL-503 etc.) 5: for a super long throw lens (Type LL-504 etc.) <i>memo</i> This setting has an influence on the keystone distortion etc. <i>memo</i> About the optional lens, ask your dealer.												
LENS LOCK	Select the TURN ON or the TURN OFF using the ▲ / ▼ buttons. : TURN ON ⇔ TURN OFF Selecting the TURN ON locks the adjustment of the lens shift, the zoom and the focus.												
RESET	Select the EXECUTE using the ▲ button to reset the OPTION menu items. : EXECUTE ⇔ CANCEL The items of the OPTION menu are collectively returned to the initial setting. Note that the items "VOLUME", "LAMP TIME" and "FILTER TIME" are not reset.												

Multifunctional Settings (continued)

NETWORK Menu

This projector provides the NETWORK function. If you use this function, please set up the projector according to the Network environment in which you use it.

memo When you use a Network suitable to the DHCP function, the following operation is not required commonly, because the TURN ON is selected to the item "DHCP" at the shipment time. Please see the section "Network Setting Up".

MENU	
MAIN	SETUP
PICTURE-1	DHCP
PICTURE-2	INFORMATION
INPUT	RESET
AUTO	
SCREEN	
OPTION	
NETWORK	
(SELECT)	

Item	Description
SETUP	<p>Pressing the ▶ (or the ENTER) button calls the IP ADDRESS menu.</p> <p>memo This item performs only when the TURN OFF is set to the item "DHCP" of this NETWORK menu. The IP Address is identification number of the projector on the Network.</p> <p>1. Set the IP Address using the ▲ / ▼ buttons.</p> <p>memo The same number as the IP Address of other units cannot be used.</p> <p>Pressing the ▶ (or the ENTER) button at the IP ADDRESS menu calls the SUBNET MASK menu. The SUBNET MASK is an address of the Network.</p> <p>2. Set the same number as the address of the Network to be used.</p> <p>Pressing the ▶ (or the ENTER) button at the SUBNET MASK menu calls the DEFAULT GATEWAY menu. The DEFAULT GATEWAY is the address of the main device.</p> <p>3. Set the same number as the address of the device as gateway to an outer Network.</p>
DHCP	<p>Select the TURN ON or the TURN OFF using the ▲ / ▼ buttons. :</p> <p>TURN ON ⇄ TURN OFF</p> <p>When you use a Network unsuitable to the DHCP function, select the TURN OFF.</p>
INFORMATION	<p>Pressing the ▶ (or the ENTER) button displays the INFORMATION menu.</p> <p>The INFORMATION menu shows the information about the current Network setting as illustrated below.</p>
RESET	<p>Select the EXECUTE using the ▲ button to reset the NETWORK menu items. :</p> <p>EXECUTE ⇄ CANCEL</p> <p>The items of the NETWORK menu are collectively returned to the initial setting.</p>

NETWORK - SETUP	
IP ADDRESS	
▲	192 . 168 . 1 . 24
▼	
(ESC) (F5) :RETURN	(ENT) :NEXT

NETWORK - SETUP	
SUBNET MASK	
▲	255 . 255 . 255 . 1
▼	
(ESC) (F5) :RETURN	(ENT) :NEXT

NETWORK - SETUP	
DEFAULT GATEWAY	
▲	255 . 255 . 255 . 0
▼	
(ESC) (F5) :RETURN	(ENT) :NEXT

NETWORK
DHCP
TURN ON
TURN OFF

NETWORK-INFORMATION	
IP ADDRESS	192.168.1.24
SUBNETMASK	255.255.255.0
DEFAULT GATEWAY	255.255.255.0
MAC ADDRESS	00.E0.47.03.0C.D8

Network Setting Up

This projector provides the NETWORK function. If you use this function, please consult your dealer for information.

To start, connect the NETWORK port to a gateway device via a RJ-45 (10BASE-1) cable, then set up the projector according to the Network environment in which you use it.

When you use a Network unsuitable to the DHCP function

Please set the IP Address, the Subnet Mask, the Gateway and the DHCP (on/off) using the NETWORK menu, referring to the section "NETWORK Menu".

When you use a Network suitable to the DHCP function or has been set up

You can set the IP Address, the Subnet Mask, the Gateway and the DHCP (on/off) using a Web Browser of the computer connected to the Network. Although it needs a Web Browser of Internet Explorer 4.0 or higher.

Input the same IP address as set to the projector, to the Web Browser of the computer connected to LAN.

ex. Case of IP Address = 192.168.1.11

- 1) Input "http://192.168.1.11".
- 2) Click "ENTER".
- 3) Input the required data according to the screen.
- 4) Make sure of the input data, then click "Write".
memo These setting will be active after reboot. These setting will be stored, and used when DHCP is OFF.
- 5) Click "Return to top page".
- 6) Click "REBOOT" to complete this operation.

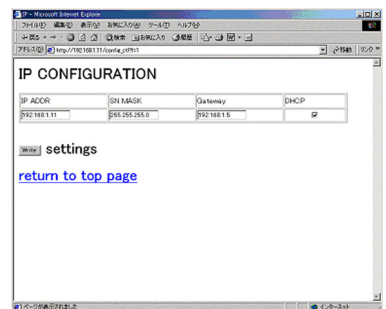
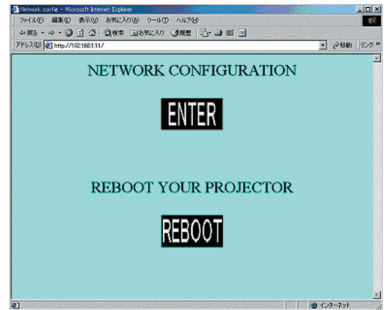

Lamp



WARNING



HIGH VOLTAGE



HIGH TEMPERATURE



HIGH PRESSURE

The projector uses a high-pressure mercury glass lamp. The lamp can **break with a loud bang, or burn out**, if jolted or scratched, handled while hot, or worn over time. Note that each lamp has a different lifetime, and some may burst or burn out soon after you start using them. In addition, when the bulb bursts, it is possible for **shards of glass** to fly into the lamp housing, and for **gas containing mercury** to escape from the projector's vent holes.

About disposal of a lamp • This product contains a mercury lamp; do not put in trash. Dispose of in accord with environmental laws.

For lamp recycling, go to www.lamprecycle.org. (in USA)

For product disposal, contact your local government agency or www.eiae.org (in the US) or www.epsc.ca (in Canada).

For more information, call your dealer.



Disconnect the plug from the power outlet

- If the lamp should break (it will make a loud bang when it does), unplug the power cord from the outlet, and make sure to request a replacement lamp from your local dealer. Note that shards of glass could damage the projector's internals, or cause injury during handling, so please do not try to clean the projector or replace the lamp yourself.
- If the lamp should break (it will make a loud bang when it does), ventilate the room well, and make sure not to breathe the gas that comes out of the projector vents, or get it in your eyes or mouth.
- Before replacing the lamp, make sure the power switch is off and the power cable is not plugged in, then wait at least 45 minutes for the lamp to cool sufficiently. Handling the lamp while hot can cause burns, as well as damaging the lamp.



- Do not open the lamp cover while the projector is suspended from above. This is dangerous, since if the lamp's bulb has broken, the shards will fall out when the cover is opened. In addition, working in high places is dangerous, so ask your local dealer to have the lamp replaced even if the bulb is not broken.
- Do not use the projector with the lamp cover removed. At the lamp replacing, make sure that the screws are screwed in firmly. Loose screws could result in damage or injury.



- Use only the lamp of the specified type **DT00601**.
- If the lamp breaks soon after the first time it is used, it is possible that there are electrical problems elsewhere besides the lamp. If this happens, contact your local dealer or a service representative.
- Handle with care: jolting or scratching could cause the lamp bulb to burst during use.
- If the indicators or a message prompts you to replace the lamp (see the section "Related Messages" and "Regarding the indicator Lamps"), replace the lamp as soon as possible. Using the lamp for long periods of time, or past the replacement date, could cause it to burst. Do not use old (used) lamps; this is a cause of breakage.

Lamp (continued)

Replacing The Lamp

If the indicators or a message prompts you to replace the lamp, replace the lamp as soon as possible.

- 1 Turn off the projector, and unplug the power cord. Allow the lamp bulb to cool for at least 45 minutes.
- 2 Contact your dealer to prepare a new lamp. Tell the dealer your lamp type number. If the projector is mounted on the ceiling, or if the lamp has broken, also ask the dealer to replace the lamp.

In the case of replacement by yourself,

- 3 After making sure that the projector has cooled adequately, slide the knob of a lamp cover lock as shown in the Figure. Then, one side of the lamp cover is raised. Pull up the lamp cover and remove it, as shown in the Figure.

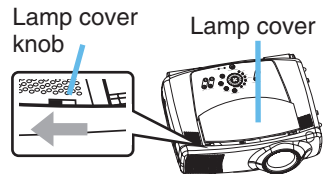

- 4 Unscrew the 3 screws, and slowly pull out the lamp by the handle. Be careful not to touch the inside of the lamp case.

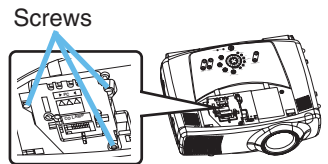

- 5 Insert the new lamp, and tighten the 3 screws firmly to lock it in place.

- 6 Interlocking the 2 tabs of the lamp cover to the projector, put the lamp cover on the projector. Then push the point of the lamp cover to fix it, as shown in the Figure. Make sure that the lamp cover doesn't come up.



- 7 Turn on the projector, and reset the lamp timer.
 - (1) While the projector running, press the MENU button to open the menu.
 - (2) Choose the "OPTION" on the menu using the ▲ / ▼ button, then press the ► button or ENTER button.
 - (3) Choose the "LAMP TIME" using the ▲ / ▼ button, then press and hold the RESET button for 3 seconds.
 - (4) Choose the "RESET" using the ▲ button.

memo When the lamp has been replaced after the message of "THE POWER WILL TURN OFF AFTER 0hr." is displayed, complete the following operation within 10 minutes of switching power on.

memo Incorrectly resetting of the lamp timer (resetting without replacement, or neglect of resetting after replacement) will result in incorrect message functions.

Air Filter



WARNING • Please carefully read the “User’s Manual - Safety Guide.

- Before caring, make sure the power switch is off and the power cable is not plugged in, then wait at least 45 minutes for the lamp to cool sufficiently.

- Use only the air filter of the specified type **NJ08081**.

- Do not use the projector with the air filter and filter cover removed. The use without the air filter could result in damage.



CAUTION • If the air filter becomes clogged by dust or the like, internal

temperature rises and could cause malfunction. The power is automatically turned off in order to prevent the projector from overheating internally.

Caring For The Air Filter

The air filter should be cleaned about every 100 hours. If the indicators or a message prompts you to clean the air filter, clean the air filter as soon as possible.

If the soiling will not come off the air filter, or it becomes damaged, then it needs to be replaced. Please replace the air filter as soon as possible.

memo When you replace the lamp, please replace also the air filter.

1

Turn off the projector, and unplug the power cord. Allow the lamp bulb to cool for at least 45 minutes.

2

After making sure that the projector has cooled adequately, remove the filter cover and air filter.

3

Apply a vacuum cleaner to the top of the filter cover and the air filter to clean.

If the soiling will not come off the air filter, or it becomes damaged, it needs to be replaced.

If the air filter needs to be replaced, contact your dealer to prepare a new air filter. Tell the dealer your air filter type.

4

Insert the cleaned air filter or a new air filter, and replace the filter cover.

5

Turn on the projector power, and reset the filter timer.

(1) While the projector running, press the MENU button to open the menu.

(2) Choose the “OPTION” on the menu using the ▲ / ▼ button, then press the ► button or ENTER button.

(3) Choose the “FILTER TIME” using the ▲ / ▼ button, then press and hold the RESET button for 3 seconds.

(4) Choose the “RESET” using the ▲ button.

memo Incorrectly resetting of the filter timer (resetting without replacement, or neglect of resetting after replacement) will result in incorrect message functions.

Hold the release buttons of the filter cover while pulling down it.

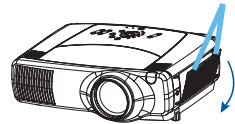

Hold the release button of the air filter while pulling out it.

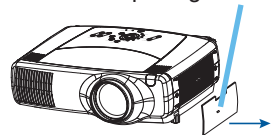

Other Care



WARNING • Please carefully read the “User’s Manual - Safety Guide”.

- Before caring, make sure the power switch is off and the power cable is not plugged in.

- Be cautious of high temperature. Do not touch about the lens and ventilation openings during use or immediately after use prevent a burn.

- Never try to care for the inside of the unit yourself. Doing so is dangerous.



CAUTION • Incorrect care could have adverse influence such as discoloration, peeling paint, etc.

- Do not use cleaner or chemicals other than those listed below, including benzene and paint thinner.

- Do not use aerosols or sprays.

- Do not polish or wipe with hard objects.

Caring For The Inside Of The Projector

In order to ensure the safe use of your projector, please have it cleaned and inspected by your local dealer about once every 2 years.

Caring For The Lens

1 Turn off the projector, and unplug the power cord.

2 Lightly wipe the lens with a commercially available lens-cleaning wipe. Do not touch the lens directly with your hand.

Caring For The Cabinet And Remote Control

1 Turn off the projector, and unplug the power cord.

2 Wipe lightly with gauze or a soft cloth.

memo If soiling is severe, dip soft cloth in water or a neutral cleaner dilute in water, and wipe lightly after wringing well. Then, wipe lightly with a soft, dry cloth.

Troubleshooting

Related Messages

When the unit's power is on, messages such as those shown below may be displayed. When any such message is displayed on the screen, please respond as described below. If the same message is displayed after the treatment, or if a message other than the following appears, please contact your dealer or service company.

memo Although these messages will be automatically disappeared around several minutes, it will be reappeared every time the power is turned on.

Message	Description
<p>☼ CHANGE THE LAMP</p> <p>AFTER REPLACING LAMP, RESET THE LAMP TIMER.</p>	<p>The time the lamp timer has counted is approaching 2000 hours.</p> <p>Preparation of a new lamp, and an early lamp change is recommended. After you have change the lamp, please be sure to reset the lamp timer.</p>
<p>☼ CHANGE THE LAMP</p> <p>AFTER REPLACING LAMP, RESET THE LAMP TIMER.</p> <p>THE POWER WILL TURN OFF AFTER ** hr.</p>	<p>The time the lamp timer has counted is approaching 2000 hours, so a lamp change within ** hours is recommended.</p> <p>When lamp usage reaches 2000 hours, the power will automatically be turned off.</p> <p>Please change the lamp by referring to the section "Lamp". After you have changed the lamp, please be sure to reset the lamp timer.</p>
<p>☼ CHANGE THE LAMP</p> <p>AFTER REPLACING LAMP, RESET THE LAMP TIMER.</p> <p>THE POWER WILL TURN OFF AFTER 0 hr.</p>	<p>As the time the lamp timer has counted has reached 2000 hours, the power will soon be automatically turned off.</p> <p>Please immediately turn the power off, and change the lamp by referring to the section "Lamp". After changing the lamp, please be sure to reset the lamp timer.</p>

(This table is continued to the following page.)

NOTE • A lamp has a finite product life. Lamps are characterized by the fact that, after long hours of usage, a lamp will no longer light up, or the lamp will break or burst, etc. This projector is equipped with an automatic shut-down function, such that the power will automatically be turned off when lamp usage time has reached 2000 hours. Please be aware, however, that among lamp types, there are major differences in product lifetimes; a lamp may thus fail to light even prior to the functioning of the automatic shut-down function of this projector.

Troubleshooting (continued)

Related Messages (continued)

Message	Description
<p>CLEAN THE AIR FILTER</p> <p>POWER OFF FIRST, THEN CLEAN THE AIR FILTER. AFTER CLEANING THE AIR FILTER, RESET THE FILTER TIMER.</p>	<p>The time the filter timer has counted has reached 100 hours.</p> <p>Please clear or change the air filter by referring to the section "Air Filter". After caring for the air filter, please be sure to reset the filter timer.</p>
<p>CHECK THE AIR FLOW</p>	<p>The internal portion temperature is rising.</p> <p>Please turn the power OFF, and allow the unit to cool down at least 20 minutes. After the projector has sufficiently cooled down, please make confirmation of the following items, and then turn the power on again.</p> <ul style="list-style-type: none"> • Is there blockage of the air passage aperture? • Is the air filter dirty? • Does the peripheral temperature exceed 35°C?
<p>NO INPUT IS DETECTED ON ***</p>	<p>There is no input signal.</p> <p>Please confirm the signal input connection, and the status of the signal source.</p>
<p>SYNC IS OUT OF RANGE ON *** fH *****kHz fV *****Hz</p>	<p>The horizontal or vertical wavelength of the inputted signal is outside of the response parameters of this unit.</p> <p>Please confirm the specs for this unit or the signal source specs.</p>

Troubleshooting (continued)

Regarding The Indicator Lamps

Lighting and flashing of the STANDBY/ON indicator, the LAMP indicator, and the TEMP indicator have the meanings as described in the table below. Please respond in accordance with the instructions within the table. If the same indication is displayed after the treatment, or if an indication other than the following is displayed, please contact your dealer or service company.

NOTE • When the interior portion has become overheated, for safety purposes, the power source is automatically turned off, and the indicator lamps may also be turned off. In such a case, press the “○” (OFF) side of the main power switch, and wait at least 45 minutes. After the projector has sufficiently cooled down, please make confirmation of the attachment state of the lamp and lamp cover, and then turn the power on again.

STANDBY/ON indicator	LAMP indicator	TEMP indicator	Description
Lighting in Orange	Turned off	Turned off	The projector is in a standby state. Please refer to the section “Power On/Off”.
<i>Blinking in Green</i>	Turned off	Turned off	The projector is warming up. Please wait.
Lighting in Green	Turned off	Turned off	The projector is in an on state. Ordinary operations may be performed.
<i>Blinking in Orange</i>	Turned off	Turned off	The projector is cooling down. Please wait.
<i>Blinking in Red</i>	(discretionary)	(discretionary)	The projector is cooling down. A certain error has been detected. Please wait until the STANDBY/ON indicator finishes blink, and then perform the proper response measure using the item descriptions below as reference.
Lighting in Red	Lighting in Red	Turned off	The lamp does not light, and there is a possibility that interior portion has become heated. Please turn the power off, and allow the unit to cool down at least 20 minutes. After the projector has sufficiently cooled down, please make confirmation of the following items, and then turn the power on again. <ul style="list-style-type: none"> • Is there blockage of the air passage aperture? • Is the air filter dirty? • Does the peripheral temperature exceed 35°C? If the same indication is displayed after the treatment, please change the lamp by referring to the section “Lamp”.

(This table is continued to the following page.)

Troubleshooting (continued)

Regarding The Indicator Lamps (continued)

STANDBY/ON indicator	LAMP indicator	TEMP indicator	Description
Lighting in Red	<i>Blinking in Red</i>	Turned off	<p>Either there is no lamp and/or lamp cover, or either of these has not been properly fixed.</p> <p>Please turn the power off, and allow the unit to cool down at least 45 minutes. After the projector has sufficiently cooled down, please make confirmation of the attachment state of the lamp and lamp cover, and then turn the power on again. If the same indication is displayed after the treatment, please contact your dealer or service company.</p>
Lighting in Red	Turned off	<i>Blinking in Red</i>	<p>The cooling fan is not operating.</p> <p>Please turn the power off, and allow the unit to cool down at least 20 minutes. After the projector has sufficiently cooled down, please make confirmation that no foreign matter has become caught in the fan, etc., and then turn the power on again. If the same indication is displayed after the treatment, please contact your dealer or service company.</p>
Lighting in Red	Turned off	Lighting in Red	<p>There is a possibility that the interior portion has become heated.</p> <p>Please turn the power off, and allow the unit to cool down at least 20 minutes. After the projector has sufficiently cooled down, please make confirmation of the following items, and then turn the power on again.</p> <ul style="list-style-type: none"> • Is there blockage of the air passage aperture? • Is the air filter dirty? • Does the peripheral temperature exceed 35°C? <p>If the same indication is displayed after the treatment, please change the lamp by referring to the section "Lamp".</p>
Lighting in Green	Alternative <i>Blinking in Red</i>		<p>There is a possibility that the interior portion has become overcooled.</p> <p>Please use the unit within the usage temperature parameters (0°C to 35°C). After the treatment, resent the power to ON.</p>
Lighting in Green	Simultaneous <i>Blinking in Red</i>		<p>It is time to clean the air filter, or there is no air filter.</p> <p>Please immediately turn the power OFF, and clean or change the air filter by referring to the section "Air Filter". After cleaning or changed the lamp, please be sure to reset the filter timer. After the treatment, resent the power to ON.</p>

Troubleshooting (continued)

Phenomena That May Easily Be Mistaken For Machine Defects

WARNING • Never use the projector if abnormal operations such as smoke, strange odor, excessive sound, damaged casing or elements or cables, penetration of liquids or foreign matter, etc. should occur. In such cases, immediately turn off the power switch and then disconnect the power plug from the power outlet. After making sure that the smoke or odor has stopped, contact your dealer or service company.

Before requesting repair, please check in accordance with the following chart. If the situation cannot be corrected, please contact your dealer or service company.

NOTE • Although bright spots or dark spots may appear on the screen, this is a unique characteristic of liquid crystal displays, and such do not constitute or imply a machine defect.

Phenomenon	Cases not involving a machine defect	Reference pages
Power does not come on.	The electrical power cord is not plugged in. Correctly connect the power cord.	11
	The power switch is not set to the on position. Set the power switch to [] (On).	15
	The main power source has been interrupted during operation such as by a power outage (blackout), etc. Please turn the power off, and allow the unit to cool down at least 20 minutes. After the projector has sufficiently cooled down, please turn the power on again.	15
	Either there is no lamp and/or lamp cover, or either of these has not been properly fixed. Please turn the power off, and allow the unit to cool down at least 45 minutes. After the projector has sufficiently cooled down, please make confirmation of the attachment state of the lamp and lamp cover, and then turn the power on again.	35, 36
Neither sounds nor pictures are outputted.	The signal cables are not correctly connected. Correctly connect the connection cables.	8, 9
	Signal source does not correctly work. Correctly set up the signal source device by referring to the manual of the source device.	-
	The input changeover settings are mismatched. Select the input signal, and correct the settings.	16

(This table is continued to the following page.)

Troubleshooting (continued)

Phenomena That May Easily Be Mistaken For Machine Defects (continued)

Phenomenon	Cases not involving a machine defect	Reference pages
Pictures are displayed, but no sounds are heard.	The signal cables are not correctly connected. Correctly connect the connection cables.	8, 9
	The volume is adjusted to an extremely low level. Adjust the VOLUME to a higher level.	19, 32
	The sound is muted. Press the MUTE button to restore the sound.	19
	The audio input is not correctly selected when the child window is displayed. Correctly select the audio input.	22
Sounds are heard, but no pictures are displayed.	The lens cap is attached. Remove the lens cap.	4, 15
	The signal cables are not correctly connected. Correctly connect the connection cables.	8, 9
	The brightness is adjusted to an extremely low level. Adjust the BRIGHT to a higher level using the menu function.	23
	The screen is blanked. Press the BLANK button to return to the input signal screen.	19
Colors have a faded- out appearance, or Color tone is poor.	Color settings are not correctly adjusted. Perform picture adjustments by changing the COLOR BAL R, COLOR BAL G, COLOR BAL B, COLOR and/or TINT settings, using the menu functions.	24
Pictures appear dark.	The brightness and/or contrast are adjusted to an extremely low level. Adjust the BRIGHT and/or CONTRAST settings to a higher level using the menu function.	23
	The WHISPER function is working. Select the NORMAL to the item WHISPER in the MAIN menu.	23
	The lamp is approaching the end of its product lifetime. Replace the lamp.	35, 36
Pictures appear blurry.	Either the focus and/or horizontal phase settings are not properly. Adjust the focus using the focus buttons, and/or H PHASE using the menu function.	16
	The lens is dirty or misty. Clean the lens by referring to the section "Caring For The Lens".	38
Input signal changes with no operation.	The INPUT dial is set between the click points. Turn the INPUT dial and set it at a click point.	16

Warranty And After-Service

If a problem occurs with the equipment, first refer to the “Troubleshooting” and run through the suggested checks. If this does not resolve the problem, please contact your dealer or service company. They will tell you what warranty condition is applied.

Specifications

NOTE • This specifications are subject to change without notice.

Item		Specification
Product name		Liquid crystal projector
Liquid crystal panel	Panel size	2.5 cm (0.99 type)
	Drive system	TFT active matrix
	Pixels	786,432 pixels (1024 horizontal x 768 vertical)
Lens		Zoom lens F=1.7 ~ 2.4 f=30.5 ~ 45.8 mm
Lamp		310W UHB
Speaker		1.0W + 1.0W (Stereo)
Power supply		AC100 ~ 120V, 5.2A / AC220 ~ 240V, 2.2A
Power consumption		470W
Temperature range		0 ~ 35°C (Operating)
Size		420 (W) x 150 (H) x 310 (D) mm (Not including protruding parts) • Please refer to the figure of the section “TECHNICAL” of the end of this manual.
Weight (mass)		7.7 kg
Ports		<p>RGB input ports RGB M1-D BNC (R, G, B, H, V)</p> <p>Video input ports VIDEO IN S-VIDEO COMPONENT (Cr/Pr, Cb/Pb, Y)</p> <p>Audio input ports AUDIO IN 1 AUDIO IN 2 AUDIO IN R/L</p> <p>RGB output port RGB OUT</p> <p>Audio output port AUDIO OUT</p> <p>Control port CONTROL</p> <p>Other ports NETWORK REMOTE CONTROL DC OUT</p>
Optional Parts	Lamp	DT00601
	Air filter	NJ08081
	Others	• Please consult your dealer.