

myprojectorlamps.com

**The most trusted, dependable name
in projector lamp sales.**



<http://www.myprojectorlamps.com>



<http://www.myprojectorlamps.ca>



<http://www.myprojectorlamps.eu>

The following projector manual has not been modified or altered in any way.

Projector

CP-RX80

User's Manual (detailed)

Operating Guide

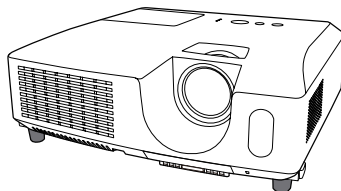

Thank you for purchasing this projector.

⚠ WARNING ▶ Before using this product, please read all manuals for this product. Be sure to read “**Safety Guide**” first. After reading them, store them in a safe place for future reference.

About this manual

Various symbols are used in this manual. The meanings of these symbols are described below.

⚠ WARNING This symbol indicates information that, if ignored, could possibly result in personal injury or even death due to incorrect handling.

⚠ CAUTION This symbol indicates information that, if ignored, could possibly result in personal injury or physical damage due to incorrect handling.

NOTICE This entry notices of fear of causing trouble.

 Please refer to the pages written following this symbol.

NOTE • The information in this manual is subject to change without notice.
• The manufacturer assumes no responsibility for any errors that may appear in this manual.
• The reproduction, transfer or copy of all or any part of this document is not permitted without express written consent.

Trademark acknowledgment

- Mac® is a registered trademark of Apple Inc.
 - Windows® is a registered trademark of Microsoft Corporation in the U.S. and/or other countries.
 - VESA and DDC are trademarks of the Video Electronics Standard Association.
- All other trademarks are the properties of their respective owners.

Contents

		
About this manual	1	PICTURE menu
Contents	2	BRIGHTNESS, CONTRAST, GAMMA, COLOR TEMP, COLOR, TINT, SHARPNESS, MY MEMORY
Projector features	3	IMAGE menu
Preparations	3	ASPECT, OVER SCAN, V POSITION, H POSITION, H PHASE, H SIZE, AUTO ADJUST EXECUTE
Checking the contents of package	3	INPUT menu
Part names	4	PROGRESSIVE, VIDEO NR, COLOR SPACE, VIDEO FORMAT, COMPUTER IN, FRAME LOCK, RESOLUTION
Projector	4	SETUP menu
Control panel	5	KEYSTONE, ECO MODE, MIRROR, STANDBY MODE, MONITOR OUT
Rear panel	5	AUDIO menu
Remote control	6	VOLUME, SPEAKER, AUDIO SOURCE
Setting up	7	SCREEN menu
Arrangement	7	LANGUAGE, MENU POSITION, BLANK, START UP, MyScreen, MyScreen Lock, MESSAGE, SOURCE NAME, TEMPLATE, C.C.
Connecting your devices	9	OPTION menu
Connecting power supply	11	AUTO SEARCH, DIRECT ON, AUTO OFF, LAMP TIME, FILTER TIME, MY BUTTON, MY SOURCE, SERVICE
Using the security bar and slot	11	SECURITY menu
Remote control	12	SECURITY PASSWORD CHANGE, MyScreen PASSWORD, PIN LOCK, MY TEXT PASSWORD, MY TEXT DISPLAY, MY TEXT WRITING
Installing the batteries	12	Maintenance
About the remote control signal	13	Replacing the lamp
Changing the frequency of remote control signal	13	Cleaning and replacing the air filter
Power on/off	14	Other care
Turning on the power	14	Troubleshooting
Turning off the power	14	Related messages
Operating	15	Regarding the indicator lamps
Adjusting the volume	15	Shutting the projector down
Temporarily muting the sound	15	Resetting all settings
Selecting an input signal	16	Phenomena that may be easy to be mistaken for machine defects
Searching an input signal	17	Specifications
Selecting an aspect ratio	17	
Adjusting the projector's elevator	18	
Adjusting the zoom and focus	18	
Using the automatic adjustment feature	19	
Adjusting the position	19	
Correcting the keystone distortions	20	
Using the magnify feature	20	
Temporarily freezing the screen	21	
Temporarily blanking the screen	21	
Using the menu function	22	
EASY MENU	24	
ASPECT, KEYSTONE, PICTURE MODE, ECO MODE, MIRROR, RESET, FILTER TIME, LANGUAGE, ADVANCED MENU, EXIT		

Projector features

This projector realizes the large projection image, even if in a small space.

Preparations

Checking the contents of package

Your projector should come with the items shown below. Check that all the items are included. Require of your dealer immediately if any items are missing.

- (1) Remote control with two AA batteries
- (2) Power cord
- (3) Computer cable
- (4) User's manuals (Book x1, CD x1)

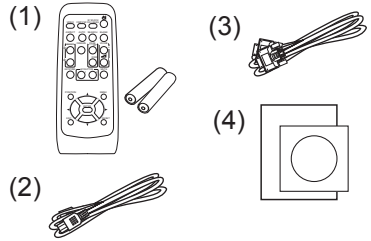

NOTE • Keep the original packing materials, for future reshipment. Be sure to use the original packing materials when moving the projector. Use special caution for the lens.

Part names

Projector

- (1) Lamp cover (📖52)
The lamp unit is inside.
- (2) Focus ring (📖18)
- (3) Zoom ring (📖18)
- (4) Control panel (📖5)
- (5) Elevator buttons (x 2) (📖18)
- (6) Elevator feet (x 2) (📖18)
- (7) Remote sensor (📖13)
- (8) Lens (📖56)
- (9) Intake vents
- (10) Filter cover (📖54)
The air filter and intake vent are inside.
- (11) Speaker (📖36)
- (12) Exhaust vent
- (13) **AC IN** (AC inlet) (📖11)
- (14) Rear panel (📖5)
- (15) Security bar (📖11)
- (16) Security slot (📖11)

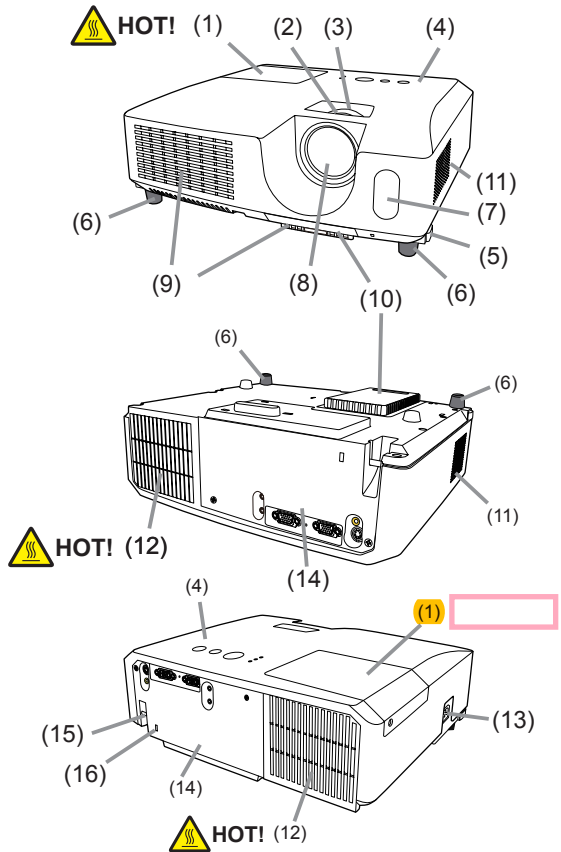

⚠ WARNING ▶HOT! : Do not touch around the lamp cover and the exhaust vents during use or just after use, since it is too hot.

- ▶ Do not look into the lens or vents while the lamp is on, since the strong light is not good for your eyes.
- ▶ Do not handle the elevator buttons without holding the projector, since the projector may drop down.

⚠ CAUTION ▶ Maintain normal ventilation to prevent the projector from heating up. Do not cover, block or plug up the vents. Do not place anything that can stick or be sucked to the vents, around the intake vents. Clean the air filter periodically.

- ▶ Do not use the security bar and slot to prevent the projector from falling down, since it is not designed for it.

Control panel

- (1) **STANDBY/ON** button (📖14)
- (2) **INPUT** button (📖16, 22)
- (3) **MENU** button (📖22)
It consists of four cursor buttons.
- (4) **POWER** indicator (📖11, 14, 58)
- (5) **TEMP** indicator (📖58)
- (6) **LAMP** indicator (📖58)

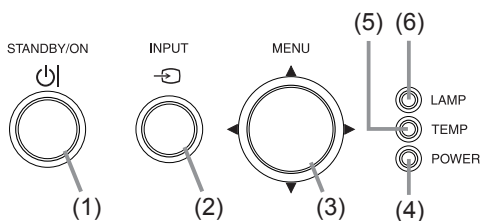

Rear panel (📖9)

- (1) **AUDIO OUT** port
- (2) **AUDIO IN** port
- (3) **COMPUTER IN** port
- (4) **MONITOR OUT** port
- (5) **Shutdown switch** (📖59)
- (6) **VIDEO** port
- (7) **S-VIDEO** port

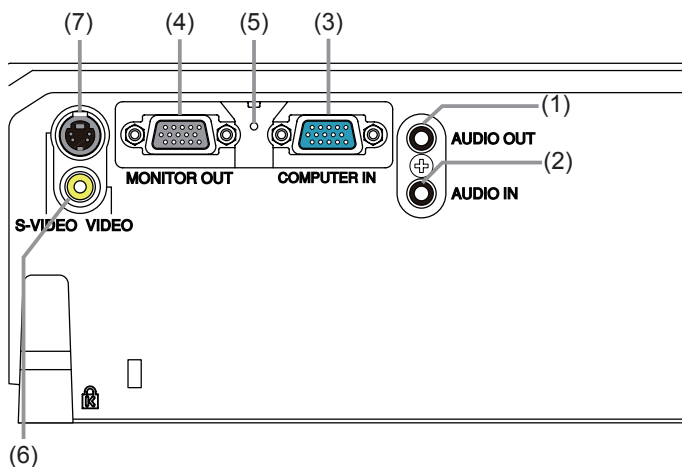

⚠ CAUTION ▶ Use the shutdown switch only when the projector is not turned off by normal procedure, since pushing this switch stops operation of the projector without cooling it down.

Remote control

- (1) VIDEO button (📖16)
- (2) COMPUTER button (📖16)
- (3) SEARCH button (📖17)
- (4) STANDBY/ON button (📖14)
- (5) ASPECT button (📖17)
- (6) AUTO button (📖19)
- (7) BLANK button (📖21)
- (8) MAGNIFY - ON button (📖20)
- (9) MAGNIFY - OFF button (📖13, 20)
- (10) MY SOURCE/DOC.CAMERA button (📖16, 44)
- (11) VOLUME - button (📖13, 15)
- (12) VOLUME + button (📖15)
- (13) MUTE button (📖15)
- (14) FREEZE button (📖21)
- (15) MY BUTTON - 1 button (📖44)
- (16) MY BUTTON - 2 button (📖44)
- (17) KEYSTONE button (📖20)
- (18) POSITION button (📖19, 20, 23)
- (19) MENU button (📖22)
- (20) ▲/▼/◀/▶ cursor buttons (📖22)
- (21) ENTER button (📖22)
- (22) ESC button (📖13, 22)
- (23) RESET button (📖13, 22)
- (24) Battery cover (📖12)

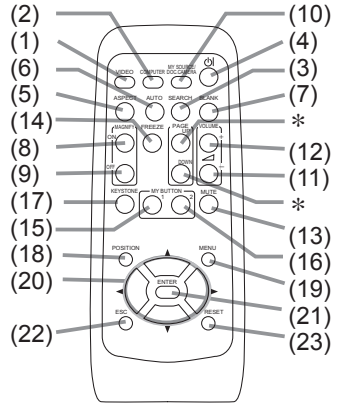

* These buttons don't work.

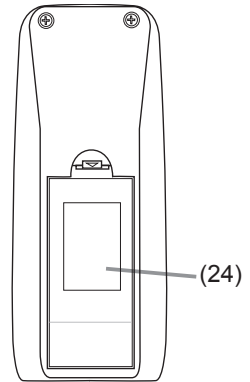

Back of
the remote control

NOTICE ▶ When one of the buttons marked with “*” was pressed, a message “NOT AVAILABLE” (📖57) appears on the screen.

Setting up

Install the projector according to the environment and manner the projector will be used in.

Arrangement

Refer to the illustrations and tables below to determine screen size and projection distance.

The values shown in the table are calculated for a full size screen: 1024 x 768

(a) Screen size (diagonal) (b) Projection distance ($\pm 10\%$)

(c1), (c2) Screen height ($\pm 10\%$)

On a horizontal surface

Suspended from the ceiling

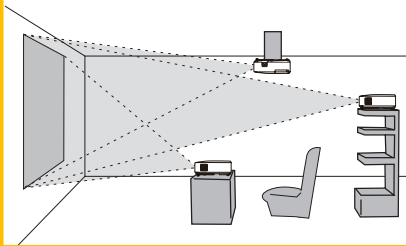
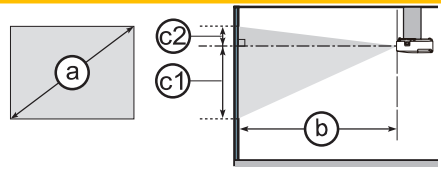
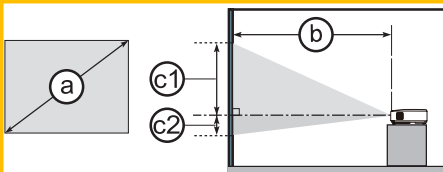

- Keep a space of 30 cm or more between the sides of the projector and other objects such as walls.
- For the case of installation in a special state such as ceiling mount, the specified mounting accessories (63) and service may be required. Before installing the projector, consult your dealer about your installation.

(a) Screen size (diagonal)		4 : 3 screen								16 : 9 screen							
		(b) Projection distance				(c1) Screen height		(c2) Screen height		(b) Projection distance				(c1) Screen height		(c2) Screen height	
		min.		max.		cm		inch		min.		max.		cm		inch	
type (inch)	m	m	inch	m	inch	cm	inch	cm	inch	m	inch	m	inch	cm	inch	cm	inch
30	0.8	0.8	33	1.0	40	38	15	8	3	0.9	36	1.1	44	35	14	2	1
40	1.0	1.1	45	1.4	54	51	20	10	4	1.2	49	1.5	59	47	19	3	1
50	1.3	1.4	56	1.7	68	64	25	13	5	1.6	62	1.9	74	59	23	3	1
60	1.5	1.7	68	2.1	82	76	30	15	6	1.9	74	2.3	89	71	28	4	2
70	1.8	2.0	80	2.4	96	89	35	18	7	2.2	87	2.7	104	82	32	5	2
80	2.0	2.3	91	2.8	110	102	40	20	8	2.5	99	3.0	119	94	37	6	2
90	2.3	2.6	103	3.1	123	114	45	23	9	2.8	112	3.4	135	106	42	6	2
100	2.5	2.9	114	3.5	137	127	50	25	10	3.2	124	3.8	150	118	46	7	3
120	3.0	3.5	137	4.2	165	152	60	30	12	3.8	150	4.6	180	141	56	8	3
150	3.8	4.4	172	5.2	207	191	75	38	15	4.8	187	5.7	225	176	69	10	4
200	5.1	5.8	230	7.0	276	254	100	51	20	6.4	250	7.6	301	235	93	14	5
250	6.4	7.3	287	8.8	345	318	125	64	25	8.0	313	9.6	376	294	116	17	7
300	7.6	8.8	345	10.5	414	381	150	76	30	9.5	376	11.5	452	353	139	21	8

Arrangement (continued)

⚠ WARNING ► Place the projector in a stable horizontal position. If the projector falls or is knocked over, it could cause injury and/or damage to the projector. Using a damaged projector could then result in fire and/or electric shock.

- Do not place the projector on an unstable, slanted or vibrational surface such as a wobbly or inclined stand.
- Do not place the projector on its side, front or rear position.
- Consult with your dealer before a special installation such as suspending from a ceiling or somewhere else.
- Place the projector in a cool place, and ensure that there is sufficient ventilation. The high temperature of the projector could cause fire, burns and/or malfunction of the projector.
- Do not stop-up, block or otherwise cover the projector's vents.
- Keep a space of 30 cm or more between the sides of the projector and other objects such as walls.
- Do not place the projector on metallic thing or anything weak in heat.
- Do not place the projector on carpet, cushions or bedding.
- Do not place the projector in direct sunlight or near hot objects such as heaters.
- Do not place anything near the projector lens or vents, or on top of the projector.
- Do not place anything that may be sucked into or stick to the vents on the bottom of the projector. This projector has some intake vents also on the bottom.
- Do not place the projector anywhere where it may get wet. Getting the projector wet or inserting liquid into the projector could cause fire, electric shock and/or malfunction of the projector.
- Do not place the projector in a bathroom or the outdoors.
- Do not place anything containing liquid near the projector.
- Use only the mounting accessories the manufacturer specified, and leave installing and removing the projector with the mounting accessories to the service personnel.
- Read and keep the user's manual of the mounting accessories used.
- ⚠ CAUTION** ► Avoid placing the projector in smoky, humid or dusty place. Placing the projector in such places could cause fire, electric shock and/or malfunction of the projector.
- Do not place the projector near humidifiers, smoking spaces or a kitchen.
- Position the projector to prevent light from directly hitting the projector's remote sensor.

Connecting your devices

Be sure to read the manuals for devices before connecting them to the projector. Make sure that the devices are suitable to be connected with this product, and prepare the cables required to connect. Please refer to the following illustrations to connect them.

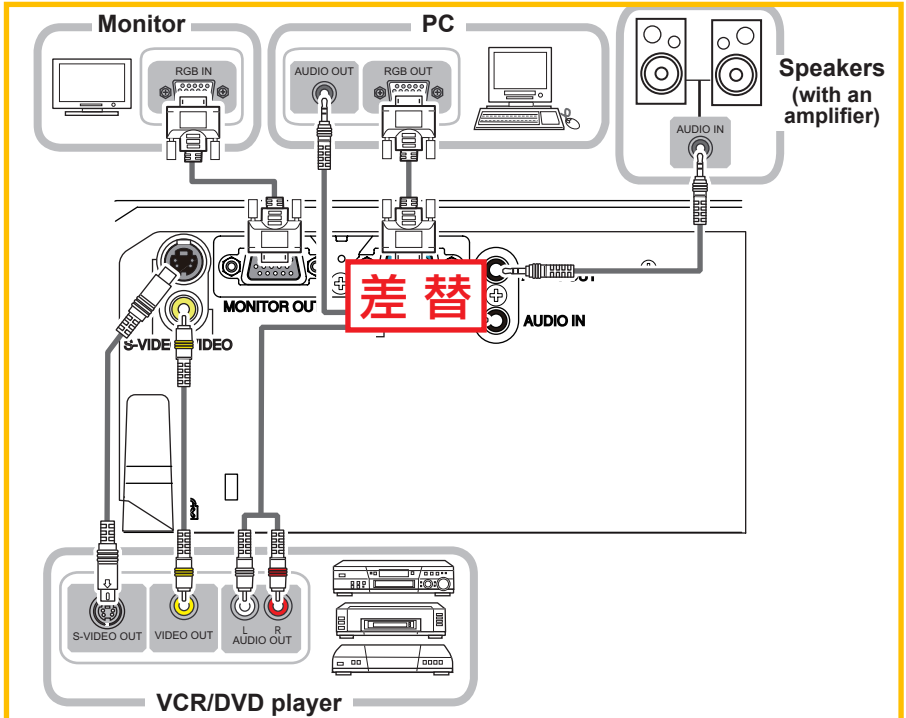

⚠ WARNING ▶ Do not disassemble or modify the projector and accessories.

▶ Be careful not to damage the cables, and do not use damaged cables.

⚠ CAUTION ▶ Turn off all devices and unplug their power cords prior to connecting them to projector. Connecting a live device to the projector may generate extremely loud noises or other abnormalities that may result in malfunction or damage to the device and the projector.

▶ Use appropriate accessory or designated cables. Ask your dealer about non-accessory cables which may be required a specific length or a ferrite core by the regulations. For cables with a core only at one end, connect the end with the core to the projector.

▶ Make sure that devices are connected to the correct ports. An incorrect connection may result in malfunction or damage to the device and the projector.

NOTICE ▶ Use the cables with straight plugs, not L-shaped ones, as the input ports of the projector are recessed.

Connecting your devices (continued)

NOTE • Be sure to read the manuals for devices before connecting them to the projector, and make sure that all the devices are suitable to be connected with this product. Before connecting to a PC, check the signal level, the signal timing, and the resolution.

- Some signal may need an adapter to input this projector.
- Some PCs have multiple screen display modes that may include some signals which are not supported by this projector.
- Although the projector can display signals with resolution up to UXGA (1600X1200), the signal will be converted to the projector's panel resolution before being displayed. The best display performance will be achieved if the resolutions of the input signal and the projector panel are identical.
- While connecting, make sure that the shape of the cable's connector fits the port to connect with. And be sure to tighten the screws on connectors with screws.
- When connecting a laptop PC to the projector, be sure to activate the PC's external RGB output. (Set the laptop PC to CRT display or to simultaneous LCD and CRT display.) For details on how this is done, please refer to the instruction manual of the corresponding laptop PC.
- When the picture resolution is changed on a PC depending on an input, automatic adjustment function may take some time and may not be completed. In this case, you may not be able to see a check box to select "Yes/No" for the new resolution on Windows. Then the resolution will go back to the original. It might be recommended to use other CRT or LCD monitors to change the resolution.
- In some cases, this projector may not display a proper picture or display any picture on screen. For example, automatic adjustment may not function correctly with some input signals. An input signal of composite sync or sync on G may confuse this projector, so the projector may not display a proper picture.

About Plug-and-Play capability

Plug-and-Play is a system composed of a PC, its operating system and peripheral equipment (i.e. display devices). This projector is VESA DDC 2B compatible. Plug-and-Play can be used by connecting this projector to a PC that is VESA DDC (display data channel) compatible.

- Take advantage of this feature by connecting a computer cable to the **COMPUTER IN** port (DDC 2B compatible). Plug-and-Play may not work properly if any other type of connection is attempted.
- Please use the standard drivers in your PC as this projector is a Plug-and-Play monitor.

Connecting power supply

1. Put the connector of the power cord into the **AC IN** (AC inlet) of the projector.
2. Firmly plug the power cord's plug into the outlet. In a couple of seconds after the power supply connection, the **POWER** indicator will light up in steady orange.

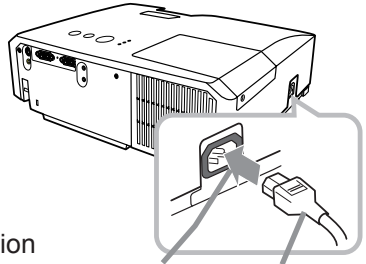

AC IN

Power cord

Please remember that when the DIRECT ON function activated (42), the connection of the power supply make the projector turn on.

⚠ WARNING ▶ Please use extra caution when connecting the power cord, as incorrect or faulty connections may result in fire and/or electrical shock.

- Only use the power cord that came with the projector. If it is damaged, consult your dealer to get a new one.
- Only plug the power cord into an outlet whose voltage is matched to the power cord. The power outlet should be close to the projector and easily accessible. Remove the power cord for complete separation.
- Never modify the power cord.

Using the security bar and slot

A commercial anti-theft chain or wire up to 10 mm in diameter can be attached to the security bar on the projector. Also this product has the security slot for the Kensington lock. For details, see the manual of the security tool.

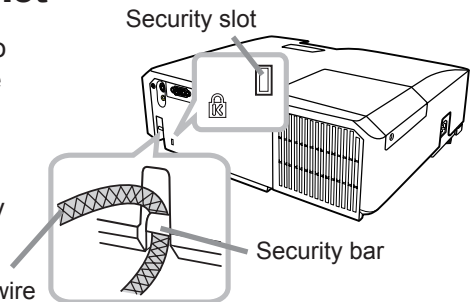

Security slot

Security bar

Anti-theft chain or wire

⚠ WARNING ▶ Do not use the security bar and slot to prevent the projector from falling down, since it is not designed for it.

⚠ CAUTION ▶ Do not place anti-theft chain or wire near the exhaust vents. It may become too hot.

NOTE • The security bar and slot is not comprehensive theft prevention measures. It is intended to be used as supplemental theft prevention measure.

Remote control

Installing the batteries

Please insert the batteries into the remote control before using it. If the remote control starts to malfunction, try to replace the batteries. If you will not use the remote control for long period, remove the batteries from the remote control and store them in a safe place.

1. Holding the hook part of the battery cover, remove it.
2. Align and insert the two AA batteries (**HITACHI MAXELL, Part No.LR6 or R6P**) according to their plus and minus terminals as indicated in the remote control.
3. Replace the battery cover in the direction of the arrow and snap it back into place.

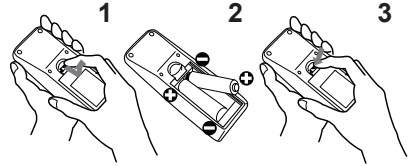

- ⚠ WARNING** ► Always handle the batteries with care and use them only as directed. Improper use may result in battery explosion, cracking or leakage, which could result in fire, injury and/or pollution of the surrounding environment.
- Be sure to use only the batteries specified. Do not use batteries of different types at the same time. Do not mix a new battery with used one.
 - Make sure the plus and minus terminals are correctly aligned when loading a battery.
 - Keep a battery away from children and pets.
 - Do not recharge, short circuit, solder or disassemble a battery.
 - Do not place a battery in a fire or water. Keep batteries in a dark, cool and dry place.
 - If you observe battery leakage, wipe out the leakage and then replace a battery. If the leakage adheres to your body or clothes, rinse well with water immediately.
 - Obey the local laws on disposing the battery.

About the remote control signal

The remote control works with the projector's remote sensor. This projector has a remote sensor on the front. The sensor senses the signal within the following range when the sensor is active:

60 degrees (30 degrees to the left and right of the sensor)
within 3 meters about.

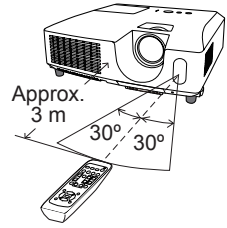

NOTE • The remote control signal reflected in the screen or the like may be available. If it is difficult to send the signal to the sensor directly, attempt to make the signal reflect.

- The remote control uses infrared light to send signals to the projector (Class 1 LED), so be sure to use the remote control in an area free from obstacles that could block the remote control's signal to the projector.
- The remote control may not work correctly if strong light (such as direct sun light) or light from an extremely close range (such as from an inverter fluorescent lamp) shines on the remote sensor of the projector. Adjust the position of projector avoiding those lights.

Changing the frequency of remote control signal

The accessory remote control has the two choices on signal frequency Mode 1:NORMAL and Mode 2:HIGH. If the remote control does not function properly, attempt to change the signal frequency.

In order to set the Mode, please keep pressing the combination of two buttons listed below simultaneously for about 3 seconds.

- (1) Set to Mode 1:NORMAL... **VOLUME -** and **RESET** buttons
- (2) Set to Mode 2:HIGH... **MAGNIFY OFF** and **ESC** buttons

Please remember that the REMOTE FREQ. in the SERVICE item of the OPTION menu ( 46) of the projector to be controlled should be set to the same mode as the remote control.

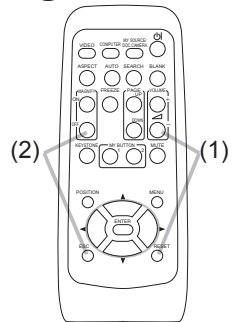

Power on/off

Turning on the power

1. Make sure that the power cord is firmly and correctly connected to the projector and the outlet.
2. Make sure that the **POWER** indicator is steady orange (📖58).
3. Press **STANDBY/ON** button on the projector or the remote control.
The projection lamp will light up and **POWER** indicator will begin blinking in green. When the power is completely on, the indicator will stop blinking and light in steady green (📖58).

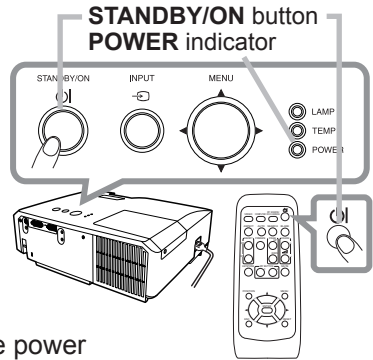

To display the picture, select an input signal according to the section “Selecting an input signal” (📖16).

Turning off the power

1. Press the **STANDBY/ON** button on the projector or the remote control. The message “Power off?” will appear on the screen for about 5 seconds.
2. Press the **STANDBY/ON** button again while the message appears.
The projector lamp will go off, and the **POWER** indicator will begin blinking in orange. Then **POWER** indicator will stop blinking and light in steady orange when the lamp cooling is complete (📖58).

Do not turn the projector on for about 10 minutes or more after turning it off. Turning the projector on again too soon could shorten the lifetime of some consumable parts of the projector.

⚠ WARNING ▶ A strong light is emitted when the projector’s power is on. Do not look into the lens of the projector or look inside of the projector through any of the projector’s openings.

▶ Do not touch around the lamp cover and the exhaust vents during use or just after use, since it is too hot.

NOTE • Turn the power on/off in right order. Please power on the projector prior to the connected devices.

- This projector has the function that can make the projector automatically turn on/off. Please refer to the **DIRECT ON** (📖42) and **AUTO OFF** (📖43) items of the **OPTION** menu.
- Use the shutdown switch (📖59) only when the projector is not turned off by normal procedure.

Operating

Adjusting the volume

- Use the **VOLUME +/VOLUME -** buttons to adjust the volume.
 - A dialog will appear on the screen to aid you in adjusting the volume. If you do not do anything, the dialog will automatically disappear after a few seconds.
 - When \times is selected for current picture input port, the volume adjustment is disabled. Please see AUDIO SOURCE item of AUDIO menu ([436](#)).
 - When the projector is in the standby mode, the volume can be adjusted if \times is not selected for the AUDIO OUT STANDBY and NORMAL is selected to the STANDBY MODE in the SETUP menu ([435](#)).

VOLUME +/- button

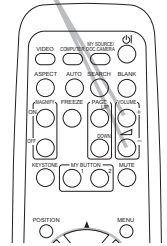
**Temporarily muting the sound**

- Press **MUTE** button on the remote control.
 - A dialog will appear on the screen indicating that you have muted the sound. To restore the sound, press the **MUTE, VOLUME +** or **VOLUME -** button. Even if you do not do anything, the dialog will automatically disappear after a few seconds.
 - When \times is selected for current picture input port, the sound is always muted. Please see AUDIO SOURCE item of AUDIO menu ([436](#)).
 - C.C. (Closed Caption) is automatically activated when sound is muted and an input signal containing C.C is received. This function is available only when the signal is NTSC for **VIDEO** or **S-VIDEO**, or 480i@60 for **COMPUTER IN**, and when AUTO is selected for DISPLAY in the C.C. menu under the SCREEN menu ([441](#)).

MUTE button

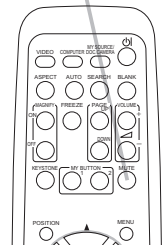

Selecting an input signal

1. Press **INPUT** button on the projector.
 - Each time you press the button, the projector switches its input port from the current port as below.

→ COMPUTER IN → S-VIDEO → VIDEO →

- While ON is selected for AUTO SEARCH item in OPTION menu (42), the projector will keep checking the ports in above order repeatedly till an input signal is detected.

INPUT button

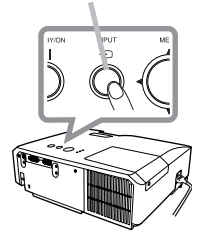

1. Press **COMPUTER** button on the remote control to select the **COMPUTER IN** port.

COMPUTER button

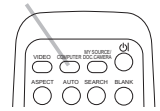

1. Press **VIDEO** button on the remote control.
 - Each time you press the button, the projector switches its input port from the current port as below.

S-VIDEO ⇔ VIDEO

- While ON is selected for AUTO SEARCH item in OPTION menu, the projector will keep checking every port sequentially till an input signal is detected (42). If **VIDEO** button is pressed when **COMPUTER IN** port is selected, the projector will check **S-VIDEO** port first.

VIDEO button

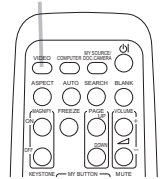

1. Press the **MY SOURCE / DOC. CAMERA** button on the remote control. The input signal will be changed into the signal you set as MY SOURCE (44).

MY SOURCE / DOC. CAMERA button

- This function also can use for document camera. Select the input port that connected the document camera.

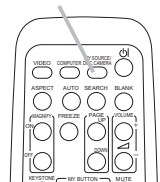

Searching an input signal

1. Press **SEARCH** button on the remote control.
 - The projector will start to check its input ports as below in order to find any input signals.
When an input is found, the projector will stop searching and display the image. If no signal is found, the projector will return to the state selected before the operation.

→ COMPUTER IN → S-VIDEO → VIDEO

- While ON is selected for AUTO SEARCH item in OPTION menu (42), the projector will keep checking the ports in above order repeatedly till an input signal is detected.

SEARCH button

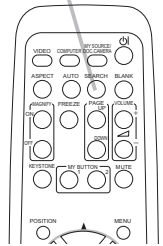

Selecting an aspect ratio

1. Press **ASPECT** button on the remote control.
 - Each time you press the button, the projector switches the mode for aspect ratio in turn.

- For a computer signal

NORMAL → 4:3 → 16:9 → 16:10



- For a video signal, s-video signal or component video signal

4:3 → 16:9 → 14:9



- For no signal

4:3 (fixed)

- **ASPECT** button does not work when no proper signal is inputted.
- **NORMAL** mode keeps the original aspect ratio setting.

ASPECT button

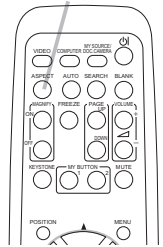

Adjusting the projector's elevator

When the place to put the projector is slightly uneven to the left or right, use the elevator feet to place the projector horizontally.

Using the feet can also tilt the projector in order to project at a suitable angle to the screen, elevating the front side of the projector within 14 degrees.

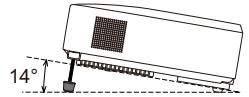

This projector has 2 elevator feet and 2 elevator buttons. An elevator foot is adjustable while pushing the elevator button on the same side as it.

1. Holding the projector, push the elevator buttons to loose the elevator feet.
2. Position the front side of the projector to the desired height.
3. Release the elevator buttons in order to lock the elevator feet.
4. After making sure that the elevator feet are locked, put the projector down gently.
5. If necessary, the elevator feet can be manually twisted to make more precise adjustments. Hold the projector when twisting the feet.

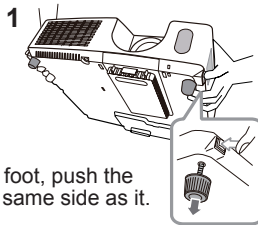

To loose an elevator foot, push the elevator button on the same side as it.

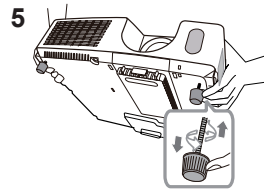

To finely adjust, twist the foot.

⚠ CAUTION ► Do not handle the elevator buttons without holding the projector, since the projector may drop down.

► Do not tilt the projector other than elevating its front within 14 degrees using the adjuster feet. A tilt of the projector exceeding the restriction could cause malfunction or shortening the lifetime of consumables, or the projector itself.

Adjusting the zoom and focus

1. Use the zoom ring to adjust the screen size.
2. Use the focus ring to focus the picture.

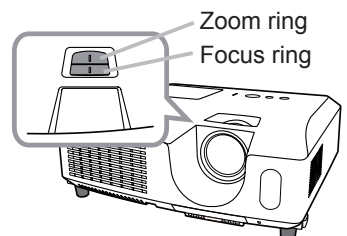

Using the automatic adjustment feature

1. Press **AUTO** button on the remote control.
 - Pressing this button performs the following.
 - **For a computer signal**
The vertical position, the horizontal position and the horizontal phase will be automatically adjusted.
Make sure that the application window is set to its maximum size prior to attempting to use this feature. A dark picture may still be incorrectly adjusted. Use a bright picture when adjusting.
 - **For a video signal and s-video signal**
The video format best suited for the respective input signal will be selected automatically. This function is available only when the AUTO is selected for the VIDEO FORMAT item in the INPUT menu (📖32). The vertical position and horizontal position will be automatically set to the default.
 - **For a component video signal**
The vertical position, horizontal position and horizontal phase will be automatically set to the default.
 - The automatic adjustment operation requires approx. 10 seconds. Also please note that it may not function correctly with some input.
 - When this function is performed for a video signal, a certain extra such as a line may appear outside a picture.
 - When this function is performed for a computer signal, a black frame may be displayed on the edge of the screen, depending on the PC model.
 - The items adjusted by this function may vary when the FINE or DISABLE is selected for the AUTO ADJUST item of the SERVICE item in the OPTION menu (📖45).

AUTO button

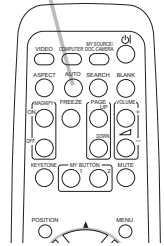

Adjusting the position

1. Press **POSITION** button on the remote control when no menu is indicated.
The "POSITION" indication will appear on the screen.
 2. Use the $\blacktriangle/\blacktriangledown/\blacktriangleleft/\blacktriangleright$ cursor buttons to adjust the picture position.
 - When you want to reset the operation, press **RESET** button on the remote control during the operation.
To complete this operation, press **POSITION** button again. Even if you do not do anything, the dialog will automatically disappear after a few seconds.
- When this function is performed on a video signal, s-video signal or component video signal, some image such as an extra-line may appear at outside of the picture.
 - When this function is performed on a video signal, s-video signal or component video signal, the range of this adjustment depends on OVER SCAN in IMAGE menu (📖29) setting. It is not possible to adjust when OVER SCAN is set to 10.
 - If **POSITION** button is pressed when a menu is indicated on screen, the displayed picture does not move its position but the menu does.

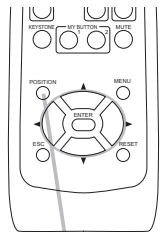

POSITION button

Correcting the keystone distortions

1. Press **KEYSTONE** button on the remote control. A dialog will appear on the screen to aid you in correcting the distortion.
2. Use the ◀/▶ buttons for adjustment.
To close the dialog and complete this operation, press **KEYSTONE** button again. Even if you do not do anything, the dialog will automatically disappear after a few seconds.
 - The adjustable range of this function will vary among inputs. For some input, this function may not work well.
 - When the projector is inclined to near ± 30 degree or over, this function may not work well.



KEYSTONE button

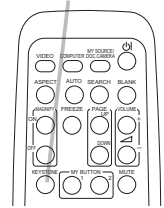

Using the magnify feature

1. Press the **ON** button of **MAGNIFY** on the remote control.
The “MAGNIFY” indication will appear on the screen and the projector will go into the MAGNIFY mode. When the **ON** button of **MAGNIFY** is pressed first after the projector is started, the picture will be zoomed twice. The indication will disappear in several seconds with no operation.
2. Use the ▲/▼ cursor buttons to adjust the zoom level.
To move the zoom area, press the **POSITION** button in the MAGNIFY mode, then use the ▲/▼/◀/▶ cursor buttons to move the area. And to finalize the zoom area, press the **POSITION** button again.
To exit from the MAGNIFY mode and restore the screen to normal, press the **OFF** button of **MAGNIFY** on the remote control.
 - The projector automatically exits from the MAGNIFY mode when the input signal is changed or when the display condition is changed.
 - In the MAGNIFY mode, the keystone distortion condition may vary, it will be restored when the projector exits from the MAGNIFY mode.

MAGNIFY ON/OFF button

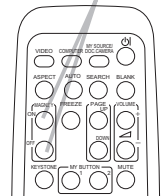

NOTE • The zoom level can be finely adjusted. Closely watch the screen to find the level you want.

Temporarily freezing the screen

1. Press the **FREEZE** button on the remote control.
 - The “FREEZE” indication will appear on the screen (however, the indication will not appear when the OFF is selected for the MESSAGE item in the SCREEN menu (📖39)), and the projector will go into the FREEZE mode, which the picture is frozen.

To exit the FREEZE mode and restore the screen to normal, press the **FREEZE** button again.

- The projector automatically exits from the FREEZE mode when some control buttons are pressed.
- If the projector continues projecting a still image for a long time, the LCD panel might possibly be burned in. Do not leave the projector in the FREEZE mode for too long.
- Images might appear degraded when this function is operated, but it is not a malfunction.

FREEZE button

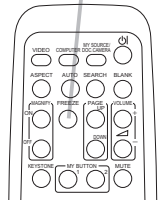

Temporarily blanking the screen

1. Press **BLANK** button on the remote control.
 - The BLANK screen will be displayed instead of the screen of input signal. Please refer to BLANK item in SCREEN menu (📖37).

To exit from the BLANK screen and return to the input signal screen, press **BLANK** button again.

- The projector automatically exits from the BLANK mode when some control buttons are pressed.

BLANK button

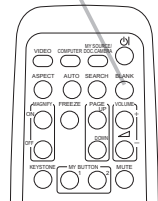

NOTE • The sound is not connected with the BLANK screen function. If necessary, set the volume or mute first. To display the BLANK screen and mute the sound at one time, use AV MUTE function (📖44).

Using the menu function

This projector has the following menus:

PICTURE, IMAGE, INPUT, SETUP, AUDIO, SCREEN, OPTION, SECURITY and EASY MENU.

EASY MENU consists of functions often used, and the other menus are classified into each purpose and brought together as the ADVANCED MENU.

Each of these menus is operated using the same methods. While the projector is displaying any menu, the **MENU** button on the projector works as the cursor buttons. The basic operations of these menus are as follows.

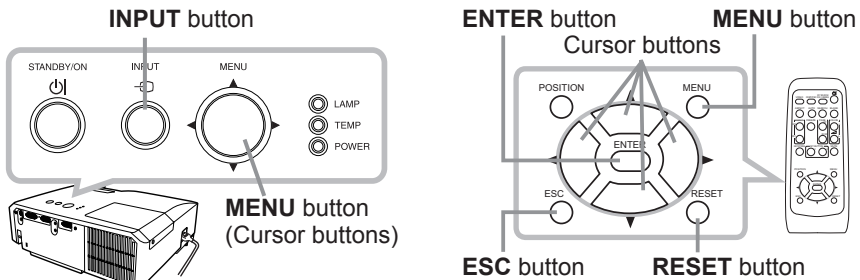

1. To start the MENU, press the **MENU** button. The MENU you last used (EASY or ADVANCED) will appear. EASY MENU has priority to appear just after powered on.

2. In the EASY MENU

- (1) Use the ▲/▼ cursor buttons to select an item to operate. If you want to change it to the ADVANCED MENU, select the ADVANCED MENU.
- (2) Use the ◀/▶ cursor buttons to operate the item.

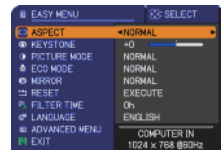

In the ADVANCED MENU

- (1) Use the ▲/▼ cursor buttons to select a menu. If you want to change it to the EASY MENU, select the EASY MENU. The items in the menu appear on the right side.
- (2) Press the ▶ cursor button or **ENTER** button to move the cursor to the right side. Then use the ▲/▼ cursor buttons to select an item to operate and press the ▶ cursor button or **ENTER** button to progress. The operation menu or dialog of the selected item will appear.
- (3) Use the buttons as instructed in the OSD to operate the item.



(continued on next page)

Using the menu function (continued)

3. To close the MENU, press the **MENU** button again or select EXIT and press the ◀ cursor button or **ENTER** button. Even if you do not do anything, the dialog will automatically disappear after about 30 seconds.
 - If you want to move the menu position, use the cursor buttons after pressing the **POSITION** button.
 - Some functions cannot be performed when a certain input port is selected, or when a certain input signal is displayed.
 - When you want to reset the operation, press **RESET** button on the remote control during the operation. Note that some items (ex. LANGUAGE, VOLUME) cannot be reset.
 - In the ADVANCED MENU, when you want to return to the previous display, press the ◀ cursor button or **ESC** button on the remote control.

Indication in OSD (On Screen Display)

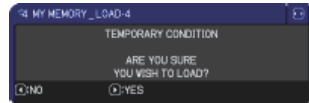
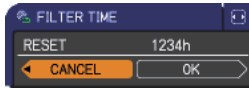

The meanings of the general words on the OSD are as follows.

Indication	Meaning
EXIT	Selecting this word finishes the OSD menu. It's the same as pressing the MENU button.
RETURN	Selecting this word returns the menu to the previous menu.
CANCEL or NO	Selecting this word cancels the operation in the present menu and returns to the previous menu.
OK or YES	Selecting this word executes the prepared function or shifts the menu to the next menu.

EASY MENU

From the EASY MENU, items shown in the table below can be performed.

Select an item using the ▲/▼ cursor buttons. Then perform it according to the following table.

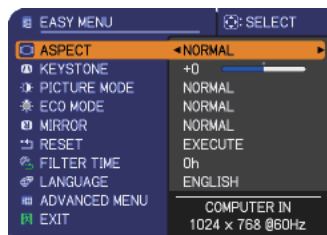

Item	Description																								
ASPECT	Using the ◀/▶ buttons switches the mode for aspect ratio. See the ASPECT item in IMAGE menu (📖29).																								
KEYSTONE	Using the ◀/▶ buttons corrects the vertical keystone distortion. See the KEYSTONE item in SETUP menu (📖34).																								
PICTURE MODE	<p>Using the ◀/▶ buttons switches the picture mode. The picture modes are combinations of GAMMA and COLOR TEMP settings. Choose a suitable mode according to the projected source.</p> <p> ↪ NORMAL ⇔ CINEMA ⇔ DYNAMIC ⇔ BOARD(BLACK) ↪ ↪ DAYTIME ⇔ WHITEBOARD ⇔ BOARD(GREEN) ↪ </p> <table border="1"> <thead> <tr> <th></th> <th>GAMMA</th> <th>COLOR TEMP</th> </tr> </thead> <tbody> <tr> <td>NORMAL</td> <td>1 DEFAULT</td> <td>2 MID</td> </tr> <tr> <td>CINEMA</td> <td>2 DEFAULT</td> <td>3 LOW</td> </tr> <tr> <td>DYNAMIC</td> <td>3 DEFAULT</td> <td>1 HIGH</td> </tr> <tr> <td>BOARD(BLACK)</td> <td>4 DEFAULT</td> <td>4 Hi-BRIGHT-1</td> </tr> <tr> <td>BOARD(GREEN)</td> <td>4 DEFAULT</td> <td>5 Hi-BRIGHT-2</td> </tr> <tr> <td>WHITEBOARD</td> <td>5 DEFAULT</td> <td>2 MID</td> </tr> <tr> <td>DAYTIME</td> <td>6 DEFAULT</td> <td>6 Hi-BRIGHT-3</td> </tr> </tbody> </table> <ul style="list-style-type: none"> • When the combination of GAMMA and COLOR TEMP differs from pre-assigned modes above, the display on the menu for the PICTURE MODE is "CUSTOM". Please refer to the GAMMA and COLOR TEMP (📖26, 27) items in PICTURE menu. • Lines or other noise might appear on the screen when this function is operated, but it is not a malfunction. 		GAMMA	COLOR TEMP	NORMAL	1 DEFAULT	2 MID	CINEMA	2 DEFAULT	3 LOW	DYNAMIC	3 DEFAULT	1 HIGH	BOARD(BLACK)	4 DEFAULT	4 Hi-BRIGHT-1	BOARD(GREEN)	4 DEFAULT	5 Hi-BRIGHT-2	WHITEBOARD	5 DEFAULT	2 MID	DAYTIME	6 DEFAULT	6 Hi-BRIGHT-3
	GAMMA	COLOR TEMP																							
NORMAL	1 DEFAULT	2 MID																							
CINEMA	2 DEFAULT	3 LOW																							
DYNAMIC	3 DEFAULT	1 HIGH																							
BOARD(BLACK)	4 DEFAULT	4 Hi-BRIGHT-1																							
BOARD(GREEN)	4 DEFAULT	5 Hi-BRIGHT-2																							
WHITEBOARD	5 DEFAULT	2 MID																							
DAYTIME	6 DEFAULT	6 Hi-BRIGHT-3																							

(continued on next page)

Item	Description
ECO MODE	Using the ◀/▶ buttons turns off/on the eco mode. See the ECO MODE item in SETUP menu (📖34).
MIRROR	Using the ◀/▶ buttons switches the mode for mirror status. See the MIRROR item in SETUP menu (📖34).
RESET	Performing this item resets all of the EASY MENU items except the FILTER TIME and LANGUAGE. A dialog is displayed for confirmation. Selecting the OK using the ▶ button performs resetting.
FILTER TIME	The usage time of the air filter is shown in the menu. Performing this item resets the filter time which counts usage time of the air filter. A dialog is displayed for confirmation. Selecting the OK using the ▶ button performs resetting. See the FILTER TIME item in OPTION menu (📖43).
LANGUAGE	Using the ◀/▶ buttons changes the display language. See the LANGUAGE item in SCREEN menu (📖37).
ADVANCED MENU	Press the ▶ or ENTER button to use the menu of PICTURE, IMAGE, INPUT, SETUP, AUDIO, SCREEN, OPTION or SECURITY.
EXIT	Press the ◀ or ENTER button to finish the OSD menu.

PICTURE menu

From the PICTURE menu, items shown in the table below can be performed.



Select an item using the ▲/▼ cursor buttons, and press the ► cursor button or **ENTER** button to execute the item. Then perform it according to the following table.

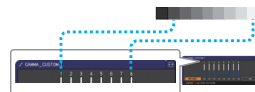

Item	Description
BRIGHTNESS	Using the ◀/▶ buttons adjusts the brightness. Dark ⇔ Light
CONTRAST	Using the ◀/▶ buttons adjusts the contrast. Weak ⇔ Strong
GAMMA	<p>Using the ▲/▼ buttons switches the gamma mode.</p> <p>1 DEFAULT ⇔ 1 CUSTOM ⇔ 2 DEFAULT ⇔ 2 CUSTOM ⇔ 3 DEFAULT ⇕ ⇕ 6 CUSTOM 3 CUSTOM ⇕ ⇕ 6 DEFAULT ⇔ 5 CUSTOM ⇔ 5 DEFAULT ⇔ 4 CUSTOM ⇔ 4 DEFAULT</p> <p>To adjust CUSTOM</p> <p>Selecting a mode whose name includes CUSTOM and then pressing the ► button or the ENTER button displays a dialog to aid you in adjusting the mode.</p> <p>This function is useful when you want to change the brightness of particular tones.</p> <p>Choose an item using the ◀/▶ buttons, and adjust the level using the ▲/▼ buttons.</p> <p>You can display a test pattern for checking the effect of your adjustment by pressing the ENTER button. Each time you press the ENTER button, the pattern changes as below.</p> <p>No pattern ⇔ Gray scale of 9 steps ⇐ ⇑ Ramp ⇔ Gray scale of 15 steps</p> <p>The eight equalizing bars correspond to eight tone levels of the test pattern (Gray scale of 9 steps) except the darkest in the left end. If you want to adjust the 2nd tone from left end on the test pattern, use the equalizing adjustment bar “1”. The darkest tone at the left end of the test pattern cannot be controlled with any of equalizing adjustment bar.</p> <ul style="list-style-type: none"> • Lines or other noise might appear on the screen when this function is operated, but it is not a malfunction.

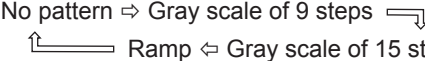

(continued on next page)

Item	Description
<p>COLOR TEMP</p>	<p>Using the ▲/▼ buttons switches the color temperature mode.</p> <p>1 HIGH ⇄ 1 CUSTOM ⇄ 2 MID ⇄ 2 CUSTOM ⇕ ⇕ 6 CUSTOM ⇄ 3 LOW ⇕ ⇕ 6 Hi-BRIGHT-3 ⇄ 3 CUSTOM ⇕ ⇕ 5 CUSTOM ⇄ 5 Hi-BRIGHT-2 ⇄ 4 CUSTOM ⇄ 4 Hi-BRIGHT-1</p> <p>To adjust CUSTOM</p> <p>Selecting a mode whose name includes CUSTOM and then pressing the ► button or the ENTER button displays a dialog to aid you in adjusting the OFFSET and GAIN of the selected mode.</p>  <p>OFFSET adjustments change the color intensity on the whole tones of the test pattern. GAIN adjustments mainly affect color intensity on the brighter tones of the test pattern.</p> <p>Choose an item using the ◀/▶ buttons, and adjust the level using the ▲/▼ buttons.</p> <p>You can display a test pattern for checking the effect of your adjustment by pressing the ENTER button. Each time you press the ENTER button, the pattern changes as below.</p> <p>No pattern ⇄ Gray scale of 9 steps ⇄ Ramp ⇄ Gray scale of 15 steps</p>  <ul style="list-style-type: none"> • Lines or other noise might appear on the screen when this function is operated, but it is not a malfunction. 
<p>COLOR</p>	<p>Using the ◀/▶ buttons adjusts the strength of whole color. Weak ⇄ Strong</p> <ul style="list-style-type: none"> • This item can be selected only for a video, s-video and component video signal.
<p>TINT</p>	<p>Using the ◀/▶ buttons adjusts the tint. Reddish ⇄ Greenish</p> <ul style="list-style-type: none"> • This item can be selected only for a video, s-video and component video signal.
<p>SHARPNESS</p>	<p>Using the ◀/▶ buttons adjusts the sharpness. Weak ⇄ Strong</p> <ul style="list-style-type: none"> • There may be some noise and/or the screen may flicker for a moment when an adjustment is made. This is not a malfunction.

(continued on next page)



Item	Description
<p>MY MEMORY</p>	<p>This projector has 4 memories for adjustment data (for all the items of the PICTURE menu). Selecting a function using the ▲/▼ buttons and pressing the ► or ENTER button performs each function.</p> <p style="text-align: center;">  </p> <p><u>SAVE-1, SAVE-2, SAVE-3, SAVE-4</u> Performing a SAVE function saves the current adjustment data into the memory linked in the number included in the function's name.</p> <ul style="list-style-type: none"> • Remember that the current data being stored of a memory will be lost by saving new data into the memory. <p><u>LOAD-1, LOAD-2, LOAD-3, LOAD-4</u> Performing a LOAD function loads the data from the memory linked in the number included in the function's name, and adjusts the picture automatically depending on the data.</p> <ul style="list-style-type: none"> • The LOAD functions whose linked memory has no data are skipped. • Remember that the current adjusted condition will be lost by loading data. If you want to keep the current adjustment, please save it before performing a LOAD function. • There may be some noise and the screen may flicker for a moment when loading data. This is not malfunction. • You can perform the LOAD function using MY BUTTONS. Please see MY BUTTON item in OPTION menu (44).

IMAGE menu

From the IMAGE menu, items shown in the table below can be performed.

Select an item using the ▲/▼ cursor buttons, and press the ► cursor button or **ENTER** button to execute the item. Then perform it according to the following table.

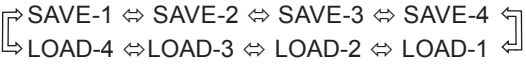
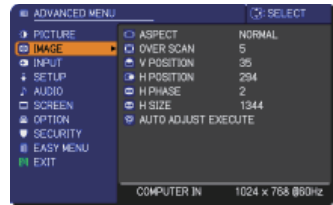

Item	Description
<p>ASPECT</p>	<p>Using the ▲/▼ buttons switches the mode for aspect ratio.</p> <p>For a computer signal NORMAL ⇔ 4:3 ⇔ 16:9 ⇔ 16:10 </p> <p>For a video signal, s-video signal or component video signal 4:3 ⇔ 16:9 ⇔ 14:9 </p> <p>For no signal 4:3 (fixed)</p> <ul style="list-style-type: none"> • The NORMAL mode keeps the original aspect ratio of the signal.
<p>OVER SCAN</p>	<p>Using the ◀/▶ buttons adjusts the over-scan ratio. Small (It magnifies picture) ⇔ Large (It reduces picture)</p> <ul style="list-style-type: none"> • This item can be selected only for a video, s-video and component video signal. • When this adjustment is too large, certain degradation may appear at the frame area of the picture. In such a case, please adjust small.
<p>V POSITION</p>	<p>Using the ◀/▶ buttons adjusts the vertical position. Down ⇔ Up</p> <ul style="list-style-type: none"> • Over-adjusting the vertical position may cause noise to appear on the screen. If this occurs, please reset the vertical position to the default setting. Pressing the RESET button when the V POSITION is selected will reset the V POSITION to the default setting. • When this function is performed on a video signal, s-video signal, or component video signal, the range of this adjustment depends on OVER SCAN (📖<i>above</i>) setting. It is not possible to adjust when OVER SCAN is set to 10.
<p>H POSITION</p>	<p>Using the ◀/▶ buttons adjusts the horizontal position. Left ⇔ Right</p> <ul style="list-style-type: none"> • Over-adjusting the horizontal position may cause noise to appear on the screen. If this occurs, please reset the horizontal position to the default setting. Pressing the RESET button when the H POSITION is selected will reset the H POSITION to the default setting. • When this function is performed on a video signal, s-video signal, or component video signal, the range of this adjustment depends on OVER SCAN (📖<i>above</i>) setting. It is not possible to adjust when OVER SCAN is set to 10.

(continued on next page)

Item	Description
<p>H PHASE</p>	<p>Using the ◀/▶ buttons adjusts the horizontal phase to eliminate flicker. Right ⇔ Left</p> <ul style="list-style-type: none"> • This item can be selected only for a computer signal or a component video signal.
<p>H SIZE</p>	<p>Using the ◀/▶ buttons adjusts the horizontal size. Small ⇔ Large</p> <ul style="list-style-type: none"> • This item can be selected only for a computer signal. • When this adjustment is excessive, the picture may not be displayed correctly. In such a case, please reset the adjustment by pressing the RESET button on the remote control during this operation. • Images might appear degraded when this function is operated, but it is not a malfunction.
<p>AUTO ADJUST EXECUTE</p>	<p>Selecting this item performs the automatic adjustment feature.</p> <p>For a computer signal The vertical position, the horizontal position and the horizontal phase will be automatically adjusted. Make sure that the application window is set to its maximum size prior to attempting to use this feature. A dark picture may still be incorrectly adjusted. Use a bright picture when adjusting.</p> <p>For a video signal and s-video signal The video format best suited for the respective input signal will be selected automatically. This function is available only when the AUTO is selected for the VIDEO FORMAT item in the INPUT menu (📖32). The vertical position and horizontal position will be automatically set to the default.</p> <p>For a component video signal The vertical position, horizontal position and horizontal phase will be automatically set to the default.</p> <ul style="list-style-type: none"> • The automatic adjustment operation requires approx. 10 seconds. Also please note that it may not function correctly with some input. • When this function is performed for a video signal, a certain extra such as a line may appear outside a picture. • When this function is performed for a computer signal, a black frame may be displayed on the edge of the screen, depending on the PC model. • The items adjusted by this function may vary when the FINE or DISABLE is selected for the AUTO ADJUST item of the SERVICE item in the OPTION menu (📖45).

INPUT menu



From the INPUT menu, items shown in the table below can be performed.

Select an item using the ▲/▼ cursor buttons, and press the ► cursor button or **ENTER** button to execute the item. Then perform it according to the following table.





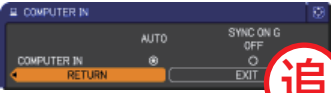

Item	Description
<p>PROGRESSIVE</p>	<p>Using the ▲/▼ buttons switches the progress mode.</p> <p>TV ⇄ FILM ⇄ OFF</p> <p style="text-align: center;">↑—————↑</p> <ul style="list-style-type: none"> • This function is performed only for the VIDEO or S-VIDEO input, and for 480i@60 or 576i@50 signal at the COMPUTER IN input. • When TV or FILM is selected, the screen image will be sharp. FILM adapts to the 2-3 Pull-Down conversion system. But these may cause a certain defect (for example, jagged line) of the picture for a quick moving object. In such a case, please select OFF, even though the screen image may lose sharpness.
<p>VIDEO NR</p>	<p>Using the ▲/▼ buttons switches the noise reduction mode.</p> <p>HIGH ⇄ MID ⇄ LOW</p> <p style="text-align: center;">↑—————↑</p> <ul style="list-style-type: none"> • This function is performed only for the VIDEO or S-VIDEO input, and for 480i@60 or 576i@50 signal at the COMPUTER IN input. • When this function is excessive, it may cause a certain degradation of the picture.
<p>COLOR SPACE</p>	<p>Using the ▲/▼ buttons switches the mode for color space.</p> <p>AUTO ⇄ RGB ⇄ SMPTE240 ⇄ REC709 ⇄ REC601</p> <p style="text-align: center;">↑—————↑</p> <ul style="list-style-type: none"> • This item can be selected only for a computer signal or a component video signal. • The AUTO mode automatically selects the optimum mode. • The AUTO operation may not work well at some signals. In such a case, it might be good to select a suitable mode except AUTO.

(continued on next page)

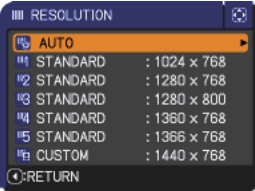
Item	Description
<p>VIDEO FORMAT</p>	<p>The video format for S-VIDEO port and VIDEO port can be set.</p> <p>(1) Use the 追 buttons to select the input port. S-VIDEO ↔ VIDEO</p> <p>(2) Using the ◀/▶ buttons switches the mode for video format. AUTO ↔ NTSC ↔ PAL ↔ SECAM ↕ N-PAL ↔ M-PAL ↔ NTSC4.43 ↕</p> <p>• This item is performed only for a video signal from the VIDEO port or the S-VIDEO port. • The AUTO mode automatically selects the optimum mode. • The AUTO operation may not work well for some signals. If the picture becomes unstable (e.g. an irregular picture, lack of color), please select the mode according to the input signal.</p> 
<p>COMPUTER IN</p>	<p>Use the ◀/▶ buttons to select the computer input signal type. AUTO ↔ SYNC ON G OFF</p> <p>• Selecting the AUTO mode allows you to input a sync on G signal or component signal from the port. • In the AUTO mode, the picture may be distorted with certain input signals. In such a case, remove the signal connector so that no signal is received and select the SYNC ON G OFF, and then reconnect the signal.</p> 
<p>FRAME LOCK</p>	<p>Use the ◀/▶ buttons to turn the frame lock function on/off. ON ↔ OFF</p> <p>• This item can be performed only on a signal with a vertical frequency of 49 to 51Hz, 59 to 61 Hz. • When ON is selected, moving pictures are displayed more smoothly. • This function may cause a certain degradation of the picture. In such a case, please select OFF.</p> 

(continued on next page)

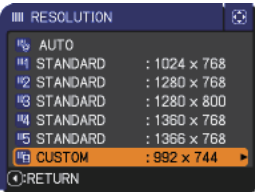

Item	Description
<p>RESOLUTION</p>	<p>The resolution for the COMPUTER IN input signals can be set on this projector.</p> <p>(1) In the INPUT menu select the RESOLUTION using the ▲/▼ buttons and press the ► button. The RESOLUTION menu will be displayed.</p>  <p>(2) In the RESOLUTION menu select the resolution you wish to display using the ▲/▼ buttons. Selecting AUTO will set a resolution appropriate to the input signal.</p> <p>(3) Pressing the ► or ENTER button when selecting a STANDARD resolution will automatically adjust the horizontal vertical positions, clock phase and horizontal size. The INPUT_INFORMATION dialog (46) will be displayed.</p>  <p>(4) To set a custom resolution use the ▲/▼ buttons to select the CUSTOM and the RESOLUTION_CUSTOM box will be displayed. Set the horizontal (HORZ) and vertical (VERT) resolutions using the ▲/▼/◀/▶ buttons. This function is may not support all resolutions.</p>  <p>(5) Move the cursor to OK on screen and press the ► or ENTER button. The message “ARE YOU SURE YOU WISH TO CHANGE RESOLUTION?” appears. To save the setting, press the ► button. The horizontal and vertical positions, clock phase and horizontal size will be automatically adjusted. After the INPUT_INFORMATION dialog has displayed for about 10 seconds the screen will return to the RESOLUTION menu displaying the changed resolution.</p>  <p>(6) To revert back to the previous resolution without saving changes, move the cursor to CANCEL on screen and press the ◀ or ENTER button. The screen will then return to the RESOLUTION menu displaying the previous resolution.</p>  <ul style="list-style-type: none"> • For some pictures, this function may not work well.

SETUP menu

From the SETUP menu, items shown in the table below can be performed.

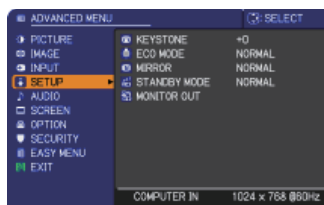
Select an item using the ▲/▼ cursor buttons, and press the ► cursor button or **ENTER** button to execute the item. Then perform it according to the following table.



Item	Description
KEYSTONE	Using the ◀/▶ buttons corrects the vertical keystone distortion. Shrink the bottom of the image ⇔ Shrink the top of the image • The adjustable range of this function will vary among inputs. For some input, this function may not work well.
ECO MODE	Using the ▲/▼ buttons turns off/on the eco mode. 変 NORMAL ⇔ ECO • When the ECO is selected, acoustic noise and screen brightness are reduced.
MIRROR	Using the ▲/▼ buttons switches the mode for mirror status.  NORMAL ⇔ H:INVERT ⇔ V:INVERT ⇔ H&V:INVERT 

(continued on next page)

Item	Description
<p>STANDBY MODE</p>	<p>Using ▲/▼ buttons switches the standby mode setting between NORMAL and SAVING. NORMAL ⇄ SAVING</p> <p>When SAVING is selected, the power consumption in the standby mode is lowered with some functional restriction as below:</p> <ul style="list-style-type: none"> • When SAVING is selected, AUDIO OUT STANDBY setting of AUDIO SOURCE (▶▶▶36) is invalid, and no signal is output from AUDIO OUT port in the standby mode.
<p>MONITOR OUT</p>	<p>The combination of a picture shown on screen and output from the MONITOR OUT port can be arranged in the menu.</p> <p>(1) Choose a picture input port using ▲/▼ buttons.</p> <p style="text-align: center;">COMPUTER IN ⇄ S-VIDEO ⇕ ⇕ STANDBY ⇄ VIDEO</p> <ul style="list-style-type: none"> • Choose STANDBY, to select the output signal from the MONITOR OUT port in the standby mode. <p>(2) Select the output signal from the MONITOR OUT port using ◀/▶ buttons.</p> <p style="text-align: center;">COMPUTER IN ⇄ OFF</p> <ul style="list-style-type: none"> • OFF disables the MONITOR OUT port. 

AUDIO menu

From the AUDIO menu, items shown in the table below can be performed. Select an item using the ▲/▼ cursor buttons, and press the ► cursor button or the **ENTER** button to execute the item. Then perform it according to the following table.



Item	Description
VOLUME	Using the ▲/▼ buttons adjusts the volume. High ⇔ Low
SPEAKER	Using the ▲/▼ buttons turns on/off the built-in speaker. ON ⇔ OFF When OFF is selected, the built-in speaker does not work.
AUDIO SOURCE	<p>The combination of a picture and audio input port can be arranged in the menu. The audio coming into the port selected in the (2) is output while an image from the port chosen in the (1) is on screen.</p> <p>(1) Choose a picture input port using the ▲/▼ buttons.</p> <div style="text-align: center;"> <p>COMPUTER IN ⇔ S-VIDEO</p> <p>⇕ ⇕</p> <p>AUDIO OUT STANDBY ⇔ VIDEO</p> </div> <p>• Choose AUDIO OUT STANDBY, to select the audio output to the AUDIO OUT port in the standby mode. The built-in speaker does not work in the standby mode.</p> <p>• While RETURN is selected, pressing the ◀ button returns to the previous menu.</p> <p>(2) Select the output signal from the AUDIO OUT port using ◀/▶ buttons.</p> <div style="text-align: center;"> <p>AUDIO IN ⇔ ✕</p> </div> <p>• ✕ disables the audio output.</p> <p>• C.C. (Closed Caption) is automatically activated when ✕ is selected and an input signal containing C.C. is received. This function is available only when the signal is NTSC for VIDEO or S-VIDEO, or 480i@60 for COMPUTER IN and when AUTO is selected for DISPLAY in the C.C. menu under the SCREEN menu (📖41).</p>



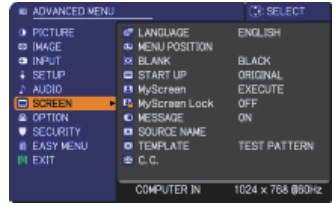

SCREEN menu

From the SCREEN menu, items shown in the table below can be performed. Select an item using the ▲/▼ cursor buttons, and press the ► cursor button or **ENTER** button to execute the item. Then perform it according to the following table.



Item	Description
<p>LANGUAGE</p>	<p>Using the ▲/▼/◀/▶ buttons switches the OSD (On Screen Display) language. ENGLISH ⇄ FRANÇAIS ⇄ DEUTSCH ⇄ ESPAÑOL ⤴ (shown in the LANGUAGE dialog) ⤵ Press the ENTER or INPUT button to save the language setting.</p>
<p>MENU POSITION</p>	<p>Using the ▲/▼/◀/▶ buttons adjusts the menu position. To quit the operation, press the MENU button on the remote control or keep no operation for about 10 seconds.</p>
<p>BLANK</p>	<p>Using the ▲/▼ buttons switches the mode for the blank screen. The blank screen is a screen for the temporarily blanking feature (📖21). It is displayed by pressing the BLANK button on the remote control. MyScreen ⇄ ORIGINAL ⇄ BLUE ⇄ WHITE ⇄ BLACK ⤴—————⤵ <u>MyScreen</u> : Screen can be registered by the MyScreen item (📖38). <u>ORIGINAL</u> : Screen preset as the standard screen. <u>BLUE, WHITE, BLACK</u> : Plain screens in each color. • To avoid remaining as an afterimage, the MyScreen or ORIGINAL screen will change to the plain black screen after several minutes.</p>
<p>START UP</p>	<p>Using the ▲/▼ buttons switches the mode for the start-up screen. The start-up screen is a screen displayed when no signal or an unsuitable signal is detected. MyScreen ⇄ ORIGINAL ⇄ OFF ⤴—————⤵ <u>MyScreen</u> : Screen can be registered by the MyScreen item (📖38). <u>ORIGINAL</u> : Screen preset as the standard screen. <u>OFF</u> : Plain black screen. • To avoid remaining as an afterimage, the MyScreen or ORIGINAL screen will change to the BLANK screen (📖21) after several minutes. If also the BLANK screen is the MyScreen or ORIGINAL, the plain black screen is instead used. • When the ON is selected to the MyScreen PASSWORD item in the SECURITY menu (📖48), the START UP is fixed to MyScreen.</p>

(continued on next page)

Item	Description
<p>MyScreen</p>	<p>This item allows you to capture an image for use as a MyScreen image which can be used as the BLANK screen and START UP screen. Display the image you want to capture before executing the following procedure.</p> <ol style="list-style-type: none"> <p>1. Selecting this item displays a dialog titled "MyScreen". It will ask you if you start capturing an image from the current screen.</p>  <p>Please wait for the target image to be displayed, and press the ENTER or INPUT button when the image is displayed. The image will freeze and the frame for capturing will appear.</p> <p>To stop performing, press the RESET button on the remote control.</p> <p>2. Using the ▲/▼/◀/▶ buttons adjusts the frame position.</p>  <p>Please move the frame to the position of the image which you want to use. The frame may not be able to be moved for some input signals.</p>  <p>To start registration, press the ENTER or INPUT button on the remote control.</p> <p>To restore the screen and return to the previous dialog, press the RESET button on the remote control.</p> <p>Registration takes several minutes.</p> <p>When the registration is completed, the registered screen and the following message is displayed for several seconds:</p> <p>"MyScreen registration is finished."</p> <p>If the registration failed, the following message is displayed:</p> <p>"A capturing error has occurred. Please try again."</p> <ul style="list-style-type: none"> • This function cannot be selected when the ON is selected to the MyScreen Lock item (🔒39). • This function cannot be selected when the ON is selected to the MyScreen PASSWORD item in SECURITY menu (🔒48).

(continued on next page)

Item	Description
MyScreen Lock	<p>Using the ▲/▼ buttons turns on/off the MyScreen lock function. ON ⇔ OFF</p> <p>When the ON is selected, the item MyScreen is locked. Use this function for protecting the current MyScreen.</p> <ul style="list-style-type: none"> • This function cannot be selected when the ON is selected to the MyScreen PASSWORD item in SECURITY menu (📖48).
MESSAGE	<p>Using the ▲/▼ buttons turns on/off the message function. ON ⇔ OFF</p> <p>When the ON is selected, the following message function works.</p> <p>“AUTO IN PROGRESS” while automatically adjusting “NO INPUT IS DETECTED” “SYNC IS OUT OF RANGE” “INVALID SCAN FREQ” “NOT AVAILABLE” “Searching....” while searching for the input “Detecting....” while an input signal is detected</p> <p>The indication of the input signal displayed by changing The indication of the aspect ratio displayed by changing The indication of the PICTURE MODE displayed by changing The indication of the MY MEMORY displayed by changing The indication of “FREEZE” and “II” while freezing the screen by pressing the FREEZE button. The indication of the TEMPLATE displayed by changing.</p> <ul style="list-style-type: none"> • When the OFF is selected, please remember if the picture is frozen. Do not mistake freezing for a malfunction (📖21).

(continued on next page)

Item	Description
<p>SOURCE NAME</p>	<p>Each input port for this projector can have a name applied to it.</p> <p>(1) Use the ▲/▼ buttons on the SCREEN menu to select SOURCE NAME and press the ► or ENTER button. The SOURCE NAME menu will be displayed.</p> <p>(2) Use the ▲/▼ buttons on the SOURCE NAME menu to select the port to be named and press the ► button. Right side of the menu is blank until a name is specified. The SOURCE NAME dialog will be displayed.</p> <p>(3) The current name will be displayed on the first line. Use the ▲/▼/◀/▶ buttons and the ENTER or INPUT button to select and enter characters. The RESET button can be used to erase 1 character at a time. Also if you move the cursor to DELETE or ALL CLEAR on screen and press the ENTER or INPUT button, 1 character or all characters will be erased. The name can be a maximum of 16 characters.</p> <p>(4) To change an already inserted character, press the ▲ button to move the cursor to the first line, and use the ◀/▶ buttons to move the cursor on the character to be changed. After pressing the ENTER or INPUT button, the character is selected. Then, follow the same procedure as described at the item (3) above.</p> <p>(5) To finish entering text, move the cursor to the OK on screen and press the ENTER or INPUT button. To revert to the previous name without saving changes, move the cursor to the CANCEL on screen and press the ENTER or INPUT button.</p>
<p>TEMPLATE</p>	<p>Using the ▲/▼ buttons switches the mode for the template screen. Press the ► button to display the selected template, and press the ◀ button to close the displayed screen. The last selected template is displayed when the MY BUTTON allocated to the TEMPLATE function is pressed (44).</p> <p>  TEST PATTERN ⇄ DOT-LINE1 ⇄ DOT-LINE4 ⇄ DOT-LINE3 ⇄ DOT-LINE2 </p>

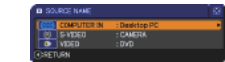

(continued on next page)

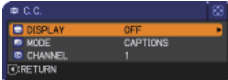
Item	Description
<p style="text-align: center;">C.C. (Closed Caption)</p>	<p>The C.C. is the function that displays a transcript or dialog of the audio portion of a video, files or other presentation or other relevant sounds. It is required to have NTSC format video or 480i@60 format component video source supporting C.C. feature to utilize this function.</p> <p>It may not work properly, depending on equipment or signal source. In this case, please turn off the Closed Caption.</p> 
	<p>DISPLAY</p> <p>Select Closed Caption DISPLAY setting from following options using ▲/▼ buttons.</p> <p style="text-align: center;">AUTO ⇔ ON ⇔ OFF</p> <p style="text-align: center;">↑—————↓</p> <p><u>AUTO</u> : Closed Caption automatically displays when the volume is muted.</p> <p><u>ON</u> : Closed Caption is on</p> <p><u>OFF</u> : Closed Caption is off</p> <ul style="list-style-type: none"> • The caption is not displayed when the OSD menu is active. • The Closed Caption is the function to display the dialogue, narration, and / or sound effects of a television program or other video sources. The Closed Caption availability is depending upon broadcaster and/or content.
	<p>MODE</p> <p>Select Closed Caption MODE setting from following options using ▲/▼ buttons.</p> <p style="text-align: center;">CAPTIONS ⇔ TEXT</p> <p><u>CAPTIONS</u> : Display Closed Caption</p> <p><u>TEXT</u> : Display Text data, which is for additional information such as news reports or a TV program guide. The information covers the entire screen. Not all of the C.C. program has Text information.</p>
	<p>CHANNEL</p> <p>Select Closed Caption CHANNEL from following options using ▲/▼ buttons.</p> <p style="text-align: center;">1 ⇔ 2 ⇔ 3 ⇔ 4</p> <p style="text-align: center;">↑—————↓</p> <p><u>1</u>: Channel 1, primary channel / language</p> <p><u>2</u>: Channel 2</p> <p><u>3</u>: Channel 3</p> <p><u>4</u>: Channel 4</p> <p>The channel data may vary, depending on the content. Some channel might be used for secondary language or empty.</p>

OPTION menu



From the OPTION menu, items shown in the table below can be performed.

Select an item using the ▲/▼ cursor buttons, and press the ► cursor button or **ENTER** button to execute the item, except for the items LAMP TIME and FILTER TIME. Then perform it according to the following table



Item	Description
<p>AUTO SEARCH</p>	<p>Using the ▲/▼ buttons turns on/off the automatic signal search function.</p> <p>ON ⇄ OFF</p> <p>When the ON is selected, detecting no signal automatically cycles through input ports in the following order. The search is started from the current port. Then when an input is found, the projector will stop searching and display the image.</p> <p>COMPUTER IN ⇄ S-VIDEO ⇄ VIDEO</p> <p style="text-align: center;">↑—————↓</p>
<p>DIRECT ON</p>	<p>Using the ▲/▼ buttons turns on/off the DIRECT ON function.</p> <p>ON ⇄ OFF</p> <p>When set to the ON, the lamp in projector will be automatically turned on without the usual procedure (14), only when the projector is supplied with the power after the power was cut while the lamp was on.</p> <ul style="list-style-type: none"> • This function does not work as long as the power has been supplied to the projector while the lamp is off. • After turning the lamp on by the DIRECT ON function, if neither input nor operation is detected for about 30 minutes, the projector is turned off, even though the AUTO OFF function (43) is disabled.



(continued on next page)



Item	Description
<p>AUTO OFF</p>	<p>Using the ▲/▼ buttons adjusts the time to count down to automatically turn the projector off. Long (max. 99 minutes) ⇔ Short (min. 0 minute = DISABLE)</p> <div style="display: flex; justify-content: space-around; align-items: center;">   </div> <p>When the time is set to 0, the projector is not turned off automatically. When the time is set to 1 to 99, and when the passed time with no-signal or an unsuitable signal reaches at the set time, the projector lamp will be turned off. If one of the projector's buttons or the remote control buttons is pressed during the corresponding time, projector will not be turned off. Please refer to the section "Turning off the power" (14).</p>
<p>LAMP TIME</p>	<p>The lamp time is the usage time of the lamp, counted after the last resetting. It is shown in the OPTION menu. Pressing the RESET button on the remote control or the ► button of the projector displays a dialog. To reset the lamp time, select the OK using the ► button. CANCEL ⇔ OK</p> <ul style="list-style-type: none"> • Please reset the lamp time only when you have replaced the lamp, for a suitable indication about the lamp. • For the lamp replacement, see the section "Replacing the lamp" (52, 53).
<p>FILTER TIME</p>	<p>The filter time is the usage time of the air filter, counted after the last resetting. It is shown in the OPTION menu. Pressing the RESET button on the remote control or the ► button of the projector displays a dialog. To reset the filter time, select the OK using the ► button. CANCEL ⇔ OK</p> <ul style="list-style-type: none"> • Please reset the filter time only when you have cleaned or replaced the air filter, for a suitable indication about the air filter. • For the air filter cleaning, see the section "Cleaning and replacing the air filter" (54, 55).

(continued on next page)

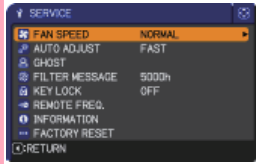
Item	Description
<p>MY BUTTON</p>	<p>This item is to assign one of the following functions to MY BUTTON 1/2 on the remote control (📄6).</p> <p>(1) Use the ▲/▼ buttons on the MY BUTTON menu to select a MY BUTTON - (1/2) and press the ► button to display the MY BUTTON setup dialog.</p> <p>(2) Then using the ▲/▼/◀/▶ buttons sets one of the following functions to the chosen button. Press the ENTER or INPUT button to save the setting.</p> <ul style="list-style-type: none"> • COMPUTER IN: Sets port to COMPUTER IN. • S-VIDEO: Sets port to S-VIDEO. • VIDEO: Sets port to VIDEO. • INFORMATION: Displays the INPUT_INFORMATION (📄46) or the SYSTEM_INFORMATION or nothing. • MY MEMORY: Loads one of adjustment data stored (📄28). When more than one data are saved, the adjustment changes every time the MY BUTTON is pressed. When no data is saved in memory, the dialog “No saved data” appears. When the current adjustment is not saved to memory, the dialog as shown in the right appears. <p>If you want to keep the current adjustment, please press the ► button to exit. Otherwise loading a data will overwrite the current adjusted condition.</p> <ul style="list-style-type: none"> • PICTURE MODE: Changes the PICTURE MODE (📄24). • FILTER RESET: Displays the filter time reset confirmation dialogue (📄43). • TEMPLATE: Makes the template pattern selected to the TEMPLATE item (📄40) appear or disappear. • AV MUTE: Turns the picture and audio on/off.
<p>MY SOURCE</p>	<p>Using ▲/▼ buttons selects the picture input port to be selected with pressing the MY SOURCE/DOC.CAMERA button on the remote control.</p> <p>Select the picture input that is connected with a document camera.</p> <p>COMPUTER IN ↔ S-VIDEO ↔ VIDEO</p> <p style="text-align: center;">↑—————↑</p>

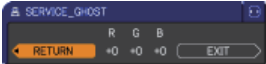

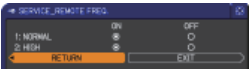
Item	Description
SERVICE	<p>Selecting this item displays the SERVICE menu. Select an item using the ▲/▼ buttons, and press the ► button or the ENTER button on the remote control to execute the item.</p> 
	<p>FAN SPEED Using the ▲/▼ buttons switches the rotation speed of the cooling fans. The HIGH is the mode for use at highlands etc. Note that the projector is noisier when the HIGH is selected. HIGH ⇄ NORMAL</p>
	<p>AUTO ADJUST Using the ▲/▼ buttons to select one of the mode. When the DISABLE is selected, the automatic adjustment feature is disabled. FINE ⇄ FAST ⇄ DISABLE  <u>FINE</u>: Finer tuning including H.SIZE adjustment. <u>FAST</u>: Faster tuning, setting H.SIZE to prearranged data for the input signal.</p> <ul style="list-style-type: none"> Depending on conditions, such as input image, signal cable to the projector, environment around the projector, etc., the automatic adjustment may not work correctly. In such a case, please choose DISABLE to disable the automatic adjustment, and make adjustment manually.
	<p>GHOST</p> <ol style="list-style-type: none"> Select a color element of ghost using the ◀/▶ buttons. Adjust the selected element using the ▲/▼ buttons to disappear ghost. 
	<p>FILTER MESSAGE Use the ▲/▼ button to set the timer for notifying by the message when to replace the filter unit 100h ⇄ 200h ⇄ 500h ⇄ 1000h ⇄ 2000h ⇄ 5000h ⇄ OFF After choosing an item except OFF, the message “REMINDER *** HRS PASSED AFTER THE LAST FILTER CHANGE” will appear after the timer reaches the interval time set by this feature (p.57). When the OFF is chosen, the message will not appear. Utilize this feature to keep the air filter clean, setting the suitable time according to your environment of this projector.</p> <ul style="list-style-type: none"> Please take care of the filter unit periodically, even if there is no message. If the air filter becomes to be blocked by dust or other matter, the internal temperature will rise, which could cause malfunction, or reduce the lifetime of the projector. Please be careful with the operating environment of the projector and the condition of the filter unit.

Item	Description
<p>SERVICE (continued)</p>	<p>KEY LOCK Using the ▲/▼ buttons turns on/off the key lock feature. When ON is selected, the buttons on the projector except the STANDBY/ON button are locked.</p> <p>変 ON ⇄ OFF</p> <ul style="list-style-type: none"> • Please use this function to prevent tampering or accidental operation. This function does not have any effect on the remote control.
	<p>REMOTE FREQ. (1) Use the ▲/▼ button to change the projector's remote sensor frequency setting (M4).</p> <p>変 1:NORMAL ⇄ 2:HIGH</p> <p>(2) Use the ◀/▶ button to change the projector's remote sensor on or off.</p> <p>変 ON ⇄ OFF</p> <p>The factory default setting is for both 1:NORMAL and 2:HIGH to be on. If the remote control does not function correctly, set this to either only 1 or only 2 as described in Remote Control Settings (M13).</p> <p>Neither can be turned off at the same time.</p> 
	<p>INFORMATION Selecting this item displays a dialog titled "INPUT_INFORMATION". It shows the information about the current input.</p>   <ul style="list-style-type: none"> • The "FRAME LOCK" message on the dialog means the frame lock function is working. • This item can't be selected for no signal and sync out. • When the MY TEXT DISPLAY is set to ON, the MY TEXT is displayed together with the input information in the INPUT_INFORMATION box (M51).
	<p>FACTORY RESET Selecting OK using the ► button performs this function. By this function, all the items in all of menus will collectively return to the initial setting. Note that the items LAMP TIME, FILTER TIME, LANGUAGE, FILTER MESSAGE and SECURITY settings are not reset.</p> <p>変 CANCEL ⇄ OK</p>

SECURITY menu

This projector is equipped with security functions. From the SECURITY menu, items shown in the table below can be performed.

To use SECURITY menu: User registration is required before using the security functions.



Enter the SECURITY menu

1. Use the ▲/▼ buttons on the SECURITY menu to select ENTER PASSWORD and press the ► button. The ENTER PASSWORD box will be displayed.
2. Use the ▲/▼/◀/▶ buttons to enter the registered password. The factory default password is **9776**. This password can be changed (SECURITY PASSWORD CHANGE). Move the cursor to the right side of the ENTER PASSWORD box and press the ► button to display the SECURITY menu.
 - It is strongly recommended the factory default password to be changed as soon as possible.
 - If an incorrect password is input, the ENTER PASSWORD box will be displayed again. If incorrect password is input 3 times, the projector will turn off. Afterwards the projector will turn off every time an incorrect password is input.
3. Items shown in the table below can be performed.



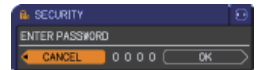
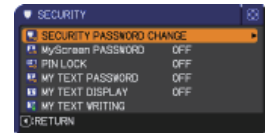
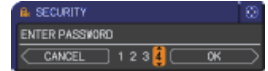

If you have forgotten your password

- (1). While the ENTER PASSWORD box is displayed, press and hold the **RESET** button on the remote control for about 3 seconds or press and hold the **INPUT** button for 3 seconds while pressing the ► button on the projector.
- (2). The 10 digit Inquiring Code will be displayed. Contact your dealer with the 10 digit Inquiring Code. Your password will be sent after your user registration information is confirmed.
 - If there is no key input for about 55 seconds while the Inquiring Code is displayed, the menu will close. If necessary, repeat the process from (1).

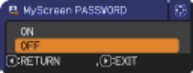

Item	Description
<p>SECURITY PASSWORD CHANGE</p>	<ol style="list-style-type: none"> (1) Use the ▲/▼ buttons on the SECURITY menu to select SECURITY PASSWORD CHANGE and press the ► button to display the ENTER NEW PASSWORD box.  (2) Use the ▲/▼/◀/▶ buttons to enter the new password. (3) Move the cursor to the right side of the ENTER NEW PASSWORD box and press the ► button to display the NEW PASSWORD AGAIN box, enter the same password again.  (4) Move the cursor to the right side of the NEW PASSWORD AGAIN box and press the ► button and the NOTE NEW PASSWORD box will be displayed for about 20 seconds, please make note of the password during this time. Pressing the ENTER button on the remote control or ► button on the projector will close the NOTE NEW PASSWORD box.  <ul style="list-style-type: none"> • Please do not forget your password.



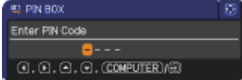
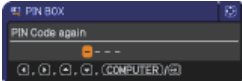
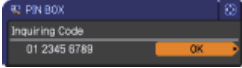

(continued on next page)

Item	Description
<p>MyScreen PASSWORD</p>	<p>The MyScreen PASSWORD function can be used to prohibit access to the MyScreen function and prevent the currently registered MyScreen image from being overwritten.</p> <p>1 Turning on the MyScreen PASSWORD</p> <p>1-1 Use the ▲/▼ buttons on the SECURITY menu to select MyScreen PASSWORD and press the ► button to display the MyScreen PASSWORD on/off menu.</p> <p>1-2 Use the ▲/▼ buttons on the MyScreen PASSWORD on/off menu to select ON. The ENTER NEW PASSWORD box (small) will be displayed.</p> <p>1-3 Use the ▲/▼/◀/▶ buttons to enter the password. Move the cursor to the right side of the ENTER NEW PASSWORD box (small) and press the ► button to display the NEW PASSWORD AGAIN box, enter the same PASSWORD again.</p> <p>1-4 Move the cursor to the right side of the NEW PASSWORD AGAIN box and press the ► button to display the NOTE NEW PASSWORD box for about 20 seconds, please make note of the password during this time.</p> <p>Pressing the ENTER button on the remote control or ► button on the projector will return to MyScreen PASSWORD on/off menu.</p> <p>When a password is set for MyScreen:</p> <ul style="list-style-type: none"> • The MyScreen registration function (and menu) will be unavailable. • The MyScreen Lock menu will be unavailable. • The START UP setting will be locked on MyScreen (and the menu will be unavailable). <p>Turning the MyScreen PASSWORD off will allow normal operation of these functions.</p> <ul style="list-style-type: none"> • Please do not forget your MyScreen PASSWORD. <p>2 Turning off the MyScreen PASSWORD</p> <p>2-1 Follow the procedure in 1-1 to display the MyScreen PASSWORD on/off menu.</p> <p>2-2 Select OFF to display the ENTER PASSWORD box (large). Enter the registered password and the screen will return to the MyScreen PASSWORD on/off menu.</p> <p>If an incorrect PASSWORD is input, the menu will close. If necessary, repeat the process from 2-1.</p> <p>3 If you have forgotten your password</p> <p>3-1 Follow the procedure in 1-1 to display the MyScreen PASSWORD on/off menu.</p> <p>3-2 Select OFF to display the ENTER PASSWORD box (large). The 10 digit Inquiring Code will be displayed inside the box.</p> <p>3-3 Contact your dealer with the 10 digit Inquiring Code. Your password will be sent after your user registration information is confirmed.</p>
	    



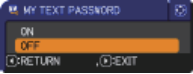

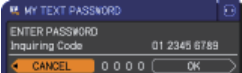

(continued on next page)

Item	Description
PIN LOCK	<p>PIN LOCK is a function which prevents the projector from being used unless a registered Code is input.</p> <p>1 Turning on the PIN LOCK</p> <p>1-1 Use the ▲/▼ buttons on the SECURITY menu to select PIN LOCK and press the ► button or the ENTER button to display the PIN LOCK on/off menu.</p>  <p>1-2 Use the ▲/▼ buttons on the PIN LOCK on/off menu to select ON and the Enter PIN Code box will be displayed.</p>  <p>1-3 Input a 4 part PIN code using the ▲/▼/◀/▶, COMPUTER or INPUT button. The PIN Code again box will appear. Reenter the same PIN code. This will complete the PIN code registration.</p>  <ul style="list-style-type: none"> • If there is no key input for about 55 seconds while the Enter PIN Code box or the PIN Code again box is displayed, the menu will close. If necessary, repeat the process from 1-1. <p>Afterwards, anytime the projector is restarted after AC power is turned off the Enter PIN Code box will be displayed. Enter the registered PIN code. The projector can be used after entering the registered PIN code. If an incorrect PIN code is input, the Enter PIN code box will be displayed again. If an incorrect PIN Code is input 3 times, the projector will turn off. Afterwards the projector will turn off every time an incorrect PIN code is input. The projector will also turn off if there is no key input for about 5 minutes while the Enter PIN code box is displayed. This function will activate only when the projector is started after AC power is turned off.</p> <ul style="list-style-type: none"> • Please do not forget your PIN code. <p>2 Turning off the PIN LOCK</p> <p>2-1 Follow the procedure in 1-1 to display the PIN LOCK on/off menu.</p> <p>2-2 Use the ▲/▼ buttons to select OFF and the Enter PIN Code box will be displayed. Enter the registered PIN code to turn the PIN LOCK function off. If an incorrect PIN Code is input 3 times, the menu will close.</p> <p>3 If you have forgotten your PIN Code</p> <p>3-1 While the Enter PIN Code box is displayed, press and hold the RESET button for three seconds or press and hold the INPUT button for 3 seconds while pressing the ► button on the projector. The 10 digit Inquiring Code will be displayed.</p>  <ul style="list-style-type: none"> • If there is no key input for about 5 minutes while the Inquiring Code is displayed, the projector will turn off. <p>3-2 Contact your dealer with the 10 digit Inquiring Code. Your PIN Code will be sent after your user registration information is confirmed.</p>

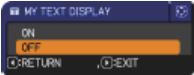
(continued on next page)

Item	Description
<p>MY TEXT PASSWORD</p>	<p>The MY TEXT PASSWORD function can prevent the MY TEXT from being overwritten. When the password is set for the MY TEXT;</p> <ul style="list-style-type: none"> • The MY TEXT DISPLAY menu will be unavailable, which can prohibit changing the DISPLAY setting. • The MY TEXT WRITING menu will be unavailable, which can prevent the MY TEXT from being overwritten. <p>1 Turning on the MY TEXT PASSWORD</p> <p>1-1 Use the ▲/▼ buttons on the SECURITY menu to select the MY TEXT PASSWORD and press the ► button to display the MY TEXT PASSWORD on/off menu.</p>  <p>1-2 Use the ▲/▼ buttons on the MY TEXT PASSWORD on/off menu to select ON. The ENTER NEW PASSWORD box (small) will be displayed.</p>  <p>1-3 Use the ▲/▼/◀/▶ buttons to enter the password. Move the cursor to the right side of the ENTER NEW PASSWORD box (small) and press the ► button to display the NEW PASSWORD AGAIN box, and then enter the same password again.</p>  <p>1-4 Move the cursor to the right of the NEW PASSWORD AGAIN box and press the ► button to display the NOTE NEW PASSWORD box for about 20 seconds, then please make note of the password during this time.</p>  <p>Pressing the ENTER button on the remote control or ► button on the projector will return to the MY TEXT PASSWORD on/off menu.</p> <p>2 Turning off the MY TEXT PASSWORD</p> <p>2-1 Follow the procedure in 1-1 to display the MY TEXT PASSWORD on/off menu.</p> <p>2-2 Select OFF to display the ENTER PASSWORD box (large). Enter the registered password and the screen will return to the MY TEXT PASSWORD on/off menu.</p>  <p>If an incorrect password is input, the menu will close. If necessary, repeat the process from 2-1</p> <p>3 If you have forgotten your password</p> <p>3-1 Follow the procedure in 1-1 to display the MY TEXT PASSWORD on/off menu.</p> <p>3-2 Select OFF to display the ENTER PASSWORD box (large). The 10 digit inquiring code will be displayed inside the box.</p> <p>3-3 Contact your dealer with the 10 digit inquiring code. Your password will be sent after your user registration information is confirmed.</p>

(continued on next page)

Item	Description
<p>MY TEXT DISPLAY</p>	<p>(1) Use the ▲/▼ buttons on the SECURITY menu to select the MY TEXT DISPLAY and press the ► button to display the MY TEXT DISPLAY on/off menu.</p>  <p>(2) Use the ▲/▼ buttons on the MY TEXT DISPLAY on/off menu to select on or off. ON ⇔ OFF</p> <p>When it is set ON, the MY TEXT will be displayed on the START UP screen and the INPUT INFORMATION when the INFORMATION on the SERVICE menu is chosen.</p> <ul style="list-style-type: none"> This function is available only when the MY TEXT PASSWORD function is set to the OFF.  
<p>MY TEXT WRITING</p>	<p>(1) Use the ▲/▼ buttons on the SECURITY menu to select the MY TEXT WRITING and press the ► button. The MY TEXT WRITING dialog will be displayed.</p>  <p>(2) The current MY TEXT will be displayed on the first 3 lines. If not yet written, the lines will be blank. Use the ▲/▼/◀/▶ buttons and the ENTER or INPUT button to select and enter characters. The RESET button can be used to erase 1 character at a time. Also if you move the cursor to DELETE or ALL CLEAR on screen and press the ENTER or INPUT button, 1 character or all characters will be erased. The MY TEXT can be input up to 24 characters on each line.</p>  <p>(3) To change an already inserted character, press the ▲/▼ button to move the cursor to one of the first 3 lines, and use the ◀/▶ buttons to move the cursor on the character to be changed. After pressing the ENTER or INPUT button, the character is selected. Then, follow the same procedure as described at the item (2) above.</p>  <p>(4) To finish entering text, move the cursor to the OK on screen and press the ENTER or INPUT button. To revert to the previous MY TEXT without saving changes, move the cursor to the CANCEL on screen and press the ENTER or INPUT button.</p> <ul style="list-style-type: none"> The MY TEXT WRITING function is available only when the MY TEXT PASSWORD function is set to OFF.

Maintenance

Replacing the lamp

A lamp has finite product life. Using the lamp for long periods of time could cause the pictures darker or the color tone poor. Note that each lamp has a different lifetime, and some may burst or burn out soon after you start using them. Preparation of a new lamp and early replacement are recommended. To prepare a new lamp, make contact with your dealer and tell the lamp type number.

Type number : DT01022

Replacing the lamp

1. Turn the projector off, and unplug the power cord.
Allow the projector to cool for at least 45 minutes.
2. Prepare a new lamp. If the projector is mounted on a ceiling, or if the lamp has broken, also ask the dealer to replace the lamp.

In case of replacement by yourself, follow the following procedure.

3. Loosen the screw (marked by arrow) of the lamp cover and then slide and lift the lamp cover to the side to remove it.
4. Loosen the 3 screws (marked by arrow) of the lamp, and slowly pick up the lamp by the handles. Never loosen any other screws.
5. Insert the new lamp, and retighten firmly the 3 screws of the lamp that are loosened in the previous process to lock it in place.
6. While putting the interlocking parts of the lamp cover and the projector together, slide the lamp cover back in place. Then firmly fasten the screw of the lamp cover.
7. Turn the projector on and reset the lamp time using the LAMP TIME item in the OPTION menu.
 - (1) Press the **MENU** button to display a menu.
 - (2) Point at the **ADVANCED MENU** in the menu using the **▼/▲** button, then press the **▶** button.
 - (3) Point at the **OPTION** in the left column of the menu using the **▼/▲** button, then press the **▶** button.
 - (4) Point at the **LAMP TIME** using the **▼/▲** button, then press the **▶** button. A dialog will appear.
 - (5) Press the **▶** button to select "OK" on the dialog. It performs resetting the lamp time.

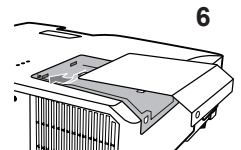
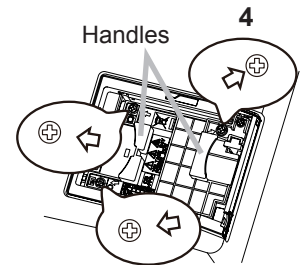
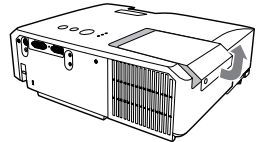
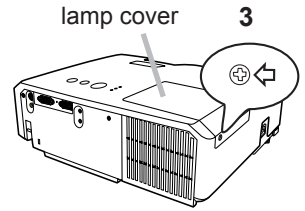

⚠ CAUTION ▶ Do not touch any inner space of the projector, while the lamp is taken out.

NOTE • Please reset the lamp time only when you have replaced the lamp, for a suitable indication about the lamp.

Replacing the lamp (continued)

Lamp warning

 **HIGH VOLTAGE**  **HIGH TEMPERATURE**  **HIGH PRESSURE**

⚠ WARNING ▶ The projector uses a high-pressure mercury glass lamp. The lamp can break with a loud bang, or burn out, if jolted or scratched, handled while hot, or worn over time. Note that each lamp has a different lifetime, and some may burst or burn out soon after you start using them. In addition, when the bulb bursts, it is possible for shards of glass to fly into the lamp housing, and for gas containing mercury to escape from the projector's vent holes.

▶ **About disposal of a lamp:** This product contains a mercury lamp; do not put it in a trash. Dispose of it in accordance with environmental laws.

- For lamp recycling, go to www.lamprecycle.org (in the US).
- For product disposal, consult your local government agency or www.eiae.org (in the US) or www.epsc.ca (in Canada).

For more information, call your dealer.



Disconnect
the plug
from the
power
outlet

- If the lamp should break (it will make a loud bang when it does), unplug the power cord from the outlet, and make sure to request a replacement lamp from your local dealer. Note that shards of glass could damage the projector's internals, or cause injury during handling, so please do not try to clean the projector or replace the lamp yourself.
- If the lamp should break (it will make a loud bang when it does), ventilate the room well, and make sure not to breathe the gas that comes out of the projector vents, or get it in your eyes or mouth.
- Before replacing the lamp, turn the projector off and unplug the power cord, then wait at least 45 minutes for the lamp to cool sufficiently. Handling the lamp while hot can cause burns, as well as damaging the lamp.



- Never unscrew except the appointed (marked by an arrow) screws.
- Do not open the lamp cover while the projector is suspended from a ceiling. This is dangerous, since if the lamp's bulb has broken, the shards will fall out when the cover is opened. In addition, working in high places is dangerous, so ask your local dealer to have the lamp replaced even if the bulb is not broken.
- Do not use the projector with the lamp cover removed. At the lamp replacing, make sure that the screws are screwed in firmly. Loose screws could result in damage or injury.



- Use only the lamp of the specified type.
- If the lamp breaks soon after the first time it is used, it is possible that there are electrical problems elsewhere besides the lamp. If this happens, consult your local dealer or a service representative.
- Handle with care: jolting or scratching could cause the lamp bulb to burst during use.
- Using the lamp for long periods of time, could cause it dark, not to light up or to burst. When the pictures appear dark, or when the color tone is poor, please replace the lamp as soon as possible. Do not use old (used) lamps; this is a cause of breakage.

Cleaning and replacing the air filter

Please check and clean the air filter periodically. When the indicators or a message prompts you to clean the air filter, comply with it as soon as possible. Replace the air filter when it is damaged or heavily soiled. To prepare a new air filter, make contact with your dealer and tell the air filter type number.

Type number : NJ26302

When you replace the lamp, please replace the air filter. An air filter of specified type will come together with a replacement lamp for this projector.

1. Turn the projector off, and unplug the power cord. Allow the projector to sufficiently cool down.
2. Use a vacuum cleaner on and around the filter cover.
3. While supporting the projector with one hand, use your other hand to pull the filter cover forward in the direction of the arrow.
4. Use a vacuum cleaner for the filter vent of the projector and the outer side of the filter unit.
5. Take the filter out pulling the filter's knob up while holding the filter cover.
6. Use a vacuum cleaner on both sides of the filter. If the filter is damaged or heavily soiled, replace it with the new one.
7. Put the filter back into the filter cover.
8. Put the filter unit back into the projector.
9. Turn the projector on and reset the filter time using the FILTER TIME item in the EASY MENU.
 - (1) Press the **MENU** button to display a menu.
 - (2) Point at the FILTER TIME using the ▼/▲ button, then press the ► button. A dialog will appear.
 - (3) Press the ► button to select "OK" on the dialog. It performs resetting the filter time.

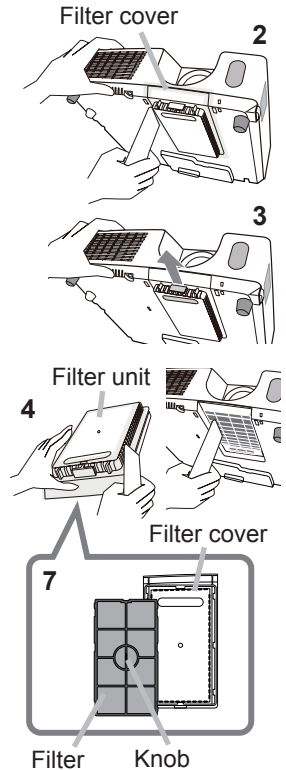

(continued on next page)

Cleaning and replacing the air filter (continued)

⚠ WARNING ▶ Before taking care of the air filter, make sure the power cable is not plugged in, then allow the projector to cool sufficiently. Taking care of the air filter in a high temperature state of the projector could cause an electric shock, a burn or malfunction to the projector.

▶ Use only the air filter of the specified type. Do not use the projector without the air filter or the filter cover. It could result in a fire or malfunction to the projector.

▶ Clean the air filter periodically. If the air filter becomes clogged by dust or the like, internal temperatures rise and could cause a fire, a burn or malfunction to the projector.

NOTE • Please replace the air filter when it is damaged or too soiled.

• When you replace the projection lamp, please replace the air filter. An air filter of specified type will come together with a replacement lamp for this projector.

• Please reset the filter time only when you have cleaned or replaced the air filter, for a suitable indication about the air filter.

• The projector may display the message such as “CHECK THE AIR FLOW” or turn off the projector, to prevent the internal heat level rising.

Other care

Inside of the projector

In order to ensure the safe use of your projector, please have it cleaned and inspected by your dealer about once every year.

Caring for the lens

If the lens is flawed, soiled or fogged, it could cause deterioration of display quality. Please take care of the lens, being cautious of handling.

1. Turn the projector off, and unplug the power cord. Allow the projector to cool sufficiently.
2. After making sure that the projector is cool adequately, lightly wipe the lens with a commercially available lens-cleaning wipe. Do not touch the lens directly with your hand.

Caring for the cabinet and remote control

Incorrect care could have adverse influence such as discoloration, peeling paint, etc.

1. Turn the projector off, and unplug the power cord. Allow the projector to cool sufficiently.
2. After making sure that the projector is cool adequately, lightly wipe with gauze or a soft cloth.
If the projector is extremely dirty, dip soft cloth in water or a neutral cleaner diluted in water, and wipe lightly after wringing well. Then, wipe lightly with a soft, dry cloth.

⚠ WARNING ▶ Before caring, make sure the power cord is not plugged in, and then allow the projector to cool sufficiently. The care in a high temperature state of the projector could cause a burn and/or malfunction to the projector.

▶ Never try to care for the inside of the projector personally. Doing is so dangerous.

▶ Avoid wetting the projector or inserting liquids in the projector. It could result in a fire, an electric shock, and/or malfunction to the projector.

- Do not put anything containing water, cleaners or chemicals near the projector.
- Do not use aerosols or sprays.

⚠ CAUTION ▶ Please take right care of the projector according to the following. Incorrect care could cause not only an injury but adverse influence such as discoloration, peeling paint, etc.

▶ Do not use cleaners or chemicals other than those specified in this manual.

▶ Do not polish or wipe with hard objects.

Troubleshooting







If an abnormal operation should occur, stop using the projector immediately.

⚠ WARNING ▶ Never use the projector if abnormal operations such as smoke, strange odor, excessive sound, damaged casing or elements or cables, penetration of liquids or foreign matter, etc. should occur. In such cases, immediately disconnect the power plug from the power outlet. After making sure that the smoke or odor has stopped, contact to your dealer or service company.

Otherwise if a problem occurs with the projector, the following checks and measures are recommended before requesting repair. If this does not resolve the problem, please contact your dealer or service company. They will tell you what warranty condition is applied.

Related messages

When some message appears, check and cope with it according to the following table. Although these messages will be automatically disappeared around several minutes, it will be reappeared every time the power is turned on.

Message	Description
	<p>There is no input signal. Please confirm the signal input connection, and the status of the signal source.</p>
	<p>The horizontal or vertical frequency of the input signal is not within the specified range. Please confirm the specs for your projector or the signal source specs.</p>
	<p>An improper signal is input. Please confirm the specs for your projector or the signal source specs.</p>
	<p>The internal temperature is rising. Please turn the power off, and allow the projector to cool down at least 20 minutes. After having confirmed the following items, please turn the power ON again.</p> <ul style="list-style-type: none"> • Is there blockage of the air passage aperture? • Is the air filter dirty? • Does the peripheral temperature exceed 35°C? <p>If the same indication is displayed after the remedy, please set FAN SPEED of the SERVICE item in the OPTION menu to HIGH.</p>
	<p>A note of precaution when cleaning the air filter. Please immediately turn the power off, and clean or change the air filter referring to the “Cleaning and replacing the air filter” section of this manual. After you have cleaned or changed the air filter, please be sure to reset the filter timer (43).</p>
	<p>The button operation is not available with following condition. One of the invalid buttons on the remote control was pressed (46).</p>

Regarding the indicator lamps

When operation of the **LAMP**, **TEMP** and **POWER** indicators differs from usual, check and cope with it according to the following table.

POWER indicator	LAMP indicator	TEMP indicator	Description
Lighting In Orange	Turned off	Turned off	The projector is in a standby state. Please refer to the section "Power on/off".
<i>Blinking</i> In Green	Turned off	Turned off	The projector is warming up. Please wait.
Lighting In Green	Turned off	Turned off	The projector is in an on state. Ordinary operations may be performed.
<i>Blinking</i> In Orange	Turned off	Turned off	The projector is cooling down. Please wait.
<i>Blinking</i> In Red	(discretionary)	(discretionary)	The projector is cooling down. A certain error has been detected. Please wait until POWER indicator finishes blinking, and then perform the proper measure using the item descriptions below.
<i>Blinking</i> In Red or Lighting In Red	Lighting In Red	Turned off	The lamp does not light, and there is a possibility that interior portion has become heated. Please turn the power off, and allow the projector to cool down at least 20 minutes. After the projector has sufficiently cooled down, please make confirmation of the following items, and then turn the power on again. <ul style="list-style-type: none"> • Is there blockage of the air passage aperture? • Is the air filter dirty? • Does the peripheral temperature exceed 35°C? If the same indication is displayed after the remedy, please change the lamp referring to the section "Replacing the lamp".
<i>Blinking</i> In Red or Lighting In Red	<i>Blinking</i> In Red	Turned off	The lamp cover has not been properly fixed. Please turn the power off, and allow the projector to cool down at least 45 minutes. After the projector has sufficiently cooled down, please make confirmation of the attachment state of the lamp cover. After performing any needed maintenance, turn the power on again. If the same indication is displayed after the remedy, please contact your dealer or service company.
<i>Blinking</i> In Red or Lighting In Red	Turned off	<i>Blinking</i> In Red	The cooling fan is not operating. Please turn the power off, and allow the projector to cool down at least 20 minutes. After the projector has sufficiently cooled down, please make confirmation that no foreign matter has become caught in the fan, etc., and then turn the power on again. If the same indication is displayed after the remedy, please contact your dealer or service company.

(Continued on next page)

Regarding the indicator lamps (continued)

POWER indicator	LAMP indicator	TEMP indicator	Description
Blinking In Red or Lighting In Red	Turned off	Lighting In Red	<p>There is a possibility that the interior portion has become heated.</p> <p>Please turn the power off, and allow the projector to cool down at least 20 minutes. After the projector has sufficiently cooled down, please make confirmation of the following items, and then turn the power on again.</p> <ul style="list-style-type: none"> • Is there blockage of the air passage aperture? • Is the air filter dirty? • Does the peripheral temperature exceed 35°C? <p>If the same indication is displayed after the remedy, please set FAN SPEED of SERVICE item in OPTION menu to HIGH (📖45).</p>
Lighting In Green	Simultaneous blinking in Red		<p>It is time to clean the air filter.</p> <p>Please immediately turn the power off, and clean or change the air filter referring to the section “Cleaning and replacing the air filter”. After cleaning or changing the air filter, please be sure to reset the filter timer. After the remedy, reset the power to ON.</p>
Lighting In Green	Alternative blinking in Red		<p>There is a possibility that the interior portion has become overcooled.</p> <p>Please use the unit within the usage temperature parameters (5°C to 35°C). After the treatment, reset the power to ON.</p>

NOTE • When the interior portion has become overheated, for safety purposes, the projector is automatically shut down, and the indicator lamps may also be turned off. In such a case, disconnect the power cord, and wait at least 45 minutes. After the projector has sufficiently cooled down, please make confirmation of the attachment state of the lamp and lamp cover, and then turn the power on again.

Shutting the projector down

Only when the projector can not be turned off by usual procedure (📖14), please push the shutdown switch using a pin or similar, and disconnect the power plug from the power outlet. Before turning it on again, wait at least 10 minutes to make the projector cool down enough.

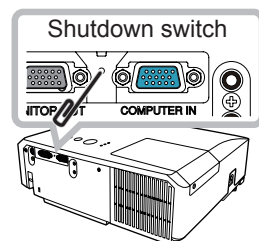

Resetting all settings

When it is hard to correct some wrong settings, the FACTORY RESET function of SERVICE item in OPTION menu (📖46) can reset all settings (except LANGUAGE, FILTER TIME, LAMP TIME, FILTER MESSAGE and SECURITY settings and etc.) to the factory default.

Phenomena that may be easy to be mistaken for machine defects

About the phenomenon confused with a machine defect, check and cope with it according to the following table.

Phenomenon	Cases not involving a machine defect	Reference page
Power does not come on.	<p>The electrical power cord is not plugged in. Correctly connect the power cord.</p>	11
	<p>The main power source has been interrupted during operation such as by a power outage (blackout), etc. Please disconnect the power plug from the power outlet, and allow the projector to cool down at least 10 minutes, then turn the power on again.</p>	11, 14
	<p>Either there is no lamp and/or lamp cover, or either of these has not been properly fixed. Please turn the power off and disconnect the power plug from the power outlet, and allow the projector to cool down at least 45 minutes. After the projector has sufficiently cooled down, please make confirmation of the attachment state of the lamp and lamp cover, and then turn the power on again.</p>	52, 53
Neither sounds nor pictures are outputted.	<p>The signal cables are not correctly connected. Correctly connect the connection cables.</p>	9
	<p>Signal source does not correctly work. Correctly set up the signal source device by referring to the manual of the source device.</p>	–
	<p>The input changeover settings are mismatched. Select the input signal, and correct the settings.</p>	15, 16
	<p>The BLANK function for pictures and the MUTE function for sounds are working. AV MUTE may be active. Refer to the item “Sound does not come out” and “No pictures are displayed” on the next page to turn off the MUTE and BLANK functions.</p>	15, 21, 44

(Continued on next page)

Phenomena that may be easy to be mistaken for machine defects (continued)

Phenomenon	Cases not involving a machine defect	Reference page
Sound does not come out.	The signal cables are not correctly connected. Correctly connect the audio cables.	9
	The MUTE function is working. Restore the sound pressing MUTE or VOLUME +/- button on the remote control.	15
	The volume is adjusted to an extremely low level. Adjust the volume to a higher level using the menu function or the remote control.	15
	The AUDIO SOURCE/SPEAKER setting is not correct. Correctly set the AUDIO SOURCE/SPEAKER in AUDIO menu.	36
No pictures are displayed.	The signal cables are not correctly connected. Correctly connect the connection cables.	9
	The brightness is adjusted to an extremely low level. Adjust BRIGHTNESS to a higher level using the menu function.	26
	The computer cannot detect the projector as a plug and play monitor. Make sure that the computer can detect a plug and play monitor using another plug and play monitor.	10
	The BLANK screen is displayed. Press BLANK button on the remote control.	21
Video screen display freezes.	The FREEZE function is working. Press FREEZE button to restore the screen to normal.	21
Colors have a faded- out appearance, or Color tone is poor.	Color settings are not correctly adjusted. Perform picture adjustments by changing the COLOR TEMP, COLOR, TINT and/or COLOR SPACE settings, using the menu functions.	27, 31
	COLOR SPACE setting is not suitable. Change the COLOR SPACE setting to AUTO, RGB, SMPTE240, REC709 or REC601.	31

(Continued on next page)

Phenomena that may be easy to be mistaken for machine defects (continued)

Phenomenon	Cases not involving a machine defect	Reference page
Pictures appear dark.	The brightness and/or contrast are adjusted to an extremely low level. Adjust BRIGHTNESS and/or CONTRAST settings to a higher level using the menu function.	26
	 ECO MODE function is working. Set the mode to NORMAL for the ECO MODE item in the SETUP menu.	34
	The lamp is approaching the end of its product lifetime. Replace the lamp.	52, 53
Pictures appear blurry.	Either the focus and/or horizontal phase settings are not properly adjusted. Adjust the focus using the focus ring, and/or H PHASE using the menu function.	18, 30
	The lens is dirty or misty. Clean the lens referring to the section "Caring for the lens".	56

NOTE • Although bright spots or dark spots may appear on the screen, this is a unique characteristic of liquid crystal displays, and it does not constitute or imply a machine defect.

Specifications

Specification

Item	Specification
Product name	Liquid crystal projector
Liquid Crystal Panel	786,432 pixels (1024 horizontal x 768 vertical)
Lens	Zoom lens, f = 19 ~ 23 mm (approximately)
Lamp	210W UHP
Speaker	1W
Power supply	AC 100-120V/3.7A, AC220-240V/1.8A
Power consumption	330 W
Temperature range	5 ~ 35°C (Operating)
Size	317 (W) x 98 (H) x 288 (D) mm * Not including protruding parts. Please refer to the following figure.
Weight (mass)	approx. 3.2kg
Ports	Computer input port COMPUTER IN D-sub 15 pin mini x1 Computer output port MONITOR OUT D-sub 15 pin mini x1 Video input port S-VIDEO..... mini DIN 4 pin x1 VIDEO RCA x1 Audio input/output port AUDIO IN Stereo mini x1 AUDIO OUT Stereo mini x1
Optional parts	Lamp: DT01022 Air filter: NJ26302 Mounting accessory: HAS-3010 (Bracket for ceiling mount) HAS-204L (Fixing adaptor for low ceilings) HAS-304H (Fixing adaptor for high ceilings) Soft case: CA3010 * For more information, please consult your dealer.

Specifications (continued)

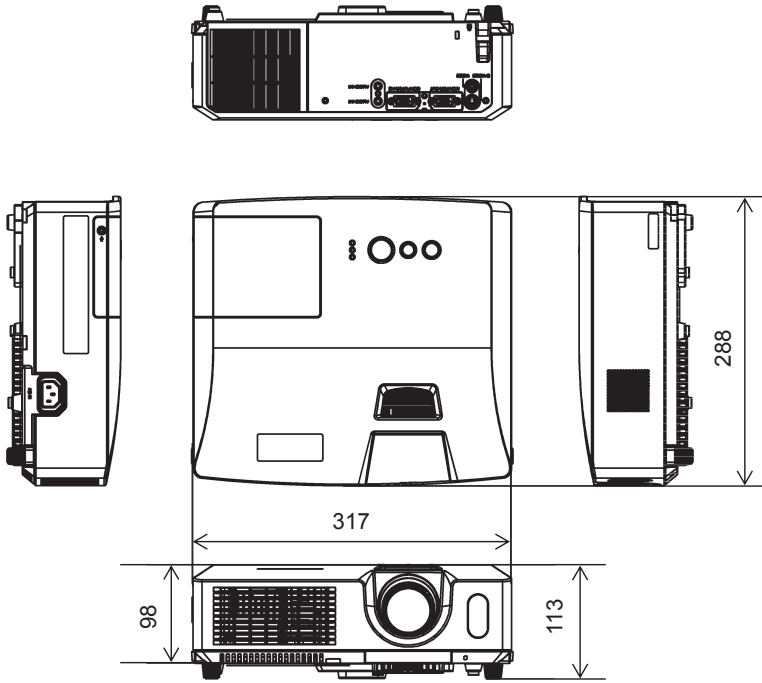

[unit: mm]