

myprojectorlamps.com

**The most trusted, dependable name
in projector lamp sales.**



<http://www.myprojectorlamps.com>



<http://www.myprojectorlamps.ca>



<http://www.myprojectorlamps.eu>

The following projector manual has not been modified or altered in any way.

Projector

User's Manual – Operating Guide

CP-RX60

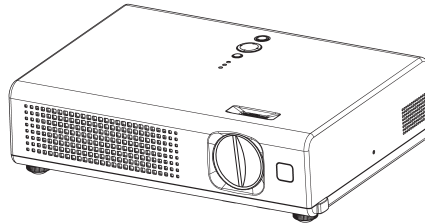

Thank you for purchasing this projector.

⚠ WARNING ▶ Before using, read the "User's Manual - Safety Guide" and these manuals to ensure correct usage through understanding. After reading, store them in a safe place for future reference.

About this manual

Various symbols are used in this manual. The meanings of these symbols are described below.

⚠ WARNING This symbol indicates information that, if ignored, could possibly result in personal injury or even death due to incorrect handling.

⚠ CAUTION This symbol indicates information that, if ignored, could result possibly in personal injury or physical damage due to incorrect handling.

📖 Please refer to the pages written following this symbol.



NOTE • The information in this manual is subject to change without notice.

- The manufacturer assumes no responsibility for any errors that may appear in this manual.
- The reproduction, transmission or use of this document or contents is not permitted without express written authority.

Trademark acknowledgment

- VGA and XGA are registered trademarks of the International Business Machines Corporation.
 - Apple and Mac are registered trademarks of Apple Computer, Inc.
 - VESA and SVGA are trademarks of the Video Electronics Standard Association.
 - Windows is a registered trademark of Microsoft Corporation.
 - Internet Explorer is a trademark of Microsoft Corporation.
- All other trademarks are the property of their respective owners.

Contents

About this manual	1		EASY MENU	25	
Contents	2		Aspect, Zoom, Keystone, Mode,		
Projector features	3		Bright, Contrast, Color, Tint,		
About contents of package	3		Sharpness, Whisper, Mirror, Reset,		
Part names	4		Filter time, Language,		
Projector	4		Go to advanced menu		
Controls	5		PICTURE menu	27	
Remote control	5		Bright, Contrast, Gamma, Color temp,		
Preparations	6		Color, Tint, Sharpness, Progressive,		
Fastening the lens cover	6		My memory		
Putting batteries	7		IMAGE menu	30	
Using the remote control	8		Aspect, Over scan, V. position,		
About the filter cover for bottom-up use	9		H. position, H. phase, H. size,		
Setting up	10		Auto adjust execute		
Arrangement	11		INPUT menu	32	
Adjusting the projector's elevator	12		Color space, Video format, Frame lock,		
Connecting your devices	13		Information		
Connecting power supply	15		SETUP menu	34	
Power on/off	16		Zoom, Keystone, Whisper, Mirror,		
Turning on the power	16		Volume		
Turning off the power	17		SCREEN menu	35	
Operating	18		Language, Menu position, OSD bright,		
Adjusting the volume	18		Blank, Start up, MyScreen,		
Temporarily muting the sound	18		MyScreen lock, Message		
Selecting an input signal	18		OPTION menu	38	
Searching an input signal	19		Auto search, Auto off, Lamp time,		
Selecting an aspect ratio	19		Filter time, Service		
Adjusting the zoom (magnifying power)	19		Maintenance	41	
Adjusting the focus	19		Lamp	41	
Using the automatic adjustment feature	20		Air filter	43	
Adjusting the position	20		Other care	45	
Correcting the keystone distortions	20		Troubleshooting	46	
Using the partial magnify feature	21		Related messages	46	
Freezing the screen	21		Regarding the indicator lamps	48	
Temporarily blanking the screen	21		Phenomena that may easily be mistaken for machine defects	50	
Multifunctional settings	22		Warranty and after-service	52	
Using the menu function	22		Specifications	52	

Projector features

This projector is used to project various computer signals as well as NTSC / PAL / SECAM video signals onto a screen. It requires just a little space for installation and gets a large image from short distance.

○ High Brightness

Newly developed 165W UHB (Ultra High Brightness) lamp gives you a higher brightness image on a screen. The image can be still kept as bright and clean enough for use in bright rooms.

○ Low Noise

WHISPER mode is equipped for reducing acoustic noise to realize quieter operation. It is perfect for use in low luminance rooms where low noise is more important than brightness.

○ Compact Body

Even with its many features, this projector is extremely compact and slim, which gives you more flexibility and usability to use it where you want.

About contents of package

Please see the "Contents of package" of the "User's Manual - Quick Guide". Your projector should come with the items shown there. Contact immediately your dealer if anything is missing.

NOTE • Keep the original packing materials for future reshipment. For moving the projector, be sure to use the original packing material. Use special caution for the lens part.

Part names

Projector

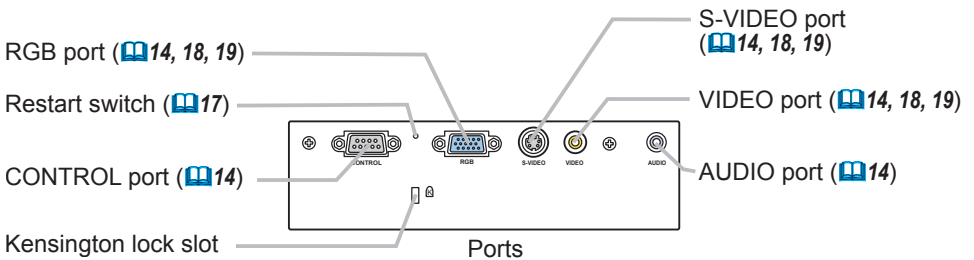
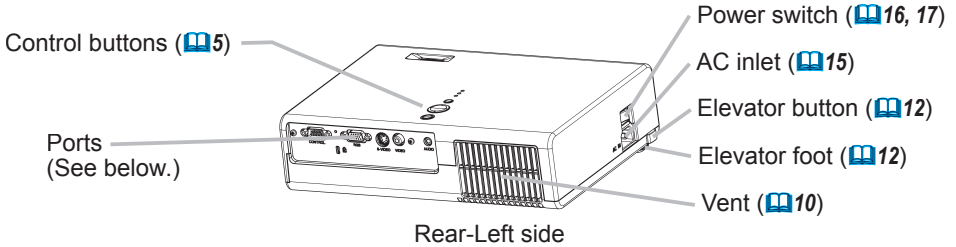
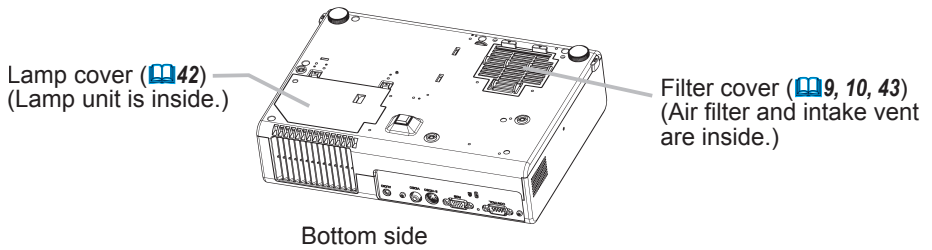
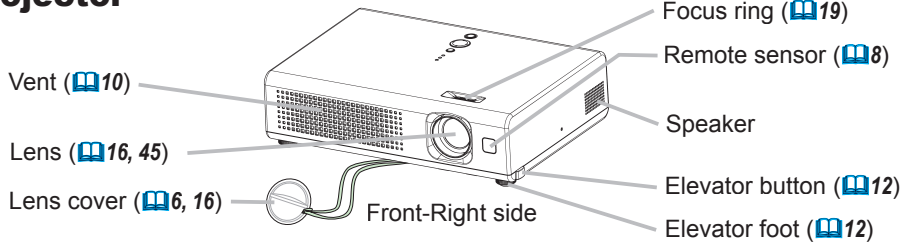

Controls

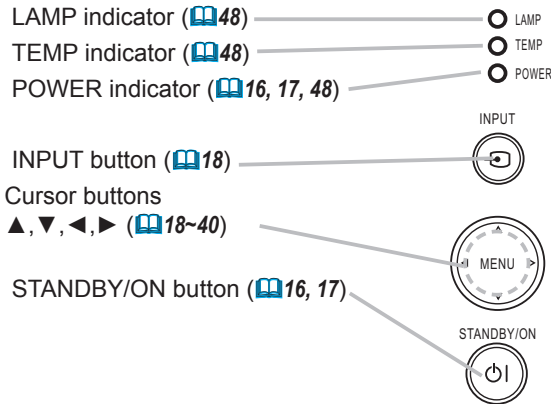

Remote control

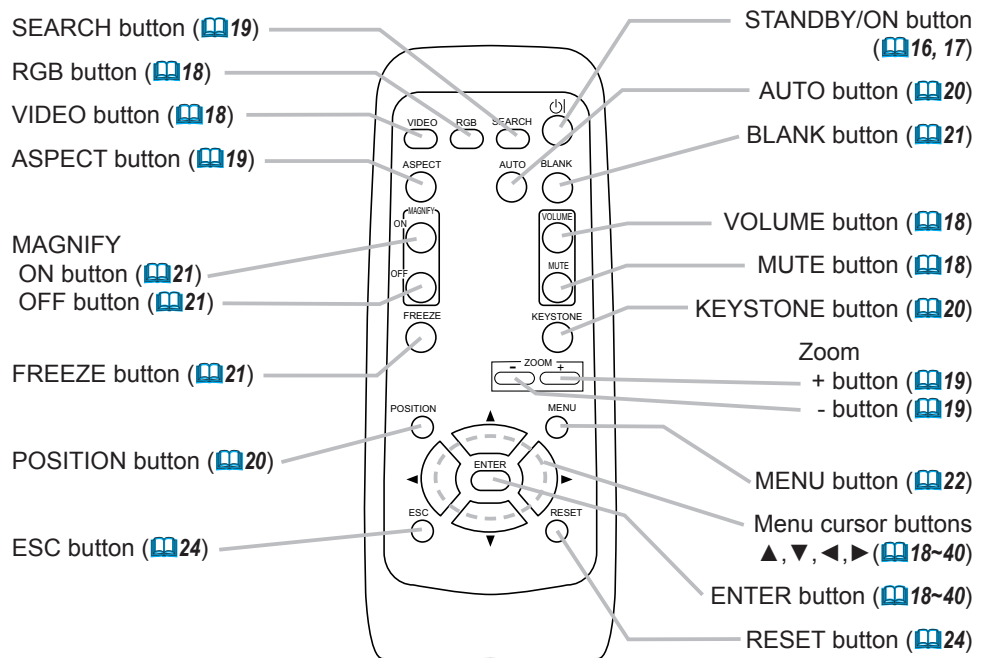

Preparations

Fastening the lens cover

⚠ WARNING ► Do not fasten the lens cover during use or immediately after use. Handling while the projector is in a high temperature could cause a burn and/or malfunction to the projector. Before operating, make sure that the power switch is off, that the power cord is not plugged in, and that the projector is cool adequately.

To avoid losing, please fasten the lens cover to the projector using the strap.

1. Slowly turn over the projector, so that the bottom is facing up.
2. Fix the strap to the strap ring of projector.

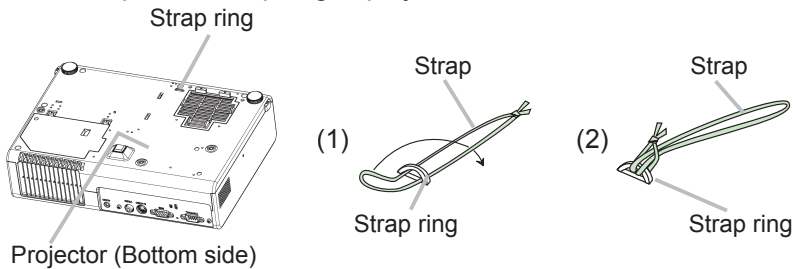

3. Fix the strap to the strap ring of lens cover.

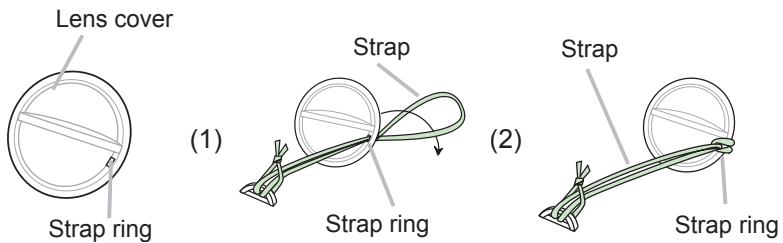

4. Attach the lens cover to the lens of projector, and slowly turn over the projector, so that the top is facing up.

Putting batteries

- ⚠WARNING** ► Always handle the batteries with care and use them only as directed. Improper use may result in battery explosion, cracking or leakage, which could result in fire, injury and/or pollution of the surrounding environment.
- Be sure to use only the batteries specified. Do not use batteries of different types at the same time. Do not mix a new battery with used one.
 - Make sure the plus and minus terminals are correctly aligned when loading a battery.
 - Keep a battery away from children and pets.
 - Do not recharge, short circuit, solder or disassemble a battery.
 - Do not allow a battery in a fire or water. Keep batteries in a dark, cool and dry place.
 - Do not give the battery a physical impact.
 - If you observe a leakage of a battery, wipe out the flower and then replace a battery. If the flower adheres your body or clothes, rinse well with water immediately.
 - Obey the local laws on disposing a battery.

To use the remote control, please load the batteries. Whenever the remote control starts to malfunction, replace the batteries. If you won't use the remote control for an extended period, remove the batteries from the remote control and store them in a safe place.

1. Remove the battery cover.
 - Slide back and remove the battery cover in the direction of the arrow.

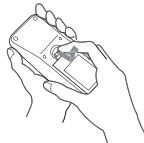

2. Take old batteries out and/or put new batteries in.
 - When putting in batteries, align and insert the two AA batteries according to their plus and minus terminals as indicated in the remote control.

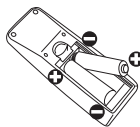

3. Close the battery cover.
 - Replace the battery cover in the direction of the arrow and snap it back into place.

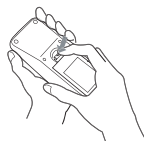

Using the remote control

⚠ CAUTION ▶ Be careful in handling the remote control. Incorrect handling could cause damage or malfunction.

- Do not drop or otherwise expose the remote control to physical impact.
- Do not get the remote control wet or place it on wet objects.
- Remove the batteries from the remote control and store them in a safe place if you won't be using the remote control for an extended period.
- Replace the batteries whenever the remote control starts to malfunction.
- When strong lights such as direct sunlight or light from an extremely close range (such as from an inverter fluorescent lamp) hit the projector's remote sensor, the remote control may not function correctly. Adjust the direction of the projector to keep light from directly hitting the projector's remote sensor.

The remote control works with the projector's remote sensor.

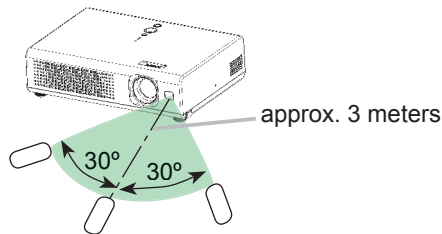

- The range of the remote sensor is 3 meters with a 60 degree range (30 degrees to the left and right of the remote sensor).
- Also a remote signal reflected in the screen etc. may be available. If it is difficult to send a remote signal to the sensor directly, please try.
- Since the remote control uses infrared light to send signals to the projector (Class1 LED), be sure to use the remote control in an area free from obstacles that could block the remote control's output signal to the projector.

About the filter cover for bottom-up use

⚠ WARNING ▶ Do not replace the filter cover and/or air filter during use or immediately after use. Handling while the projector is in a high temperature could cause a burn and/or malfunction to the projector. Before operating, make sure that the power switch is off, that the power cord is not plugged in, and that the projector is cool adequately.

When the projector is installed bottom up, please use the accessory filter cover for bottom-up use. It is higher than usual filter cover, to keep the space for intake ventilation. Please change in the following procedure.

1. Disconnect all the connectors and adapters that were connected to the projector's ports. Then slowly turn the projector so that the lens-side is facing up. Please be careful for a projector not to fall. While the projector is placed lens-side up, hold the projector.
2. Remove the filter cover and the air filter. Hold the knobs while pulling out it.

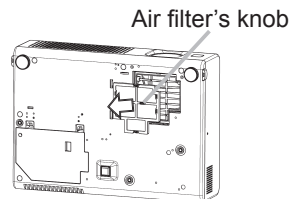
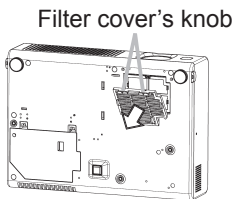

3. Slowly turn the projector so that the bottom is facing up.
4. Set a new or cleaned air filter to the filter cover for bottom-up use. Make the claws slide along the rail, and set the air filter into place.

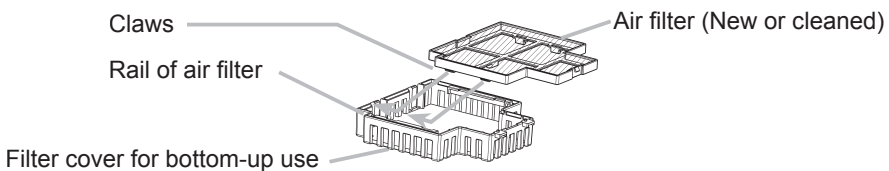

5. Interlocking the tabs, snap the filter cover for bottom-up use into place.

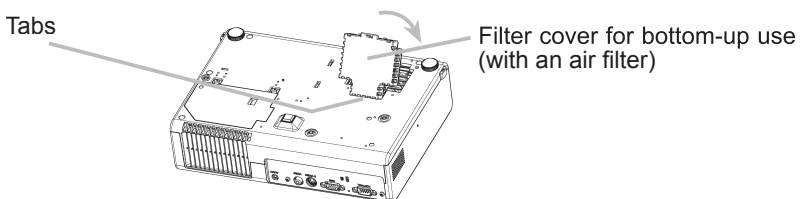

Setting up

⚠WARNING ► Place the projector in a stable position horizontally. A fall or a turnover could cause an injury and/or damage to the projector. Then using damaged projector could result in a fire and/or an electric shock.

- Don't place the projector on an unstable, slant or vibrant surface such as a wobbly or inclined stand.
- Do not place the projector in the side/front/rear-up position, except care of the air filter.
- For the projector installed bottom-up, use the accessory filter cover for bottom-up use. And in the case of a ceiling installation or the like, contact your dealer before installation.

► Place the projection in a cool place, and pay attention enough to ventilation. The high temperature of the projector could cause a fire, a burn and/or malfunction to the projector.

- Don't stop up, block and cover the projector's vents.
- Keep a space of 30 cm or more between the sides and other objects such as walls.
- Don't place the projector on a metallic thing or anything weak in heat.
- Don't place the projector on a carpet, cushion or bedding.
- Don't place the projector in direct sunlight or near a hot object such as heater.
- Put nothing about lens and vents of the projector. Put nothing on the projector.
- Put nothing that is sucked or sticks to the bottom of projector. This projector has some intake vents also on the bottom.

► Do not place the projector on the place that gets wet. Damping the projector or inserting liquid in the projector could cause a fire, an electric shock and/or malfunction to the projector.

- Don't place the projector in a bathroom or the outdoors.
- Put nothing containing the liquid near the projector.

⚠CAUTION ► Avoid a smoky, humid or dusty place. Placing the projector in such place could cause a fire, an electric shock and/or malfunction to the projector.

- Don't place the projector near a humidifier, a smoking space or a kitchen.
- Put nothing containing the liquid near the projector.

► Adjust the direction of the projector to keep light from directly hitting the projector's remote sensor.

Arrangement

Refer to the illustrations and tables below to determine the screen size and projection distance.

The values shown in the table are calculated ($\pm 3\%$) for a full size screen: 1024x768

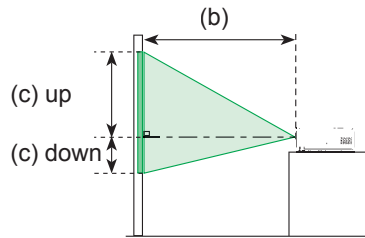

At 4:3 screen

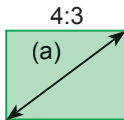

(a) Screen size [inch (m)]	(b) Projection distance [m (inch)]	(c) Screen height [cm (inch)]	
		down	up
40 (1.0)	1.3 (53)	8.7 (3)	52.3 (21)
50 (1.3)	1.7 (66)	10.9 (4)	65.3 (26)
60 (1.5)	2.0 (80)	13.1 (5)	78.4 (31)
70 (1.8)	2.4 (93)	15.2 (6)	91.4 (36)
80 (2.0)	2.7 (107)	17.4 (7)	104.5 (41)
90 (2.3)	3.1 (121)	19.6 (8)	117.6 (46)
100 (2.5)	3.4 (134)	21.8 (9)	130.6 (51)
120 (3.0)	4.1 (161)	26.1 (10)	156.8 (62)
150 (3.8)	5.1 (202)	32.7 (13)	195.9 (77)
200 (5.1)	6.8 (269)	43.5 (17)	261.3 (103)

At 16:9 screen

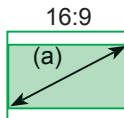

(a) Screen size [inch (m)]	(b) Projection distance [m (inch)]	(c) Screen height [cm (inch)]	
		down	up
40 (1.0)	1.5 (58)	1.2 (0)	48.6 (19)
50 (1.3)	1.8 (72)	1.5 (1)	60.8 (24)
60 (1.5)	2.2 (87)	1.8 (1)	72.9 (29)
70 (1.8)	2.6 (102)	2.1 (1)	85.1 (34)
80 (2.0)	3.0 (117)	2.4 (1)	97.2 (38)
90 (2.3)	3.3 (131)	2.7 (1)	109.4 (43)
100 (2.5)	3.7 (146)	3.0 (1)	121.6 (48)
120 (3.0)	4.5 (176)	3.6 (1)	145.9 (57)
150 (3.8)	5.6 (220)	4.4 (2)	182.3 (72)
200 (5.1)	7.5 (294)	5.9 (2)	243.1 (96)

Adjusting the projector's elevator

⚠WARNING ► Do not adjust the projector's elevator during use or immediately after use. Handling while the projector is in a high temperature could cause a burn and/or malfunction to the projector. Before operating, make sure that the power switch is off, that the power cord is not plugged in, and that the projector is cool adequately.

⚠CAUTION ► If you press the elevator button without holding the projector, the projector might crash down, overturn, smash your fingers and possibly result in malfunction. To prevent damaging the projector and injuring yourself, always hold the projector whenever using the elevator buttons to adjust the elevator feet.

► Except for inclining by the elevator feet adjustment, place the projector horizontally.

You can use the elevator feet to make adjustments if the surface on which you need to set the projector is uneven or if you otherwise need to adjust the angle of projection. The adjustment range of the elevator feet is 0 to 9 degrees.

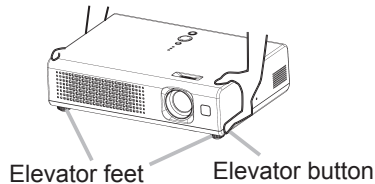

1. Press and hold in the elevator buttons while holding the projector. The elevator buttons and the elevator feet are on the both sides.
2. Raise or lower the projector to the desired height and then release the elevator buttons.
When you release the elevator buttons, the elevator feet will lock into position.
3. As necessary, you can also finely adjust the height of the projector by twisting the elevator feet by hand.

Connecting your devices

⚠ CAUTION ▶ Turn off all devices prior to connecting them to the projector. Attempting to connect a live device to the projector may generate extremely loud noises or other abnormalities that may result in malfunction and/or damage to the device and/or projector.

▶ Use the accessory cable or a designated-type cable for the connection. Some cables have to be used with core set. A too long cable may cause a certain picture degradation. Please consult with your dealer for details. For cables that have a core only at one end, connect the core to the projector.

▶ Make sure that you connect devices to the correct port. Incorrect connection may result in malfunction and/or damage to the device and/or projector.

NOTE • Whenever attempting to connect a laptop computer to the projector, be sure to activate the laptop's RGB external image output (set the laptop to CRT display or to simultaneous LCD and CRT display). For details on how this is done, please refer to the instruction manual of the corresponding laptop computer.

- Secure the screws on the connectors and tighten.
- Some computers may have multiple display screen modes. Use of some of these modes will not be possible with this projector.
- For some RGB signal modes, the optional Mac adapter is necessary.
- When the image resolution is changed on a computer, depending on an input, automatic adjust function may take some time and may not be completed. In this case, you may not be able to see a check box to select "Yes/No" for the new resolution on Windows. Then the resolution will go back to the original. It might be recommended to use other CRT or LCD monitors to change the resolution.

About Plug-and-Play capability

Plug-and-Play is a system composed of the computer, its operating system and peripheral equipment (i.e. display devices). This projector is compatible with VESA DDC 2B. Plug-and-Play can be achieved by connecting this projector to computers that are VESA DDC (display data channel) compatible.

- Please take advantage of this function by connecting the accessory RGB cable to the RGB port (DDC 2B compatible). Plug-and-Play may not work properly if any other type of connection is attempted.
- Please use the standard drivers in your computer as this projector is a Plug-and-Play monitor.

Examples of connection with a computer

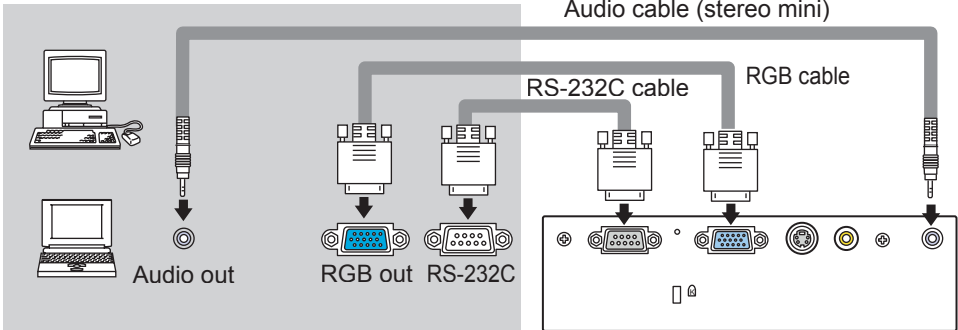

Examples of connection with a VCR/DVD player

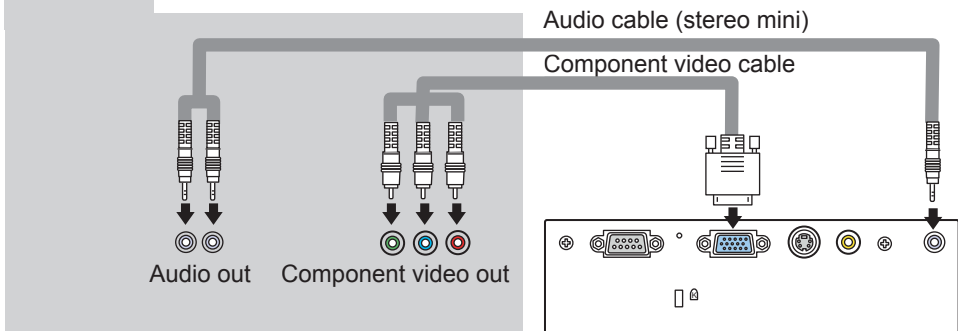
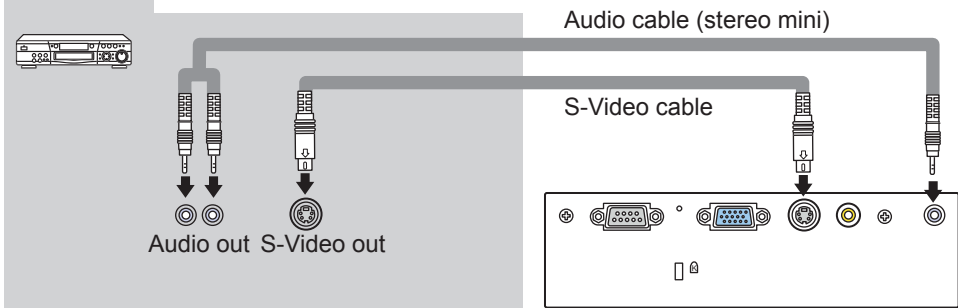
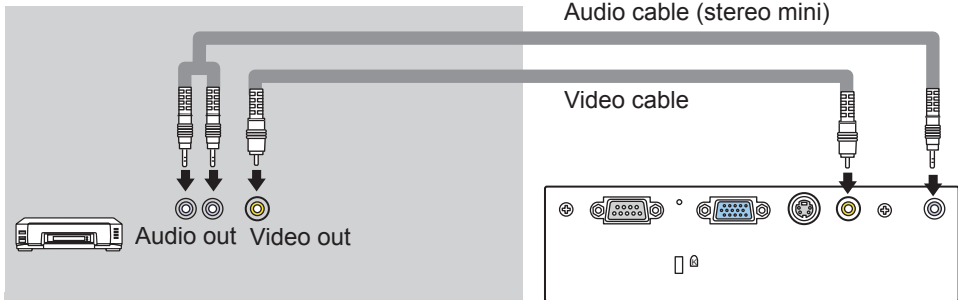

Connecting power supply

- ⚠ WARNING** ▶ Please use extra caution when connecting the power cord as incorrect or faulty connections may result in fire and/or electrical shock.
- Only use the power cord that came with the projector. If it is damaged, contact your dealer to newly get correct one.
 - Only plug the power cord into an outlet rated for use with the power cord's specified voltage range.
 - Never modify the power cord. Never attempt to defeat the ground connection of the three-pronged plug.

Before connecting, make sure that the power switch is the OFF position (pressed the side marked "O").

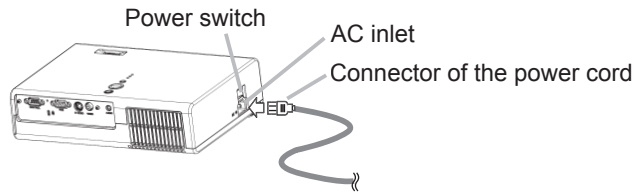

1. Connect the connector of the power cord to the AC inlet of the projector.
2. Firmly plug the power cord's plug into the outlet.

Turning on the power

⚠ WARNING ► When the power is on, a strong light is emitted. Do not look into the lens or vents of the projector.

NOTE • Turn the power on in right order. Please power on the projector before the connected devices.

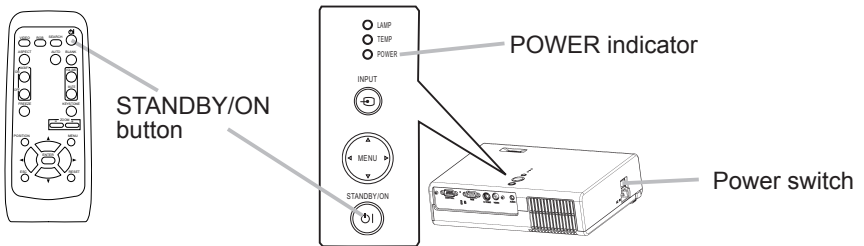

1. Make sure that the power cord is firmly and correctly connected to the projector and outlet.
2. Open the lens cover, and set the power switch to the ON position. The power indicator will light to solid orange. Then wait several seconds because buttons may not function for these several seconds.

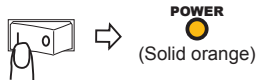

3. Press the STANDBY/ON button on the projector or remote control. The projector lamp will light up and the POWER indicator will begin blinking green. When the power is completely on, the indicator will stop blinking and light green.

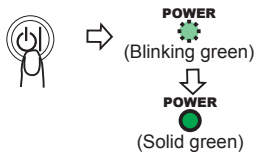

To display the picture, select an input signal according to the section "Selecting an input signal" (18).

Turning off the power

NOTE • Turn the power off in right order. Please power off the projector after the connected devices.

- Except for an emergency, whenever you turn the projector off, obey the procedure of the following "Turning off the power", and do not disconnect the power cord until the procedure is completed. Neglect causes a damage of the electrode and un-lighting of the lamp.
- This Projector is controlled by an internal microprocessor. Under certain exceptional circumstances, the projector may not operate correctly even for turning off the power. In such a case, please push the restart switch (4) by using a pin or similar. After making sure that the power indicator lights to solid orange, set the power switch to the OFF position. Only push the restart switch in these exceptional instances.
- When a power supply is shut off with a power failure or the restart switch, before turning on again, make the projector cool down at least 10 minutes without operating.

1. Press the STANDBY/ON button on the projector or remote control.
The message "Power off?" will appear on the screen for approximately 5 seconds.



2. Press the STANDBY/ON button on the projector or remote control again while the message is visible.
The projector lamp will go off, and the POWER indicator will begin blinking orange.
Then the POWER indicator will stop blinking and light to solid orange when the lamp cooling is complete.

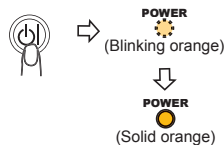

3. Make sure that the power indicator lights to solid orange, set the power switch to the OFF position. The POWER indicator will go off.
Do not set the power switch to the OFF position while the POWER indicator is green or blinking.



4. Close the lens cover. For safety purposes, disconnect the power cord if the projector is not to be used for prolonged periods of time.

Operating

Adjusting the volume

1. Press the VOLUME button on the remote control.
 - A dialog will appear on the screen to aid you in adjusting the volume.
2. Use the cursor buttons ▲/▼ to adjust the volume.
 - To close the dialog and complete the operation, press the VOLUME button again. Even if you don't do anything, the dialog will automatically disappear after a few seconds.

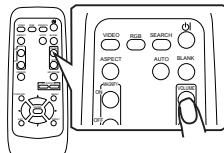

Temporarily muting the sound

1. Press the MUTE button on the remote control.
 - A dialog will appear on the screen indicating that you have muted the sound.
- To restore the sound, press the MUTE button or VOLUME button. Even if you don't do anything, the dialog will automatically disappear after a few seconds.

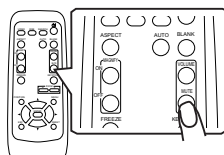

Selecting an input signal

1. Press the INPUT button on the projector.
 - Each time you press the button, the projector switches its input port as below.

RGB → S-VIDEO → VIDEO

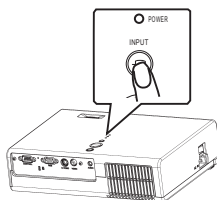

1. Press the RGB button on the remote control to select the RGB port.

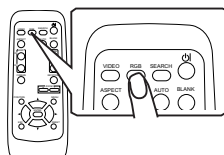

1. Press the VIDEO button on the remote control to select an input port for video signal.
 - Each time you press the button, the projector switches its video input port as below.

S-VIDEO → VIDEO

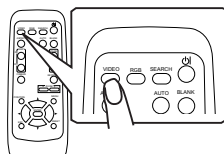

- When the TURN ON is selected to the item AUTO SEARCH of OPTION menu (p. 38), the projector selects the S-VIDEO port at first. If no input is detected at the S-VIDEO port, projector will check the VIDEO port automatically.

Searching an input signal

1. Press the SEARCH button on the remote control.
 - The projector will begin to check its input ports in order to find any input signals. Then when an input is found, the projector will stop searching and display the image. If no signal is found, the projector will return to the state selected before the operation.

RGB → S-VIDEO → VIDEO

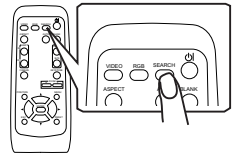

Selecting an aspect ratio

1. Press the ASPECT button on the remote control.
 - Each time you press the button, the projector switches the modes for aspect ratio in turn.

○ At a RGB signal

NORMAL → 4:3 → 16:9



○ At a video signal / no signal

4:3 → 16:9



- The NORMAL mode keeps the original aspect ratio of the signal.
- At a HDTV component video signal of 1125i (1080i) or 750p (720p), only 16:9 mode can be selected.
- Performing the automatic adjustment initializes the aspect ratio setting.

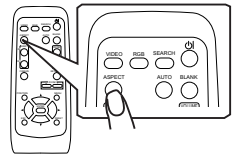

Adjusting the zoom (magnifying power)

1. Press the ZOOM +/- button on the remote control.
 - A dialog will appear on the screen to aid you in adjusting the zoom.
2. Use the ZOOM buttons +/- to adjust the zoom.
 - To close the dialog and complete this operation, don't perform operation for a few seconds.

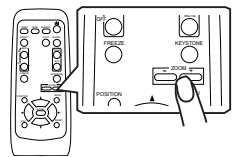

Adjusting the focus

1. Use the focus ring to focus on the picture.

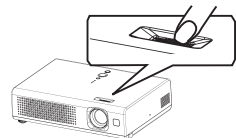

Using the automatic adjustment feature

1. Press the AUTO button on the remote control.

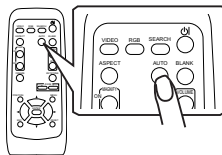

- **At a RGB signal**

The vertical position, the horizontal position, the clock phase and horizontal size will be automatically adjusted. And the aspect ratio will be automatically selected.

Make sure that the application window is set to its maximum size prior to attempting to use this feature. A dark picture may still be incorrectly adjusted. Use a bright picture when adjusting.

- **At a video signal or s-video signal**

The signal type mode best suited for the respective input signal and the aspect ratio will be selected automatically. And the vertical position, the horizontal position will be automatically adjusted.

- **At a component video signal**

The vertical position, the horizontal position and the clock phase will be automatically adjusted. And the aspect ratio will be automatically selected.

This function is available only when the AUTO mode is selected to the item VIDEO FORMAT of INPUT menu (p.32). For a component video signal, the signal type is identified automatically, independently of this function.

- The automatic adjustment operation requires approximately 10 seconds. Also please note that it may not function correctly with some input.

Adjusting the position

1. Press the POSITION button on the remote control.
The "POSITION" indication will appear on the screen.
2. Use the cursor buttons ▲/▼/◀/▶ to adjust the picture position.

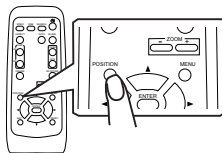

When you want to reset the operation, press the RESET button on the remote control during the operation.

To complete this operation, press the POSITION button again. Even if you don't do anything, the dialog will automatically disappear after a few seconds.

- When this function is performed at a video signal, a certain extra such as a line may appear outside a picture.

Correcting the keystone distortions

1. Press the KEYSTONE button on the remote control.
A dialog will appear on the screen to aid you in correcting the distortion.
2. Use the cursor buttons ▲/▼ to correct the distortion.
To close the dialog and complete this operation, press the KEYSTONE button again. Even if you don't do anything, the dialog will automatically disappear after a few seconds.

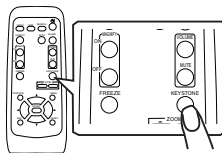

- This function may not work well with some input.
- The adjustable range for correcting will vary among inputs.

Using the partial magnify feature

1. Press the ON button of MAGNIFY on the remote control.
 - The “MAGNIFY” indication will appear on the screen (although the indication will disappear after several seconds with no operation.), and the projector will enter the MAGNIFY mode.
2. Use the cursor buttons ▲/▼ to adjust the zoom level.
 - To move the zoom area, press the POSITION button in the MAGNIFY mode, then use the cursor buttons ▲/▼/◀/▶. And to finalize the zoom area, press the POSITION button again.
 - To exit the MAGNIFY mode and restore the screen to normal, press the OFF button of MAGNIFY on the remote control.
 - The projector automatically exits the MAGNIFY mode when the input signal changes, or when an operation of changing the display condition (automatic adjustment, etc.) is executed.
 - Although the keystone distortion condition may vary in the MAGNIFY mode, it will be restored when the projector exit the MAGNIFY mode.

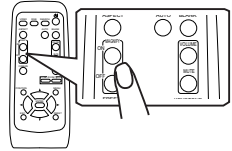

Freezing the screen

1. Press the FREEZE button on the remote control.
 - The “FREEZE” indication will appear on the screen, and the projector will enter the FREEZE mode.
 - To exit the FREEZE mode and restore the screen to normal, press the FREEZE button again.
 - The projector automatically exits the FREEZE mode when the input signal changes, or when one of the projector’s buttons or the remote control buttons of STANDBY/ON, SEARCH, RGB, VIDEO, BLANK, AUTO, ASPECT, VOLUME, MUTE, KEYSTONE, POSITION and MENU is pressed.
 - If the projector continues projecting a still image for long time, the LCD panel might possibly be printed. Do not leave the projector in FREEZE mode for too long.

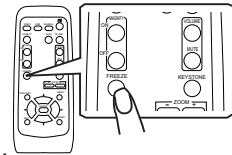

Temporarily blanking the screen

1. Press the BLANK button on the remote control.
 - The blank screen will be displayed instead of the screen of input signal. Please refer to the item BLANK of section SCREEN menu (35).
 - To remove the blank screen and return to the input signal screen, press the BLANK button again.
 - The projector automatically returns to the input signal screen when the input signal changes, or when one of the projector’s buttons or the remote control buttons are pressed.

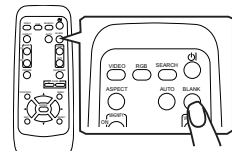

Multifunctional settings

NOTE • Regardless of description of this manual, these functions may not work correctly with some input.

Using the menu function

This projector has the following menus: PICTURE, IMAGE, INPUT, SETUP, SCREEN, OPTION and EASY MENU. Each of these menus is operated using the same methods. The basic operations of these menus are as follows.

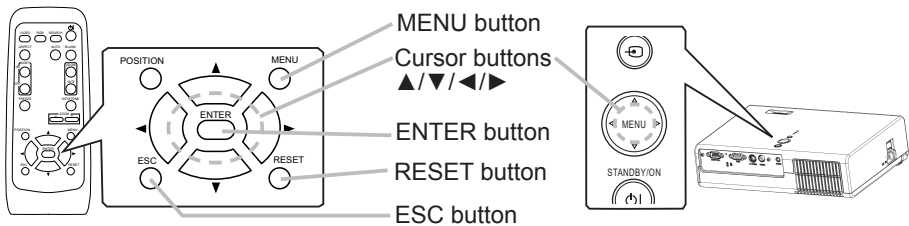

- To display a menu
 - Press the MENU button on the remote control or one of the cursor buttons ▲/▼/◀/▶ on the projector. The Advanced MENU or EASY MENU will appear.
- To choose the target menu
 - Point at one of choices on the menu using the cursor buttons ▲/▼, then press the cursor button ▶ or the ENTER button.
 - At the Advance menu, when some menu is chosen already and you want to choose other menu, please return to the main menu beforehand, using the cursor button ◀ or the ESC button before choosing the menu.

(1) EASY MENU → Advance MENU (Main)

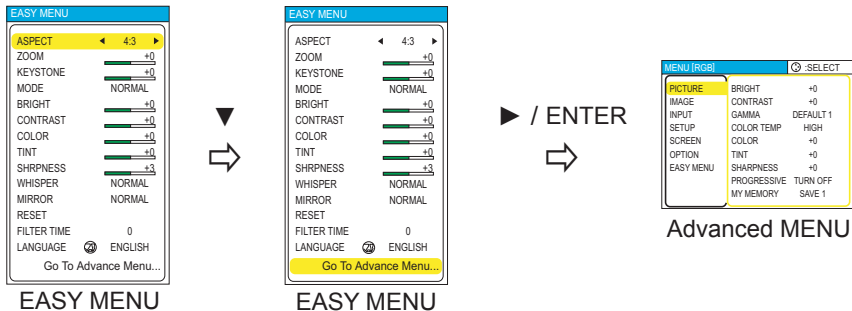

(2) Main of Advanced MENU Main → one of Advanced Menus (ex. SETUP menu)

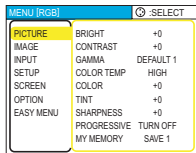

Main of Advanced MENU

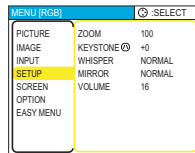

Main of Advanced MENU

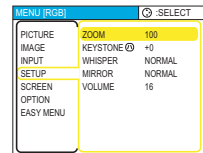

SETUP menu of Advanced MENU

(3) Advanced Menu (Main) → EASY MENU

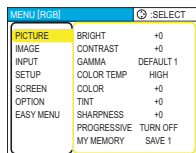

Advanced Menu (Main)

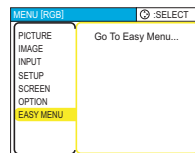

Advanced Menu (Main)

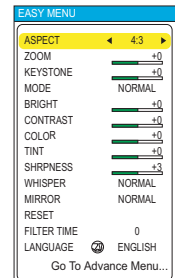

EASY MENU

3. To choose the target item

Point at one of choices on the menu using the cursor buttons ▲/▼. At an Advanced menu, then press the cursor button ► or the ENTER button.

(1) At EASY MENU (ex. KEYSTONE)

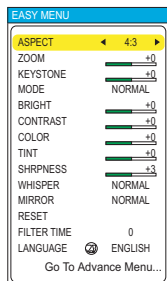

ASPECT is chosen

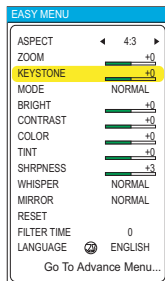

KEYSTONE is chosen

(2) At Advanced Menu (ex. KEYSTONE)

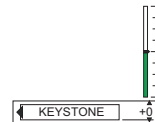
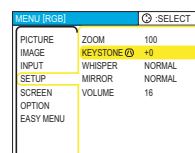
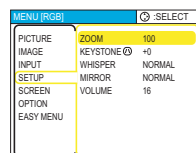

KEYSTONE is chosen

4. To operate
 - (1) At EASY MENU, use the cursor buttons ◀/▶ to operate.
 - (2) At Advanced MENU, use the cursor buttons ▲/▼.

5. To return to the previous menu
 - (1) One of Advanced Menus (ex. SETUP menu) → Main of Advanced MENU

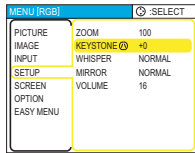

SETUP MENU of Advanced MENU

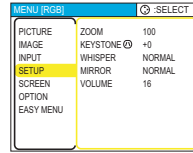

Main of Advanced MENU

- (2) Dialogs for operation (ex. KEYSTONE) → Advanced MENU



Dialog for KEYSTONE

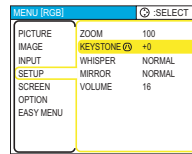

SETUP menu

6. To reset
 - (1) Each item
 - Press the RESET button while operating.
 - (2) Items of EASY MENU (at a time)
 - Point at “RESET” on the menu using the cursor buttons ▲/▼, then press the cursor button ▶ or the ENTER button. The dialog for reset will appear. Point at “RESET” on the dialog using the cursor button ▲.
 - (3) Items of an Advanced MENU
 - Press the RESET button while pointing the menu name. The dialog for reset will appear. Point at “RESET” on the dialog using the cursor button ▲.



Note that items whose functions are performed simultaneously with operation (ex. LANGUAGE, H PHASE etc.) aren't reset.

7. To close the menu
 - Press the MENU button again.

Even if you don't do anything, the operation will complete and the menu will disappear automatically after about 10 seconds.

EASY MENU

With the EASY MENU, items shown in the table below can be performed.

Choose an item using the cursor buttons ▲/▼ on the projector or remote control. Then perform it referring to the following table.

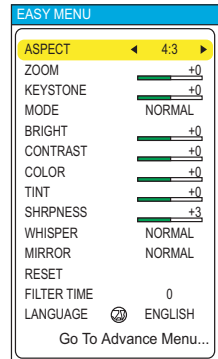

Item	Description
ASPECT	Using the buttons ◀/▶ switches the mode for aspect ratio. See the item ASPECT of section IMAGE menu. (📖30, 19)
ZOOM	Using the buttons ◀/▶ adjusts the zoom. See the item ZOOM of section SETUP menu. (📖34, 19)
KEYSTONE	Using the buttons ◀/▶ corrects the keystone distortion. See the item KEYSTONE of section SETUP menu. (📖34, 20)
MODE	Using the buttons ◀/▶ switches the mode of picture type. The modes of picture type are combinations of a mode of GAMMA (📖27) and a mode of COLOR TEMP (📖28). Choose a suitable mode according to the projected source. NORMAL ⇄ CINEMA ⇄ DYNAMIC ↑—————↑ NORMAL: (COLOR TEMP = MIDDLE) + (GAMMA = #1 DEFAULT) CINEMA: (COLOR TEMP = LOW) + (GAMMA = #2 DEFAULT) DYNAMIC: (COLOR TEMP = HIGH) + (GAMMA = #3 DEFAULT) • When the combination of GAMMA and COLOR TEMP differs from pre-assigned modes above, the display on the menu for the MODE is "CUSTOM".
BRIGHT	Using the buttons ◀/▶ adjusts the brightness. See the item BRIGHT of section PICTURE menu. (📖27)
CONTRAST	Using the buttons ◀/▶ adjusts the contrast. See the item CONTRAST of section PICTURE menu. (📖27)
COLOR	Using the buttons ◀/▶ adjusts the strength of whole color. See the item COLOR of section PICTURE menu. (📖28) • This item can be chosen only at a video signal.
TINT	Using the buttons ◀/▶ adjusts the tint. See the item TINT of section PICTURE menu. (📖28) • This item can be chosen only at a video signal.

EASY MENU (continued)

Item	Description
SHARPNESS	Using the buttons ◀/▶ adjusts the sharpness. See the item SHARPNESS of section PICTURE menu. (📖28)
WHISPER	Using the buttons ◀/▶ turns off/on the whisper mode. See the item WHISPER of section SETUP menu. (📖34)
MIRROR	Using the buttons ◀/▶ switches the mode for mirror status. See the item MIRROR of section SETUP menu. (📖34)
RESET	Performing this item resets all of the items of EASY MENU except FILTER TIME and LANGUAGE. Pressing the button ▶ displays a dialog to make sure. To perform reset, point at RESET using the button ▲. (📖24)
FILTER TIME	Performing this item resets the filter timer which counts use time of air filter. See the item FILTER TIME of section OPTION menu. (📖39)
LANGUAGE	Using the buttons ◀/▶ switches the language of menu. See the item LANGUAGE of section SCREEN menu. (📖35)
Go To Advanced Menu	Pointing at the “Go To Advanced Menu” and pressing the button ▶ changes the EASY MENU into the Advanced MENU. (📖22) Performs to use the menu of PICTURE, IMAGE, INPUT, SETUP, SCREEN or OPTION.

PICTURE menu

With the PICTURE menu, items shown in the table below can be performed.

Choose an item using the cursor buttons ▲/▼ on the projector or remote control, and press the cursor button ► on the projector or remote control, or the ENTER button on the remote control to progress. Then perform it referring to the following table.

MENU [RGB]		◀.SELECT
PICTURE	BRIGHT	+0
IMAGE	CONTRAST	+0
INPUT	GAMMA	DEFAULT 1
SETUP	COLOR TEMP	HIGH
SCREEN	COLOR	+0
OPTION	TINT	+0
EASY MENU	SHARPNESS	+0
	PROGRESSIVE	TURN OFF
	MY MEMORY	SAVE 1

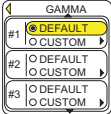
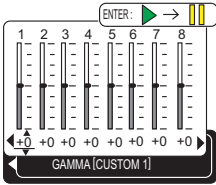
Item	Description
BRIGHT	Using the buttons ▲/▼ adjusts the brightness. : Light ⇄ Dark
CONTRAST	Using the buttons ▲/▼ adjusts the contrast. : Strong ⇄ Weak
GAMMA	<p>Using the buttons ▲/▼ switches the GAMMA mode.</p> <p>#1 DEFAULT ⇄ #1 CUSTOM ⇄ #2 DEFAULT</p> <p>⇕</p> <p>#3 CUSTOM ⇄ #3 DEFAULT ⇄ #2 CUSTOM</p>  <p>To adjust #1 CUSTOM, #2 CUSTOM or #3 CUSTOM</p> <p>Selecting a mode of CUSTOM and then pressing the button ► or the ENTER button displays a dialog to aid you in adjusting the mode.</p> <p>This function is useful when you want to change the brightness of particular tones.</p> <p>Choose an item using the buttons ◀/▶, and adjust the level using the buttons ▲/▼.</p>  <p>Using a test pattern</p> <p>You can display a test pattern for checking the effect of your adjustment by pressing the ENTER button. Each time you press the ENTER button, the pattern changes as below.</p> <p>No pattern ⇄ Gray scale of 9 steps ⇄ Ramp ⇄ Gray scale of 15 steps</p> <p>Eight of equalizing bars corresponds to eight of tone level of test pattern except the darkest in the left end. If you want to adjust the 2nd tone from left end on the test pattern, use the equalizing adjustment bar "1". The darkest tone at the left end of the test pattern cannot be controlled with any of equalizing adjustment bar.</p>

PICTURE menu (continued)

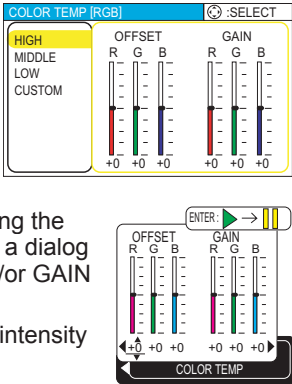
Item	Description
<p>COLOR TEMP</p>	<p>Using the buttons ▲/▼ switches the mode of color temperature.</p> <p>HIGH ⇔ MIDDLE ⇕ ⇕ CUSTOM ⇔ LOW</p> <p>To adjust CUSTOM</p> <p>Selecting the CUSTOM and then pressing the button ► or the ENTER button displays a dialog to aid you in adjusting the OFFSET and/or GAIN of CUSTOM mode.</p> <p>OFFSET adjustments change the color intensity on the whole tones of the test pattern.</p> <p>GAIN adjustments mainly affect color intensity on the brighter tones of the test pattern.</p> <p>Choose an item using the buttons ◀/▶, and adjust the level using the buttons ▲/▼.</p> <p>Using a test pattern</p> <p>You can display a test pattern for checking the effect of your adjustment by pressing the ENTER button. Each time you press the ENTER button, the pattern changes as below.</p> <p>No pattern ⇔ Gray scale of 9 steps ⇐ ⇐ ⇐ Ramp ⇔ Gray scale of 15 steps</p> 
<p>COLOR</p>	<p>Using the buttons ▲/▼ adjusts the strength of whole color.</p> <p>Strong ⇔ Weak</p> <ul style="list-style-type: none"> • This item can be chosen only at a video signal.
<p>TINT</p>	<p>Using the buttons ▲/▼ adjusts the tint.</p> <p>Green ⇔ Red</p> <ul style="list-style-type: none"> • This item can be chosen only at a video signal.
<p>SHARPNESS</p>	<p>Using the buttons ▲/▼ adjusts the sharpness.</p> <p>Strong ⇔ Weak</p>

PICTURE menu (continued)

Item	Description
<p>PROGRESSIVE</p>	<p>Using the buttons ▲/▼ switches the progressive mode. TV ⇔ FILM ⇔ TURN OFF </p> <ul style="list-style-type: none"> • This function performs only at an interlaced signal of a VIDEO input, a S-VIDEO input or a component video input of 525i (480i) or 625i (576i) signal. • When the TV or FILM is selected, the screen image will be crisper. The FILM mode is adaptable to the 2-3 Pull-Down system to the conversion. (not adaptable to the 2-2 Pull-Down system) But these may cause a certain defect (for example, jagged line) of the picture at a quick moving object. In such a case, please select the TURN OFF, even though the screen image may lose the crisp.
<p>MY MEMORY</p>	<p>Choosing a mode of MY MEMORY using the buttons ▲/▼ and then pressing the button ► or the ENTER button performs each function.</p>  <p>This projector has 4 numbered memories for adjustment data. Performing the LOAD1, LOAD2, LOAD3 or LOAD4 loads the data on the memory whose number corresponds with the command's number, and adjusts the picture automatically depending on the data. Performing the SAVE1, SAVE2, SAVE3 or SAVE4 puts the current adjustment data on the memory whose number corresponds with the command's number.</p>

IMAGE menu

With the IMAGE menu, items shown in the table below can be performed.

Choose an item using the cursor buttons ▲/▼ on the projector or remote control, and press the cursor button ► on the projector or remote control, or the ENTER button on the remote control to progress. Then perform it referring to the following table.

MENU [RGB]		◀:SELECT
PICTURE	ASPECT	4:3
IMAGE	OVER SCAN	95
INPUT	V POSITION	25
SETUP	H POSITION	142
SCREEN	H PHASE	16
OPTION	H SIZE	1344
EASY MENU	AUTO ADJUST EXECUTE	

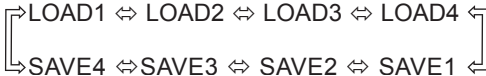
Item	Description
ASPECT	<p>Using the buttons ▲/▼ switches the mode for aspect ratio.</p> <p>At a RGB signal 4:3 ⇔ 16:9 ⇔ NORMAL ↑—————↑</p> <p>At a video signal / no signal 4:3 ⇔ 16:9 ↑—————↑</p> <ul style="list-style-type: none"> • The NORMAL mode keeps the original aspect ratio of the signal. • At a HDTV component video signal of 1125i (1080i) or 750p (720p), this item can't be chosen. • Performing the automatic adjustment initializes the aspect ratio setting.
OVER SCAN	<p>Using the buttons ▲/▼ adjusts the over-scan ratio. Large (It reduces picture) ⇔ Small (It magnifies picture)</p> <ul style="list-style-type: none"> • This item can be chosen only at a video signal. • When this adjustment is too large, certain degradation may appear at the frame area of the picture. In such a case, please adjust small. • The number displayed on the menu during this adjustment is just for your reference, and might not be exact display ratio.
V POSITION	<p>Using the buttons ▲/▼ adjusts the vertical position. Up ⇔ Down</p>
H POSITION	<p>Using the buttons ▲/▼ adjusts the horizontal position. Left ⇔ Right</p>
H PHASE	<p>Using the buttons ▲/▼ adjusts the horizontal phase to eliminate flicker. Right ⇔ Left</p> <ul style="list-style-type: none"> • This item can be chosen only at a RGB signal or a component video signal (except 525i (480i) and 625i (576i)).

IMAGE menu (continued)

Item	Description
H SIZE	<p>Using the buttons ▲/▼ adjusts the horizontal size. Large ⇄ Small</p> <ul style="list-style-type: none"> • This item can be chosen only at a RGB signal. • When this adjustment is excessive, the picture may not be displayed correctly. In such a case, please reset the adjustment pressing the RESET button during this operation.
AUTO ADJUST EXECUTE	<p>Choosing this item performs the automatic adjustment feature.</p> <p>At a RGB signal The vertical position, the horizontal position, the clock phase and horizontal size will be automatically adjusted. And the aspect ratio (ASPECT) will be automatically selected. Make sure that the application window is set to its maximum size prior to attempting to use this feature. A dark picture may still be incorrectly adjusted. Use a bright picture when adjusting.</p> <p>At a video signal or s-video signal The signal type mode best suited for the respective input signal and the aspect ratio (ASPECT) will be selected automatically. And the vertical position (V POSITION), the horizontal position (H POSITION) will be automatically adjusted.</p> <p>At a component video signal The vertical position (V POSITION), the horizontal position (H POSITION) and the clock phase (H POSITION) will be automatically adjusted. And the aspect ratio (ASPECT) will be automatically selected.</p> <ul style="list-style-type: none"> • This function is available only when the AUTO mode is selected to the item VIDEO FORMAT of INPUT menu. For a component video signal, the signal type is identified automatically independently of this function. • The automatic adjustment operation requires approximately 10 seconds. Also please note that it may not function correctly with some input. • This operation may not work well at some signals. If the picture becomes unstable (ex. a irregular picture, a color lack), please select the suitable mode to the item "VIDEO" of the INPUT menu.

INPUT menu (continued)

Item	Description
FRAME LOCK	<p>Using the buttons ▲/▼ turns the frame lock function on/off. TURN ON ⇔ TURN OFF</p> <ul style="list-style-type: none"> • This item performs only at a RGB signal with vertical frequency of 50 to 60 Hz. • When the TURN ON is selected, a moving picture is displayed more smoothly. • This function may cause a certain degradation of the picture. In such a case, please select the TURN OFF.
INFORMATION	<p>Choosing this item displays a dialog titled “INPUT INFORMATION”. It shows the information about the current input.</p> <div style="display: flex; justify-content: space-around; align-items: center;"> <div data-bbox="515 581 636 646" style="border: 1px solid black; padding: 5px; text-align: center;"> ◀ INPUT-INFORMATION RGB 1024x768 @60.0 FRAME LOCK </div> <div data-bbox="757 581 878 646" style="border: 1px solid black; padding: 5px; text-align: center;"> ◀ INPUT-INFORMATION S-VIDEO SECAM AUTO </div> </div> <ul style="list-style-type: none"> • The “FRAME LOCK” message on the dialog means the frame lock function is working. (📖33) • This item can't be chosen at no signal.

SETUP menu

With the SETUP menu, items shown in the table below can be performed.

Choose an item using the cursor buttons ▲/▼ on the projector or remote control, and press the cursor button ► on the projector or remote control, or the ENTER button on the remote control to progress. Then perform it referring to the following table.

MENU [RGB]		◀:SELECT
PICTURE	ZOOM	100
IMAGE	KEYSTONE	+0
INPUT	WHISPER	NORMAL
SETUP	MIRROR	NORMAL
SCREEN	VOLUME	16
OPTION		
EASY MENU		

Item	Description
ZOOM	Using the buttons ▲/▼ adjusts the zoom (magnifying power). Large ⇔ Small
KEYSTONE	Using the buttons ▲/▼ corrects the keystone distortion. Upper in the data ⇔ Lower in the data <ul style="list-style-type: none"> • The adjustable range of this function will vary with the type of input signal. At some signals, this function may not work well. • When the V:INVERT or the H&V:INVERT is selected under the item MIRROR, if the projector screen is inclined or if the projector is angled downward, this function may not work correctly. • When the zoom adjustment is set to the TELE side, this correction may be excessive. This function should be used with zoom set to WIDE whenever possible.
WHISPER	Using the buttons ▲/▼ turns off/on the whisper mode. NORMAL ⇔ WHISPER <ul style="list-style-type: none"> • When the WHISPER is selected, acoustic noise and screen brightness are reduced.
MIRROR	Using the buttons ▲/▼ switches the mode for mirror status.  NORMAL ⇔ H:INVERT ⇔ V:INVERT ⇔ H&V:INVERT
VOLUME	Using the buttons ▲/▼ adjusts the volume. High ⇔ Low

SCREEN menu

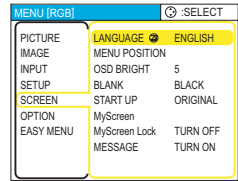

With the SCREEN menu, items shown in the table below can be performed.

Choose an item using the cursor buttons ▲/▼ on the projector or remote control, and press the cursor button ► on the projector or remote control, or the ENTER button on the remote control to progress. Then perform it referring to the following table.

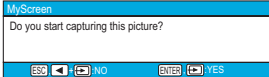
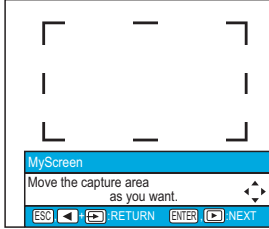

Item	Description
LANGUAGE	<p>Using the buttons ▲/▼ switches the OSD (On Screen Display) language.</p> <p>ENGLISH ⇔ FRANÇAIS ⇔ DEUTSCH ⇔ ESPAÑOL ⇔ ITALIANO NORSK ⇔ NEDERLANDS ⇔ PORTUGUÉS ⇔ 日本語 简体中文 ⇔ 繁體中文 ⇔ 한글 ⇔ SVENSKA ⇔ РУССКИЙ SUOMI ⇔ POLSKI ⇔ TÜRKÇE</p>
MENU POSITION	<p>Using the buttons ◀/▶/▲/▼ adjusts the menu position. To quit the operation, press the MENU button or keep no operation for 10 seconds.</p>
OSD BRIGHT	<p>Using the buttons ▲/▼ switches the brightness level of the OSD (On Screen Display). Bright ⇔ Dark</p>
BLANK	<p>Using the buttons ▲/▼ switches the mode for the blank screen. The blank screen is the screen for the temporarily blanking feature (📄21). It is displayed by pressing the BLANK button. MyScreen ⇔ ORIGINAL ⇔ BLUE ⇔ WHITE ⇔ BLACK</p> <p>MyScreen is the screen you can register a desired screen. ORIGINAL screen is the existing standard screen. BLUE, WHITE and BLACK are non-patterned (plain) screens in each color.</p> <ul style="list-style-type: none"> • To avoid remaining as an afterimage, the MyScreen and the ORIGINAL screens will change to the BLACK screen after several minutes. • For the MyScreen, please refer to the item MyScreen (📄36).

SCREEN menu (continued)

Item	Description
<p>START UP</p>	<p>Using the buttons ▲/▼ switches the mode for the start up screen. The start up screen is the screen displayed when no signal or an unsuitable signal is detected.</p> <p style="text-align: center;">MyScreen ⇄ ORIGINAL ⇄ TURN OFF </p> <p>MyScreen is the screen you can register a desired screen. ORIGINAL screen is the existing standard screen. When the TURN OFF is selected, the BLUE screen is used.</p> <ul style="list-style-type: none"> • To avoid remaining as an afterimage, the MyScreen and the ORIGINAL screens will change to the BLANK screen after several minutes. If also the BLANK screen is the MyScreen or ORIGINAL, it will change to the BLACK screen. • For the MyScreen, please refer to the item MyScreen below. <p>About the BLUE, BLACK and BLANK screens, please refer to the item BLANK (35).</p>
<p>MyScreen</p>	<p>This item functions for capturing the MyScreen of the blank screen and the start up screen. Please execute displaying the input including the picture you want to capture.</p> <ol style="list-style-type: none"> 1. Choosing this item displays a dialog titled “MyScreen”. It will ask you if you start capturing the picture from the current screen. Please wait for the target picture to be displayed. 2. Press the ENTER button when the picture is display. The picture will freeze and the frame for capturing appears. To stop performing, press the RESET or ESC button. 3. Using the buttons ◀/▶/▲/▼ adjust the frame position. Please move the frame to the position of the picture which you want to use. To start registration, press the ENTER button. To restore the screen and return to the previous dialog, press the RESET or ESC button. <p>Registration takes several minutes. When the registration is completed, the registered screen and the message “MyScreen registration is finished.” are displayed for several seconds. If the registration failed, the message “A capturing error has occurred. Please try again.” is displayed.</p> <div style="display: flex; justify-content: space-between;"> <div style="width: 60%;">  </div> <div style="width: 35%;">  </div> </div> <div style="display: flex; justify-content: space-between; margin-top: 10px;"> <div style="width: 60%;">  </div> </div>

SCREEN menu (continued)

Item	Description
MyScreen Lock	Using the buttons ▲/▼ turns on/off the MyScreen lock function. TURN ON ⇔ TURN OFF When the TURN ON is selected, the item MyScreen cannot be performed. Use this function for protecting the current MyScreen.
MESSAGE	Using the buttons ▲/▼ turns on/off the message function. TURN ON ⇔ TURN OFF When the TURN ON is selected, the following message function works. "AUTO IN PROGRESS" while automatically adjusting "NO INPUT IS DETECTED" "SYNC IS OUT OF RANGE" "Searching" while searching for an input signal "Detecting...." when an input signal is detected The indication of the input signal by changing The indication of the aspect ration by changing

OPTION menu

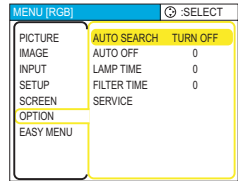

With the OPTION menu, items shown in the table below can be performed.

Choose an item using the cursor buttons ▲/▼ on the projector or remote control, and press the cursor button ► on the projector or remote control, or the ENTER button on the remote control to progress, except for the items LAMP TIME and FILTER TIME. Then perform it referring to the following table.



Item	Description
<p>AUTO SEARCH</p>	<p>Using the buttons ▲/▼ turns on/off the automatic signal search function.</p> <p>TURN ON ⇔ TURN OFF</p> <p>When the TURN ON is selected, detecting no signal automatically cycles through input ports in order of following. Then when an input is found, the projector will stop searching and display the image.</p> <p>RGB ⇒ S-VIDEO ⇒ VIDEO</p>
<p>AUTO OFF</p>	<p>Using the buttons ▲/▼ adjusts the time to count down to automatically turn the projector off.</p> <p>Long (max. 99 minutes) ⇔ Short (min. 0 minute = DISABLE)</p> <div style="display: flex; justify-content: space-around;"> <div data-bbox="495 862 589 935"> </div> <div data-bbox="747 862 842 935"> </div> </div> <p>When the time is set to 0, the projector is not turned off automatically.</p> <p>When the time is set to 1 to 99, and when the passed time with a no-signal or an unsuitable signal reaches at the set time, the projector lamp will go off and the power indicator begins blinking. Please refer to the section “Turning off the power” (17).</p>

OPTION menu (continued)

Item	Description
<p>LAMP TIME</p>	<p>The lamp time is the time counted after the last resetting. It is shown in the OPTION menu as the use time of the lamp. Performing this item resets the time.</p> <p>Pressing the RESET button on the remote control or the button ► on the projector for about 3 seconds displays a dialog to make sure. To perform reset, point at RESET using the button ▲.</p> <p>RESET ⇐ CANCEL</p>  <ul style="list-style-type: none"> • Please reset the lamp time only when you have replaced the lamp, for correct messages about the lamp. • About the lamp replacement, please see the section "Lamp" (41, 42).
<p>FILTER TIME</p>	<p>The filter time is the time counted after the last resetting. It is shown in the OPTION menu as the use time of the air filter. Performing this item resets the time.</p> <p>Pressing the RESET button on the remote control or the button ► on the projector for about 3 seconds displays a dialog to make sure. To perform reset, point at RESET using the button ▲.</p> <p>RESET ⇐ CANCEL</p>  <ul style="list-style-type: none"> • Please reset the filter time only when you have cleaned or replaced the air filter, for correct messages about the air filter. • About the caring the air filter, please see the section "Air filter" (43).

OPTION menu (continued)

Item	Description
<p>SERVICE</p>	<p>Choosing this item displays the SERVICE menu. Choose an item using the buttons ▲/▼, and press the button ► or the ENTER button to progress.</p> <div style="display: flex; justify-content: space-around; align-items: center;"> <div style="text-align: center;"> <p>FAN SPEED ⇄ AUTO ADJUST</p> <p>↑↓</p> <p>FACTORY RESET ⇄ GHOST</p> </div> <div style="border: 1px solid black; padding: 5px;"> <p>SERVICE SELECT</p> <p>FANSPEED NORMAL</p> <p>AUTO ADJUST</p> <p>GHOST</p> <p>FACTORY RESET</p> </div> </div> <p>FAN SPEED: Using the buttons ▲/▼ switches the rotation speed of the cooling fans. The HIGH is the mode for use at highlands etc. Note that the projector is noisier when the HIGH is selected.</p> <div style="display: flex; justify-content: space-around; align-items: center;"> <div style="text-align: center;"> <p>HIGH ⇄ NORMAL</p> </div> <div style="border: 1px solid black; padding: 5px;"> <p>FANSPEED</p> <p>● HIGH</p> <p>○ NORMAL</p> </div> </div> <p>AUTO ADJUST: Using the buttons ▲/▼ enables or disables the automatic adjustment. Depending on conditions, such as input image, signal cable to the unit, environment around the unit, etc., the automatic adjustment may not work correctly. In such a case, please choose DISABLE to disable the automatic adjustment, and adjust manually.</p> <div style="display: flex; justify-content: space-around; align-items: center;"> <div style="text-align: center;"> <p>ENABLE ⇄ DISABLE</p> </div> <div style="border: 1px solid black; padding: 5px;"> <p>AUTO ADJUST</p> <p>● ENABLE</p> <p>○ DISABLE</p> </div> </div> <p>GHOST:</p> <ol style="list-style-type: none"> 1. Choose a color element of ghost using the buttons ◀/▶. 2. Adjust the chosen element using the buttons ▲/▼ to disappear ghost. <div style="display: flex; justify-content: flex-end; align-items: center;"> <div style="border: 1px solid black; padding: 5px; margin-right: 10px;"> <p>R G B</p> <p>← +0 +0 +0 →</p> </div> <div style="border: 1px solid black; padding: 5px;"> <p>GHOST</p> </div> </div> <p>FACTORY RESET: To perform reset, point at RESET using the button ▲.</p> <p>By this function, all the items in all of menu will collectively return to the initial setting. Note that the items LAMP TIME, FILTER TIME and LANGUAGE are not reset.</p> <div style="display: flex; justify-content: space-around; align-items: center;"> <div style="text-align: center;"> <p>RESET ⇄ CANCEL</p> </div> <div style="border: 1px solid black; padding: 5px;"> <p>FACTORY RESET</p> <p>RESET</p> <p>CANCEL</p> </div> </div>

Maintenance

Lamp

**WARNING**

HIGH VOLTAGE



HIGH TEMPERATURE



HIGH PRESSURE

► The projector uses a high-pressure mercury glass lamp. The lamp can break with a loud bang, or burn out, if jolted or scratched, handled while hot, or worn over time. Note that each lamp has a different lifetime, and some may burst or burn out soon after you start using them. In addition, when the bulb bursts, it is possible for shards of glass to fly into the lamp housing, and for gas containing mercury to escape from the projector's vent holes.

► **About disposal of a lamp** • This product contains a mercury lamp; do not put in trash. Dispose of in accord with environmental laws. For lamp recycling, go to www.lamprecycle.org. (in the US) For product disposal, contact your local government agency or www.eiae.org (in the US) or www.epsc.ca (in Canada). For more information, call your dealer.



Disconnect
the plug
from the
power
outlet

- If the lamp should break (it will make a loud bang when it does), unplug the power cord from the outlet, and make sure to request a replacement lamp from your local dealer. Note that shards of glass could damage the projector's internals, or cause injury during handling, so please do not try to clean the projector or replace the lamp yourself.
- If the lamp should break (it will make a loud bang when it does), ventilate the room well, and make sure not to breathe the gas that comes out of the projector vents, or get it in your eyes or mouth.
- Before replacing the lamp, turn the projector off and unplug the power cord, then wait at least 45 minutes for the lamp to cool sufficiently. Handling the lamp while hot can cause burns, as well as damaging the lamp.



- Never unscrew except the appointed (marked by an arrow) screws.
- Do not open the lamp cover while the projector is suspended from above. This is dangerous, since if the lamp's bulb has broken, the shards will fall out when the cover is opened. In addition, working in high places is dangerous, so ask your local dealer to have the lamp replaced even if the bulb is not broken.
- Do not use the projector with the lamp cover removed. At the lamp replacing, make sure that the screws are screwed in firmly. Loose screws could result in damage or injury.



- Use only the lamp of the specified type.
- If the lamp breaks soon after the first time it is used, it is possible that there are electrical problems elsewhere besides the lamp. If this happens, contact your local dealer or a service representative.
- Handle with care: jolting or scratching could cause the lamp bulb to burst during use.
- If the indicators or a message prompts you to replace the lamp (see the section "Related Messages" and "Regarding the indicator Lamps"), replace the lamp as soon as possible. Using the lamp for long periods of time, or past the replacement date, could cause it to burst. Do not use old (used) lamps; this is a cause of breakage.

Lamp (continued)

When the indicators or a message prompts you to replace the lamp, replace the lamp as soon as possible.

1. Turn the projector off, and unplug the power cord. Allow the lamp to cool for at least 45 minutes.
2. To prepare a new lamp, contact your dealer and tell the lamp type number = **DT00701**. If the projector is mounted on the ceiling, or if the lamp has broken, also ask the dealer to replace the lamp.

In the case of replacement by yourself,

3. After making sure that the projector has cooled adequately, slowly turn over the projector, so that the bottom is facing up.
4. Please loosen the screw (marked by arrow). Then, unhook the claws of the lamp cover and remove the lamp cover.
5. Loosen the 2 screws (marked by arrow) of the lamp, and slowly pick up the lamp by the handles.
6. Insert the new lamp, and retighten firmly two screws that are loosened in the previous process to lock it in place.
7. Interlocking the 2 tabs of the lamp cover to the projector, position the lamp cover on the projector, and push the center point of two claws to fix the lamp cover. Then retighten firmly the screw of the lamp cover.
8. Slowly turn the projector so that the top is facing up.
9. Turn the projector on, and reset the lamp time using the LAMP TIME function of OPTION menu (📖 39).

Claws of lamp cover

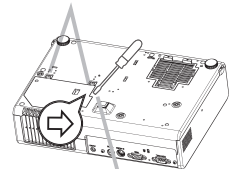

Screw marked by arrow

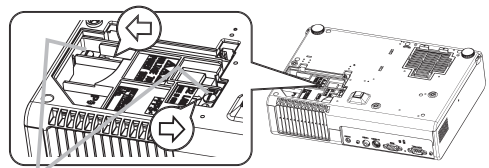

Screws marked by arrow

Center point of claws
Tabs

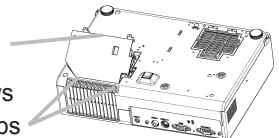

NOTE • When the lamp has been replaced after the message of "THE POWER WILL TURN OFF AFTER 0hr." is displayed, complete the following operation within 10 minutes of switching power on.
 • Incorrectly resetting of the lamp timer (resetting without replacement, or neglect of resetting after replacement) will result in incorrect message functions.

Air filter

- ⚠ WARNING** ▶ Do not replace the air filter during use or immediately after use. Handling while the projector is in a high temperature could cause a burn and/or malfunction to the projector. Before operating, make sure that the power switch is off, that the power cord is not plugged in, and that the projector is cool adequately.
- ▶ Use only the air filter of the specified type. Do not use the projector with the air filter and filter cover removed.
- ▶ Avoid wetting the projector or inserting liquids in the projector. It could result in a fire, an electric shock, and/or malfunction to the projector.
- ⚠ CAUTION** ▶ Please replace the air filter when it is damaged or too soiled, and also when you replace the lamp.

When the indicators or a message prompts you to clean the air filter, clean the air filter as soon as possible. If the air filter becomes clogged by dust or the like, internal temperatures rise and the power may be automatically turned off for malfunction prevention.

1. Disconnect all the connectors and adapters that were connected to the projector's ports. Then slowly turn the projector so that the lens-side is facing up. Please be careful for a projector not to fall. While the projector is placed lens-side up, hold the projector.
2. Remove the filter cover and the air filter. Hold the knobs while pulling out it.

Usual filter cover

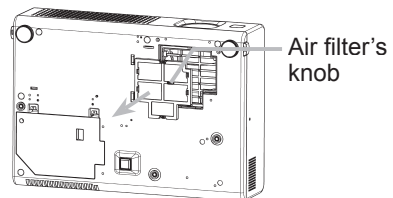
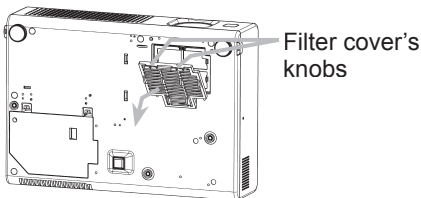

Filter cover for bottom-up use

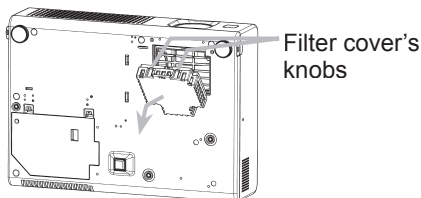

3. Apply a vacuum cleaner to the vent of the projector for the air filter. And then slowly turn the projector bottom up.

Air filter (continued)

4. Apply a vacuum cleaner to the air filter and filter cover. Then set a new or cleaned air filter into place. In case of the filter cover for bottom-up use, remove the air filter from the filter cover and clean each. After cleaning, reattach the cleaned filter to the filter cover.

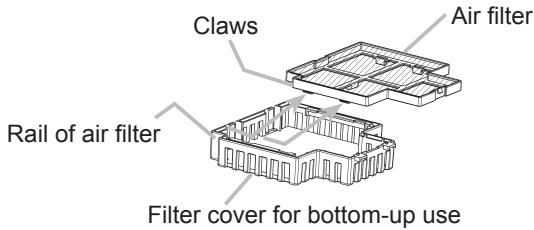

Please replace the air filter when it is damaged or too soiled.

To prepare a new air filter, contact your dealer and tell the air filter type number = **NJ20922**.

An air filter of specified type will come even with the replacement lamp for this projector.

5. Position the air filter and filter cover into place.

Usual filter cover

Push the points of "PUSH" word with claws to fix the air filter.

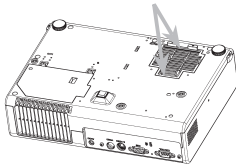

Interlocking the tabs, snap the filter cover into place.

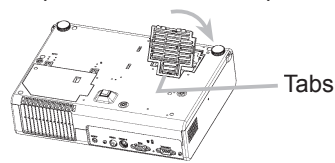

Filter cover for bottom-up use

Interlocking the tabs, snap the filter cover into place.

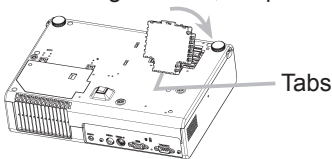

6. Slowly turn the projector so that the top is facing up, except for the case of bottom-up use.
7. Turn the projector on, and reset the filter time using the FILTER TIME function of OPTION menu. (📖39)

NOTE • Incorrectly resetting of the filter timer (resetting without replacement, or neglect of resetting after replacement) will result in incorrect message functions.

Other care

- ⚠ WARNING** ▶ Do not take care of the projector during use or immediately after use. Handling while the projector is in a high temperature could cause a burn and/or malfunction to the projector. Before operating, make sure that the power switch is off, that the power cord is not plugged in, and that the projector is cool adequately.
- ▶ Never try to care for the inside of the projector personally. Doing is so dangerous.
 - ▶ Avoid wetting the projector or inserting liquids in the projector. It could result in a fire, an electric shock, and/or malfunction to the projector.
 - Don't put a container containing water, cleaner or chemicals near the projector.
 - Don't use aerosols or sprays.
- ⚠ CAUTION** ▶ Please take right care of the projector according to the following. Incorrect care could cause not only an injury but adverse influence such as discoloration, peeling paint, etc.
- Do not use cleaner or chemicals other than those listed below.
 - Do not polish or wipe with hard objects.

Inside of the projector

In order to ensure the safe use of your projector, please have it cleaned and inspected by your dealer about once every year.

Caring for the lens

If the lens is flawed, soiled or fogged, it could cause deterioration of display quality. Please take care of the lens, being cautious of the handling.

1. Turn the projector off, and unplug the power cord. Allow the projector to cool sufficiently.
2. After making sure that the projector is cool adequately, lightly wipe the lens with a commercially available lens-cleaning wipe. Do not touch the lens directly with your hand.

Caring for the cabinet and remote control

Incorrect care could have adverse influence such as discoloration, peeling paint, etc.

1. Turn the projector off, and unplug the power cord. Allow the projector to cool sufficiently.
2. After making sure that the projector is cool adequately, lightly wipe with gauze or a soft cloth.

If soiling is severe, dip soft cloth in water or a neutral cleaner dilute in water, and wipe lightly after wringing well. Then, wipe lightly with a soft, dry cloth.

Troubleshooting

Related messages

When the unit's power is on, messages such as those shown below may be displayed. When any such message is displayed on the screen, please respond as described below. If the same message is displayed after the treatment, or if a message other than the following appears, please contact your dealer or service company.

Although these messages will be automatically disappeared around several minutes, it will be reappeared every time the power is turned on.

Message	Description
<p>☀ CHANGE THE LAMP</p> <p>AFTER REPLACING LAMP, RESET THE LAMP TIMER.</p>	<p>The time the lamp timer has counted is approaching 2000 hours. Preparation of a new lamp, and an early lamp change is recommended. After you have change the lamp, please be sure to reset the lamp timer. (📖39)</p>
<p>☀ CHANGE THE LAMP</p> <p>AFTER REPLACING LAMP, RESET THE LAMP TIMER.</p> <p>THE POWER WILL TURN OFF AFTER ** hr.</p>	<p>The time the lamp timer has counted is approaching 2000 hours, so a lamp change within ** hours is recommended. When lamp usage reaches 2000 hours, the power will automatically be turned off. Please change the lamp by referring to the section “Lamp”. (📖41) After you have changed the lamp, please be sure to reset the lamp timer. (📖39)</p>
<p>☀ CHANGE THE LAMP</p> <p>AFTER REPLACING LAMP, RESET THE LAMP TIMER.</p> <p>THE POWER WILL TURN OFF AFTER 0 hr.</p>	<p>As the time the lamp timer has counted has reached 2000 hours, the power will soon be automatically turned off. Please immediately turn the power off, and change the lamp by referring to the section “Lamp”. (📖41) After changing the lamp, please be sure to reset the lamp timer. (📖39)</p>
<p>NO INPUT IS DETECTED ON ***</p>	<p>There is no input signal. Please confirm the signal input connection, and the status of the signal source.</p>
<p>SYNC IS OUT OF RANGE ON *** [fH] *****kHz [fV] *****Hz</p>	<p>The horizontal or vertical wavelength of the inputted signal is outside of the response parameters of this unit. Please confirm the specs for this unit or the signal source specs.</p>

Related messages (continued)

Message	Description
<p>CHECK THE AIR FLOW</p>	<p>The internal portion temperature is rising. Please turn the power OFF, and allow the unit to cool down at least 20 minutes. After having confirmed the following items, please turn the power ON again.</p> <ul style="list-style-type: none"> • Is there blockage of the air passage aperture? • Is the air filter dirty? • Does the peripheral temperature exceed 35°C? • If the same indication is displayed after the treatment, please set the HIGH at the FAN SPEED of the item SERVICE of the OPTION menu.
<p>CLEAN THE AIR FILTER POWER OFF FIRST, THEN CLEAN THE AIR FILTER. AFTER CLEANING THE AIR FILTER, RESET THE FILTER TIMER.</p>	<p>A note of precaution when cleaning the air filter. Please immediately turn the power OFF, and clean or change the air filter by referring to the “Air Filter” section of this manual. After you have cleaned or changed the air filter, please be sure to reset the filter timer ( 39).</p>

NOTE • A lamp has a finite product life. Lamps are characterized by the fact that, after long hours of usage, a lamp will no longer light up, or the lamp will break or burst, etc. This projector is equipped with an automatic shut-down function, such that the power will automatically be turned off when lamp usage time has reached 2000 hours. Please be aware, however, that among lamp types, there are major differences in product lifetimes; a lamp may thus fail to light even prior to the functioning of the automatic shut-down function of this projector.

Regarding the indicator lamps

Lighting and flashing of the POWER indicator, the LAMP indicator, and the TEMP indicator have the meanings as described in the table below. Please respond in accordance with the instructions within the table. If the same indication is displayed after the treatment, or if an indication other than the following is displayed, please contact your dealer or service company.

POWER indicator	LAMP indicator	TEMP indicator	Description
Lighting In Orange	Turned off	Turned off	The projector is in a standby state. Please refer to the section "Power On/Off". (16)
<i>Blinking</i> In Green	Turned off	Turned off	The projector is warming up. Please wait.
Lighting In Green	Turned off	Turned off	The projector is in an on state. Ordinary operations may be performed.
<i>Blinking</i> In Orange	Turned off	Turned off	The projector is cooling down. Please wait.
<i>Blinking</i> In Red	(discretionary)	(discretionary)	The projector is cooling down. A certain error has been detected. Please wait until the POWER indicator finishes blink, and then perform the proper response measure using the item descriptions below as reference.
<i>Blinking</i> In Red or Lighting In Red	Lighting In Red	Turned off	The lamp does not light, and there is a possibility that interior portion has become heated. Please turn the power off, and allow the unit to cool down at least 20 minutes. After the projector has sufficiently cooled down, please make confirmation of the following items, and then turn the power on again. • Is there blockage of the air passage aperture? • Is the air filter dirty? • Does the peripheral temperature exceed 35°C? If the same indication is displayed after the treatment, please change the lamp by referring to the section "Lamp". (41)
<i>Blinking</i> In Red or Lighting In Red	<i>Blinking</i> In Red	Turned off	The lamp cover has not been properly fixed (attached). Please turn the power off, and allow the unit to cool down at least 45 minutes. After the projector has sufficiently cooled down, please make confirmation of the attachment state of the lamp cover. After performing any needed maintenance, turn the power on again. If the same indication is displayed after the treatment, please contact your dealer or service company.

Regarding the indicator lamps (continued)

POWER indicator	LAMP indicator	TEMP indicator	Description
Blinking In Red or Lighting In Red	Turned off	Blinking In Red	The cooling fan is not operating. Please turn the power off, and allow the unit to cool down at least 20 minutes. After the projector has sufficiently cooled down, please make confirmation that no foreign matter has become caught in the fan, etc. and then turn the power on again. If the same indication is displayed after the treatment, please contact your dealer or service company.
Blinking In Red or Lighting In Red	Turned off	Lighting In Red	There is a possibility that the interior portion has become heated. Please turn the power off, and allow the unit to cool down at least 20 minutes. After the projector has sufficiently cooled down, please make confirmation of the following items, and then turn the power on again. <ul style="list-style-type: none"> • Is there blockage of the air passage aperture? • Is the air filter dirty? • Does the peripheral temperature exceed 35°C? If the same indication is displayed after the treatment, please set the HIGH at the FAN SPEED of the item SERVICE of the OPTION menu. (40)
Lighting In Green	Alternative blinking in Red		There is a possibility that the interior portion has become overcooled. Please use the unit within the usage temperature parameters (5°C to 35°C). After the treatment, resent the power to ON.
Lighting In Green	Simultaneous blinking in Red		It is time to clean the air filter. Please immediately turn the power OFF, and clean or change the air filter by referring to the section "Air Filter". After cleaning or changed the air filter, please be sure to reset the filter timer. After the treatment, resent the power to ON.

NOTE • When the interior portion has become overheated, for safety purposes, the power source is automatically turned off, and the indicator lamps may also be turned off. In such a case, press the "O" (OFF) side of the power switch, and wait at least 45 minutes. After the projector has sufficiently cooled down, please make confirmation of the attachment state of the lamp and lamp cover, and then turn the power on again.

Phenomena that may easily be mistaken for machine defects

⚠WARNING ▶ Never use the projector if abnormal operations such as smoke, strange odor, excessive sound, damaged casing or elements or cables, penetration of liquids or foreign matter, etc. should occur. In such cases, immediately turn off the power switch and then disconnect the power plug from the power outlet. After making sure that the smoke or odor has stopped, contact your dealer or service company.

1. Before requesting repair, please check in accordance with the following chart.
This operation sometimes resolves your problem.

If the situation cannot be corrected,

2. The projector's microprocessor may need to be reset. Please push the restart switch by using a pin or similar. (📖17)
3. Some setting may be wrong. Please use the FACTORY RESET function of SERVICE menu in the OPTION menu (📖40) to reset all settings to factory default.

Then, if the problem is not removed after maintenance, please contact your dealer or service company.

Phenomenon	Cases not involving a machine defect	Reference page 📖
Power does not come on.	The electrical power cord is not plugged in. Correctly connect the power cord.	15
	The power switch is not set to the on position. Set the power switch to [] (On).	16
	The main power source has been interrupted during operation such as by a power outage (blackout), etc. Please turn the power off, and allow the unit to cool down at least 20 minutes. After the projector has sufficiently cooled down, please turn the power on again.	16, 17
	Either there is no lamp and/or lamp cover, or either of these has not been properly fixed. Please turn the power off, and allow the unit to cool down at least 45 minutes. After the projector has sufficiently cooled down, please make confirmation of the attachment state of the lamp and lamp cover, and then turn the power on again.	41, 42

Phenomena that may easily be mistaken for machine defects (continued)

Phenomenon	Cases not involving a machine defect	Reference page 
No pictures are displayed.	<p>The lens cover is closed. Remove the lens cover.</p>	4, 16
	<p>The signal cables are not correctly connected. Correctly connect the connection cables.</p>	13, 14
	<p>The brightness is adjusted to an extremely low level. Adjust the BRIGHT to a higher level using the menu function or the remote control.</p>	25, 27
	<p>The computer cannot detect the projector as a plug and play monitor. Make sure that the computer's can detect a plug and play monitor using other plug and play monitor.</p>	13
Colors have a faded- out appearance, or Color tone is poor.	<p>Color settings are not correctly adjusted. Perform picture adjustments by changing the COLOR TEMP, COLOR, TINT and/or COLOR SPACE settings, using the menu functions.</p>	25, 28 32
	<p>COLOR SPACE setting is not suitable. Change the COLOR SPACE setting to AUTO, RGB, SMPTE240 , REC709 or REC601.</p>	32
Pictures appear dark.	<p>The brightness and/or contrast are adjusted to an extremely low level. Adjust the BRIGHT and/or CONTRAST settings to a higher level using the menu function.</p>	25, 27
	<p>The WHISPER function is working. Select the NORMAL to the item WHISPER in the SETUP menu.</p>	26, 34
	<p>The lamp is approaching the end of its product lifetime. Replace the lamp.</p>	41, 42, 44
Pictures appear blurry.	<p>Either the focus and/or horizontal phase settings are not properly. Adjust the focus using the focus ring, and/or H PHASE using the menu function.</p>	19, 30
	<p>The lens is dirty or misty. Clean the lens by referring to the section "Caring for the lens".</p>	45

NOTE • Although bright spots or dark spots may appear on the screen, this is a unique characteristic of liquid crystal displays, and such do not constitute or imply a machine defect.

Warranty and after-service

If a problem occurs with the equipment, first refer to the “Troubleshooting” (46) and run through the suggested checks. If this does not resolve the problem, please contact your dealer or the service company. They will tell you what warranty condition is applied.

Specifications

NOTE • This specifications are subject to change without notice.

Item		Specification
Product name		Liquid crystal projector
Liquid Crystal panel	Panel size	1.5 cm (0.6 type)
	Drive system	TFT active matrix
	Pixels	786,432 pixels (1024 horizontal x 768 vertical)
Lens		F=1.77 f=20.4 mm
Lamp		165W UHB
Power Supply		AC100-120V/2.7A, AC220-240V/1.5A
Power Consumption		240W
Temperature range		5 ~ 35°C (Operating)
Size		285 (W) x 73 (H) x 202 (D) mm (Not including protruding parts) • Please refer to the following figure.
Weight (mass)		2.2 kg
Ports		RGB input: RGBD-sub 15pin mini x 1 Communication port: CONTROL D-sub 9pin x 1 Video input: VIDEO..... RCA x 1 S-VIDEO S-Video x 1 Audio input: AUDIO..... Stereo mini x 1
Optional parts	Lamp	DT00701
	Air filter	NJ20922
	Others	• Please consult your dealer.

Specifications (continued)

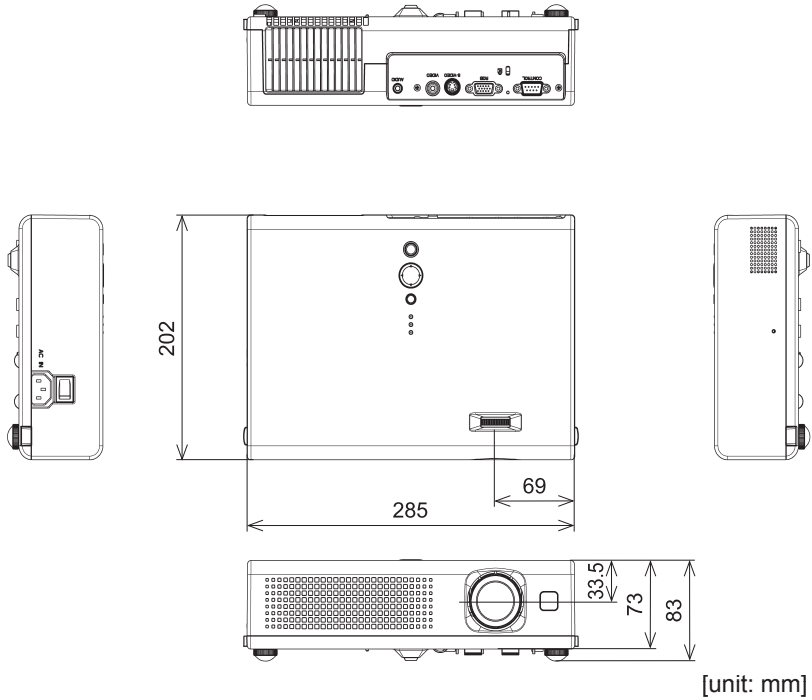

Projector

User's Manual – Operating Guide

Technical

Example of computer signal

Resolution (H x V)	H. frequency (kHz)	V. frequency (Hz)	Rating	Signal mode
720 x 400	37.9	85.0	VESA	TEXT
640 x 480	31.5	59.9	VESA	VGA (60Hz)
640 x 480	37.9	72.8	VESA	VGA (72Hz)
640 x 480	37.5	75.0	VESA	VGA (75Hz)
640 x 480	43.3	85.0	VESA	VGA (85Hz)
800 x 600	35.2	56.3	VESA	SVGA (56Hz)
800 x 600	37.9	60.3	VESA	SVGA (60Hz)
800 x 600	48.1	72.2	VESA	SVGA (72Hz)
800 x 600	46.9	75.0	VESA	SVGA (75Hz)
800 x 600	53.7	85.1	VESA	SVGA (85Hz)
832 x 624	49.7	74.5		Mac 16" mode
1024 x 768	48.4	60.0	VESA	XGA (60Hz)
1024 x 768	56.5	70.1	VESA	XGA (70Hz)
1024 x 768	60.0	75.0	VESA	XGA (75Hz)
1024 x 768	68.7	85.0	VESA	XGA (85Hz)
1152 x 864	67.5	75.0	VESA	SXGA (75Hz)
1280 x 960	60.0	60.0	VESA	SXGA (60Hz)
1280 x 1024	64.0	60.0	VESA	SXGA (60Hz)
1280 x 1024	80.0	75.0	VESA	SXGA (75Hz)
1280 x 1024	91.1	85.0	VESA	SXGA (85Hz)
1600 x 1200	75.0	60.0	VESA	UXGA (60Hz)

- NOTE** • Be sure to check jack type, signal level, timing and resolution before connecting this projector to a computer.
- Some computers may have multiple display screen modes. Use of some of these modes will not be possible with this projector.
 - Depending on the input signal, full-size display may not be possible in some cases. Refer to the number of display pixels above.
 - Although the projector can display signals with resolution up to UXGA (1600x1200), the signal will be converted to the projector's panel resolution before being displayed. The best display performance will be achieved if the resolutions of the input signal and projector panel are identical.
 - Automatically adjustment may not function correctly with some input signals.
 - The image may not be displayed correctly when the input sync signal is a composite sync or a sync on G.

Initial set signals

The following signals are used for the initial settings. The signal timing of some computer models may be different. In such case, adjust the items V POSITION and H POSITION in the IMAGE menu.

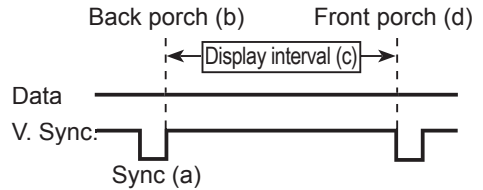
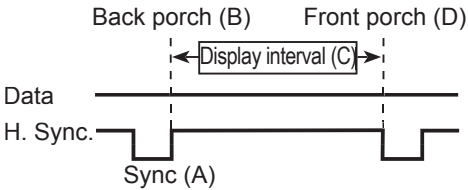

Computer/ Signal	Horizontal signal timing (µs)			
	(A)	(B)	(C)	(D)
TEXT	2.0	3.0	20.3	1.0
VGA (60Hz)	3.8	1.9	25.4	0.6
VGA (72Hz)	1.3	3.8	20.3	1.0
VGA (75Hz)	2.0	3.8	20.3	0.5
VGA (85Hz)	1.6	2.2	17.8	1.6
SVGA (56Hz)	2.0	3.6	22.2	0.7
SVGA (60Hz)	3.2	2.2	20.0	1.0
SVGA (72Hz)	2.4	1.3	16.0	1.1
SVGA (75Hz)	1.6	3.2	16.2	0.3
SVGA (85Hz)	1.1	2.7	14.2	0.6
Mac 16" mode	1.1	3.9	14.5	0.6
XGA (60Hz)	2.1	2.5	15.8	0.4
XGA (70Hz)	1.8	1.9	13.7	0.3
XGA (75Hz)	1.2	2.2	13.0	0.2
XGA (85Hz)	1.0	2.2	10.8	0.5
1152 x 864 (75Hz)	1.2	2.4	10.7	0.6
1280 x 960 (60Hz)	1.0	2.9	11.9	0.9
1280 x 1024 (60Hz)	1.0	2.3	11.9	0.4
1280 x 1024 (75Hz)	1.1	1.8	9.5	0.2
1280 x 1024 (85Hz)	1.0	1.4	8.1	0.4
1600 x 1200 (60Hz)	1.2	1.9	9.9	0.4

Computer/ Signal	Vertical signal timing (lines)			
	(a)	(b)	(c)	(d)
TEXT	3	42	400	1
VGA (60Hz)	2	33	480	10
VGA (72Hz)	3	28	480	9
VGA (75Hz)	3	16	480	1
VGA (85Hz)	3	25	480	1
SVGA (56Hz)	2	22	600	1
SVGA (60Hz)	4	23	600	1
SVGA (72Hz)	6	23	600	37
SVGA (75Hz)	3	21	600	1
SVGA (85Hz)	3	27	600	1
Mac 16" mode	3	39	624	1
XGA (60Hz)	6	29	768	3
XGA (70Hz)	6	29	768	3
XGA (75Hz)	3	28	768	1
XGA (85Hz)	3	36	768	1
1152 x 864 (75Hz)	3	32	864	1
1280 x 960 (60Hz)	3	36	960	1
1280 x 1024 (60Hz)	3	38	1024	1
1280 x 1024 (75Hz)	3	37	1024	2
1280 x 1024 (85Hz)	3	44	1024	1
1600 x 1200 (60Hz)	3	46	1200	1

Connection to the ports

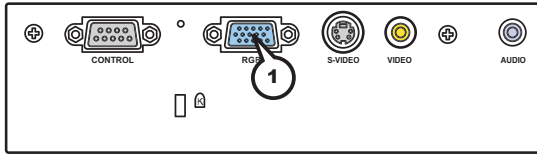

① RGB

D-sub 15pin mini shrink jack

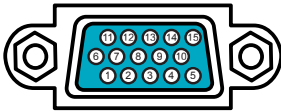

At RGB signal

- Video signal: RGB separate, Analog, 0.7Vp-p, 75Ω terminated (positive)
- H/V. sync. Signal: TTL level (positive/negative)
- Composite sync. Signal: TTL level

At component video signal

- System: 525i (480i), 525p (480p), 625i (576i), 750p (720p), 1125i (1080i)

At RGB signal

Pin	Signal
1	Video Red
2	Video Green
3	Video Blue
4	(No connection)
5	Ground
6	Ground Red
7	Ground Green
8	Ground Blue
9	(No connection)
10	Ground
11	(No connection)
12	SDA (DDC data)
13	H. sync / Composite sync.
14	V. sync.
15	SCL (DDC clock)

At component video signal

Pin	Signal
1	C _R /P _R
2	Y
3	C _B /P _B
4	(No connection)
5	Ground
6	C _R /P _R Ground
7	Y Ground
8	C _B /P _B Ground
9	(No connection)
10	Ground
11	(No connection)
15	

* except for RGB OUT.

Connection to the ports (continued)

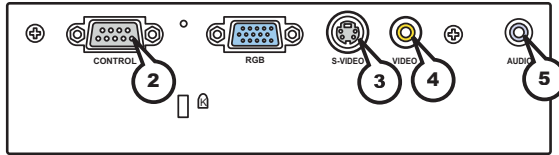

②CONTROL

D-sub 9pin plug

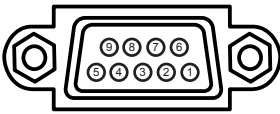

• About the details of RS-232C communication, please refer to the following page.

Pin	Signal	Pin	Signal	Pin	Signal
1	(No connection)	4	(No connection)	7	RTS
2	RD	5	Ground	8	CTS
3	TD	6	(No connection)	9	(No connection)

③S-VIDEO

Mini DIN 4pin jack



Pin	Signal
1	Color signal 0.286Vp-p (NTSC, burst), 75Ω terminator Color signal 0.300Vp-p (PAL/SECAM, burst) 75Ω terminator
2	Brightness signal, 1.0Vp-p, 75Ω terminator
3	Ground
4	Ground

④VIDEO

RCA jack

- System: NTSC, PAL, SECAM, PAL-M, PAL-N, NTSC4.43, PAL60
- 1.0±0.1Vp-p, 75Ω terminator

⑤AUDIO

Ø3.5 stereo mini jack

- 200 mV rms, more than 47k Ω or more

RS-232C Communication

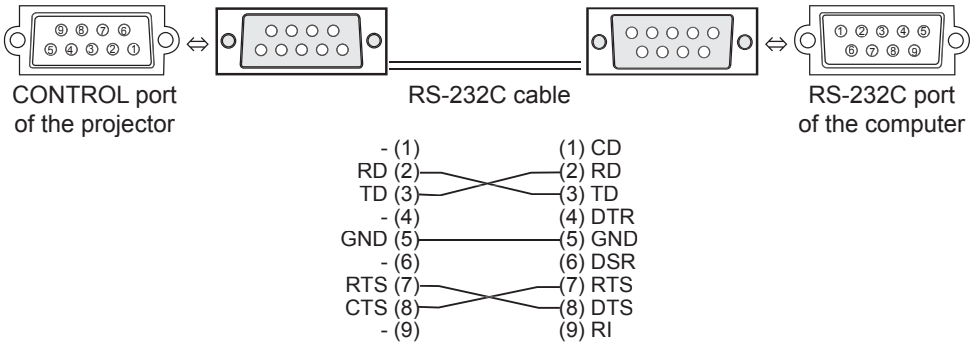

Connecting the cable

1. Turn off the projector and the computer.
2. Connect the CONTROL port of the projector with a RS-232C port of the computer by a RS-232C cable. Use the cable that fulfills the specification shown in the previous page.
3. Turn the computer on, and after the computer has started up turn the projector on.

Communications setting

19200bps, 8N1

1. Protocol

Consist of header (7 bytes) + command data (6 bytes).

2. Header

BE + EF + 03 + 06 + 00 + CRC_low + CRC_high

CRC_low : Lower byte of CRC flag for command data

CRC_high : Upper byte of CRC flag for command data

3. Command data

Command data chart

byte_0	byte_1	byte_2	byte_3	byte_4	byte_5
Action		Type		Setting code	
low	high	low	high	low	high

Action (byte_0 - 1)

Action	Classification	Content
1	SET	Change setting to desired value.
2	GET	Read projector internal setup value.
4	INCREMENT	Increment setup value by 1.
5	DECREMENT	Decrement setup value by 1.
6	EXECUTE	Run a command.

Requesting projector status (Get command)

- (1) Send the request code Header + Command data ('02H'+ '00H'+ type (2 bytes)+ '00H' + '00H') from the computer to the projector.
- (2) The projector returns the response code '1DH'+ data (2 bytes) to the computer.

Changing the projector settings (Set command)

- (1) Send the setting code Header + Command data ('01H'+ '00H'+ type (2 bytes) + setting code (2 bytes)) from the computer to the projector.
- (2) The projector changes the setting based on the above setting code.
- (3) The projector returns the response code '06H' to the computer.

Using the projector default settings (Reset Command)

- (1) The computer sends the default setting code Header + Command data ('06H'+ '00H' + type (2 bytes) + '00H'+ '00H') to the projector.
- (2) The projector changes the specified setting to the default value.
- (3) The projector returns the response code '06H' to the computer.

Increasing the projector setting value (Increment command)

- (1) The computer sends the increment code Header + Command data ('04H'+ '00H'+ type (2 bytes) + '00H'+ '00H') to the projector.
- (2) The projector increases the setting value on the above setting code.
- (3) The projector returns the response code '06H' to the computer.

Decreasing the projector setting value (Decrement command)

- (1) The computer sends the decrement code Header + Command data ('05H'+ '00H'+ type (2 bytes) + '00H' + '00H') to the projector.
- (2) The projector decreases the setting value on the above setting code.
- (3) The projector returns the response code '06H' to the computer.

When the projector cannot understand the received command

When the projector cannot understand the received command, the error code '15H' is sent back to the computer.

Sometimes the projector cannot properly receive the command. In such a case, the command is not executed and the error code '15H' is sent back to the computer. If this error code is returned, send the same command again.

When the projector cannot execute the received command.

When the projector cannot execute the received command, the error code '1cH' + 'xxxxH' is sent back to the computer. When the data length is greater than indicated by the data length code, the projector ignore the excess data code.

Conversely when the data length is shorter than indicated by the data length code, an error code will be returned to the computer.

NOTE • Operation cannot be guaranteed when the projector receives an undefined command or data.

- Provide an interval of at least 40ms between the response code and any other code.
- The projector outputs test data when the power supply is switched ON, and when the lamp is lit. Ignore this data.
- Commands are not accepted during warm-up.

Command table

Names	Operation Type	Header				Command Data			
				CRC	Action	Type	Setting Code		
Power	Set	Turn off	BE EF	03	06 00	2A D3	01 00	00 60	00 00
		Turn on	BE EF	03	06 00	BA D2	01 00	00 60	01 00
	Get	Get	BE EF	03	06 00	19 D3	02 00	00 60	00 00
		(Example return)	00 00 (Off)	01 00 (On)	02 00 (Cool down)				
Input Source	Set	RGB	BE EF	03	06 00	FE D2	01 00	00 20	00 00
		VIDEO	BE EF	03	06 00	6E D3	01 00	00 20	01 00
		S-VIDEO	BE EF	03	06 00	9E D3	01 00	00 20	02 00
	Get	BE EF	03	06 00	CD D2	02 00	00 20	00 00	
Error Status	Get	Get	BE EF	03	06 00	D9 D8	02 00	20 60	00 00
		(Example return)	00 00 (Normal)	01 00 (Cover error)	02 00 (Fan error)	03 00 (Lamp error)	04 00 (Temp error)	05 00 (Air flow error)	06 00 (Lamp time error)
BRIGHT	Get	Get	BE EF	03	06 00	89 D2	02 00	03 20	00 00
		Increment	BE EF	03	06 00	EF D2	04 00	03 20	00 00
		Decrement	BE EF	03	06 00	3E D3	05 00	03 20	00 00
BRIGHT Reset	Execute	BE EF	03	06 00	58 D3	06 00	00 70	00 00	
CONTRAST	Get	Get	BE EF	03	06 00	FD D3	02 00	04 20	00 00
		Increment	BE EF	03	06 00	9B D3	04 00	04 20	00 00
		Decrement	BE EF	03	06 00	4A D2	05 00	04 20	00 00
CONTRAST Reset	Execute	BE EF	03	06 00	A4 D2	06 00	01 70	00 00	
MODE	Set	NORMAL	BE EF	03	06 00	23 F6	01 00	BA 30	00 00
		CINEMA	BE EF	03	06 00	B3 F7	01 00	BA 30	01 00
		DYNAMIC	BE EF	03	06 00	E3 F4	01 00	BA 30	04 00
	Get	BE EF	03	06 00	10 F6	02 00	BA 30	00 00	
(Example return)	00 00 (Normal)	01 00 (Cinema)	04 00 (Dynamic)	10 00 (Custom)					
GAMMA	Set	#1 DEFAULT	BE EF	03	06 00	07 E9	01 00	A1 30	20 00
		#1 CUSTOM	BE EF	03	06 00	07 FD	01 00	A1 30	10 00
		#2 DEFAULT	BE EF	03	06 00	97 E8	01 00	A1 30	21 00
		#2 CUSTOM	BE EF	03	06 00	97 FC	01 00	A1 30	11 00
		#3 DEFAULT	BE EF	03	06 00	67 E8	01 00	A1 30	22 00
		#3 CUSTOM	BE EF	03	06 00	67 FC	01 00	A1 30	12 00
	Get	BE EF	03	06 00	F4 F0	02 00	A1 30	00 00	
User Gamma Pattern	Set	Off	BE EF	03	06 00	FB FA	01 00	80 30	00 00
		9 step gray scale	BE EF	03	06 00	6B FB	01 00	80 30	01 00
		15 steps gray scale	BE EF	03	06 00	9B FB	01 00	80 30	02 00
		Ramp	BE EF	03	06 00	0B FA	01 00	80 30	03 00
	Get	BE EF	03	06 00	C8 FA	02 00	80 30	00 00	

Command table (continued)

Names	Operation Type	Header				Command Data			
						CRC	Action	Type	Setting Code
User Gamma Point 1	Get	BE EF	03	06 00	08 FE	02 00	90 30	00 00	
	Increment	BE EF	03	06 00	6E FE	04 00	90 30	00 00	
	Decrement	BE EF	03	06 00	BF FF	05 00	90 30	00 00	
User Gamma Point 2	Get	BE EF	03	06 00	F4 FF	02 00	91 30	00 00	
	Increment	BE EF	03	06 00	92 FF	04 00	91 30	00 00	
	Decrement	BE EF	03	06 00	43 FE	05 00	91 30	00 00	
User Gamma Point 3	Get	BE EF	03	06 00	B0 FF	02 00	92 30	00 00	
	Increment	BE EF	03	06 00	D6 FF	04 00	92 30	00 00	
	Decrement	BE EF	03	06 00	07 FE	05 00	92 30	00 00	
User Gamma Point 4	Get	BE EF	03	06 00	4C FE	02 00	93 30	00 00	
	Increment	BE EF	03	06 00	2A FE	04 00	93 30	00 00	
	Decrement	BE EF	03	06 00	FB FF	05 00	93 30	00 00	
User Gamma Point 5	Get	BE EF	03	06 00	38 FF	02 00	94 30	00 00	
	Increment	BE EF	03	06 00	5E FF	04 00	94 30	00 00	
	Decrement	BE EF	03	06 00	8F FE	05 00	94 30	00 00	
User Gamma Point 6	Get	BE EF	03	06 00	C4 FE	02 00	95 30	00 00	
	Increment	BE EF	03	06 00	A2 FE	04 00	95 30	00 00	
	Decrement	BE EF	03	06 00	73 FF	05 00	95 30	00 00	
User Gamma Point 7	Get	BE EF	03	06 00	80 FE	02 00	96 30	00 00	
	Increment	BE EF	03	06 00	E6 FE	04 00	96 30	00 00	
	Decrement	BE EF	03	06 00	37 FF	05 00	96 30	00 00	
User Gamma Point 8	Get	BE EF	03	06 00	7C FF	02 00	97 30	00 00	
	Increment	BE EF	03	06 00	1A FF	04 00	97 30	00 00	
	Decrement	BE EF	03	06 00	CB FE	05 00	97 30	00 00	
COLOR TEMP	Set	LOW	BE EF	03	06 00	6B F4	01 00	B0 30	01 00
		MIDDLE	BE EF	03	06 00	9B F4	01 00	B0 30	02 00
		HIGH	BE EF	03	06 00	0B F5	01 00	B0 30	03 00
		CUSTOM	BE EF	03	06 00	3B F8	01 00	B0 30	10 00
	Get	BE EF	03	06 00	C8 F5	02 00	B0 30	00 00	
COLOR TEMP GAIN R	Get	BE EF	03	06 00	34 F4	02 00	B1 30	00 00	
	Increment	BE EF	03	06 00	52 F4	04 00	B1 30	00 00	
	Decrement	BE EF	03	06 00	83 F5	05 00	B1 30	00 00	
COLOR TEMP GAIN G	Get	BE EF	03	06 00	70 F4	02 00	B2 30	00 00	
	Increment	BE EF	03	06 00	16 F4	04 00	B2 30	00 00	
	Decrement	BE EF	03	06 00	C7 F5	05 00	B2 30	00 00	
COLOR TEMP GAIN B	Get	BE EF	03	06 00	8C F5	02 00	B3 30	00 00	
	Increment	BE EF	03	06 00	EA F5	04 00	B3 30	00 00	
	Decrement	BE EF	03	06 00	3B F4	05 00	B3 30	00 00	
COLOR TEMP OFFSET R	Get	BE EF	03	06 00	04 F5	02 00	B5 30	00 00	
	Increment	BE EF	03	06 00	62 F5	04 00	B5 30	00 00	
	Decrement	BE EF	03	06 00	B3 F4	05 00	B5 30	00 00	
COLOR TEMP OFFSET G	Get	BE EF	03	06 00	40 F5	02 00	B6 30	00 00	
	Increment	BE EF	03	06 00	26 F5	04 00	B6 30	00 00	
	Decrement	BE EF	03	06 00	F7 F4	05 00	B6 30	00 00	

Command table (continued)

Names	Operation Type	Header				Command Data			
						CRC	Action	Type	Setting Code
COLOR TEMP OFFSET B	Get	BE EF	03	06 00	BC F4	02 00	B7 30	00 00	
	Increment	BE EF	03	06 00	DA F4	04 00	B7 30	00 00	
	Decrement	BE EF	03	06 00	0B F5	05 00	B7 30	00 00	
COLOR	Get	BE EF	03	06 00	B5 72	02 00	02 22	00 00	
	Increment	BE EF	03	06 00	D3 72	04 00	02 22	00 00	
	Decrement	BE EF	03	06 00	02 73	05 00	02 22	00 00	
COLOR Reset	Execute	BE EF	03	06 00	80 D0	06 00	0A 70	00 00	
TINT	Get	BE EF	03	06 00	49 73	02 00	03 22	00 00	
	Increment	BE EF	03	06 00	2F 73	04 00	03 22	00 00	
	Decrement	BE EF	03	06 00	FE 72	05 00	03 22	00 00	
TINT Reset	Execute	BE EF	03	06 00	7C D1	06 00	0B 70	00 00	
SHARPNESS	Get	BE EF	03	06 00	F1 72	02 00	01 22	00 00	
	Increment	BE EF	03	06 00	97 72	04 00	01 22	00 00	
	Decrement	BE EF	03	06 00	46 73	05 00	01 22	00 00	
SHARPNESS Reset	Execute	BE EF	03	06 00	C4 D0	06 00	09 70	00 00	
PROGRESSIVE	Set	TURN OFF	BE EF	03	06 00	4A 72	01 00	07 22	00 00
		TV	BE EF	03	06 00	DA 73	01 00	07 22	01 00
		FILM	BE EF	03	06 00	2A 73	01 00	07 22	02 00
	Get	BE EF	03	06 00	79 72	02 00	07 22	00 00	
MY MEMORY Load	Set	1	BE EF	03	06 00	0E D7	01 00	14 20	00 00
		2	BE EF	03	06 00	9E D6	01 00	14 20	01 00
		3	BE EF	03	06 00	6E D6	01 00	14 20	02 00
		4	BE EF	03	06 00	FE D7	01 00	14 20	03 00
MY MEMORY Save	Set	1	BE EF	03	06 00	F2 D6	01 00	15 20	00 00
		2	BE EF	03	06 00	62 D7	01 00	15 20	01 00
		3	BE EF	03	06 00	92 D7	01 00	15 20	02 00
		4	BE EF	03	06 00	02 D6	01 00	15 20	03 00
ASPECT	Set	4:3	BE EF	03	06 00	9E D0	01 00	08 20	00 00
		16:9	BE EF	03	06 00	0E D1	01 00	08 20	01 00
		NORMAL	BE EF	03	06 00	5E DD	01 00	08 20	10 00
	Get	BE EF	03	06 00	AD D0	02 00	08 20	00 00	

Command table (continued)

Names	Operation Type	Header				Command Data			
						CRC	Action	Type	Setting Code
OVER SCAN	Get	BE EF	03	06 00	91 70	02 00	09 22	00 00	
	Increment	BE EF	03	06 00	F7 70	04 00	09 22	00 00	
	Decrement	BE EF	03	06 00	26 71	05 00	09 22	00 00	
OVER SCAN Reset	Execute	BE EF	03	06 00	EC D9	06 00	27 70	00 00	
V POSITION	Get	BE EF	03	06 00	0D 83	02 00	00 21	00 00	
	Increment	BE EF	03	06 00	6B 83	04 00	00 21	00 00	
	Decrement	BE EF	03	06 00	BA 82	05 00	00 21	00 00	
V POSITION Reset	Execute	BE EF	03	06 00	E0 D2	06 00	02 70	00 00	
H POSITION	Get	BE EF	03	06 00	F1 82	02 00	01 21	00 00	
	Increment	BE EF	03	06 00	97 82	04 00	01 21	00 00	
	Decrement	BE EF	03	06 00	46 83	05 00	01 21	00 00	
H POSITION Reset	Execute	BE EF	03	06 00	1C D3	06 00	03 70	00 00	
H PHASE	Get	BE EF	03	06 00	49 83	02 00	03 21	00 00	
	Increment	BE EF	03	06 00	2F 83	04 00	03 21	00 00	
	Decrement	BE EF	03	06 00	FE 82	05 00	03 21	00 00	
H SIZE	Get	BE EF	03	06 00	B5 82	02 00	02 21	00 00	
	Increment	BE EF	03	06 00	D3 82	04 00	02 21	00 00	
	Decrement	BE EF	03	06 00	02 83	05 00	02 21	00 00	
H SIZE Reset	Execute	BE EF	03	06 00	68 D2	06 00	04 70	00 00	
AUTO ADJUST	Execute	BE EF	03	06 00	91 D0	06 00	0A 20	00 00	
COLOR SPACE	Set	AUTO	BE EF	03	06 00	0E 72	01 00	04 22	00 00
		RGB	BE EF	03	06 00	9E 73	01 00	04 22	01 00
		SMPTE240	BE EF	03	06 00	6E 73	01 00	04 22	02 00
		REC709	BE EF	03	06 00	FE 72	01 00	04 22	03 00
	REC601	BE EF	03	06 00	CE 70	01 00	04 22	04 00	
	Get	BE EF	03	06 00	3D 72	02 00	04 22	00 00	
VIDEO FORMAT	Set	AUTO	BE EF	03	06 00	9E 75	01 00	00 22	0A 00
		NTSC	BE EF	03	06 00	FE 71	01 00	00 22	04 00
		PAL	BE EF	03	06 00	6E 70	01 00	00 22	05 00
		SECAM	BE EF	03	06 00	6E 75	01 00	00 22	09 00
		NTSC4.43	BE EF	03	06 00	5E 72	01 00	00 22	02 00
		M-PAL	BE EF	03	06 00	FE 74	01 00	00 22	08 00
	N-PAL	BE EF	03	06 00	0E 71	01 00	00 22	07 00	
	Get	BE EF	03	06 00	0D 73	02 00	00 22	00 00	
FRAME LOCK	Set	TURN OFF	BE EF	03	06 00	CB D6	01 00	14 30	00 00
		TURN ON	BE EF	03	06 00	5B D7	01 00	14 30	01 00
		Get	BE EF	03	06 00	F8 D6	02 00	14 30	00 00

Command table (continued)

Names	Operation Type	Header				Command Data			
						CRC	Action	Type	Setting Code
ZOOM	Get	BE EF	03	06 00	D0 D0	02 00	0A 30	00 00	
	Increment	BE EF	03	06 00	B6 D0	04 00	0A 30	00 00	
	Decrement	BE EF	03	06 00	67 D1	05 00	0A 30	00 00	
ZOOM Reset	Execute	BE EF	03	06 00	98 C9	06 00	70 70	00 00	
KEYSTONE V	Get	BE EF	03	06 00	B9 D3	02 00	07 20	00 00	
	Increment	BE EF	03	06 00	DF D3	04 00	07 20	00 00	
	Decrement	BE EF	03	06 00	0E D2	05 00	07 20	00 00	
KEYSTONE V Reset	Execute	BE EF	03	06 00	08 D0	06 00	0C 70	00 00	
WHISPER	Set	NORMAL	BE EF	03	06 00	3B 23	01 00	00 33	00 00
		WHISPER	BE EF	03	06 00	AB 22	01 00	00 33	01 00
	Get	BE EF	03	06 00	08 23	02 00	00 33	00 00	
MIRROR	Set	NORMAL	BE EF	03	06 00	C7 D2	01 00	01 30	00 00
		H:INVERT	BE EF	03	06 00	57 D3	01 00	01 30	01 00
		V:INVERT	BE EF	03	06 00	A7 D3	01 00	01 30	02 00
		H&V:INVERT	BE EF	03	06 00	37 D2	01 00	01 30	03 00
	Get	BE EF	03	06 00	F4 D2	02 00	01 30	00 00	
VOLUME	Get	BE EF	03	06 00	31 D3	02 00	01 20	00 00	
	Increment	BE EF	03	06 00	57 D3	04 00	01 20	00 00	
	Decrement	BE EF	03	06 00	86 D2	05 00	01 20	00 00	
MUTE	Set	TURN OFF	BE EF	03	06 00	46 D3	01 00	02 20	00 00
		TURN ON	BE EF	03	06 00	D6 D2	01 00	02 20	01 00
	Get	BE EF	03	06 00	75 D3	02 00	02 20	00 00	
LANGUAGE	Set	ENGLISH	BE EF	03	06 00	F7 D3	01 00	05 30	00 00
		FRANÇAIS	BE EF	03	06 00	67 D2	01 00	05 30	01 00
		DEUTSCH	BE EF	03	06 00	97 D2	01 00	05 30	02 00
		ESPAÑOL	BE EF	03	06 00	07 D3	01 00	05 30	03 00
		ITALIANO	BE EF	03	06 00	37 D1	01 00	05 30	04 00
		NORSK	BE EF	03	06 00	A7 D0	01 00	05 30	05 00
		NEDERLANDS	BE EF	03	06 00	57 D0	01 00	05 30	06 00
		PORTUGUÊS	BE EF	03	06 00	C7 D1	01 00	05 30	07 00
		日本語	BE EF	03	06 00	37 D4	01 00	05 30	08 00
		简体中文	BE EF	03	06 00	A7 D5	01 00	05 30	09 00
		繁體中文	BE EF	03	06 00	37 DE	01 00	05 30	10 00
		한글	BE EF	03	06 00	57 D5	01 00	05 30	0A 00
		SVENSKA	BE EF	03	06 00	C7 D4	01 00	05 30	0B 00
		РУССКИЙ	BE EF	03	06 00	F7 D6	01 00	05 30	0C 00
	SUOMI	BE EF	03	06 00	67 D7	01 00	05 30	0D 00	
POLSKI	BE EF	03	06 00	97 D7	01 00	05 30	0E 00		
TÜRKÇE	BE EF	03	06 00	07 D6	01 00	05 30	0F 00		
Get	BE EF	03	06 00	C4 D3	02 00	05 30	00 00		
MENU POSITION H	Get	BE EF	03	06 00	04 D7	02 00	15 30	00 00	
	Increment	BE EF	03	06 00	62 D7	04 00	15 30	00 00	
	Decrement	BE EF	03	06 00	B3 D6	05 00	15 30	00 00	
MENU POSITION H Reset	Execute	BE EF	03	06 00	DC C6	06 00	43 70	00 00	

Command table (continued)

Names	Operation Type	Header				Command Data			
						CRC	Action	Type	Setting Code
MENU POSITION V	Get	BE EF	03	06 00	40 D7	02 00	16 30	00 00	
	Increment	BE EF	03	06 00	26 D7	04 00	16 30	00 00	
	Decrement	BE EF	03	06 00	F7 D6	05 00	16 30	00 00	
MENU POSITION V Reset	Execute	BE EF	03	06 00	A8 C7	06 00	44 70	00 00	
OSD BRIGHT	Get	BE EF	03	06 00	A8 D5	02 00	18 30	00 00	
	Increment	BE EF	03	06 00	CE D5	04 00	18 30	00 00	
	Decrement	BE EF	03	06 00	1F D4	05 00	18 30	00 00	
BLANK	Set	My Screen	BE EF	03	06 00	FB CA	01 00	00 30	20 00
		ORIGINAL	BE EF	03	06 00	FB E2	01 00	00 30	40 00
		BLUE	BE EF	03	06 00	CB D3	01 00	00 30	03 00
		WHITE	BE EF	03	06 00	6B D0	01 00	00 30	05 00
	BLACK	BE EF	03	06 00	9B D0	01 00	00 30	06 00	
Get	BE EF	03	06 00	08 D3	02 00	00 30	00 00		
BLANK On/Off	Set	TURN OFF	BE EF	03	06 00	FB D8	01 00	20 30	00 00
		TURN ON	BE EF	03	06 00	6B D9	01 00	20 30	01 00
	Get	BE EF	03	06 00	C8 D8	02 00	20 30	00 00	
START UP	Set	My Screen	BE EF	03	06 00	CB CB	01 00	04 30	20 00
		ORIGINAL	BE EF	03	06 00	0B D2	01 00	04 30	00 00
		TURN OFF	BE EF	03	06 00	9B D3	01 00	04 30	01 00
	Get	BE EF	03	06 00	38 D2	02 00	04 30	00 00	
My Screen LOCK	Set	TURN OFF	BE EF	03	06 00	3B EF	01 00	C0 30	00 00
		TURN ON	BE EF	03	06 00	AB EE	01 00	C0 30	01 00
	Get	BE EF	03	06 00	08 EF	02 00	C0 30	00 00	
Message	Set	TURN OFF	BE EF	03	06 00	8F D6	01 00	17 30	00 00
		TURN ON	BE EF	03	06 00	1F D7	01 00	17 30	01 00
	Get	BE EF	03	06 00	BC D6	02 00	17 30	00 00	
AUTO SEARCH	Set	TURN OFF	BE EF	03	06 00	B6 D6	01 00	16 20	00 00
		TURN ON	BE EF	03	06 00	26 D7	01 00	16 20	01 00
	Get	BE EF	03	06 00	85 D6	02 00	16 20	00 00	
AUTO POWER OFF	Get	BE EF	03	06 00	08 86	02 00	10 31	00 00	
	Increment	BE EF	03	06 00	6E 86	04 00	10 31	00 00	
	Decrement	BE EF	03	06 00	BF 87	05 00	10 31	00 00	
LAMP TIME	Get	BE EF	03	06 00	C2 FF	02 00	90 10	00 00	
LAMP TIME Reset	Execute	BE EF	03	06 00	58 DC	06 00	30 70	00 00	
FILTER TIME	Get	BE EF	03	06 00	C2 F0	02 00	A0 10	00 00	
FILER TIME Reset	Execute	BE EF	03	06 00	98 C6	06 00	40 70	00 00	
MAGNIFY	Get	BE EF	03	06 00	7C D2	02 00	07 30	00 00	
	Increment	BE EF	03	06 00	1A D2	04 00	07 30	00 00	
	Decrement	BE EF	03	06 00	CB D3	05 00	07 30	00 00	
FREEZE	Set	NORMAL	BE EF	03	06 00	83 D2	01 00	02 30	00 00
		FREEZE	BE EF	03	06 00	13 D3	01 00	02 30	01 00
	Get	BE EF	03	06 00	B0 D2	02 00	02 30	00 00	

HITACHI

Hitachi, Ltd. Tokyo, Japan
International Sales Division
THE HITACHI ATAGO BUILDING,
No. 15-12 Nishi Shinbashi, 2 - Chome,
Minato - Ku, Tokyo 105-8430, Japan.
Tel: 03 35022111

HITACHI EUROPE LTD,

Whitebrook Park
Lower Cookham Road
Maidenhead
Berkshire
SL6 8YA

UNITED KINGDOM

Tel: 01628 643000
Fax: 01628 643400
Email: consumer-service@hitachi-eu.com

HITACHI EUROPE S.A.

364 Kifissias Ave. & 1, Delfon Str.
152 33 Chalandri
Athens

GREECE

Tel: 1-6837200
Fax: 1-6835964
Email: service.hellas@hitachi-eu.com

HITACHI EUROPE GmbH

Munich Office
Dornacher Strasse 3
D-85622 Feldkirchen bei München

GERMANY

Tel: +49-89-991 80-0
Fax: +49-89-991 80-224
Hotline: +49-180-551 25 51 (12ct/min)
Email: HSE-DUS.service@hitachi-eu.com

HITACHI EUROPE S.A.

Gran Via Carlos III, 86, planta 5
Edificios Trade - Torre Este
08028 Barcelona

SPAIN

Tel: +34 93 409 2550
Fax: +34 93 491 3513
Email: atencion.cliente@hitachi-eu.com

HITACHI EUROPE srl

Via Tommaso Gulli N.39, 20147
Milano, Italia

ITALY

Tel: +39 02 487861
Tel: +39 02 38073415 Servizio Clienti
Fax: +39 02 48786381/2
Email: customerservice.italy@hitachi-eu.com

HITACHI Europe AB

Box 77 S-164 94 Kista

SWEDEN

Tel: +46 (0) 8 562 711 00
Fax: +46 (0) 8 562 711 13
Email: csgswe@hitachi-eu.com

HITACHI EUROPE S.A.S

Lyon Office
B.P. 45, 69671 BRON CEDEX

FRANCE

Tel: +33 04 72 14 29 70
Fax: +33 04 72 14 29 99
Email: france.consommateur@hitachi-eu.com

HITACHI EUROPE LTD (Norway) AB

STRANDVEIEN 18

1366 Lysaker

NORWAY

Tel: 67 5190 30
Fax: 67 5190 32
Email: csgnor@hitachi-eu.com

HITACH EUROPE AB

Egebækgård
Egebækvej 98
DK-2850 Nærum

DENMARK

Tel: +45 43 43 6050
Fax: +45 43 60 51
Email: csgnor@hitachi-eu.com

HITACHI EUROPE AB

Neopoli / Niemenkatu 73
FIN-15140 Lahti

FINLAND

Tel : +358 3 8858 271
Fax: +358 3 8858 272
Email: csgnor@hitachi-eu.com

Hitachi Europe Ltd

Bergensesteenweg 421
1600 Sint-Pieters-Leeuw

BELGIUM

Tel: +32 2 363 99 01
Fax: +32 2 363 99 00
Email: sofie.van.bom@hitachi-eu.com

HITACHI EUROPE LTD

Na Sychrove 975/8
101 27 Praha 10 - Bohdalec

CZECH REPUBLIC

Tel: +420 267 212 383
Fax: +420 267 212 385
Email: csgnor@hitachi-eu.com