

***myprojectorlamps.com***

**The most trusted, dependable name  
in projector lamp sales.**



<http://www.myprojectorlamps.com>



<http://www.myprojectorlamps.ca>



<http://www.myprojectorlamps.eu>

The following projector manual has not been modified or altered in any way.

## Projector

# CP-RS56/CP-RX61

## User's Manual – Operating Guide

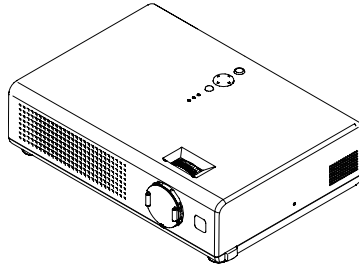

Thank you for purchasing this projector.

**⚠ WARNING** ▶ Before using, read the "User's Manual - Safety Guide" and these manuals to ensure correct usage through understanding. After reading, store them in a safe place for future reference.

### About this manual

Various symbols are used in this manual. The meanings of these symbols are described below.

**⚠ WARNING** This symbol indicates information that, if ignored, could possibly result in personal injury or even death due to incorrect handling.

**⚠ CAUTION** This symbol indicates information that, if ignored, could result possibly in personal injury or physical damage due to incorrect handling.

 Please refer to the pages written following this symbol.

**NOTE** • The information in this manual is subject to change without notice.

- The manufacturer assumes no responsibility for any errors that may appear in this manual.
- The reproduction, transmission or use of this document or contents is not permitted without express written authority.

### Trademark acknowledgment

- VGA and XGA are registered trademarks of the International Business Machines Corporation.
  - Apple and Mac are registered trademarks of Apple Computer, Inc.
  - VESA and SVGA are trademarks of the Video Electronics Standard Association.
  - Windows is a registered trademark of Microsoft Corporation.
  - Internet Explorer is a trademark of Microsoft Corporation.
- All other trademarks are the property of their respective owners.

Contents

<b>About this manual</b> . . . . .	<b>1</b>		<b>EASY MENU</b> . . . . .	<b>26</b>	
<b>Contents</b> . . . . .	<b>2</b>		Aspect, Zoom, Keystone, Mode,		
<b>Projector features</b> . . . . .	<b>3</b>		Bright, Contrast, Color, Tint,		
<b>About contents of package</b> . . . . .	<b>3</b>		Sharpness, Whisper, Mirror, Reset,		
<b>Part names</b> . . . . .	<b>4</b>		Filter time, Language,		
Projector . . . . .	4		Go to Advance Menu		
Controls . . . . .	5		<b>PICTURE menu</b> . . . . .	<b>28</b>	
Remote control . . . . .	5		Bright, Contrast, Gamma, Color temp,		
<b>Preparations</b> . . . . .	<b>6</b>		Color, Tint, Sharpness, Progressive,		
Fastening the lens cover . . . . .	6		My memory		
Putting batteries . . . . .	7		<b>IMAGE menu</b> . . . . .	<b>31</b>	
Using the remote control . . . . .	8		Aspect, Over scan, V. position,		
About the filter cover for bottom-up use . . . . .	9		H. position, H. phase, H. size,		
<b>Setting up</b> . . . . .	<b>10</b>		Auto adjust execute		
Arrangement . . . . .	11		<b>INPUT menu</b> . . . . .	<b>33</b>	
Adjusting the projector's elevator . . . . .	12		Color space, Video format, Frame lock,		
Connecting your devices . . . . .	13		Information		
Connecting power supply . . . . .	16		<b>SETUP menu</b> . . . . .	<b>35</b>	
<b>Power on/off</b> . . . . .	<b>17</b>		Zoom, Keystone, Whisper, Mirror,		
Turning on the power . . . . .	17		Volume		
Turning off the power . . . . .	18		<b>SCREEN menu</b> . . . . .	<b>36</b>	
<b>Operating</b> . . . . .	<b>19</b>		Language, Menu position, OSD bright,		
Adjusting the volume . . . . .	19		Blank, Start up, MyScreen,		
Temporarily muting the sound . . . . .	19		MyScreen lock, Message		
Selecting an input signal . . . . .	19		<b>OPTION menu</b> . . . . .	<b>39</b>	
Searching an input signal . . . . .	20		Auto search, Auto off, Lamp time,		
Selecting an aspect ratio . . . . .	20		Filter time, Service		
Adjusting the zoom (Optical) . . . . .	20		<b>Maintenance</b> . . . . .	<b>42</b>	
Adjusting the zoom (Digital) . . . . .	20		Lamp . . . . .	42	
Adjusting the focus . . . . .	20		Air filter . . . . .	44	
Using the automatic adjustment			Other care . . . . .	46	
feature . . . . .	21		<b>Troubleshooting</b> . . . . .	<b>47</b>	
Adjusting the position . . . . .	21		Related messages . . . . .	47	
Correcting the keystone distortions . . . . .	21		Regarding the indicator lamps . . . . .	48	
Using the partial magnify feature . . . . .	22		Phenomena that may easily be		
Freezing the screen . . . . .	22		mistaken for machine defects . . . . .	50	
Temporarily blanking the screen . . . . .	22		<b>Warranty and after-service</b> . . . . .	<b>52</b>	
<b>Multifunctional settings</b> . . . . .	<b>23</b>		<b>Specifications</b> . . . . .	<b>52</b>	
Using the menu function . . . . .	23				

## Projector features

This projector is used to project various computer signals as well as NTSC / PAL / SECAM video signals onto a screen. It requires just a little space for installation and gets a large image from short distance.

- High Brightness

Newly developed 165W UHB (Ultra High Brightness) lamp gives you a higher brightness image on a screen. The image can be still kept as bright and clean enough for use in bright rooms.

- Low Noise

WHISPER mode is equipped for reducing acoustic noise to realize quieter operation. It is perfect for use in low luminance rooms where low noise is more important than brightness.

- Compact Body

Even with its many features, this projector is extremely compact and slim, which gives you more flexibility and usability to use it where you want.

## About contents of package

Please see the "Contents of package" of the "User's Manual - Quick Guide". Your projector should come with the items shown there. Contact immediately your dealer if anything is missing.

**NOTE** • Keep the original packing materials for future reshipment. For moving the projector, be sure to use the original packing material. Use special caution for the lens part.

Part names

**Projector**

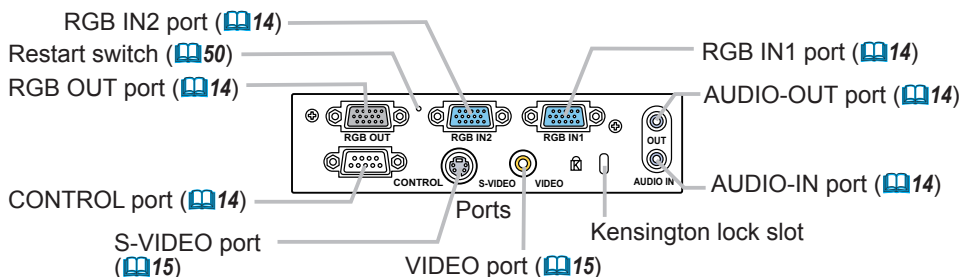
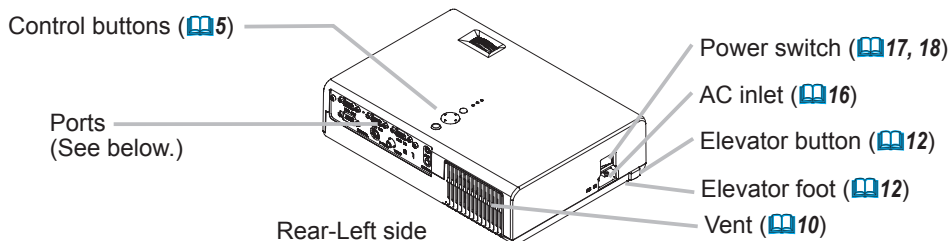
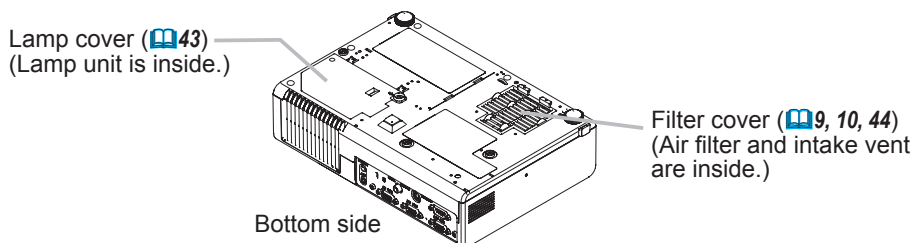
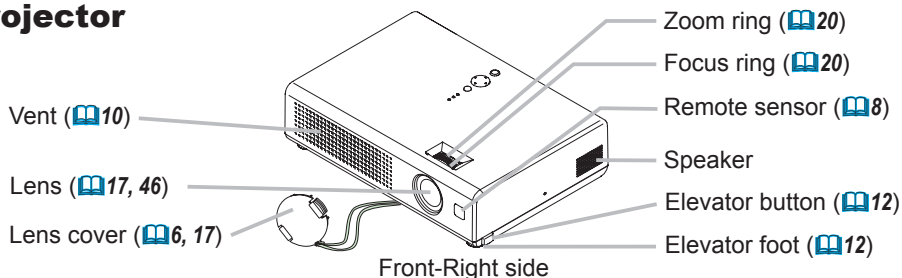

**NOTE (\*) About Restart switch:** This projector is controlled by an internal microprocessor. Under certain exceptional circumstances, the projector may not operate correctly and the microprocessor will need to be reset. In such a case, please push the Restart switch by using a cocktail stick or similar, and before turning on again, make the projector cool down at least 10 minutes without operating. Only push the Restart switch in these exceptional instances.

## Controls

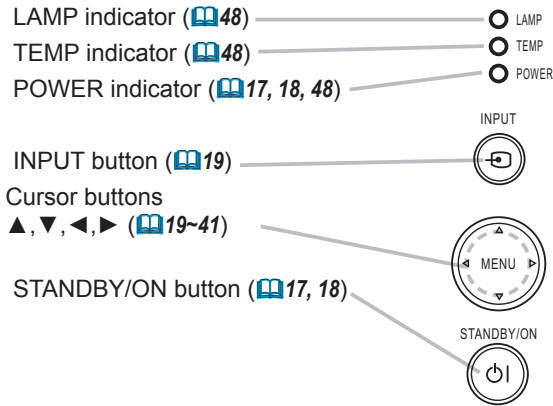

## Remote control

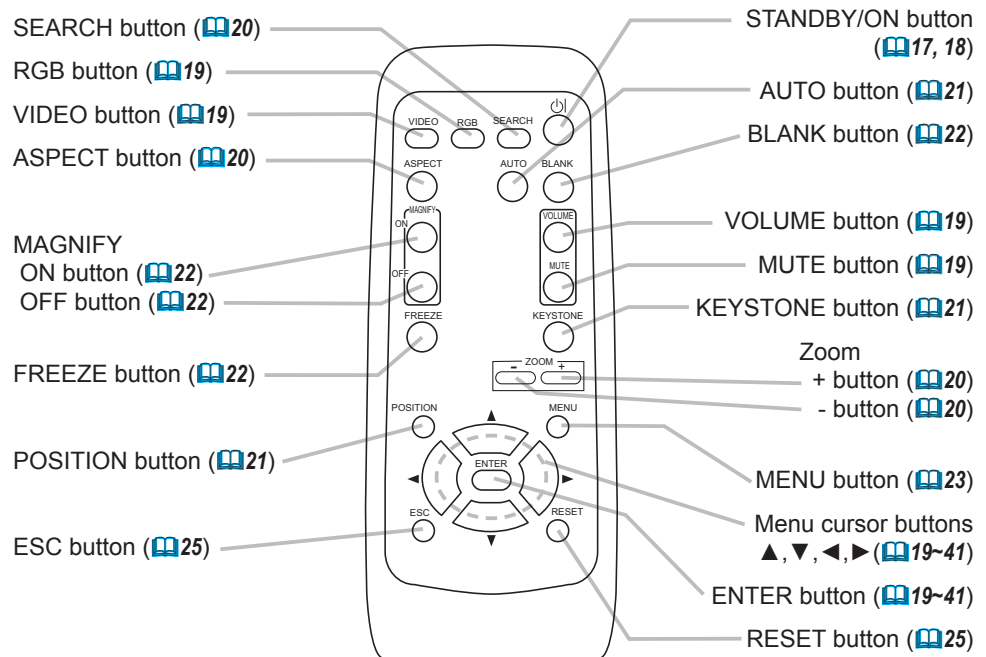

## Preparations

### Fastening the lens cover

**⚠WARNING** ▶ Do not fasten the lens cover during use or immediately after use. Handling while the projector is in a high temperature could cause a burn and/or malfunction to the projector. Before operating, make sure that the power switch is off, that the power cord is not plugged in, and that the projector is cool adequately.

To avoid losing, please fasten the lens cover to the projector using the strap.

1. Slowly turn over the projector, so that the bottom is facing up.

2. Fix the strap to the strap ring of projector.

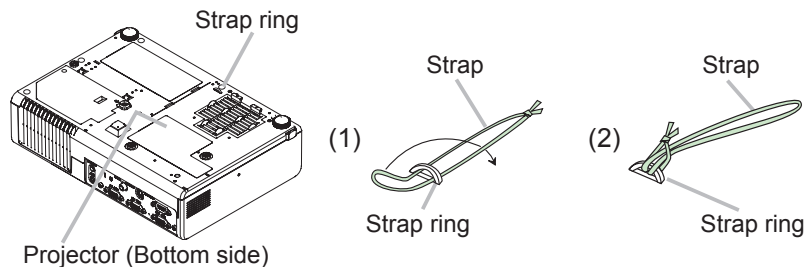

3. Fix the strap to the strap ring of lens cover.

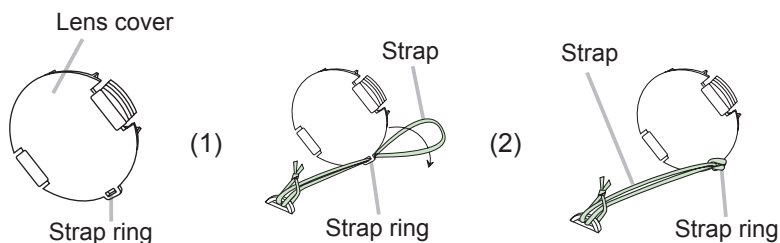

4. Attach the lens cover to the lens of projector, and slowly turn over the projector, so that the top is facing up.

## Putting batteries

- ⚠ WARNING** ▶ Always handle the batteries with care and use them only as directed. Improper use may result in battery explosion, cracking or leakage, which could result in fire, injury and/or pollution of the surrounding environment.
- Be sure to use only the batteries specified. Do not use batteries of different types at the same time. Do not mix a new battery with used one.
  - Make sure the plus and minus terminals are correctly aligned when loading a battery.
  - Keep a battery away from children and pets.
  - Do not recharge, short circuit, solder or disassemble a battery.
  - Do not allow a battery in a fire or water. Keep batteries in a dark, cool and dry place.
  - Do not give the battery a physical impact.
  - If you observe a leakage of a battery, wipe out the flower and then replace a battery. If the flower adheres your body or clothes, rinse well with water immediately.
  - Obey the local laws on disposing a battery.

To use the remote control, please load the batteries. Whenever the remote control starts to malfunction, replace the batteries. If you won't use the remote control for an extended period, remove the batteries from the remote control and store them in a safe place.

1. Remove the battery cover.
  - Slide back and remove the battery cover in the direction of the arrow.

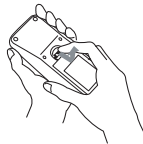

2. Take old batteries out and/or put new batteries in.
  - When putting in batteries, align and insert the two AA batteries according to their plus and minus terminals as indicated in the remote control.

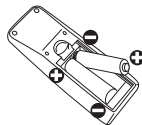

3. Close the battery cover.
  - Replace the battery cover in the direction of the arrow and snap it back into place.

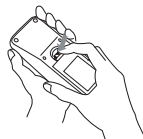



## Using the remote control

**⚠ CAUTION** ▶ Be careful in handling the remote control. Incorrect handling could cause damage or malfunction.

- Do not drop or otherwise expose the remote control to physical impact.
- Do not get the remote control wet or place it on wet objects.
- Remove the batteries from the remote control and store them in a safe place if you won't be using the remote control for an extended period.
- Replace the batteries whenever the remote control starts to malfunction.
- When strong lights such as direct sunlight or light from an extremely close range (such as from an inverter fluorescent lamp) hit the projector's remote sensor, the remote control may not function correctly. Adjust the direction of the projector to keep light from directly hitting the projector's remote sensor.

The remote control works with the projector's remote sensor.

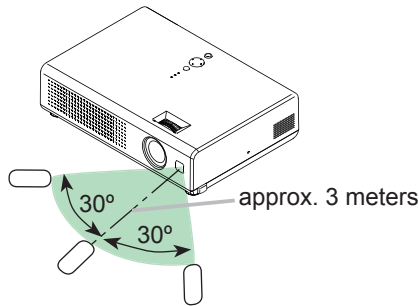

- The range of the remote sensor is 3 meters with a 60 degree range (30 degrees to the left and right of the remote sensor).
- Also a remote signal reflected in the screen etc. may be available. If it is difficult to send a remote signal to the sensor directly, please try.
- Since the remote control uses infrared light to send signals to the projector (Class1 LED), be sure to use the remote control in an area free from obstacles that could block the remote control's output signal to the projector.

## About the filter cover for bottom-up use

**⚠ WARNING** ▶ Do not replace the filter cover and/or air filter during use or immediately after use. Handling while the projector is in a high temperature could cause a burn and/or malfunction to the projector. Before operating, make sure that the power switch is off, that the power cord is not plugged in, and that the projector is cool adequately.

When the projector is installed bottom up, please use the accessory filter cover for bottom-up use. It is higher than usual filter cover, to keep the space for intake ventilation. Please change in the following procedure.

1. Disconnect all the connectors and adapters that were connected to the projector's ports. Then slowly turn the projector so that the lens-side is facing up. Please be careful for a projector not to fall. While the projector is placed lens-side up, hold the projector.
2. Remove the filter cover and the air filter. Hold the knobs while pulling out it.

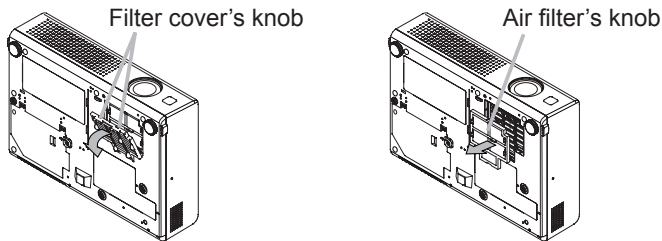

3. Slowly turn the projector so that the bottom is facing up.
4. Set a new or cleaned air filter to the filter cover for bottom-up use. Make the claws slide along the rail, and set the air filter into place.

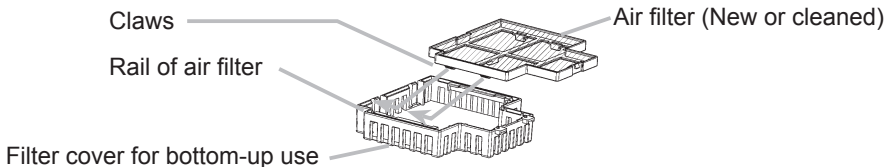

5. Interlocking the tabs, snap the filter cover for bottom-up use into place.

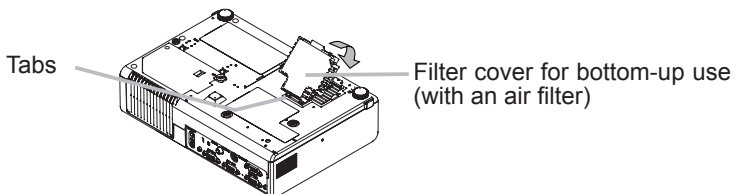

## Setting up

**▲WARNING** ► Place the projector in a stable position horizontally. A fall or a turnover could cause an injury and/or damage to the projector. Then using damaged projector could result in a fire and/or an electric shock.

- Don't place the projector on an unstable, slant or vibrant surface such as a wobbly or inclined stand.
- Do not place the projector in the side/front/rear-up position, except care of the air filter.
- For the projector installed bottom-up, use the accessory filter cover for bottom-up use. And in the case of a ceiling installation or the like, contact your dealer before installation.

► Place the projection in a cool place, and pay attention enough to ventilation. The high temperature of the projector could cause a fire, a burn and/or malfunction to the projector.

- Don't stop up, block and cover the projector's vents.
- Keep a space of 30 cm or more between the sides and other objects such as walls.
- Don't place the projector on a metallic thing or anything weak in heat.
- Don't place the projector on a carpet, cushion or bedding.
- Don't place the projector in direct sunlight or near a hot object such as heater.
- Put nothing about lens and vents of the projector. Put nothing on the projector.
- Put nothing that is sucked or sticks to the bottom of projector. This projector has some intake vents also on the bottom.

► Do not place the projector on the place that gets wet. Damping the projector or inserting liquid in the projector could cause a fire, an electric shock and/or malfunction to the projector.

- Don't place the projector in a bathroom or the outdoors.
- Put nothing containing the liquid near the projector.

**▲CAUTION** ► Avoid a smoky, humid or dusty place. Placing the projector in such place could cause a fire, an electric shock and/or malfunction to the projector.

- Don't place the projector near a humidifier, a smoking space or a kitchen.
- Put nothing containing the liquid near the projector.

► Adjust the direction of the projector to keep light from directly hitting the projector's remote sensor.

## Arrangement

Refer to the illustrations and tables below to determine the screen size and projection distance. The values shown in the table are calculated ( $\pm 3\%$ ) for a full size screen of 800x600 for the model CP-RS56, or 1024x768 for the model CP-RX61.

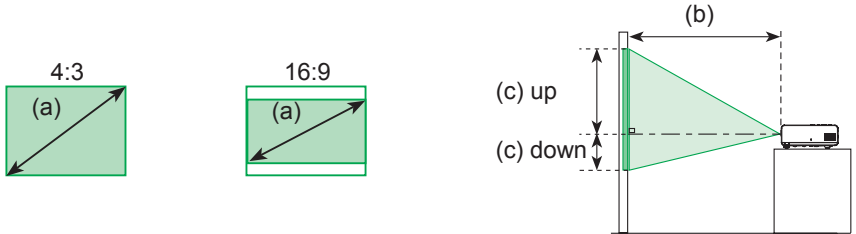

### For the model CP-RS56

(a) Screen size [inch (m)]	4 : 3 screen				16 : 9 screen			
	(b) Projection distance [m (inch)]		(c) Screen height [cm (inch)]		(b) Projection distance [m (inch)]		(c) Screen height [cm (inch)]	
	min.	max.	down	up	min.	max.	down	up
40 (1.0)	1.3 (52)	1.6 (63)	8.7 (3)	52.3 (21)	1.4 (57)	1.7 (68)	1.2 (0)	48.6 (19)
50 (1.3)	1.7 (65)	2.0 (79)	10.9 (4)	65.3 (26)	1.8 (71)	2.2 (86)	1.5 (1)	60.8 (24)
60 (1.5)	2.0 (79)	2.4 (95)	13.1 (5)	78.4 (31)	2.2 (86)	2.6 (103)	1.8 (1)	72.9 (29)
70 (1.8)	2.3 (92)	2.8 (111)	15.2 (6)	91.4 (36)	2.5 (100)	3.1 (121)	2.1 (1)	85.1 (34)
80 (2.0)	2.7 (105)	3.2 (127)	17.4 (7)	104.5 (41)	2.9 (115)	3.5 (138)	2.4 (1)	97.2 (38)
90 (2.3)	3.0 (118)	3.6 (142)	19.6 (8)	117.6 (46)	3.3 (129)	3.9 (155)	2.7 (1)	109.4 (43)
100 (2.5)	3.3 (132)	4.0 (158)	21.8 (9)	130.6 (51)	3.6 (144)	4.4 (173)	3.0 (1)	121.6 (48)
120 (3.0)	4.0 (158)	4.8 (190)	26.1 (10)	156.8 (62)	4.4 (172)	5.3 (207)	3.6 (1)	145.9 (57)
150 (3.8)	5.0 (198)	6.0 (238)	32.7 (13)	195.9 (77)	5.5 (216)	6.6 (260)	4.4 (2)	182.3 (72)
200 (5.1)	6.7 (264)	8.1 (318)	43.5 (17)	261.3 (103)	7.3 (288)	8.8 (346)	5.9 (2)	243.1 (96)
250 (6.4)	8.4 (331)	10.1 (398)	54.4 (21)	326.6 (129)	9.2 (360)	11.0 (433)	7.4 (3)	303.9 (120)
300 (7.6)	10.1 (397)	12.1 (477)	65.3 (26)	391.9 (154)	11.0 (433)	13.2 (520)	8.9 (4)	364.7 (144)

### For the model CP-RX61

(a) Screen size [inch (m)]	4 : 3 screen				16 : 9 screen			
	(b) Projection distance [m (inch)]		(c) Screen height [cm (inch)]		(b) Projection distance [m (inch)]		(c) Screen height [cm (inch)]	
	min.	max.	down	up	min.	max.	down	up
40 (1.0)	1.2 (47)	1.4 (57)	8.7 (3)	52.3 (21)	1.3 (51)	1.6 (62)	1.2 (0)	48.6 (19)
50 (1.3)	1.5 (59)	1.8 (71)	10.9 (4)	65.3 (26)	1.6 (64)	2.0 (78)	1.5 (1)	60.8 (24)
60 (1.5)	1.8 (71)	2.2 (86)	13.1 (5)	78.4 (31)	2.0 (77)	2.4 (93)	1.8 (1)	72.9 (29)
70 (1.8)	2.1 (83)	2.5 (100)	15.2 (6)	91.4 (36)	2.3 (91)	2.8 (109)	2.1 (1)	85.1 (34)
80 (2.0)	2.4 (95)	2.9 (115)	17.4 (7)	104.5 (41)	2.6 (104)	3.2 (125)	2.4 (1)	97.2 (38)
90 (2.3)	2.7 (107)	3.3 (129)	19.6 (8)	117.6 (46)	3.0 (117)	3.6 (141)	2.7 (1)	109.4 (43)
100 (2.5)	3.0 (119)	3.6 (143)	21.8 (9)	130.6 (51)	3.3 (130)	4.0 (156)	3.0 (1)	121.6 (48)
120 (3.0)	3.6 (143)	4.4 (172)	26.1 (10)	156.8 (62)	4.0 (156)	4.8 (188)	3.6 (1)	145.9 (57)
150 (3.8)	4.5 (179)	5.5 (216)	32.7 (13)	195.9 (77)	5.0 (195)	6.0 (235)	4.4 (2)	182.3 (72)
200 (5.1)	6.1 (239)	7.3 (288)	43.5 (17)	261.3 (103)	6.6 (261)	8.0 (314)	5.9 (2)	243.1 (96)
250 (6.4)	7.6 (299)	9.1 (360)	54.4 (21)	326.6 (129)	8.3 (326)	10.0 (392)	7.4 (3)	303.9 (120)
300 (7.6)	9.1 (359)	11.0 (432)	65.3 (26)	391.9 (154)	9.9 (391)	12.0 (471)	8.9 (4)	364.7 (144)

## Adjusting the projector's elevator

**⚠ WARNING** ► Do not adjust the projector's elevator during use or immediately after use. Handling while the projector is in a high temperature could cause a burn and/or malfunction to the projector. Before operating, make sure that the power switch is off, that the power cord is not plugged in, and that the projector is cool adequately.

**⚠ CAUTION** ► If you press the elevator button without holding the projector, the projector might crash down, overturn, smash your fingers and possibly result in malfunction. To prevent damaging the projector and injuring yourself, always hold the projector whenever using the elevator buttons to adjust the elevator feet.

► Except for inclining by the elevator feet adjustment, place the projector horizontally.

You can use the elevator feet to make adjustments if the surface on which you need to set the projector is uneven or if you otherwise need to adjust the angle of projection. The adjustment range of the elevator feet is 0 to 9 degrees.

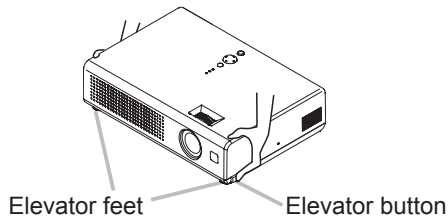

1. Press and hold in the elevator buttons while holding the projector. The elevator buttons and the elevator feet are on the both sides.
2. Raise or lower the projector to the desired height and then release the elevator buttons. When you release the elevator buttons, the elevator feet will lock into position.
3. As necessary, you can also finely adjust the height of the projector by twisting the elevator feet by hand.

## Connecting your devices

**⚠ CAUTION** ▶ Turn off all devices prior to connecting them to the projector. Attempting to connect a live device to the projector may generate extremely loud noises or other abnormalities that may result in malfunction and/or damage to the device and/or projector.

▶ Use the accessory cable or a designated-type cable for the connection. Some cables have to be used with core set. A too long cable may cause a certain picture degradation. Please consult with your dealer for details. For cables that have a core only at one end, connect the core to the projector.

▶ Make sure that you connect devices to the correct port. Incorrect connection may result in malfunction and/or damage to the device and/or projector.

**NOTE** • Whenever attempting to connect a laptop computer to the projector, be sure to activate the laptop's RGB external image output (set the laptop to CRT display or to simultaneous LCD and CRT display). For details on how this is done, please refer to the instruction manual of the corresponding laptop computer.

- Secure the screws on the connectors and tighten.
- Some computers may have multiple display screen modes. Use of some of these modes will not be possible with this projector.
- For some RGB signal modes, the optional Mac adapter is necessary.
- When the image resolution is changed on a computer, depending on an input, automatic adjust function may take some time and may not be completed. In this case, you may not be able to see a check box to select "Yes/No" for the new resolution on Windows. Then the resolution will go back to the original. It might be recommended to use other CRT or LCD monitors to change the resolution.

### **About Plug-and-Play capability**

Plug-and-Play is a system composed of the computer, its operating system and peripheral equipment (i.e. display devices). This projector is compatible with VESA DDC 2B. Plug-and-Play can be achieved by connecting this projector to computers that are VESA DDC (display data channel) compatible.

- Please take advantage of this function by connecting the accessory RGB cable to the RGB IN1 port (DDC 2B compatible). Plug-and-Play may not work properly if any other type of connection is attempted.
- Please use the standard drivers in your computer as this projector is a Plug-and-Play monitor.

### Examples of connection with a computer

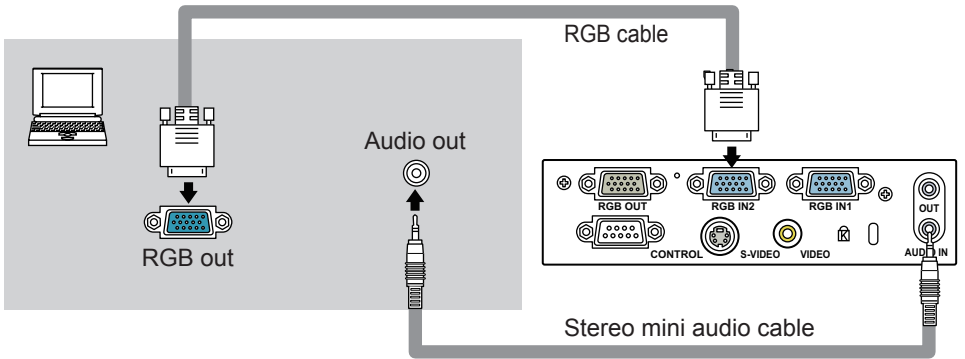
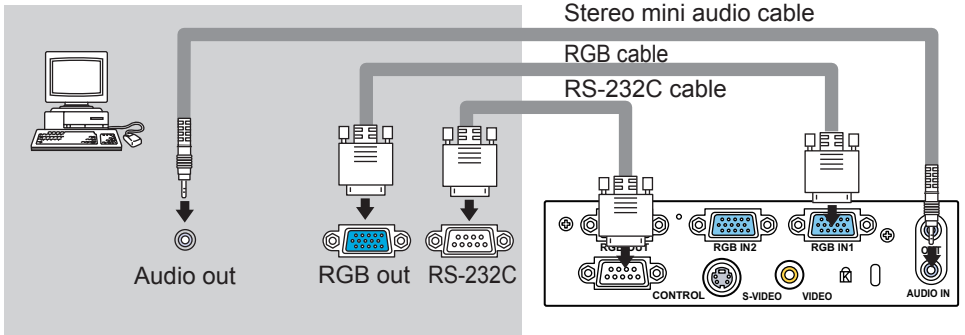

### Connecting to a monitor (output)

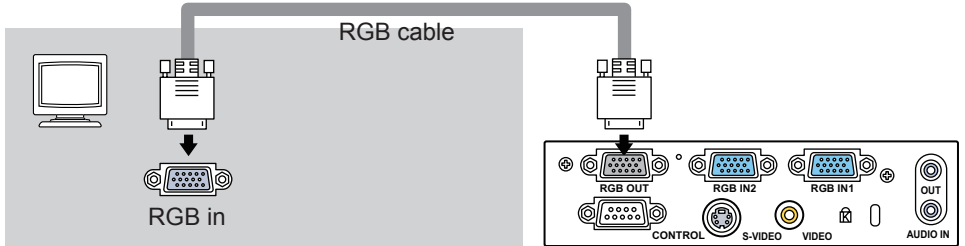

### Connecting to a speaker with amplifier (output)

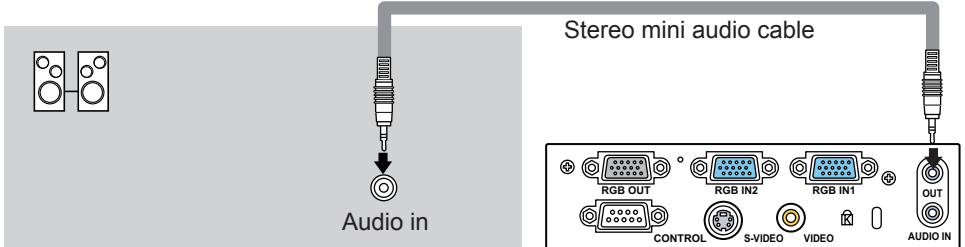

Examples of connection with a VCR/DVD player

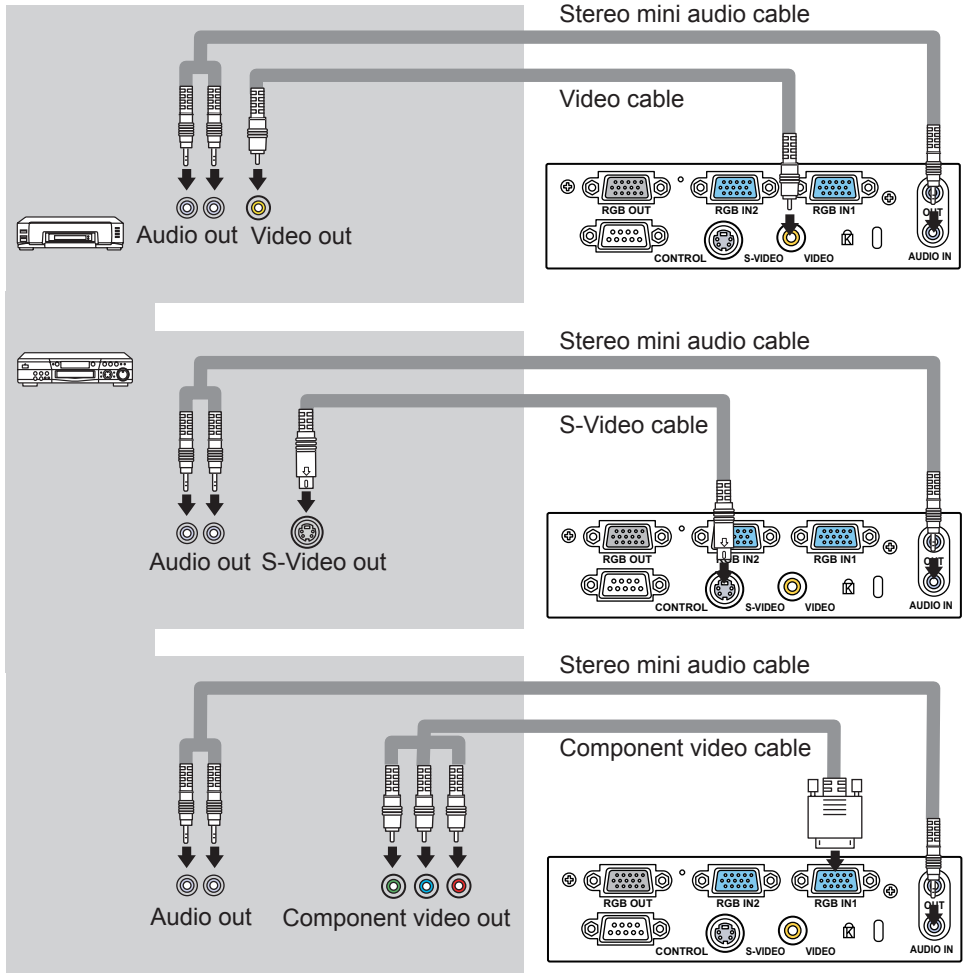



## Connecting power supply

- ⚠ WARNING ►** Please use extra caution when connecting the power cord as incorrect or faulty connections may result in fire and/or electrical shock.
- Only use the power cord that came with the projector. If it is damaged, contact your dealer to newly get correct one.
  - Only plug the power cord into an outlet rated for use with the power cord's specified voltage range.
  - Never modify the power cord. Never attempt to defeat the ground connection of the three-pronged plug.

Before connecting, make sure that the power switch is the OFF position (pressed the side marked "O").

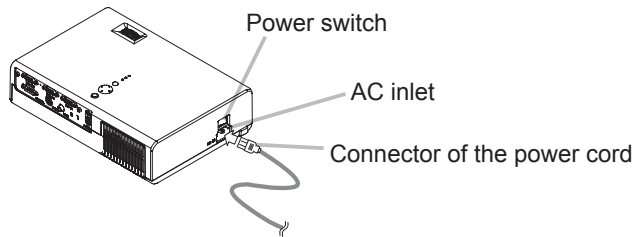

1. Connect the connector of the power cord to the AC inlet of the projector.
2. Firmly plug the power cord's plug into the outlet.

## Power on/off

## Turning on the power

**⚠ WARNING** ► When the power is on, a strong light is emitted. Do not look into the lens or vents of the projector.

**NOTE** • Turn the power on in right order. Please power on the projector before the connected devices.

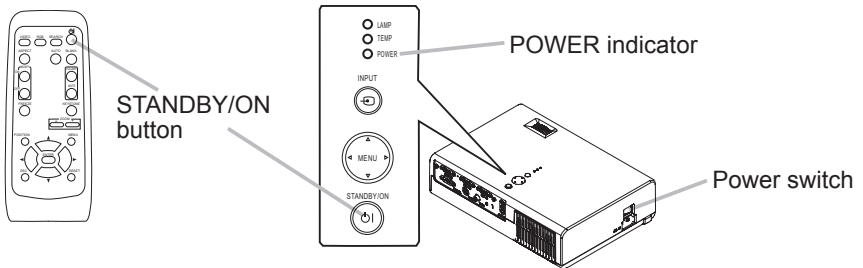

1. Make sure that the power cord is firmly and correctly connected to the projector and outlet.
2. Open the lens cover, and set the power switch to the ON position. The power indicator will light to solid orange. Then wait several seconds because buttons may not function for these several seconds.

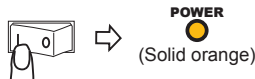

3. Press the STANDBY/ON button on the projector or remote control. The projector lamp will light up and the POWER indicator will begin blinking green. When the power is completely on, the indicator will stop blinking and light green.

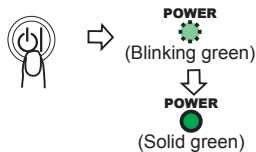

To display the picture, select an input signal according to the section "Selecting an input signal" (19).

## Turning off the power

**NOTE** • Turn the power off in right order. Please power off the projector after the connected devices.

- Except for an emergency, whenever you turn the projector off, obey the procedure of the following “Turning off the power”, and do not disconnect the power cord until the procedure is completed. Neglect causes a damage of the electrode and un-lighting of the lamp.
- This Projector is controlled by an internal microprocessor. Under certain exceptional circumstances, the projector may not operate correctly even for turning off the power. In such a case, please push the restart switch (4) by using a pin or similar. After making sure that the power indicator lights to solid orange, set the power switch to the OFF position. Only push the restart switch in these exceptional instances.
- When a power supply is shut off with a power failure or the restart switch, before turning on again, make the projector cool down at least 10 minutes without operating.

1. Press the STANDBY/ON button on the projector or remote control.  
The message "Power off?" will appear on the screen for approximately 5 seconds.



2. Press the STANDBY/ON button on the projector or remote control again while the message is visible.  
The projector lamp will go off, and the POWER indicator will begin blinking orange. Then the POWER indicator will stop blinking and light to solid orange when the lamp cooling is complete.

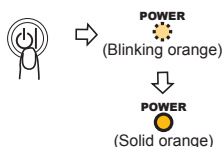

3. Make sure that the power indicator lights to solid orange, set the power switch to the OFF position. The POWER indicator will go off.  
Do not set the power switch to the OFF position while the POWER indicator is green or blinking.



4. Close the lens cover. For safety purposes, disconnect the power cord if the projector is not to be used for prolonged periods of time.

Operating

### Adjusting the volume

1. Press the VOLUME button on the remote control.
  - A dialog will appear on the screen to aid you in adjusting the volume.
2. Use the cursor buttons ▲/▼ to adjust the volume.
  - To close the dialog and complete the operation, press the VOLUME button again. Even if you don't do anything, the dialog will automatically disappear after a few seconds.

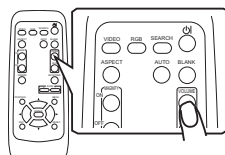

### Temporarily muting the sound

1. Press the MUTE button on the remote control.
  - A dialog will appear on the screen indicating that you have muted the sound.
  - To restore the sound, press the MUTE button or VOLUME button. Even if you don't do anything, the dialog will automatically disappear after a few seconds.

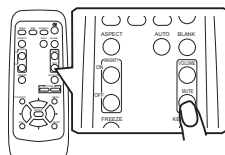

### Selecting an input signal

1. Press the INPUT button on the projector.
  - Each time you press the button, the projector switches its input port as below.

RGB1 → RGB2 → S-VIDEO → VIDEO

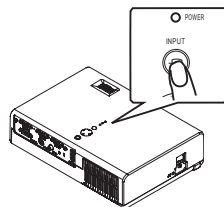

1. Press the RGB button on the remote control to select the RGB port.

RGB1 → RGB2

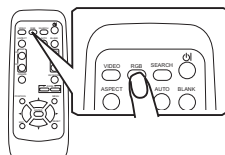

1. Press the VIDEO button on the remote control to select an input port for video signal.
  - Each time you press the button, the projector switches its video input port as below.

S-VIDEO → VIDEO

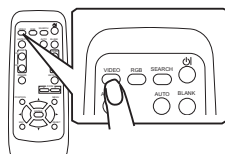

- If the VIDEO button is pushed (when switching from RGB to VIDEO signals) when TURN ON is selected for the AUTO SEARCH item in the OPTION menu (p.39) the projector will check the S-VIDEO port first. If no input is detected at the S-VIDEO port, projector will check the VIDEO port automatically.

## Searching an input signal

1. Press the SEARCH button on the remote control.
  - The projector will begin to check its input ports in order to find any input signals.
 Then when an input is found, the projector will stop searching and display the image. If no signal is found, the projector will return to the state selected before the operation.

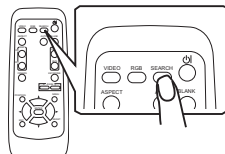

RGB1 → RGB2 → S-VIDEO → VIDEO



## Selecting an aspect ratio

1. Press the ASPECT button on the remote control.
  - Each time you press the button, the projector switches the modes for aspect ratio in turn.

### ○ At a RGB signal

NORMAL → 4:3 → 16:9



### ○ At a video signal /no signal

4:3 → 16:9

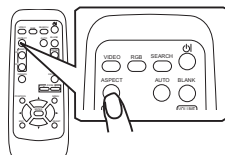

- The NORMAL mode keeps the original aspect ratio of the signal.
- At a HDTV component video signal of 1125i (1080i) or 750p (720p), only 16:9 mode can be selected.
- Performing the automatic adjustment initializes the aspect ratio setting.

## Adjusting the zoom (Optical)

1. Use the zoom knob to adjust the screen size.

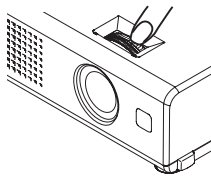

## Adjusting the zoom (Digital)

1. Press the ZOOM +/- button on the remote control.
  - A dialog will appear on the screen to aid you in adjusting the zoom.
2. Use the ZOOM buttons +/- to adjust the zoom.
  - To close the dialog and complete this operation, don't perform operation for a few seconds.

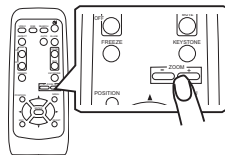

## Adjusting the focus

1. Use the focus ring to focus on the picture.

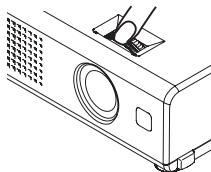

## Using the automatic adjustment feature

1. Press the AUTO button on the remote control.

- **At a RGB signal**

The vertical position, the horizontal position, the horizontal phase, the aspect and horizontal size will be automatically adjusted.

Make sure that the application window is set to its maximum size prior to attempting to use this feature. A dark picture may still be incorrectly adjusted. Use a bright picture when adjusting.

- **At a video signal**

S-VIDEO · VIDEO:

The video format best suited for the respective input signal, the vertical position, the horizontal position phase and the aspect will be automatically adjusted.

COMPONENT:

The vertical position, the horizontal position, the clock phase and the aspect will be automatically adjusted.

This function is available only when the AUTO mode is selected at the VIDEO FORMAT MENU. Refer to Page (33) of this manual.

For a component video signal, the signal type is automatically identified, regardless of this function.

- The automatic adjustment operation requires approximately 10 seconds. Also please note that it may not function correctly with some input.

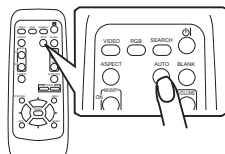

## Adjusting the position

1. Press the POSITION button on the remote control.
1. The "POSITION" indication will appear on the screen.
2. Use the cursor buttons ▲/▼/◀/▶ to adjust the picture position.
2. When you want to reset the operation, press the RESET button on the remote control during the operation.

To complete this operation, press the POSITION button again. Even if you don't do anything, the dialog will automatically disappear after a few seconds.

- When this function is performed at a video signal, a certain extra such as a line may appear outside a picture.

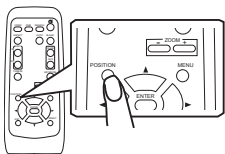

## Correcting the keystone distortions

1. Press the KEYSTONE button on the remote control.
1. A dialog will appear on the screen to aid you in correcting the distortion.
2. Use the cursor buttons ▲/▼ to correct the distortion.
2. To close the dialog and complete this operation, press the KEYSTONE button again. Even if you don't do anything, the dialog will automatically disappear after a few seconds.

- This function may not work well with some input.
- The adjustable range for correcting will vary among inputs.

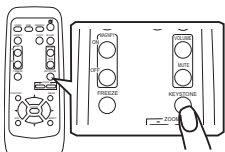

## Using the partial magnify feature

1. Press the ON button of MAGNIFY on the remote control.
    - The “MAGNIFY” indication will appear on the screen (although the indication will disappear after several seconds with no operation.), and the projector will enter the MAGNIFY mode.
  2. Use the cursor buttons ▲/▼ to adjust the zoom level.
    - To move the zoom area, press the POSITION button in the MAGNIFY mode, then use the cursor buttons ▲/▼/◀/▶. And to finalize the zoom area, press the POSITION button again.
    - To exit the MAGNIFY mode and restore the screen to normal, press the OFF button of MAGNIFY on the remote control.
- The projector automatically exits the MAGNIFY mode when the input signal changes, or when an operation of changing the display condition (automatic adjustment, etc.) is executed.
  - Although the keystone distortion condition may vary in the MAGNIFY mode, it will be restored when the projector exit the MAGNIFY mode.

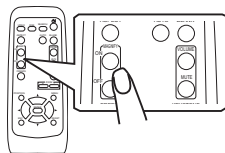

## Freezing the screen

1. Press the FREEZE button on the remote control.
    - The “FREEZE” indication will appear on the screen, and the projector will enter the FREEZE mode.
    - To exit the FREEZE mode and restore the screen to normal, press the FREEZE button again.
- The projector automatically exits the FREEZE mode when the input signal changes, or when one of the projector’s buttons or the remote control buttons of STANDBY/ON, SEARCH, RGB, VIDEO, BLANK, AUTO, ASPECT, VOLUME, MUTE, KEYSTONE, POSITION and MENU is pressed.
  - If the projector continues projecting a still image for long time, the LCD panel might possibly be printed. Do not leave the projector in FREEZE mode for too long.

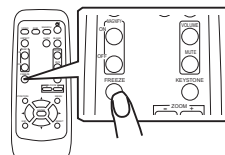

## Temporarily blanking the screen

1. Press the BLANK button on the remote control.
    - The blank screen will be displayed instead of the screen of input signal. Please refer to the item BLANK of section SCREEN menu (36).
    - To remove the blank screen and return to the input signal screen, press the BLANK button again.
- The projector automatically returns to the input signal screen when the input signal changes, or when one of the projector’s buttons or the remote control buttons are pressed.

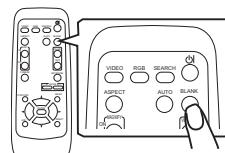

## Multifunctional settings

**NOTE** • Regardless of description of this manual, these functions may not work correctly with some input.

### Using the menu function

This projector has the following menus: PICTURE, IMAGE, INPUT, SETUP, SCREEN, OPTION and EASY MENU. Each of these menus is operated using the same methods. The basic operations of these menus are as follows.

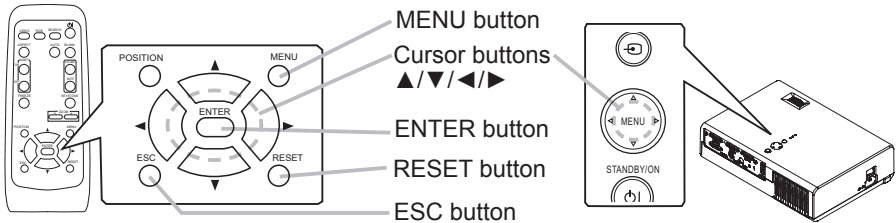

- To display a menu  
Press the MENU button on the remote control or one of the cursor buttons ▲/▼/◀/▶ on the projector. The Advance MENU or EASY MENU will appear.
- To choose the target menu  
Point at one of choices on the menu using the cursor buttons ▲/▼, then press the cursor button ▶ or the ENTER button.  
At the Advance menu, when some menu is chosen already and you want to choose other menu, please return to the main menu beforehand, using the cursor button ◀ or the ESC button before choosing the menu.

#### (1) EASY MENU → Advance MENU

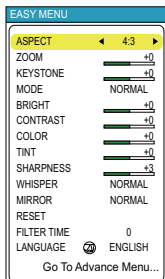

EASY MENU

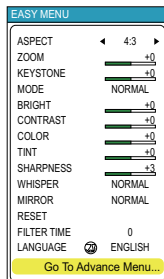

EASY MENU

▶ / ENTER

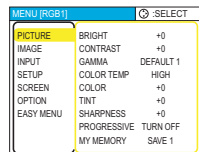

Advance MENU



(2) PICTURE of Advance MENU → one of Advance Menus (ex. SETUP menu)

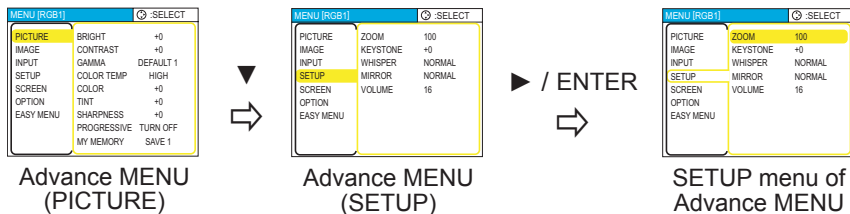

(3) Advance Menu → EASY MENU

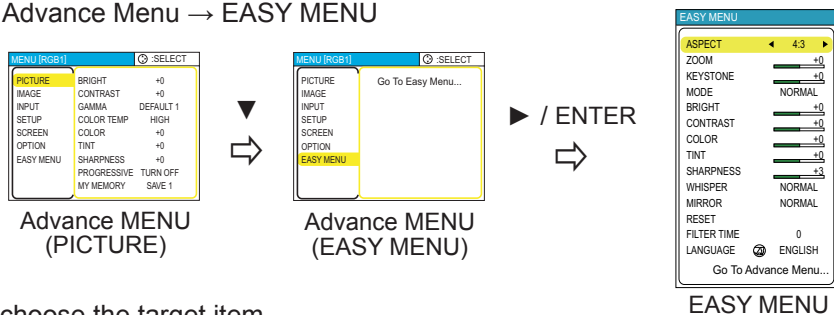

### 3. To choose the target item

Point at one of choices on the menu using the cursor buttons ▲/▼. At an Advance menu, then press the cursor button ► or the ENTER button.

(1) At EASY MENU (ex. KEYSTONE)

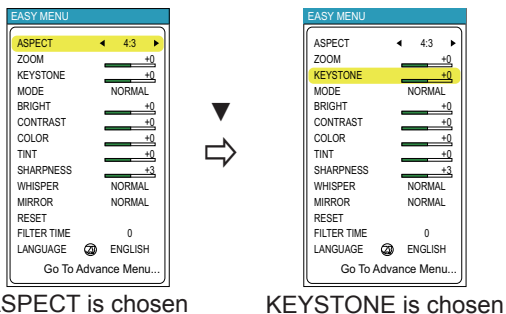

(2) At Advance Menu (ex. KEYSTONE)

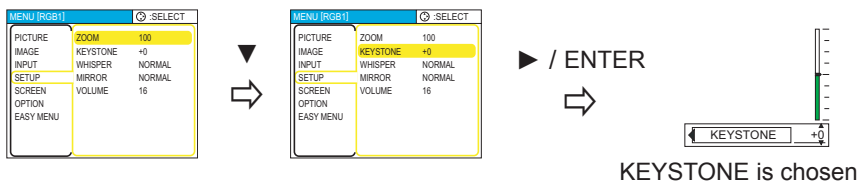

4. To operate
  - (1) At EASY MENU, use the cursor buttons ◀/▶ to operate.
  - (2) At Advance MENU, use the cursor buttons ▲/▼.

5. To return to the previous menu
  - (1) One of Advance Menus (ex. SETUP menu) → Main of Advance MENU

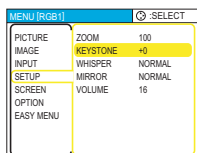

SETUP MENU of Advance MENU

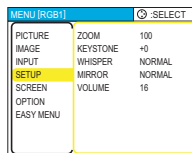

Main of Advance MENU

- (2) Dialogs for operation (ex. KEYSTONE) → Advance MENU



Dialog for KEYSTONE

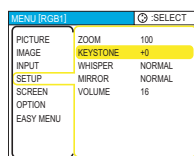

SETUP menu

6. To reset

- (1) Each item
  - Press the RESET button while operating.
- (2) Items of EASY MENU (at a time)
  - Point at "RESET" on the menu using the cursor buttons ▲/▼, then press the cursor button ▶ or the ENTER button. The dialog for reset will appear. Point at "RESET" on the dialog using the cursor button ▲.
- (3) Items of an Advance MENU
  - Press the RESET button while pointing the menu name. The dialog for reset will appear.
  - Point at "RESET" on the dialog using the cursor button ▲.

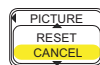

Note that items whose functions are performed simultaneously with operation (ex. LANGUAGE, H PHASE etc.) aren't reset.

7. To close the menu
  - Press the MENU button again.

Even if you don't do anything, the operation will complete and the menu will disappear automatically after about 10 seconds.

## EASY MENU

With the EASY MENU, items shown in the table below can be performed.

Choose an item using the cursor buttons ▲/▼ on the projector or remote control. Then perform it referring to the following table.

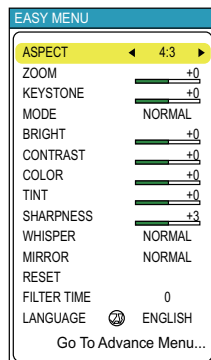

Item	Description
<b>ASPECT</b>	Using the buttons ◀/▶ switches the mode for aspect ratio. See the item ASPECT of section IMAGE menu. (📖31, 20)
<b>ZOOM</b>	Using the buttons ◀/▶ adjusts the zoom. See the item ZOOM of section SETUP menu. (📖35, 20)
<b>KEYSTONE</b>	Using the buttons ◀/▶ corrects the keystone distortion. See the item KEYSTONE of section SETUP menu. (📖35, 21)
<b>MODE</b>	Using the buttons ◀/▶ switches the mode of picture type. The modes of picture type are combinations of a mode of GAMMA (📖28) and a mode of COLOR TEMP (📖29). Choose a suitable mode according to the projected source. NORMAL ⇄ CINEMA ⇄ DYNAMIC ↕ ↕ NORMAL: (COLOR TEMP = MIDDLE) + (GAMMA = #1 DEFAULT) CINEMA: (COLOR TEMP = LOW) + (GAMMA = #2 DEFAULT) DYNAMIC: (COLOR TEMP = HIGH) + (GAMMA = #3 DEFAULT) • When the combination of GAMMA and COLOR TEMP differs from pre-assigned modes above, the display on the menu for the MODE is "CUSTOM".
<b>BRIGHT</b>	Using the buttons ◀/▶ adjusts the brightness. See the item BRIGHT of section PICTURE menu. (📖28)
<b>CONTRAST</b>	Using the buttons ◀/▶ adjusts the contrast. See the item CONTRAST of section PICTURE menu. (📖28)
<b>COLOR</b>	Using the buttons ◀/▶ adjusts the strength of whole color. See the item COLOR of section PICTURE menu. (📖29) • This item can be chosen only at a video signal.
<b>TINT</b>	Using the buttons ◀/▶ adjusts the tint. See the item TINT of section PICTURE menu. (📖29) • This item can be chosen only at a video signal.

**EASY MENU (continued)**

Item	Description
<b>SHARPNESS</b>	Using the buttons ◀/▶ adjusts the sharpness. See the item SHARPNESS of section PICTURE menu. (📖29)
<b>WHISPER</b>	Using the buttons ◀/▶ turns off/on the whisper mode. See the item WHISPER of section SETUP menu. (📖35)
<b>MIRROR</b>	Using the buttons ◀/▶ switches the mode for mirror status. See the item MIRROR of section SETUP menu. (📖35)
<b>RESET</b>	Performing this item resets all of the items of EASY MENU except FILTER TIME and LANGUAGE. Pressing the button ▶ displays a dialog to make sure. To perform reset, point at RESET using the button ▲. (📖25)
<b>FILTER TIME</b>	Performing this item resets the filter timer which counts use time of air filter. See the item FILTER TIME of section OPTION menu. (📖40)
<b>LANGUAGE</b>	Using the buttons ◀/▶ switches the language of menu. See the item LANGUAGE of section SCREEN menu. (📖36)
<b>Go To Advance Menu</b>	Pointing at the “Go To Advance Menu” and pressing the button ▶ changes the EASY MENU into the Advance MENU. (📖23) Performs to use the menu of PICTURE, IMAGE, INPUT, SETUP, SCREEN or OPTION.

## PICTURE menu

With the PICTURE menu, items shown in the table below can be performed.

Choose an item using the cursor buttons ▲/▼ on the projector or remote control, and press the cursor button ► on the projector or remote control, or the ENTER button on the remote control to progress. Then perform it referring to the following table.

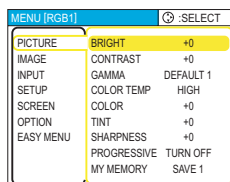

Item	Description
<b>BRIGHT</b>	Using the buttons ▲/▼ adjusts the brightness. : Light ⇄ Dark
<b>CONTRAST</b>	Using the buttons ▲/▼ adjusts the contrast. : Strong ⇄ Weak
<b>GAMMA</b>	<p>Using the buttons ▲/▼ switches the GAMMA mode.</p> <p>#1 DEFAULT ⇄ #1 CUSTOM ⇄ #2 DEFAULT</p> <p>↑ ↓</p> <p>#3 CUSTOM ⇄ #3 DEFAULT ⇄ #2 CUSTOM</p> <p><b>To adjust #1 CUSTOM, #2 CUSTOM or #3 CUSTOM</b></p> <p>Selecting a mode of CUSTOM and then pressing the button ► or the ENTER button displays a dialog to aid you in adjusting the mode.</p> <p>This function is useful when you want to change the brightness of particular tones.</p> <p>Choose an item using the buttons ◀/▶, and adjust the level using the buttons ▲/▼.</p> <p><b>Using a test pattern</b></p> <p>You can display a test pattern for checking the effect of your adjustment by pressing the ENTER button. Each time you press the ENTER button, the pattern changes as below.</p> <p>No pattern ⇄ Gray scale of 9 steps ⇄ Ramp ⇄ Gray scale of 15 steps</p> <p>Eight of equalizing bars corresponds to eight of tone level of test pattern except the darkest in the left end. If you want to adjust the 2nd tone from left end on the test pattern, use the equalizing adjustment bar "1". The darkest tone at the left end of the test pattern cannot be controlled with any of equalizing adjustment bar.</p>

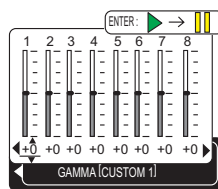
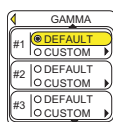

PICTURE menu (continued)

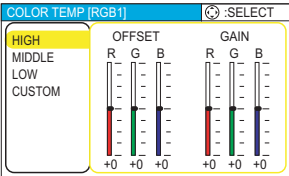
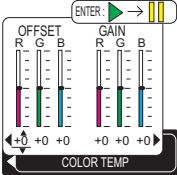
Item	Description
<p><b>COLOR TEMP</b></p>	<p>Using the buttons ▲/▼ switches the mode of color temperature.</p> <p style="text-align: center;">HIGH ⇄ MIDDLE            ↓                    ↓            CUSTOM ⇄ LOW</p> <p style="text-align: center;"><b>To adjust CUSTOM</b></p> <p>Selecting the CUSTOM and then pressing the button ► or the ENTER button displays a dialog to aid you in adjusting the OFFSET and/or GAIN of CUSTOM mode.</p> <p>OFFSET adjustments change the color intensity on the whole tones of the test pattern.</p> <p>GAIN adjustments mainly affect color intensity on the brighter tones of the test pattern.</p> <p>Choose an item using the buttons ◀/▶, and adjust the level using the buttons ▲/▼.</p> <p style="text-align: center;"><b>Using a test pattern</b></p> <p>You can display a test pattern for checking the effect of your adjustment by pressing the ENTER button. Each time you press the ENTER button, the pattern changes as below.</p> <p style="text-align: center;">No pattern ⇄ Gray scale of 9 steps ⇄ Ramp ⇄ Gray scale of 15 steps</p> <div style="display: flex; justify-content: space-around; align-items: center;">   </div>
<p><b>COLOR</b></p>	<p>Using the buttons ▲/▼ adjusts the strength of whole color.</p> <p style="text-align: center;">Strong ⇄ Weak</p> <ul style="list-style-type: none"> <li>• This item can be chosen only at a video signal.</li> </ul>
<p><b>TINT</b></p>	<p>Using the buttons ▲/▼ adjusts the tint.</p> <p style="text-align: center;">Green ⇄ Red</p> <ul style="list-style-type: none"> <li>• This item can be chosen only at a video signal.</li> </ul>
<p><b>SHARPNESS</b></p>	<p>Using the buttons ▲/▼ adjusts the sharpness.</p> <p style="text-align: center;">Strong ⇄ Weak</p>

**PICTURE menu (continued)**

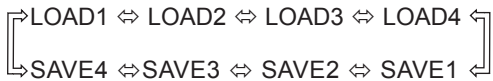
Item	Description
<p><b>PROGRESSIVE</b></p>	<p>Using the buttons ▲/▼ switches the progressive mode.            TV ⇔ FILM ⇔ TURN OFF  </p> <ul style="list-style-type: none"> <li>• This function performs only at an interlaced signal of a VIDEO input, a S-VIDEO input or a component video input of 525i (480i) or 625i (576i) signal.</li> <li>• When the TV or FILM is selected, the screen image will be crisper. The FILM mode is adaptable to the 2-3 Pull-Down system to the conversion. (not adaptable to the 2-2 Pull-Down system) But these may cause a certain defect (for example, jagged line) of the picture at a quick moving object. In such a case, please select the TURN OFF, even though the screen image may lose the crisp.</li> </ul>
<p><b>MY MEMORY</b></p>	<p>Choosing a mode of MY MEMORY using the buttons ▲/▼ and then pressing the button ► or the ENTER button performs each function.  </p> <p>This projector has 4 numbered memories for adjustment data. Performing the LOAD1, LOAD2, LOAD3 or LOAD4 loads the data on the memory whose number corresponds with the command's number, and adjusts the picture automatically depending on the data. Performing the SAVE1, SAVE2, SAVE3 or SAVE4 puts the current adjustment data on the memory whose number corresponds with the command's number.</p>

## IMAGE menu

With the IMAGE menu, items shown in the table below can be performed.

Choose an item using the cursor buttons ▲/▼ on the projector or remote control, and press the cursor button ► on the projector or remote control, or the ENTER button on the remote control to progress. Then perform it referring to the following table.

MENU [RGB1]		SELECT
PICTURE	ASPECT	4:3
IMAGE	OVER SCAN	5
INPUT	V POSITION	25
SETUP	H POSITION	142
SCREEN	H PHASE	16
OPTION	H SIZE	1344
EASY MENU	AUTO ADJUST EXECUTE	

Item	Description
<b>ASPECT</b>	<p>Using the buttons ▲/▼ switches the mode for aspect ratio.</p> <p><b>At a RGB signal</b>            4:3 ⇔ 16:9 ⇔ NORMAL            ↑—————↑</p> <p><b>At a video signal / no signal</b>            4:3 ⇔ 16:9            ↑—————↑</p> <ul style="list-style-type: none"> <li>• The NORMAL mode keeps the original aspect ratio of the signal.</li> <li>• At a HDTV component video signal of 1125i (1080i) or 750p (720p), this item can't be chosen.</li> <li>• Performing the automatic adjustment initializes the aspect ratio setting.</li> </ul>
<b>OVER SCAN</b>	<p>Using the buttons ▲/▼ adjusts the over-scan ratio.            Large (It reduces picture) ⇔ Small (It magnifies picture)</p> <ul style="list-style-type: none"> <li>• This item can be chosen only at a video signal.</li> <li>• When this adjustment is too large, certain degradation may appear at the frame area of the picture. In such a case, please adjust small.</li> <li>• The number displayed on the menu during this adjustment is just for your reference, and might not be exact display ratio.</li> </ul>
<b>V POSITION</b>	<p>Using the buttons ▲/▼ adjusts the vertical position.            Up ⇔ Down</p>
<b>H POSITION</b>	<p>Using the buttons ▲/▼ adjusts the horizontal position.            Left ⇔ Right</p>
<b>H PHASE</b>	<p>Using the buttons ▲/▼ adjusts the horizontal phase to eliminate flicker.            Right ⇔ Left</p> <ul style="list-style-type: none"> <li>• This item can be chosen only at a RGB signal or a component video signal.</li> </ul>



**IMAGE menu (continued)**

Item	Description
<p><b>H SIZE</b></p>	<p>Using the buttons ▲/▼ adjusts the horizontal size.                      Large ↔ Small</p> <ul style="list-style-type: none"> <li>• This item can be chosen only at a RGB signal.</li> <li>• When this adjustment is excessive, the picture may not be displayed correctly. In such a case, please reset the adjustment pressing the RESET button during this operation.</li> </ul>
<p><b>AUTO ADJUST EXECUTE</b></p>	<p>Choosing this item performs the automatic adjustment feature.</p> <p>○ <b>At a RGB signal</b>                      The vertical position, the horizontal position, the horizontal phase, the aspect and horizontal size will be automatically adjusted.                      Make sure that the application window is set to its maximum size prior to attempting to use this feature. A dark picture may still be incorrectly adjusted. Use a bright picture when adjusting.</p> <p>○ <b>At a video signal</b>                      S-VIDEO · VIDEO:                      The video format best suited for the respective input signal, the vertical position, the horizontal position phase and the aspect will be automatically adjusted.</p> <p>COMPONENT:                      The vertical position, the horizontal position, the clock phase and the aspect will be automatically adjusted.</p> <p>This function is available only when the AUTO mode is selected at the VIDEO FORMAT MENU. Refer to Page (33) of this manual.                      For a component video signal, the signal type is automatically identified, regardless of this function.</p> <ul style="list-style-type: none"> <li>• The automatic adjustment operation requires approximately 10 seconds. Also please note that it may not function correctly with some input.</li> </ul>



**INPUT menu (continued)**

Item	Description
<p><b>FRAME LOCK</b></p>	<p>Using the buttons ▲/▼ turns the frame lock function on/off. TURN ON ⇔ TURN OFF</p> <ul style="list-style-type: none"> <li>• This item performs only at a RGB signal with vertical frequency of 50 to 72 Hz.</li> <li>• When the TURN ON is selected, a moving picture is displayed more smoothly.</li> <li>• This function may cause a certain degradation of the picture. In such a case, please select the TURN OFF.</li> </ul>
<p><b>INFORMATION</b></p>	<p>Choosing this item displays a dialog titled “INPUT INFORMATION”. It shows the information about the current input.</p> <div style="display: flex; justify-content: space-around; align-items: center;"> <div data-bbox="487 560 605 627" style="border: 1px solid black; padding: 5px; text-align: center;"> <p>◀ INPUT-INFORMATION RGB 1024x768 @60Hz FRAME LOCK</p> </div> <div data-bbox="726 560 845 627" style="border: 1px solid black; padding: 5px; text-align: center;"> <p>◀ INPUT-INFORMATION S-VIDEO SECAM AUTO</p> </div> </div> <ul style="list-style-type: none"> <li>• The “FRAME LOCK” message on the dialog means the frame lock function is working. (📖 34)</li> <li>• This item can't be chosen at no signal.</li> </ul>

## SETUP menu

With the SETUP menu, items shown in the table below can be performed.

Choose an item using the cursor buttons ▲/▼ on the projector or remote control, and press the cursor button ► on the projector or remote control, or the ENTER button on the remote control to progress. Then perform it referring to the following table.

MENU [RGB1]		◀ SELECT
PICTURE	ZOOM	100
IMAGE	KEYSTONE	+0
INPUT	WHISPER	NORMAL
SETUP	MIRROR	NORMAL
SCREEN	VOLUME	16
OPTION		
EASY MENU		

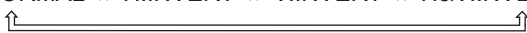
Item	Description
<b>ZOOM</b>	Using the buttons ▲/▼ adjusts the zoom (magnifying power). Large ⇔ Small
<b>KEYSTONE</b>	Using the buttons ▲/▼ corrects the keystone distortion. Upper in the data ⇔ Lower in the data <ul style="list-style-type: none"> <li>• The adjustable range of this function will vary with the type of input signal. At some signals, this function may not work well.</li> <li>• When the V:INVERT or the H&amp;V:INVERT is selected under the item MIRROR, if the projector screen is inclined or if the projector is angled downward, this function may not work correctly.</li> <li>• When the zoom adjustment is set to the TELE side, this correction may be excessive. This function should be used with zoom set to WIDE whenever possible.</li> </ul>
<b>WHISPER</b>	Using the buttons ▲/▼ turns off/on the whisper mode. NORMAL ⇔ WHISPER <ul style="list-style-type: none"> <li>• When the WHISPER is selected, acoustic noise and screen brightness are reduced.</li> </ul>
<b>MIRROR</b>	Using the buttons ▲/▼ switches the mode for mirror status.  NORMAL ⇔ H:INVERT ⇔ V:INVERT ⇔ H&V:INVERT 
<b>VOLUME</b>	Using the buttons ▲/▼ adjusts the volume. High ⇔ Low

## SCREEN menu



With the SCREEN menu, items shown in the table below can be performed.

Choose an item using the cursor buttons ▲/▼ on the projector or remote control, and press the cursor button ► on the projector or remote control, or the ENTER button on the remote control to progress. Then perform it referring to the following table.

MENU [RGB1]		SELECT
PICTURE	LANGUAGE ● ENGLISH	
IMAGE	MENU POSITION	
INPUT	OSD BRIGHT 5	
SETUP	BLANK	BLACK
SCREEN	START UP	ORIGINAL
OPTION	MyScreen	
EASY MENU	MyScreen Lock	TURN OFF
	MESSAGE	TURN ON

Item	Description
<b>LANGUAGE</b>	<p>Using the buttons ▲/▼ switches the OSD (On Screen Display) language.</p> <p>ENGLISH ⇔ FRANÇAIS ⇔ DEUTSCH ⇔ ESPAÑOL ⇔ ITALIANO            ↓            NORSK ⇔ NEDERLANDS ⇔ PORTUGUÊS ⇔ 日本語            ↓            简体中文 ⇔ 繁體中文 ⇔ 한글 ⇔ SVENSKA ⇔ РУССКИЙ            ↓            SUOMI ⇔ POLSKI ⇔ TÜRKÇE</p>
<b>MENU POSITION</b>	<p>Using the buttons ◀/▶/▲/▼ adjusts the menu position.            To quit the operation, press the MENU button or keep no operation for 10 seconds.</p>
<b>OSD BRIGHT</b>	<p>Using the buttons ▲/▼ switches the brightness level of the OSD (On Screen Display).            Bright ⇔ Dark</p>
<b>BLANK</b>	<p>Using the buttons ▲/▼ switches the mode for the blank screen. The blank screen is the screen for the temporarily blanking feature (📺22). It is displayed by pressing the BLANK button.</p> <p>MyScreen ⇔ ORIGINAL ⇔ BLUE ⇔ WHITE ⇔ BLACK</p> <p>MyScreen is the screen you can register a desired screen. ORIGINAL screen is the existing standard screen. BLUE, WHITE and BLACK are non-patterned (plain) screens in each color.</p> <ul style="list-style-type: none"> <li>To avoid remaining as an afterimage, the MyScreen and the ORIGINAL screens will change to the BLACK screen after several minutes.</li> <li>For the MyScreen, please refer to the item MyScreen (📺37).</li> </ul>

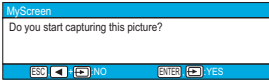
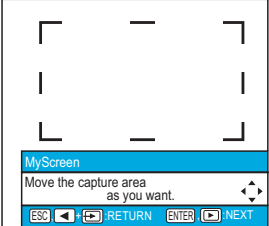
**SCREEN menu (continued)**

Item	Description
<p><b>START UP</b></p>	<p>Using the buttons ▲/▼ switches the mode for the start up screen. The start up screen is the screen displayed when no signal or an unsuitable signal is detected.</p> <p style="text-align: center;">MyScreen ⇄ ORIGINAL ⇄ TURN OFF  </p> <p>MyScreen is the screen you can register a desired screen. ORIGINAL screen is the existing standard screen. When the TURN OFF is selected, the BLACK screen is used.</p> <ul style="list-style-type: none"> <li>• To avoid remaining as an afterimage, the MyScreen and the ORIGINAL screens will change to the BLANK screen after several minutes. If also the BLANK screen is the MyScreen or ORIGINAL, it will change to the BLACK screen.</li> <li>• For the MyScreen, please refer to the item MyScreen below.</li> </ul> <p>About the BLANK screen, please refer to the item BLANK (36).</p>
<p><b>MyScreen</b></p>	<p>This item functions for capturing the MyScreen of the blank screen and the start up screen. Please execute displaying the input including the picture you want to capture.</p> <ol style="list-style-type: none"> <li>1. Choosing this item displays a dialog titled “MyScreen”. It will ask you if you start capturing the picture from the current screen. Please wait for the target picture to be displayed.</li> <li>2. Press the ENTER button when the picture is display. The picture will freeze and the frame for capturing appears. To stop performing, press the RESET or ESC button.</li> <li>3. Using the buttons ◀/▶/▲/▼ adjust the frame position. Please move the frame to the position of the picture which you want to use. The frame may not be able to be moved for some input signals. To start registration, press the ENTER button. To restore the screen and return to the previous dialog, press the RESET or ESC button.</li> </ol> <p>Registration takes several minutes. When the registration is completed, the registered screen and the message “MyScreen registration is finished.” are displayed for several seconds. If the registration failed, the message “A capturing error has occurred. Please try again.” is displayed.</p> <div data-bbox="759 767 1028 847">  </div> <div data-bbox="759 871 1028 1098">  </div> <div data-bbox="759 1121 1028 1193">  </div>

**SCREEN menu (continued)**

Item	Description
<b>MyScreen Lock</b>	Using the buttons ▲/▼ turns on/off the MyScreen lock function. TURN ON ⇔ TURN OFF When the TURN ON is selected, the item MyScreen cannot be performed. Use this function for protecting the current MyScreen.
<b>MESSAGE</b>	Using the buttons ▲/▼ turns on/off the message function. TURN ON ⇔ TURN OFF When the TURN ON is selected, the following message function works. "AUTO IN PROGRESS" while automatically adjusting "NO INPUT IS DETECTED" "SYNC IS OUT OF RANGE" "Searching ...." while searching for an input signal "Detecting...." when an input signal is detected The indication of the input signal by changing The indication of the aspect ration by changing

## OPTION menu

With the OPTION menu, items shown in the table below can be performed.

Choose an item using the cursor buttons ▲/▼ on the projector or remote control, and press the cursor button ► on the projector or remote control, or the ENTER button on the remote control to progress, except for the items LAMP TIME and FILTER TIME. Then perform it referring to the following table.

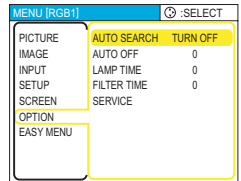

Item	Description
<b>AUTO SEARCH</b>	<p>Using the buttons ▲/▼ turns on/off the automatic signal search function.</p> <p>TURN ON ⇔ TURN OFF</p> <p>When the TURN ON is selected, detecting no signal automatically cycles through input ports in order of following. Then when an input is found, the projector will stop searching and display the image.</p> <p>RGB1 ⇒ RGB2 ⇒ S-VIDEO ⇒ VIDEO</p>
<b>AUTO OFF</b>	<p>Using the buttons ▲/▼ adjusts the time to count down to automatically turn the projector off.</p> <p>Long (max. 99 minutes) ⇔ Short (min. 0 minute = DISABLE)</p> <div style="display: flex; justify-content: space-around; align-items: center;"> <div style="border: 1px solid black; padding: 5px; text-align: center;">             ◀ AUTO OFF ENABLE ▲ 10 ▼         </div> <div style="border: 1px solid black; padding: 5px; text-align: center;">             ◀ AUTO OFF DISABLE ▲ 0 ▼         </div> </div> <p>When the time is set to 0, the projector is not turned off automatically.</p> <p>When the time is set to 1 to 99, and when the passed time with a no-signal or an unsuitable signal reaches at the set time, the projector lamp will go off and the power indicator begins blinking. Please refer to the section “Turning off the power” (18).</p>



**OPTION menu (continued)**

Item	Description
<p><b>LAMP TIME</b></p>	<p>The lamp time is the time counted after the last resetting. It is shown in the OPTION menu as the usage time of the lamp. Pressing the RESET button on the remote control or the button ► of the projector displays a dialog. To reset the lamp time, select the RESET using the button ▲.</p> <p>RESET ⇄ CANCEL</p> <ul style="list-style-type: none"> <li>• Please reset the lamp time only when you have replaced the lamp, for a suitable indication about the lamp.</li> <li>• For the lamp replacement, see the section "Lamp" (42, 43).</li> </ul>
<p><b>FILTER TIME</b></p>	<p>The filter time is the time counted after the last resetting. It is shown in the OPTION menu as the usage time of the air filter. Pressing the RESET button on the remote control or the button ► of the projector displays a dialog. To reset the filter time, select the RESET using the button ▲.</p> <p>RESET ⇄ CANCEL</p> <ul style="list-style-type: none"> <li>• Please reset the filter time only when you have cleaned or replaced the air filter, for a suitable indication about the air filter.</li> <li>• For the air filter cleaning, see the section "Air filter" (44).</li> </ul>



## Maintenance

## Lamp

 **WARNING** HIGH VOLTAGE HIGH TEMPERATURE HIGH PRESSURE

► The projector uses a high-pressure mercury glass lamp. The lamp can break with a loud bang, or burn out, if jolted or scratched, handled while hot, or worn over time. Note that each lamp has a different lifetime, and some may burst or burn out soon after you start using them. In addition, when the bulb bursts, it is possible for shards of glass to fly into the lamp housing, and for gas containing mercury to escape from the projector's vent holes.

► **About disposal of a lamp** • This product contains a mercury lamp; do not put in trash. Dispose of in accord with environmental laws. For lamp recycling, go to [www.lamprecycle.org](http://www.lamprecycle.org). (in the US) For product disposal, contact your local government agency or [www.eiae.org](http://www.eiae.org) (in the US) or [www.epsc.ca](http://www.epsc.ca) (in Canada). For more information, call your dealer.



Disconnect the plug from the power outlet

- If the lamp should break (it will make a loud bang when it does), unplug the power cord from the outlet, and make sure to request a replacement lamp from your local dealer. Note that shards of glass could damage the projector's internals, or cause injury during handling, so please do not try to clean the projector or replace the lamp yourself.
- If the lamp should break (it will make a loud bang when it does), ventilate the room well, and make sure not to breathe the gas that comes out of the projector vents, or get it in your eyes or mouth.
- Before replacing the lamp, turn the projector off and unplug the power cord, then wait at least 45 minutes for the lamp to cool sufficiently. Handling the lamp while hot can cause burns, as well as damaging the lamp.



- Never unscrew except the appointed (marked by an arrow) screws.
- Do not open the lamp cover while the projector is suspended from above. This is dangerous, since if the lamp's bulb has broken, the shards will fall out when the cover is opened. In addition, working in high places is dangerous, so ask your local dealer to have the lamp replaced even if the bulb is not broken.
- Do not use the projector with the lamp cover removed. At the lamp replacing, make sure that the screws are screwed in firmly. Loose screws could result in damage or injury.



- Use only the lamp of the specified type.
- If the lamp breaks soon after the first time it is used, it is possible that there are electrical problems elsewhere besides the lamp. If this happens, contact your local dealer or a service representative.
- Handle with care: jolting or scratching could cause the lamp bulb to burst during use.
- If the indicators or a message prompts you to replace the lamp (see the section "Related Messages" and "Regarding the indicator Lamps"), replace the lamp as soon as possible. Using the lamp for long periods of time, or past the replacement date, could cause it to burst. Do not use old (used) lamps; this is a cause of breakage.

**Lamp (continued)**

A lamp has a finite product life. Using the lamp for long periods of time could cause the pictures darker or the color tone poor. Note that each lamp has a different lifetime, and some may burst or burn out soon after you start using them. Preparation of a new lamp and early replacement are recommended.

To prepare a new lamp, contact your dealer and tell the lamp type number.

**Type number = DT00701.**

1. Turn the projector off, and unplug the power cord. Allow the lamp to cool for at least 45 minutes.
2. Prepare a new lamp.
  - If the projector is mounted on the ceiling, or if the lamp has broken, also ask the dealer to replace the lamp.

**In the case of replacement by yourself,**

3. After making sure that the projector has cooled adequately, slowly turn over the projector, so that the bottom is facing up.
4. Please loosen the screw (marked by arrow). Then, unhook the claws of the lamp cover and remove the lamp cover.
5. Loosen the 2 screws (marked by arrow) of the lamp, and slowly pick up the lamp by the handles.
6. Insert the new lamp, and retighten firmly two screws that are loosened in the previous process to lock it in place.
7. Interlocking the 2 tabs of the lamp cover to the projector, position the lamp cover on the projector, and push the center point of two claws to fix the lamp cover. Then retighten firmly the screw of the lamp cover.
8. Slowly turn the projector so that the top is facing up.
9. Turn the projector on and reset the lamp time using the LAMP TIME function in the OPTION menu (40).
  - (1) Press the MENU button to display a menu. Only when the EASY MENU has appeared, please perform the next step (2).
  - (2) Point at the "Go To Advance Menu ..." in the menu using ▼/▲ button, then press the ► button.
  - (3) Point at the "OPTION" in the left column of the menu using ▼/▲ button, then press the ► button.
  - (4) Point at the "LAMP TIME" using ▼/▲ button, then press the ► button. A dialog will appear.
  - (5) Press the ▲ button to select "RESET" on the dialog. It performs resetting the lamp time.

Claws of lamp cover

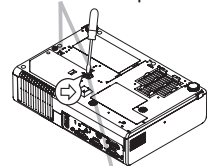

Screw marked by arrow

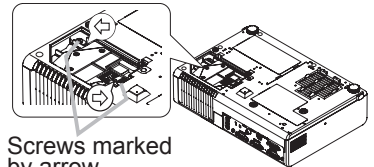

Screws marked by arrow

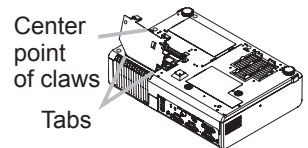
Center point of claws  
Tabs

**NOTE** • Please reset the lamp time only when you have replaced the lamp, for a suitable indication about the lamp.

## Air filter

**⚠ WARNING** ▶ Before caring, make sure the power switch is off and the power cable is not plugged in, then allow the projector to cool sufficiently. The care in a high temperature state of the projector could cause an electric shock, a burn and/or malfunction to the projector.

▶ Use only the air filter of the specified type. Do not use the projector with the air filter and the filter cover removed. It could result in a fire and/or malfunction to the projector.

▶ The air filter should be cleaned periodically. If the air filter becomes clogged by dust or the like, internal temperatures rise and could cause a fire, a burn and/or malfunction to the projector.

**NOTE** • Please replace the air filter when it is damaged or too soiled, and also when you replace the lamp.

• Please reset the filter time only when you have cleaned or replaced the air filter, for a suitable indication about the air filter. (40)

• The projector may display the message such as “CHECK THE AIR FLOW” or turn off the projector, to prevent the internal heat level rising.

If the air filter becomes clogged by dust or the like, internal temperatures rise and could cause a fire, a burn and/or malfunction to the projector. When the indicators or a message prompts you to clean the air filter, clean the air filter as soon as possible.

Please check and clean the air filter periodically, even if there is no message. Please replace the air filter when it is damaged or too soiled. Preparation of a new air filter is recommended. To prepare a new air filter, contact your dealer and tell the air filter type number.

### Type number = NJ20922

And also when you replace the lamp, please replace the air filter. An air filter of specified type will come together with a replacement lamp for this projector.

1. Turn the projector off, and unplug the power cord. Allow the lamp to cool for at least 45 minutes.
2. Disconnect all the connectors and adapters that were connected to the projector's ports. Then slowly turn the projector so that the lens-side is facing up. Please be careful for a projector not to fall. While the projector is placed lens-side up, hold the projector.
3. Remove the filter cover and the air filter. Hold the knobs while pulling out it.

Usual filter cover

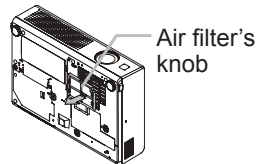
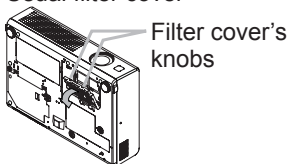

Filter cover for bottom-up use

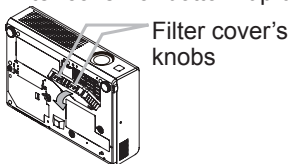

4. Apply a vacuum cleaner to the vent of the projector for the air filter. And then slowly turn the projector bottom up.

**Air filter (continued)**

5. Apply a vacuum cleaner to the air filter and filter cover. Then set a new or cleaned air filter into place.

In case of the filter cover for bottom-up use, remove the air filter from the filter cover and clean each. After cleaning, reattach the cleaned filter to the filter cover.

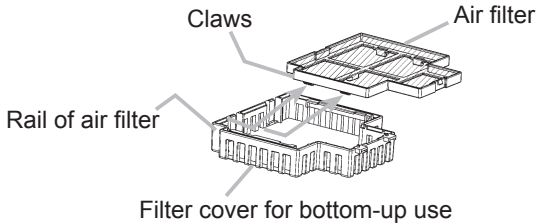

Please replace the air filter when it is damaged or too soiled.

6. Position the air filter and filter cover into place.

Usual filter cover

Push the points of "PUSH" word with claws to fix the air filter.

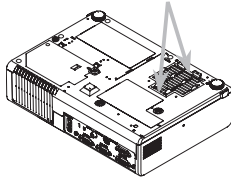

Interlocking the tabs, snap the filter cover into place.

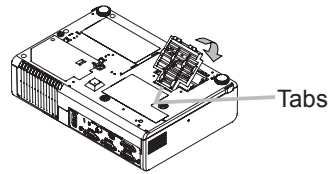

Filter cover for bottom-up use

Interlocking the tabs, snap the filter cover into place.

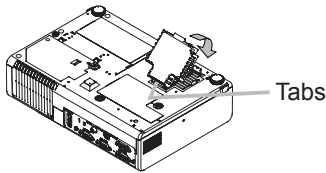

7. Slowly turn the projector so that the top is facing up, except for the case of bottom-up use.
8. Turn the projector on and reset the filter time using the FILTER TIME function in the OPTION menu (40).
- (1) Press the MENU button to display a menu. When the EASY MENU has appeared, please skip the next step (2).
  - (2) Point at the "OPTION" in the left column of the menu using ▼/▲ button, then press the ► button.
  - (3) Point at the "FILTER TIME" using ▼/▲ button, then press the ► button. A dialog will appear.
  - (4) Press the ▲ button to select "RESET" on the dialog. It performs resetting the filter time.

## Other care

**⚠ WARNING** ▶ Do not take care of the projector during use or immediately after use. Handling while the projector is in a high temperature could cause a burn and/or malfunction to the projector. Before operating, make sure that the power switch is off, that the power cord is not plugged in, and that the projector is cool adequately.

▶ Never try to care for the inside of the projector personally. Doing is so dangerous.

▶ Avoid wetting the projector or inserting liquids in the projector. It could result in a fire, an electric shock, and/or malfunction to the projector.

- Don't put a container containing water, cleaner or chemicals near the projector.

- Don't use aerosols or sprays.

**⚠ CAUTION** ▶ Please take right care of the projector according to the following. Incorrect care could cause not only an injury but adverse influence such as discoloration, peeling paint, etc.

- Do not use cleaner or chemicals other than those listed below.

- Do not polish or wipe with hard objects.

### Inside of the projector

In order to ensure the safe use of your projector, please have it cleaned and inspected by your dealer about once every year.

### Caring for the lens

If the lens is flawed, soiled or fogged, it could cause deterioration of display quality. Please take care of the lens, being cautious of the handling.

1. Turn the projector off, and unplug the power cord. Allow the projector to cool sufficiently.
2. After making sure that the projector is cool adequately, lightly wipe the lens with a commercially available lens-cleaning wipe. Do not touch the lens directly with your hand.

### Caring for the cabinet and remote control

Incorrect care could have adverse influence such as discoloration, peeling paint, etc.

1. Turn the projector off, and unplug the power cord. Allow the projector to cool sufficiently.
2. After making sure that the projector is cool adequately, lightly wipe with gauze or a soft cloth.

If soiling is severe, dip soft cloth in water or a neutral cleaner dilute in water, and wipe lightly after wringing well. Then, wipe lightly with a soft, dry cloth.

## Troubleshooting

### Related messages

When the unit's power is on, messages such as those shown below may be displayed. When any such message is displayed on the screen, please respond as described below. If the same message is displayed after the treatment, or if a message other than the following appears, please contact your dealer or service company.

Although these messages will be automatically disappeared around several minutes, it will be reappeared every time the power is turned on.

Message	Description
<p style="text-align: center;"><b>NO INPUT IS DETECTED</b> ON ***</p>	<p><b>There is no input signal.</b> Please confirm the signal input connection, and the status of the signal source.</p>
<p style="text-align: center;"><b>SYNC IS OUT OF RANGE</b> ON *** [fH] *****kHz [fV] *****Hz</p>	<p><b>The horizontal or vertical frequency of the input signal is not within the specified range.</b> Please confirm the specs for your projector or the signal source specs.</p>
<p style="text-align: center;"><b>CHECK THE AIR FLOW</b></p>	<p><b>The internal portion temperature is rising.</b> Please turn the power OFF, and allow the unit to cool down at least 20 minutes. After having confirmed the following items, please turn the power ON again.</p> <ul style="list-style-type: none"> <li>• Is there blockage of the air passage aperture?</li> <li>• Is the air filter dirty?</li> <li>• Does the peripheral temperature exceed 35°C?</li> <li>• If the same indication is displayed after the treatment, please set the HIGH at the FAN SPEED of the item SERVICE of the OPTION menu.</li> </ul>
<p style="text-align: center;"><b>REMINDER</b> *** HRS PASSED AFTER THE LAST FILTER CHECK. FILTER MAINTENANCE IS ESSENTIAL TO REMOVE WARNING MESSAGE, RESET FILTER TIMER. SEE MANUAL FURTHER INFO.</p>	<p><b>A note of precaution when cleaning the air filter.</b> Please immediately turn the power OFF, and clean or change the air filter by referring to the “Air Filter” section of this manual. After you have cleaned or changed the air filter, please be sure to reset the filter timer ( 40).</p>



## Regarding the indicator lamps

Lighting and flashing of the POWER indicator, the LAMP indicator, and the TEMP indicator have the meanings as described in the table below. Please respond in accordance with the instructions within the table. If the same indication is displayed after the treatment, or if an indication other than the following is displayed, please contact your dealer or service company.

POWER indicator	LAMP indicator	TEMP indicator	Description
Lighting In <b>Orange</b>	Turned <b>off</b>	Turned <b>off</b>	<b>The projector is in a standby state.</b> Please refer to the section "Power On/Off". (P17)
<i>Blinking</i> In <b>Green</b>	Turned <b>off</b>	Turned <b>off</b>	<b>The projector is warming up.</b> Please wait.
Lighting In <b>Green</b>	Turned <b>off</b>	Turned <b>off</b>	<b>The projector is in an on state.</b> Ordinary operations may be performed.
<i>Blinking</i> In <b>Orange</b>	Turned <b>off</b>	Turned <b>off</b>	<b>The projector is cooling down.</b> Please wait.
<i>Blinking</i> In <b>Red</b>	(discretionary)	(discretionary)	<b>The projector is cooling down. A certain error has been detected.</b> Please wait until the POWER indicator finishes blink, and then perform the proper response measure using the item descriptions below as reference.
<i>Blinking</i> In <b>Red</b> or Lighting In <b>Red</b>	Lighting In <b>Red</b>	Turned <b>off</b>	<b>The lamp does not light, and there is a possibility that interior portion has become heated.</b> Please turn the power off, and allow the unit to cool down at least 20 minutes. After the projector has sufficiently cooled down, please make confirmation of the following items, and then turn the power on again. <ul style="list-style-type: none"> <li>• Is there blockage of the air passage aperture?</li> <li>• Is the air filter dirty?</li> <li>• Does the peripheral temperature exceed 35°C?</li> </ul> If the same indication is displayed after the treatment, please change the lamp by referring to the section "Lamp". (P42)
<i>Blinking</i> In <b>Red</b> or Lighting In <b>Red</b>	<i>Blinking</i> In <b>Red</b>	Turned <b>off</b>	<b>The lamp cover has not been properly fixed (attached).</b> Please turn the power off, and allow the unit to cool down at least 45 minutes. After the projector has sufficiently cooled down, please make confirmation of the attachment state of the lamp cover. After performing any needed maintenance, turn the power on again. If the same indication is displayed after the treatment, please contact your dealer or service company.

**Regarding the indicator lamps (continued)**

POWER indicator	LAMP indicator	TEMP indicator	Description
<i>Blinking In Red or Lighting In Red</i>	Turned off	<i>Blinking In Red</i>	<p><b>The cooling fan is not operating.</b> Please turn the power off, and allow the unit to cool down at least 20 minutes. After the projector has sufficiently cooled down, please make confirmation that no foreign matter has become caught in the fan, etc. and then turn the power on again. If the same indication is displayed after the treatment, please contact your dealer or service company.</p>
<i>Blinking In Red or Lighting In Red</i>	Turned off	Lighting In Red	<p><b>There is a possibility that the interior portion has become heated.</b> Please turn the power off, and allow the unit to cool down at least 20 minutes. After the projector has sufficiently cooled down, please make confirmation of the following items, and then turn the power on again.</p> <ul style="list-style-type: none"> <li>• Is there blockage of the air passage aperture?</li> <li>• Is the air filter dirty?</li> <li>• Does the peripheral temperature exceed 35°C?</li> </ul> <p>If the same indication is displayed after the treatment, please set the HIGH at the FAN SPEED of the item SERVICE of the OPTION menu. (M41)</p>
Lighting In Green	Alternative <i>blinking in Red</i>		<p><b>There is a possibility that the interior portion has become overcooled.</b> Please use the unit within the usage temperature parameters (5°C to 35°C). After the treatment, resent the power to ON.</p>
Lighting In Green	Simultaneous <i>blinking in Red</i>		<p><b>It is time to clean the air filter.</b> Please immediately turn the power OFF, and clean or change the air filter by referring to the section “Air Filter”. After cleaning or changed the air filter, please be sure to reset the filter timer. After the treatment, resent the power to ON.</p>

**NOTE** • When the interior portion has become overheated, for safety purposes, the power source is automatically turned off, and the indicator lamps may also be turned off. In such a case, press the “O” (OFF) side of the power switch, and wait at least 45 minutes. After the projector has sufficiently cooled down, please make confirmation of the attachment state of the lamp and lamp cover, and then turn the power on again.

## Phenomena that may easily be mistaken for machine defects

**⚠ WARNING** ▶ Never use the projector if abnormal operations such as smoke, strange odor, excessive sound, damaged casing or elements or cables, penetration of liquids or foreign matter, etc. should occur. In such cases, immediately turn off the power switch and then disconnect the power plug from the power outlet. After making sure that the smoke or odor has stopped, contact your dealer or service company.

1. Before requesting repair, please check in accordance with the following chart. This operation sometimes resolves your problem.

If the situation cannot be corrected,

2. The projector's microprocessor may need to be reset. Please push the restart switch by using a pin or similar.
3. Some setting may be wrong. Please use the **FACTORY RESET** function of **SERVICE** menu in the **OPTION** menu (📖41) to reset all settings to factory default.

Then, if the problem is not removed after maintenance, please contact your dealer or service company.

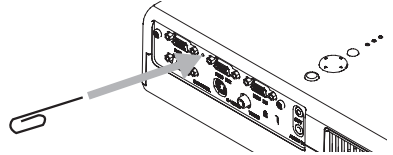

Phenomenon	Cases not involving a machine defect	Reference page 📖
Power does not come on.	<b>The electrical power cord is not plugged in.</b> Correctly connect the power cord.	16
	<b>The power switch is not set to the on position.</b> Set the power switch to [   ] (On).	17
	<b>The main power source has been interrupted during operation such as by a power outage (blackout), etc.</b> Please turn the power off, and allow the unit to cool down at least 20 minutes. After the projector has sufficiently cooled down, please turn the power on again.	17, 18
	<b>Either there is no lamp and/or lamp cover, or either of these has not been properly fixed.</b> Please turn the power off, and allow the unit to cool down at least 45 minutes. After the projector has sufficiently cooled down, please make confirmation of the attachment state of the lamp and lamp cover, and then turn the power on again.	42, 43

**Phenomena that may easily be mistaken for machine defects (continued)**

Phenomenon	Cases not involving a machine defect	Reference page 
No pictures are displayed.	<b>The lens cover is closed.</b> Remove the lens cover.	4, 17
	<b>The signal cables are not correctly connected.</b> Correctly connect the connection cables.	13, 14
	<b>The brightness is adjusted to an extremely low level.</b> Adjust the BRIGHT to a higher level using the menu function or the remote control.	26, 28
	<b>The computer cannot detect the projector as a plug and play monitor.</b> Make sure that the computer's can detect a plug and play monitor using other plug and play monitor.	13
Colors have a faded- out appearance, or Color tone is poor.	<b>Color settings are not correctly adjusted.</b> Perform picture adjustments by changing the COLOR TEMP, COLOR, TINT and/or COLOR SPACE settings, using the menu functions.	26, 29 33
	<b>COLOR SPACE setting is not suitable.</b> Change the COLOR SPACE setting to AUTO, RGB, SMPTE240 , REC709 or REC601.	33
Pictures appear dark.	<b>The brightness and/or contrast are adjusted to an extremely low level.</b> Adjust the BRIGHT and/or CONTRAST settings to a higher level using the menu function.	26, 28
	<b>The WHISPER function is working.</b> Select the NORMAL to the item WHISPER in the SETUP menu.	27, 35
	<b>The lamp is approaching the end of its product lifetime.</b> Replace the lamp.	42, 43, 45
Pictures appear blurry.	<b>Either the focus and/or horizontal phase settings are not properly.</b> Adjust the focus using the focus ring, and/or H PHASE using the menu function.	20, 31
	<b>The lens is dirty or misty.</b> Clean the lens by referring to the section "Caring for the lens".	46

**NOTE** • Although bright spots or dark spots may appear on the screen, this is a unique characteristic of liquid crystal displays, and such do not constitute or imply a machine defect.

## Warranty and after-service

If a problem occurs with the equipment, first refer to the “Troubleshooting” (47) and run through the suggested checks. If this does not resolve the problem, please contact your dealer or the service company. They will tell you what warranty condition is applied.

## Specifications

**NOTE** • This specifications are subject to change without notice.

Item		Specification
Product name		Liquid crystal projector
Liquid Crystal panel	Panel size	CP-RS56 : 1.4 cm (0.55 type) CP-RX61 : 1.5 cm (0.6 type)
	Drive system	TFT active matrix
	Pixels	CP-RS56 : 480,000 pixels (800 horizontal x 600 vertical) CP-RX61 : 786,432 pixels (1,024 horizontal x 768 vertical)
Lens		F=1.60 ~ 1.88 f=18.6 ~ 22.3 mm
Lamp		165W UHB
Power Supply		AC100-120V/2.7A, AC220-240V/1.5A
Power Consumption		240W
Temperature range		5 ~ 35°C (Operating)
Size		285 (W) x 73 (H) x 202 (D) mm (Not including protruding parts) • Please refer to the following figure.
Weight (mass)		2.3 kg
Ports		<b>RGB input:</b> RGB .....D-sub 15pin mini x 2 <b>RGB Output:</b> RGB OUT ... D-sub 15pin mini x 1 <b>Communication port:</b> CONTROL ..... D-sub 9pin x 1 <b>Video input:</b> VIDEO ..... RCA x 1 S-VIDEO ..... S-Video x 1 <b>Audio input:</b> AUDIO IN .....Stereo mini x 1 <b>Audio Output:</b> AUDIO OUT ....Stereo mini x 1
Optional parts	Lamp	DT00701
	Air filter	NJ20922
	Others	• Please consult your dealer.

