

myprojectorlamps.com

**The most trusted, dependable name
in projector lamp sales.**



<http://www.myprojectorlamps.com>



<http://www.myprojectorlamps.ca>



<http://www.myprojectorlamps.eu>

The following projector manual has not been modified or altered in any way.

HITACHI

Inspire the Next

LCD REAR PROJECTION TELEVISION

Operating Guide for 50VG825, 55VG825, 60VG825

IMPORTANT SAFETY INSTRUCTIONS.....	2-3
FIRST TIME USE	4-20
THE REMOTE CONTROL.....	21-38
ON-SCREEN DISPLAY	39-88
LAMP REPLACEMENT	88-91
USEFUL INFORMATION.....	92-97
LICENSE AGREEMENT.....	98
APPENDIXES	99-100
INDEX.....	101



As an Energy Star® Partner, Hitachi, Ltd. has determined that this product meets the Energy Star® guidelines for energy efficiency.



ULTRAVISION

Important Safety Instructions



SAFETY POINTS YOU SHOULD KNOW ABOUT YOUR HITACHI LCD REAR PROJECTION TELEVISION

Our reputation has been built on the quality, performance, and ease of service of **HITACHI** televisions.

Safety is also foremost in our minds in the design of these units. To help you operate these products properly, this section illustrates safety tips which will be of benefit to you. Please read it carefully and apply the knowledge you obtain from it to the proper operation of your **HITACHI** television.

Please fill out your warranty card and mail it to **HITACHI**. This will enable **HITACHI** to notify you promptly in the improbable event that a safety problem should be discovered in your product model.

Follow all warnings and instructions marked on this television.



 The lightning flash with arrowhead symbol, within an equilateral triangle, is intended to alert the user to the presence of uninsulated "dangerous voltage" within the product's enclosure that may be of a sufficient magnitude to constitute a risk of electric shock to a person.

 The exclamation point within an equilateral triangle, is intended to alert the user to the presence of important operating and maintenance (servicing) instructions in the literature accompanying the appliance.

READ BEFORE OPERATING EQUIPMENT

Follow all warnings and instructions marked on this television.

1. Read these instructions.
2. Keep these instructions.
3. Heed all warnings.
4. Follow all instructions.
5. Do not use this apparatus near water.
6. Clean only with a dry cloth.
7. Do not block any ventilation openings. Install in accordance with the manufacturer's instructions.
8. Do not install near any heat sources such as radiators, heat registers, stoves, or other apparatus (including amplifiers) that produce heat.
9. Do not defeat the safety purpose of the polarized or grounding-type plug. A polarized plug has two blades with one wider than the other. A grounding

type plug has two blades and a third grounding prong. The wide blade or the third prong are provided for your safety. If the provided plug does not fit into your outlet, consult an electrician for replacement of the obsolete outlet.

10. Protect the power cord from being walked on or pinched particularly at plugs, convenience receptacles, and the point where they exit from the apparatus.
11. Only use the attachments/accessories specified by the manufacturer.
12.  Use only with the cart, stand, tripod, bracket, or table specified by the manufacturer, or sold with the apparatus. When a cart is used, use caution when moving the cart/apparatus combination to avoid injury from tip-over.
13. Unplug this apparatus during lightning storms or when unused for long periods of time.
14. Refer all servicing to qualified service personnel. Servicing is required when the apparatus has been damaged in any way, such as power-supply cord or plug is damaged, liquid has been spilled or objects have fallen into apparatus, the apparatus has been exposed to rain or moisture, does not operate normally, or has been dropped.
15. Televisions are designed to comply with the recommended safety standards for tilt and stability. Do not apply excessive pulling force to the front, or top, of the cabinet which could cause the product to overturn resulting in product damage and/or personal injury.
16. Follow instructions for wall, shelf or ceiling mounting as recommended by the manufacturer.
17. An outdoor antenna should not be located in the vicinity of overhead power lines or other electrical circuits.
18. If an outside antenna is connected to the receiver be sure the antenna system is grounded so as to provide some protection against voltage surges and built up static charges. Section 810 of the National Electric Code, ANSI/NFPA No. 70-1984, provides information with respect to proper grounding for the mast and supporting structure, grounding of the lead-in wire to an antenna discharge unit, size of grounding connectors, location of antenna-discharge unit, connection to grounding electrodes and requirements for the grounding electrode.

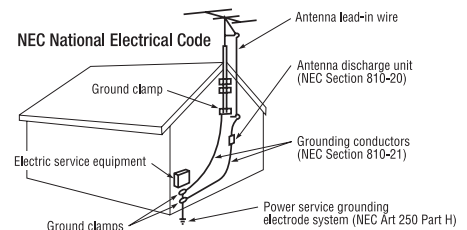

Note to the CATV system installer: This reminder is provided to call the CATV system installer's attention to Article 820-44 of the NEC that provides guidelines for proper grounding and, in particular, specifies that the cable ground shall be connected to the grounding system of the building, as close to the point of cable entry as practical.

Important Safety Instructions



Power source

This television is designed to operate on 120 volts 60 Hz, AC current. Insert the power cord into a 120 volt 60 Hz outlet.

To prevent electric shock, do not use the television's (polarized) plug with an extension cord, receptacle, or other outlet unless the blades and ground terminal can be fully inserted to prevent blade exposure.

Never connect the television to 50 Hz, direct current, or anything other than the specified voltage.

Caution



Never remove the back cover of the television as this can expose you to very high voltages and other hazards. If the television does not operate properly, unplug the television and call your authorized dealer or service center.

Caution

Adjust only those controls that are covered in the instructions, as improper changes or modifications not expressly approved by **HITACHI** could void the user's warranty.

Warning

- To reduce the risk of fire or electric shock, do not expose this apparatus to rain or moisture.
- The television should not be exposed to dripping or splashing and objects filled with liquids, such as vases, should not be placed on the television.



Warning

- Do not place any objects on the top of the television which may fall or cause a child to climb to retrieve the objects.

Modifications

The FCC requires the user to be notified that any changes or modifications made to this device that are not expressly approved by Hitachi America, Ltd. Home Electronics Division may void the user's authority to operate the equipment.

Note

This television receiver will display television closed captioning, ( or ), in accordance with paragraph 15.119 and 15.122 of the FCC rules.

Public viewing of copyrighted material

Public viewing of programs broadcast by TV stations and cable companies, as well as programs from other sources, may require prior authorization from the broadcaster or owner of the video program material.

This product incorporates copyright protection technology that is protected by U.S. patents and other intellectual property rights. Use of this copyright protection technology must be authorized by Macrovision Corporation, and is intended for home and other limited consumer uses only unless otherwise authorized by Macrovision. Reverse engineering or disassembly is prohibited.

Note

This digital television is capable of receiving analog basic, digital basic and digital premium cable television programming by direct connection to a cable system providing such programming. A CableCARD provided by your cable operator is required to view encrypted digital programming. Certain advanced and interactive digital cable services such as video-on-demand, a cable operator's enhanced program guide and data-enhanced television services may require the use of a set-top box. For more information call your local cable company.

Note

- There are no user serviceable parts inside the television.
- Model and serial numbers are indicated on back side of the television.

Lead Notice

This product contains lead and a lamp that contains mercury. Dispose of this product and its lamp in accordance with applicable environmental laws. For lamp recycling and disposal information, go to www.lamprecycle.org. For product recycling and disposal information contact your local government agency or www.eRecycle.org (in California), the Electronic Industries Alliance at www.eiae.org (in the US) or the Electronic Product Stewardship Canada at www.epsc.ca (in Canada).

FOR MORE INFORMATION, CALL 1-800-HITACHI.

Accessories

Check to make sure you have the following accessories before disposing of the packing material.

① Remote Control

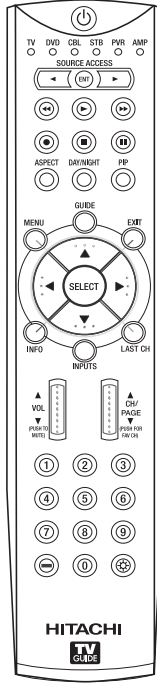

② Two "AA" size, 1.5V batteries

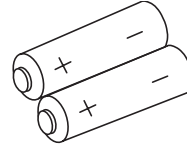

③ IR Mouse Cable

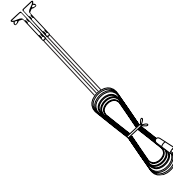

For U.S. models:

For optional accessories, please access our web site at:
www.hitachi.us/tv

- ① Remote Control Unit CLU-3851WL (Part No. HL02065).
- ② Two "AA" size, 1.5V batteries (P# FQ00021).
- ③ Two IR Mouse cables (P# EY01641).

REMOTE CONTROL BATTERY INSTALLATION AND REPLACEMENT

1. Open the battery cover of the remote control by pushing down and sliding the back cover off.
2. Insert two new "AA" size batteries for the remote control. When replacing old batteries, push them towards the springs and lift them out.
3. Match the batteries to the (+) and (-) marks in the battery compartment.
4. Replace the cover.

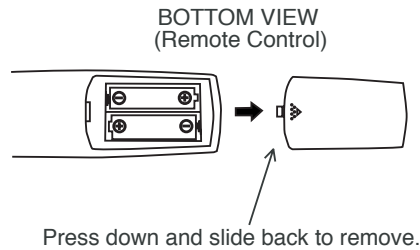

CAUTION: Do not insert batteries with the '+' and '-' polarities reversed as this may cause the batteries to swell or rupture resulting in leakage.

How to set up your new HITACHI Projection Television

ANTENNA

Unless your LCD Rear PTV is connected to a cable TV system or to a centralized antenna system, a good outdoor TV antenna is recommended for best performance. However, if you are located in an exceptionally good signal area that is free from interference and multiple image ghosts, an indoor antenna may be sufficient.

LOCATION

Select an area where sunlight or bright indoor illumination will not fall directly on the picture screen. Also, be sure that the location selected allows a free flow of air to and from the perforated back cover of the set. To avoid cabinet warping, cabinet color changes, and increased chance of set failure, do not place the TV where temperatures can become excessively hot, for example, in direct sunlight or near a heating appliance, etc. When using your LCD Rear PTV against a wall, keep it at least 10cm (4 inches) from the wall.

NOTE: Your new HDTV has a built-in high definition television signal processor. This television includes a fan to cool the processor. The sound of moving air from the fan is normal and may be noticeable in very quiet environments.

VIEWING

The major benefit of the **HITACHI** LCD Rear PTV is its large viewing screen. To see this large screen at its best, test various locations in the room to find the optimum spot for viewing.

The best picture is seen by sitting directly in front of the TV and about 10 to 18 feet from the screen. Picture brightness decreases as the viewer moves to the left and right of the receiver.

During daylight hours, reflections from outside light may appear on the screen. If so, drapes or screens can be used to reduce the reflection or the TV can be located in a different section of the room.

If the TV's audio output will be connected to a Hi-Fi system's external speakers, the best audio performance will be obtained by placing the speakers equidistant from each side of the receiver cabinet and as close as possible to the height of the picture screen center. For best stereo separation, place the external speakers at least four feet from the side of the TV, place the surround speakers to the side or behind the viewing area. Differences in room sizes and acoustical environments will require some experimentation with speaker placement for best performance.

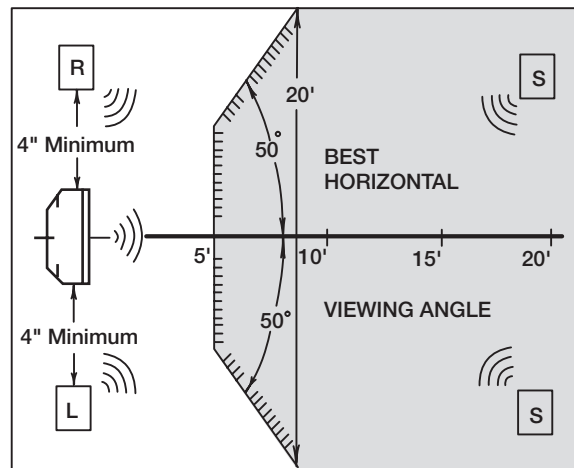
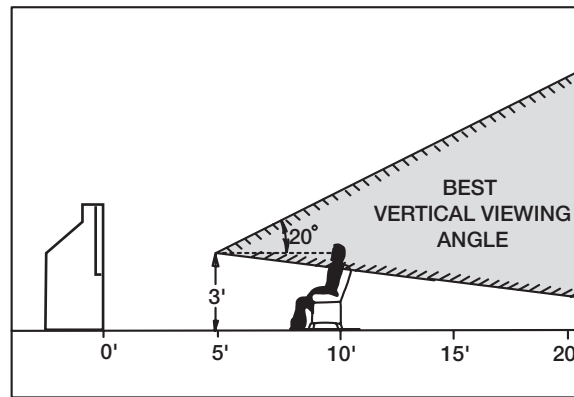

IMPORTANT NOTES:

1. Since LCD Rear PTV incorporates a high pressure lamp to display an image, it may take about one minute for the picture to become stable, after the power has been turned on. After extended use, the picture may darken, the color may look unusual, or the lamp "goes out," (burns out). You may hear a "pop" sound when the lamp "goes out." These are common characteristics of the lamp, and should not be considered defective.
2. LCD Rear PTV incorporates an advanced cooling fan system to prevent from overheating. If you hear the cooling fan, it should not be considered defective.
3. If you hear a "cracking" sound from the TV cabinet, it is due to the TV's cabinet expanding and contracting due to room temperature changes. It has no effect on the TV's functions.
4. The LCD Rear PTV cabinet is constructed with all plastic. Make sure to place it on a flat surface. An uneven surface might warp the cabinet and reduce the picture quality.

Hook-up Cables and Connectors

Most video/audio connections between components can be made with shielded video and audio cables that have phono connectors. For best performance, video cables should use 75-Ohm coaxial shielded wire. Cables can be purchased from most stores that sell audio/video products. Below are illustrations and names of common connectors. Before purchasing any cables, be sure of the output and input connector types required by the various components and the length of each cable.

300-Ohm Twin Lead Connector

This outdoor antenna cable must be connected to an antenna adapter (300-Ohm to 75-Ohm).

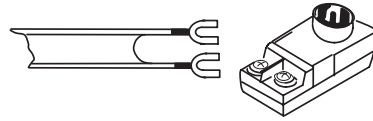

Phono Connector

Used on all standard video and audio cables which connect to inputs and outputs located on the television's rear jack panel and side control panel.



"F" Type 75-Ohm Coaxial Antenna Connector

For connecting RF signals (antenna or cable TV) to the antenna jack on the television.



S-Video (Super Video) Connector

This connector is used on camcorders, VCRs and laser-disc players with an S-Video feature in place of the standard video cable to produce a high quality picture.



Optical Cable

This cable is used to connect to an audio amplifier with an Optical Audio In jack. Use this cable for the best sound quality.

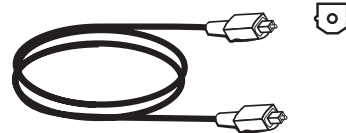

IR Mouse Cable/G-LINK Cable (Provided)

Connect the IR Mouse to the IR Blaster output of your LCD Television when A/V Network is used. You must place the IR Mouse in front of the corresponding IR window of your cable box and VCR. This connection allows your TV, and the TV Guide On Screen™ system, to control your cable box and/or VCR.

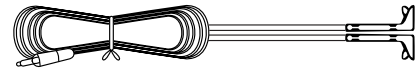

USB Cable

This cable is used to connect your digital camera to the Photo Input in the side of the LCD television.



HDMI Cable

This cable is used to connect your external devices such as Set-Top-Boxes or DVD players equipped with an HDMI output connection to the TV's HDMI input.

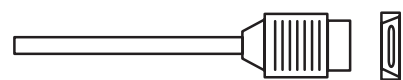

ANTENNA CONNECTIONS TO REAR JACK PANEL

VHF (75-Ohm) antenna/CATV (Cable TV)

When using a 75-Ohm coaxial cable system, connect **CATV** coaxial cable to the **CABLE** (75-Ohm) terminal. If you have an antenna, connect the coaxial cable to the **AIR** terminal.

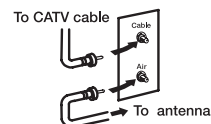

VHF (300-Ohm) antenna/UHF antenna

When using a 300-Ohm twin lead from an outdoor antenna, connect the **VHF** or **UHF** antenna leads to screws of the **VHF** or **UHF** adapter. Plug the adapter into the antenna terminal on the TV.

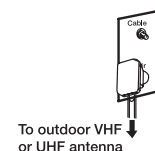

When both VHF and UHF antennas are connected

Attach an optional antenna cable mixer to the TV antenna terminal, and connect the cables to the antenna mixer. Consult your dealer or service store for the antenna mixer.

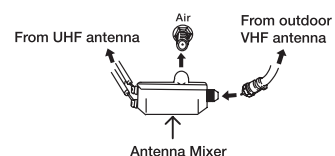

Quick Reference Remote Control Buttons and Functions

In addition to controlling all of the functions on your HITACHI LCD Rear Projection TV, the new remote control is designed to operate different types of devices, such as, DVD Players, CBL (Cable Boxes), set-top-boxes, satellite receivers, and VCRs. The remote control must be programmed to control the chosen device. Please see pages 21-38 for a complete description of all features and programming of the Remote Control.

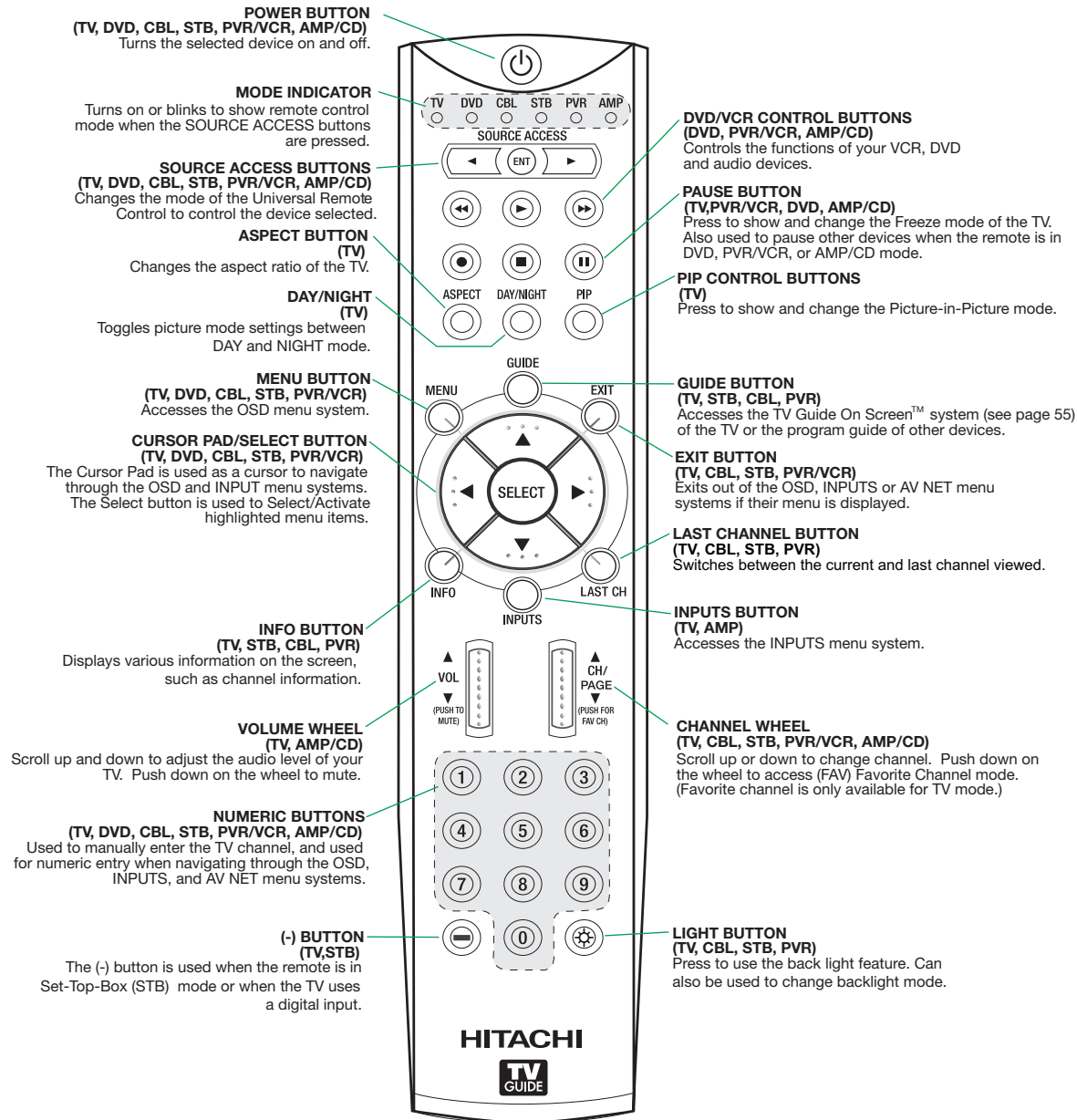

LEGEND

TV – Television
CBL – Cable Box
STB – Set-Top-Box
VCR – Video Cassette Recorder/Player
DVD – Digital Video Disc Player
SAT – Satellite Receiver

- NOTES:**
1. The TV's remote control sensor is located on the right bottom portion of the TV screen. To control TV functions, please point the remote control directly at the remote control sensor for best results.
 2. VCR precode is included in the PVR mode.
 3. CD precode is included in the AMP mode.
 4. Pressing any button will illuminate the backlight for 4 seconds.

Front Panel Controls

First time use

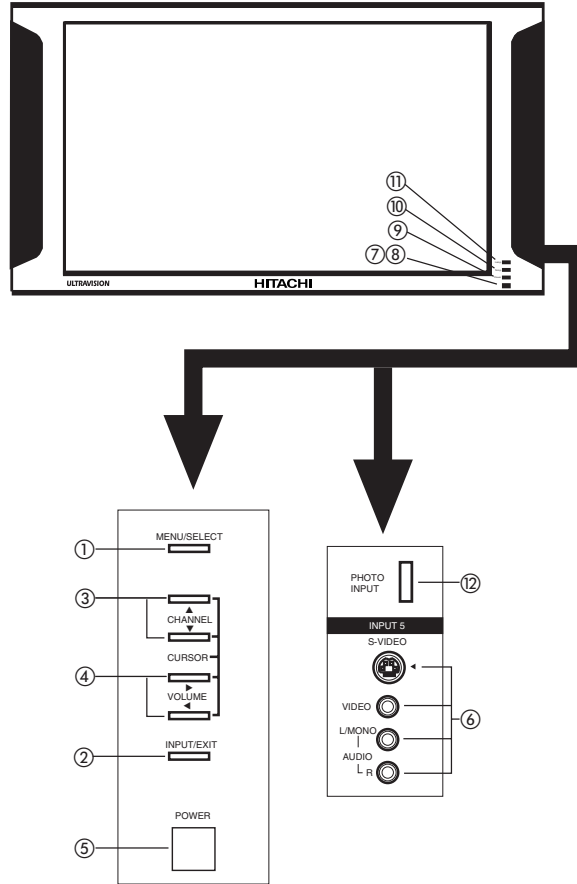

1 MENU/SELECT button

This button allows you to enter the **MENU**, making it possible to set TV features to your preference without using the remote. This button also serves as the **SELECT** button when in **MENU** mode.

2 INPUT/EXIT button

Press this button to display the input menu, **CABLE, AIR, INPUT: 1, 2, 3, 4** and **5**. This button also serves as the **EXIT** button when in **MENU** mode.

3 CHANNEL selector

Press these buttons until the desired channel appears in the top right corner of the TV screen. These buttons also serve as the cursor down (**▼**) and up (**▲**) buttons when in **MENU** mode.

4 VOLUME level

Press these buttons for your desired sound level. The volume level will be displayed on the TV screen. These buttons also serve as the cursor left (**◀**) and right (**▶**) buttons when in **MENU** mode. When the TV power is turned OFF at a volume level 31 or greater, the volume level will default to 30 when the TV is turned ON. However, if it is set to a level 30 or less, the volume level will be at the level it was set when the TV is turned ON.

5 POWER button

Press this button to turn the TV on or off.

6 SIDE INPUT JACKS (INPUT 5)

Use these audio/video jacks for a quick hook-up from a camcorder or VCR to instantly view your favorite show or new recording. Press the **INPUT** button and select **INPUT 5**. If you have mono sound, insert the audio cable into the left audio jack.

7 LEARNING AV NET Sensor

Point your equipment's remote control at this area while using the AV NET Learning Wizard.

8 IR RECEIVER Sensor

Point the remote control at this area when selecting channels, adjusting volume, etc.

Front Panel Controls

9 POWER Light

This light is on during normal operation. Light Blinking Slowly (2 seconds): television lamp is cooling down. It takes 12-15 seconds to warm up and about 2 minutes to cool down.

10 TEMP Indicator

This light is off during normal operation. If this indicator is lit, the optic unit is too hot. If this indicator is blinking, the cooling fan has stopped. Please call service. The optic unit has an air filter that may become clogged over time. The internal temperature will increase which will trigger the temperature sensor to display an On-Screen warning. After 5 minutes, the lamp will turn off, then the TV will turn off with the TEMP LED On.

11 LAMP Indicator

This light is off during normal operation. If light is lit, the lamp has failed. See page 89-92 for lamp replacement procedure. Consult your Hitachi dealer for proper part. If light is blinking, lamp cover is not assembled securely after replacement.

NOTES:

INDICATOR	INDICATION	MEANING	ACTION
LAMP LED	LIGHT ON	NO LAMP LIGHT or BROKEN LAMP	Need to replace if LAMP still does not light by Power On " again. Check assembly condition of LAMP UNIT
	BLINKING	WRONG LAMP UNIT ASSEMBLY / LAMP DOOR OPEN	
TEMP LED	LIGHT ON	Too hot inside the OPTIC unit	Call for Service
	BLINKING	COOLING FAN STOPPED	
POWER LED	INTERMEDIATE BLINKING (0.5 SEC CYCLE)	BEGINNING OF WARM UP AFTER THE POWER ON.	
	LIGHT ON	NORMAL OPERATION	
	SHORT BLINKING (0.3 SEC CYCLE)	BEGINNING OF COOL DOWN (FOR 20 SEC.) (TV CANNOT ACCEPT ANY CODE IN THIS PERIOD EXCEPT WITHIN THE BEGINNING 5 SEC.)	
	LONG BLINKING (1 SEC CYCLE)	COOL DOWN (FOR 6 MINUTES) (TV CAN ACCEPT REMOTE CONTROL AND SIDE BUTTONS)	

2. If the LAMP, TEMP, and POWER LED are blinking in the order below, the television is warming up.



3. Your Hitachi LCD Rear Projection Television may appear to be OFF when it is set to input 1 ~ input 5 and the video signal is not received from the input jacks. Please make sure the Blue Power light indicator is not lit (OFF) when you are not watching for long lasting performance.

4. Your Hitachi LCD Rear Projection Television has an internal lamp that lights up the TV screen. Make sure to turn off the Power when you do not watch the LCD Rear Projection Television for longer lamp life

12 PHOTO INPUT

Insert USB cable from your digital camera, USB memory or memory card USB drive to view your digital still pictures (see page 25).

Side Panel Jacks and Connections

The side panel jacks are provided as a convenience to allow you to easily connect a camcorder or VCR as shown in the following examples:

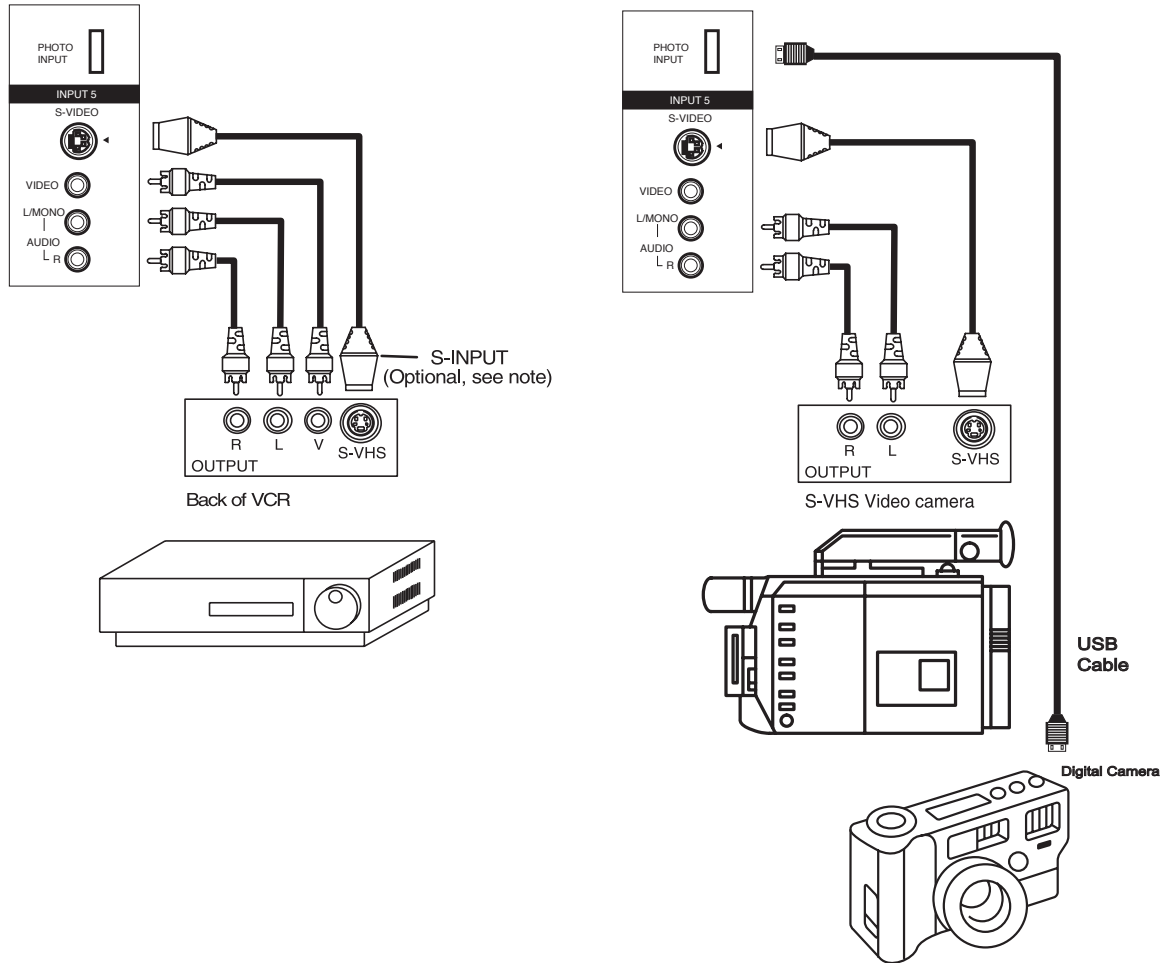

- NOTE:**
1. Completely insert connection cord plugs when connecting to side panel jacks. If you do not, the played back picture may be abnormal.
 2. If you have a S-VHS VCR, use the S-INPUT cable in place of the standard video cable.
 3. If you have a mono VCR, insert the audio cable into the left audio jack of your TV.

Rear Panel Connections

1 Antenna Input

CABLE – CATV (Cable TV) input.
AIR – RF antenna input.

NOTE: You may ask your local cable company whether DTV services are available.

2 Audio/Video Inputs 1, 2, 3 and 4

By using the **INPUTS** button, **CURSOR** buttons and **SELECT** button of the remote control you can select each video source. Use the audio and video inputs to connect external devices, such as VCRs, camcorders, laserdisc players, DVD players etc. (If you have mono sound, insert the audio cable into the left audio jack.)

NOTE: You may use **VIDEO** or **S-VIDEO** inputs to connect to **INPUT 1** and **2**, but only one of these inputs may be used at a time.

3 Monitor Out

These jacks provide fixed or variable audio and video signals which are used for recording. Use the S-Video Output for high quality video output (see page 86).

4 S-Video Inputs 1 and 2

INPUTS 1 and **2** provide S-Video (Super Video) jacks for connecting equipment with S-Video output capability.

5 Component: Y-PbPr Inputs

INPUTS 3 and **4** provide Y-PbPr jacks for connecting equipment with this capability, such as a DVD player or Set Top Box. You may use composite video signal for both inputs.

- NOTE:**
1. Do not connect composite **VIDEO** and **S-VIDEO** to **INPUT 1, 2** or **5** at the same time. **S-VIDEO** has priority over **VIDEO** input.
 2. Your component outputs may be labeled **Y, B-Y, and R-Y**. In this case, connect the components **B-Y** output to the TV's **Pb** input and the components **R-Y** output to the TV's **Pr** input.
 3. Your component outputs may be labeled **Y-CbCr**. In this case, connect the component **Cb** output to the TV's **Pb** input and the component **Cr** output to the TV's **Pr** input.
 4. It may be necessary to adjust **TINT** to obtain optimum picture quality when using the **Y-PbPr** inputs (see page 41).
 5. To ensure no copyright infringement, the **MONITOR OUT** output will be abnormal, when using the **Y-PbPr** jacks.
 6. **INPUT 3** and **INPUT 4 (Y/VIDEO)** can be used for composite video and component video input.

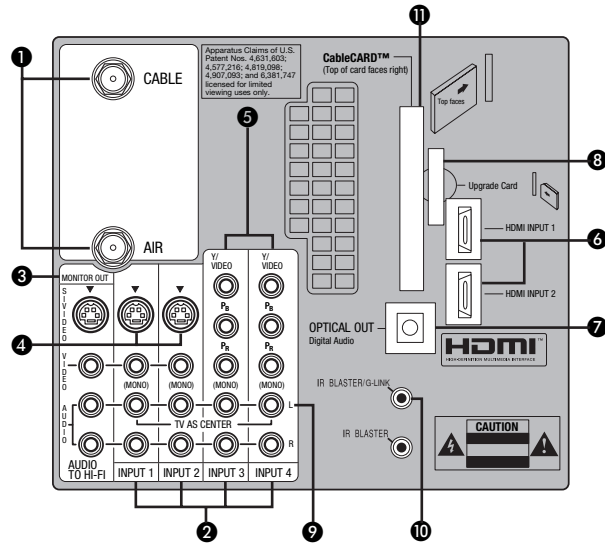

6 HDMI (High Definition Multimedia Interface) (INPUTS 1 and 2)

ABOUT HDMI – HDMI is the **HDMI** HIGH-DEFINITION MULTIMEDIA INTERFACE next-generation all digital interface for consumer electronics. **HDMI** enables the secure distribution of high-definition video and multi-channel audio in a single cable. Because digital television (DTV) signals remain in digital format, **HDMI** assures that pristine high-definition images retain the highest video quality from the source all the way to your television screen.

Use the **HDMI** input for your external devices such as Set-Top-Boxes or DVD players equipped with an **HDMI** output connection.

HDMI, the **HDMI** logo and High-Definition Multimedia Interface are trademarks or registered trademarks of **HDMI** Licensing LLC.

- NOTE:**
1. The **HDMI** input is not intended for use with personal computers.
 2. Only DTV formats such as **1080i, 720p, 480i** and **480p** are available for **HDMI** INPUTS.

7 Optical Out (Digital Audio)

This jack provides Digital Audio Output for your audio device that is Dolby® Digital and PCM compatible, such as an audio amplifier.

Manufactured under license from Dolby Laboratories. “**DOLBY**” and the **DOUBLE-D** symbol are trademarks of Dolby Laboratories.

8 Upgrade Card

This card slot is for future software upgrades. Hitachi will notify you if a software upgrade is required for your TV. In order to receive written notification, please complete and return your warranty card.

Rear Panel Connections

First time use

9 TV AS CENTER (INPUTS 1-4)

These jacks are for stereo amplifiers with center signal output capability. This feature allows the TV speakers to be used as a center speaker. The TV must be set as a center channel by selecting **TV AS CENTER** on the Internal Speakers Settings of the Audio Menu (see page 45).

10 IR Blaster/G-LINK

This jack provides IR output to your external components (VCR, Cable box, DVD player, etc.). With this connection, your external components can automatically be controlled by the A/V network feature. This connection will allow you to control the external components with your LCD Television's remote control in TV mode. The G-LINK connection will enable the TV Guide On Screen™ recording feature.

11 CableCARD Slot

This slot is for the CableCARD that will be provided by your local cable operator to gain access to chosen cable channels. The CableCARD will allow you to tune digital and high definition cable channels. Please call your local cable operator if this service is available before requesting a CableCARD (also known as Point of Deployment (POD) module).

IMPORTANT: Please read the "Lamp Power Control" feature on page 75 before installing the CableCARD.

1. Connect a coaxial cable to cable terminal of the Rear Panel Jacks.
2. Insert the CableCARD into the slot (Top of card should be facing right as shown below).

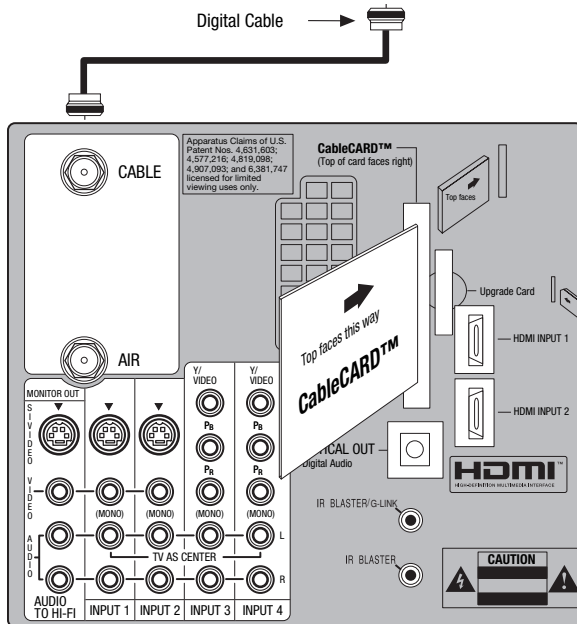

NOTE: 1. A digital cable subscription is required.
2. Do not insert a PCMCIA card into the CableCARD slot.

If the CableCARD is properly installed or not installed, the TV will display the following respective screens.

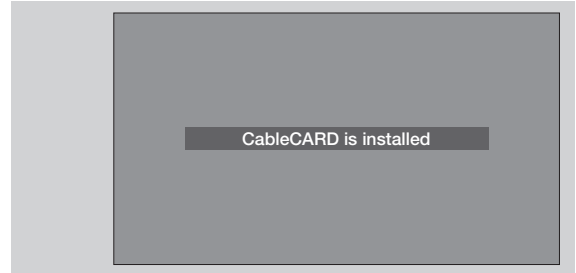

OR



After the CableCARD is installed, wait until the second screen below appears. The third screen below will appear if a channel is not authorized for viewing. Press the **EXIT** button to exit the second screen.

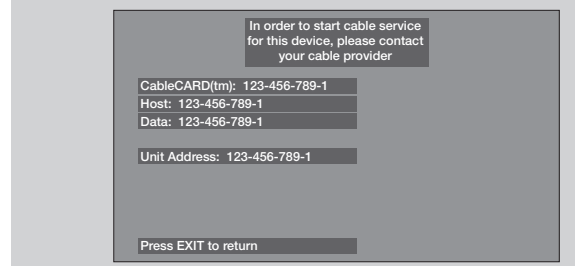

OR



Please take note of all information on the screen (you will provide this information to your cable operator). Call your cable operator and give them the information from the card to start your cable service.

NOTE: Please see Appendix E on page 100 for additional CableCARD information.

Rear Panel Connections

TIPS ON REAR PANEL CONNECTIONS

- **S-VIDEO, Y-PbPr** and **HDMI** connections are provided for high performance laserdisc players, VCRs etc. that have this feature. Use these connections in place of the standard video connection if your device has this feature.
- If your device has only one audio output (mono sound), connect it to the left audio jack on the television.
- Refer to the operating guide of your other electronic equipment for additional information on connecting your hook-up cables.
- A single VCR can be used for VCR #1 and VCR #2, but note that a VCR cannot record its own video or line output (**INPUT 1** in the example on this page). Refer to your VCR operating guide for more information on line input-output connections.
- You may use **VIDEO** or **S-VIDEO** inputs to connect to **INPUT 1**, **INPUT 2** or **INPUT 5**, but only one of these may be used at a time.
- Connect only one component (VCR, DVD player, camcorder, etc.) to each input jack.
- **COMPONENT: Y-PbPr (INPUT 3 and INPUT 4)** connections are provided for high performance components, such as DVD players and set-top-boxes. Use these connections in place of the standard video connection if your device has this feature. **INPUT 3 and INPUT 4** accepts both composite and component video signals.
- Your component outputs may be labeled **Y, B-Y**, and **R-Y**. In this case, connect the components **B-Y** output to the TV's **Pb** input and the components **R-Y** output to the TV's **Pr** input.
- Your component outputs may be labeled **Y-CbCr**. In this case, connect the components **Cb** output to the TV's **Pb** input and the components **Cr** output to the TV's **Pr** input.
- You may use composite and component video signals for **INPUT 3** and **INPUT 4**.
- It may be necessary to adjust **TINT** to obtain optimum picture quality when using the **Y-PbPr** inputs (see page 41).

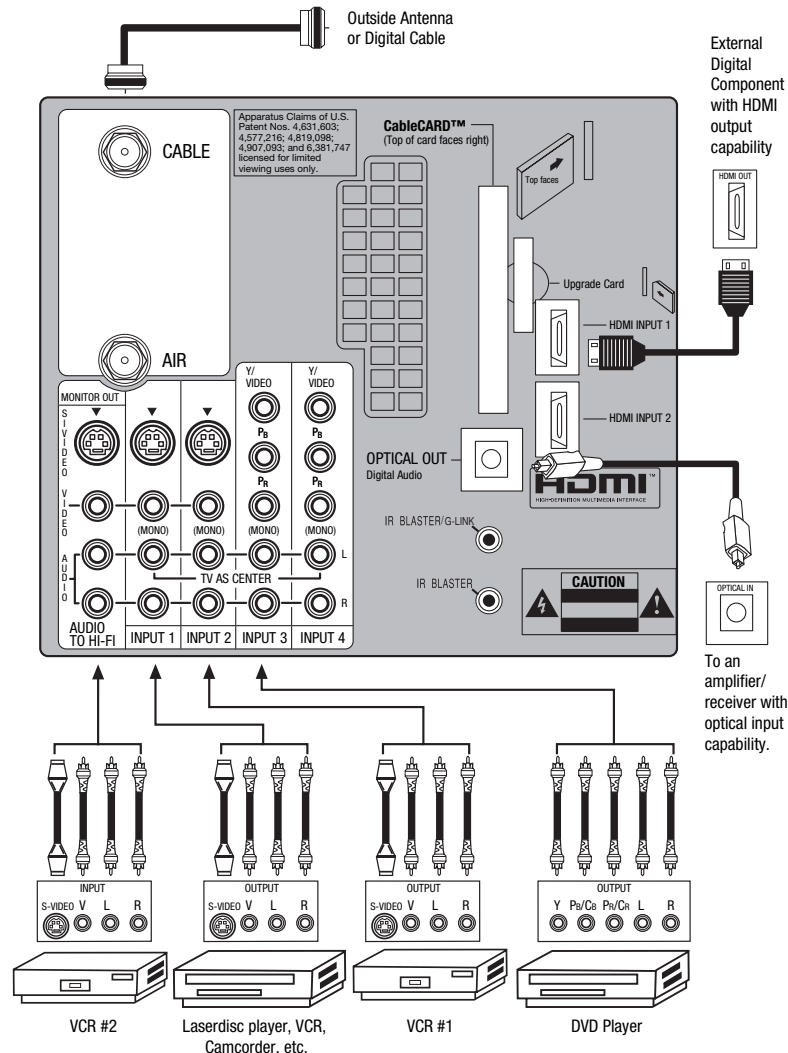

- To ensure no copyright infringement, the **MONITOR OUT** output may be abnormal, when using the **Y-PbPr** jacks.
- When using an **HDMI** input from a Set-Top-Box, it is recommended that a **1080i** or **720p** input signal is used.

- NOTE:**
1. Connect only one component to each input jack.
 2. Follow connections that pertain to your personal entertainment system.
 3. **INPUT 3 and INPUT 4** can accommodate Composite and Component video signals.
 4. Cables are not included with the purchase of this TV, except when noted as "provided".

- MACROVISION NOTES:**
1. Video signals fed through a VCR may be affected by copyright protection systems and the picture will be distorted on the television.
 2. Connecting the television directly to the Audio /Video output of a Set-Top-Box will assure a more normal picture.

First time use

Connecting External Audio Sources

First time use

Match the numbers below to the diagram for speaker placement.

- ❶ The television's internal speakers will act as center speaker (select **AUDIO - INTERNAL SPEAKERS - TV AS CENTER**).
- ❷ These FRONT left and right speakers are connected to the FRONT output of a separate audio amplifier.
- ❸ These REAR left and right speakers are connected to the Rear output of a separate audio amplifier.
- ❹ This subwoofer is connected to the LFE/SUB Out output of a separate audio amplifier.

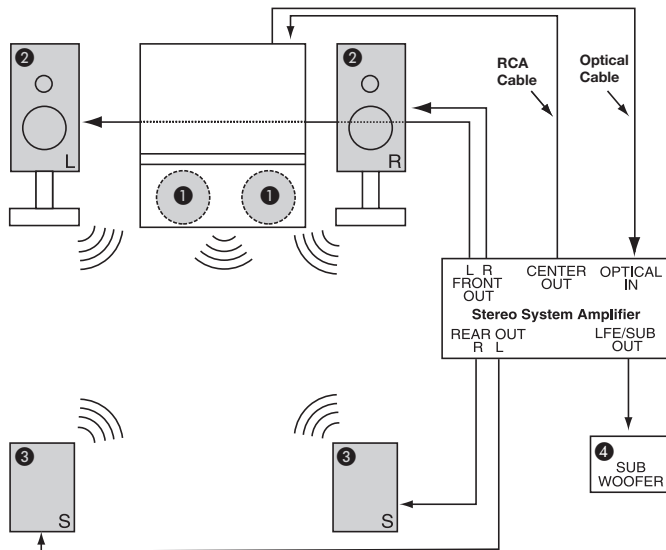
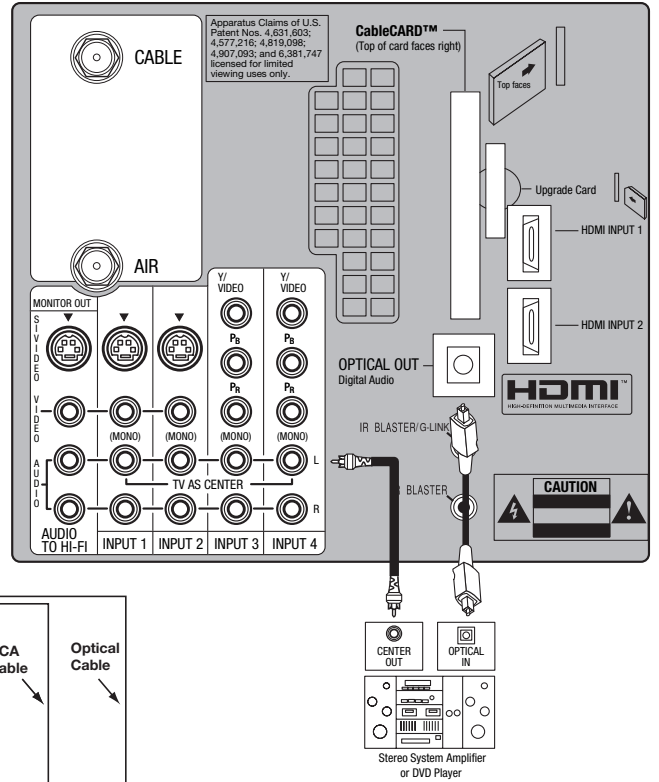

NOTE: 1. The Optical Out (Digital Audio) provides a fixed digital audio output to your external component such as an A/V receiver with optical input capability. The audio level can only be controlled through the volume control of the external audio amplifier.
 2. See page 46 for AUDIO-Digital Output.

Connecting External Video Sources

The exact arrangement you use to connect the VCR, camcorder, laserdisc player, DVD player, or HDTV Set Top Box to your TV set is dependent on the model and features of each component. Check the owner's manual of each component for the location of video and audio inputs and outputs.

The following connection diagrams are offered as suggestions. However, you may need to modify them to accommodate your particular assortment of components and features. For best performance, video and audio cables should be made from coaxial shielded wire.

BEFORE OPERATING EXTERNAL VIDEO SOURCE

Connect an external source to the INPUT terminal, then press the **INPUTS** button to show the **INPUTS** menu. Use the **CURSOR PAD** to select the **CABLE**, **AIR** or **INPUT** of your choice. Then press the **SELECT** button to confirm your choice (see page 24).

NOTE: When the TV is set to **VIDEO** and a video signal is not received from the **VIDEO INPUT JACK** on the back panel of the TV (i.e., VCR/laserdisc player, etc. is not connected or the video device is **OFF**), the set will appear to be **OFF**.

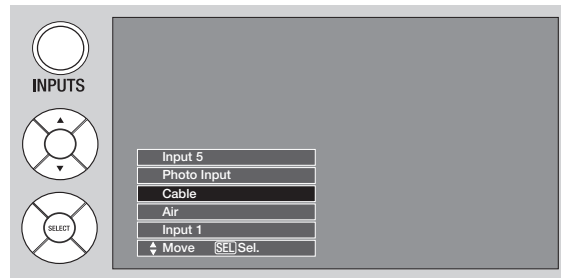

CONNECTING A COMPOSITE VIDEO AND MONAURAL AUDIO SOURCE TO INPUT 1 - INPUT5

1. Connect the cable from the VIDEO OUT of the VCR or the laserdisc player to the INPUT (VIDEO) jack, as shown on the TV set on the right.
2. Connect the cable from the AUDIO OUT of the VCR or the laserdisc player to the INPUT (MONO)/L(AUDIO) jack.
3. Press the **INPUTS** button, then select **INPUT 4** from the **INPUTS** menu to view the program from the VCR or the laserdisc player. The VIDEO OSD label disappears automatically after approximately four seconds.
4. Select **CABLE** from the **INPUTS** menu to return to the last channel tuned.

NOTE: The **INPUT 3** can be used in the same manner as **INPUT 4**.

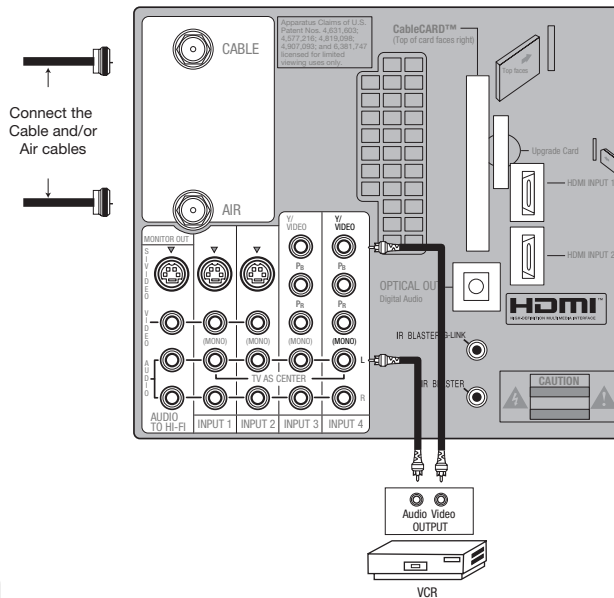

Connecting External Video Sources

First time use

CONNECTING A COMPOSITE VIDEO AND STEREO AUDIO SOURCE TO INPUT1 - INPUT5

1. Connect the cable from the VIDEO OUT of the VCR or the laserdisc player to the INPUT (VIDEO) jack, as shown on the TV set on the right.
2. Connect the cable from the AUDIO OUT R of the VCR or the laserdisc player to the INPUT (AUDIO/R) jack.
3. Connect the cable from the AUDIO OUT L of the VCR or the laserdisc player to the INPUT (AUDIO/L) jack.
4. Press the **INPUTS** button, then select **INPUT 2** from the **INPUTS** menu to view the program from the VCR or laserdisc player. The VIDEO OSD label disappears automatically after approximately four seconds.
5. Select **CABLE** from the **INPUTS** menu to return to the last channel tuned.

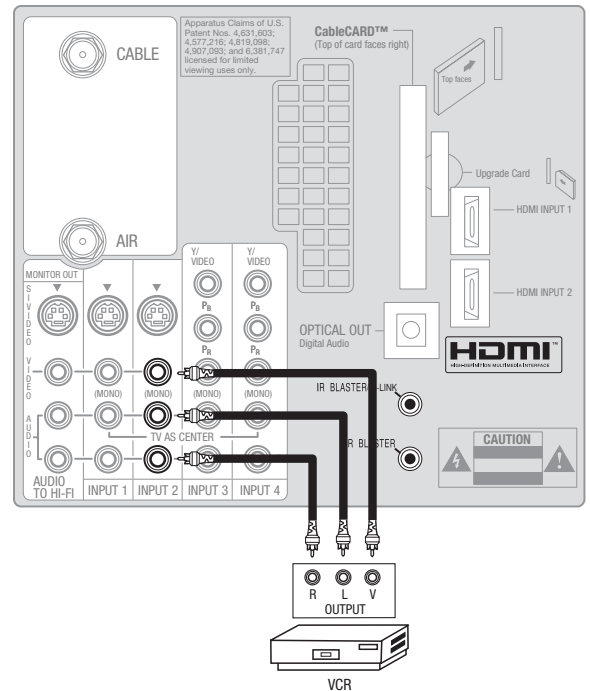

NOTE: 1. Completely insert the connection cord plugs when connecting to rear panel jacks. The picture and sound that is played back will be abnormal if the connection is loose.
 2. A single VCR can be used for VCR #1 and VCR #2 (see page 13), but note that a VCR cannot record its own video or line output. Refer to your VCR operating guide for more information on line input-output connections.
 3. When INPUT 3 or 4 are used, it's necessary to connect the video output from the device to the Y/Video input jack of the TV.

CONNECTING AN S-VIDEO SOURCE TO INPUT 1, 2 AND 5

1. Connect the cable from the S-VIDEO OUT of the VCR or the laserdisc player to the INPUT (S-VIDEO) jack, as shown on the TV set on the right.
2. Connect the cable from the AUDIO OUT R of the VCR or the laserdisc player to the INPUT (AUDIO/R) jack.
3. Connect the cable from the AUDIO OUT L of the VCR or the laserdisc player to the INPUT (AUDIO/L) jack.
4. Press the **INPUTS** button, then select **INPUT 2** from the **INPUTS** menu to view the program from the VCR or laserdisc player. The VIDEO OSD label disappears automatically after approximately four seconds.
5. Select **CABLE** from the **INPUTS** menu to return to the last channel tuned.

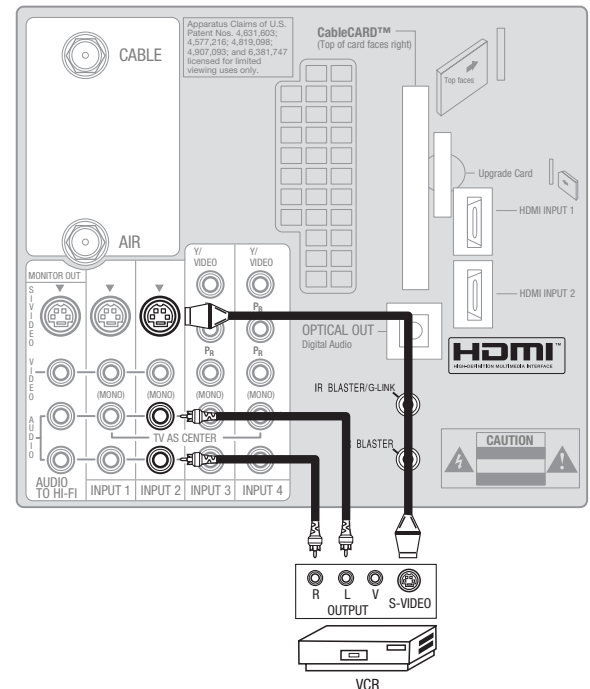

NOTE: 1. Completely insert the connection cord plugs when connecting to rear panel jacks. The picture and sound that is played back will be abnormal if the connection is loose.
 2. A single VCR can be used for VCR #1 and VCR #2 (see page 13), but note that a VCR cannot record its own video or line output. Refer to your VCR operating guide for more information on line input-output connections.

Connecting External Video Sources

CONNECTING A COMPONENT SOURCE WITH HDMI OR DVI CAPABILITY TO INPUT 1 OR INPUT 2

1. Connect the HDMI or DVI to HDMI connection cable from the output of the HDTV set top box or DVD player to the HDMI input as shown on the TV set on the right. When using a component with DVI output, you also have to connect the AUDIO OUT (R/L) of the component to the AUDIO IN (R/L) of INPUT 1 or INPUT 2.
2. Press the **INPUTS** button, then select **INPUT 1** or **INPUT 2** from the **INPUTS** menu to view the program from the HDTV set top box or DVD player. The VIDEO OSD label disappears automatically after approximately four seconds.
3. Select **CABLE** from the **INPUTS** menu to return to the last channel tuned.

- NOTE:**
1. Completely insert the connection cord plugs when connecting to rear panel jacks. The picture and sound that is played back will be abnormal if the connection is loose.
 2. The HDMI input on INPUT 1 or 2 contains the copy protection system called High-bandwidth Digital Content Protection (HDCP). HDCP is a cryptographic system that encrypts video signals when using HDMI connections to prevent illegal copying of video contents.
 3. HDMI is not a "NETWORK" technology. It establishes a one-way point-to-point connection for delivery of uncompressed video to a display.
 4. The connected digital output device controls the HDMI interface so proper set-up of device user settings determines final video appearance.

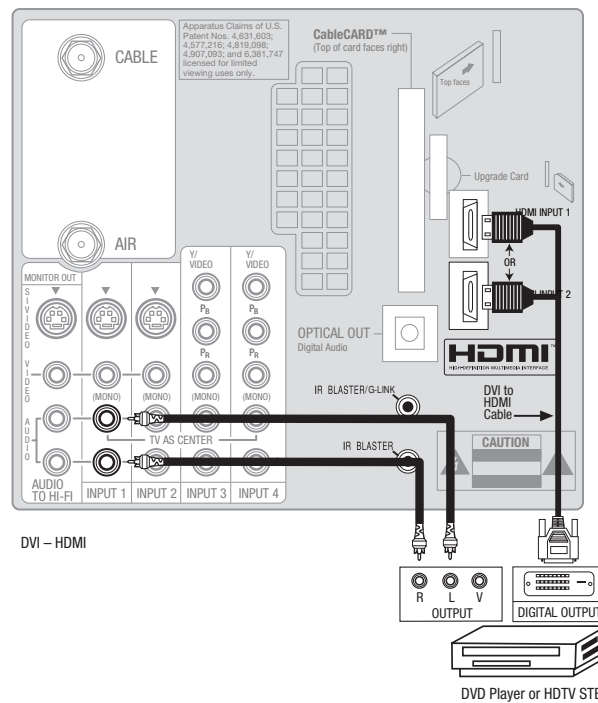
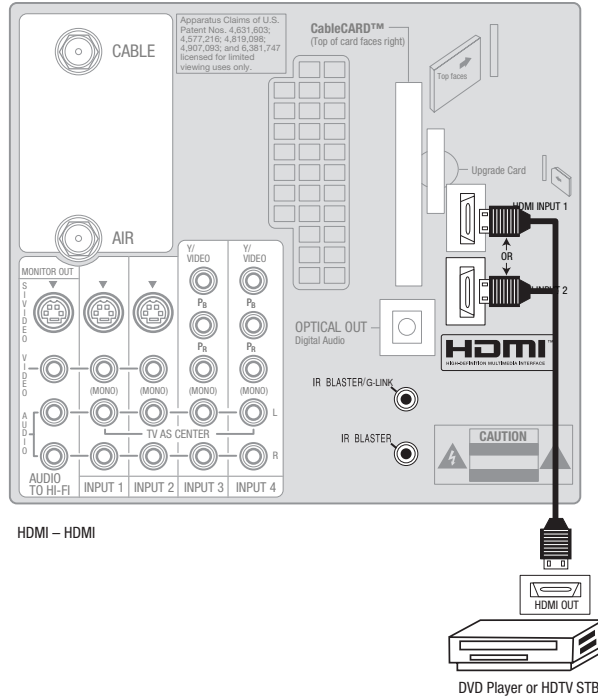

Connecting External Video Sources

CONNECTING A COMPONENT SOURCE TO INPUT 3 OR 4: Y-PbPr.

1. Connect the cable from the Y OUT of the Laserdisc/DVD player or HDTV set top box to the INPUT (Y) jack, as shown on the TV set on the right.
2. Connect the cable from the Cb/Pb OUT or B-Y OUT of the Laserdisc/DVD player or HDTV set top box to the INPUT (Pb) jack.
3. Connect the cable from the Cr/Pr OUT or R-Y OUT of the laserdisc/DVD player or HDTV set top box to the INPUT (Pr) jack.
4. Connect the cable from the AUDIO OUT R of the Laserdisc/DVD player or HDTV set top box to the INPUT (AUDIO/R) jack.
5. Connect the cable from the AUDIO OUT L of the Laserdisc/DVD player or HDTV set top box to the INPUT (AUDIO/L) jack.
6. Press the the **INPUTS** button, then select **INPUT 3** from the **INPUTS** menu to view the program from the Laserdisc/DVD player or HDTV set top box. The VIDEO OSD label disappears automatically after approximately four seconds.
7. Select **CABLE** from the **INPUTS** menu to return to the last channel tuned.

NOTE: 1. Completely insert the connection cord plugs when connecting to rear panel jacks. The picture and sound that is played back will be abnormal if the connection is loose.
2. See page 13 for tips on REAR PANEL CONNECTIONS.

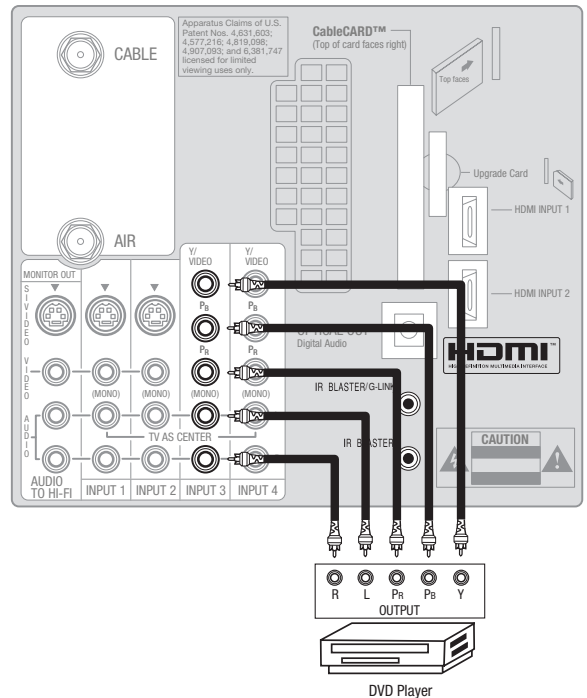

Connecting External Video Sources

Your HITACHI LCD Rear Projection Television is equipped with an AV Network feature. This feature helps to control your external Audio/Video equipment (VCR, Set Top Box, DVD, etc.). Once this is setup, it allows your IR Mouse connector to control your equipment using your HITACHI LCD Rear PTV Remote Control. You can use your HITACHI remote control to control the Audio/Video equipment command without the equipment's remote control.

The LCD Rear PTV Rear Panel has 2 IR BLASTER jacks. Each IR Mouse cable can connect up to 2 external Audio/Video components. Therefore, you can connect the LCD Rear PTV with up to four components. Please see the following example of an AV Network setup between your HITACHI LCD Rear PTV and external Audio/Video equipment (VCR and DVD Player).

CONNECTING EXTERNAL AUDIO/VIDEO COMPONENTS TO IR BLASTER FOR AV NETWORK

1. Connect your external Audio/Video components to the Rear Panel shown below.
2. Connect the IR Mouse cable to the IR BLASTER output of the Rear Panel.
3. Place the IR Mouse in front of the infrared sensor of the external components you wish to control.

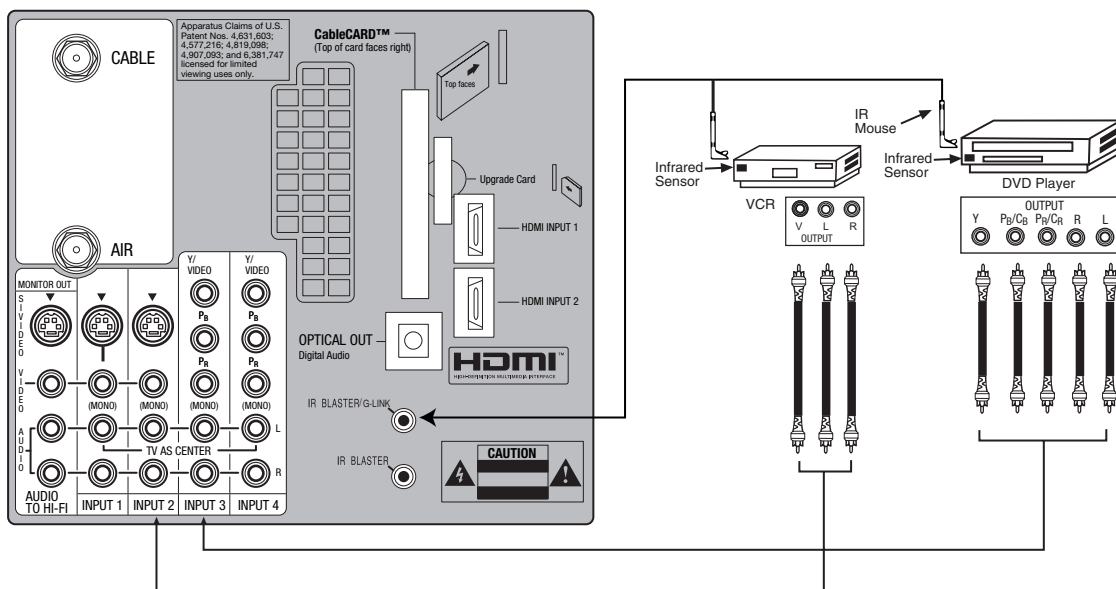

4. ACCESS THE AV NET SETUP WIZARD
Press the MENU button.
5. Use the CURSOR PAD ▼ or channel scroll down to highlight SETUP.
6. Press the SELECT or CURSOR PAD ► button to select.
7. Use the CURSOR PAD ▼ or channel scroll to highlight the SET AV NET features then press the SELECT button.
8. Follow the Setup procedure on pages 76-83.

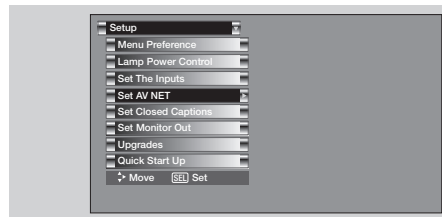

- NOTE:**
1. The Rear Panel has two IR BLASTER outputs which can control up to a total of four external components.
 2. The IR Mouse must be placed in front of the external components infrared sensor for the AV Network to work. Double-sided mounting tape may be used to hold the IR Mouse in place.
 3. The correct codes must be chosen for each of the Audio/Video components for the AV Network to function properly.

Connecting External Video Sources

Your HITACHI LCD Rear Projection Television is equipped with a G-LINK feature. This connection is necessary for the TV Guide On Screen™ system to work with your cable box to receive program listings and to enable VCR recording features. Once you setup the G-LINK (IR Mouse) connector, then you can use your HITACHI LCD Rear PTV Remote Control and the TV Guide On Screen system to control your cable box and VCR recording features.

The LCD Rear PTV Rear Panel has 2 IR BLASTER jacks. One IR Mouse cable can connect up to 2 external Audio/Video components. Please see the following example of a G-LINK setup between your HITACHI LCD Rear PTV and external Audio/Video equipment (VCR and Cable box).

CONNECTING THE CABLE BOX/VCR TO G-LINK FOR TV GUIDE ON SCREEN™ SYSTEM

1. Connect your external Audio/Video components to the Rear Panel shown below.
2. Connect the IR Mouse cable to the IR BLASTER/G-LINK output of the Rear Panel.
3. Place the IR Mouse in front of the infrared sensor of the external components you want to control.

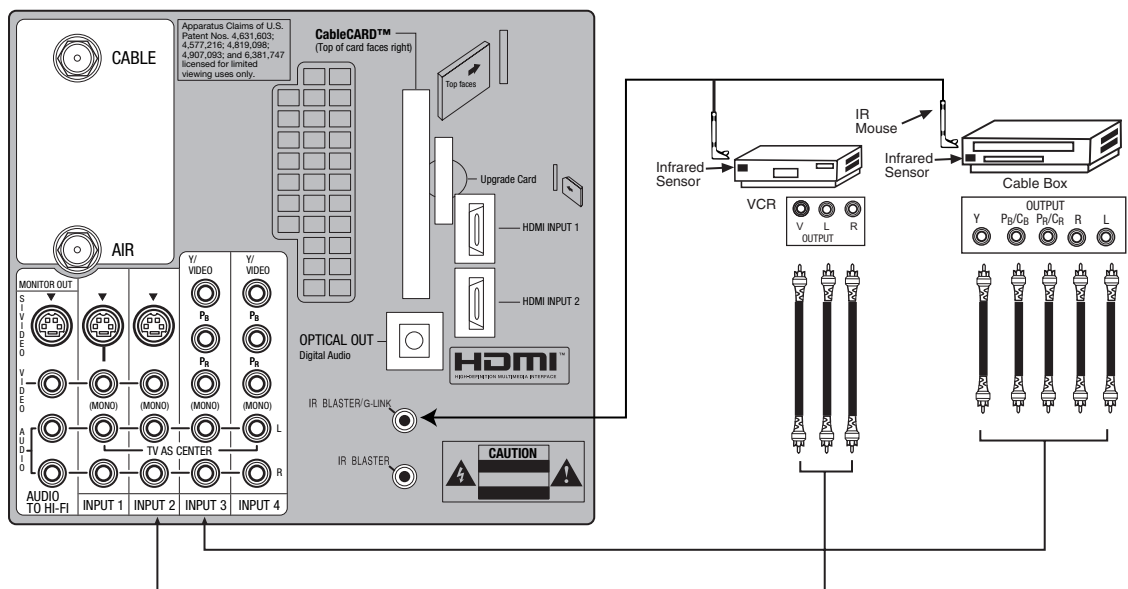

4. To access the TV Guide On-Screen™ system, press the MENU button.
5. Use the CURSOR PAD ▼ or channel scroll down to highlight TV GUIDE ON SCREEN.
6. Press the SELECT or CURSOR PAD ► button to select.
7. Follow the Setup procedure on pages 47-51.

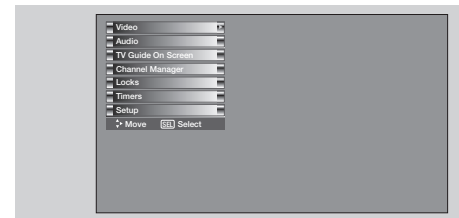

NOTE: The IR Mouse must be placed in front of the external components infrared sensor for the AV Network to work.

The Remote Control

In addition to controlling all the functions on your HITACHI LCD Rear Projection TV, the new remote control is designed to operate different types of VCRs, CATV (Cable TV) converters, set-top-box, satellite receiver, DVD players, and other audio/video equipment with one touch. Basic operation keys are grouped together in one area.

To operate your LCD Rear Projection TV, point the remote control at the remote sensor of the television and select the TV by pressing the ◀ or ▶ button of the Source Access on the remote. The TV mode indicator will blink, indicating that the remote will now control your television.

To operate your VCR, point the remote at the remote sensor of the VCR and select PVR by pressing the ◀ or ▶ button of the Source Access on the remote. The PVR mode indicator will blink, indicating that the remote will now control your VCR (see page 34 for instructions on how to program the remote to control your VCR).

To operate your PVR (Personal Video Recorder), point the remote at the remote sensor of the PVR and select PVR by pressing the ◀ or ▶ button of the Source Access on the remote. The PVR mode indicator will blink, indicating that the remote will now control your PVR (see page 34 for instruction on how to program the remote to control your PVR).

To operate your cable box, point the remote at the remote sensor of the cable box and select the CABLE (CBL) by pressing the ◀ or ▶ button of the Source Access on the remote. The CBL mode indicator will blink, indicating that the remote will now control your cable box (see page 31 for instructions on how to program the remote to control your cable box).

To operate your set-top-box or satellite receiver point the remote at the remote sensor of the set-top-box and select the SET-TOP-BOX (STB) by pressing the ◀ or ▶ button of the Source Access on the remote. If you have a satellite receiver, use this button to program your satellite receiver. The STB mode indicator will blink, indicating that the remote will now control your set-top-box (see page 32 for instructions on how to program the remote to control your set-top-box).

To operate your DVD player, point the remote at the remote sensor of the DVD player and select DVD by pressing the ◀ or ▶ button of the Source Access on the remote. The DVD mode indicator will blink, indicating that the remote will now control your DVD Player (see page 33 for instruction on how to program the remote to control your DVD player).

To operate additional audio equipment, point the remote at the remote sensor of the component you wish to control and select AMP by pressing the ◀ or ▶ button of the Source Access on the remote. The AMP mode indicator will blink, indicating that the remote will now control your audio equipment (see page 35 for instructions on how to program the remote to control additional Audio/Video equipment).

NOTE: When you press any remote control button, the buttons will light up. The illumination will light a few seconds during this time. The buttons will appear to light if the room is dark.

There are two modes of lighting the Remote Control buttons. They are the Automatic and Manual modes.

AUTOMATIC MODE (Default mode)

In Automatic mode, if any button is pressed (including the LIGHT button), the illumination will light for 4 seconds.

MANUAL MODE (Optional mode)

In Manual mode, the illumination will only work when the LIGHT button is pressed. When the LIGHT button is pressed, the illumination will light for 8 seconds. During the illumination, if the LIGHT button is pressed, the illumination will turn off.

CHANGING LIGHTING MODES (Automatic to Manual/Manual to Automatic)

1. Place the Remote Control in TV Mode by using the SOURCE ACCESS ◀ and ▶ buttons. The TV mode indicator will blink 3 times to confirm the remote control mode.
2. Press and hold the LIGHT button for 10 seconds. After releasing the LIGHT button, the TV mode indicator will blink 3 times to confirm the mode switch.

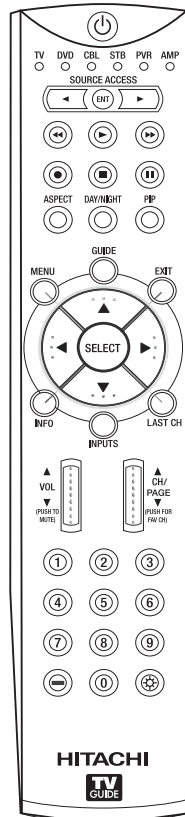

How to Use the Remote to Control Your TV

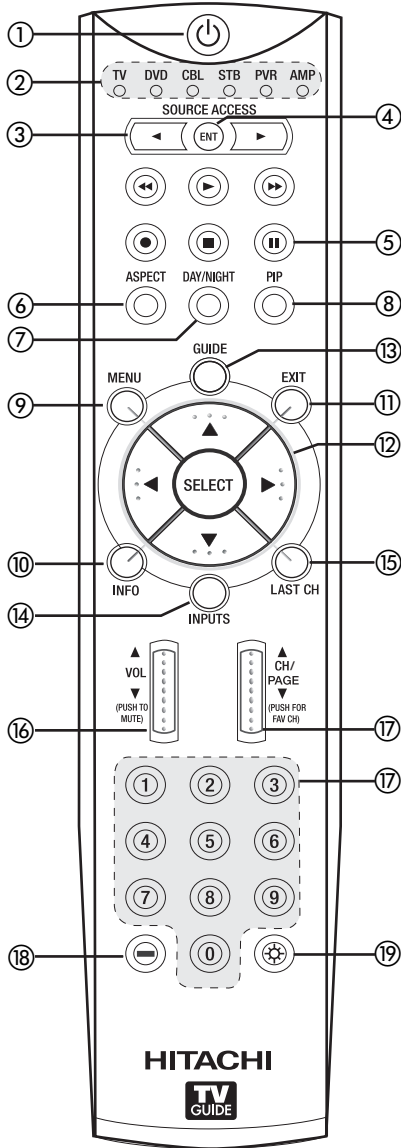

- ① **POWER button**
Press this button to turn the TV set on or off when the remote is in TV mode. (See page 21 for instructions on how to set the remote control to TV mode.)
- ② **MODE Indicator**
Turns on or blinks to show remote control mode.
- ③ **SOURCE ACCESS (◀ or ▶) buttons**
Press these buttons to select remote control mode.
- ④ **SOURCE ACCESS (ENT) button**
Hold down this button while entering your device code to program the remote (see pages 31-38). You can also use this button in an optional Input access feature (see page 36).
- ⑤ **PAUSE button**
Press the PAUSE button to freeze the picture. Press the EXIT button to return the picture to motion. Press the PAUSE button repeatedly to cycle through the three different freeze modes (see page 30).

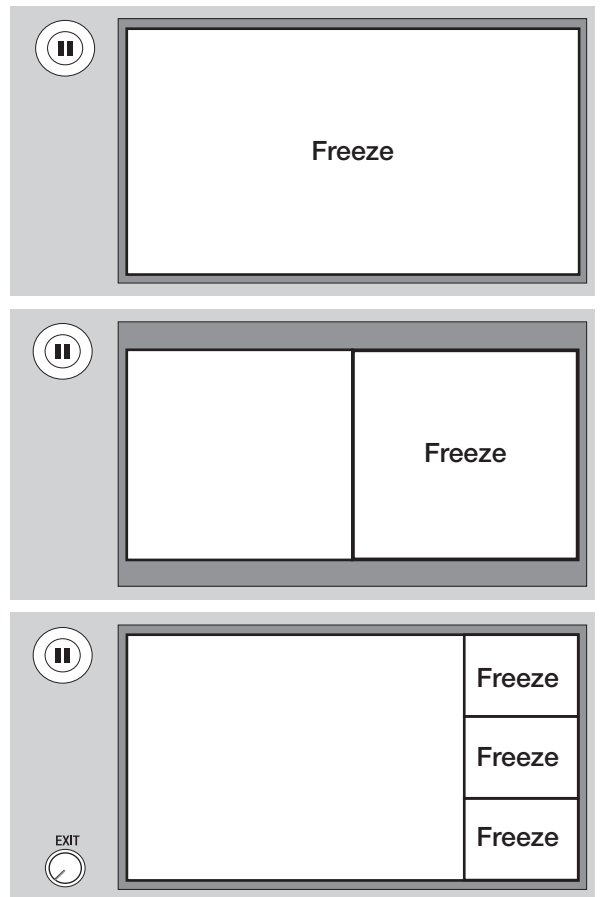

How to Use the Remote to Control Your TV

⑥ ASPECT button

Press this button to quickly change the picture format ASPECT ratio. Depending on the input signal format received, the picture format ratio allows you to adjust the images through the following options.

4:3 STANDARD

Use this aspect mode to display conventional (4:3) images. Side panels (gray areas) are placed to the left and right of the image to preserve the original aspect ratio of the source.

4:3 EXPANDED

Use this aspect mode to display conventional (4:3) sources by linearly increasing image expansion from the center towards the edges of the display area in order to fill it.

4:3 ZOOM1/ZOOM2

Use these aspect modes to zoom in on conventional (4:3) sources.

16:9 STANDARD

Use this aspect mode to display 16:9 sources like HDTV and DVD's preserving the original 16:9 aspect ratio.

16:9 ZOOM

Use this aspect to Zoom-in once while in 16:9 aspect.

- Antenna-Analog
- S-Video/Video Input (Auto Aspect: Off)
- HDMI-480i/480p Input (Auto Aspect: Off)
- Component-480i/480p Input (Auto Aspect: Off)

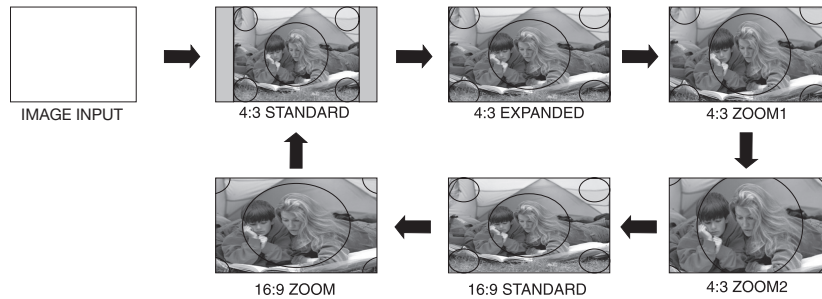

Note: Please see Appendix A on page 99.

- Antenna-Digital (4:3)
- S-Video/Video 4:3/Letter Input (Auto Aspect: On)
- HDMI-480i/480p 4:3/Letter Input (Auto Aspect: On)
- Component-480i/480p 4:3/Letter Input (Auto Aspect: On)

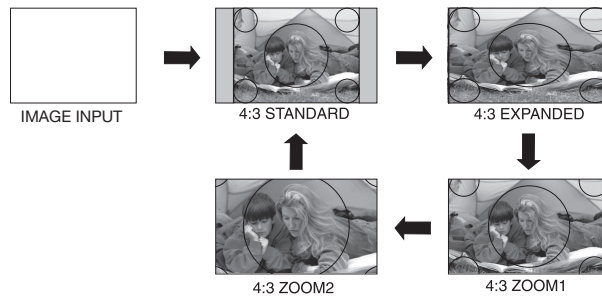

Note: Please see Appendix B on page 99.

- S-Video/Video 16:9 Input (Auto Aspect: On)
- HDMI-480i/480p 16:9 Input (Auto Aspect: On)
- Component-480i/480p 16:9 Input (Auto Aspect: On)

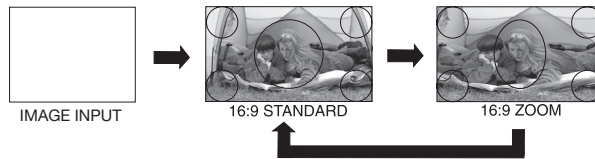

Note: Please see Appendix C on page 99.

- Antenna-Digital (16:9)
- HDMI-720p/1080i Input
- Component-720p/1080i Input

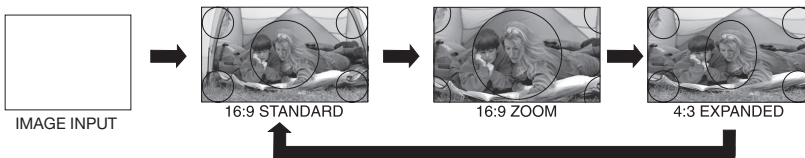

Note: Please see Appendix D on page 99.

NOTE: 1. The Aspect Style setting you select for an ANT input will automatically be set for the other ANT input. However, all five video inputs have independent Aspect Style settings.
2. Vertical position adjustments are directly available when you choose 4:3 EXPANDED/ZOOM1/ZOOM2 or 16:9 ZOOM aspect style (see also pages 42-43).

How to Use the Remote to Control Your TV

- ⑦ **DAY/NIGHT button**
Press this button to toggle between Day and Night picture mode settings. Select Day for day time viewing with more brightness and contrast to compete with room light. Select Night for night time viewing with less brightness and contrast for a more detailed picture (see page 46 for settings changes).

NOTE: For automatic DAY/NIGHT picture mode settings, see page 41.

- ⑧ **PICTURE-IN-PICTURE button**
See separate section on pages 28-30 for a description.
- ⑨ **MENU button**
The MENU button will start the On-Screen Display.
- ⑩ **INFO button**
Press this button when you want to check the channel being received, the picture source, if the channel has stereo (ST) or second audio program (SAP), the time, CHANNEL ID and if the TIMER is set.

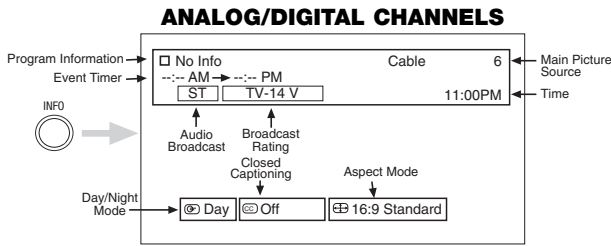

When an S-VIDEO Input is connected to INPUT 3

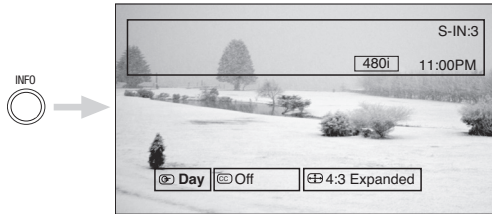

When a Component Video: Y-PbPr Input is connected to INPUT 1

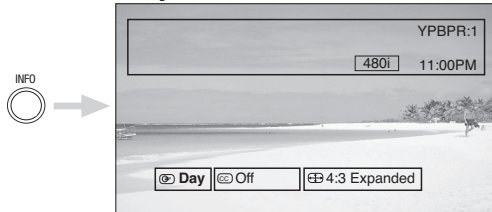

NOTE: 1. The Sleep Timer info will show momentarily after releasing INFO button.
2. The Aspect setting will not be shown if the channel is locked.

- ⑪ **EXIT button**
This button will exit all On-Screen Displays.
- ⑫ **CURSOR PAD/SELECT button**
All the On-Screen Display features can be set or adjusted by using the CURSOR PAD, except for numeric entries. The CURSOR PAD will highlight functions or adjust and set different features. Press the CURSOR PAD toward desired direction and press the SELECT button to select.
- ⑬ **GUIDE button**
Press this button to access the TV Guide On Screen™ interactive display (see page 57). Press this button to access the Channel Guide of the (CBL), and (SAT/STB) while in (CBL)(SAT/STB) mode.
- ⑭ **INPUTS button**
When the remote control is in TV mode, press this button to access the INPUTS menu. Use the CURSOR PAD and SELECT button to select the inputs that are being used. Pressing the INPUTS button repeatedly will also cycle through the Inputs menu items. Then press the SELECT button to select.

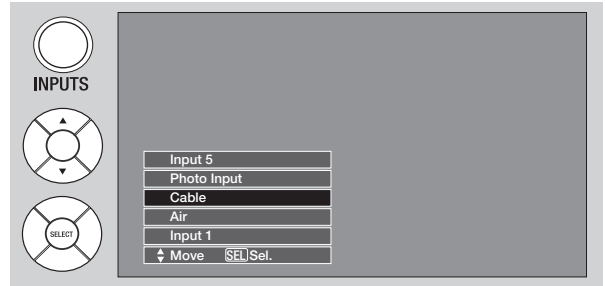

- INPUT 1** Select to choose INPUT 1.
- INPUT 2** Select to choose INPUT 2.
- INPUT 3** Select to choose INPUT 3.
- INPUT 4** Select to choose INPUT 4.
- INPUT 5** Select to choose INPUT 5.
- CABLE** Select to choose Cable.
- AIR** Select to choose Air.
- PHOTO INPUT** Select to access your pictures from a digital camera, USB memory or memory card USB drive connected to the Photo Input in the side panel of the LCD TV (see pages 25-26).

How to Use the Remote to Control Your TV

PHOTO INPUT

This feature is useful for viewing digital still pictures from your digital camera, USB Drive or memory cards USB drive using the Photo Input in the right side panel of the TV.

1. Press the INPUTS button to cycle through the INPUTS selections until the PHOTO INPUT is selected. Press the SELECT button or CURSOR PAD ►.

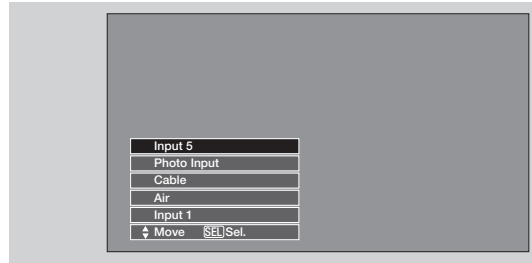

2. Press the CURSOR PAD ◀ or ▶ to access the next or previous photo.



3. Press the SELECT button to view THUMBNAIL.
4. Use the CURSOR PAD buttons ▲, ▼, ◀ or ▶ and the SELECT button to navigate and select individual chosen photos.

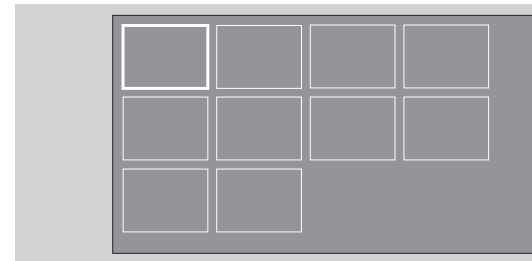

5. Press the picture number to jump from picture to picture.



6. Press the INFO button to access PHOTO Input menu and to view Photo information.
7. Press the CURSOR PAD ▲ or ▼ and the SELECT button to navigate and select the PHOTO Input menu.

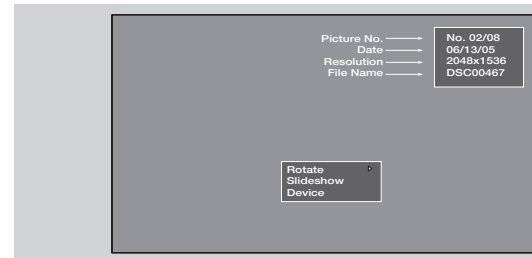

NOTES:

1. The maximum number of digital Photos that can be displayed is 999.
2. Press INFO button to show Picture Numbers in Thumbnail view, plus other information in individual photos.
3. Digital photos recorded on a DVD-RAM disc may not work with this Photo Input.
4. Certain types of digital cameras may not work with this Photo Input.
5. Digital cameras with low battery power may not properly display your photos in this input.
6. The screen may show "Input device not detected" if the digital camera's large capacity memory is fully loaded, or because of slow access time on some digital cameras. Please wait 1 or 2 minutes before checking your Photo Input connections.

How to Use the Remote to Control Your

ROTATE

Select this menu item to rotate selected photos either clockwise (CURSOR PAD ►) and counterclockwise (CURSOR PAD ◀).

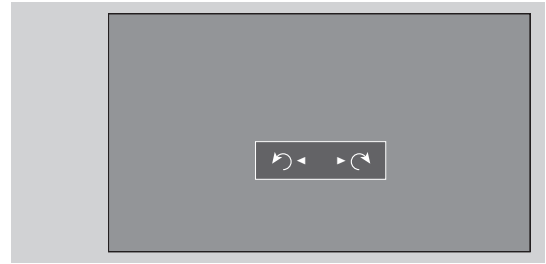

SLIDESHOW

Select this menu item to start a slideshow of the digital photos. While the Interval sub menu is highlighted, press the SELECT button to cycle through the interval time from 5, 10 and 30 seconds. Press the SELECT button to stop on a chosen picture of the slideshow. After 30 seconds, the slideshow will resume or press the SELECT button again to continue with the slideshow.

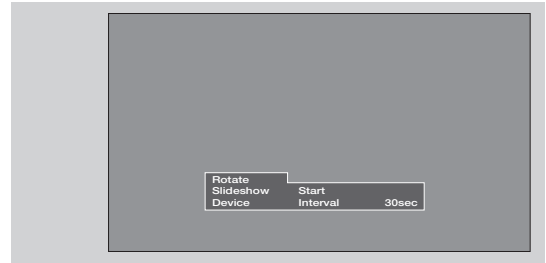

DEVICE

Select this menu item to select the Photo Input Device Drive when using a USB Drive device. Use the CURSOR PAD ◀ or ► to select Device Drive. Press the INFO button to highlight a device, then press the SELECT button or CURSOR PAD ► to access it. Use the CURSOR PAD ◀ or ► to choose the device to read.

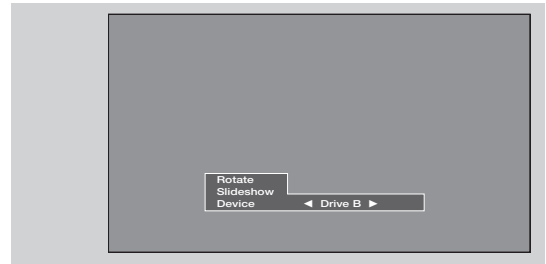

- NOTES:**
1. Photo file names modified on a computer should be 8 characters (Ex. ABCD1234.jpg). 1st character: letters; 2nd to 4th: letters or numbers; 5th to 8th: numbers. Photo files should be first placed on a sub directory name with 8 characters (Ex. 123ABCDE). 1st to 3rd: number; 4th to 8th: letters. The sub directory then should be placed on a main directory with a "dcim" file name format.
 2. Supported image types are up to 3072 x 2304; JPEG format should conform with DCF Standard (Design rule for Camera File System).
 3. This TV set displays only digital pictures from digital cameras which meet DCF Standard. Pictures that were copied, edited or modified on a computer may not be displayed on the TV set.

How to Use the Remote to Control Your TV

⑮ LAST CHANNEL (LAST CH) button

Press this button to toggle between the current and last channel viewed.

⑯ VOLUME (VOL) WHEEL, MUTE button

Use the VOL WHEEL (▲ or ▼) until you obtain the desired sound level.

To reduce the sound to one half of normal volume (SOFT MUTE) to answer the telephone, etc., press the VOL wheel down. Press the VOL wheel again to turn the sound off completely (MUTE). To restore the sound, press the VOL wheel one more time or VOL Up (▲).

Press the channel (CH) wheel to switch to Favorite (FAV) channel mode. You will know you are in Favorite Channel mode when (FAV) is displayed and the displayed channel is GREEN. Press it again to return to your regular tuned channels. You can add any channel to your Favorite channel list by pressing and holding down the Channel (CH) wheel until the displayed channel turns from WHITE to highlighted GREEN. You can also delete a channel from your favorite channel list by pressing and holding down the Channel (CH) wheel until the displayed channel turns highlighted GREEN to WHITE.

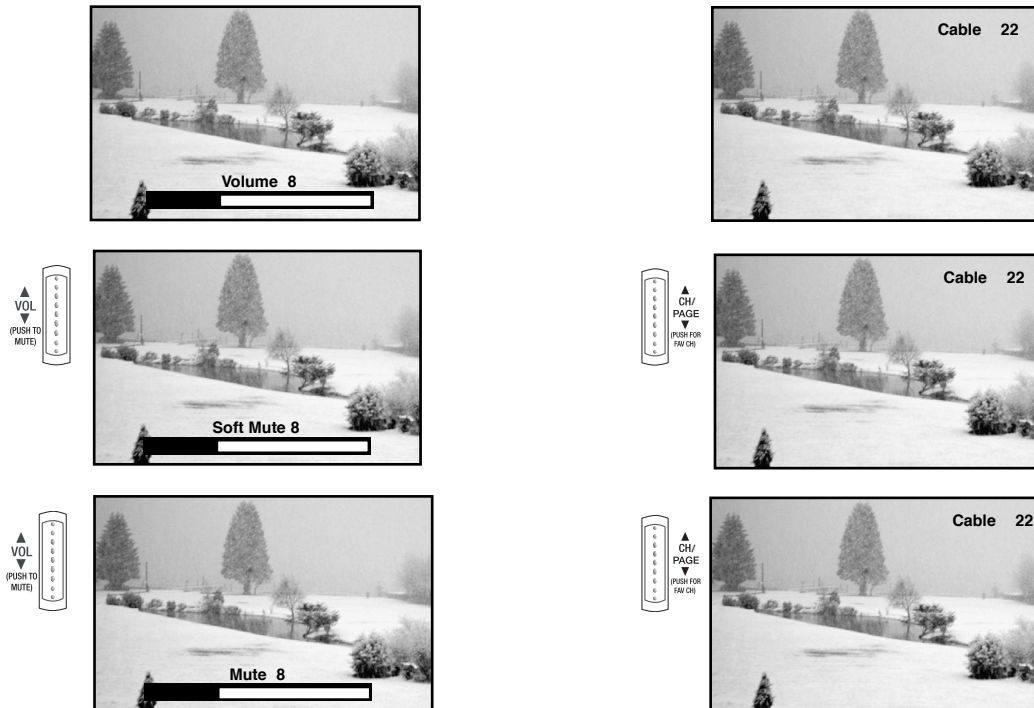

Closed Captioning will display automatically when MUTE/SOFT MUTE is on and Closed Caption is set to AUTO (see page 84).

When the TV power is turned off at a volume level 31 or greater, the volume level will default to 30 when the TV is turned on. However, if it is set to a level 30 or less, the volume level will be at the level it was set when the TV is turned ON.

⑰ CHANNEL (CH) WHEEL/CHANNEL SELECTOR buttons

The CHANNEL wheel or the CHANNEL SELECTOR buttons are used to select channels, lock access code, etc. Use the CHANNEL WHEEL (▲ or ▼) to select the desired channel. Use the CHANNEL SELECTOR buttons to enter one, two, or three numbers to select channels. Enter "0" first for channels 1 to 9, or simply press the single digit channel you wish to tune then wait a few seconds for the TV to tune. For Digital Channels, use the CHANNEL SELECTOR buttons with the (-) DASH button. Channel selection may also be performed by CHANNEL WHEEL up (▲) or CHANNEL WHEEL down (▼).

⑱ (-) DASH button

Use the (-) DASH button with the CHANNEL SELECTOR buttons to enter Digital Channels that have subchannel numbers indicated by (-) DASH (example 15-1).

⑲ BACKLIGHT button

Press this button to light up and illuminate the buttons of the remote control.

Picture-In-Picture (PIP)

Your HITACHI LCD Rear PTV incorporates Two Tuner technology designed for improved viewing enjoyment. This Two Tuner feature allows you to view antenna inputs on both the main picture and sub picture simultaneously, with separate tuning control for each. When a Digital channel is viewed in the main picture, the Digital channel can not be viewed in the sub picture. And when the Analog channel input is viewed in the main picture, the Analog channel input can not be viewed in the sub picture.

To select between main picture and PIP sub picture tuning, use the CURSOR PAD button on the remote. The Green highlighted channel display will move with every press of the CURSOR PAD buttons.

The Picture-in-Picture feature is convenient when you want to watch more than one program at the same time. You can watch a TV program while viewing other programs from any of the video inputs.

Use the connection diagram to the right to view VCR program (from Input 1-5) as a sub-picture while viewing another program as main picture (**CABLE, AIR**). You may also view the VCR program (from Input 1-5) as a main picture while viewing another program as a sub-picture (**CABLE or AIR**).

When installing a CableCARD, connect your coaxial cable to **CABLE** (see page 12). **AIR** will not be available while using a CableCARD.

① PIP button

Press the PIP button and a sub-picture will appear in one of the four different modes (POP, PIP, SPLIT or SURF), depending on the INPUT signal. To change the PIP mode, use the PIP button to cycle through the four different modes.

POP MODE PICTURE-IN-PICTURE

POP Mode PIP displays the sub-picture outside of the main picture. Use the CURSOR PAD (▲ or ▼) to move the sub-picture. This feature is not available with a 1080i signal. Please refer to the PICTURE-IN-PICTURE MODES Table (see page 29).

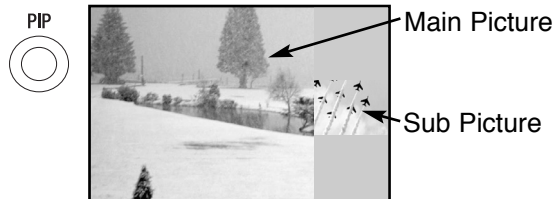

- NOTES:**
1. PIP MODE Picture-in-Picture is only available with a 1080i signal.
 2. Press the CURSOR PAD (◀ or ▶) to enable the sub-picture sound.
 3. Sub-picture channel availability depends on the channel list.
 4. Two INPUTS cannot be viewed in PIP mode. Only one INPUT (1-5) and one antenna (Cable or Air).

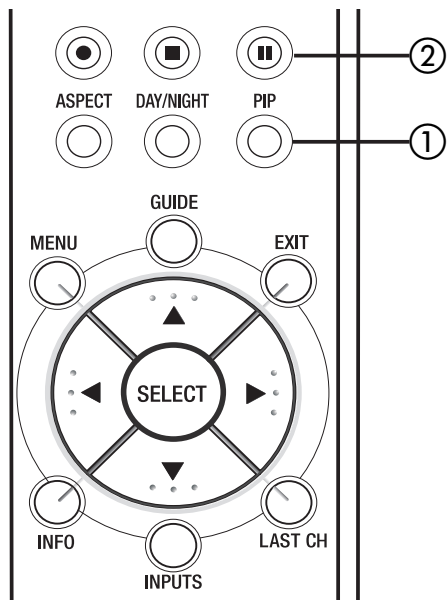
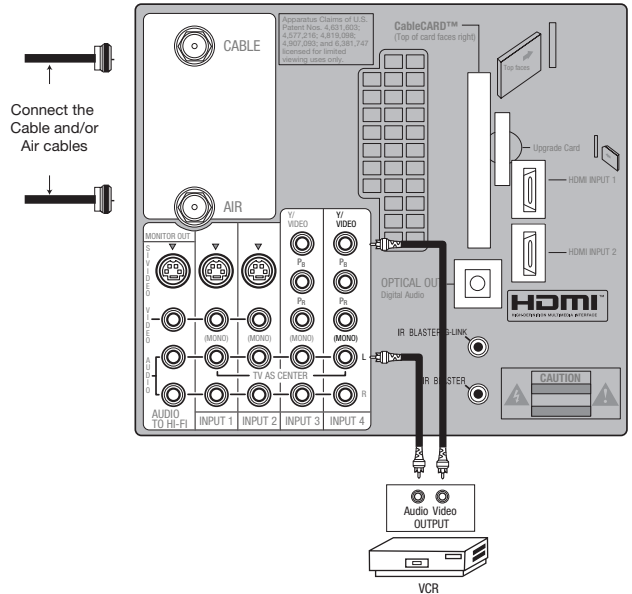

Picture-in-Picture (PIP)

PIP MODE PICTURE-IN-PICTURE

Select AIR from the INPUTS menu. Select a channel that has a 1080i signal. To prevent a pattern burn, occasionally move the sub-picture using the CURSOR PAD.



Main Picture

Sub Picture

SPLIT MODE PICTURE-IN-PICTURE

Split Mode PIP displays the main picture and sub-picture evenly on the screen.



Main Picture

Sub Picture

SURF MODE PICTURE-IN-PICTURE

Surf Mode PIP automatically scans all active channels (those set in Memory) and displays them as PIP sub-pictures or Thumbnails. Press the SELECT button to stop on a chosen channel. Use the remote CURSOR PAD ▲, ▼, ◀ or ▶ to navigate the Thumbnails. Press the SELECT button to restart channel scan or press the EXIT button to enable your chosen channel and return to normal viewing.



PIP Mode	MAIN PICTURE		SUB-IMAGE				
			Digital Tuner		1080i / 720p	480p / 480i / Analog Tuner / Video / S-Video	
	Format	Aspect	16 : 9	4 : 3	16 : 9	16 : 9	4 : 3
POP	ANT Digital	4 : 3	-	-	YES	YES	YES
	480p/480i	16 : 9	YES	YES	-	-	-
	ANT Analog Video / S-Video	4 : 3	YES	YES	-	-	-
PIP 4 : 3	ANT Digital	16 : 9	-	-	-	YES	YES
	1080i / 720p	16 : 9	-	YES	-	-	-
PIP 16 : 9	ANT Digital	16 : 9	-	-	YES	YES	YES
	1080i / 720p	16 : 9	YES	-	-	-	-
SPLIT	ANT Digital	16 : 9	-	-	YES	YES	YES
		4 : 3	-	-	YES	YES	YES
	1080i / 720p	16 : 9	YES	YES	-	-	-
	480p / 480i ANT Analog Video / S-Video	16 : 9	YES	YES	-	-	-
		4 : 3	YES	YES	-	-	-
SURF 12 PIX	---	---	YES	YES	-	-	YES ¹

Yes¹- Available only in analog tuner.

Picture-in-Picture (PIP)

② PAUSE button

If you wish to freeze the sub-picture, press the PAUSE button. This is convenient when trying to write down the address for a mail order company, recording statistics for a sporting event, etc. To return the picture to motion, press the EXIT button. Press the PAUSE button repeatedly to toggle between FREEZE modes (Main Freeze, SPLIT and STROBE).

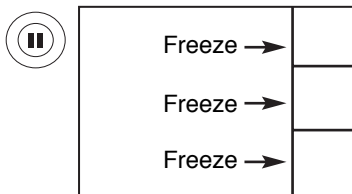
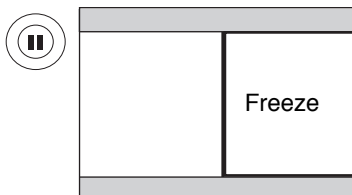

MAIN FREEZE

Press the PAUSE button to freeze one frame of the picture you are currently viewing and the frozen frame will show in the Main Picture. Press the EXIT button to return to normal viewing. This feature is useful for freezing a picture frame with addresses.



SPLIT FREEZE

Press the PAUSE button to freeze the picture you are currently viewing (only the right sub-picture will freeze). Press the EXIT button to return to normal viewing.

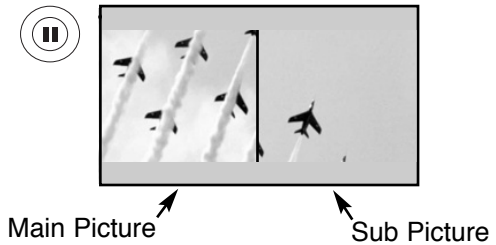

STROBE FREEZE

Press the PAUSE button to freeze three frames of the picture you are currently viewing (only the 3 sub-pictures will freeze). Press the EXIT button to return to normal viewing. This feature is useful for viewing a moving picture that has many details, for example, a close play in a sporting event or a golf swing.



NOTE: 1. The default FREEZE mode is the MAIN freeze followed by the SPLIT freeze and then the STROBE freeze. The last FREEZE mode you selected before you pressed the EXIT button will be the one that comes up after pressing the PAUSE button again.
2. Each freeze frame in Strobe Freeze is delayed about 0.1 (1/10) second.

The Remote Control for Cable Box Functions

Operating the precoded function for your cable box.

This remote is designed to operate different types of cable boxes. You must first program the remote to match the remote system of your cable box (refer to pages 37-38 for pre-codes).

1. Turn ON your cable box.
2. Aim the remote control at the front of your cable box.
3. To switch to Cable (CBL) pre-coded mode, use the SOURCE ACCESS buttons (◀ or ▶) on the remote control to position the LED light to the corresponding selection.
4. Hold down the ENT button on the remote and enter the four digit preset code that matches your cable box as shown on pages 37-38. Release the ENT button. The indicator light will flash 3 times if the code was accepted.
5. Aim the remote at the cable box and press the POWER button. The remote will turn off your cable box when the correct four digit preset code is entered. When this occurs, the remote control is programmed for your cable box. If the cable box does not turn off, try a different four digit preset code.
6. The remote will now control your Cable box.

NOTE: 1. If your cable box cannot be operated after performing the above procedures, your cable box code has not been precoded into the remote.

2. In the unlikely event that your cable box cannot be operated after performing the above procedures, please consult your cable box operating guide.

3. The remote control will remember the codes you have programmed until the batteries are removed from the remote control. After replacing the batteries repeat the entire programming procedure as stated above.

- ① **PRECODED CABLE BOX buttons**
These buttons transmit the chosen precoded cable codes.
- ② **EXCLUSIVE TV buttons**
These buttons are for operating the TV.

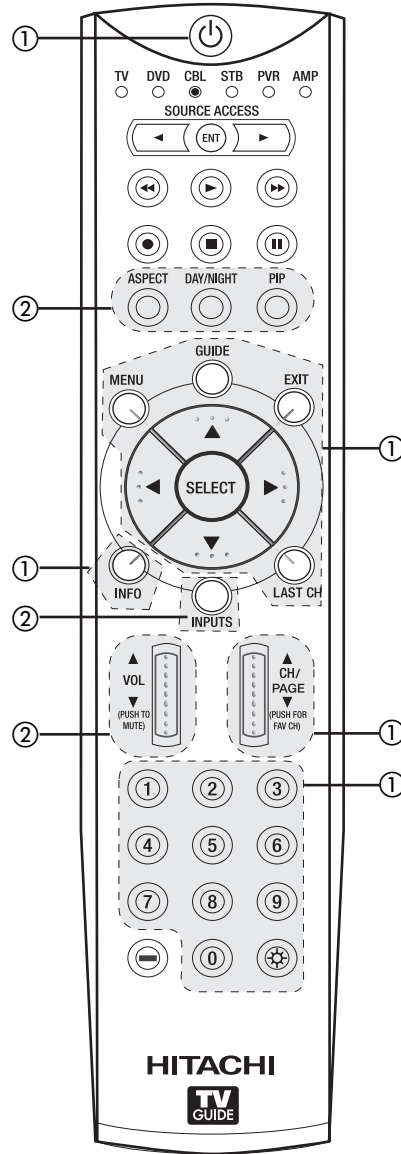

MY CABLE BOX CODE IS: _____

NOTE: Refer to instruction manual of the Cable Box for operation of the buttons exclusively for the Cable Box.

The Remote Control for Set-Top Box/Satellite Receiver Functions

Operating the precoded function for your set-top-box/satellite receiver.

This remote is designed to operate different types of set-top-box/satellite systems. You must first program the remote to match the remote system of your set-top-box/satellite systems (refer to pages 37-38 for pre-codes).

1. Turn ON your set-top-box/satellite systems.
2. Aim the remote control at the front of your set-top-box/satellite systems.
3. To switch to set-top-box/satellite (STB) pre-coded mode, use the SOURCE ACCESS buttons (◀ or ▶) on the remote control to position the LED light to the corresponding selection.
4. Hold down the ENT button on the remote and enter the four digit preset code that matches your set-top-box/satellite receiver as shown on page 37-38. Release the ENT button. The indicator light will flash 3 times if the code was accepted.
5. Aim the remote at the set-top-box/satellite receiver and press the POWER button. The remote will turn off your set-top-box/satellite receiver when the correct four digit preset code is entered. When this occurs, the remote control is programmed for your set-top-box/satellite receiver. If the set-top-box/satellite receiver does not turn off, try a different four digit preset code.
6. The remote will now control your set-top-box/satellite receiver.

- NOTE:**
1. If your set-top-box/satellite receiver cannot be operated after performing the above procedures, your set-top-box/satellite receiver code has not been precoded into the remote.
 2. In the unlikely event that your set-top-box/satellite receiver cannot be operated after performing the above procedures, please consult your set-top-box/satellite receiver operating guide.
 3. The remote control will remember the codes you have programmed until the batteries are removed from the remote control. After replacing the batteries repeat the entire programming procedure as stated above.

① PRE-CODED SET-TOP-BOX/SATELLITE RECEIVER buttons

These buttons transmit the chosen pre-coded set-top-box/satellite codes.

② EXCLUSIVE TV buttons

These buttons are for operating the TV.

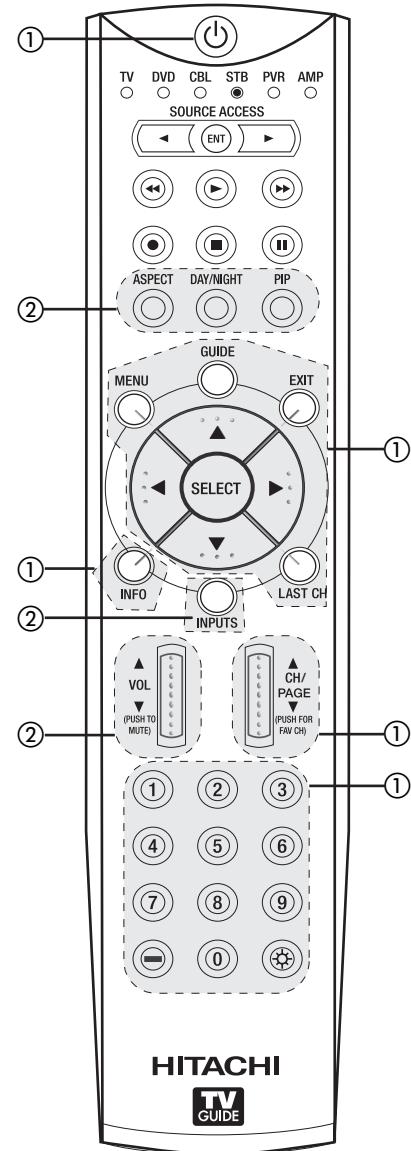

**MY Satellite RECEIVER/
SET-TOP-BOX CODE IS:** _____

NOTE: Refer to instruction manual of the Set-Top-Box/Satellite Receiver for operation of the buttons exclusively for the Set-Top-Box/Satellite Receiver.

The Remote Control for DVD Functions

Operating the precoded function for your DVD player.

This remote is designed to operate different types of DVD players. You must first program the remote to match the remote system of your DVD player (refer to pages 37-38 for pre-codes).

1. Turn ON your DVD player.
2. Aim the remote control at the front of your DVD player.
3. To switch to DVD pre-coded mode, use the SOURCE ACCESS buttons (◀ or ▶) on the remote control to position the LED light to the corresponding selection.
4. Hold down the ENT button on the remote and enter the four digit preset code that matches your DVD player, as shown on pages 37-38. Release the ENT button. The indicator light will flash 3 times if the code was accepted.
5. Aim the remote at the DVD player and press the POWER button. The remote will turn off your DVD player when the correct four digit preset code is entered. When this occurs, the remote control is programmed for your DVD player. If the DVD player does not turn off, try a different four digit preset code.
6. The remote will now control your DVD player.
7. You will need to set the display type of your DVD player to 16:9 widescreen.

NOTE: 1. If your DVD player cannot be operated after performing the above procedures, your DVD player code has not been precoded into the remote.
 2. In the unlikely event that your DVD player cannot be operated after performing the above procedures, please consult your DVD player operating guide.
 3. The remote control will remember the codes you have programmed until the batteries are removed from the remote control. After replacing the batteries repeat the entire programming procedure as stated above.

① PRECODED DVD Buttons

These buttons transmit the chosen precoded DVD codes.

② EXCLUSIVE TV Buttons

These buttons are for operating the TV.

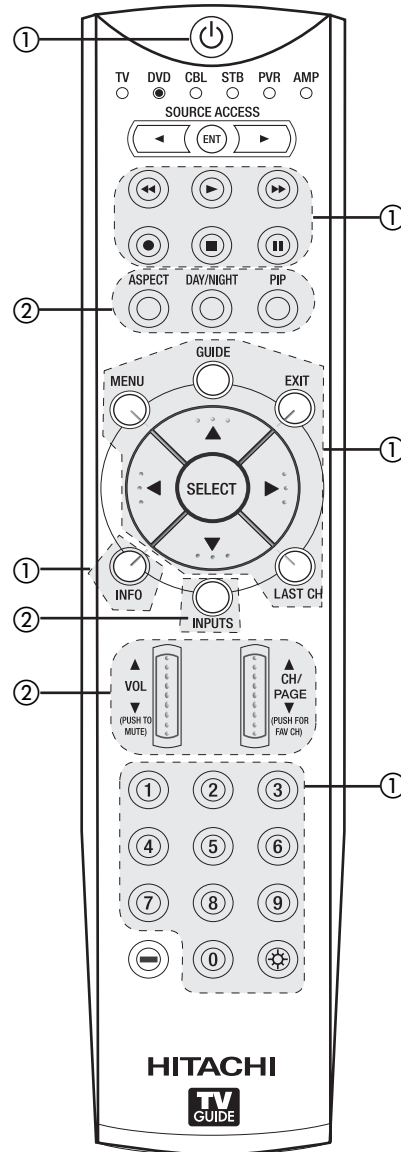

MY DVD PLAYER CODE IS: _____

NOTE: Refer to instruction manual of the DVD Player for operation of the buttons exclusively for the DVD Player.

The Remote Control for VCR/PVR Functions

Operating the precoded function for your VCR/PVR (Personal Video Recorder).

This remote is designed to operate different types of VCRs/PVRs. You must first program the remote to match the remote system of your VCR/PVR (refer to pages 37-38 for pre-codes).

1. Turn ON your VCR/PVR.
2. Aim the remote control at the front of your VCR/PVR.
3. To switch to VCR/PVR pre-coded mode, use the SOURCE ACCESS buttons (◀ or ▶) on the remote control to position the LED light to the corresponding selection.
4. Hold down the ENT button on the remote and enter the four digit preset code that matches your VCR/PVR, as shown on pages 37-38. Release the ENT button. The indicator light will flash 3 times if the code was accepted.
5. Aim the remote at the VCR/PVR and press the POWER button. The remote will turn off your PVR when the correct four digit preset code is entered. When this occurs, the remote control is programmed for your VCR/PVR. If the VCR/PVR does not turn off, try a different four digit preset code.
6. The remote will now control your VCR/PVR.

NOTE: 1. If your VCR/PVR cannot be operated after performing the above procedures, your VCR/PVR code has not been precoded into the remote.
 2. In the unlikely event that your VCR/PVR cannot be operated after performing the above procedures, please consult your VCR/PVR operating guide.
 3. The remote control will remember the codes you have programmed until the batteries are removed from the remote control. After replacing the batteries repeat the entire programming procedure as stated above.

- ① **PRECODED VCR/PVR Buttons**
These buttons transmit the chosen precoded VCR/PVR codes.
- ② **EXCLUSIVE TV Buttons**
These buttons are for operating the TV.

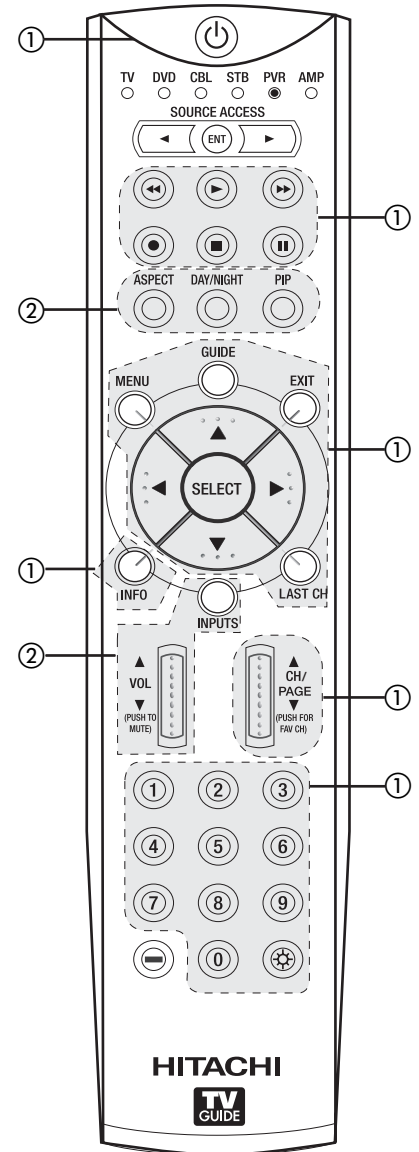

MY VCR/PVR CODE IS: _____

NOTE: Refer to instruction manual of the VCR/PVR for operation of the buttons exclusively for the VCR/PVR.

The Remote Control for Additional Audio Equipment

Operating the precoded function for your Audio component.

This remote is designed to operate different types of Audio component. You must first program the remote to match the remote system of your Audio component (refer to pages 37-38 for pre-codes).

1. Turn ON your Audio component you wish to control with the Remote.
2. Aim the remote control at the front of your Audio component.
3. To switch to Audio (AMP) component pre-coded mode, use the SOURCE ACCESS buttons (◀ or ▶) on the remote control to position the LED light to the corresponding selection.
4. Hold down the ENT button on the remote and enter the four digit preset code that matches your Audio component, as shown on pages 37-38. Release the ENT button. The indicator light will flash 3 times if the code was accepted.
5. Aim the remote at the Audio component and press the POWER button. The remote will turn off your Audio component when the correct four digit preset code is entered. When this occurs, the remote control is programmed for your Audio component. If the Audio component does not turn off, try a different four digit preset code.
6. The remote will now control your Audio component.
7. Repeat steps 1 - 6 if you wish to program the remote to control another Audio component.

NOTE: 1. If your Audio component cannot be operated after performing the above procedures, your Audio component code has not been precoded into the remote.
 2. In the unlikely event that your Audio component cannot be operated after performing the above procedures, please consult your Audio component operating guide.
 3. The remote control will remember the codes you have programmed until the batteries are removed from the remote control. After replacing the batteries repeat the entire programming procedure as stated above.

- ① **PRECODED AUDIO Buttons**
These buttons transmit the chosen precoded Audio component codes.
- ② **EXCLUSIVE TV Buttons**
These buttons are for operating the TV.

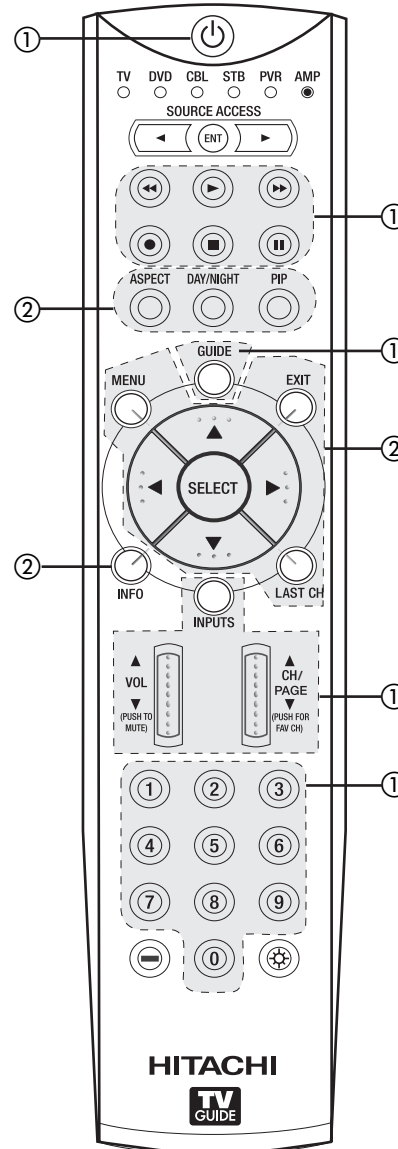

MY AUDIO COMPONENT CODE IS: _____

NOTE: Refer to instruction manual of the VCR/PVR for operation of the buttons exclusively for the VCR/PVR.

How to Use the ENT Button

INPUT ACCESS

This optional feature allows the user of the remote control to setup its ENTER (ENT) button to access the specified input of the TV. Setup for this feature is applicable to the remote control's normal mode only and only applies to the DVD, CBL, STB, PVR and AMP modes.

1. Select the desired device mode (DVD, CBL, STB, PVR, or AMP) by using your SOURCE ACCESS buttons (◀ or ▶) to position the LED indicator to the corresponding selection.
2. Hold down the ENTER (ENT) button on the remote and enter the four digit preset code that matches your device as shown on pages 37-38.
3. Then enter the assigned input number (1-5) that the device is related to.
4. Release ENTER (ENT) button.
5. If done correctly, the device LED indicator will flash 3 times to confirm proper setup.
6. The remote will now control the desired device.
7. Pressing the ENTER (ENT) button will now access the video input (1-5) of the desired device.

SETUP EXAMPLE (Hitachi DVD with precode 0573 connected to INPUT 1 of the TV)

- ① Select DVD mode by using your SOURCE ACCESS buttons (◀ or ▶) to position the LED indicator to DVD.
- ② Hold down the ENTER (ENT) button and press the numbers 0, 5, 7 and 3.
- ③ Then press the number 1 for the assigned input number of the DVD player.
- ④ Release ENTER (ENT) button.
- ⑤ If done correctly, the device LED indicator will flash 3 times to confirm proper setup.
- ⑥ The remote will now control the DVD player.
- ⑦ Press the ENTER (ENT) button to instantly access the video input of your DVD on Input 1.

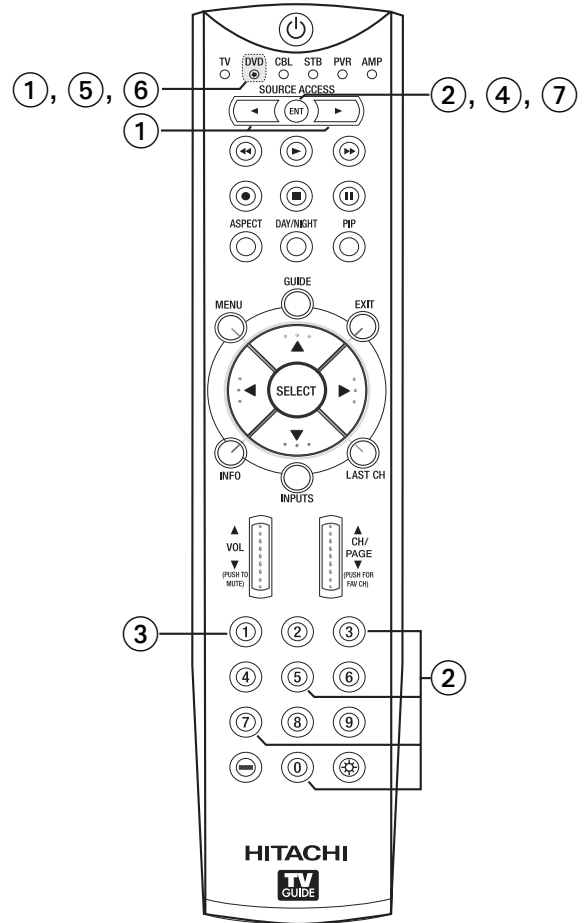

NOTE: 1. This feature is optional
2. Assigned input numbers can be used more than once if applicable.

Remote Control Codes

VCR BRANDCODE

ABS1972
 Admiral0048, 0209
 Adventura0000
 Aiko0278
 Aiwa0000, 0037, 0307
 Akai0041, 0061, 0106
 Alienware1972
 America Action0278
 American High0035
 Asha0240
 Audiovox0037, 0278
 Beaumark0240
 Bell & Howell0104
 Broksonic0121, 0184,
0002, 0209, 0479
 CCE0072, 0278
 Calix0037
 Canon0035
 Carver0081
 Cinerall0278
 Citizen0278, 0037
 Colt0072
 Craig0037, 0072,
0047, 0240, 0271
 Curtis Mathes0035, 0041,
0060, 0162
 CyberPower1972
 Cybernex0240
 Daewoo0278, 0045, 0561
 Dell1972
 Denon0042
 Durabrand0039, 0038
 Dynatech0000
 Electrohome0037
 Electrophonic0037
 Emerex0032
 Emerson0037, 0184, 000, 0121,
 0043, 0209, 0002, 0278, 0061,
 ..0208, 0212, 0479, 0561, 1593
 Fisher0104, 0047, 0066
 Fujii0033, 0035
 Funai0000, 1593
 GE0035, 0060, 0240,
0202, 0761
 Garrard0000
 Gateway1972
 Go Video0432, 0526
 GoldStar0037, 0038
 Gradiente0000, 0008
 HI-Q0047
 HP1972
 Harley Davidson0000
 Harman/Kardon0038, 0081
 Harwood0072
 Headquarter0046
 Hewlett Packard1972
 Hitachi 0000, 0041, 0042, 0105
 Howard Computers1972
 Hughes Network Systems 0042
 iBuy Power1972
 JVC0067, 0041, 0008
 Jensen0041
 KEC0037, 0278
 KLH0072
 Kenwood0041, 0067, 0038
 Kodak0035, 0037
 LG0037
 LXI0037
 Lloyd's0000, 0208
 Logik0072
 MEI0035
 MGA0043, 0240, 0061
 MGN Technology0240
 MTC0000, 0240
 Magnasonic0593
 Magnavox0035, 0081, 0563,
 0000, 0039, 0593
 Magnin0240
 Marantz0081, 0035

Marta0037
 Matsushita0035, 0162, 1162
 Media Center PC1972
 Memorex0035, 0162, 0037,
0048, 0039, 0047, 0240,
0000, 0104, 0209, 0046,
 ..0307, 0479, 1037, 1162, 1262
 Microsoft1972
 Mind1972
 Minolta0042, 0105
 Mitsubishi0061, 0043, 0067
 Motorola0035, 0048
 Multitech0000, 0072
 NEC0038, 0041, 0067, 0104
 Nikko0037
 Noblex0240
 Northgate1972
 Olympus0035
 Optimus0593, 1062, 0162,
0037, 0048, 0104, 0432,
1048, 1162, 1262
 Optonica0062
 Orion0184, 0209, 0002, 0479
 Panasonic0162, 1062, 0035,
0616, 1162, 1262
 Penney0035, 0037, 0240, 0042,
0038
 Pentax0042, 0105
 Philco0035, 0209, 0479, 0561
 Philips0081, 0035, 0618,
1081, 1181, 0062
 Pilot0037
 Pioneer0067
 Polk Audio0081
 Profitronic0240
 Proscan0060, 0202, 0761
 Protec0072
 Pulsar0039
 Quarter0046
 Quartz0046
 Quasar0035, 0162, 1162
 RCA0060, 0240, 0042, 0105,
0106, 0202, 0761, 0880
 Radio Shack0000, 1037
 Radix0037
 Randex0037
 Realistic0035, 0037, 0048,
0047, 0000, 0104, 0046,
0062, 0066
 ReplayTV0614, 0616
 Runco0039
 STS0042
 Samsung0045, 0240, 0432
 Sanky0039, 0048
 Sansui0000, 0067, 0209,
0041, 0479, 1479, 0271
 Sanyo ..0047, 0240, 0104, 0046
 Scott0184, 0045, 0121,
0043, 0210, 0212
 Sears ..0035, 0037, 0047, 0000,
 0042, 0104, 1237, 0046, 0066,
0105
 Semp0045
 Sharp0048, 0848, 0062
 Shintom0072
 Shogun0240
 Singer0072
 Sonic Blue0614, 0616
 Sony0035, 0032, 0000,
0033, 0636, 1032, 1972
 Sylvania0035, 0081, 0000,
0043, 0593, 1593
 Symphonic0000, 0593, 1593
 Systemax1972
 TMK0240, 0208
 Tagar Systems1972
 Tatung0041
 Teac0000, 0041
 Technics0035, 0162
 Teknika0000, 0035, 0037

Thomas0000
 Tivo0618, 0636, 1503
 Toshiba0045, 0043, 0066,
0210, 0212, 0366, 0845,
1008, 1145, 1503, 1972
 Totevision0037, 0240
 Touch1972
 Unitech0240
 Vector0045
 Vector Research0038
 Video Concepts0045, 0061
 Videomagic0037
 Videosonic0240
 Viewsonic1972
 Wards 0060, 0062, 0035, 0048,
0047, 0081, 0240, 0000,
0042, 0072, 0212
 White Westinghouse
0072, 0209
 XR-10000072, 0000, 0035
 Yamaha0038
 ZT Group1972
 Zenith 0039, 0000, 0209, 0033,
0479, 1479

DVD BRANDCODE

AMW0872
 Aiwa0641
 Allegro0869
 Apex Digital ..0672, 0717, 0755,
 0794, 0796, 0797, 1004, 1020,
 ..1056, 1061, 1100, 1915, 1937
 Audiovox0790, 1072
 Axion1072
 Blaupunkt0717
 Blue Parade0571
 Brooksonic0695
 CAVS1057
 CineVision0876, 0869
 Classic1917
 Coby1086
 Curtis Mathes1087
 CyberHome ..0816, 1023, 1024
 DVD20000521
 Daewoo0784, 0705,
0833, 0869, 1918
 Denon0490, 0634
 Dual1068, 1085
 Emerson0591, 0675
 Enterprise0591
 Fisher0670
 Funai0675
 GE0522, 0717, 0815
 GPX0699, 0769
 Gateway1073
 Go Video0744, 0715, 0783,
0833, 0869, 1075
 Gradiente0651
 Greenhill0717
 Grundig0705
 Harman/Kardon0702
 Hitachi0573, 0664, 0695
 Hiteker0672
 IRT0783
 Initial0717
 Integra0627
 Hiteker0672
 JBL0702
 JVC0623, 0558, 0867, 1901
 KLH0717, 0790, 1020
 Kawasaki0790
 Kenwood0490, 0534
 Koss0651
 Lasonic0798
 Lite-On1058
 Magnavox0503, 0675,
1914, 1976
 Marantz0539
 Memorex0695
 Microsoft0522

Mintek0717, 0839
 Mitsubishi0521, 1521
 Nesa0717
 Norcent1003, 0872
 Onkyo0627, 0503
 Oritron0651
 Panasonic0490
 Philco0790
 Philips ..0503, 0539, 0646, 0854
 Pioneer0525, 0571, 1902
 Polaroid1061, 1086
 Polk Audio0539
 Proscan0522
 Qwestar0651
 RCA0522, 0571, 0717,
0790, 0822, 1974
 Recco0698
 Rio0869
 Rotel0623
 Rowa0823
 Sampo0698, 0752
 Samsung0490, 0573,
0820, 0744, 1075
 Sansui0695
 Sanyo0670, 0695, 0873
 Semp0503
 Sharp0630, 0752
 Shinsonic0533, 0839
 Sonic Blue0869
 Sony0533
 Sylvania0675
 Symphonic0675
 TYT0705
 Teac0790
 Technics0490
 Theta Digital0571
 Tivo1996
 Toshiba0503, 0695, 1045,
1988, 1996, 2006
 Tredex0799, 0803
 US Logic0839
 Urban Concepts0503
 Venturer0790
 XBox0522
 Yamaha0490, 0545, 0539
 Zenith0591, 0503, 0869

CABLE BRANDCODE

ABC0003, 0008, 0011, 0013,
0014, 0017
 Allegro0153, 0315
 Americast0899
 Antronix022
 Archer022, 0153, 0797
 Bell & Howell0014
 Bell South0899
 Cabletenna0022
 Cableview0022
 Century0153
 Citizen0153, 0315
 ClearMax0883
 Clearmaster0883
 Colour Voice0025, 0031
 Comtronics0040
 Contec0019
 Coolmax0883
 Digi0637
 Director0476
 Dumont0637
 Emerson0797
 Everquest0015, 0040
 Focus0400
 Garrard0153
 Gemini0015, 0797
 General Instrument 0003, 0011,
0476, 0276, 0810
 GoldStar0040, 0144
 Goodmind0797
 Hamlin 0009, 0020, 0034, 0273
 Hitachi0011

Remote Control Codes

Jasco0015, 0153, 0315
 Jerrold 0003, 0011, 0012,
 0014, 0015, 0024, 0276, 0476,
0810
 Memorex0000
 Motorola 0276, 0476, 0810,
1106, 1254, 1376
 Movie Time0063
 Multivision.....0012
 NSC0063
 Novaplex.....0618
 Oak0019
 Optimus0021
 Pace0237, 1877
 Panasonic.....0000, 0021, 0107
 Panther0637
 Paragon0000
 Philips0305, 0317
 Pioneer0023, 0025, 0031, 0153,
0144, 0533, 0877, 1877
 Popular Mechanics0400
 Pulsar0000
 Quasar0000
 RCA0021
 RadioShack..0015, 0315, 0797,
0883
 Recoton0400
 Regal0020, 0273, 0279
 Rembrandt0011
 Runco0000
 SL Marx0040
 Samsung0040, 0144
 Scientific Atlanta ...0877, 0008,
0017, 0477, 1877
 Signal0015, 0040
 Signature0011
 Sony1006
 Sprucer0021
 Starcom0003, 0015
 Stargate0015, 0040, 0797
 Starquest0015
 Supercable0276
 Supermax0883
 TFC.....0310
 TV860063
 Tandy0258
 TeleCaption.....0221
 Teleview0040
 Timeless0040
 Tocom0012, 0013
 Torx.....0003
 Toshiba0000
 Tristar0883
 Tusa0015
 Unika0022, 0153
 Universal0022, 0153, 0191
 V20883
 ViewMaster0883
 Viewstar0063, 0258
 Vision0883
 Vortex View.....0883
 Zenith ..0000, 0054, 0525, 0899
 Zentek.....0400

SATELLITE BRAND (Set-Top-Box).....CODE
 AlphaStar0772
 Amway0043, 0075
 Astro Industries.....0095
 BSR0095
 Cable Innovations.....0554
 Capetronic0095
 Century0856
 Channel Master0018, 0212
 Chapparral ...0053, 0209, 0216
 Conifer0004
 Crossdigital1109
 Curtis Mathes061
 DX Antenna0041
 DirectTV0392, 0566, 0639,

.....1639, 1142, 0247, 0749,
1749, 0724, 0819, 1856,
1076, 1109, 0099, 1052,
 ..1053, 1054, 1442, 1443, 1444
 Dish Network System1005,
 0775, 1170
 DishPro1005, 0775
 Drake0018, 0064, 0245
 EchoStar1005, 0775, 0148,
0269, 0280, 1170
 Expressvu0775
 GE0566
 GOI0775
 General Instrument0869,
0547, 0554
 Gradiente0856
 HTS0775
 Hitachi0819
 homecable0238
 Hughes Network Systems 1142,
 ..0749, 1749, 1442, 1443, 1444
 Hytek0095
 IQ0210
 IQ Prism0210
 Innova0099
 Intersat0043
 JVC0775, 1170
 Janeil0152
 Legend0269
 Macom0018, 0061
 Magnavox.....0724, 0722
 Memorex.....0724, 0269
 Mitsubishi0749
 Motorola0869
 Netsat0099
 Next Level.....0869
 Norsat0004
 Pace0455
 Panasonic.....0247, 0701, 0152
 Paysat0724
 Philips 1142, 0749, 0724, 1076,
0722, 1749, 0856, 0099
 Pico.....0075
 Proscan0392, 0566
 RCA ...0392, 0566, 0855, 0143
 Radioshack.....0869, 0554
 Ramsey0075
 Realistic0052
 SKY0856, 1856, 0099
 STS.....0041, 0210
 Samsung.....1276, 1109
 Sony0639, 1639
 Star Choice.....0869
 Star Trak0180, 0421, 0547
 Strong0421
 Tivo.....1142, 1442, 1443, 1444
 Toshiba0749, 1749, 0790,
0061, 0082, 1052, 1053,
 ..1054, 1285, 1286, 1287, 1289
 Town & Country0547
 Uniden0724, 0722, 0052, 0074,
0076, 0238, 0370, 0554
 Zenith ..0856, 1856, 0061, 0064

AMPLIFIER BRANDCODE
 Aiwa0406
 Bose0674
 Carver0269
 Curtis Mathes0300
 Denon0160
 Durabrand.....1561
 GE0078
 Harman/Kardon0892
 JVC0331
 Left Coast0892
 Lennox1561
 Linn0269
 Luxman0165
 Magnavox0269
 Marantz0269, 0321, 0892

NEC0264
 Nakamichi0321
 Optimus0395, 0300
 Panasonic.....0308, 0521
 Parasound0246
 Philips0269, 0892
 Pioneer0013, 0300
 Polk Audio0269, 0892
 RCA0300
 Realistic0395
 Sansui0321
 Shure0264
 Sony0815, 0689, 0220
 Soundesign.....0078, 0211
 Technics0308, 0521
 Toshiba0353
 Victor0331
 Wards0013, 0078, 0211
 Yamaha0354, 0133

RECEIVER BRAND (Amplifier) CODE

ADC0531
 Aiwa...1405, 0121, 0158, 0189,
 0405
 Anam1074, 1609
 Arcam1120
 Audiotronic1189
 Bose0639, 1229, 1253
 Capetronic0531
 Carver1189, 0042, 0189
 Casio0195
 Clarinette0195
 Coby1263
 Compaq1136
 Curtis Mathes0080
 Dell1383
 Denon0004, 1360
 Fisher0042
 Garrard0463
 Glory Horse1263
 Harman/Kardon0891, 0110,
 0189
 Hewlett Packard1181
 Hitachi0228
 Integra0135
 JBL0110
 JVC0074, 1263
 KLH1428
 Kenwood1313, 1570, 1569,
0027, 0042, 0186, 0239
 LXI0181
 Linn0189
 Lloyd's.....0195
 MCS0039
 Magnavox ...1189, 1269, 0189,
 0195, 0391, 0531
 Marantz1189, 0039, 0189, 1269
 Mitsubishi1393
 Modulaire0195
 Musicmagic.....1089
 Nakamichi0097
 Onkyo0135, 0842
 Optimus1023, 0042, 0080,
0177, 0181, 0186, 0219,
 ..0531, 0670, 0738, 0801, 1074
 Panasonic1518, 0039, 0309,
 0367
 Penney0195
 Philips1189, 1269, 0189,
0391, 1120
 Pioneer1023, 0014, 0080,
0150, 0244, 0531, 0630
 Polk Audio.....0189
 Proscan1254
 Quasar0039
 RCA1023, 1254, 0080,
0531, 1074, 1609
 Radio Shack1263
 Realistic0181, 0195

Rio1383
 Sansui0189
 Sanyo0801, 1251
 Scott0163, 0322
 Sharp0186
 Sharper Image1263
 Sherwood0491, 0502
 Sonic Blue1383
 Sony ..1058, 1441, 1759, 0158,
0474, 1349, 1406, 1442
 Soundesign.....0670
 Stereophonics1023
 Sunfire1313
 Teac0463, 1074
 Technics.....1308, 1518,
0039, 0309
 Thorens1189
 Toshiba1572
 Victor0074
 Wards .0014, 0080, 0158, 0189
 Yamaha.....0176, 0186, 1176
 Yorx0195
 Zenith0857

AUDIO BRANDCODE

Aiwa0010, 0159
 AudioSource0351
 Cambridge Soundworks ...0351
 Carver0351
 Fisher0052
 Fosgate.....0259
 Harmon/Kardon0477
 JBL0477
 JVC0073
 KLH0351
 Magnavox0325
 Nikko0376
 Paramount Pictures 0317, 0351
 RCA0056
 SSI0317
 Sansui.....0325
 Schneider0376
 Sony0010, 0576
 Soundesign.....0376
 Yorx.....0376

SET TOP BOX BRAND..CODE

Panasonic1120
 Pioneer1010
 Princeton.....0113, 0295
 Samsung.....1190
 Sensory Science1126
 Sharp1010
 Sony0639

PERSONAL VIDEO

RECORDER BRAND.....CODE

Panasonic0616
 Philips0618
 ReplayTV0614, 0616
 SonicBlue0614, 0616
 Sony0636
 Tivo0618, 0636

On-Screen Display

1. Press **MENU** on the remote control to display the different features on your **HITACHI** LCD Rear Projection TV.
2. Press the **CURSOR** buttons to navigate and highlight a different feature of the On-Screen Display menu. Press the **SELECT** button to select.
3. Press **EXIT** on the remote control to quickly exit from a menu.

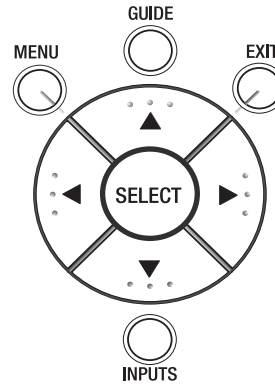

This part of the screen shows which selections are available.

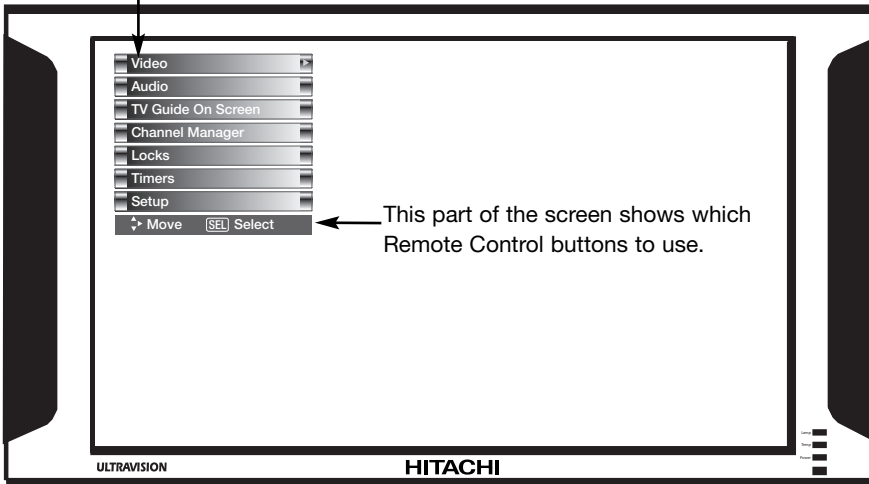

On-Screen Display

Video

Picture Mode	Select between the two picture modes; Day and Night.
Contrast	Adjust contrast.
Brightness	Adjust brightness.
Color	Adjust color.
Tint	Adjust tint.
Sharpness	Adjust sharpness.
Color Temperature	Set this to High for less intense color with more blue, set to Medium for natural color, set to Standard for standard colors or Black and White for more reddish color.
Black Enhancement	Enhance picture brightness in light scenes.
Contrast Mode	Choose Automatic Contrast settings.
Noise Reduction	Reduces conspicuous noise in the picture.
Auto Movie Mode	Turn ON/OFF the 3:2 Pulldown detection feature.
Aspect	Choose the picture format aspect ratio.
Black Side Panel	Set the gray side bars on/off when watching 4:3 signals in standard mode.
Reset Video Settings	Choose the Reset Video settings.

Audio

Treble	Adjust the treble.
Bass	Adjust the bass.
Balance	Adjust the balance.
SRS	Select SRS settings (Off, Wide, Normal)
BBE	Select BBE settings (Off, Soft, Hard)
Audio Source	Select between three Audio Sources.
Internal Speakers	Select internal or external speakers.
Auto Noise Cancel	Eliminates the noise between stations.
Perfect Volume	Adjust volume in fixed setting.
Loudness	Adjust Loudness.
Language	Select Language options if available.
Digital Output	Select Optical Output options.
DRC	Select Dynamic Range Compression to ON or OFF.

TV Guide On Screen

TV Guide On Screen	Set, Control and navigate the system.
--------------------	---------------------------------------

Channel Manager

Signal Meter	Access Signal Meter.
Auto Channel Scan	Set Auto Channel Scan.
Channel List	Set Channel List.

Locks

Change Access Code	Change Lock access code.
Engage Lock	Choose to lock channel or front panel.
Movie Ratings	Block various types of movies and video types based on motion picture ratings.
TV Ratings	Block various types of movies and television programming based on a parental guide ratings.
Canadian Ratings (ENG)	Block various types of movies and television programming based on the Canadian ratings system.
Canadian Ratings (FRN)	Block various types of movies and television programming based on the Canadian French ratings system.

Timers

Set the Clock	Set Clock Settings.
Set Sleep Timer	Set Sleep Timer intervals (30 min. intervals, 00:30-3:00).
Set Day/Night Timer	Set Day/Night picture mode settings.

Setup

Menu Preference	Choose English, French, or Spanish text.
Lamp Power Control	Automatic Power Saving Feature.
Set The Inputs	Label Video Inputs, VCR, DVD, etc.
Set AV NET	Set AV NET Wizard
Set Closed Captions	Feature to display dialogue/text.
Set Monitor Out	Set Monitor Out source.
Upgrades	Select to upgrade TV software.
Quick Start Up	Select the TV Quick Start Up options.

- NOTES:**
1. The Signal Meter feature of the Channel Manager OSD is only available for Digital signals.
 2. The Language, Digital Output, and the Dynamic Range Compression feature of the Audio OSD are only available for Digital channels.

Video

Select VIDEO to adjust picture settings and improve picture quality. You can independently customize each of the Video Inputs to your preference to increase viewing performance and pleasure depending upon the video program being viewed. If RESET is selected, only the selected input will reset to initial conditions.

Picture Mode

Use this function to choose from automatic picture settings to optimize your TV's performance.

1. Use the **CURSOR PAD** ◀ or ▶ to highlight and select **PICTURE MODE** settings.
2. Press **EXIT** to quit menu or select **PICTURE MODE** to return to previous menu.

Function	Day	Night
Contrast	100%	90%
Brightness	50%	50%
Color	50%	30%
Tint	50%	50%
Sharpness	50%	20%
Color Temperature	High	Standard
Black Enhancement	Middle	Off
Contrast Mode	Dynamic	Normal
Noise Reduction	Low	Low
Black Side Panel	On	On

1. Use the **CURSOR PAD** ▲ or ▼ to highlight the function to be adjusted.
2. Press the **CURSOR PAD** ◀ or ▶ to adjust the function. Press the **SELECT** button to select the function settings.
3. Press **MENU** to return to main menu or select **PICTURE MODE** to return to previous menu.
4. Press **EXIT** to quit menu.

Contrast

Use this function to change the contrast between black and white levels in the picture.

Brightness

Use this function to adjust overall picture brightness.

Color

Use this function to adjust the level of color in the picture.

Tint

Use this function to adjust flesh tones so they appear natural.

Sharpness

Use this function to adjust the amount of fine detail in the picture. Sharpness function will be disabled when Noise Reduction is set to High.

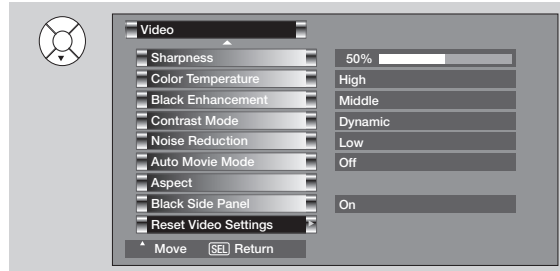
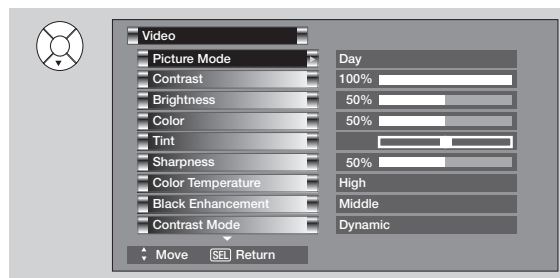
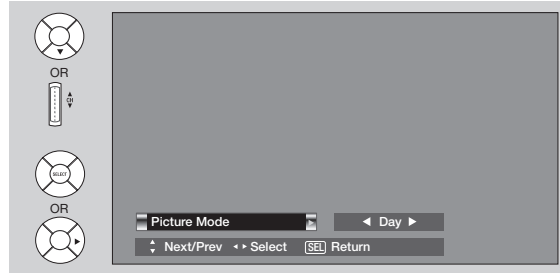
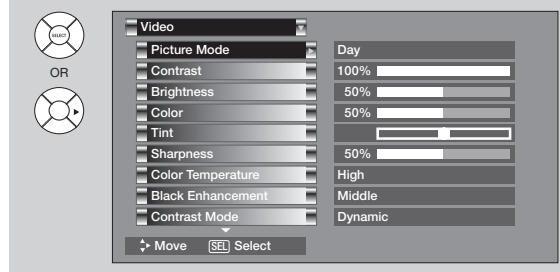

Video

Color Temperature

Set this to High for cooler color with more blue, set to Medium for more natural color, set to Standard for accurate color or set to Black/White for more reddish color.

Black Enhancement

Use this function to enhance Picture brightness in light scenes using the settings off, low, middle and high.

Contrast Mode

Use this function to choose between 2 Contrast Mode settings. Set to Dynamic for darker images more in the level of Black and set to Normal for a balanced White to Black level.

- NOTE:**
1. If **CONTRAST** is selected, you are adjusting **CONTRAST**. The additional menu items **BRIGHTNESS**, **COLOR**, **TINT**, and **SHARPNESS** can be selected and adjusted in the same manner.
 2. It may be necessary to adjust **TINT** to obtain optimum picture quality when using the **COMPONENT VIDEO Y-PbPr** input jacks.
 3. **CABLE** and **AIR** share a Video setting. Also, each of the video inputs have their own independent settings.
 4. If **CONTRAST** is set to minimum level, the OSD will be difficult to see.

Noise Reduction

The **NOISE REDUCTION** function automatically reduces conspicuous noise in the picture without degrading picture quality. Set **NOISE REDUCTION** to **OFF** if the TV experiences picture blocking. When Noise Reduction is set to High, Sharpness function is disabled (grayed out).

Auto Movie Mode

The Auto Movie Mode turns the 3:2 PULLDOWN DETECTION SPECIAL FEATURE ON or OFF. Theatrical movies are shot on film at 24 frames or still pictures per second, instead of 30 frames or 60 fields like video. When film is transferred to video for television viewing, the disparity between the two frame rates must be reconciled. This involves a process known as 3:2 pulldown.

When Auto Movie Mode is turned ON from the VIDEO menu, your Hitachi LCD Rear Projection Television will activate the circuitry for this special feature to improve video performance when watching film based sources.

- NOTE:**
1. When using Progressive Scan Component, HDMI or DVI input (ex. 480p, 740p, 1080i), Auto Movie Mode will not be available (grayed out).
 2. All video settings are independent of each other based on it's input (Cable, Air, Input 1~5, Photo Input).

Aspect

Use this function to select the Picture Format Aspect Ratio.

1. Use the **CURSOR PAD ▲** or **▼** to highlight the function to be adjusted.
2. Press the **CURSOR PAD ◀** or **▶** to select **ON** or **OFF**.
3. Press the **CURSOR PAD ◀** or **▶** to select **ASPECT MODE**.

Auto Aspect

Automatically adjust the Aspect Ratio depending on the input signal to fill the screen.

- NOTE:**
1. The Auto Aspect function is recommended on an input signal with **VIDEO ID**.
 2. The Auto Aspect function is best used on **COMPOSITE VIDEO**, **S-VIDEO**, **480i** and **480p COMPONENT/HDMI** signals.
 3. See page 23 for **ASPECT MODE** availability.

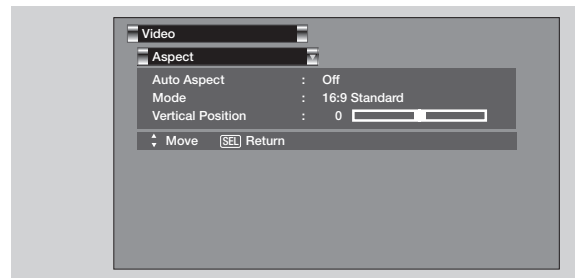

4. Press the **CURSOR PAD ◀** or **▶** to select **VERTICAL POSITION**.

Video

Vertical Position

This function allows you to select when aspect style is either **4:3 EXPANDED/ZOOM1/ZOOM2** or **16:9 ZOOM**. Vertical position can be changed with these modes. For example, it will be useful for centering the picture area at both the top and bottom of the picture with 480i/480P signal. Adjustable range is -10 (video center is toward bottom of screen) to +10 (video center is toward top of screen).

NOTE: Vertical Position will not be available in 4:3 STANDARD and 16:9 STANDARD MODES.

5. Press **MENU** to return to main menu or select **PICTURE MODE** to return to previous menu.
6. Press **EXIT** to quit menu.

Black Side Panel

The BLACK SIDE PANEL function turns the gray side bars on/off when watching 4:3 signals in Standard mode. The top/bottom gray bar will appear in SPLIT MODE PIP and SPLIT FREEZE. The TV set will always return to "Set Black Side Panel - OFF" setting every time the TV is powered "OFF".

Reset Video Settings

This function allows you to Reset the Video Menu Settings of the present input and return it to the Day VIDEO mode.

1. Use the **CURSOR PAD ▲** or **▼** to highlight the function to be adjusted.
2. Press the **SELECT** button to select **RESET VIDEO SETTINGS**.
3. Use the **CURSOR PAD ▼** to access other video settings.

You can customize each of the Video Inputs to your preference to increase viewing performance and pleasure, depending upon the video program being viewed. If **RESET** is selected, only the selected Input will reset to the initial conditions as explained above.

If **RESET** is selected in INPUT 1, only INPUT 1 will return to factory conditions.

- NOTE:**
1. If **YES** is selected, the **VIDEO MENU SETTINGS** will be reset to the original factory settings on all modes during the next power on/off
 2. Channel List, Volume level and Last-CH selection remains unchanged.

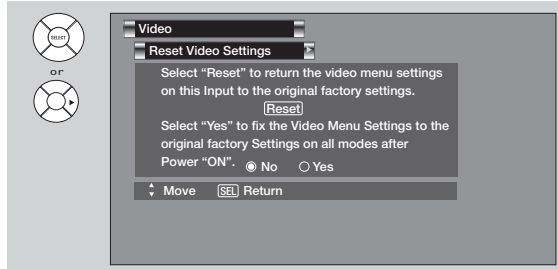
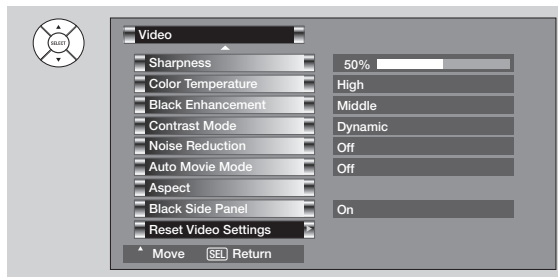

Audio

Audio

Select AUDIO to adjust the TV to your preference and to improve the sound quality.

1. Use the **CURSOR PAD** ▲ or ▼ to highlight the function to be adjusted.
2. Press the **CURSOR PAD** ◀ or ▶ to adjust the function.
3. Press **EXIT** to quit the menu or select **AUDIO** to return to the main menu.

NOTE: If **TREBLE** is selected you are adjusting **TREBLE**. The additional menu items **BASS** and **BALANCE** can be selected and adjusted in the same manner.

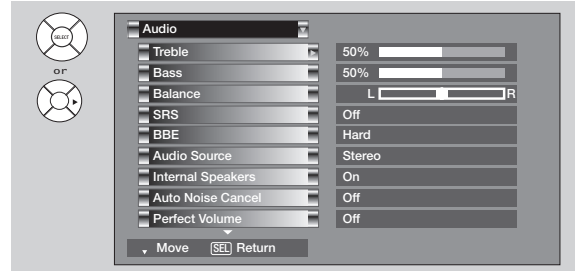

Treble

This function controls the high frequency audio to all speakers.

Bass

This function controls the low frequency audio to all speakers.

Balance

This function will control the left to right balance of the Projection TV internal speakers.

SRS

Based on the principles of the human hearing system, **SRS** technology delivers an exciting and realistic 3D Sound experience from just two external speakers (or) the two internal speakers of your **HITACHI** Television. If your **HITACHI** Television is connected to an external audio system, **SRS** will also create an incredible 3D sound experience from two speakers and even enhance a complete multi-speaker surround sound system.

SRS and the (●) symbol are trademarks of SRS Labs, Inc. SRS technology is incorporated under license from SRS Labs, Inc.

BBE

Sound reproduction quality enhancement system. The **BBE** technology produces sound that is natural and crisp from just two speakers or the two internal speakers found in your **HITACHI** television. If your **HITACHI** television is connected to an external audio system, **BBE** will also create an incredible crisp sound experience from two speakers. **BBE** brings to the listener's ear a more complete and accurate reproduction of the original performance. Each voice, speaking or singing, each instrument or sound effect is presented with its attendant harmonics or partials more clearly audible. The ear can then more easily recognize the unique tonal colors of each sound as though the sound was being produced live.

Licensed by BBE Sound, Inc. under USP5510752 and 5736897. BBE and BBE symbol are registered trademarks of BBE Sound, Inc. Manufactured under license from BBE Sound, Inc.

Audio

Audio Source

Multi-Channel Television Sound will allow you to select **STEREO** (a stereo broadcast), **MONO** (monaural sound) used when receiving a weak stereo broadcast or **SECOND AUDIO PROG (SA)** which may be a secondary language, weather report, etc.

The sources received will be displayed at the top left edge of the TV. See example to the right for each source received..

1. Press the **INFO** button to display your settings.

NOTE: 1. When a monaural (MONO) audio broadcast source is received, no label will be displayed.
 2. When a ST/SA label is displayed, the audio source being received will be both STEREO and SECOND AUDIO.

STEREO (ST)

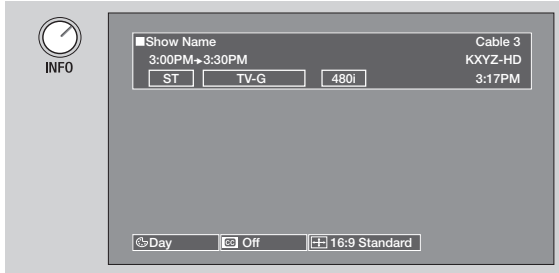

MONO

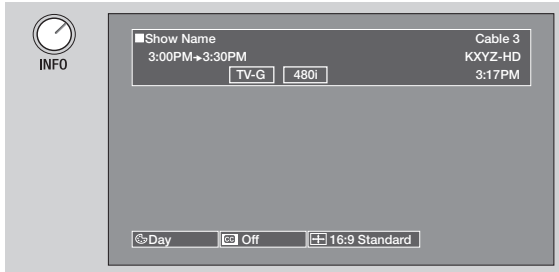

SECOND AUDIO PROGRAM (SA)

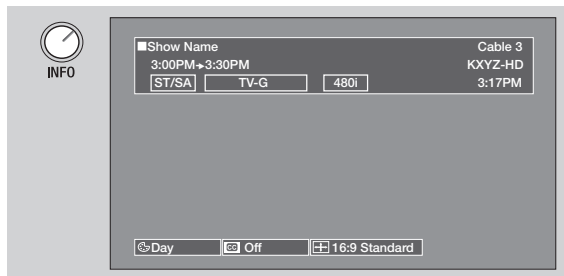

Internal Speakers

This function is useful when setting up the external speakers.

ON	Select this feature if using the internal speakers only.
TV as Center	Select this feature when setting up external speakers from a separate stereo system. The TV's speakers will work as the center speaker.
OFF	Select this feature if you prefer to use only speakers from a separate stereo system.

Auto Noise Cancel

This function eliminates the noise between stations. If a channel is tuned and is noisy, this function will automatically eliminate the audio for that channel.

Perfect Volume

This function will automatically adjust volume so each channel and input has the same average volume level.

Loudness

This function turns loudness **ON** or **OFF**. It will improve the quality of both low and high frequency sounds when listening at low volume levels.

Audio

Use the functions below if your TV is connected to an amplifier/receiver with **OPTICAL DIGITAL INPUT** with Dolby Digital or PCM decoder capabilities.

1. Use the **CURSOR PAD ▲** or **▼** to highlight the function to be adjusted.
2. Press the **CURSOR PAD ◀** or **▶** to adjust the function.
3. Press **EXIT** to quit the menu or select **AUDIO** to return to the main menu.

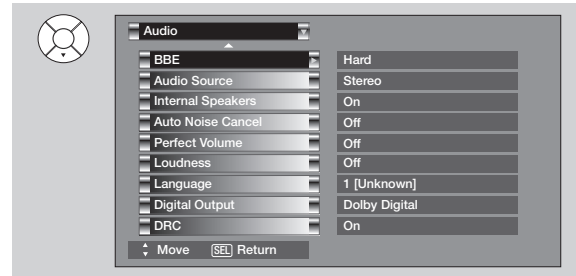
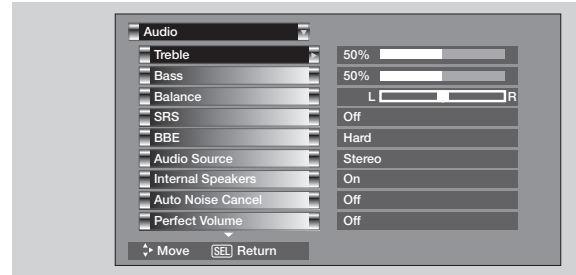

Language

Some programs transmit more than one DTV language option. Most will have English as a default language. The language function will allow you to select up to 4 language options (if available).

Digital Output

This function allows you to select between Dolby® Digital and PCM.

Dolby® Digital	Select this feature if the TV is connected to an amplifier/ receiver with a Dolby® Digital only decoder; it will provide six independent soundtrack channels through the optical output jack (Digital Audio).
PCM	Select this feature if the TV is connected to an amplifier/ receiver with a PCM only decoder; it will provide two independent soundtrack channels through the optical output jack (Digital Audio).

Manufactured under license from Dolby Laboratories. "Dolby" and the double-D symbol are trademarks of Dolby Laboratories.

DRC

Dynamic Range Compression - Use this function to compress the range of sound volume. By compressing the range of sound volume, it is possible not only to suppress the output of loud sound at night but also to raise the volume of low sound. This is only effective when the TV is connected via the optical out (digital audio) to an amplifier/receiver with a Dolby® Digital decoder. The default setting is ON. Use the **CURSOR PAD ◀** or **▶** to select the chosen options.

NOTE: These functions are only available when viewing digital programs.

TV Guide On Screen

TV Guide On Screen

The TV Guide On-Screen system is a built-in feature that provides a channel lineup and program listings in your area. Once the setup process is complete, the program listings are automatically updated several times a day. This interactive guide can also be programmed to receive listings from a cable box or record your favorite shows using a VCR.

If using a Cable Box or VCR, you must first setup the LCD Rear PTV as shown on Page 20.

To Setup the TV Guide On Screen System:

1. Press the MENU button. Use the CURSOR PAD ▲ to highlight TV GUIDE ON SCREEN, then press the SELECT button.

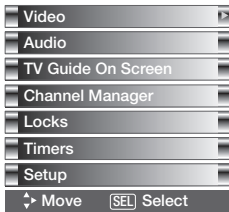

Note: Pressing the GUIDE button also allows you immediate access to this feature.

2. Press the SELECT button to continue.

Setup Procedure:

Screen 1: Select which country your TV is located in: Use the CURSOR PAD ▲ and ▼ to highlight your TV location (USA or CANADA), then press the SELECT button to continue.

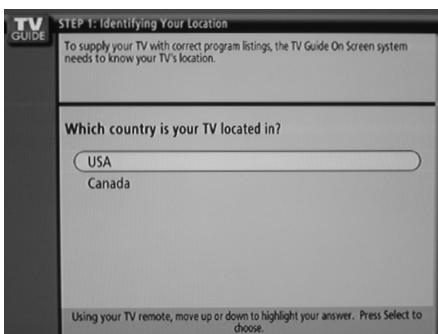

Screen 2: Enter the ZIP code (USA) or postal code (Canada):

Use the Numeric buttons and the CURSOR PAD ▲ and ▼ for letter entries to enter the ZIP code (USA) or postal code (CANADA) of your location.

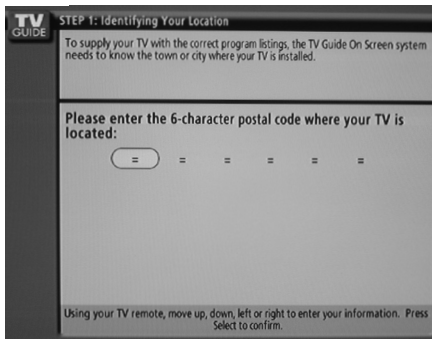
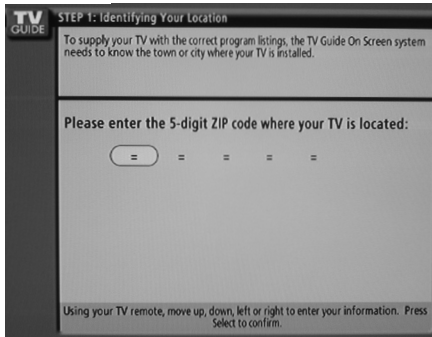

Screen 3:

Do you have Cable service connected?

Use the CURSOR PAD ▲ and ▼ to highlight your choice, then press the SELECT button to continue.

If YES: Please see Screen 4.

If NO: Please see Screen 12.

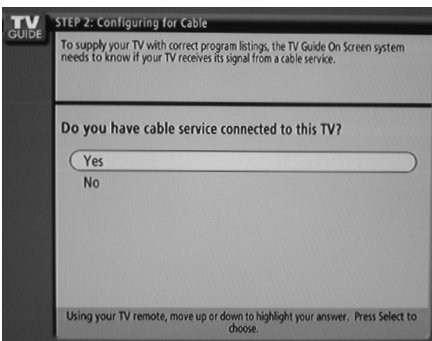

TV Guide On Screen

Screen 4:

Do you have a Cable box connected?
 Use the CURSOR PAD ▲ and ▼ to highlight your choice, then press the SELECT button to continue.
 If YES: Please see Screen 5.
 If NO: Please see Screen 12.

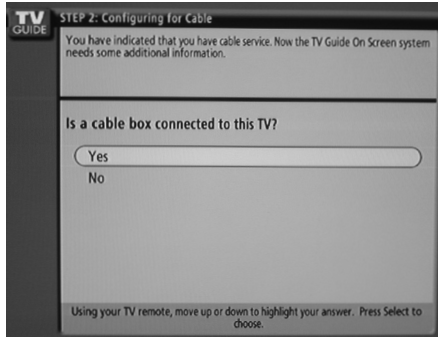

Screen 5:

Which TV input is the Cable box plugged into?
 AIR/CABLE: Please see Screen 6.
 INPUT 1/2: Please see Screen 7.

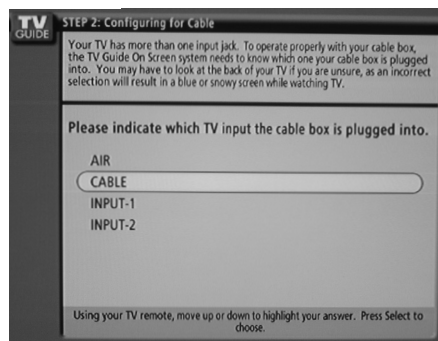

Screen 6:

Select the channel your TV is tuned to when using a Cable box. Use the CURSOR PAD ▲ and ▼ to highlight your choice, then press the SELECT button to continue.

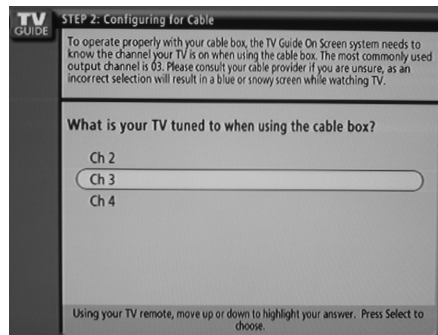

Screen 7:

This screen shows the correct way to setup the Cable box with the G-LINK. Please confirm connection (see Page 20). Press the SELECT button to continue.

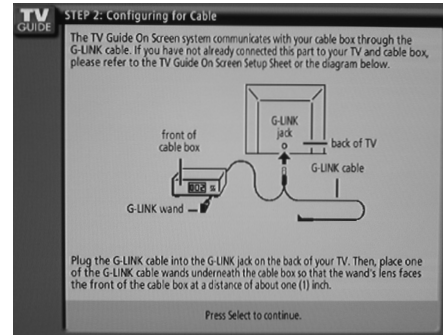

Screen 8:

Use the CURSOR PAD ▲ and ▼ to highlight your Cable box brand or choose "Not Listed" if not listed, then press the SELECT button to continue.

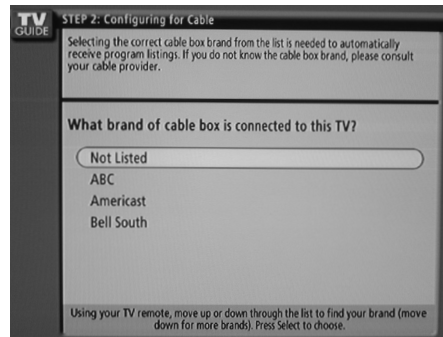

Screen 9:

To allow the TV Guide On-Screen system to find the correct code for your brand of Cable box, tune the Cable box to channel 2. Please make sure that the Cable box and TV are ON. Press the SELECT button to continue.

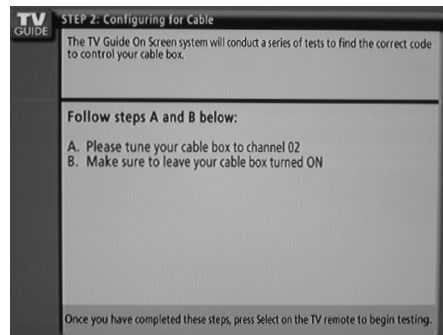

TV Guide On Screen

Screen 10:

The TV Guide On Screen system will test the code of your Cable box. No TV, Cable or remote buttons should be pressed while performing the automatic test. After the testing process is complete, the setup procedure will continue, see screen 11.

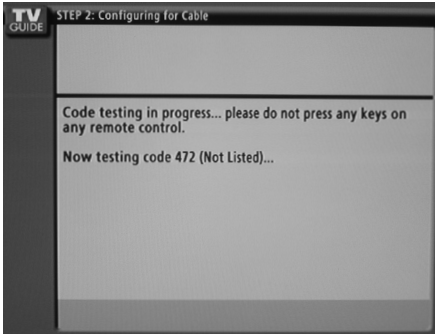

Screen 13:

Please confirm your initial settings. Use the CURSOR PAD ▲ and ▼ to highlight your choice, then press the SELECT button to continue. If YES, FINISH SETUP PROCESS: Please see screen 14. If NO, REPEAT SETUP PROCESS: Please see screen 1.

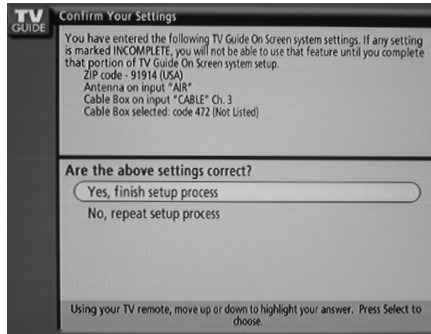

Screen 11:

Did your Cable box tune to channel 28? Use the CURSOR PAD ▲ and ▼ to highlight your choice, then press the SELECT button to continue. If YES: Please see screen 12. If NO: Select NO to test a different code or select TEST THIS CODE AGAIN to test the same code.

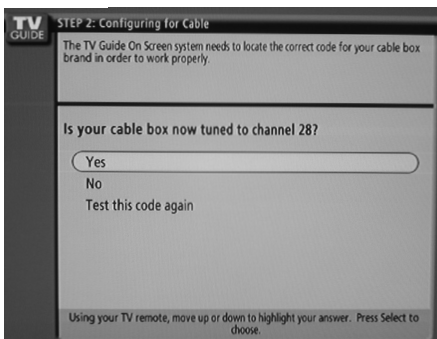

Screen 14:

The Basic TV Guide On Screen system setup has just been completed. Press the SELECT button to continue.

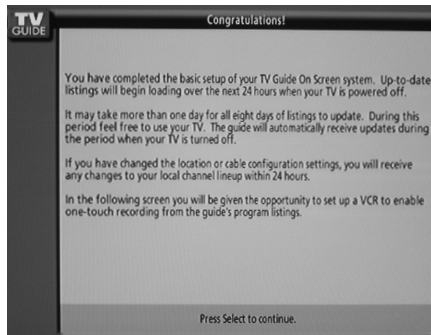

Screen 12:

Do you have an antenna connected? Use the CURSOR PAD ▲ and ▼ to highlight your choice, then press the SELECT button to continue.

NOTE: In order to receive the program listings, you must select YES in this screen if you chose NO in Screen 3.

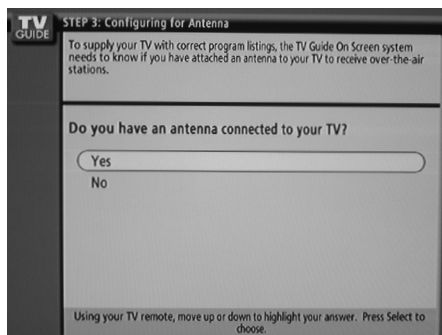

Screen 15:

Would like the TV Guide On-Screen system to control the recording of your VCR? Use the CURSOR PAD ▲ and ▼ to highlight your choice, then press the SELECT button to continue. If YES: Please see Screen 16. If NO: Please see Screen 21.

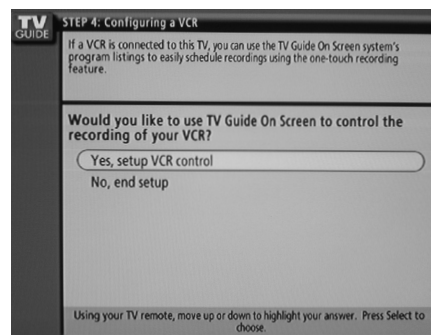

TV Guide On Screen

Screen 16:

This screen shows the correct way to setup the VCR with the G-LINK. Please confirm connection (see Page 20). Press the SELECT button to continue.

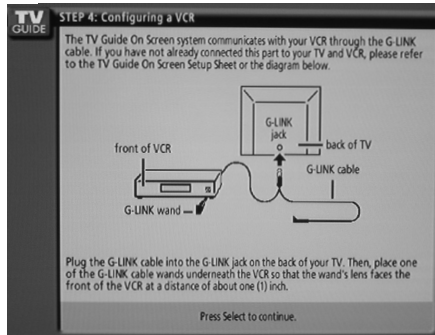

Screen 19:

The TV Guide On Screen system will test the code of your VCR. No TV, VCR or remote buttons should be pressed while performing the automatic test. After the testing process is complete, the setup procedure will continue, see Screen 20.

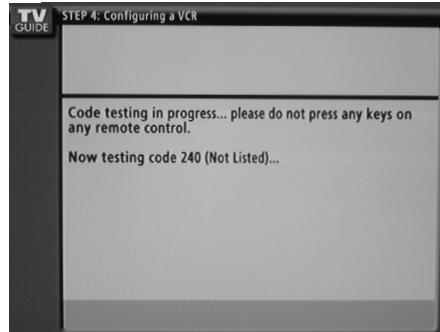

Screen 17:

Use the CURSOR PAD ▲ and ▼ to highlight your VCR brand or choose "Not Listed" if not listed, then press the SELECT button to continue.

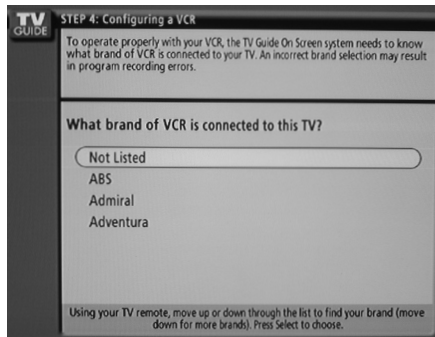

Screen 20:

Did your VCR stop playing?
Use the CURSOR PAD ▲ and ▼ to highlight your choice, then press the SELECT button to continue.
If YES: Please see screen 21.
If NO: Select NO to test a different code or select TEST THIS CODE AGAIN to test the same code.

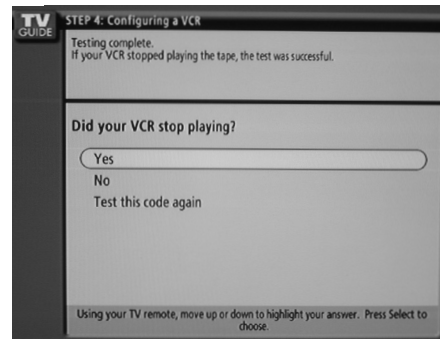

Screen 18:

Please turn on your VCR and insert a tape for recording purposes. Press PLAY from the VCR, then press the SELECT button to continue.

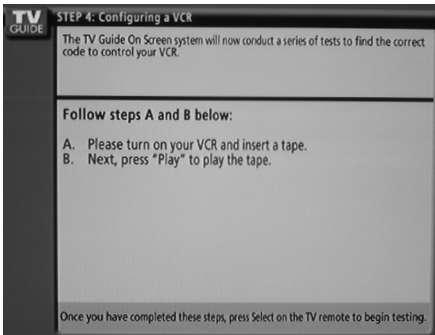

Screen 21:

Please confirm your initial settings. Use the CURSOR PAD ▲ and ▼ to highlight your choice, then press the SELECT button to continue.
If YES, FINISH SETUP PROCESS: Please see screen 22.
If NO, REPEAT SETUP PROCESS: Please see screen 1.

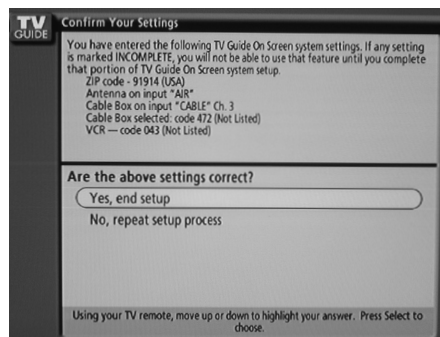

TV Guide On Screen

Screen 22:

Congratulations! The TV Guide On Screen system setup is complete. Press the SELECT button to finalize.

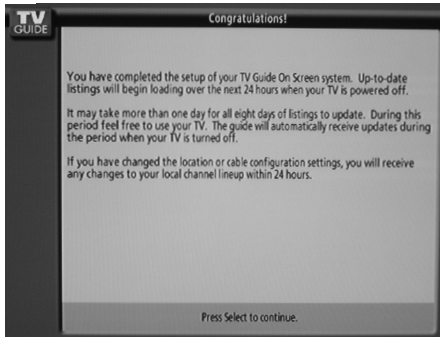

Screen 23:

The last screen gives tips on using the TV Guide On Screen system. Press the SELECT button to exit the Setup.

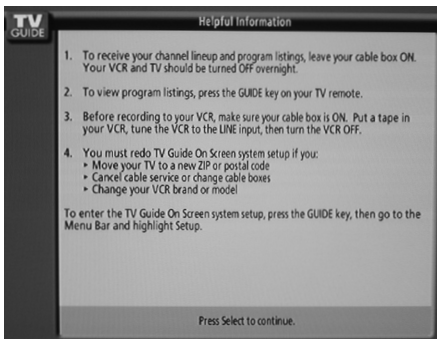

- NOTE:**
- 1. The LCD Rear PTV should be in standby mode in order to continually receive updated program listings from your cable company.*
 - 2. If using a Cable box, please leave it ON to continually receive updated program listings from your cable company.*

TV Guide On Screen

Using the TV Guide On Screen System

This free interactive program guide provides up to 8 days of TV programming. The advanced program listings make watching and recording TV shows and programs much easier.

The TV Guide On Screen system consists of 4 main services:

- **Listings:** Displays the available program listings and descriptions.
- **Search:** Allows you to find shows by keyword, alphabetically, or by program category.
- **Schedule:** Allows you to review, edit or delete "Record/Remind" events that were previously set.
- **Setup:** Allows you to make changes to System Settings, Channel Display and Default Options.

- NOTE:**
1. After initial setup it may take up to 24 hours to receive initial program listings. It may take up to one week to receive a full 8 days of program listings.
 2. The Program Guide provides listings for cable-ready, cable box, and digital cable services as well as over-the-air programs. It does not support satellite services.
 3. The Program Guide lets you directly schedule and control VCR recordings.
 4. The TV Guide On Screen representations shown in this Operating Guide are for illustration purposes only. Channels and program availability will depend on your location.
 5. If Cable and Air are both connected, channels from both antennas will be downloaded and shown grouped together in the listings.

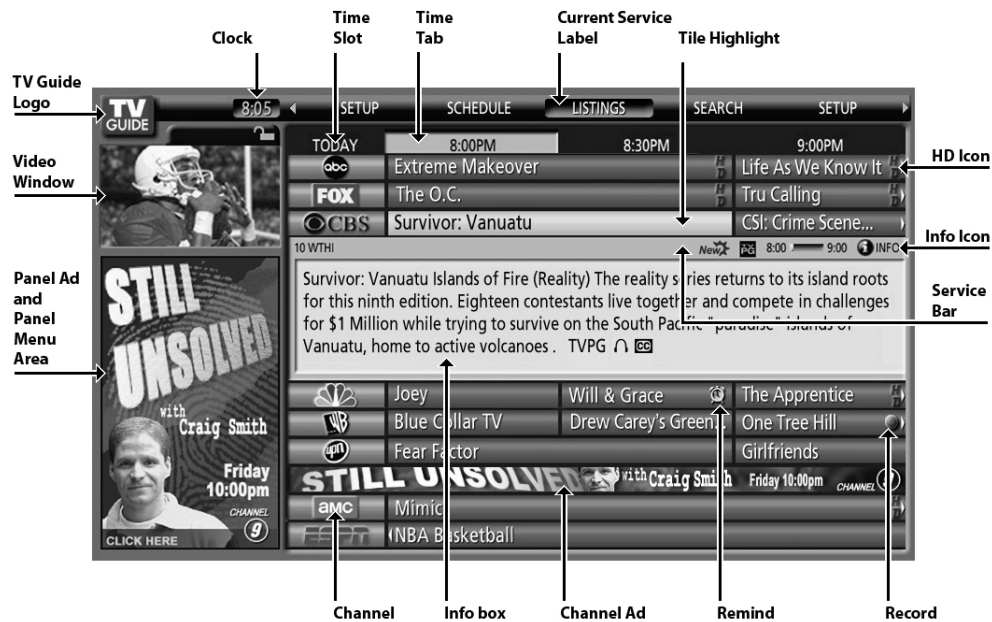

- **Video Window-** Displays the current TV program while the Guide is enabled.
- **Clock Window-** Displays the current time.
- **Tile Highlight-** Indicates the current active tile.
- **Current Services Label-** Indicates currently viewed Service Label.
- **Service Bar-** Provides access to the 4 main Guide services.
- **Time Slot-** Provides the program broadcast time frame.
- **Info Icon-** Indicates additional information is available, or the Info Box has additional sizes.
- **Info Box-** Provides information on the highlighted program.
- **Tile-** Displays the program's title.
- **Remind Icon-** Indicates the program is set to remind and the remind frequency (Once, Daily, Weekly, or Regularly).
- **Record Icon-** Indicates the program is set to record and the record frequency (Once, Daily, Weekly, or Regularly).
- **Channel Logo-** Indicates the channel logo for easy identification.
- **Panel Menu/Panel Ad-** Displays Menu options and program advertising.

TV Guide On Screen

NAVIGATING THE TV GUIDE ON SCREEN SYSTEM

- Press the GUIDE button while watching TV to access the TV Guide On Screen system. The LISTINGS screen will be presented with the current show displayed in the Video Window.
- Use the CURSOR PAD ◀, ▶, ▲, and ▼ to highlight any program, and press the SELECT button to tune to that program (if it is currently airing) or channel (if the program airs in the future). You can also press the GUIDE button to exit the Guide and automatically tune to the program displayed in the Video Window.
- Press the MENU button to access the Panel Menu where you can set reminders and recordings for the highlighted program.
- To access another Service screen:
 1. Press the MENU button to access the Panel Menu. Press the CURSOR PAD ▲ to highlight "GO TO SERVICE BAR". Press the SELECT button to jump to the Service Bar. You can also jump to the Service Bar by repeatedly pressing PAGE UP or CURSOR PAD ▲.
 2. Press the CURSOR PAD ◀ or ▶ to highlight a different Service (LISTINGS, SEARCH, SETUP and SCHEDULE).
 3. Press the CURSOR PAD ▼ to use the highlighted Service.



Video Window: Press the PIP button to Lock the Video Window to one single channel. Press the PIP button again to Unlock the Video Window so it displays the channels as you navigate through the listings.

Panel Menus: Press the MENU button to access the Panel Menus.

Info Box: Press the INFO button to access or resize the Info Box. Info Boxes contain information about a show, Service or Panel Ad, or Help information for a Panel Menu.



Remote Control Functions of the TV Guide On Screen system

Button	Function
① GUIDE	- Press to access the TV Guide On Screen system. - Press again to exit the TV Guide On Screen system.
② CHANNEL SELECTOR (Numbers)	- For Channel Tuning, Channel editing
③ (-) DIGITAL SEPARATOR	- For entering Digital Channels.
④ MENU	- Press to access the Panel Menu for other options.
⑤ INFO	- Press to cycle between levels of Information.
⑥ SELECT	- Press to enable your selection. - Press to directly tune to a currently airing program. - Press to display Panel Menu while checking future program tiles.
⑦ CURSOR PAD	- Press to navigate the Cursor.
⑧ RECORD	- Press to record current program.
⑨ PIP	- Press to toggle the Lock and Unlock feature of the Video Window.
⑩ PAGE UP / PAGE DOWN	- Rotate the Channel Wheel one click up or down to move one set of screen information up or down.

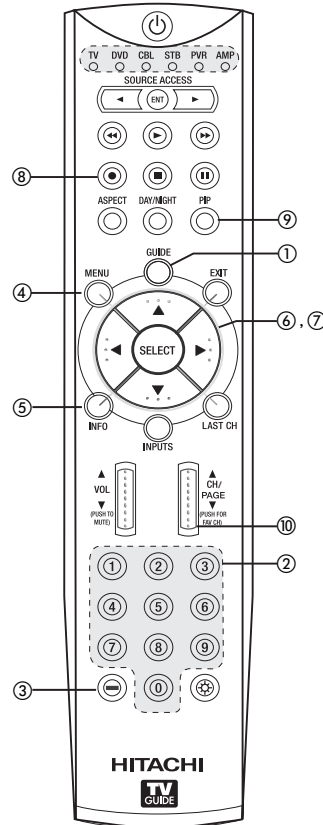

TV Guide On Screen

TV Guide On Screen Icons

Icon	NAME	DESCRIPTION
1.	Progress Bar	- Elapsed time in current program
2.	Info Icon	- Indicates Info Box has additional sizes and information.
3.	HDTV	- Program is presented in High Definition.
4.	New	- Program is new (not a repeat).
5.	CC	- Closed Captioning is available.
6.	TV Rating	- TV rating for the program.
7.	Record Once	- Program is set to record one time.
8.	Record Daily	- Program is set to record every weekday that it airs on the same channel and starts at the same time. (Only available in manual recording).
9.	Record Regularly	- Program is set to record every time it airs on the same channel and starts at the same time.
10.	Record Weekly	- Program is set to record every time it airs on the same day of the week and on the same channel, and starts at the same time.
11.	Record Off	- Program is set to record but is currently Off (Still in Schedule) until the frequency is changed.
12.	Record Suspended	- Program recording is suspended due to a schedule conflict (Still in Schedule). - The Recording will resume when the conflict no longer exists.
13.	Remind Once	- Program is set to remind one time.
14.	Remind Daily	- Program is set to remind every weekday that it airs on the channel and starts at the same time (Only available when setting a manual reminder).
15.	Remind Regularly	- Program is set to remind every time it airs on the same channel and starts at the same time.
16.	Remind Weekly	- Program is set to remind every time it airs on the same day of the week and on the same channel, and starts at the same time.
17.	Remind Off	- Program is set to remind but is currently Off (Still in Schedule) until the frequency is changed.
18.	Remind Suspended	- Program reminder is suspended due to a schedule conflict (Still in Schedule). - The Reminder will resume when the conflict no longer exists.
19.	Stereo	- Program is available in stereo.
20.	AC3 Dolby Digital	- Program is presented in High-Definition, if available.
21.	Keep Recording	- Indicates recording will not be deleted until done so by user.

TV Guide On Screen

Four (4) Services:

- LISTINGS
- SEARCH
- SCHEDULE
- SETUP

NOTE: Recording to a VCR is available in the LISTINGS, SEARCH and SCHEDULE services.

LISTINGS:

The LISTINGS service screen is always the first service displayed when accessing the TV Guide On Screen system.

Use the CURSOR PAD and SELECT buttons to navigate the LISTINGS screen.



- View current day and up to 7 days of future programs.
- Read program information.
- Press the SELECT button to tune directly to a current program.
- Lock and Unlock the Video Window.
- Set a program to remind.
- Set a program to Record.
- Access the panel ads and channel ads when available.
- Use the CHANNEL SELECTOR (Number) buttons to jump to a specific channel.

Press the INFO button while the LISTINGS service is highlighted on the Service Bar to display a Help screen.

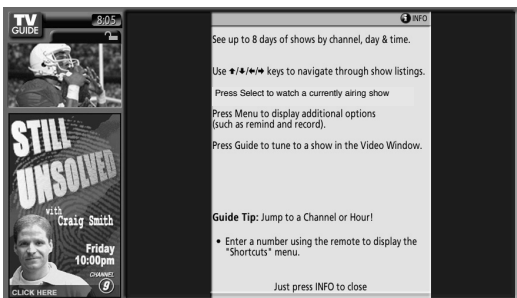

Press the MENU button while a program is highlighted to access the Episode Options Panel Menu.

EPISODE OPTIONS Panel Menu:

- Go to Service Bar
- Watch Now
- Set a recording
- Set a reminder
- Tune to the channel



GO TO SERVICE BAR:

Select to highlight the Service Bar.

TUNE TO CHANNEL / WATCH NOW:

Select to exit the TV Guide On Screen system and tune to the program or channel of the highlighted current and future program tile respectively.

SET RECORDING:

Select to display the Record Options Panel Menu from which you can set a program to record (see page 58).

SET REMINDER:

Select to display the Remind Options Panel Menu from which you can set a reminder for a program (see page 60).

CANCEL:

Select to close the menu and return to the highlighted program.

TV Guide On Screen

SEARCH:

The SEARCH service screen allows you to find programs by the following:

- Keyword
- Alphabetical
- Category
 - HDTV
 - Movies
 - Sports
 - Children
 - Educational
 - News
 - Variety
 - Series



Press the INFO button while the SEARCH service is highlighted on the Service Bar to display a Help screen.

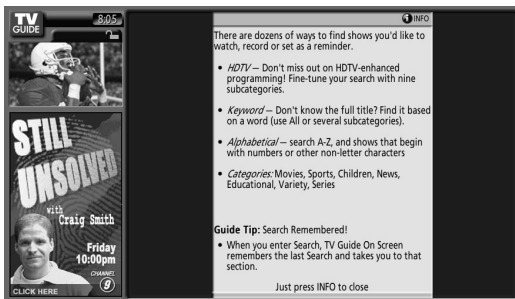

Example Category Search (Movies)

1. From the Search Screen, press the CURSOR PAD ▼ to highlight a category (Example: Movies).



2. Press the CURSOR PAD ▼ to highlight a subcategory (Example: ALL).



3. Press the SELECT button to display a list of all movies organized by date and time.



4. Use the CURSOR PAD ▲ and ▼ to highlight a current program, and then press the SELECT button to watch now. You can also press the MENU button to access the Episode Options Panel (see page 55).



TV Guide On Screen

Example: Keyword Search

The Keyword search allows you to enter a word or words to find a program title that matches.

1. From the Search Screen, use the CURSOR PAD ◀ or ▶ to highlight KEYWORD, and then press the SELECT button.
2. Use the CURSOR PAD ▲ or ▼ to highlight NEW SEARCH in the Panel Menu, and then press the SELECT button.



3. After the Search Options Panel Menu is accessed, use the CURSOR PAD ▲ or ▼ to highlight CATEGORY. Then, use the CURSOR PAD ◀ or ▶ to highlight a category to search (ALL, HDTV, Children, Sports, etc.).
4. Press the CURSOR PAD ▼ to highlight ENTER KEYWORD, and then press the SELECT button.

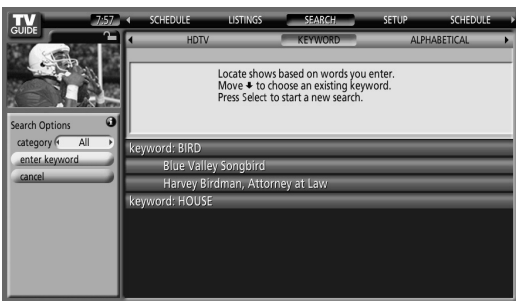

5. A keyboard is displayed. Use the CURSOR PAD ▲, ▼, ◀ and ▶ to highlight a letter, and then press the SELECT button to enter it. After entering all necessary letters, highlight DONE and press the SELECT button.

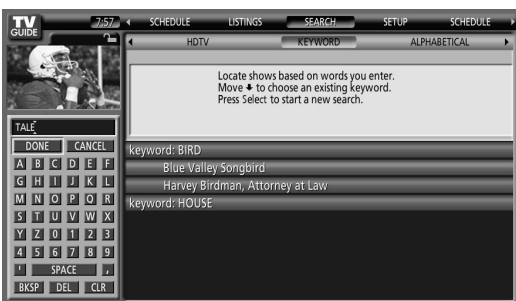

6. A list of all the shows that matched the keyword is displayed.

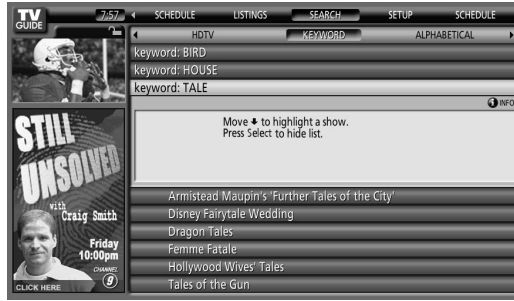

7. Use the CURSOR PAD ▲ and ▼ to highlight a program, and then press the SELECT button to display all play times. Use the CURSOR PAD ▲ and ▼ to highlight a chosen listing, then press the SELECT button to watch a current program or press the MENU button to display the Episode Options menu (see page 55).

NOTE: The TV Guide On Screen system stores up to 250 keywords.

To Edit or Delete a keyword:

From the SEARCH/KEYWORD screen, use the CURSOR PAD ▲ and ▼ to highlight the keyword you want to edit or delete. Press the MENU button to access the Search Options Panel Menu.

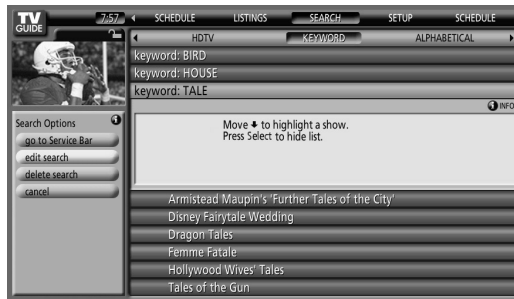

GO TO SERVICE BAR:

Select to highlight the Service Bar.

EDIT SEARCH:

Select to display the keyboard for editing the keyword.

DELETE SEARCH:

Select to display the Search Options Menu. Select "edit search" or "delete search" to exit the Panel Menu.



CANCEL:

Select to close the Panel Menu and return to the highlighted program.

TV Guide On Screen

SCHEDULE:

The SCHEDULE Service screen allows you to review, edit and delete Record and Remind events.



Press the INFO button while the SCHEDULE Service is highlighted on the Service Bar to display a Help screen.

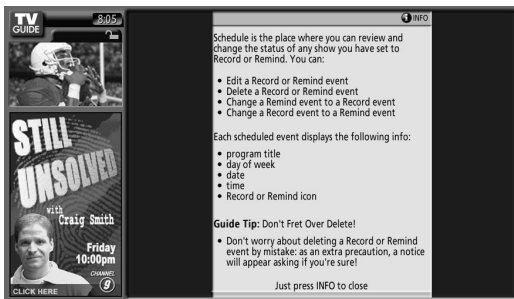

Use the CURSOR PAD ▲ or ▼ to highlight an event, and then press the MENU button to display the applicable Schedule Options Panel Menu options.

GO TO SERVICE BAR:

Select to highlight the Service Bar.

WATCH NOW/TUNE TO CHANNEL:

Select to exit the TV Guide On Screen system and tune to the highlighted program.

SET RECORDING:

Select to open a menu in which you can set a recording for the program (see page 58).

DELETE RECORDING:

Select to remove the recording from the schedule. A confirmation Panel Menu will display. Select YES to delete the recording or NO to exit the Panel Menu.

EDIT RECORDING:

Select to open a menu in which you can edit existing information (see page 58).

SET REMINDER:

Select to open a menu in which you can set a reminder for the program (see page 60).

DELETE REMINDER:

Select to remove the reminder from the schedule. A confirmation panel menu will display. Select YES to delete the reminder or NO to exit the panel menu.

EDIT REMINDER:

Select to open a menu in which you can edit existing reminder information (see page 60).

CANCEL:

Select to exit the Panel Menu.

How to Record:

The Record options can be set in the LISTINGS, SEARCH, and SCHEDULE Services. You can also edit record settings for a program in the SCHEDULE Services. There are 3 ways to set a program to record.

- Use the RECORD button on the Remote Control. Press the RECORD button to record the program Once with the current default setting. Each press of the RECORD button cycles through the RECORD frequency of Once (default), Regularly, Weekly and Cancel.

NOTE: The specific Record Icon appears on the tile each time the RECORD button is pressed.

- Use the Panel Menu record features.
1. Use the CURSOR PAD ▲ or ▼ to highlight a program and press the MENU button to access the Panel Menu.



2. Use the CURSOR PAD ▼ to highlight Set Recording and press the SELECT button to display the Record Options Panel Menu.

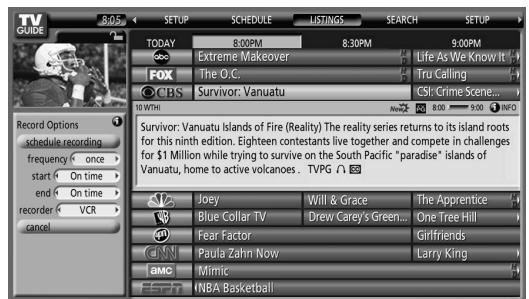

3. Use the CURSOR PAD ▲ or ▼ to highlight the Frequency field and press the CURSOR PAD ◀ or ▶ to select among Once, Regularly, Weekly or Off.
4. Press the CURSOR PAD ▼ to highlight the Start field, and then press the CURSOR PAD ◀ or ▶ to select in the range from 120 minutes early to 120 minutes late. The default time is ON Time.
5. Repeat step 4 for the End Field.

NOTE: Default options can be set for the values in the Record Options Panel menu fields (see page 63).

TV Guide On Screen

- Use Manual Recording:
 1. From the SERVICE bar, use the CURSOR PAD ◀ or ▶ to highlight the SCHEDULE. Press the MENU button to display the Schedule Options Panel Menu.



2. Use the CURSOR PAD ▲ or ▼ to highlight New Manual Recording, and then press the SELECT button to access the Record Options Panel Menu.



3. Set the information in the Panel Menu fields.
4. After completing the information in the fields, press the SELECT button to highlight SCHEDULE RECORDING, and then press the SELECT button again to exit the menu or use the CURSOR PAD ▲ or ▼ to highlight CANCEL then press the SELECT button to exit the menu.

NOTE: 1. When setting Manual recording, the option DAILY is available instead of Regularly.
2. A specific Record icon appears on the tile.

Recording Notification Banner:

If the channel you are watching is different from the one that is set to record, a notification banner appears and will prompt you before recording starts. The banner will ask you to choose to start or cancel recording. If no choice is made within 3 minutes, the banner will close automatically and the channel will tune to the one set to record. If you want the recording cancelled, select "Don't change; cancel recording" in the banner and press the SELECT button.

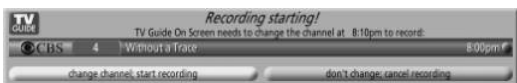

Recording Conflict:

A recording conflict message will appear if:

- A program set to record overlaps with part of another program previously set to record.
- A program set to record overlaps with the program previously set to auto-tune (see page 60). Select these options:
 - Record Anyway – The selected program will override an existing program set to record or auto-tune.
 - Don't record this show – Cancels the recording.

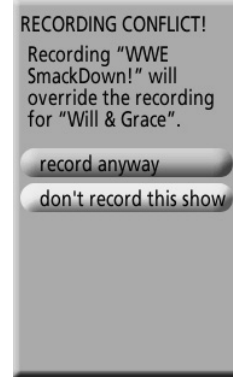
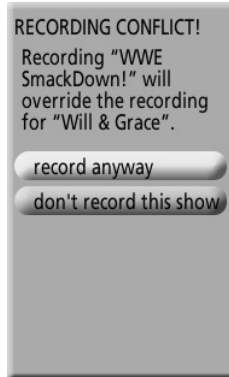

How to Remind:

The Remind options can be set in the LISTINGS, SEARCH, and SCHEDULE Services. You can also edit remind settings for a program in the SCHEDULE Services. Set the Reminder to perform the following functions.

- Set to automatically turn ON the TV and tune to the channel at the scheduled reminder time.
- Set to automatically tune the TV, at the scheduled reminder time, to the channel specified by the reminder.
- Set to display an on-screen notification banner that reminds you that the program is about to start. You will be given the choices to tune to the program channel or cancel the reminder.

TV Guide On Screen

How to set a reminder:

- Set from the Panel Menu
1. Use the CURSOR PAD ▲ or ▼ to highlight a program and press the MENU button to access the Episode Options Panel Menu.
 2. Use the CURSOR PAD ▼ to highlight SET REMINDER and press the SELECT button to access the Remind Options Panel Menu.



3. Use the CURSOR PAD ▲ or ▼ to highlight the frequency field, and then use the CURSOR PAD ◀ or ▶ to select from Once, Regularly, Weekly or Off.
4. Use the CURSOR PAD ▼ to highlight the Power on TV field, and then use the CURSOR PAD ◀ or ▶ to select YES (Turns the TV On automatically at the specified reminder time) or NO (Default setting).
5. Use the CURSOR PAD ▼ to highlight the Auto Tune TV field, and then use the CURSOR PAD ◀ or ▶ to select YES (Tunes the TV which is currently ON automatically to the channel specified at specified reminder time).
6. Use the CURSOR PAD ▼ to highlight the When field (set the time for displaying the reminder screen), and then use the CURSOR PAD ◀ or ▶ to select from 15 minutes early to 15 minutes late or On time (Default is 1 minute early).
7. Press the SELECT button to highlight Schedule reminder, and then press the SELECT button again to exit the menu or you can highlight Cancel and press the SELECT button to exit the menu.

NOTE: Default options can be set for the values of the Remind Options Panel Menu fields (see page 63).

- Set Manual reminder
1. From the Service bar, use the CURSOR PAD ◀ or ▶ to highlight SCHEDULE, and then press the MENU button to access the Schedule Options Panel Menu.
 2. Use the CURSOR PAD ▲ or ▼ to highlight New Manual Reminder and then press the SELECT button to access the Remind Options Panel Menu.



3. Use the CURSOR PAD ▲, ▼, ◀, ▶ to highlight and enter information in the panel menu fields (Date, start/end time, channel, input, power on TV, auto tune TV and frequency).
4. Press the SELECT button to highlight SCHEDULE REMINDER, and then press the SELECT button again to exit the menu or you can highlight Cancel and press the SELECT button to exit the menu.

NOTE: 1. When setting Manual Reminders, the option Daily is available instead of Regularly.
2. A specific Reminder icon appears on the tile.

TV Guide On Screen

Reminder Notification Banner

Depending on your option settings, a notification banner will appear at the scheduled reminder time.

Press the SELECT button to hide the Reminder banner, or, if more than one reminder appears, use the CURSOR PAD ▲ or ▼ to highlight a program. Press the SELECT button to tune to the program.

If no choice is made within 3 minutes, the banner closes automatically.



Remind Conflict

A remind conflict message will appear if:

- A program set with an auto-tune reminder has the same start time as an existing auto-tune reminder.
- A program set with an auto-tune reminder overlaps with a scheduled recording.

Select these options:

- Auto-Tune anyway – The selected program will override an existing program set to auto-tune.
- Proceed, No Auto-Tune – Set the program as a reminder but do not auto-tune.
- Don't set this reminder – Cancels the reminder.

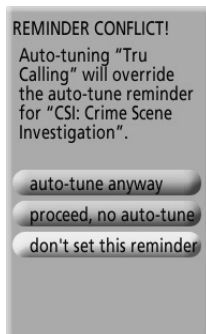
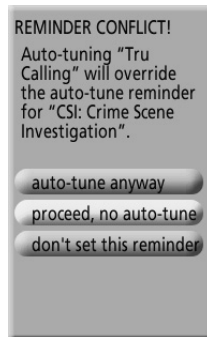
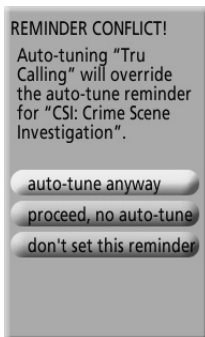

SETUP:

The SETUP Service screen allows you to modify settings that were entered at initial TV Guide On Screen system setup (see page 47). The 3 settings will be the following:

- Change System settings
- Change channel display
- Change default options

Press the INFO button while the SETUP Service is highlighted on the Service Bar to display a Help screen.

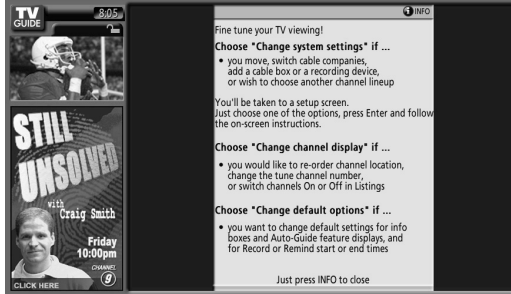

Use the CURSOR PAD ▼ to highlight a setting option, and then press the SELECT button to access each setting.

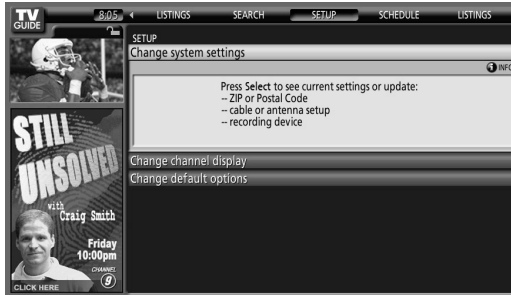

TV Guide On Screen

CHANGE SYSTEM SETTINGS:

Use this option if you want to change something after completing initial TV Guide On Screen system setup.

- From the SETUP screen, use the CURSOR PAD ▼ to highlight Change system settings, and then press the SELECT button to reconfirm your settings.

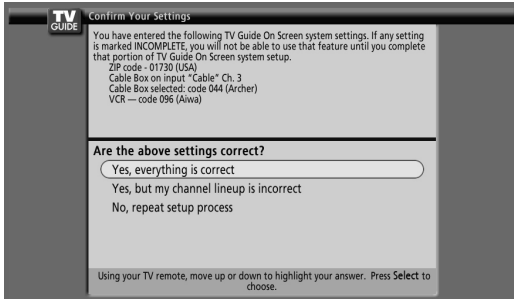
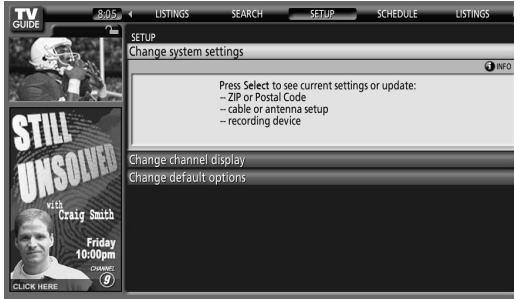

- Use the CURSOR PAD ▲ or ▼ to highlight your selected options, and then press the SELECT button. Follow the On Screen instructions.

CHANGE CHANNEL DISPLAY:

Use this option to edit channel information that appears in the LISTINGS Service screen. The channel information that can be edited includes:

- Change the position order channels appear in the LISTINGS Service screen.
- Change the tune channel number.
- Change a channel to one of the following settings:
 - ON (Channel is displayed in LISTINGS)
 - OFF (Channel is not displayed in LISTINGS)
 - AUTO-HIDE (Channel is displayed in LISTINGS only when program information is available)
- Change the service type for the source:
 - Cable
 - Cable Box
 - Over-the-Air
 - Antenna
 - Etc.

- From the SETUP Screen, use the CURSOR PAD ▼ to highlight Change Channel Display, and then press the SELECT button.



- Highlight a channel row and press the SELECT button.

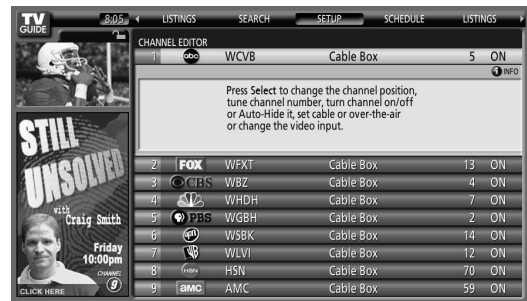

- Press the INFO button to view the On-Screen instructions.
- Use the CURSOR PAD ▲ or ▼ to highlight one of the options, and make any necessary changes, and then press the SELECT button.

NOTE: The Tune channel is the channel on which the TV receives a station depending on its type of cable, cable box, or antenna services.

TV Guide On Screen

CHANGE DEFAULT OPTIONS:

Use this option to change default settings:

- General Defaults
- Record Defaults
- Remind Defaults
- IR Defaults

GENERAL DEFAULT OPTIONS

1. From the SETUP screen, use the CURSOR PAD ▲ or ▼ to highlight Change Default Options and then press the SELECT button

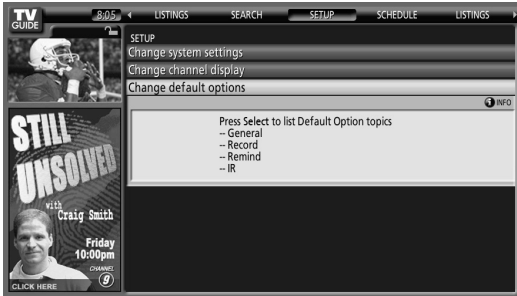

2. Use the CURSOR PAD ▲ or ▼ to highlight General Default Options, and then press the MENU button to access the General Default Options Panel Menu.

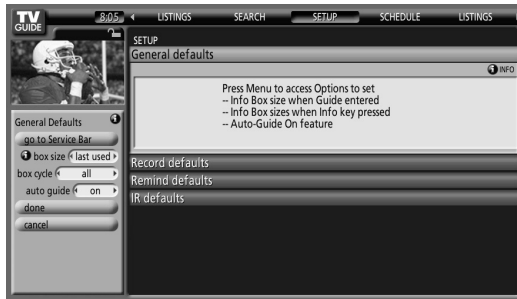

3. Enter your choices in the Panel Menu fields:

- **BOX SIZE:** The initial Info box size (No, Small, Large, and Last Used -default)
- **BOX CYCLE:** The Info Box size rotation when the INFO button is pressed. (No Only, Small Only, Large Only, No and Small, No and Large, Small and Large, and All -default).
- **AUTO GUIDE:** Automatic access into the TV Guide On Screen system when the TV is turned ON (On-default and Off).

4. Press the SELECT button to highlight Done, and then press the SELECT button again to exit the menu or use the CURSOR PAD ▲ or ▼ to highlight Cancel. Then press the SELECT button to exit the menu.

RECORD DEFAULTS

1. From the SETUP screen, use the CURSOR PAD ▲ or ▼ to highlight Change Default Options and then press the SELECT button.
2. Use the CURSOR PAD ▲ or ▼ to highlight Record defaults and then press the MENU button to access the Record Defaults Panel Menu.

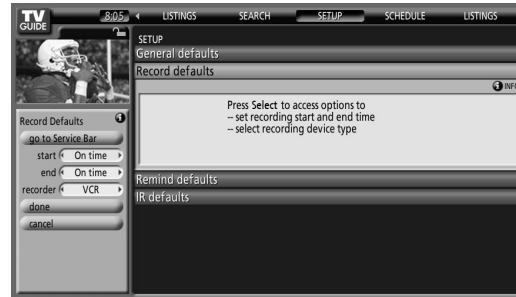

3. The following options would not appear in the panel menu and should be deleted from the list and the screen "recorder choice, how long to keep a Record event, the quality of the recording."
4. Press the SELECT button to highlight Done, and then press the SELECT button to exit the menu or use the CURSOR PAD ▼ to highlight Cancel. Then press the SELECT button to exit the menu.

REMIND DEFAULTS

1. From the SETUP screen, use the CURSOR PAD ▲ or ▼ to highlight Change Default Options and then press the SELECT button.
2. Use the CURSOR PAD ▲ or ▼ to highlight Remind defaults and then press the MENU button to access the Remind Defaults Panel Menu.



3. Enter the chosen information in the Panel Menu fields (Power On TV, auto-tune, when to display the Remind screen).
4. Press the SELECT button to highlight Done, and then press the SELECT button to exit the menu or use the CURSOR PAD ▼ to highlight Cancel. Then press the SELECT button to exit the menu.

IR DEFAULTS

IR Defaults lets you modify the channel dialing defaults if your cable box and/or VCR is not changing channels properly.

1. From the SETUP screen, use the CURSOR PAD ▼ to highlight Change Default Options and then press the SELECT button.
2. Use the CURSOR PAD ▲ or ▼ to highlight IR defaults and then press the MENU button to access the IR Defaults Panel Menu.



3. Enter the chosen information in the Panel Menu fields.
 - Cable box – if you have a cable box, indicates whether or not you want to modify the default channel dialing options. Choices are Yes and No (default).
 - Dial mode – select whether you must enter 2-digit or 3-digit (default) channel numbers to change channels on your cable box.
 - Enter key – indicate if you currently press the Enter key after you enter a channel number with your cable box remote. Choices are Yes and No (default).
 - VCR – if you have a VCR, indicates whether or not you want to modify the default channel dialing options. Choices are Yes and No (default).
 - Dial mode – select whether you must enter 2-digit (default) or 3-digit channel numbers to change channels on your VCR.
 - Enter key – indicate if you currently press the Enter key after you enter a channel number with your VCR remote. Choices are Yes and No (default).
4. Press the SELECT button to highlight Done, and then press the SELECT button to exit the menu or use the CURSOR PAD ▼ to highlight Cancel. Then press the SELECT button to exit the menu.

Channel Manager

Channel Manager

Select **CHANNEL MANAGER** to set your Antenna options, run Auto Channel Scan, Check Signal Meter and Set Channel List.

1. Use the **CURSOR PAD ▲** or **▼** to highlight the function to be adjusted.
2. Press the **SELECT** button or **CURSOR PAD ►** to select.

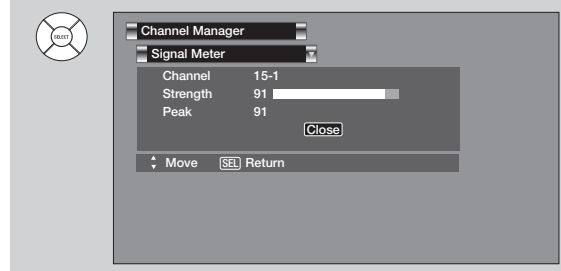
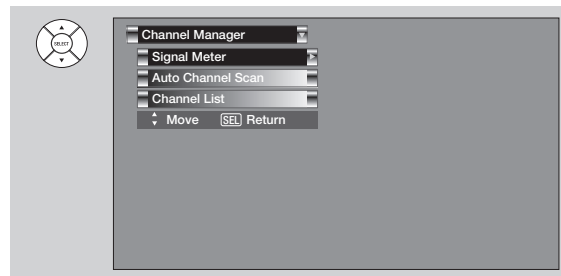
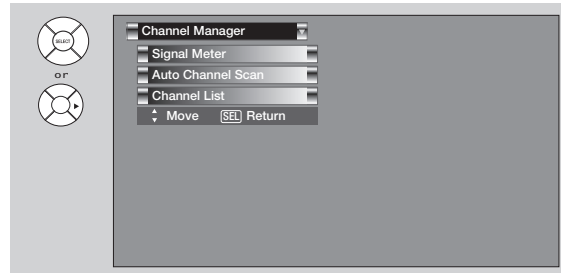
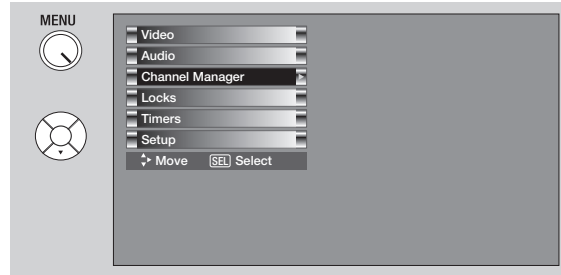

Signal Meter

Select **SIGNAL METER** when using an indoor or outdoor antenna. This feature will show the signal strength and peak values of the Antenna signal to help you adjust your antenna to optimize signal reception.

1. Use the **CURSOR PAD ▲** or **▼** to highlight **SIGNAL METER**.
2. Press the **SELECT** button to select.

NOTE: The Signal Meter will not be available (grayed out) when watching analog channels.

Channel Manager

Auto Channel Scan

This feature will automatically store active TV channels in Auto Channel Scan memory.

1. Use the **CURSOR PAD** ▲ or ▼ to highlight **CABLE** or **AIR**.
2. Press the **CURSOR PAD** ◀ or ▶ to highlight the **START** or **RESET** option.
3. Press the **SELECT** button to select.

NOTE: 1. When a CableCARD is installed, Auto Channel Scan for **CABLE** will not be available.
2. If certain channels are poor or not possible in Cable (1) mode, set cable source to Cable (2) by using the **CURSOR** buttons ◀ or ▶.

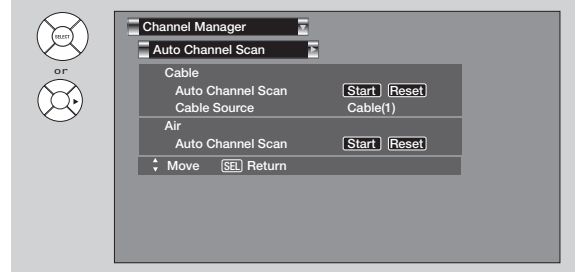
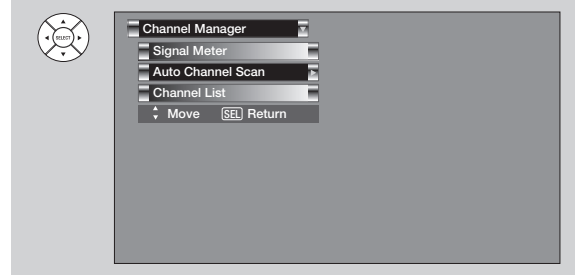

Channel List

This function allows you to review which channels are labeled (**CH ID**), which have been added to **CHANNEL MEMORY (SCAN)**, which are protected by **LOCK** and which are your **FAVORITE (FAV) CHANNELS**.

1. Use the **CURSOR PAD** to navigate the Channel List.
2. Press the **SELECT** button to select **ON** or **OFF** on the **SCAN** and **LOCK** Columns.
3. To select the **LOCK** column, input the access code. (Default access code: 0000)
4. Press the **FAV** button to set or remove the **FAVORITES** settings.
5. Press the **EXIT** button to return to normal viewing.

NOTE: 1. When a CableCARD is installed, the Channel List will be dependent on channels agreed upon by you and your cable operator.
2. The Channel List cannot be updated by only changing the Cable Source. Auto Channel Scan must also be performed for the Channel List to be updated.

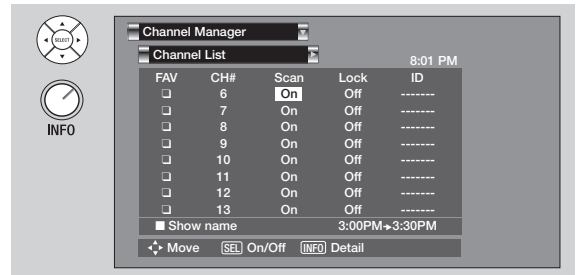

Locks

Locks

This function will block out the picture and sound of the selected channel or video input. It can also be used to keep the TV from being viewed for a scheduled time period that you set.

The code to enter the Locks feature is a four digit access code number. The factory preset code is **0000**. Use the **NUMBER** buttons to enter the access code.

1. Use the **CURSOR PAD** ▲ or ▼ to highlight the function.
2. Press the **SELECT** button to select.

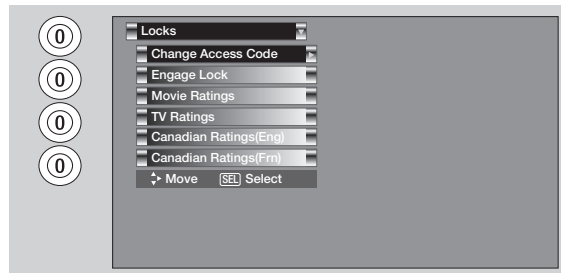
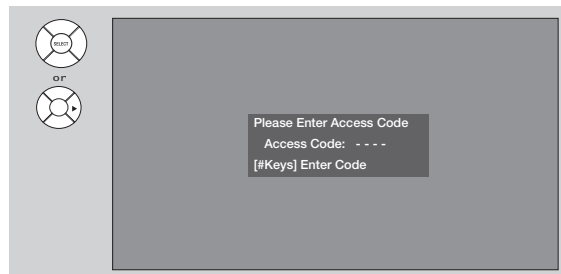

Change Access Code

1. To change the **ACCESS CODE NUMBER**, select **CHANGE ACCESS CODE** to change the factory preset code (**0000**) to your preference.

If you forget your **ACCESS CODE NUMBER**, use the factory code **7777** to erase your key number. This will reset the access code number back to the factory preset (**0000**).

2. Enter a new four digit number.
3. Press **EXIT** to quit the menu or select **CHANGE ACCESS CODE** to return to the previous menu.

Engage Lock

When **ENGAGE LOCK** is selected, **SET CHANNEL LOCK** and **SET FRONT PANEL LOCK** can be set individually.

When **SET CHANNEL LOCK** is turned on, the picture and sound for the chosen channel will be blocked out.

When **SET FRONT PANEL LOCK** is turned on, all buttons on the Front Panel will be deactivated, except the **POWER** button.

When **MOVIE RATINGS** is selected, you can block various types of movies and video tapes based on motion picture ratings. Picture-in-Picture will also be blocked automatically (see page 68).

When **TV RATINGS** is selected, various types of television programming based on a parental guide ratings will be blocked. Picture-in-Picture will also be blocked automatically (see page 69).

Use **CANADIAN RATINGS** to block various types of movies and television programs based on the two rating systems used in Canada that you feel may be inappropriate due to its content (see pages 70-71).

NOTE: If **MOVIE/TV RATINGS LOCK** function settings are **ON**, **SURF** will be deactivated.

Rear Panel Jacks

Movie Ratings

Use Movie Ratings to prevent viewing of any movie that you feel may be inappropriate due to its content.

1. Use the **CURSOR PAD** ▲ or ▼ to select the **MOVIE RATING** category that you want to block.
2. Press **SELECT** to block the **MOVIE RATING** that you have selected. Once rating is selected, for example PG-13, all movies rated PG-13 and higher (R, NC-17, and X) will be blocked.
3. Press **EXIT** to quit the menu or select **MOVIE RATING** to return to the previous menu.

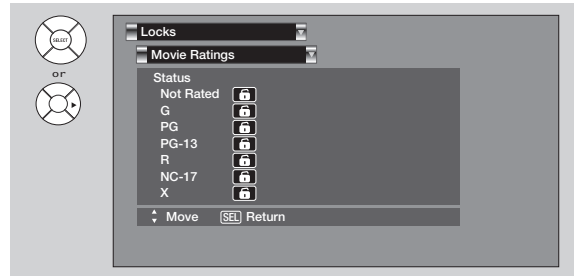
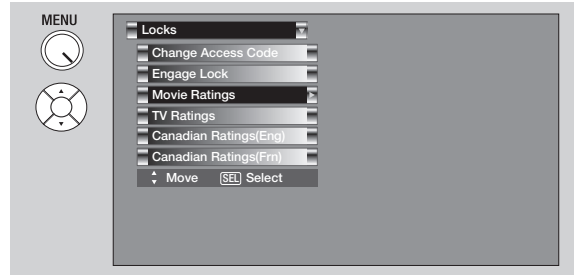

Motion Picture Ratings Table

NOT RATED	Contains no rating. Not Rated (NR) and Not Applicable (NA) programs. Movie has not been rated or ratings do not apply.
G	General audiences. All ages admitted.
PG	Parental guidance suggested. Some material may not be suitable for children.
PG-13	Parents strongly cautioned. Some material may be inappropriate for children under 13.
R	Restricted. Under 17 requires accompanying parent or adult guardian.
NC-17	No one 17 and under admitted.
X	Adults only

- NOTE:**
1. A movie rating is dependent upon the movie that is viewed. If the movie does not carry a rating, the TV will not block it.
 2. Blocking **NOT RATED** programs may block emergency programming, sports, news, public service announcements, religious programs and weather.
 3. If a CableCARD is installed, your cable operator may provide an Emergency Alert System (EAS) message in the event of a local or national emergency with the purpose of alerting the general public. When you receive such messages, the Television will immediately tune to an EAS channel as directed by the EAS message. Please be advised that if the EAS channel is blocked using the LOCKS feature, you will not be able to tune to that channel.

Locks

TV Ratings

Use **TV RATINGS** to prevent the viewing of any TV program that you feel may be inappropriate due to its content.

1. Use the **CURSOR PAD** ▲ or ▼ to select the **TV RATING** category that you want to block.
2. Press **SELECT** to block the **TV RATING** that you have selected.
3. Press **EXIT** to quit the menu or select **TV RATING** to return to the previous menu.

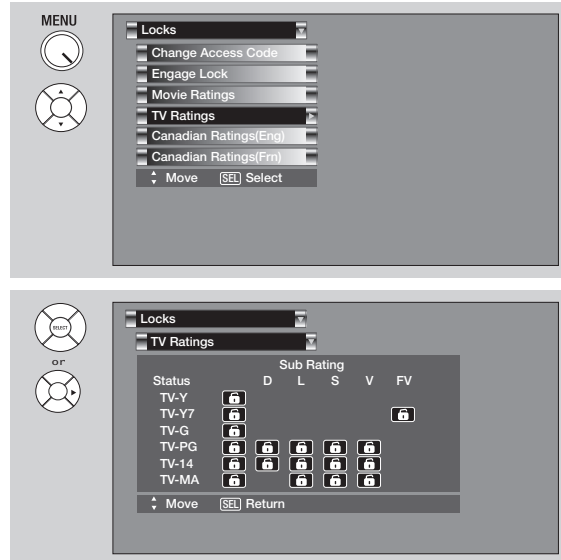

TV Parental Guide Ratings Table

TV-Y	All children. The themes and elements in this program are specifically designed for a very young audience, including children from ages 2-6.
TV-Y7	Directed to older children. Themes and elements in this program may include mild physical or comedic violence, or may frighten children under the age of 7.
TV-G	General audience. It contains little or no violence, no strong language, and little or no sexual dialogue or situations.
TV-PG	Parental guidance suggested. The program may contain infrequent coarse language, limited violence, some suggestive sexual dialogue and situations.
TV-14	Parents strongly cautioned. This program may contain sophisticated themes, intense sexual situation, more intense violence and intensely suggestive dialogue.
TV-MA	Mature audiences only. This program may contain mature themes, indecent language, graphic violence, and explicit sexual content.
FV	Fantasy Violence
V	Violence
S	Sexual Situation
L	Adult Language
D	Sexually Suggestive Dialogue

- NOTE:**
1. If you Block **TV-14D**, you will still permit **TV-MA** programs; If you block **TV-14V**, you will automatically block **TV-MAV** programs, but you will still permit **TV-MALS** programs. This means that the TV will block violence in **TV-14** and higher (**TV-MA**), but not language and sex.
 2. TV program ratings are dependent on the broadcaster. If the program is not rated, the TV will not block it.
 3. If a CableCARD is installed, your cable operator may provide an Emergency Alert System (EAS) message in the event of a local or national emergency with the purpose of alerting the general public. When you receive such messages, the Television will immediately tune to an EAS channel as directed by the EAS message. Please be advised that if the EAS channel is blocked using the **LOCKS** feature, you will not be able to tune to that channel.

Locks

Canadian Ratings (Eng)

Use **CANADIAN RATINGS (ENG)** to block any type of movie and television program in Canada that you feel might be inappropriate in its content.

1. Use the **CURSOR PAD ▲** or **▼** to select the **CANADIAN RATINGS (ENG)** category that you want to block.
2. Press **SELECT** to block the **CANADIAN RATINGS (ENG)** that you have selected. Once rating is selected, for example **C8+**, all movies and television programs rated **C8+** and higher (**G**, **PG**, **14+** and **18+**) will be blocked automatically.
3. Press **EXIT** to quit the menu or select **CANADIAN RATINGS (ENG)** to return to the previous menu.

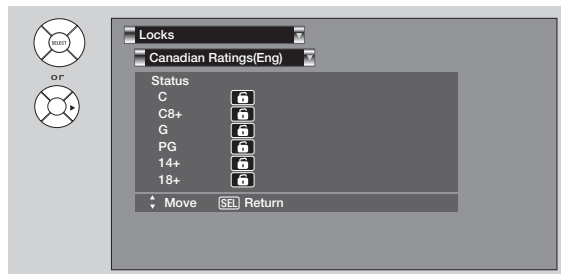

Canadian Ratings English Table

C	Programming intended for children under age 8 - Violence Guidelines; Careful attention is paid to themes, which could threaten children's sense of security and well-being. There will be no realistic scenes of violence. Depictions of aggressive behaviour will be infrequent and limited to portrayals that are clearly imaginary, comedic or unrealistic in nature. Other Content Guidelines: There will be no offensive language, nudity or sexual content.
C8+	Programming generally considered acceptable for children 8 years and over to watch on their own - Violence Guidelines: Violence will not be portrayed as the preferred, acceptable, or only way to resolve conflict; or encourage children to imitate dangerous acts which they may see on television. Any realistic depictions of violence will be infrequent, discreet, of low intensity and will show the consequences of the acts. Other Content Guidelines: There will be no profanity, nudity or sexual content.
G	General Audience - Violence Guidelines: Will contain very little violence, either physical or verbal or emotional. Will be sensitive to themes which could frighten a younger child, will not depict realistic scenes of violence which minimize or gloss over the effects of violent acts. Other Content Guidelines: There may be some inoffensive slang, no profanity and no nudity.
PG	Parental Guidance - Programming intended for a general audience but which may not be suitable for younger children. Parents may consider some content inappropriate for unsupervised viewing by children ages 8-13. Violence Guidelines: Depictions of conflict and/or aggression will be limited and moderate; may include physical, fantasy, or supernatural violence. Other Content Guidelines: May contain infrequent mild profanity, or mildly suggestive language. Could also contain brief scenes of nudity.
14+	Programming contains themes or content which may not be suitable for viewers under the age of 14 - Parents are strongly cautioned to exercise discretion in permitting viewing by pre-teens and early teens. Violence Guidelines: May contain intense scenes of violence. Could deal with mature themes and societal issues in a realistic fashion. Other Content Guidelines: May contain scenes of nudity and/or sexual activity. There could be frequent use of profanity.
18+	Adult - Violence Guidelines: May contain violence integral to the development of the plot, character or theme, intended for adult audiences. Other Content Guidelines: May contain graphic language and explicit portrayals of nudity and/or sex.

Locks

Canadian Ratings (Frn)

Use **CANADIAN RATINGS (FRN)** to block Canadian French programs according to various program ratings that you feel might be inappropriate in its content.

1. Use the **CURSOR PAD ▲** or **▼** to select the **CANADIAN RATINGS (FRN)** category that you want to block.
2. Press **SELECT** to block the **CANADIAN RATINGS (FRN)** that you have selected. Once rating is selected, for example **8 ANS+**, all movies and television programs rated **8 ANS+** and higher will be blocked automatically.
3. Press **EXIT** to quit the menu or select **CANADIAN RATINGS (FRN)** to return to the previous menu.

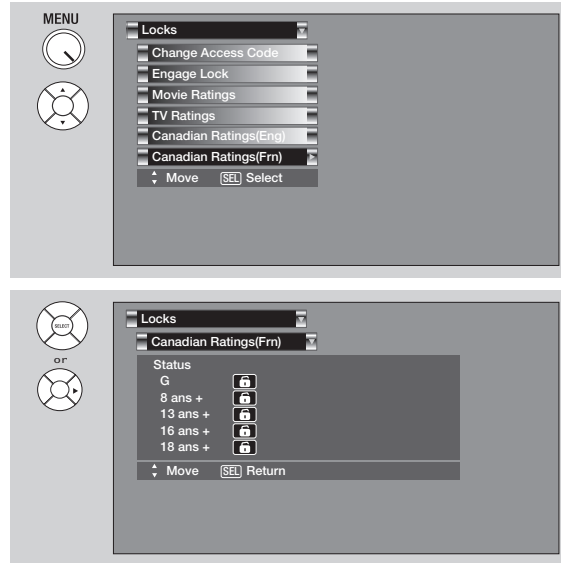

Canadian Ratings French Chart

G	General - Programming intended for audiences of all ages. Contains no violence, or the violence content is minimal or is depicted appropriately with humor or caricature or in an unrealistic manner.
8 ans +	8 + General - Not recommended for young children - Programming intended for a broad audience but contains light or occasional violence that could disturb young children. Viewing with an adult is therefore recommended for young children (under the age of 8) who cannot differentiate between real and imaginary portrayals.
13 ans +	Programming may not be suitable for children under the age of 13 - Contains either a few violent scenes or one or more sufficiently violent scenes to affect them. Viewing with an adult is therefore strongly recommended for children under 13.
16 ans +	Programming is not suitable for children under the age of 16 - Contains frequent scenes of violence or intense violence.
18 ans +	Programming restricted to adults - Contains constant violence or scenes of extreme violence.

Timers

Select **TIMERS** to set your Clock, Sleep Timer, Event Timer and Day/Night Timer Recordings.

1. Use the **CURSOR PAD ▲** or **▼** to highlight the function to be adjusted.
2. Press the **SELECT** button or **CURSOR PAD ►** to select.

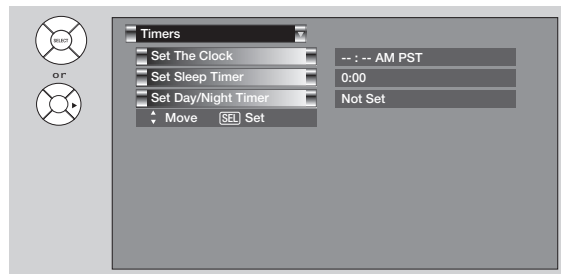
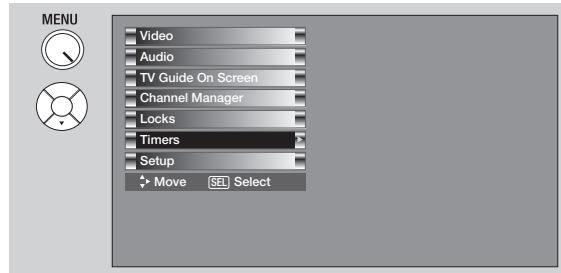

Set The Clock

The Clock must be adjusted before you can use the **SET EVENT TIMER** or **DAY/NIGHT TIMER** feature.

1. Use the **CURSOR PAD ▼** to highlight the chosen **TIME ZONE** settings. Use **CURSOR** buttons **◀** or **▶** to set **TIME ZONE** and press **SELECT** to set.
2. Press **CURSOR PAD ▼** to select Date. Use **CURSOR PAD ◀, ▶, ▲** or **▼** to set Month, Day and Year. Press **SELECT** to set.
3. Press **CURSOR PAD ▼** to select Time. Use **CURSOR PAD ◀, ▶, ▲** or **▼** to set Hour, Minute, AM or PM. Press **SELECT** to set.
4. If you observe Daylight Saving Time, press **CURSOR PAD ▼** to select **AUTOMATICALLY ADJUST CLOCK FOR DAYLIGHT SAVINGS CHANGES** and press **SELECT** to set.

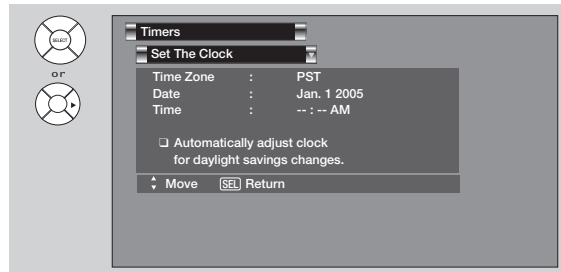
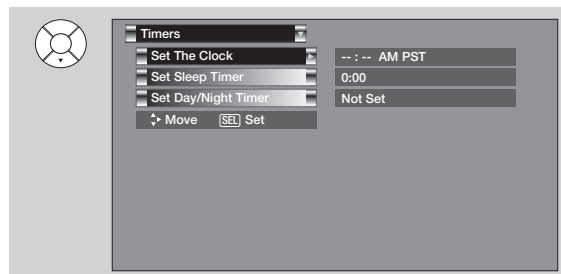

5. Press **EXIT** to quit the menu or select **SET THE CLOCK** to return to the previous menu.

NOTE: 1. When **AUTOMATICALLY ADJUST CLOCK FOR DAYLIGHT SAVING CHANGES** is checked , the TV will automatically calculate the clock adjustment for Daylight Saving.
 2. When the CableCARD is used, the TV will **SET THE CLOCK** automatically.
 3. The TV counts electrical pulses for regulating the **TIMERS**. When the power cord is unplugged then plugged in quickly, the clock is stopped momentarily and the **TIME** indication will become slow.

Timers

Set Sleep Timer

Select this feature to set your **SLEEP TIMER** from 30 minutes to 3 hours (30 minute increments).

1. Press the **CURSOR PAD** ◀ or ▶ repeatedly to set your Timer from **0:00**, **0:30**, **1:00**, **1:30**, **2:00**, **2:30** and **3:00**.

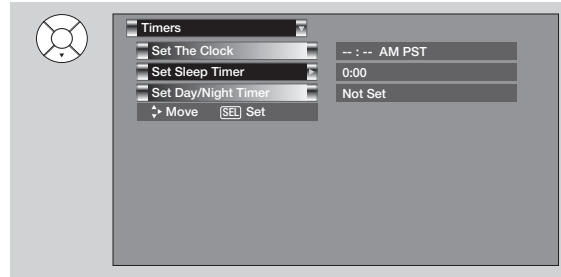

Set Day/Night Timer

Select this feature to activate and set your TV's **DAY/NIGHT PICTURE MODE** automatically.

1. Use the **CURSOR PAD** ▼ to select **ACTIVATE**. Press **SELECT** button to set (a check mark will appear in the box).
2. Use the **CURSOR PAD** ▼ to select **DAY MODE ON**. Using **CURSOR PAD** ◀, ▶, ▲ or ▼, set the **ON TIMER**. Press the **SELECT** button to set.
3. Use the **CURSOR PAD** ▼ to select **DAY MODE OFF**. Using **CURSOR PAD** ◀, ▶, ▲ or ▼, set the **OFF TIMER**. Press the **SELECT** button to set.
4. Press **EXIT** to quit the menu or select **SET DAY/NIGHT TIMER** to return to the previous menu.

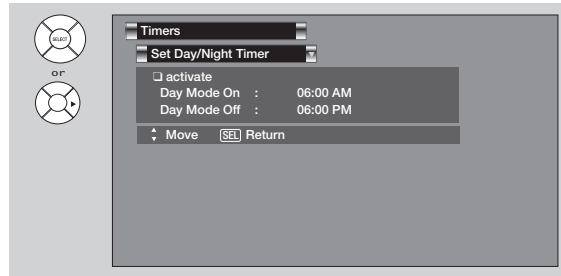
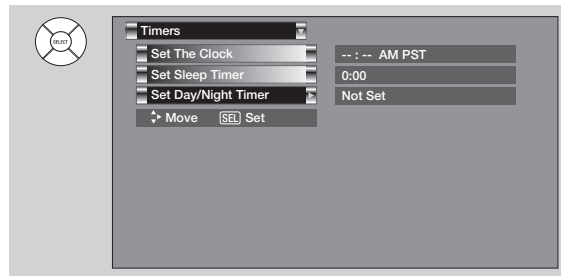

NOTE: When the clock is changed in the **SET THE CLOCK** function, this feature is disabled.



Select **SETUP** when setting your TV up for the first time.

1. Use the **CURSOR PAD** ▲ or ▼ to highlight the function to be adjusted.
2. Press the **SELECT** button or **CURSOR PAD** ► to select.

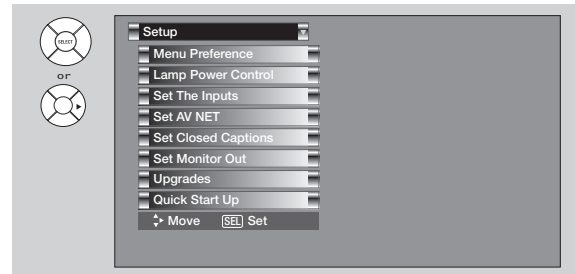

Menu Preference

This feature will allow you to select any one of three different languages for all on-screen displays.

Set the Language

This function allows you to choose from three menu languages.

1. Use the **CURSOR PAD** ◀ or ▶ to highlight the language of your choice.
2. Press **EXIT** to quit menu or select **MENU PREFERENCE** to return to previous menu.

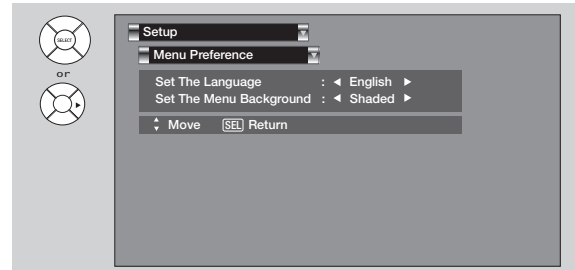
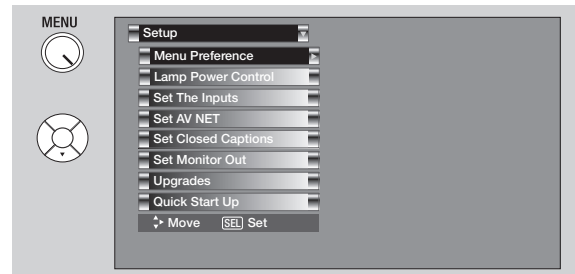

Set the Menu Background

This function allows you to choose from two menu backgrounds.

1. Use the **CURSOR PAD** ◀ or ▶ to highlight **SET THE MENU BACKGROUND (SHADED OR SOLID)**.
2. Press **EXIT** to quit menu or **CURSOR PAD** ◀ to return to previous menu.
3. Select **SOLID** for a black background (no picture can be seen behind menu screen), or select **SHADED** for a light background.

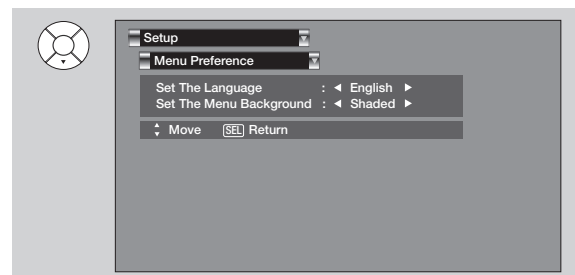

Setup

Lamp Power Control

Use this feature to have the TV turned OFF automatically when a video signal is not detected for 15 minutes.

1. Press the **CURSOR PAD** ◀ or ▶ to highlight Yes or No.

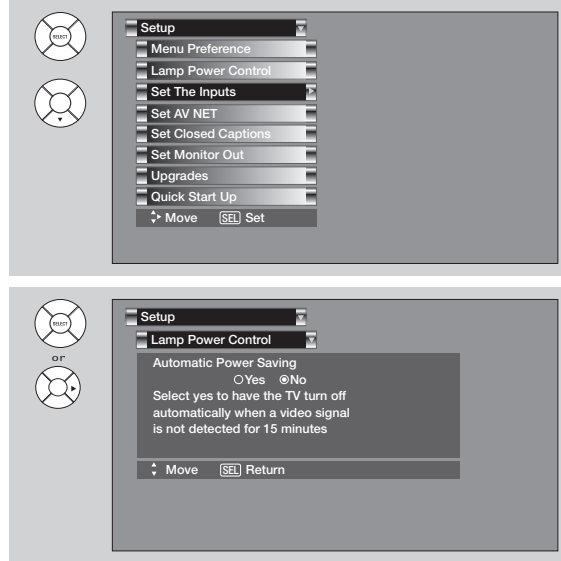

NOTE: Your new HDTV has a built-in Automatic Power Saving feature that shuts Off the TV if a video signal is not detected within 15 minutes. The default setting for this feature is ON (Yes). The Automatic Power Saving feature needs to be set to OFF (No) before any CableCARD set up can be performed.

INSTRUCTIONS:

1. Access the Menu OSD by press the MENU button of the remote control.
2. Navigate the menu to access SETUP, then LAMP POWER CONTROL. SET AUTO POWER SAVING OFF (No) using the Cursor and the SELECT buttons of the remote control.
3. Use the Cursor buttons to highlight "No" then press the SELECT button to set this feature to Off.
4. After CableCARD set up is completed, set the Auto Power Saving feature to ON (Yes).

Set The Inputs

Use this feature to give a name to any of the five video inputs. A named input is shown in the **INPUTS** menu.

1. Press the **CURSOR PAD** ◀, ▶, ▲ or ▼ to highlight the name of the video inputs.
2. Select from one of the following choices to set an input name:
A/V Receiver, DVD, DVD2, VCR, VCR2,
Cable (STB), Satellite, PVR, DVD Recorder,
CAM, LB, Gray out (Skip), Hide (Skip)

Note: The inputs labeled Gray out (Skip) or Hide (Skip) are disabled in the INPUTS selection.

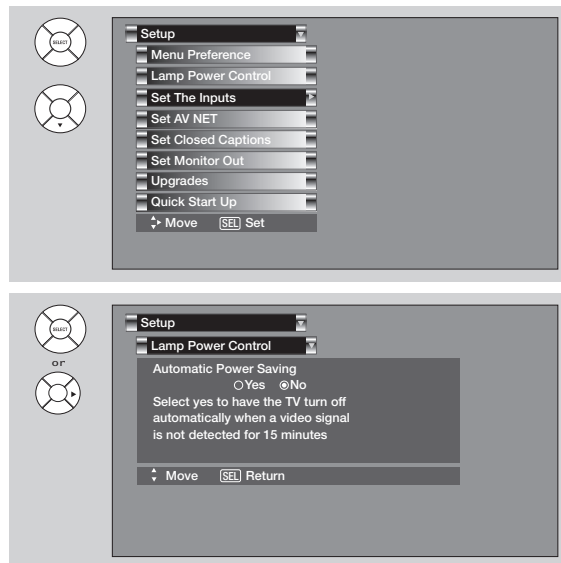

Setup

INPUT 4 Auto Link

Use this function to automatically turn the TV on and tune to Input 4 when it detects a video signal to Input 4.

1. Use the **CURSOR PAD** ◀ or ▶ to highlight the **AUTO LINK** setting of your choice.
2. When **AUTO** is selected, the TV will turn on and tune to INPUT 4 automatically, when the INPUT 4 input device is turned on. This is convenient when you want to watch a movie with your VCR, laserdisc player or DVD player.
3. When **REMOTE** is selected, the TV will turn on and switch to Input 4 automatically when the Input 4 input device is turned on and the VCR, laserdisc, or DVD play button on your remote control is pressed. This is convenient when you want to record a movie with your VCR and watch it later.
4. Select **OFF** to disable this function.
5. Press **EXIT** to quit menu or select **AUTO LINK** to return to previous menu.

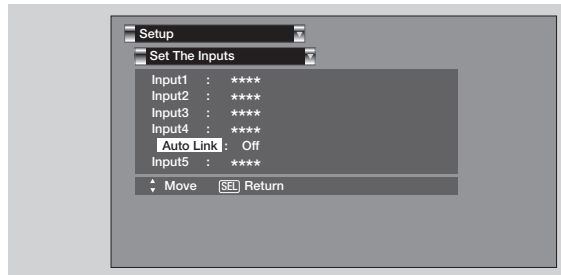

NOTE: 1. Once the TV has been turned on using the **AUTO LINK** feature, it must be reset before **AUTO LINK** is used again. To do this, turn your VCR, laserdisc or DVD player OFF. This feature is now reset and will turn on your TV as described above.
2. When using **REMOTE** mode, any remote control button will substitute for your video input device play button. However, intended operation is for use with your VCR, laserdisc, or DVD play button.
3. If no remote control button is pressed after the TV is turned on by **AUTO LINK**, the TV will automatically turn off after three hours.

Set AV Net

Use this feature to control your external Audio/Video equipment using your HITACHI LCD Rear PTV Remote Control. The IR Mouse cable must be properly connected for the AV NET feature to work.

1. Press the **MENU** button.
2. Use the **CURSOR PAD** ▼ or **CHANNEL WHEEL** to highlight **SETUP**.
3. Press the **SELECT** button to select.
4. Use the **CURSOR PAD** ▼ or **CHANNEL WHEEL** to highlight **SET AV NET** feature.
5. Press the **SELECT** button to select.

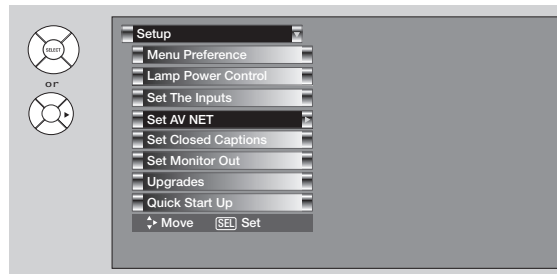
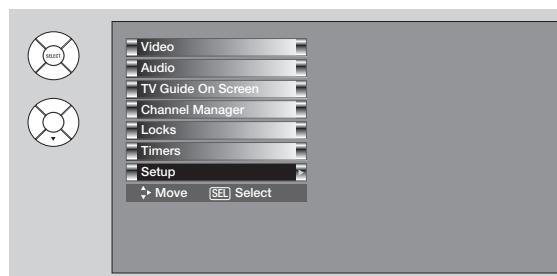

AV NET SETUP WIZARD (Example: A/V RECEIVER Setup)

1. Press the SELECT button to start the SETUP WIZARD.



2. Use the CURSOR PAD ▲ or ▼ to highlight YES or NO.
3. Press the SELECT button to select "YES". (Select YES to setup an A/V Receiver or NO to setup other devices).
4. Use the CURSOR PAD ◀, ▶, ▲ and ▼ to highlight NEXT, then press the SELECT button to move on to the next SETUP screen.

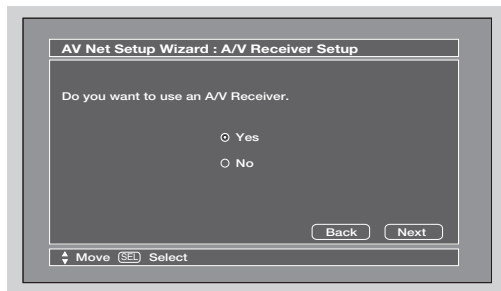

5. Use the CURSOR PAD ◀ or ▶ to choose the brand name of your A/V Receiver.
6. Use the CURSOR PAD ◀, ▶, ▲ and ▼ to highlight NEXT, then press the SELECT button to move on to the next SETUP screen.

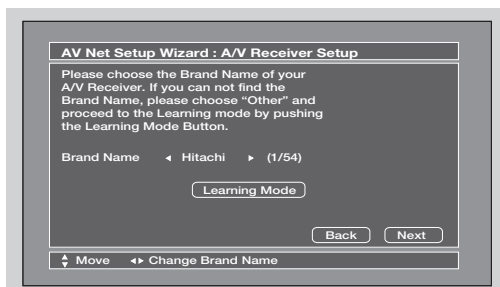

7. Use the CURSOR PAD ◀ or ▶ to choose the preset IR Code.
8. Use the CURSOR PAD ▼ to highlight the "POWER" Test button. These On-screen buttons are called "Soft Keys".
9. Press the SELECT button to pass the Power command through the IR Mouse and onto the A/V Receiver (Repeat steps 7 to 9 until finding the IR code that will power up the A/V Receiver. If the A/V Receiver turns ON, then you have found the correct preset IR code).

10. Use the CURSOR PAD ◀, ▶, ▲ and ▼ to highlight NEXT, then press the SELECT button to move on to the next SETUP screen.

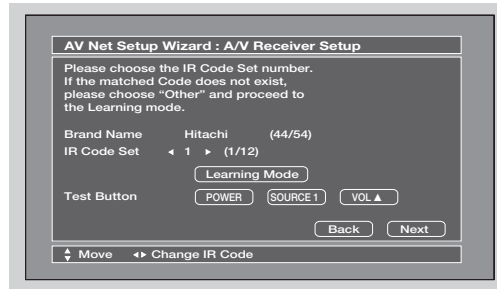

11. Use the CURSOR PAD ◀ or ▶ to select the TV Input that connects to the video and audio output of the A/V Receiver.
12. Use the CURSOR PAD ◀, ▶, ▲ and ▼ to highlight NEXT, then press the SELECT button to move on to the next SETUP screen.



13. Use the CURSOR PAD ◀ or ▶ to select the A/V Receiver Source if you have connected the Monitor Out and Optical Out to the A/V receiver. Select " Not Connected " if not used.
14. Use the CURSOR PAD ◀, ▶, ▲ and ▼ to highlight NEXT, then press the SELECT button to move on to the next SETUP screen.

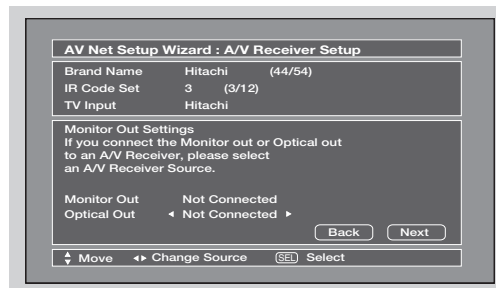

- If you would like to label your A/V Receiver Source, use the CURSOR PAD ◀ or ▶ to highlight “ Yes “ then press the SELECT button to continue. Selecting “ No “ will bypass the Source labeling.

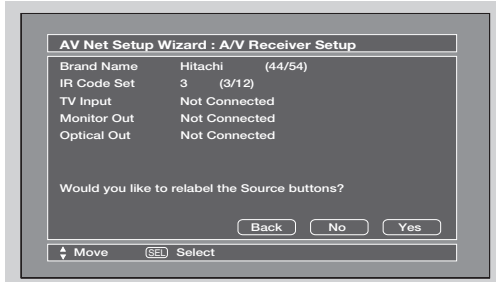

- Use the CURSOR PAD ▲ or ▼ to select your A/V Receiver Sources.
- Use the CURSOR PAD ◀ or ▶ to label your A/V Receiver Sources.
- Use the CURSOR PAD ◀, ▶, ▲ and ▼ to highlight NEXT, then press the SELECT button to move on to the next SETUP screen.

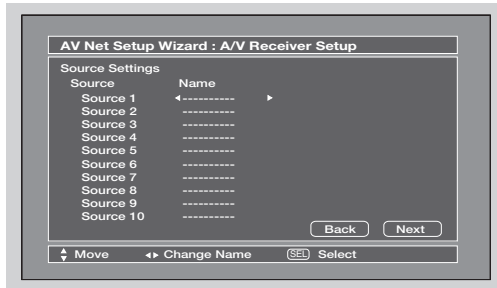

- Confirm all settings, then press the SELECT button to move on to the next SETUP screen.



- Press SELECT to setup another device or use the CURSOR PAD ◀ or ▶ to highlight “ No thanks, I'm done “, then press the SELECT button to exit the A/V NET SETUP.



AV NET SETUP WIZARD (Example: DVD Setup)

- Press the SELECT button to start the SETUP WIZARD.



- Use the CURSOR PAD ▲ or ▼ to highlight NO.
- Press the SELECT button to select. (Select NO to setup other devices).
- Use the CURSOR PAD ◀, ▶, ▲ and ▼ to highlight NEXT, then press the SELECT button to move on to the next SETUP screen.

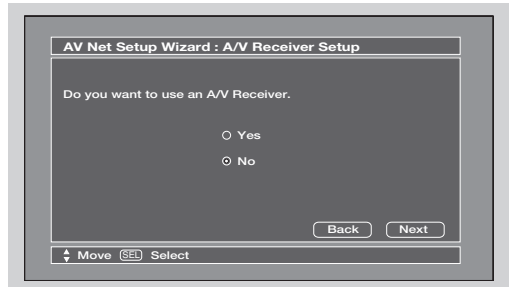

- Use the CURSOR PAD ◀, ▶, ▲ and ▼ to highlight the device. (Example : DVD Setup).
- Press the SELECT button to select.
- Use the CURSOR PAD ◀, ▶, ▲ and ▼ to highlight NEXT, then press the SELECT button to move on to the next SETUP screen.



Setup

8. Use the CURSOR PAD ◀ or ▶ to choose the brand name of your DVD.
9. Press the CURSOR PAD ▼ to highlight the IR CODE Set, then use the CURSOR PAD ◀ or ▶ to choose the preset IR Code.
10. Use the CURSOR PAD ▼ to highlight the “POWER” Test button. These On-screen buttons are called “Soft Keys”.
11. Press the SELECT button to pass the Power command through the IR Mouse and onto the DVD.
(Repeat steps 9 to 11 until finding the IR code that will power up the A/V Receiver. If the DVD turns ON, then you have found the correct preset IR code.)
12. Use the CURSOR PAD ◀, ▶, ▲ and ▼ to highlight NEXT, then press the SELECT button to move on to the next SETUP screen.



13. Use the CURSOR PAD ◀ or ▶ to select the TV Input that connects to the video and audio output of the DVD.
14. Use the CURSOR PAD ◀, ▶, ▲ and ▼ to highlight NEXT, then press the SELECT button to move on to the next SETUP screen.



15. Confirm all settings, then press the SELECT button to move on to the next SETUP screen.



16. Press the SELECT button to select YES to Setup another device. Press the CURSOR PAD ◀ or ▶ to highlight “No thanks, I'm done”, then press the SELECT button to exit the AV NET SETUP.



Learning Mode

This function of the AV NET allows the user to use equipment that is not supported by the AV/NET codes. After programming your equipment to the AV NET and the Soft Keys do not work, you can manually “LEARN” each one by completing the Learning Mode. The Learning Mode will transfer any remote control button IR code of your equipment to the “Soft Keys” of your AV NET.

Learning Mode (Example: A/V Receiver Setup)

1. Press the SELECT button to start the SETUP WIZARD.



2. Use the CURSOR PAD ▲ or ▼ to highlight YES.
3. Press the SELECT button to select.
4. Use the CURSOR PAD ◀, ▶, ▲ and ▼ to highlight NEXT, then press the SELECT button to move on to the next SETUP screen.

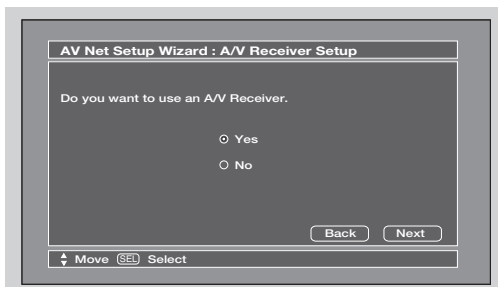

Setup

- Use the CURSOR PAD ◀ or ▶ to select "Other" from brand name choices.
- Use the CURSOR PAD ▲ or ▼ to highlight "Learning Mode" then press the SELECT button.

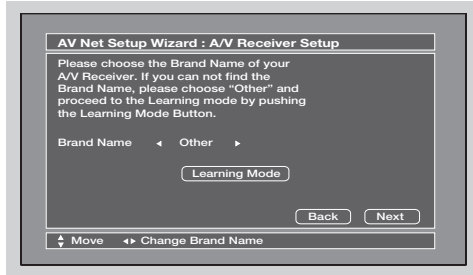

- Use the CURSOR PAD ◀, ▶, ▲ and ▼ to select the Soft Key to learn (Ex. VOL ▲), then press the SELECT button.

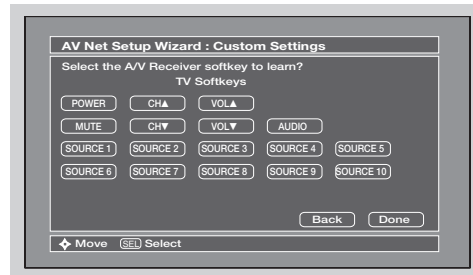

- Press and hold the VOL ▲ button of your A/V Receiver remote control while pointing directly at the learning AV NET sensor of the LCD TV (located at the lower right corner of the screen) at a distance of 5 to 10 feet or 2 to 3 meters.



- If the IR code transfer was not completed, the screen below appears. Repeat step 8 to try again.



- If the IR code transfer was successful, the screen below appears, then select "OK" to continue setup.



- Select another Soft Key to learn or select DONE to move on to the next screen.

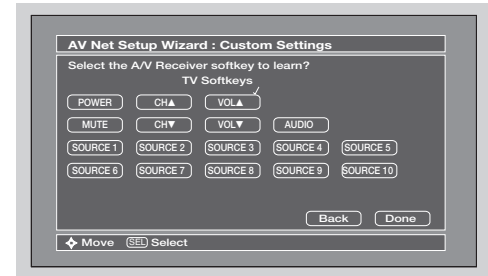

- Select the Test button VOL ▲ to check the response of the device to this command.
- Use the CURSOR PAD ◀, ▶, ▲ and ▼ to highlight NEXT, then press the SELECT button to move on to the next SETUP screen.

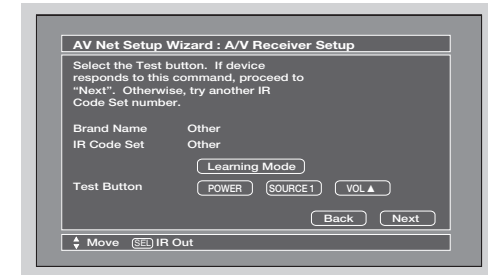

- Use the CURSOR PAD ◀ or ▶ to select the TV Input that connects to the video and audio output of the A/V Receiver.
- Use the CURSOR PAD ◀, ▶, ▲ and ▼ to highlight NEXT, then press the SELECT button to move on to the next SETUP screen.



- Use the CURSOR PAD ◀ or ▶ to select the A/V Receiver Source if you have connected the Monitor Out and Optical Out to the A/V Receiver. Select "Not Connected" if not used.
- Use the CURSOR PAD ◀, ▶, ▲ and ▼ to highlight NEXT, then press the SELECT button to move on to the next step.



- If you would like to label your A/V Receiver Source, use the CURSOR PAD ◀ or ▶ to highlight "Yes", then press the SELECT button to continue. Selecting "No" will bypass the Source Labeling.

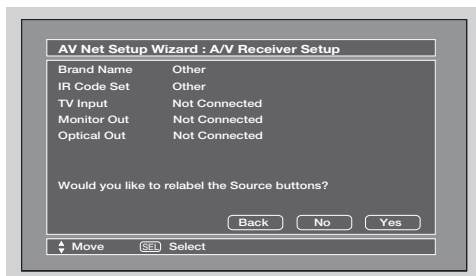

- Use the CURSOR PAD ▲ or ▼ to select your A/V Receiver Sources.
- Use the CURSOR PAD ◀ or ▶ to label your A/V Receiver Sources.
- Use the CURSOR PAD ◀, ▶, ▲ and ▼ to highlight NEXT, then press the SELECT button to move on to the next SETUP screen.

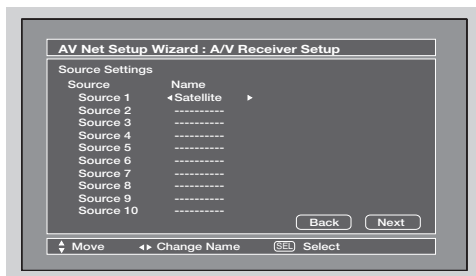

- Confirm all settings, then press the SELECT button to move on to the next SETUP screen.



- Select "YES" to setup another device or select "No, thanks, I'm done" to exit the AV Net setup.



Learning Mode (Example: CUSTOM/DVD 3 Setup)

- Press the SELECT button to start the SETUP WIZARD.



- Use the CURSOR PAD ▲ or ▼ to highlight NO.
- Press the SELECT button to select "NO". (Select NO to setup other devices).
- Use the CURSOR PAD ◀, ▶, ▲ and ▼ to highlight NEXT, then press the SELECT button to move on to the next SETUP screen.

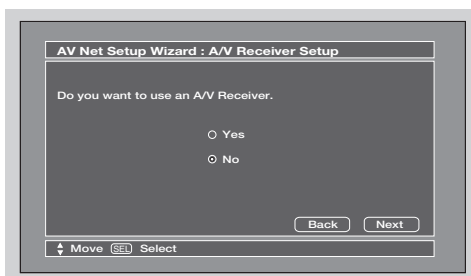

- CURSOR PAD ◀, ▶, ▲ and ▼ to highlight "Custom", then press the SELECT button to select.
- Select NEXT to continue.

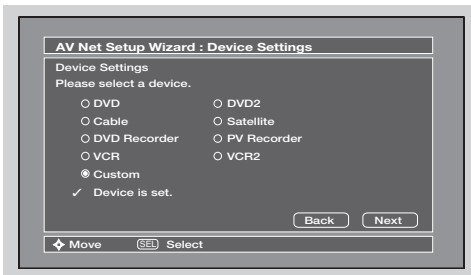

Setup

- Use the CURSOR PAD ◀ or ▶ to choose the device you wish to learn. (Example: DVD 3)
- Select NEXT to continue.



- Select the DVD 3 softkey to learn. (Example: PLAY ▶ button).
- Select NEXT to continue.

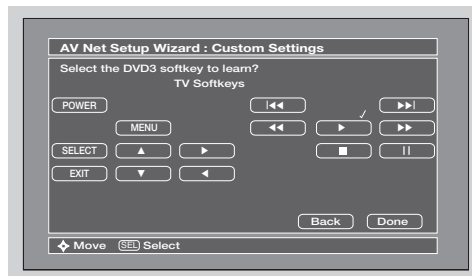

- Press and hold the ▶ “Play button” of the DVD remote control while pointing directly at the learning AV NET sensor of the LCD TV (located at the lower right corner of the screen) at a distance of 3 to 6 feet or 1 to 2 meters.



- If the IR Code transfer was successful, the screen below appears, then select “OK” to continue setup.



- Select another softkey to learn or select “DONE” to move on to the next screen.

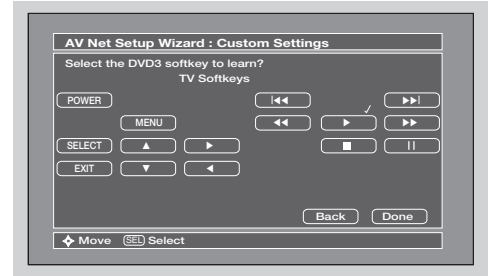

- Select the Test button ▶ “Play button” to check the response of the device to this command.
- Use the CURSOR PAD ◀, ▶, ▲ and ▼ to highlight NEXT, then press the SELECT button to move on to the next SETUP screen.



- Use the CURSOR PAD ◀ or ▶ to select the TV Input that connects to the video and audio output of the DVD.
- Use the CURSOR PAD ◀, ▶, ▲ and ▼ to highlight NEXT, then press the SELECT button to move on to the next SETUP screen.



- Confirm all settings, then press the SELECT button to move on to the next SETUP screen.



Setup

19. Continue with the normal procedures to setup TV Input, Monitor Out, Optical Out and the labeling of the source buttons.
20. Select "YES" to setup another device or select "No thanks, I'm done" to exit the AV NET setup.



- NOTE:**
1. After a successful A/V NET setup to a chosen TV Input, the user can access soft key controls by selecting the device in the inputs menu.
 2. Each Device and Custom setting only accepts one device at a time. The second device/custom setup will give the user the options to either modify or delete the device.
 3. When setting up devices that have Monitor Out options (examples: A/V receiver, VCR), the Monitor Out and Audio Out will have default settings of TV Tuner out and Fixed respectively.
 4. Before changing or modifying the Video and Audio Inputs, both should be set to "Not Connected" to access available options.
 5. The device label will show on the Inputs menu until deleted or modified.
 6. The AV NET setup will have priority over the Input setup.
 7. For devices which have any or all of these functions, Play, Rewind, Fast Forward, Record, Stop and Pause, the Remote Control equivalent buttons may be used to perform these operations.

Set Closed Caption

Closed Captions are the dialogue, narration, and/or sound effects of a television program or home video which are displayed on the TV screen. Your local TV program guide denotes these programs as **CC** or .

1. Use the **CURSOR PAD** ◀, ▶, ▲ or ▼ to highlight and select the function to change.
2. Press **EXIT** to quit menu or **CURSOR PAD** ◀ to return to previous menu.

Caption Display:

ON/OFF will turn the **CC** display on or off.
AUTO will turn the **CC** display on when Mute/Soft Mute is on.

Analog Captions:

Set **CAPTIONS** for Analog programs. This function will help choose and set available mode and channel.

Caption Mode:

CAPTIONS is for the program you are viewing.

TEXT is for additional information such as news reports or a TV program guide. This information covers the entire screen and viewing the TV program is not possible. Text may not be available with every **CC** program.

Channel:

- 1 is used for the primary language (usually English).
- 2 is sometimes used for a second language (may vary by region).
- 3 is sometimes used for a third language (may vary by region).
- 4 is sometimes used for a fourth language (may vary by region).

Digital Captions

Set captions for digital programs. This function will help choose and set available language, font, size and style of digital captions.

1. Use the **CURSOR PAD** ◀, ▶, ▲ or ▼ to highlight and select **DIGITAL CAPTIONS** feature.
2. Press **EXIT** to quit menu or **CURSOR PAD** ◀ to return to previous menu.

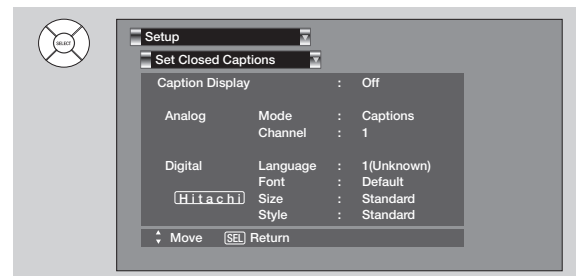
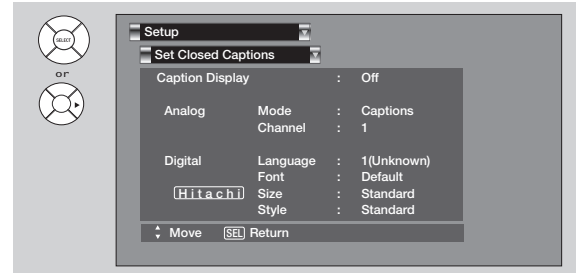
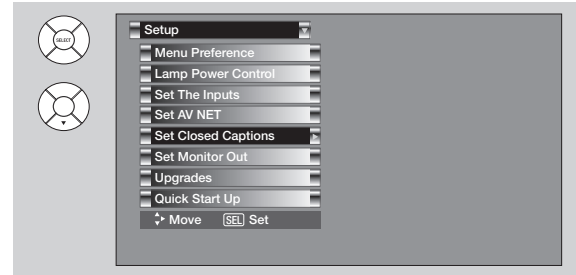

- NOTE:**
1. Some types of digital closed captions will not work with this TV.
 2. Caption Display will not work when viewing a 480p, 720p or 1080i input via the **COMPONENT: Y-PbPr** inputs.
 3. When **PIP SURF** is on, Closed Caption will not work.
 4. Digital Captions Font Style are sometimes different from the Font Style of Analog Captions.
 5. Closed Caption and Digital Captions availability and content depends on the broadcaster. Closed Caption is available when Closed Caption icon is displayed on screen.
 6. Digital Captions will not be available (grayed out) when using analog channels.

Setup

Set Monitor Out

This feature will select the source of the Monitor Output.

Monitor:

Select **MONITOR** to output the audio and video signals of the chosen input source (**CABLE, AIR, INPUT 1-5**) to a VCR or other AV device.

TV Tuner Out:

Select **TV TUNER OUT** to output the audio and video signals of the last watched Antenna Source (**CABLE, AIR**).

Fixed

Select **AUDIO OUT FIXED** to have the Audio at fixed volume.

Variable

Select **AUDIO OUT VARIABLE** to have Audio volume that can be controlled by the LCD Rear Projection TV Volume Up/Down.

Video Out	Audio Out	Use
Monitor	Fixed	To record currently viewed Video and Audio.
Monitor	Variable	When an external device like a monitor or Hi-Fi audio system is connected to the audio and video output of the TV. You can control the volume output by changing the volume of the TV.
TV Tuner Out	Fixed	To record currently viewed Video and Audio from either Cable or Air.

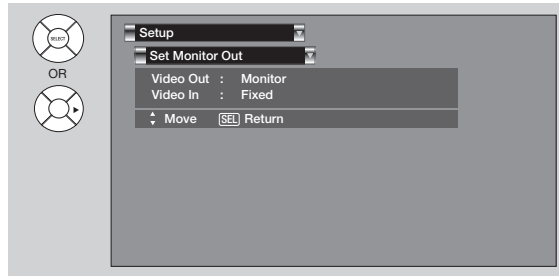
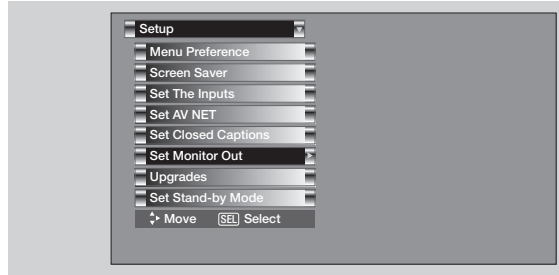

1. Use **CURSOR PAD ▲** or **▼** to highlight the function to change
2. Use the **CURSOR PAD ◀** or **▶** to select the function.
3. Press **EXIT** to quit menu or select **SET MONITOR OUT** to return to previous menu.

NOTE: 1. When **TV TUNER OUT** is selected, **VARIABLE AUDIO OUT** will not be available (grayed out).
 2. When using **MONITOR OUT** for recording, set the **VIDEO OUT** to **MONITOR**.

Setup

MONITOR: Available Monitor Out Signals

Input Mode				Monitor Out			
				S-Video	Video	L/R	HiFi
ANT (Air or Cable)	Digital Channel	No Macrovision	S-Video	YES	YES	YES	YES
		Macrovision	S-Video	-	-	-	YES
	Analog Channel		Video	-	YES	YES	YES
Input 1	HDMI_1			-	-	-	YES
	S-Video_1			YES	YES	YES	YES
	Video_1			-	YES	YES	YES
Input 2	S-Video_2			YES	YES	YES	YES
	Video_2			-	YES	YES	YES
Input 3	Y-PbPr_3			-	-	-	YES
	Video_3			-	YES	YES	YES
Input4	Y-PbPr_4			-	-	-	YES
	Video_4			-	YES	YES	YES
Input5	S-Video_5			YES	YES	YES	YES
	Video_5			-	YES	YES	YES

TV TUNER OUT: Available Monitor Out Signals

Input Mode				Monitor Out (TV Tuner Out)			
				S-Video	Video	L/R	HiFi
ANT (Air or Cable)	Digital Channel	No Macrovision	S-Video	YES	YES	YES	YES
		Macrovision	S-Video	ANT	ANT	ANT	ANT
	Analog Channel		Video	-	-	-	YES
Input 1	HDMI_1		Y-PbPr	YES	YES	YES	YES
	S-Video_1			ANT	ANT	ANT	ANT
	Video_1			digital ONLY			
Input 2	S-Video_2						
	Video_2						
Input 3	Y-PbPr_3						
	Video_3						
Input4	Y-PbPr_4						
	Video_4						
Input5	S-Video_5						
	Video_5						

Setup

Upgrades

It shows software information and easy upgrade procedure. This function allows the TV software to be upgraded by using a flash card (**MMC CARD**). If a future software upgrade is required for your TV, **HITACHI** will notify and provide you with a flash card. In order to receive written notification and the flash card, please complete and return the warranty card.

1. Insert **MMC CARD**
2. Press the **CURSOR PAD ▲** or **▼** to highlight **UPGRADE NOW**.
3. Press the **SELECT** button to select and start upgrading.
4. Unplug the power cord when the upgrade is complete.

NOTE: Any power interruption during the upgrade process will cancel the upgrade. When this happens, repeat the upgrade procedure.

Quick Start Up

This feature will select **QUICK START UP** options. Set this feature to **ON** to have the TV tune channels (both Analog and Digital) quickly when first turning the TV on. Set this feature to **OFF** to save electricity. Selecting **ON** for the **QUICK START UP** feature will activate the TV tuners circuits when the TV is in “standby mode” which is commonly referred to as “off”. This will allow you to quickly tune to channels when first turning the TV on. Digital signals often change and this feature will monitor any changes and prepare the television to quickly present a picture. A small amount of electricity is used to continually monitor signals when this feature is selected.

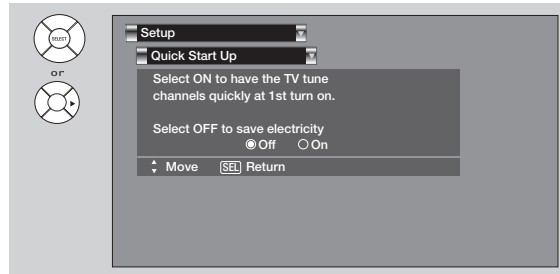
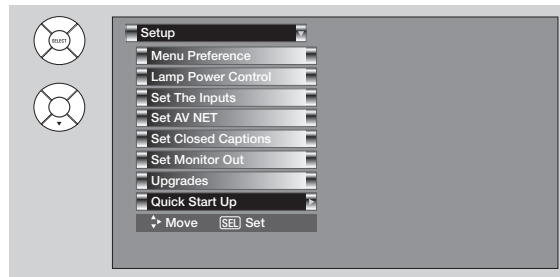
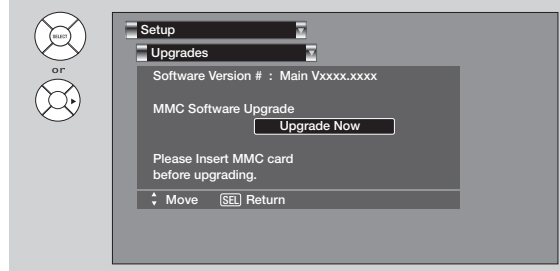
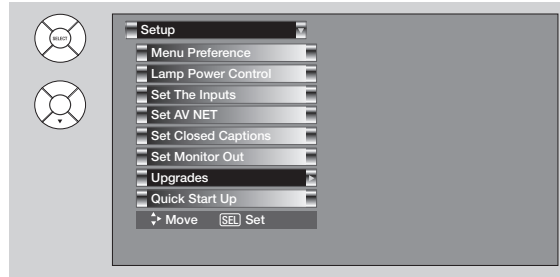

Lamp Replacement

Lamp Life

The lamp life may vary based on usage of the LCD Rear PTV. Turning on and off frequently may shorten the life of the lamp.

Lamp Replacement

After extended use, if the TV picture turns dark, the color looks unusual or LAMP INDICATOR light turns on, then it is time to replace the lamp with a new lamp.

WARNING:

The lamp gets very hot! The lamp may explode if improperly handled. To avoid injury, please observe the following precautions.

- *Do not open lamp compartment or attempt to remove lamp assembly unless the lamp assembly is being replaced.*
- *Unplug the product's power cord from the AC outlet before attempting to replace the lamp assembly.*
- *If the lamp is in use when failure occurs or if the lamp has exploded, wait at least 30-45 minutes for the lamp to cool before opening the lamp compartment or touching the lamp assembly or any broken pieces.*
- *Broken lamp pieces can cause injury. Handle with gloves to avoid cuts.*
- *Do not place any foreign objects inside the lamp compartment.*
- *When installing a new lamp, follow handling instruction included with the new lamp. Do not touch glass surface of new lamp.*
- *This product contains lead and a lamp that contains mercury. Dispose of this product and its lamp in accordance with applicable environmental laws. For lamp recycling and disposal information, go to www.lamprecycle.org. For product recycling and disposal information, contact your local government agency or eRecycle.org (in California), the Electronic Industries Alliance at www.eiae.org (in the US) or the Electronic Product Stewardship Canada at www.epsc.ca (in Canada). For more information, call "1-800-HITACHI."*

CAUTION!

A "LAMP" indicator will light when lamp becomes hot. Unplug product's power cord from the AC outlet and allow lamp to cool for at least 30-45 minutes. If "LAMP" indicator is still lit, please contact your authorized service center (see page 97).

NOTES:

- *Contact your Hitachi dealer for a new lamp unit. Using other lamps may cause damage to the TV Set.*

MODEL#	LAMP TYPE	PART#
50VG825	LP700	UX21516
55VG825	LP700	UX21516
60VG825	LP700	UX21516

- *When replacing the lamp, let it cool down completely, for approximately 30 to 45 minutes after the power has been switched off and A.C. cord has been unplugged.*
- *Do not touch the glass of the new lamp or make it dirty which can shorten the life of the lamp and reduce the picture quality.*
- *Keep the lamp out of the reach of children and away from flammable materials.*
- *Do not pour water onto the removed lamp or put any object inside the lamp.*
- *Once the lamp is removed, do not put flammable materials and metal objects inside the lamp receptacle on the TV set. Do not touch the receptacle.*
- *Install the new lamp securely, otherwise the picture may become dark or it may cause severe overheating.*
- *Install the lamp cover correctly, otherwise power will not come on.*

Lamp Replacement

Lamp Replacement

1. Turn off the main power switch and unplug the power cord.

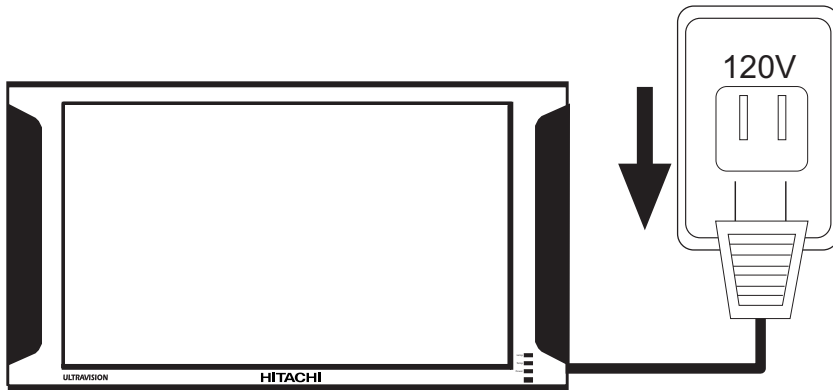

CAUTION: The lamp is very hot and may cause fire or severe burns. Wait at least 30~45 minutes to allow the lamp to cool before proceeding with lamp removal.

2. Locate the Lamp Compartment on the left side of the LCD TV.

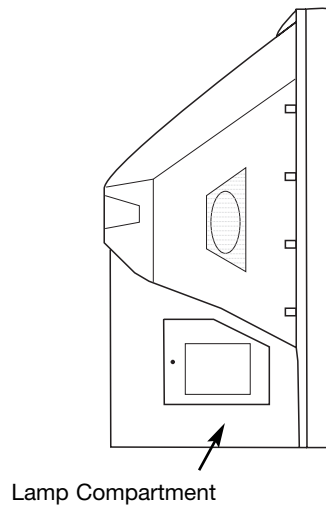

Lamp Replacement

- Remove the screw securing the lamp cover with a Phillips head screw driver as shown. Remove the lamp cover.

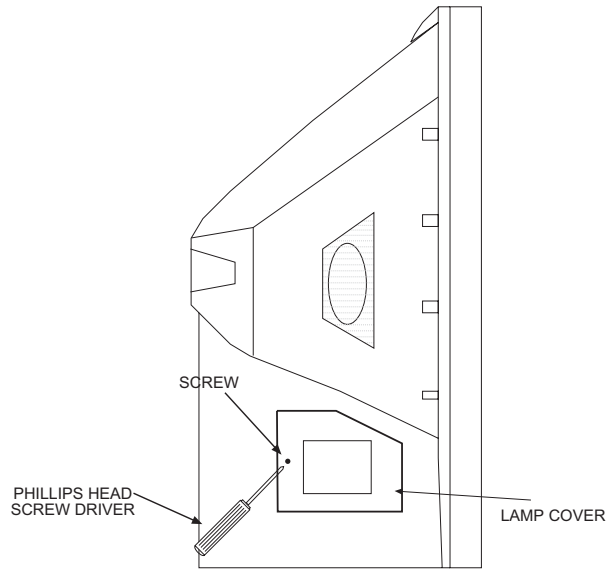

CAUTION: The lamp is very hot and may cause fire or severe burns. Wait at least 30–45 minutes to allow the lamp to cool before proceeding with lamp removal.

- Remove the two screws that hold the lamp in place. Remove the lamp unit by holding the lamp handle, then pulling outwards. Exercise caution when removing the lamp unit to avoid injury to your fingers.

NOTE: Do not put your hand in the Lamp Storage area after the Lamp Unit is removed, you may get burned.

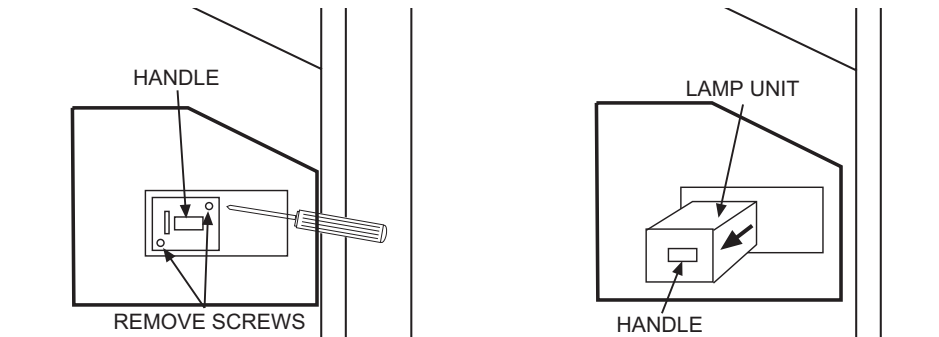

- Replace with the new lamp.
Place the removed lamp into the empty box of the replacement lamp. Do not touch the front glass of the new lamp or its receptacle. This may shorten the life of the lamp and reduce the picture quality.
 - Push the lamp unit back to its original position.
 - Tighten the screws firmly on the lamp unit. If they are loose, the TV may not operate correctly.

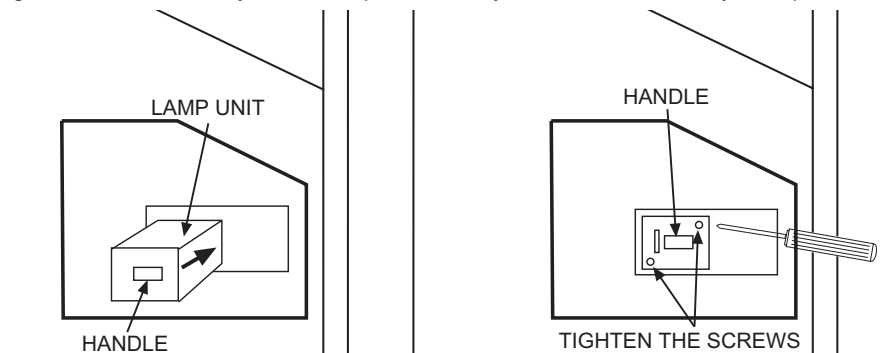

Lamp Replacement

- Without installing the lamp cover, the power will be off and the Lamp Indicator will flash (see page 9). Be sure to install the lamp cover by re-engaging the two clips and tighten the screws before turning the power on, otherwise it may cause unusual colors.

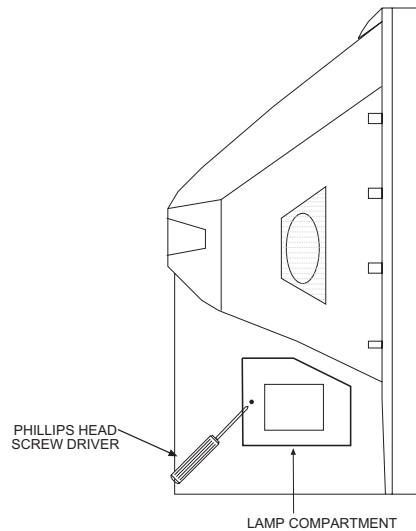

NOTE: If power is connected before the Lamp Cover is installed, the power will be off and the Lamp Indicator will flash (see page 9).

- Plug power cord into AC outlet and turn on the main power switch.

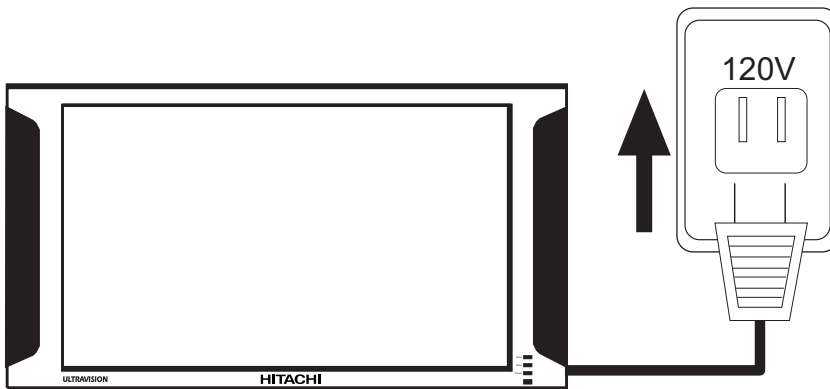

NOTE: This product contains lead and a lamp that contains mercury. Dispose of this product and its lamp in accordance with applicable environmental laws. For lamp recycling and disposal information, go to www.lamprecycle.org. For product recycling and disposal information, contact your local government agency or eRecycle.org (in California), the Electronic Industries Alliance at www.eiae.org (in the US) or Electronic Product Stewardship Canada at www.epsc.ca (in Canada). For more information, call "1-800-Hitachi".

Equipment Care and Troubleshooting

DO

- Dust the screen and cabinet with a soft cloth.
- Clean the screen with a soft cloth moistened in warm water and dry with a soft cloth. A mild soap may be used if the screen is extremely dirty.
- Place your Television away from extreme heat, humidity, and extremely dusty places.
- Remove the plug from the wall outlet if your Television will not be used for a long period of time, for instances, when you go on vacation.

DO NOT

- Do not clean your screen or cabinet with strong cleaners, polishes or a chemically treated cloth.
- Do not place rubber or vinyl products or cellophane tape on your Television.
- Do not touch the screen too often.
- Do not subject the remote control to shocks such as dropping it on the floor, etc. Physical damage to the precision parts may result.
- Avoid placing the remote control in a high humidity place or getting it wet. Do not leave it on or near a heater. Excessive heat or moisture may cause the unit to cease operation.
- When the batteries run down, remote control operation will become erratic or possibly stop altogether. Replace the old batteries with two new "AA" size batteries as soon as possible to preserve the remote control precodes that were set for the devices. Pressing a remote control button with a "DEAD" battery might erase all precodes in memory. Do not use an old battery with a new battery.
- Exposure of the viewing screen to prolonged direct sunlight or heat may cause the screen to permanently warp, resulting in a distorted picture..

TROUBLESHOOTING

HITACHI LCD Rear Projection Television incorporates advanced power surge protection technology designed to protect against component or circuit damage due to external or internal voltage power surges.

IF YOUR TELEVISION SHOULD APPEAR TO HAVE A LOSS OF POWER, PLEASE FOLLOW THIS PROCEDURE:

1. Press the **POWER SWITCH (ON/OFF SWITCH)** once.
2. If there is still no power, wait 30 seconds and press the **POWER SWITCH** again.
3. If there is still no power, unplug the power cord from the wall. Wait 30 seconds and plug the power cord back in. Press the **POWER SWITCH** again.

This protective technology should provide for years of lasting entertainment from your **HITACHI** LCD Rear Projection Television.

SYMPTOMS	CHECK THESE ITEMS AND TRY THESE ADJUSTMENTS												
	Be sure external connection is correct	Be sure power cord is plugged in	Be sure TV is switched ON	Try another channel (station trouble)	Check antenna connections (back of TV)	Check antenna for broken lead-in wire	Adjust outside antenna	Adjust for local interference	Adjust Contrast control	Adjust Brightness control	Adjust Color control	Adjust Tint control	Adjust Volume control
No Picture, no sound	●	●	●	●	●	●							
Sound OK, picture poor	●			●	●	●	●	●					
Picture OK, sound poor	●			●	●	●	●					●	
Picture blurred	●			●	●	●	●						
Lines or streaks in picture				●	●	●	●						
Poor reception on some channels				●	●	●	●						
Picture rolls vertically				●			●						
No color	●			●	●	●	●			●			
Poor color	●			●	●	●	●			●	●		

TV Guide On Screen™ System Frequently Asked Questions

TV Guide On-Screen™ System Frequently Asked Questions

My Guide listings disappeared after a power failure.

You should begin to receive listings again within 24 hours.

Some channel numbers in the Guide are incorrect.

You can correct them using Change Channel Display under Setup.

I have not received any Guide show listings.

Listings usually begin to appear within 24 hours after a successful Setup. It may take up to 5 days to receive a full 8 days of program listings.

- Check the connections between the TV, cable, antenna, and the IR cable if using a cable box.
- Verify Setup information under Change System Settings.
- Make sure the cable box is On, if applicable.
- Review Screen 4 and Screen 5 in the Initial Guide Setup section.

A show I set to Record did not occur.

- Make sure your recorder is turned Off before the recording begins.
- Make sure there is a tape in the VCR.
- Check the Schedule menu and verify that the show is listed before recording begins.
- Check the placement of the IR cable in front of your recorder.

The TV did not tune to a show I scheduled with the Reminder feature.

- Check the Schedule menu and verify that the show is listed.
- If you have a cable box, check the IR cable connection.

I set a show to Auto-Tune and it did not.

- Check the Schedule menu and verify that the show is listed as a Reminder.
- Highlight the show under Listings and do the following:
 - Press the Menu button on the remote.
 - Use the down arrow to highlight Edit Reminder, and press SELECT.
 - Verify the Auto-Tune option reads Yes.
- The TV must be On at the scheduled time for Auto-Tune.

I set a show with the Power On TV option and it did not.

- Check the Schedule menu and verify that the show is listed as a Reminder.
- Highlight the show under Listings and do the following:
 - Press the Menu button on the remote.
 - Use the down arrow to highlight Edit Reminder, and press SELECT.
 - Verify the Power On TV option reads Yes.
- The TV must be Off at the scheduled time for Power On TV.

If I add a recorder or change my cable service, how do I change my Setup information?

- 1) Highlight the Setup Service in the Guide.
- 2) Use the down arrow to select Change System Settings.
- 3) Follow the on-screen instructions.

A show entry in the Guide reads “No Listing.” What does that mean?

Show information for that entry was not available during the last Guide information update (download). Show information is updated on a daily basis.

When I entered the Guide, I was asked to choose from more than one channel lineup. What should I do?

Select the lineup that most closely matches the one for your area. If after you choose the lineup, you want to make changes:

- 1) Highlight the Setup Service in the Guide.
- 2) Use the down arrow to select Change Channel Display or change System Settings.
- 3) Follow the on-screen instructions.

What do the color for shows in the Listings and Search screens indicate?

Green=Sports; Dark Blue=Children's; Purple=Movies; Teal=Other Show

If I have a power outage, do I need to complete Setup again?

No; Setup information is stored in TV Guide On Screen.

Is Help available in the Guide? If so, how do I find it?

Yes. Highlight any of the 4 main Services (i.e., Listings, Schedule, Setup, Search) and press the Info Button. An Expanded Info Box displays additional help information; press Info again to close the box.

Help is also available in a Panel Menu. Press the Info Button to display an Expanded Info Box; press Info again to close the box.

After some show titles, I have noticed from 1 to 4 stars (**). What does that mean?**

These stars are a broadcast-industry rating system used to inform you of a show's quality. The more stars, the better the rating.

I have seen the word “download” in reference to the Guide. What does that mean?

A download sends channel and show information to a TV Guide On Screen device. A download happens at least once a day.

Can I set a Record or Remind event without highlighting a show title in the Guide?

Yes. TV Guide On Screen has a Manual Record and Remind feature. Highlight Schedule and press menu. Choose the event type, press SELECT and then enter date, start and stop time, channel number, etc.

TV Guide On Screen™ System Frequently Asked Questions

What do the frequencies for Record and Remind mean?

- **Once**—records/reminds the show one time
- **Daily** (manual only)—records/reminds the time, channel, and input combination Monday through Friday
- **Regularly**— records/reminds for the channel/time combination on any day of the week, on the same channel
- **Weekly**— records/reminds for the channel/time combination on a specific day of the week
- **Off** (not cancel)—keeps the show in the Schedule list but will not record/remind the show until the frequency is changed

How can I look for a specific show in the Guide?

Search lets you find shows by Category (HDTV, Movies, Sports, Children, Educational, News, Variety, Series), Keyword, or Alphabetical.



In the United States, TV GUIDE and other related marks are registered marks of Gemstar-TV Guide International, Inc. and/or one of its affiliates. In Canada, TV GUIDE is a registered mark of Transcontinental Inc., and is used under license by Gemstar-TV Guide International, Inc.

The TV Guide On Screen system is manufactured under license from Gemstar-TV Guide International, Inc. and/or one of its affiliates.

The TV Guide On Screen system is protected by one or more of the following issued United States patents 6,498,895; 6,418,556; 6,331,877; 6,239,794; 6,154,203; 5,940,073; 4,908,713; 4,751,578; 4,706,121.

Gemstar-TV Guide International Inc. and/or its related affiliates are not in any way liable for the accuracy or availability of the program schedule information or other data in the TV Guide On Screen system and cannot guarantee service availability in your area. In no event shall Gemstar-TV Guide International, Inc. and/or its related affiliates be liable for any damages in connection with the accuracy or availability of the program schedule information or other data in the TV Guide On Screen system.

Reception Problems

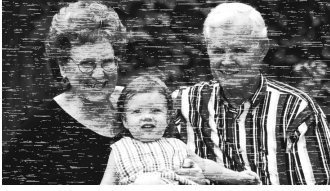

IGNITION NOISE:

Black spots or horizontal streaks may appear, picture may flutter or drift. Usually caused by interference from automobile ignition systems, neon lamps, electrical drills, and other electrical appliances.



GHOSTS:

Ghosts are caused by the television signal following two paths. One is the direct path and the other is reflected from tall buildings, hills or some other objects. Changing the direction or position of the antenna may improve reception. Ghosting may also be caused by defects in the antenna system such as unshielded leads or connecting several sets to the same antenna without using multiple antenna couplers.



SNOW:

If your receiver is located in the fringe area of a television station where the signal is weak, your picture may be marred by the appearance of small dots. When the signal is extremely weak, it may be necessary to install a special antenna to improve the picture.

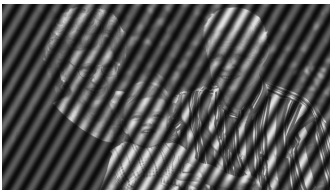

RADIO FREQUENCY INTERFERENCE:

The interference produces moving ripples or diagonal streaks, and in some cases, causes loss of contrast in the picture.



BLOCK NOISE (DIGITAL INPUT):

Fuzzy blocks may appear in some area or the whole area of the screen. This is usually caused by interference from automobile ignition systems, neon lamps, electrical drills, ghosting of the image and weak signals.

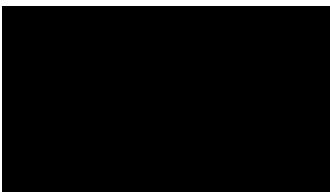



BLACK SCREEN:

When using an antenna, weak signals will display a black screen. It may be necessary to upgrade your antenna.

NOTE: The TV set can generate sound distortion in external devices such as a radio. Please separate radio equipment from the TV set to a considerable distance.

Features and Specifications

FEATURES:

- Superfine Picture Quality; 1280 Line Horizontal Resolution
- Remote (Controls many PVR/VCR brands, cable boxes, satellite boxes, and other audio equipment).
- New Easy-to-Use (3-Language) On-Screen Menu
- Full Set of Input Jacks, including S-Video
- COMPONENT VIDEO: Y-P_B/P_R
- Six Aspect Modes
- Closed Caption Decoder
- 2-Tuner Picture in Picture
- 2 Antenna Inputs (Either for Analog/Digital)
- Video Input Sensor
- HDMI (High Definition Multimedia Interface) (High Bandwidth Digital Content Protection V1.1 compatible).
- Digital Audio Output (Dolby® Digital and PCM)
- 3 Dimensional Y/C Comb Filter
- Compatible with 1080i, 720p, 480p and 480i input signals.
- Photo Input (for your digital camera, USB drive or memory card USB drive)
- TV Guide On Screen™
-  Technology.
This digital television is capable of receiving basic analog, digital basic and digital premium cable television programming by direct connection to a cable system providing such programming. A security card (CableCARD™) provided by your cable operator is required to view encrypted digital programming. Certain advanced interactive digital cable services may require the use of a set-top-box: video-on-demand, cable operator enhanced program guide, data enhanced television service. For more information, contact your local cable operator.
- **BBE** Technology.
Licensed by BBE Sound, Inc. under USP5510752 and 5736897. BBE and BBE symbol are registered trademarks of BBE Sound, Inc. Manufactured under license from BBE Sound, Inc.
- **SRS** Technology.
SRS and  symbol are trademarks of SRS Labs, Inc. SRS technology is incorporated under license from SRS Labs, Inc.
- **DOLBY DIGITAL** Technology.
Manufactured under license from Dolby Laboratories. "Dolby" and the double-D symbol are trademarks of Dolby Laboratories.
- **HDMI** Technology
HDMI, the HDMI logo and High-Definition Multimedia Interface are trademarks or registered trademarks of HDMI Licensing LLC.

INPUTS:

- Power Input.....AC 120V, 60Hz
- Stand-by Power.....Less than 1 Watt
- Power Consumption - Refer to rear panel at the back of the T.V.
- Antenna input impedance75 Ohm
- Channel coverage
VHF-Band2 – 13
UHF-Band.....14 – 69
CATV Band1 – 135, A – I
- Video1.0Vp-p, 75 Ohm
- S-Video
Luminance (Y)1.0Vp-p, 75 Ohm
Chrominance (C)0.286Vp-p, 75 Ohm
- Component Video
Luminance (Y)1.0Vp-p, 75 Ohm
Chrominance (P_B/P_R)0.7Vp-p, 75 Ohm
- Audio input Impedance47k Ohm
- Average input level470mVrms
- HDMIHDMI 19 PIN
- IR BLASTER2
- G-LINK1

OUTPUTS:

- Video1.0Vp-p. 75 Ohm
- Audio (Fixed)470mVrms, 1k Ohm
- S-Video
Luminance (Y)1.0Vp-p, 75 Ohm
Chrominance (C)0.286Vp-p, 75 Ohm
- Optical Out (Digital Audio)1 optical connector

DIMENSIONS:

	50VG825	55VG825	60VG825
Height (in.)	28 11/16	31 1/8	33 9/16
(mm)	728.0	790.0	853.0
Width (in.)	55 3/8	59 7/8	64 1/8
(mm)	1,407.0	1,520.0	1,629.0
Depth (in.)	16 6/16	17 3/4	19 1/16
(mm)	415.8	450.0	483.8
Weight (lbs.)	97	94.1	118
(kg.)	44	42.7	53.5

NOTE: Due to improvements, specifications in this operating guide are subject to change without notice.

HITACHI

Inspire the Next

Service Hotline

To locate an authorized **HITACHI** service facility in the continental U.S.A. and Canada,

DIAL TOLL FREE

7 days a week, 24 hours a day

1-800-HITACHI
(1-800-448-2244)



HITACHI AMERICA, LTD.
HOME ELECTRONICS DIVISION

HITACHI has made every effort to assure you hours of trouble free operation from your unit. However, should you require service, a network of **HITACHI** Authorized Service Facilities has been established in all 50 states and Puerto Rico. Each facility will provide you with convenient and expedient assistance. Our service hotline operator will direct you to the **HITACHI** Authorized Service Facility nearest you. Just present proof of purchase and/or delivery receipts to the Hitachi Authorized Service Facility, and service will be rendered in accordance with the terms of the limited warranty as stated on your warranty card or operating guide.

Should you have any questions regarding warranty, service, operation, or technical assistance, please contact:

Hitachi America, LTD.
Home Electronics Division
900 Hitachi Way
Chula Vista, CA 91914-3556

HITACHI CANADA, LTD.
DIGITAL MEDIA DIVISION

Should you have any questions regarding warranty, service, operation, or technical assistance, please contact:

In Canada: 1-800-HITACHI (1-800-448-2244)

Monday – Friday (EST).....9:00am – 7:00pm
Saturday (EST)9:00am – 5:00pm

Look for your French Manual on the outside of the box. If the manual is missing, call **1-800-HITACHI (1-800-448-2244)** for a copy.

Pour de plus amples renseignements sur le service durant la période couverte par la garantie, sur le fonctionnement ou pour de l'assistance technique communiquez avec:

Au Canada: 1-800-HITACHI (1-800-448-2244)

Lundi - Vendredi L'EST9:00am – 7:00pm
Samedi L'EST9:00am – 5:00pm

La version français de votre manuel se trouve a l'exterieur de la boîte. Si le manuel est manquant, coposez le **1-800-HITACHI (1-800-448-2244)** pour obenir votre copie.

HITACHI CANADA, LTD.
2495 Meadowpine Blvd.
Mississauga, Ontario L5N 6C3

End User Licence Agreement for HITACHI DTV Software

END USER LICENSE AGREEMENT FOR HITACHI DTV SOFTWARE

IMPORTANT – READ CAREFULLY: This End User License Agreement for **HITACHI** DTV Software (this “Agreement”) is a legal agreement between you (“you” or “your”), in your capacity as the owner of a **HITACHI** brand digital television (the “DTV”), and **HITACHI** America, Ltd., Home Electronics Division (“**HITACHI**”). By using the DTV or the operating system software installed on the DTV (the “System Software”) or any Upgrade (as defined below, and together with the System Software, the “Software”), you agree to be bound by the terms and conditions of this Agreement. **IF YOU DO NOT AGREE TO BE BOUND BY THIS LICENSE AGREEMENT, DO NOT USE THE DTV OR THE SOFTWARE.**

1. **LICENSE GRANT.** **HITACHI** grants to you, for the life of the DTV, a non-exclusive, non-transferable, revocable license to install and use one copy of the Software on the DTV, subject to the following limitations and restrictions:
 - a. You may not share, duplicate, republish or redistribute the Software;
 - b. You may not resell, rent, lease, sublicense, gift, loan, assign or otherwise transfer the Software or any of your rights under this Agreement;
 - c. You may not modify, adapt, translate, reverse engineer, decompile, disassemble or make derivative works from the Software or use the Software in combination with any non-Hitachi software; and
 - d. You may not use the Software for any commercial purpose.
2. **VIOLATIONS; INDEMNITY.** You understand and agree that your use of the Software in any manner except as permitted under this Agreement could constitute a serious crime and could subject you to damages and an award to **HITACHI** of attorneys’ fees in connection with your violation of this Agreement. You further understand that you may be held legally responsible for any copyright infringement or other violation of intellectual property rights caused or facilitated by your failure to abide by the terms of this Agreement. You agree to defend, indemnify and hold **HITACHI** and its parent and affiliate companies harmless from and against any and all liability resulting from any breach by you of this Agreement.
3. **INTELLECTUAL PROPERTY.** The Software is protected by federal copyright laws, international copyright treaties and other intellectual property laws and treaties. The Software is licensed, not sold, to you. All right, title and interest in and to the Software and any intellectual property associated therewith, including any accompanying printed materials, shall belong to **HITACHI** and its licensors and suppliers. Except as expressly provided herein, neither **HITACHI** nor any of its licensors or suppliers grants to you under this Agreement any express or implied right in or to any patents, copyrights, trademarks, trade secrets or other intellectual property. All right, title and interest in and to the intellectual property rights associated with any content that is accessible through use of the Software shall belong to the applicable content owners and may be protected by copyright or other intellectual property laws and treaties. This Agreement grants you no rights to use such content. Any rights of **HITACHI** not expressly granted to you hereunder are reserved expressly by Hitachi.
4. **SOFTWARE UPGRADES.** In the future, **HITACHI** may release or make available one or more upgrades to the System Software (each, an “Upgrade”). You understand and agree that if you decide to install or use any Upgrade, your installation and use of such Upgrade and/or any other software or intellectual property **HITACHI** may provide in connection therewith shall be governed by the terms and conditions of this Agreement, except to the extent that **HITACHI** provides different or supplementary license terms or conditions that accompany such Upgrade or other software or intellectual property. In the event **HITACHI** provides you with a “flash card” or other media to effect or facilitate an Upgrade, you understand and acknowledge that your failure to return such flash card or other media to **HITACHI** as **HITACHI** may require could result in **HITACHI** placing your name and your DTV’s serial number on a “No Further Upgrades” list, which will prohibit you from receiving any subsequent Upgrades **HITACHI** may later release or make available. **IF YOU DO NOT AGREE WITH ALL THE TERMS AND CONDITIONS OF THIS AGREEMENT OR ALL THE TERMS AND CONDITIONS OF ANY DIFFERENT OR SUPPLEMENTARY LICENSE THAT MAY ACCOMPANY SUCH UPGRADE, (A) DO NOT USE ANY HITACHI-PROVIDED FLASH CARD OR OTHER MEDIA, (B) DO NOT PERFORM INSTALL ANY HITACHI-PROVIDED UPGRADE SOFTWARE ON YOUR DTV, AND (C) PROMPTLY RETURN SUCH FLASH CARD OR OTHER MEDIA TO HITACHI.**
5. **EXPORT RESTRICTIONS.** **HITACHI** is licensing the Software for use within North America only. You agree that you will not export or re-export the Software. You specifically agree not to export or re-export the Software: (i) to any country to which the U.S. has embargoed or restricted the export of goods or services, which currently include, but are not necessarily limited to Cuba, Iran, Libya, North Korea, Sudan and Syria, or to any national of any such country, wherever located, who intends to transmit or transport the Software back to such country; (ii) to any person or entity who you know or have reason to know will utilize the Software in the design, development, or production of nuclear, chemical, or biological weapons; or (iii) to any person or entity who has been prohibited from participating in U.S. export transactions by any federal agency of the U.S. government. You warrant and represent that neither the U.S. Bureau of Industry and Security nor any other U.S. federal Agency has suspended, revoked, or denied your export privileges.
6. **NO WARRANTIES.** The software is provided to you in “as is” condition and **HITACHI** makes no warranties of any kind whatsoever regarding the software and, to the maximum extent permitted by law, hereby expressly disclaims all warranties of any kind whatsoever, express or implied, with respect to the software. All implied warranties, including without limitation, the implied warranties of non-infringement, merchantability and fitness for a particular purpose are hereby expressly disclaimed by hitachi to the maximum extent permitted by law.
7. **LIMITATION OF LIABILITY.** To the maximum extent permitted by applicable law, **HITACHI**, its licensors, suppliers, parent companies, affiliates, subsidiaries, employees and agents shall not under any circumstances be liable to you or any third parties for any damages of any nature arising in any way from this agreement, your use of the software or otherwise, whether indirect, special, incidental, consequential or otherwise, including, without limitation, any claims for lost profits, lost good will, lost data, business interruption, procurement of substitute goods or services, or expenditures made or committed for in reliance on the continuation of this agreement, even if advised in advance of the possibility of such damages.
8. **NO FAILURE OF ESSENTIAL PURPOSE.** You agree that neither **HITACHI**’s breach of this agreement nor its failure to repair a defect, error or bug in the software shall constitute a failure of the essential purpose of this agreement.
9. **CRYPTOGRAPHIC SOFTWARE.** The software contains software developed by the openssl project, including cryptographic software written by eric young (the “cryptographic software”). The cryptographic software is provided by the openssl project in “as is” condition and any express or implied warranties, including but not limited to, the implied warranties of merchantability and fitness for a particular purpose are hereby expressly disclaimed to the maximum extent permitted by law. In no event shall the openssl project, its contributors, **HITACHI** or any of its parent or affiliate companies be liable for any direct, indirect, incidental, special, exemplary, or consequential damages (including, but not limited to, procurement of substitute goods or services; loss of use, data, or profits; or business interruption) however caused and on any theory of liability, whether in contract, strict liability, or tort (including negligence or otherwise) arising in any way out of the use of the software or the cryptographic software, even if advised in advance of the possibility of such damages.
10. **TERMINATION.** **HITACHI** may terminate this Agreement immediately at any time by providing notice to you.
11. **GOVERNING LAW; SEVERABILITY.** This Agreement will be governed by the laws of the State of New York, and you consent to the exclusive jurisdiction and venue in the federal courts sitting in the Southern District of New York, unless no federal subject matter jurisdiction exists, in which case you consent to the exclusive jurisdiction and venue in the Borough of Manhattan, New York, USA.

Appendixes

Appendix A:

IMAGE INPUT					
INPUT	TYPE	FORMAT	ASPECT	VIDEO ID	AUTO ASPECT
Air or Cable (Analog Channels)	--	NTSC	4:3	--	On/Off
Inputs 1 & 2	HDMI	480i/480p	16:9	16:9	Off
			Letter	Letter	Off
			4:3	4:3	Off
			--	No Info.	On/Off
Inputs 1-5	S-Video ¹ Video	NTSC	16:9	16:9	Off
			Letter	Letter	Off
			4:3	4:3	Off
			--	No Info.	On/Off
Inputs 3 & 4	Y-P _b P _r	480i/480p	16:9	16:9	Off
			Letter	Letter	Off
			4:3	4:3	Off
			--	No Info.	On/Off

¹S-Video = Not available in Input 3 and 4

Appendix B:

IMAGE INPUT					
INPUT	TYPE	FORMAT	ASPECT	VIDEO ID	AUTO ASPECT
Air or Cable (Digital Channels)	--	1080i	4:3	--	On/Off
Inputs 1 & 2	HDMI	480i/480p	Letter	Letter	On
			4:3	4:3	On
Inputs 1-5	S-Video ² Video	NTSC	Letter	Letter	On
			4:3	4:3	On
Inputs 3 & 4	Y-P _b P _r	480i/480p	Letter	Letter	On
			4:3	4:3	On

²S-Video = Not available in Input 3 and 4

Appendix C:

IMAGE INPUT					
INPUT	TYPE	FORMAT	ASPECT	VIDEO ID	AUTO ASPECT
Inputs 1 & 2	HDMI	480i/480p	16:9	16:9	On
Inputs 1, 2, 3 & 5	S-Video ³	NTSC	16:9	16:9	On
Inputs 3 & 4	Y-P _b P _r	480i/480p	16:9	16:9	On

³S-Video = Not available in Input 3 and 4

Appendix D:

IMAGE INPUT					
INPUT	TYPE	FORMAT	ASPECT	VIDEO ID	AUTO ASPECT
Air or Cable (Digital Channels)	--	1080i	16:9	--	On/Off
Inputs 1 & 2	HDMI	1080i/720p	16:9	--	On/Off
Inputs 3 & 4	Y-P _b P _r	1080i/720p	16:9	--	On/Off

Appendixes

Appendix E

After the CableCARD has been successfully installed, a CableCARD Information menu appears in the **SETUP** menu of the On-Screen Display.

Follow the instructions below to access the CableCARD Information menu.

1. Press the **MENU** button on the Remote Control to access the Main Menu screen.



2. Use the **CURSOR PAD ▼** to highlight **SETUP** in the Main Menu and press the **SELECT** button.
3. Use the **CURSOR PAD ▼** to highlight **CableCARD Information** and press the **SELECT** button.

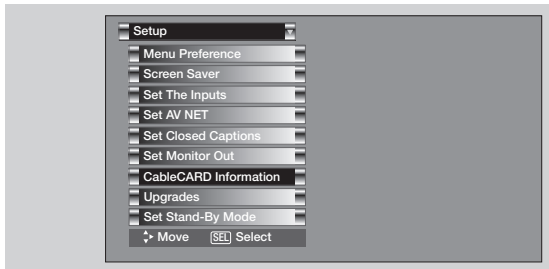

4. To view the CableCARD ID and Host ID, use the **CURSOR PAD ▼** to highlight **CableCARD Info** and press the **SELECT** button.

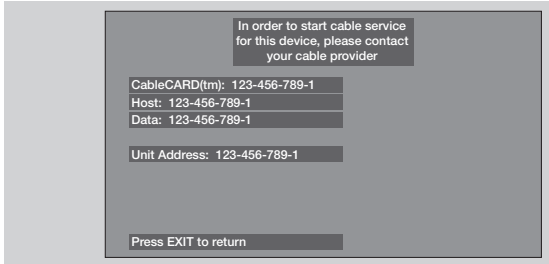
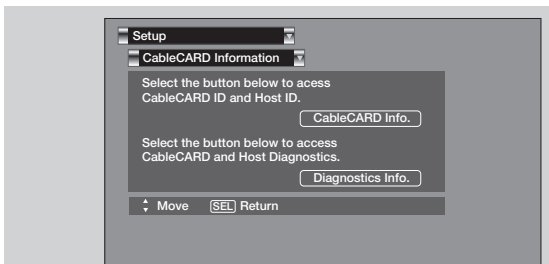

THINGS TO CHECK WHEN USING THE CableCARD / CableCARD Services

1. Check that the CableCARD is properly inserted in the CableCARD slot.
2. Remove the CableCARD by pressing the eject button and pull the CableCARD straight out.
3. Visually inspect the CableCARD to ensure all pin-holes are in good condition, with none blocked or damaged.
4. Make sure the CableCARD is re-inserted in the correct direction, then slowly push until it is fully seated in the slot.
5. When the CableCARD is installed, note all screen messages that appear (“CableCARD Installed”, “Acquiring Data”, “CableCARD is not Installed”). If the “CableCARD Installed” message does not appear when card is installed, check the TV’s card slot and CableCARD pins for obstructions or damage.
6. If problems still remain, please contact your Cable Service Provider.

NOTES:

1. When a CableCARD is installed, Auto Channel scan will not be needed because the channel list is automatically loaded to the TV’s channel memory.
2. The TV will take several seconds to detect and recognize the presence of the CableCARD. This process must be completed before any CableCARD information or Channel listings is accessed.

NOTE: The **Diagnostics Info.** window is for Service use only.

Index

A		I	
Accessories	4	Input button	7, 24
Antennas (Connecting)	6	L	
Aspect Ratio	23	Lamp Replacement	88-91
Audio		Language	
Languages	46	Menu Language	74
Dolby Digital	46	Audio Language	46
DRC (Dynamic Range Compression)	46	Locks	
SRS	44	Change Access Code	67
BBE	44	Channel Lock	67
Audio Settings	44	Front Panel Lock	67
Audio Source	45	Movie Ratings	68
Auto Noise Cancel	45	TV Ratings	69
AV NET	19, 76-83	TV Ratings (Canadian - English)	70
		TV Ratings (Canadian - French)	71
		Loudness	45
B		M	
Balance	44	Menu Preference	
Bass	44	Language	74
Black Enhancement	42	Background	74
Brightness	41	Monitor Out	85
C		P	
CableCARD	12	Pause (Freeze) Button	7, 22, 30
Channel Manager	65	Perfect Volume	45
Auto Channel Scan	66	Picture Mode	41
Channel List	66	Picture-in-Picture (PIP)	28-30
Signal Meter	65	Picture-outside-Picture (POP)	28
Clock		R	
Time	72	Remote Control	
Time Zone	72	Functions	21-38
Date	72	Programming Codes	31-38
Closed Captions		Installing Batteries	4
Analog Captions	84	S	
Digital Captions	84	Sharpness	41
Color Temperature	42	Speakers	14
Color	41	T	
Contrast	41	Timers	72-73
Contrast Mode	42	Time	72
D		Tint	41
Date	72	Treble	44
Daylight Saving Correction	72	Troubleshooting	93-94
G		TV Guide On Screen	47-64
Guide Button	7, 24	Troubleshooting	93-94
H		U	
HDMI	11, 13, 17	Upgrades	87
		V	
		Video Settings	41-43
		Volume	7, 27

Notes

HITACHI

Inspire the Next