

Projector CP-RX94

User's Manual (detailed) Operating Guide

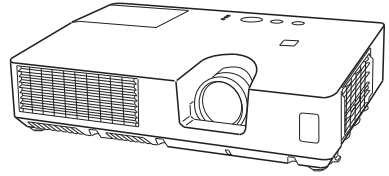

Thank you for purchasing this projector.

▲ WARNING ► Before using this product, please read all manuals for this product. Be sure to read **Safety Guide** first. After reading them, store them in a safe place for future reference.

About this manual

Various symbols are used in this manual. The meanings of these symbols are described below.

▲ WARNING This symbol indicates information that, if ignored, could possibly result in personal injury or even death due to incorrect handling.

▲ CAUTION This symbol indicates information that, if ignored, could possibly result in personal injury or physical damage due to incorrect handling.

NOTICE This entry notices of fear of causing trouble.

 Please refer to the pages written following this symbol.

NOTE • The information in this manual is subject to change without notice.
• The illustrations in this manual are for illustrative purposes. They may differ slightly from your projector.
• The manufacturer assumes no responsibility for any errors that may appear in this manual.
• The reproduction, transfer or copy of all or any part of this document is not permitted without express written consent.

Trademark acknowledgment

- Mac[®] is a registered trademark of Apple Inc.
- Windows[®], DirectDraw[®] and Direct3D[®] are registered trademarks of Microsoft Corporation in the U.S. and/or other countries.
- VESA and DDC are trademarks of the Video Electronics Standard Association.
- HDMI, the HDMI logo, and High-Definition Multimedia Interface are trademarks or registered trademarks of HDMI Licensing LLC in the United States and other countries.
- Blu-ray Disc[™] and Blu-ray[™] are trademarks of Blu-ray Disc Association.

All other trademarks are the properties of their respective owners.

Contents



Introduction	3	INPUT menu	37
Features	3	PROGRESSIVE, VIDEO NR, COLOR SPACE,	
Checking the contents of package.	3	VIDEO FORMAT, HDMI FORMAT, HDMI RANGE,	
Part names	4	COMPUTER IN, FRAME LOCK, RESOLUTION	
Setting up	7	SETUP menu	41
Arrangement	7	Ⓜ KEYSTONE, AUTO ECO MODE, ECO MODE,	
Connecting with your devices	10	INSTALLATION, STANDBY MODE, MONITOR OUT	
Connecting to a power supply.	14	AUDIO menu	44
Using the security bar and slot	15	VOLUME, SPEAKER, AUDIO SOURCE,	
Remote control	16	HDMI AUDIO	
Installing the batteries.	16	SCREEN menu	45
About the remote control signal	16	LANGUAGE, MENU POSITION, BLANK,	
Power on/off	17	START UP, MyScreen, MyScreen Lock,	
Turning on the power	17	MESSAGE, SOURCE NAME, TEMPLATE, C.C.	
Turning off the power	18	OPTION menu	51
Operating	19	AUTO SEARCH, DIRECT POWER ON,	
Adjusting the volume.	19	AUTO POWER OFF, LAMP TIME, FILTER TIME,	
Temporarily muting the sound.	19	MY BUTTON, MY SOURCE, SERVICE	
Selecting an input signal.	20	SECURITY menu	57
Searching an input signal.	21	SECURITY PASSWORD CHANGE,	
Selecting an aspect ratio.	21	MYScreen PASSWORD, PIN LOCK,	
Adjusting the projector's elevator	22	MY TEXT PASSWORD, MY TEXT DISPLAY,	
Adjusting the zoom and focus.	22	MY TEXT WRITING	
Using the automatic adjustment feature.	23	Maintenance	62
Adjusting the position	23	Replacing the lamp	62
Correcting the keystone distortions.	24	Cleaning and replacing the air filter	64
Using the magnify feature.	25	Other care	66
Temporarily freezing the screen	26	Troubleshooting	67
Temporarily blanking the screen	26	Related messages	67
Using the menu function	27	Regarding the indicator lamps	69
EASY MENU	29	Resetting all settings.	71
ASPECT, Ⓜ KEYSTONE, PICTURE MODE,		Phenomena that may be easy	
ECO MODE, INSTALLATION, RESET, FILTER TIME,		to be mistaken for machine defects.	71
LANGUAGE, ADVANCED MENU, EXIT		Specifications	75
PICTURE menu	31		
BRIGHTNESS, CONTRAST, GAMMA, COLOR TEMP,			
COLOR, TINT, SHARPNESS, MY MEMORY			
IMAGE menu	34		
ASPECT, OVER SCAN, V POSITION, H POSITION,			
H PHASE, H SIZE, AUTO ADJUST EXECUTE			

Introduction

Features

The projector provides you with the broad use by the following features.

- ✓ This projector has a variety of I/O ports that supposedly cover for any business scene. The **HDMI** port can support various image equipment which have digital interface to get clearer pictures on a screen.
- ✓ This compact, lightweight projector uses a front exhaust system that keeps the user comfortable by directing hot air away from the user.

Checking the contents of package

Please see the **Contents of package** section in the **User's Manual (concise)** which is a book. Your projector should come with the items shown there. Require of your dealer immediately if any items are missing.

⚠ WARNING ► Keep small parts away from children and pets. Take care not to put in the mouth. If swallowed, consult a physician immediately for emergency treatment.

NOTE • Keep the original packing materials, for future reshipment. Be sure to use the original packing materials when moving the projector. Use special caution for the lens.

- The projector may make a rattling sound when tilted, moved or shaken, since a flap to control the air flow inside of the projector has moved. Be aware that this is not a failure or malfunction.

Part names

- (1) Lamp cover (📖62)
The lamp unit is inside.
- (2) **FOCUS** ring (📖22)
- (3) **ZOOM** ring (📖22)
- (4) Control panel (📖5)
- (5) Elevator buttons (x 2) (📖22)
- (6) Elevator feet (x 2) (📖22)
- (7) Remote sensor (📖16)
- (8) Lens (📖66)
- (9) Intake vents
- (10) Filter cover (📖64)
The air filter and intake vent are inside.
- (11) Speaker (📖44)
- (12) Exhaust vent
- (13) **AC IN** (AC inlet) (📖14)
- (14) Rear panel (📖5)
- (15) Security bar (📖15)
- (16) Security slot (📖15)

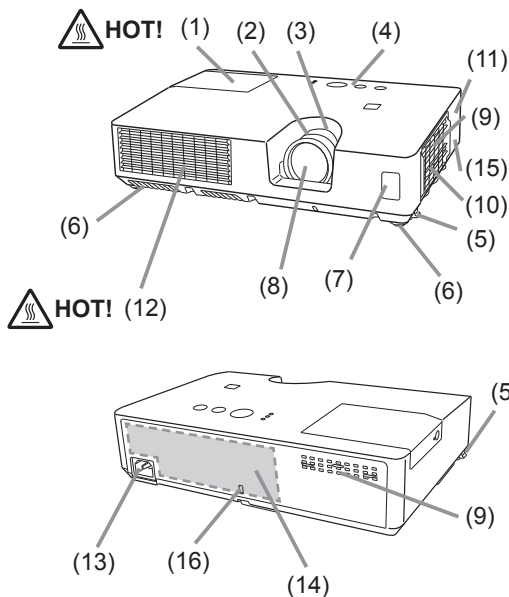

⚠ WARNING ▶ Do not open or remove any portion of the product, unless the manuals direct it.

▶ Do not subject the projector to unstable conditions.

▶ Do not apply a shock or pressure to this product.

▶ Do not look into the lens and the openings on the projector while the lamp is on.

⚠ CAUTION ▶ Do not touch around the lamp cover and the exhaust vents during use or just after use, since it is too hot.

▶ Do not attach anything onto the lens because it could damage the lens, such as melting the lens.



(continued on next page)

Part names (continued)

Control panel

- (1) **STANDBY/ON** button (📖 18)
- (2) **INPUT** button (📖 20, 27)
- (3) **MENU** button (📖 27)

It consists of four cursor buttons.

- (4) **ECO** button (📖 53)
- (5) **POWER** indicator (📖 17, 69)
- (6) **TEMP** indicator (📖 69)
- (7) **LAMP** indicator (📖 69)

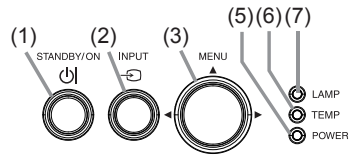

Rear panel (📖 11 ~ 13)

- (1) **HDMI** port
- (2) **VIDEO** port
- (3) **S-VIDEO** port
- (4) **AUDIO IN** port
- (5) **COMPUTER IN1** port
- (6) **COMPUTER IN2 / MONITOR OUT** port
- (7) **AUDIO OUT** port

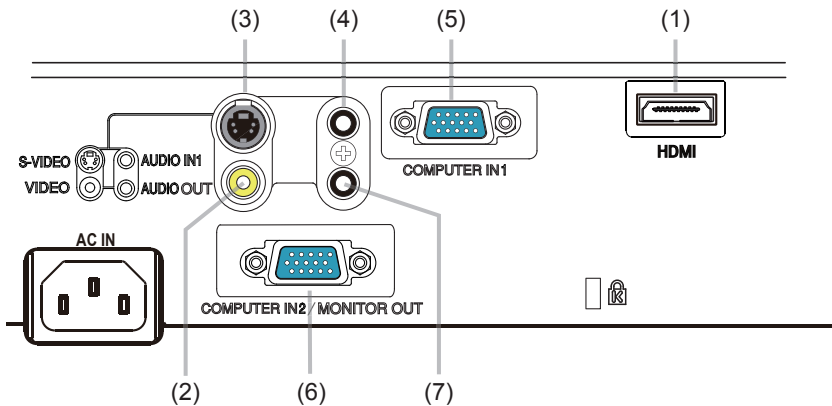

(continued on next page)

Part names (continued)

Remote control

- (1) **VIDEO** button (📖20)
- (2) **COMPUTER** button (📖20)
- (3) **SEARCH** button (📖21)
- (4) **STANDBY/ON** button (📖17)
- (5) **ASPECT** button (📖21)
- (6) **AUTO** button (📖23)
- (7) **BLANK** button (📖26)
- (8) **MAGNIFY - ON** button (📖25)
- (9) **MAGNIFY - OFF** button (📖25)
- (10) **MY SOURCE/DOC.CAMERA** button (📖20, 54)
- (11) **VOLUME -** button (📖19)
- (12) **PAGE UP** button
- (13) **PAGE DOWN** button
- (14) **VOLUME +** button (📖19)
- (15) **MUTE** button (📖19)
- (16) **FREEZE** button (📖26)
- (17) **MY BUTTON - 1** button (📖53)
- (18) **MY BUTTON - 2** button (📖53)
- (19) **KEYSTONE** button (📖24)
- (20) **POSITION** button (📖23, 27)
- (21) **MENU** button (📖27)
- (22) **▲/▼/◀/▶** cursor buttons (📖27)
- (23) **ENTER** button (📖27)
- (24) **ESC** button (📖27)
- (25) **RESET** button (📖27)
- (26) **Battery cover** (📖16)

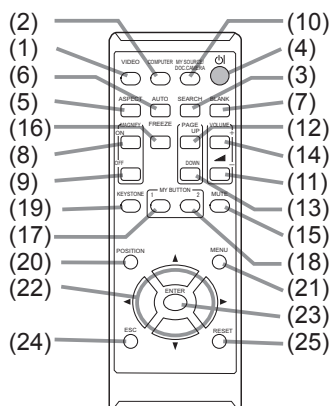

Back of the remote control

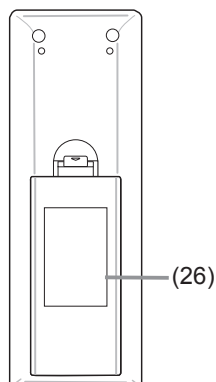

Setting up

Install the projector according to the environment and manner the projector will be used in.

For the case of installation in a special state such as ceiling mount, the specified mounting accessories ([☐ Specifications](#) in the **User's Manual (concise)**) and service may be required. Before installing the projector, consult your dealer about your installation.

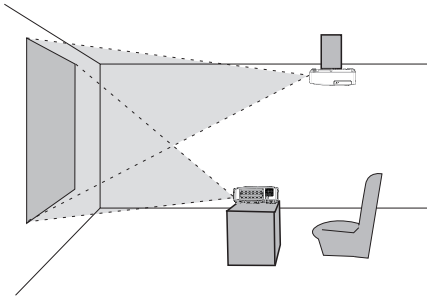

Arrangement

Refer to tables **T-1** and **T-2** at the back of **User's Manual (concise)** as well as the following to determine the screen size and projection distance.

The values shown in the table are calculated for a full size screen.

- Ⓐ Screen size (diagonal)
- Ⓑ Projection distance ($\pm 10\%$, from the projector's end)
- Ⓒ1, Ⓒ2 Screen height ($\pm 10\%$)

- If the projector is used at an altitude of about 1600 m (5250 feet) or higher, set ALTITUDE of the SERVICE item in the OPTION menu to HIGH ([☐ 54](#)). Otherwise, set it to NORMAL. If the projector is used with a wrong setting, it may cause damage to the projector itself or the parts inside.

(continued on next page)

Arrangement (continued)

⚠ WARNING ▶ Install the projector where you can access the power outlet easily. If an abnormality should occur, unplug the projector urgently. Otherwise it could cause a fire or electric shock.

▶ Do not subject the projector to unstable conditions. If the projector falls or topples over, it could result in injury or damage to the projector and the surrounding things. Using a damaged projector could result in a fire and an electric shock.

- Do not place the projector in unstable places, such as an inclined surface, places subject to vibration, on top of a wobbly table or cart, or a surface that is smaller than the projector.
- Do not put the projector on its side, front or rear position.
- Do not attach nor place anything on the projector unless otherwise specified in the manual.
- Do not use any mounting accessories except the accessories specified by the manufacturer. Read and keep the manuals of the accessories used.
- For special installation such as ceiling mounting, be sure to consult your dealer beforehand.

▶ Do not install the projector near thermally conductive or flammable things. Such things when heated by the projector could result in a fire and burns.

- Do not place the projector on a metal stand.

▶ Do not place the projector where any oils, such as cooking or machine oil, are used. Oil may harm the product, resulting in malfunction, or falling from the mounted position.

▶ Do not place the projector in a place where it may get wet. Getting the projector wet or inserting liquid into the projector could cause a fire and an electric shock, and damage the projector.

- Do not place the projector near water, such as in a bathroom, kitchen, or poolside.
- Do not place the projector outdoors or by the window.
- Do not place anything containing liquid near the projector.

(continued on next page)

Arrangement (continued)

⚠ CAUTION ▶ Place the projector in a cool place with sufficient ventilation. The projector may shutdown automatically or may malfunction if its internal temperature is too high.

Using a damaged projector could result in a fire and an electric shock.

- Do not place the projector in direct sunlight or near hot objects such as heaters.
- Do not place the projector where the air from an air conditioner or similar unit will blow on it directly.
- Keep a space of 30 cm or more between a side of the projector and other objects such as walls.
- Do not place the projector on carpet, cushions or bedding.
- Do not stop up, block nor cover the projector's vent holes. Do not place anything around the projector that could be sucked in or stuck to the projector's intake vents.
- Do not place the projector at places that are exposed to magnetic fields, doing so can cause the cooling fans inside the projector to malfunction.

▶ Avoid placing the projector in smoky, humid or dusty place. Placing the projector in such places could cause a fire, an electric shock and malfunction of the projector.

- Do not place the projector near humidifiers. Especially for an ultrasonic humidifier, chlorine and minerals contained in tap water are atomized and could be deposited in the projector causing image degradation or other problems.

NOTICE • Do not place the projector in a smoking area, kitchen, passageway or by the window.

- Position the projector to prevent light from directly hitting the projector's remote sensor.
- Do not place the product in a place where radio interference may be caused.
- Check and correct the setting for ALTITUDE of SERVICE in the OPTION menu according to the usage environment (📖54). If the projector is used with a wrong setting, it may cause damage to the projector itself or the parts inside.
- Keep heat-sensitive things away from the projector. Otherwise, they may be damaged by the heat from the projector.

Connecting with your devices

Before connecting the projector to a device, consult the manual of the device to confirm that the device is suitable for connecting with this projector and prepare the required accessories, such as a cable in accord with the signal of the device. Consult your dealer when the required accessory did not come with the product or the accessory is damaged.

After making sure that the projector and the devices are turned off, perform the connection, according to the following instructions. Refer to the figures in subsequent pages.

⚠ WARNING ▶ Use only the appropriate accessories. Otherwise it could cause a fire or damage the projector and devices.

- Use only the accessories specified or recommended by the projector's manufacturer. It may be regulated under some standard.
- Neither disassemble nor modify the projector and the accessories.
- Do not use the damaged accessory. Be careful not to damage the accessories. Route a cable so that it is neither stepped on nor pinched out.

⚠ CAUTION ▶ For a cable with a core at only one end, connect the end with the core to the projector. That may be required by EMI regulations.

NOTE • Do not turn on or off the projector while connected to a device in operation, unless that is directed in the manual of the device. Otherwise it may cause malfunction in the device or projector.

- The function of some input ports can be selected according to your usage requirements. Check the reference page indicated beside each port in the following illustration.
- Be careful not to mistakenly connect a connector to a wrong port. Otherwise it may cause malfunction in the device or projector.
 - When connecting a connector to a port, make sure that the shape of the connector fits the port.
 - Tighten the screws to connect a connector equipped with screws to a port.
 - Use the cables with straight plugs, not L-shaped ones, as the input ports of the projector are recessed.

About Plug-and-Play capability

- Plug-and-Play is a system composed of a computer, its operating system and peripheral equipment (i.e. display devices). This projector is VESA DDC 2B compatible. Plug-and-Play can be used by connecting this projector to a computer that is VESA DDC (display data channel) compatible.
 - Take advantage of this feature by connecting a computer cable to the **COMPUTER IN1** port (DDC 2B compatible). Plug-and-Play may not work properly if any other type of connection is attempted.
 - Please use the standard drivers in your computer as this projector is a Plug-and-Play monitor.

(continued on next page)

Connecting with your devices (continued)

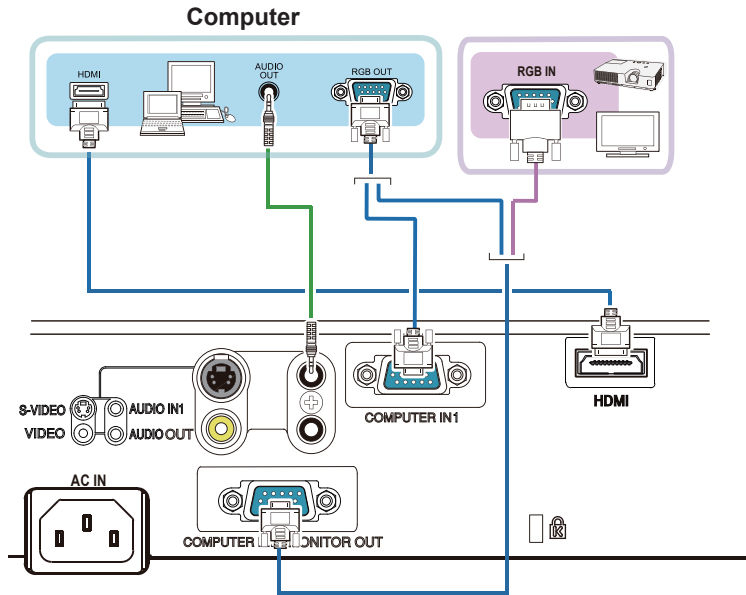

NOTE • Before connecting the projector to a computer, consult the computer's manual and check the compatibility of the signal level, the synchronization methods and the display resolution output to the projector.

- Some signal may need an adapter to input this projector.
- Some computers have multiple screen display modes that may include some signals which are not supported by this projector.
- Although the projector can display signals with resolution up to UXGA (1600x1200), the signal will be converted to the projector's panel resolution before being displayed. The best display performance will be achieved if the resolutions of the input signal and the projector panel are identical.
- If you connect this projector and a notebook computer, you need output the display to an external monitor, or output simultaneously to the internal display and an external monitor. Consult the computer's manual for the setting.
- Depending on the input signal, the automatic adjustment function of this projector may take some time and not function correctly.
- Note that a composite sync signal or sync-on-green signal may confuse the automatic adjustment function of this projector (📖 38).
- If the automatic adjustment function does not work correctly, you may not see the dialog to set the display resolution. In such a case, use an external display device. You may be able to see the dialog and set an appropriate display resolution.

(continued on next page)

Connecting with your devices (continued)

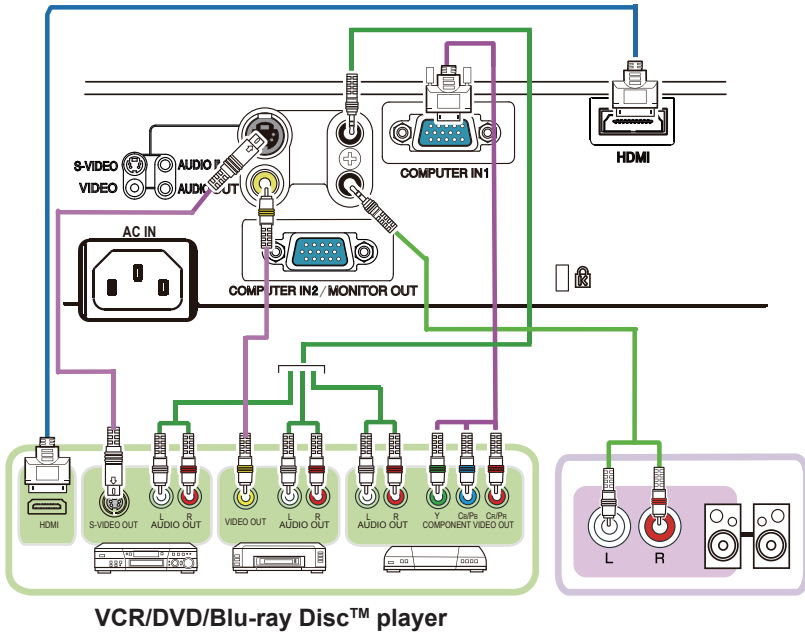

VCR/DVD/Blu-ray Disc™ player

NOTE • The **HDMI** port of this model is compatible with HDCP (High-bandwidth Digital Content Protection) and therefore capable of displaying a video signal from HDCP compatible DVD players or the like.

- The **HDMI** supports the following signals.

Video signal : 480i@60, 480p@60, 576i@50, 576p@50, 720p@50/60, 1080i@50/60, 1080p@50/60

Audio signal : Format Linear PCM

Sampling frequency 48kHz / 44.1kHz / 32kHz

- This projector can be connected with another equipment that has HDMI™ connector, but with some equipment the projector may not work properly, something like no video.

- Be sure to use an HDMI™ cable that has the HDMI™ logo.

- Use a Category 2-certified HDMI™ cable to input 1080p@50/60 signal to the projector.

- When the projector is connected with a device having DVI connector, use a DVI to HDMI™ cable to connect with the **HDMI** input.

(continued on next page)

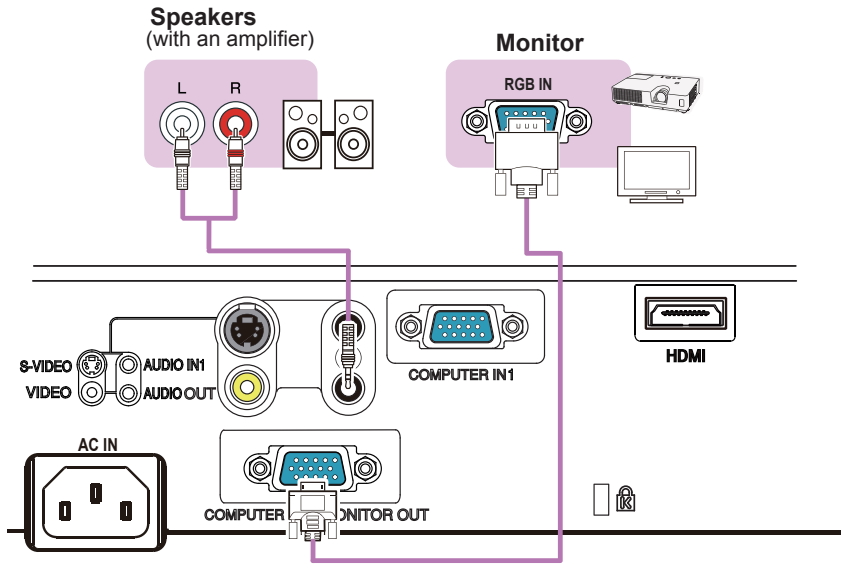
Connecting with your devices (continued)

Connecting to a power supply

1. Put the connector of the power cord into the **AC IN** (AC inlet) of the projector.
2. Firmly plug the power cord's plug into the outlet. In a couple of seconds after the power supply connection, the **POWER** indicator will light up in steady orange.

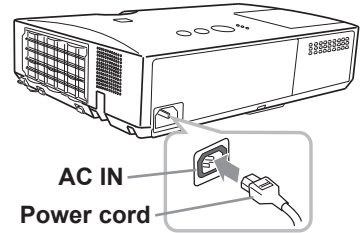

Please remember that when the DIRECT POWER ON function activated (📖 51), the connection of the power supply make the projector turn on.

⚠ WARNING ► Please use extra caution when connecting the power cord, as incorrect or faulty connections may result in fire and/or electrical shock.

- Do not touch the power cord with a wet hand.
- Only use the power cord that came with the projector. If it is damaged, consult your dealer to get a new one. Never modify the power cord.
- Only plug the power cord into an outlet whose voltage is matched to the power cord. The power outlet should be close to the projector and easily accessible. Remove the power cord for complete separation.
- Do not distribute the power supply to multiple devices. Doing so may overload the outlet and connectors, loosen the connection, or result in fire, electric shock or other accidents.
- Connect the ground terminal for the AC inlet of this unit to the ground terminal of the building using an appropriate power cord (bundled).

NOTICE ► This product is also designed for IT power systems with a phase-to-phase voltage of 220 to 240 V.

Using the security bar and slot

A commercially available anti-theft chain or wire can be attached to the security bar on the projector. Refer to the figure to choose an anti-theft chain or wire.

Also this product has the security slot for the Kensington lock.

For details, see the manual of the security tool.

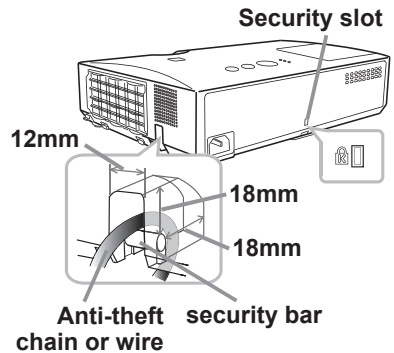
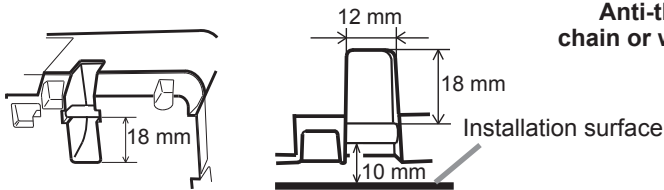

⚠ WARNING ► Do not use the security bar and slot to prevent the projector from falling down, since it is not designed for it.

⚠ CAUTION ► Do not place anti-theft chain or wire near the exhaust vents. It may become too hot.

NOTE • The security bar and slot is not comprehensive theft prevention measures. It is intended to be used as supplemental theft prevention measure.

Remote control

Installing the batteries

Please insert the batteries into the remote control before using it. If the remote control starts to malfunction, try to replace the batteries. If you will not use the remote control for long period, remove the batteries from the remote control and store them in a safe place.

1. Holding the hook part of the battery cover, remove it.
2. Align and insert the two AA batteries (**HITACHI MAXELL or HITACHI MAXELL ENERGY, Part No.LR6 or R6P**) according to their plus and minus terminals as indicated in the remote control.
3. Replace the battery cover in the direction of the arrow and snap it back into place.

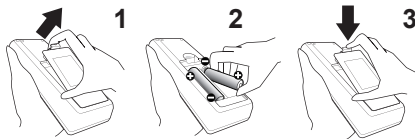

⚠ WARNING ▶ Always handle the batteries with care and use them only as directed. Improper use may result in battery explosion, cracking or leakage, which could result in fire, injury and/or pollution of the surrounding environment.

- Be sure to use only the batteries specified. Do not use batteries of different types at the same time. Do not mix a new battery with used one.
- Make sure the plus and minus terminals are correctly aligned when loading a battery.
- Keep a battery away from children and pets.
- Do not recharge, short circuit, solder or disassemble a battery.
- Do not place a battery in a fire or water. Keep batteries in a dark, cool and dry place.
- If you observe battery leakage, wipe out the leakage and then replace a battery. If the leakage adheres to your body or clothes, rinse well with water immediately.
- Obey the local laws on disposing the battery.

About the remote control signal

The remote control works with the projector's remote sensor. This projector has a remote sensor on the front. The sensor senses the signal within the following range when the sensor is active:

- 60 degrees (30 degrees to the left and right of the sensor)
- within 3 meters about.

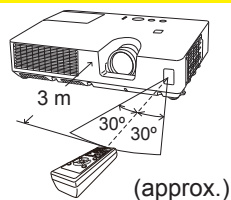

NOTE • The remote control signal reflected in the screen or the like may be available. If it is difficult to send the signal to the sensor directly, attempt to make the signal reflect.

- The remote control uses infrared light to send signals to the projector (Class 1 LED), so be sure to use the remote control in an area free from obstacles that could block the remote control's signal to the projector.
- The remote control may not work correctly if strong light (such as direct sun light) or light from an extremely close range (such as from an inverter fluorescent lamp) shines on the remote sensor of the projector. Adjust the position of projector avoiding those lights.

Power on/off

Turning on the power

1. Make sure that the power cord is firmly and correctly connected to the projector and the outlet.
2. Make sure that the **POWER** indicator is steady orange (📖69).
3. Press **STANDBY/ON** button on the projector or the remote control.
The projection lamp will light up and **POWER** indicator will begin blinking in green. When the power is completely on, the indicator will stop blinking and light in steady green (📖69).

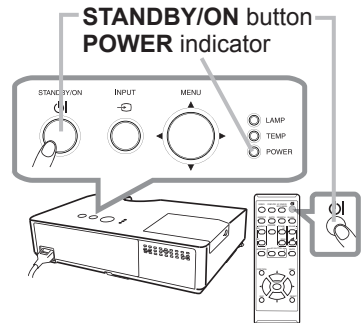

To display the picture, select an input signal according to the section **Selecting an input signal** (📖20).

The INITIAL SETTING Menu will be displayed by factory default upon startup. Once the INITIAL SETTING Menu is set, it will not appear until **FACTORY RESET** (📖56) is executed. If you wish to change the settings, refer to the **LANGUAGE** (📖30) and **ALTITUDE** (📖54) menu.

- (1) **LANGUAGE**: Use the ▲/▼/◀/▶ buttons to select the desired language and press the **ENTER** button of the remote control or the **INPUT** button of the projector to execute.

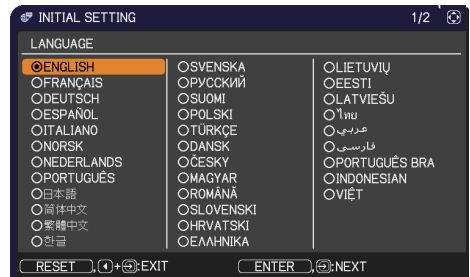

- (2) **ALTITUDE**: Use the ▲/▼ buttons to select **NORMAL** for altitude below 1600 m (5250 feet), otherwise select **HIGH** and press the **ENTER** button of the remote control or the **INPUT** button of the projector to execute.

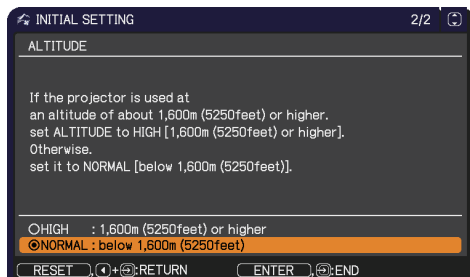

Turning off the power

1. Press the **STANDBY/ON** button on the projector or the remote control.
 - The message “Power off?” will appear on the screen for about 5 seconds.
2. Press the **STANDBY/ON** button again while the message appears.
 - The projector lamp will go off, and the **POWER** indicator will begin blinking in orange. Then **POWER** indicator will stop blinking and light in steady orange when the lamp cooling is complete (📖69).

Do not turn the projector on for about 10 minutes or more after turning it off. Also, do not turn the projector off shortly after turning it on. Such operations might cause the lamp to malfunction or shorten the lifetime of some parts including the lamp.

⚠ WARNING ▶ A strong light is emitted when the projector’s power is on. Do not look into the lens of the projector or look inside of the projector through any of the projector’s openings.
▶ Do not touch around the lamp cover and the exhaust vents during use or just after use, since it is too hot.

NOTE • Turn the power on/off in right order. Please power on the projector prior to the connected devices.
• This projector has the function that can make the projector automatically turn on/off. Please refer to the **DIRECT POWER ON** (📖51) and **AUTO POWER OFF** (📖52) items of the **OPTION** menu.

Operating

Adjusting the volume

VOLUME +/- button

- Use the **VOLUME +/VOLUME -** buttons to adjust the volume. A dialog will appear on the screen to aid you in adjusting the volume. If you do not do anything, the dialog will automatically disappear after a few seconds.
 - When \times is selected for current picture input port, the volume adjustment is disabled. Please see AUDIO SOURCE item of AUDIO menu (44).
 - Even if the projector is in the standby mode, the volume is adjustable when both of the following conditions are true:
 - An option other than \times is selected for AUDIO OUT STANDBY in the AUDIO SOURCE item of the AUDIO menu (44).
 - NORMAL is selected in the STANDBY MODE item of the SETUP menu (43).
 - In the standby mode, the volume of the microphone is adjustable with the **VOLUME +/-** buttons on the remote control, in synchronization with the volume of the projector.

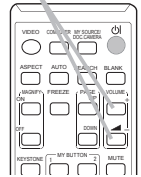
**Temporarily muting the sound**

MUTE button

- Press **MUTE** button on the remote control. A dialog will appear on the screen indicating that you have muted the sound. To restore the sound, press the **MUTE, VOLUME +** or **VOLUME -** button. Even if you do not do anything, the dialog will automatically disappear after a few seconds.
 - When \times is selected for current picture input port, the sound is always muted. Please see AUDIO SOURCE item of AUDIO menu (44).
 - C.C. (Closed Caption) is automatically activated when sound is muted and an input signal containing C.C. is received. This function is available only when the signal is NTSC for **VIDEO** or **S-VIDEO**, or 480i@60 for **COMPUTER IN1** or **COMPUTER IN2**, and when AUTO is selected for DISPLAY in the C.C. menu under the SCREEN menu (50).

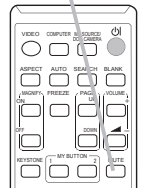

Selecting an input signal

1. Press **INPUT** button on the projector.
 - Each time you press the button, the projector switches its input port from the current port as below.

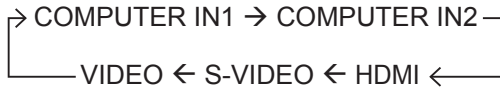

INPUT button

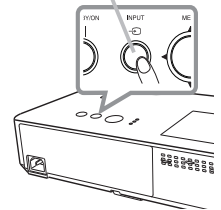

- While ON is selected for AUTO SEARCH item in OPTION menu (51), the projector will keep checking the ports in above order repeatedly till an input signal is detected.

1. Press **COMPUTER** button on the remote control.
 - Each time you press the button, the projector switches its input port from the current port as below.



COMPUTER button

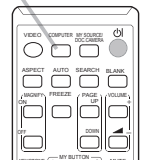

- While ON is selected for AUTO SEARCH item in OPTION menu, the projector will keep checking every port sequentially till an input signal is detected (51). If **COMPUTER** button is pressed when **VIDEO**, **S-VIDEO** or **HDMI** port is selected, the projector will check **COMPUTER IN1** port first.

1. Press **VIDEO** button on the remote control.
 - Each time you press the button, the projector switches its input port from the current port as below.



VIDEO button

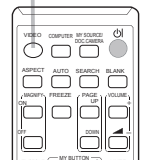

- While ON is selected for AUTO SEARCH item in OPTION menu, the projector will keep checking every port sequentially till an input signal is detected (51). If **VIDEO** button is pressed when **COMPUTER IN1** or **COMPUTER IN2** port is selected, the projector will check the **HDMI** port first.

1. Press the **MY SOURCE / DOC. CAMERA** button on the remote control. The input signal will be changed into the signal you set as MY SOURCE (54).

MY SOURCE / DOC. CAMERA button

- This function also can use for document camera. Select the input port that connected the document camera.

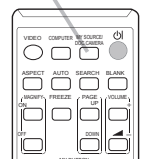

Searching an input signal

1. Press **SEARCH** button on the remote control.
 - The projector will start to check its input ports as below in order to find any input signals. When an input is found, the projector will stop searching and display the image. If no signal is found, the projector will return to the state selected before the operation.

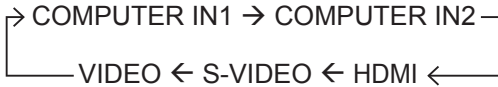

- While ON is selected for AUTO SEARCH item in OPTION menu (51), the projector will keep checking the ports in above order repeatedly till an input signal is detected.

SEARCH button

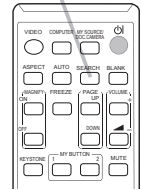

Selecting an aspect ratio

1. Press **ASPECT** button on the remote control.
 - Each time you press the button, the projector switches the mode for aspect ratio in turn.

○ For a computer signal

NORMAL → 4:3 → 16:9 → 16:10



○ For an HDMI™ signal

NORMAL → 4:3 → 16:9 → 16:10 → 14:9



○ For a video signal, s-video signal or component video signal

4:3 → 16:9 → 14:9



○ For no signal

4:3 (fixed)

- **ASPECT** button does not work when no proper signal is inputted.
- **NORMAL** mode keeps the original aspect ratio setting.

ASPECT button

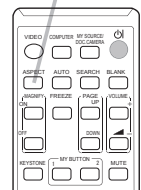

Adjusting the projector's elevator

When the place to put the projector is slightly uneven to the left or right, use the elevator feet to place the projector horizontally.

Using the feet can also tilt the projector in order to project at a suitable angle to the screen, elevating the front side of the projector within 12 degrees.

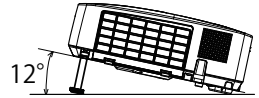

This projector has 2 elevator feet and 2 elevator knobs. An elevator foot is adjustable while pulling up the elevator knob on the same side as it.

1. Holding the projector, pull the elevator knobs up to loose the elevator feet.
2. Position the front side of the projector to the desired height.
3. Release the elevator knobs in order to lock the elevator feet.
4. After making sure that the elevator feet are locked, put the projector down gently.
5. If necessary, the elevator feet can be manually twisted to make more precise adjustments. Hold the projector when twisting the feet.

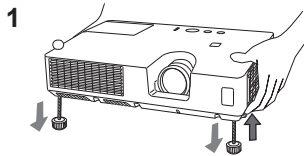

To loose an elevator knob, pull up the elevator knob on the same side as it.

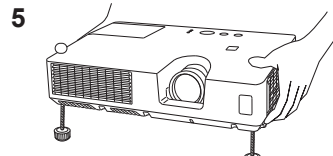

To finely adjust, twist the foot.

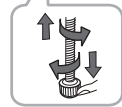

⚠ CAUTION ► Do not handle the elevator buttons without holding the projector, since the projector may drop down.

► Do not tilt the projector other than elevating its front within 12 degrees using the adjuster feet. A tilt of the projector exceeding the restriction could cause malfunction or shortening the lifetime of consumables, or the projector itself.

Adjusting the zoom and focus

1. Use the **ZOOM** ring to adjust the screen size.
2. Use the **FOCUS** ring to focus the picture.

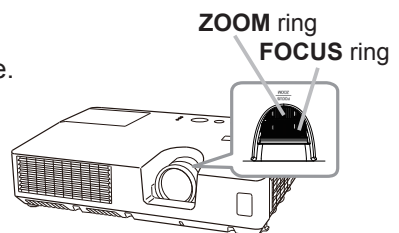

Using the automatic adjustment feature

1. Press **AUTO** button on the remote control.
Pressing this button performs the following.

- **For a computer signal**

The vertical position, the horizontal position and the horizontal phase will be automatically adjusted.

Make sure that the application window is set to its maximum size prior to attempting to use this feature. A dark picture may still be incorrectly adjusted. Use a bright picture when adjusting.

- **For a video signal and s-video signal**

The video format best suited for the respective input signal will be selected automatically. This function is available only when the AUTO is selected for the VIDEO FORMAT item in the INPUT menu ([438](#)). The vertical position and horizontal position will be automatically set to the default.

- **For a component video signal**

The vertical position and horizontal position will be automatically set to the default. The horizontal phase will be automatically adjusted.

- The automatic adjustment operation requires approx. 10 seconds. Also please note that it may not function correctly with some input.
- When this function is performed for a video signal, a certain extra such as a line may appear outside a picture.
- When this function is performed for a computer signal, a black frame may be displayed on the edge of the screen, depending on the computer model.
- The items adjusted by this function may vary when the FINE or DISABLE is selected for the AUTO ADJUST item of the SERVICE item in the OPTION menu ([54](#)).

AUTO button

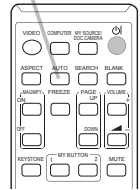

Adjusting the position

1. Press **POSITION** button on the remote control when no menu is indicated.
The "POSITION" indication will appear on the screen.
2. Use the **▲/▼/◀/▶** cursor buttons to adjust the picture position.
When you want to reset the operation, press **RESET** button on the remote control during the operation.
To complete this operation, press **POSITION** button again. Even if you do not do anything, the dialog will automatically disappear after a few seconds.

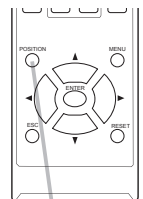

POSITION button

- When this function is performed on a video signal or an s-video signal, some image such as an extra-line may appear at outside of the picture.
- When this function is performed on a video signal or s-video signal, the range of this adjustment depends on OVER SCAN in IMAGE menu ([34](#)) setting. It is not possible to adjust when OVER SCAN is set to 10.
- If **POSITION** button is pressed when a menu is indicated on screen, the displayed picture does not move its position but the menu does.
- This function is unavailable for signal from the **HDMI** port.

Correcting the keystone distortions

1. Press **KEYSTONE** button on the remote control. A dialog will appear on the screen to aid you in correcting the distortion.
2. Use the ◀/▶ buttons for adjustment.
To close the dialog and complete this operation, press **KEYSTONE** button again. Even if you do not do anything, the dialog will automatically disappear after a few seconds.

KEYSTONE button

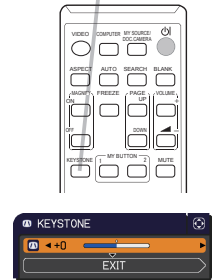

- The menu or dialog will automatically disappear after several seconds of inactivity. Pressing the **KEYSTONE** button again finishes the operation and closes the menu or dialog.
- The adjustable range of this function will vary among inputs. For some input, this function may not work well.
- When the projector is placed on the level (about $\pm 4^\circ$), the automatic keystone distortion correction may not work.
- When the projector is inclined to near ± 30 degree or over, this function may not work well.

Using the magnify feature

MAGNIFY ON/OFF button

1. Press the **MAGNIFY ON** button on the remote control. The picture will be magnified, and the MAGNIFY dialog will appear on the screen. When the **MAGNIFY ON** button is pressed for the first time after the projector is turned on, the picture will be zoomed by 1.5 times. On the dialog, triangle marks to show each direction will be displayed.

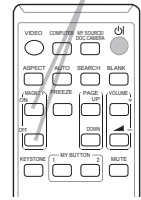
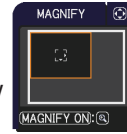

2. The display magnification of the projector switches in order with every press of the **MAGNIFY ON** button.

- For computer signals or HDMI™ (RGB) signals

1.5 times → 2 times → 3 times → 4 times → 1 time



- For video signals, s-video signals, component video signals or HDMI™ (Component) signals

1.5 times → 2 times → 1 time



3. While the triangles are displayed on the dialog, use the ▲/▼/◀/▶ cursor buttons to shift the magnifying area.

4. Press the **MAGNIFY OFF** button on the remote control to exit magnification.

- The MAGNIFY dialog will automatically disappear in several seconds with no operation. The dialog will appear again if the **MAGNIFY ON** button is pressed when the dialog has automatically disappeared.
- The magnification is automatically disabled when the displaying signal or its display condition is changed.
- While the magnification is active, the keystone distortion condition may vary. It will be restored when the magnification is disabled.
- Some horizontal stripes might be visible on the image while magnification is active.
- This function is not available in the following cases:
 - A sync signal in the range not supported is input.
 - There is no input signal.

Temporarily freezing the screen

1. Press the **FREEZE** button on the remote control.
 The “FREEZE” indication will appear on the screen (however, the indication will not appear when the OFF is selected for the MESSAGE item in the SCREEN menu (📖47)), and the projector will go into the FREEZE mode, which the picture is frozen.
 To exit the FREEZE mode and restore the screen to normal, press the **FREEZE** button again.

FREEZE button

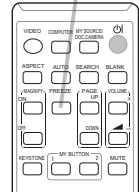

- The projector automatically exits from the FREEZE mode when some control buttons are pressed.
- If the projector continues projecting a still image for a long time, the LCD panel might possibly be burned in. Do not leave the projector in the FREEZE mode for too long.
- Images might appear degraded when this function is operated, but it is not a malfunction.

Temporarily blanking the screen

1. Press **BLANK** button on the remote control.
 The BLANK screen will be displayed instead of the screen of input signal. Please refer to BLANK item in SCREEN menu (📖45).
 To exit from the BLANK screen and return to the input signal screen, press **BLANK** button again.

BLANK button

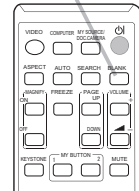

- The projector automatically exits from the BLANK mode when some control buttons are pressed.

⚠ CAUTION ▶ If you wish to have a blank screen while the projector's lamp is on, use the BLANK function above. Taking any other action may cause the damage on the projector.

NOTE • The sound is not connected with the BLANK screen function. If necessary, set the volume or mute first. To display the BLANK screen and mute the sound at one time, use AV MUTE function (📖53).

Using the menu function

This projector has the following menus:

PICTURE, IMAGE, INPUT, SETUP, AUDIO, SCREEN, OPTION, SECURITY and EASY MENU.

EASY MENU consists of functions often used, and the other menus are classified into each purpose and brought together as the ADVANCED MENU.

Each of these menus is operated using the same methods. While the projector is displaying any menu, the **MENU** button on the projector works as the cursor buttons. The basic operations of these menus are as follows.

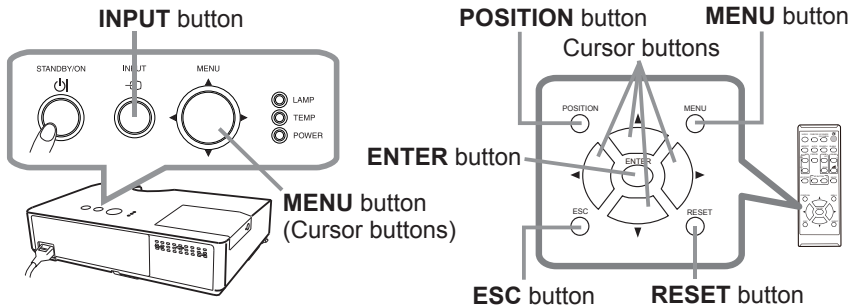

1. To start the MENU, press the **MENU** button. The MENU you last used (EASY or ADVANCED) will appear. EASY MENU has priority to appear just after powered on.

2. In the EASY MENU

- (1) Use the **▲/▼** cursor buttons to select an item to operate. If you want to change it to the ADVANCED MENU, select the ADVANCED MENU.
- (2) Use the **◀/▶** cursor buttons to operate the item.

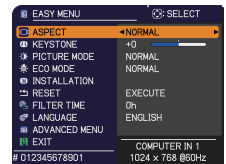

In the ADVANCED MENU

- (1) Use the **▲/▼** cursor buttons to select a menu. If you want to change it to the EASY MENU, select the EASY MENU. The items in the menu appear on the right side.
- (2) Press the **▶** cursor button or **ENTER** button to move the cursor to the right side. Then use the **▲/▼** cursor buttons to select an item to operate and press the **▶** cursor button or **ENTER** button to progress. The operation menu or dialog of the selected item will appear.
- (3) Use the buttons as instructed in the OSD to operate the item.



(continued on next page)

Using the menu function (continued)

3. To close the MENU, press the **MENU** button again or select EXIT and press the ◀ cursor button or **ENTER** button. Even if you do not do anything, the dialog will automatically disappear after about 30 seconds.
 - If you want to move the menu position, use the cursor buttons after pressing the **POSITION** button.
 - Some functions cannot be performed when a certain input port is selected, or when a certain input signal is displayed.
 - When you want to reset the operation, press **RESET** button on the remote control during the operation. Note that some items (ex. LANGUAGE, VOLUME) cannot be reset.
 - In the **ADVANCED MENU**, when you want to return to the previous display, press the ◀ cursor button or **ESC** button on the remote control.

Indication in OSD (On Screen Display)

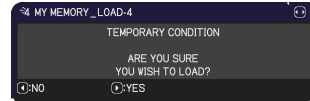
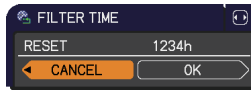

The meanings of the general words on the OSD are as follows.

Indication	Meaning
EXIT	Selecting this word finishes the OSD menu. It's the same as pressing the MENU button.
RETURN	Selecting this word returns the menu to the previous menu.
CANCEL or NO	Selecting this word cancels the operation in the present menu and returns to the previous menu.
OK or YES	Selecting this word executes the prepared function or shifts the menu to the next menu.

EASY MENU

From the EASY MENU, items shown in the table below can be performed.

Select an item using the ▲/▼ cursor buttons. Then perform it according to the following table.

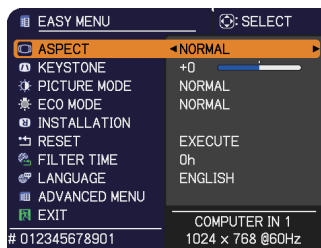

Item	Description																								
ASPECT	Using the ◀/▶ buttons switches the mode for aspect ratio. See the ASPECT item in IMAGE menu (📺34).																								
KEYSTONE	Using the ◀/▶ buttons corrects the vertical keystone distortion. See the ⏏ KEYSTONE item in SETUP menu (📺41).																								
PICTURE MODE	<p>Using the ◀/▶ buttons switches the picture mode. The picture modes are combinations of GAMMA and COLOR TEMP settings. Choose a suitable mode according to the projected source.</p> <p> ↪ NORMAL ⇄ CINEMA ⇄ DYNAMIC ⇄ BOARD(BLACK) ↩ ↪ DAYTIME ⇄ WHITEBOARD ⇄ BOARD(GREEN) ↩ </p> <table border="1"> <thead> <tr> <th></th> <th>GAMMA</th> <th>COLOR TEMP</th> </tr> </thead> <tbody> <tr> <td>NORMAL</td> <td>1 DEFAULT</td> <td>2 MID</td> </tr> <tr> <td>CINEMA</td> <td>2 DEFAULT</td> <td>3 LOW</td> </tr> <tr> <td>DYNAMIC</td> <td>3 DEFAULT</td> <td>1 HIGH</td> </tr> <tr> <td>BOARD(BLACK)</td> <td>4 DEFAULT</td> <td>4 Hi-BRIGHT-1</td> </tr> <tr> <td>BOARD(GREEN)</td> <td>4 DEFAULT</td> <td>5 Hi-BRIGHT-2</td> </tr> <tr> <td>WHITEBOARD</td> <td>5 DEFAULT</td> <td>2 MID</td> </tr> <tr> <td>DAYTIME</td> <td>6 DEFAULT</td> <td>6 Hi-BRIGHT-3</td> </tr> </tbody> </table> <ul style="list-style-type: none"> • When the combination of GAMMA and COLOR TEMP differs from pre-assigned modes above, the display on the menu for the PICTURE MODE is “CUSTOM”. Please refer to the GAMMA and COLOR TEMP (📺31, 32) items in PICTURE menu. • Lines or other noise might appear on the screen when this function is operated, but it is not a malfunction. 		GAMMA	COLOR TEMP	NORMAL	1 DEFAULT	2 MID	CINEMA	2 DEFAULT	3 LOW	DYNAMIC	3 DEFAULT	1 HIGH	BOARD(BLACK)	4 DEFAULT	4 Hi-BRIGHT-1	BOARD(GREEN)	4 DEFAULT	5 Hi-BRIGHT-2	WHITEBOARD	5 DEFAULT	2 MID	DAYTIME	6 DEFAULT	6 Hi-BRIGHT-3
	GAMMA	COLOR TEMP																							
NORMAL	1 DEFAULT	2 MID																							
CINEMA	2 DEFAULT	3 LOW																							
DYNAMIC	3 DEFAULT	1 HIGH																							
BOARD(BLACK)	4 DEFAULT	4 Hi-BRIGHT-1																							
BOARD(GREEN)	4 DEFAULT	5 Hi-BRIGHT-2																							
WHITEBOARD	5 DEFAULT	2 MID																							
DAYTIME	6 DEFAULT	6 Hi-BRIGHT-3																							

(continued on next page)

EASY MENU

Item	Description
ECO MODE	Using the ◀/▶ buttons switches ECO MODE. See the ECO MODE item in SETUP menu (41).
INSTALLATION	Pressing the ▶ button displays the INSTALLATION dialog. See the INSTALLATION item in SETUP menu (42).
RESET	Performing this item resets all of the EASY MENU items except the FILTER TIME and LANGUAGE. A dialog is displayed for confirmation. Selecting the OK using the ▶ button performs resetting.
FILTER TIME	The usage time of the air filter is shown in the menu. Performing this item resets the filter time which counts usage time of the air filter. A dialog is displayed for confirmation. Selecting the OK using the ▶ button performs resetting. See the FILTER TIME item in OPTION menu (52).
LANGUAGE	Using the ◀/▶ buttons changes the display language. See the LANGUAGE item in SCREEN menu (45).
ADVANCED MENU	Press the ▶ or ENTER button to use the menu of PICTURE, IMAGE, INPUT, SETUP, AUDIO, SCREEN, OPTION or SECURITY.
EXIT	Press the ◀ or ENTER button to finish the OSD menu.

PICTURE menu

From the PICTURE menu, items shown in the table below can be performed.

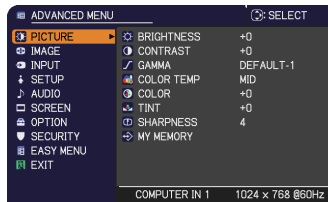

Select an item using the ▲/▼ cursor buttons, and press the ► cursor button or **ENTER** button to execute the item. Then perform it according to the following table.

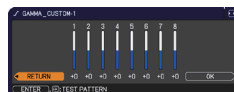

Item	Description
BRIGHTNESS	Using the ◀/▶ buttons adjusts the brightness. Dark ⇔ Light
CONTRAST	Using the ◀/▶ buttons adjusts the contrast. Weak ⇔ Strong
GAMMA	<p>Using the ▲/▼ buttons switches the gamma mode.</p> <p>1 DEFAULT ⇔ 1 CUSTOM ⇔ 2 DEFAULT ⇔ 2 CUSTOM ⇔ 3 DEFAULT ⇕ 6 CUSTOM ⇕ 6 DEFAULT ⇔ 5 CUSTOM ⇔ 5 DEFAULT ⇔ 4 CUSTOM ⇔ 4 DEFAULT ⇕ 3 CUSTOM ⇕ 6 DEFAULT ⇔ 5 CUSTOM ⇔ 5 DEFAULT ⇔ 4 CUSTOM ⇔ 4 DEFAULT</p> <p>To adjust CUSTOM</p> <p>Selecting a mode whose name includes CUSTOM and then pressing the ► button or the ENTER button displays a dialog to aid you in adjusting the mode. This function is useful when you want to change the brightness of particular tones.</p> <p>Choose an item using the ◀/▶ buttons, and adjust the level using the ▲/▼ buttons.</p> <p>You can display a test pattern for checking the effect of your adjustment by pressing the ENTER button. Each time you press the ENTER button, the pattern changes as below.</p> <p>No pattern ⇔ Gray scale of 9 steps ⇐ ⇐⇐⇐ Ramp ⇔ Gray scale of 15 steps</p> <p>The eight equalizing bars correspond to eight tone levels of the test pattern (Gray scale of 9 steps) except the darkest in the left end. If you want to adjust the 2nd tone from left end on the test pattern, use the equalizing adjustment bar "1". The darkest tone at the left end of the test pattern cannot be controlled with any of equalizing adjustment bar.</p> <ul style="list-style-type: none"> • Lines or other noise might appear on the screen when this function is operated, but it is not a malfunction.

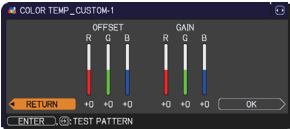

(continued on next page)

Item	Description
<p>COLOR TEMP</p>	<p>Using the ▲/▼ buttons switches the color temperature mode.</p> <p>1 HIGH ⇔ 1 CUSTOM ⇔ 2 MID ⇔ 2 CUSTOM ⇕ 6 CUSTOM ⇕ ⇕ 3 LOW ⇕ 6 Hi-BRIGHT-3 ⇕ ⇕ 3 CUSTOM ⇕ 5 CUSTOM ⇔ 5 Hi-BRIGHT-2 ⇔ 4 CUSTOM ⇔ 4 Hi-BRIGHT-1</p> <p>To adjust CUSTOM</p> <p>Selecting a mode whose name includes CUSTOM and then pressing the ► button or the ENTER button displays a dialog to aid you in adjusting the OFFSET and GAIN of the selected mode.</p>  <p>OFFSET adjustments change the color intensity on the whole tones of the test pattern. GAIN adjustments mainly affect color intensity on the brighter tones of the test pattern.</p> <p>Choose an item using the ◀/▶ buttons, and adjust the level using the ▲/▼ buttons.</p> <p>You can display a test pattern for checking the effect of your adjustment by pressing the ENTER button. Each time you press the ENTER button, the pattern changes as below.</p> <p>No pattern ⇔ Gray scale of 9 steps ⇐ ⇑ ⇐ Ramp ⇔ Gray scale of 15 steps</p> <ul style="list-style-type: none"> • Lines or other noise might appear on the screen when this function is operated, but it is not a malfunction. 
<p>COLOR</p>	<p>Using the ◀/▶ buttons adjusts the strength of whole color. Weak ⇔ Strong</p> <ul style="list-style-type: none"> • This item can be selected only for a video, s-video and component video signal. • For an HDMI™ signal, this item can also be selected if either (1) or (2) applies. (1) HDMI FORMAT item in the INPUT menu is set to VIDEO. (2) HDMI FORMAT item in the INPUT menu is set to AUTO, and the projector recognizes that it receives video signals.
<p>TINT</p>	<p>Using the ◀/▶ buttons adjusts the tint. Reddish ⇔ Greenish</p> <ul style="list-style-type: none"> • This item can be selected only for a video, s-video and component video signal. • For an HDMI™ signal, this item can also be selected if either (1) or (2) applies. (1) HDMI FORMAT item in the INPUT menu is set to VIDEO. (2) HDMI FORMAT item in the INPUT menu is set to AUTO, and the projector recognizes that it receives video signals.



Item	Description
SHARPNESS	<p>Using the ◀/▶ buttons adjusts the sharpness. Weak ⇔ Strong</p> <ul style="list-style-type: none"> • There may be some noise and/or the screen may flicker for a moment when an adjustment is made. This is not a malfunction.
MY MEMORY	<p>This projector has 4 memories for adjustment data (for all the items of the PICTURE menu). Selecting a function using the ▲/▼ buttons and pressing the ▶ or ENTER button performs each function.</p> <p style="text-align: center;">  </p> <p><u>SAVE-1, SAVE-2, SAVE-3, SAVE-4</u> Performing a SAVE function saves the current adjustment data into the memory linked in the number included in the function's name.</p> <ul style="list-style-type: none"> • Remember that the current data being stored of a memory will be lost by saving new data into the memory. <p><u>LOAD-1, LOAD-2, LOAD-3, LOAD-4</u> Performing a LOAD function loads the data from the memory linked in the number included in the function's name, and adjusts the picture automatically depending on the data.</p> <ul style="list-style-type: none"> • The LOAD functions whose linked memory has no data are skipped. • Remember that the current adjusted condition will be lost by loading data. If you want to keep the current adjustment, please save it before performing a LOAD function. • There may be some noise and the screen may flicker for a moment when loading data. This is not malfunction. • You can perform the LOAD function using MY BUTTON. Please see MY BUTTON item in OPTION menu ( 53).

IMAGE menu

From the IMAGE menu, items shown in the table below can be performed.

Select an item using the ▲/▼ cursor buttons, and press the ► cursor button or **ENTER** button to execute the item. Then perform it according to the following table.

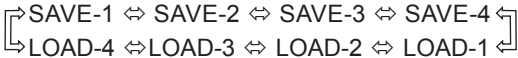

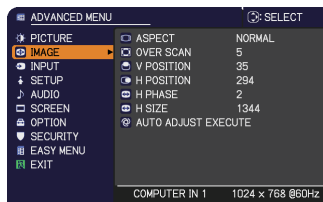
Item	Description
<p>ASPECT</p>	<p>Using the ▲/▼ buttons switches the mode for aspect ratio.</p> <p>For a computer signal NORMAL ⇔ 4:3 ⇔ 16:9 ⇔ 16:10 ↑—————↑</p> <p>For an HDMI™ signal NORMAL ⇔ 4:3 ⇔ 16:9 ⇔ 16:10 ⇔ 14:9 ↑—————↑</p> <p>For a video signal, s-video signal or component video signal 4:3 ⇔ 16:9 ⇔ 14:9 ↑—————↑</p> <p>For no signal. 4:3 (fixed)</p> <ul style="list-style-type: none"> • The NORMAL mode keeps the original aspect ratio of the signal.
<p>OVER SCAN</p>	<p>Using the ◀/▶ buttons adjusts the over-scan ratio. Small (It magnifies picture) ⇔ Large (It reduces picture)</p> <ul style="list-style-type: none"> • This item can be selected only for a video, s-video and component video signal. • For an HDMI™ signal, this item can also be selected if either (1) or (2) applies. <ol style="list-style-type: none"> (1) HDMI FORMAT item in the INPUT menu is set to VIDEO. (2) HDMI FORMAT item in the INPUT menu is set to AUTO, and the projector recognizes that it receives video signals.

(continued on next page)

Item	Description
V POSITION	<p>Using the ◀/▶ buttons adjusts the vertical position. Down ⇔ Up</p> <ul style="list-style-type: none"> • Over-adjusting the vertical position may cause noise to appear on the screen. If this occurs, please reset the vertical position to the default setting. Pressing the RESET button when the V POSITION is selected will reset the V POSITION to the default setting. • When this function is performed on a video signal or an s-video signal, the range of this adjustment depends on OVER SCAN (📖 34) setting. It is not possible to adjust when OVER SCAN is set to 10. • This function is unavailable for signal from the HDMI port.
H POSITION	<p>Using the ◀/▶ buttons adjusts the horizontal position. Right ⇔ Left</p> <ul style="list-style-type: none"> • Over-adjusting the horizontal position may cause noise to appear on the screen. If this occurs, please reset the horizontal position to the default setting. Pressing the RESET button when the H POSITION is selected will reset the H POSITION to the default setting. • When this function is performed on a video signal or an s-video signal, the range of this adjustment depends on OVER SCAN (📖 34) setting. It is not possible to adjust when OVER SCAN is set to 10. • This function is unavailable for signal from the HDMI port.
H PHASE	<p>Using the ◀/▶ buttons adjusts the horizontal phase to eliminate flicker. Right ⇔ Left</p> <ul style="list-style-type: none"> • This item can be selected only for a computer signal or a component video signal. This function is unavailable for signal from the HDMI port.
H SIZE	<p>Using the ◀/▶ buttons adjusts the horizontal size. Small ⇔ Large</p> <ul style="list-style-type: none"> • This item can be selected only for a computer signal. This function is unavailable for signal from the HDMI port. • When this adjustment is excessive, the picture may not be displayed correctly. In such a case, please reset the adjustment by pressing the RESET button on the remote control during this operation. • Images might appear degraded when this function is operated, but it is not a malfunction.

(continued on next page)

Item	Description
<p>AUTO ADJUST EXECUTE</p>	<p>Selecting this item performs the automatic adjustment feature.</p> <p>For a computer signal The vertical position, the horizontal position and the horizontal phase will be automatically adjusted. Make sure that the application window is set to its maximum size prior to attempting to use this feature. A dark picture may still be incorrectly adjusted. Use a bright picture when adjusting.</p> <p>For a video signal and s-video signal The video format best suited for the respective input signal will be selected automatically. This function is available only when the AUTO is selected for the VIDEO FORMAT item in the INPUT menu (📖38). The vertical position and horizontal position will be automatically set to the default.</p> <p>For a component video signal The vertical position and horizontal position will be automatically set to the default. The horizontal phase will be automatically adjusted.</p> <ul style="list-style-type: none"> • The automatic adjustment operation requires approx. 10 seconds. Also please note that it may not function correctly with some input. • When this function is performed for a video signal, a certain extra such as a line may appear outside a picture. • When this function is performed for a computer signal, a black frame may be displayed on the edge of the screen, depending on the computer model. • The items adjusted by this function may vary when the FINE or DISABLE is selected for the AUTO ADJUST item of the SERVICE item in the OPTION menu (📖54).

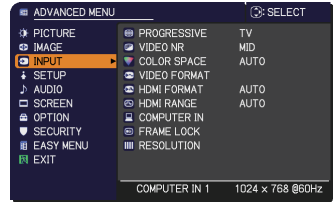

INPUT menu



From the INPUT menu, items shown in the table below can be performed. Select an item using the ▲/▼ cursor buttons, and press the ► cursor button or **ENTER** button to execute the item. Then perform it according to the following table.

Item	Description
<p>PROGRESSIVE</p>	<p>Using the ▲/▼ buttons switches the progress mode. TV ⇄ FILM ⇄ OFF ↑—————↑</p> <ul style="list-style-type: none"> • This function works only for a video signal, s-video signal, component video signal (of 480i@60 or 576i@50 or 1080i@50/60) and an HDMI™ signal (of 480i@60 or 576i@50 or 1080i@50/60). • When TV or FILM is selected, the screen image will be sharp. FILM adapts to the 2-3 Pull-Down conversion system. But these may cause a certain defect (for example, jagged line) of the picture for a quick moving object. In such a case, please select OFF, even though the screen image may lose sharpness.
<p>VIDEO NR</p>	<p>Using the ▲/▼ buttons switches the noise reduction mode. HIGH ⇄ MID ⇄ LOW ↑—————↑</p> <ul style="list-style-type: none"> • This function works only for a video signal, s-video signal, component video signal (of 480i@60 or 576i@50 or 1080i@50/60) and an HDMI™ signal (of 480i@60 or 576i@50 or 1080i@50/60).
<p>COLOR SPACE</p>	<p>Using the ▲/▼ buttons switches the mode for color space. AUTO ⇄ RGB ⇄ SMPTE240 ⇄ REC709 ⇄ REC601 ↑—————↑</p> <ul style="list-style-type: none"> • This item can be selected only for a computer signal or a component video signal. • The AUTO mode automatically selects the optimum mode. • The AUTO operation may not work well at some signals. In such a case, it might be good to select a suitable mode except AUTO.

(continued on next page)

Item	Description								
<p>VIDEO FORMAT</p>	<p>The video format for S-VIDEO port and VIDEO port can be set.</p> <p>(1) Use the ▲/▼ buttons to select the input port.</p> <p>(2) Using the ◀/▶ buttons switches the mode for video format.</p>  <p>AUTO ⇄ NTSC ⇄ PAL ⇄ SECAM ⤴ N-PAL ⇄ M-PAL ⇄ NTSC4.43 ⤵</p> <ul style="list-style-type: none"> • This item is performed only for a video signal from the VIDEO port or the S-VIDEO port. • The AUTO mode automatically selects the optimum mode. • The AUTO operation may not work well for some signals. If the picture becomes unstable (e.g. an irregular picture, lack of color), please select the mode according to the input signal. 								
<p>HDMI FORMAT</p>	<p>Using the ▲/▼ cursor buttons switches the video format for an input from the HDMI port.</p> <p>AUTO ⇄ VIDEO ⇄ COMPUTER</p>  <table border="1" data-bbox="305 722 1023 863"> <thead> <tr> <th></th> <th>Feature</th> </tr> </thead> <tbody> <tr> <td>AUTO</td> <td>automatically sets the optimum mode.</td> </tr> <tr> <td>VIDEO</td> <td>sets the suitable mode for DVD signals.</td> </tr> <tr> <td>COMPUTER</td> <td>sets the suitable mode for computer signals.</td> </tr> </tbody> </table> <ul style="list-style-type: none"> • When the COMPUTER is selected, the functions COLOR (PICTURE menu), TINT (PICTURE menu) and OVER SCAN (IMAGE menu) are unavailable. 		Feature	AUTO	automatically sets the optimum mode.	VIDEO	sets the suitable mode for DVD signals.	COMPUTER	sets the suitable mode for computer signals.
	Feature								
AUTO	automatically sets the optimum mode.								
VIDEO	sets the suitable mode for DVD signals.								
COMPUTER	sets the suitable mode for computer signals.								
<p>HDMI RANGE</p>	<p>Using the ▲/▼ cursor buttons changes the digital range for input from the HDMI port.</p> <p>AUTO ⇄ NORMAL ⇄ ENHANCED</p>  <table border="1" data-bbox="305 1090 1023 1230"> <thead> <tr> <th></th> <th>Feature</th> </tr> </thead> <tbody> <tr> <td>AUTO</td> <td>automatically sets the optimum mode.</td> </tr> <tr> <td>NORMAL</td> <td>sets the suitable mode for DVD signals. (16-235)</td> </tr> <tr> <td>ENHANCED</td> <td>sets the suitable mode for computer signals. (0-255)</td> </tr> </tbody> </table> <ul style="list-style-type: none"> • If the contrast of the screen image is too strong or too weak, try finding a more suitable mode. 		Feature	AUTO	automatically sets the optimum mode.	NORMAL	sets the suitable mode for DVD signals. (16-235)	ENHANCED	sets the suitable mode for computer signals. (0-255)
	Feature								
AUTO	automatically sets the optimum mode.								
NORMAL	sets the suitable mode for DVD signals. (16-235)								
ENHANCED	sets the suitable mode for computer signals. (0-255)								

(continued on next page)

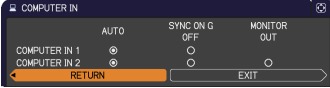
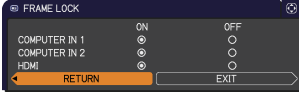
Item	Description
<p>COMPUTER IN</p>	<p>The computer input signal type for COMPUTER IN1 and IN2 ports can be set.</p> <p>(1) Use the ▲/▼ buttons to select the COMPUTER IN port to be set.</p> <p>(2) Use the ◀/▶ buttons to select the computer input signal type.</p> <p>(COMPUTER IN1) AUTO ⇔ SYNC ON G OFF</p> <p>(COMPUTER IN2) AUTO ⇔ SYNC ON G OFF ⇔ MONITOR OUT</p> <ul style="list-style-type: none"> • Selecting the AUTO mode allows you to input a sync on G signal or component video signal from the port (11, 13). • In the AUTO mode, the picture may be distorted with certain input signals. In such a case, remove the signal connector so that no signal is received and select the SYNC ON G OFF, and then reconnect the signal. 
<p>FRAME LOCK</p>	<p>Set the frame lock function on/off for each port.</p> <p>(1) Use the ▲/▼ buttons to select the input ports.</p> <p>(2) Use the ◀/▶ buttons to turn the frame lock function on/off .</p> <p>ON ⇔ OFF</p> <ul style="list-style-type: none"> • This item can be performed only on a signal with a vertical frequency of 49 to 51Hz, 59 to 61 Hz. • When ON is selected, moving pictures are displayed more smoothly. 

(continued on next page)

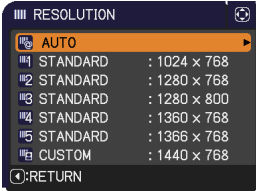
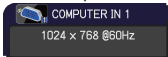
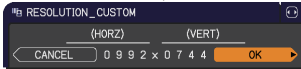
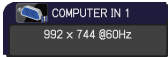

Item	Description
<p>RESOLUTION</p>	<p>The resolution for the COMPUTER IN1 and COMPUTER IN2 input signals can be set on this projector.</p> <p>(1) In the INPUT menu select the RESOLUTION using the ▲/▼ buttons and press the ► button. The RESOLUTION menu will be displayed.</p>  <p>(2) In the RESOLUTION menu select the resolution you wish to display using the ▲/▼ buttons. Selecting AUTO will set a resolution appropriate to the input signal.</p> <p>(3) Pressing the ► or ENTER button when selecting a STANDARD resolution will automatically adjust the horizontal and vertical positions, clock phase and horizontal size. The INPUT_INFORMATION dialog will be displayed.</p> <p style="text-align: center;">STANDARD</p>  <p>(4) To set a custom resolution use the ▲/▼ buttons to select the CUSTOM and the RESOLUTION_CUSTOM box will be displayed. Set the horizontal (HORZ) and vertical (VERT) resolutions using the ▲/▼/◀/▶ buttons. This function may not support all resolutions.</p> <p style="text-align: center;">CUSTOM</p>  <p>(5) Move the cursor to OK on screen and press the ► or ENTER button. The message "ARE YOU SURE YOU WISH TO CHANGE RESOLUTION?" appears. To save the setting, press the ► button. The horizontal and vertical positions, clock phase and horizontal size will be automatically adjusted. The INPUT_INFORMATION dialog will be displayed.</p>  <p>(6) To revert back to the previous resolution without saving changes, move the cursor to CANCEL on screen and press the ◀ or ENTER button. The screen will then return to the RESOLUTION menu displaying the previous resolution.</p> <ul style="list-style-type: none"> • For some pictures, this function may not work well.

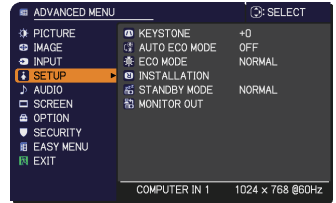
SETUP menu



From the SETUP menu, items shown in the table below can be performed.

Select an item using the ▲/▼ cursor buttons, and press the ► cursor button or **ENTER** button to execute the item. Then perform it according to the following table.

Item	Description
 KEYSTONE	Using the ◀/▶ buttons corrects the vertical keystone distortion. Shrink the bottom of the image ⇔ Shrink the top of the image • The adjustable range of this function will vary among inputs. For some input, this function may not work well.
AUTO ECO MODE	Using the ▲/▼ buttons turns on/off the AUTO ECO MODE. ON ⇔ OFF • When ON is selected, the projector will always be set to Eco mode at start-up regardless of the ECO MODE (below) setting. An OSD message “AUTO ECO MODE” will be displayed for a while when the projector starts with this function activated.
ECO MODE	Using the ◀/▶ buttons switches ECO MODE. ECO ⇔ INTELLIGENT ECO ⇔ NORMAL  • When the ECO is selected, acoustic noise and screen brightness are reduced. • When INTELLIGENT ECO is selected, the brightness of the lamp changes according to the level of the input signal. The lamp becomes brighter when the input signal level is high and darker when the level is low. If dark images are projected continuously, the brightness of the lamp may increase to maintain its performance. • When AUTO ECO MODE (above) is set to ON, the projector will always be set to Eco mode at start-up regardless this setting.

(continued on next page)

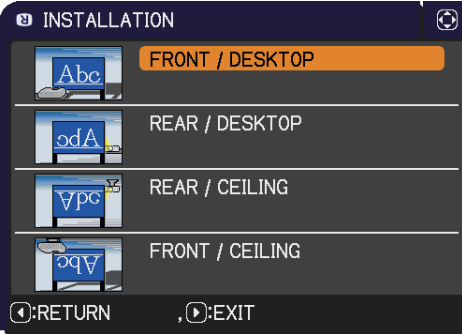
Item	Description
<p>INSTALLATION</p>	<p>Pressing the ► button displays the dialog for changing the INSTALLATION setting.</p>  <p>Use the ▲/▼ buttons to select the desired setting on the INSTALLATION dialog, and press the ENTER button of the remote control or the INPUT button of the projector to execute.</p>



(continued on next page)

Item	Description
<p>STANDBY MODE</p>	<p>Using ▲/▼ buttons switches the standby mode setting between NORMAL and SAVING. NORMAL ⇔ SAVING</p> <p>When SAVING is selected, the power consumption in the standby mode is lowered with some functional restriction as below:</p> <ul style="list-style-type: none"> • When SAVING is selected, AUDIO OUT STANDBY setting of AUDIO SOURCE (44) is invalid, and no signal is output from AUDIO OUT port in the standby mode. • When SAVING is selected, STANDBY setting of MONITOR OUT is invalid, and no signal is output from MONITOR OUT port in the standby mode.
<p>MONITOR OUT</p>	<p>While the image signal from the input port chosen in step (1) is projected, the image signal from the input port selected in step (2) is output to MONITOR OUT port.</p> <p>(1) Choose a picture input port using ▲/▼ buttons. Choose STANDBY to select the picture output in the standby mode.</p> <p>(2) Select the output signal from the MONITOR OUT port using ◀/▶ buttons. Select OFF to disable the MONITOR OUT port for the input port or standby mode chosen in the step (1).</p> <ul style="list-style-type: none"> • If you have changed the setting of STANDBY, it applies only to the current standby mode, NORMAL or SAVING, selected under STANDBY MODE, without changing the setting of the other mode. The factory settings are as follows: <ul style="list-style-type: none"> - COMPUTER IN1 for the NORMAL mode of STANDBY MODE - OFF for the SAVING mode of STANDBY MODE • It is invalid if MONITOR OUT is not selected under COMPUTER IN 2. 

AUDIO menu

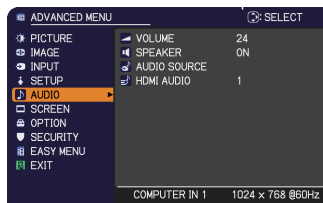
From the AUDIO menu, items shown in the table below can be performed. Select an item using the ▲/▼ cursor buttons, and press the ► cursor button or the **ENTER** button to execute the item. Then perform it according to the following table.



Item	Description
VOLUME	Using the ◀/▶ buttons adjusts the volume. Low ⇄ High
SPEAKER	Using the ▲/▼ buttons turns on/off the built-in speaker. ON ⇄ OFF When OFF is selected, the built-in speaker does not work.
AUDIO SOURCE	<p>While the image signal from the input port chosen in step (1) is projected, the audio signal from the input port selected in step (2) is output to both the AUDIO OUT port and built-in speaker of this projector. However, the built-in speaker does not work when SPEAKER is set to OFF.</p> <p>(1) Choose a picture input port using the ▲/▼ buttons. Choose AUDIO OUT STANDBY to select the sound output in the standby mode.</p> <p>(2) Select the output signal from the AUDIO OUT port using ◀/▶ buttons. Select  to mute the sound from the input port or in the standby mode chosen in the step (1).</p> <ul style="list-style-type: none"> • Even if the projector is in the standby mode, cooling fans may work and make noises when the built-in speaker is in operation. • C.C. (Closed Caption) is automatically activated when  is selected and an input signal containing C.C. is received. This function is available only when the signal is NTSC for VIDEO or S-VIDEO, or 480i@60 for COMPUTER IN1 or COMPUTER IN2, and when AUTO is selected for DISPLAY in the C.C. menu under the SCREEN menu ( 50). • AUDIO OUT STANDBY is automatically set to OFF when SAVING is selected for the STANDBY MODE item in the SETUP menu.
HDMI AUDIO	Using the ▲/▼ buttons switches the mode for the HDMI™ audio. Check each of the two modes provided and select the suitable one for your HDMI™ audio device. 1 ⇄ 2



SCREEN menu

From the SCREEN menu, items shown in the table below can be performed. Select an item using the ▲/▼ cursor buttons, and press the ► cursor button or **ENTER** button to execute the item. Then perform it according to the following table.

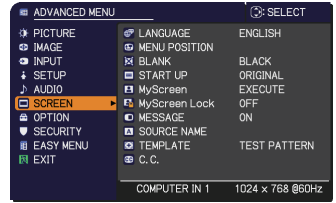

Item	Description
<p>LANGUAGE</p>	<p>Using the ▲/▼/◀/▶ buttons switches the OSD (On Screen Display) language.</p> <p>ENGLISH ⇄ FRANÇAIS ⇄ DEUTSCH ⇄ ESPAÑOL ⤴ (shown in the LANGUAGE dialog) ⤵</p> <p>Press the ENTER or INPUT button to save the language setting.</p>
<p>MENU POSITION</p>	<p>Using the ▲/▼/◀/▶ buttons adjusts the menu position. To quit the operation, press the MENU button on the remote control or keep no operation for about 10 seconds.</p>
<p>BLANK</p>	<p>Using the ▲/▼ buttons switches the mode for the blank screen. The blank screen is a screen for the temporarily blanking feature (46). It is displayed by pressing the BLANK button on the remote control.</p> <p>MyScreen ⇄ ORIGINAL ⇄ BLUE ⇄ WHITE ⇄ BLACK ⤴ ⤵</p> <p><u>MyScreen</u> : Screen can be registered by the MyScreen item (46). <u>ORIGINAL</u> : Screen preset as the standard screen. <u>BLUE, WHITE, BLACK</u> : Plain screens in each color.</p> <ul style="list-style-type: none"> • To avoid remaining as an afterimage, the MyScreen or ORIGINAL screen will change to the plain black screen after several minutes.
<p>START UP</p>	<p>Using the ▲/▼ buttons switches the mode for the start-up screen. The start-up screen is a screen displayed when no signal or an unsuitable signal is detected.</p> <p>MyScreen ⇄ ORIGINAL ⇄ OFF ⤴ ⤵</p> <p><u>MyScreen</u> : Screen can be registered by the MyScreen item (46). <u>ORIGINAL</u> : Screen preset as the standard screen. <u>OFF</u> : Plain black screen.</p> <ul style="list-style-type: none"> • To avoid remaining as an afterimage, the MyScreen or ORIGINAL screen will change to the BLANK screen (46 above) after several minutes. If also the BLANK screen is the MyScreen or ORIGINAL, the plain black screen is instead used. • When the ON is selected to the MyScreen PASSWORD item in the SECURITY menu (58), the START UP is fixed to MyScreen.

(continued on next page)

Item	Description
<p>MyScreen</p>	<p>This item allows you to capture an image for use as a MyScreen image which can be used as the BLANK screen and START UP screen. Display the image you want to capture before executing the following procedure.</p> <ol style="list-style-type: none"> <p>1. Selecting this item displays a dialog titled “MyScreen”. It will ask you if you start capturing an image from the current screen.</p> <p>Please wait for the target image to be displayed, and press the ENTER or INPUT button when the image is displayed. The image will freeze and the frame for capturing will appear.</p> <p>To stop performing, press the RESET button on the remote control.</p> <p>2. Using the ▲/▼/◀/▶ buttons adjusts the frame position.</p> <p>Please move the frame to the position of the image which you want to use. The frame may not be able to be moved for some input signals.</p> <p>To start registration, press the ENTER or INPUT button on the remote control.</p> <p>To restore the screen and return to the previous dialog, press the RESET button on the remote control.</p> <p>Registration may take several minutes.</p> <p>When the registration is completed, the registered screen and the following message is displayed for several seconds:</p> <p>“MyScreen registration is finished.”</p> <p>If the registration failed, the following message is displayed:</p> <p>“A capturing error has occurred. Please try again.”</p> <ul style="list-style-type: none"> • This function cannot be selected when the ON is selected to the MyScreen Lock item (47). • This function cannot be selected when the ON is selected to the MyScreen PASSWORD item in SECURITY menu (58). • This function is unavailable for signal from the HDMI port.

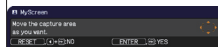
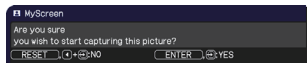

(continued on next page)

Item	Description
MyScreen Lock	<p>Using the ▲/▼ buttons turns on/off the MyScreen lock function. ON ⇔ OFF</p> <p>When the ON is selected, the item MyScreen is locked. Use this function for protecting the current MyScreen.</p> <ul style="list-style-type: none"> • This function cannot be selected when the ON is selected to the MyScreen PASSWORD item in SECURITY menu (📄58).
MESSAGE	<p>Using the ▲/▼ buttons turns on/off the message function. ON ⇔ OFF</p> <p>When the ON is selected, the following message function works.</p> <p>“AUTO IN PROGRESS” while automatically adjusting “NO INPUT IS DETECTED” “SYNC IS OUT OF RANGE” “INVALID SCAN FREQ.” “Searching....” while searching for the input “Detecting....” while an input signal is detected “AUTO ECO MODE” while starting up with AUTO ECO MODE The indication of the input signal displayed by changing The indication of the aspect ratio displayed by changing The indication of the PICTURE MODE displayed by changing The indication of the MY MEMORY displayed by changing The indication of “FREEZE” and “II” while freezing the screen by pressing the FREEZE button. The indication of the TEMPLATE displayed by changing. The indication of the ECO MODE displayed by changing.</p> <ul style="list-style-type: none"> • When the OFF is selected, please remember if the picture is frozen. Do not mistake freezing for a malfunction (📄26).

(continued on next page)

Item	Description
<p>SOURCE NAME</p>	<p>Each input port for this projector can have a name applied to it.</p> <p>(1) Use the ▲/▼ buttons on the SCREEN menu to select SOURCE NAME and press the ► or ENTER button. The SOURCE NAME menu will be displayed.</p> <p>(2) Use the ▲/▼ buttons on the SOURCE NAME menu to select the port to be named and press the ► button. The SOURCE NAME dialog will be displayed. Right side of the menu is blank until a name is specified.</p> <p>(3) Select an icon you would like to assign to the port in the SOURCE NAME dialog. The name assigned to the port will also be automatically switched according to your icon selection. Press the ENTER or INPUT button to determine your icon selection.</p> <p>(4) Select a number you would like to assign to the port along with the icon. You can select the number either from blank (no number assigned), 1, 2, 3, or 4. Then press the ENTER or INPUT button.</p> <p>(5) If you would like to modify the name assigned to the port, select CUSTOM NAME and press the ENTER or INPUT button.</p> <p>(continued on next page)</p>

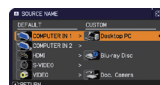
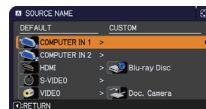

(continued on next page)

Item	Description
<p>SOURCE NAME (continued)</p>	<p>(6) The current name will be displayed on the first line. Use the ▲/▼/◀/▶ buttons and the ENTER or INPUT button to select and enter characters. To erase 1 character at one time, press the RESET button or press the ◀ and INPUT button at the same time. Also if you move the cursor to DELETE or ALL CLEAR on screen and press the ENTER or INPUT button, 1 character or all characters will be erased. The name can be a maximum of 16 characters.</p> <p>(7) To change an already inserted character, press the ▲ button to move the cursor to the first line, and use the ◀/▶ buttons to move the cursor on the character to be changed.</p> <p>After pressing the ENTER or INPUT button, the character is selected. Then, follow the same procedure as described at the item (6) above.</p> <p>(8) To finish entering text, move the cursor to the OK on screen and press the ▶, ENTER or INPUT button. To revert to the previous name without saving changes, move the cursor to the CANCEL on screen and press the ◀, ENTER or INPUT button.</p> 
<p>TEMPLATE</p>	<p>Using the ▲/▼ cursor buttons switches the mode for the template screen.</p> <p>Press the ▶ cursor (or the ENTER) button to display the selected template, and press the ◀ cursor button to close the displayed screen.</p> <p>The last selected template is displayed when the MY BUTTON allocated to the TEMPLATE function is pressed (53).</p> <p>TEST PATTERN ⇔ DOT-LINE1 ⇔ DOT-LINE2 ⇔ DOT-LINE3 ⇕ MAP2 ⇔ MAP1 ⇔ CIRCLE2 ⇔ CIRCLE1 ⇔ DOT-LINE4 ⇕</p> <p>You can turn a map upside down and scroll it horizontally when MAP1 or MAP2 is selected. To invert or scroll the map, display the guidance by pressing the RESET button on the remote three seconds or more when MAP1 or MAP2 appears.</p>

(continued on next page)

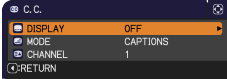
Item	Description
<p align="center">C.C. (Closed Caption)</p>	<p>The C.C. is the function that displays a transcript or dialog of the audio portion of a video, files or other presentation or other relevant sounds. It is required to have NTSC format video or 480i@60 format component video source supporting C.C. feature to utilize this function.</p> <p>It may not work properly, depending on equipment or signal source. In this case, please turn off the Closed Caption.</p> 
	<p>DISPLAY Select Closed Caption DISPLAY setting from following options using ▲/▼ buttons.</p> <p>AUTO ⇄ ON ⇄ OFF</p> <p align="center">↑—————↑</p> <p><u>AUTO</u> : Closed Caption automatically displays when the volume is muted. <u>ON</u> : Closed Caption is on. <u>OFF</u> : Closed Caption is off.</p> <ul style="list-style-type: none"> • The caption is not displayed when the OSD menu is active. • The Closed Caption is the function to display the dialogue, narration, and / or sound effects of a television program or other video sources. The Closed Caption availability is depending upon broadcaster and/or content.
	<p>MODE Select Closed Caption MODE setting from following options using ▲/▼ buttons.</p> <p>CAPTIONS ⇄ TEXT</p> <p><u>CAPTIONS</u> : Display Closed Caption. <u>TEXT</u> : Display Text data, which is for additional information such as news reports or a TV program guide. The information covers the entire screen. Not all of the C.C. program has Text information.</p>
	<p>CHANNEL Select Closed Caption CHANNEL from following options using ▲/▼ buttons.</p> <p>1 ⇄ 2 ⇄ 3 ⇄ 4</p> <p align="center">↑—————↑</p> <p><u>1</u>: Channel 1, primary channel / language <u>2</u>: Channel 2 <u>3</u>: Channel 3 <u>4</u>: Channel 4</p> <p>The channel data may vary, depending on the content. Some channel might be used for secondary language or empty.</p>

OPTION menu

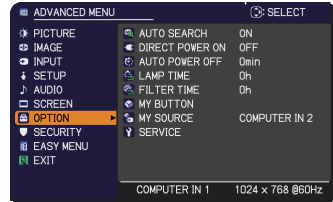



From the OPTION menu, items shown in the table below can be performed.

Select an item using the ▲/▼ cursor buttons, and press the ► cursor button or **ENTER** button to execute the item, except for the items LAMP TIME and FILTER TIME. Then perform it according to the following table.

Item	Description
<p>AUTO SEARCH</p>	<p>Using the ▲/▼ buttons turns on/off the automatic signal search function.</p> <p>ON ⇔ OFF</p> <p>When the ON is selected, detecting no signal automatically cycles through input ports in the following order. The search is started from the current port. Then when an input is found, the projector will stop searching and display the image.</p> <p>  </p>
<p>DIRECT POWER ON</p>	<p>Using the ▲/▼ buttons turns on/off the DIRECT POWER ON function.</p> <p>ON ⇔ OFF</p> <p>When set to the ON, the lamp in projector will be automatically turned on without the usual procedure (17), only when the projector is supplied with the power after the power was cut while the lamp was on.</p> <ul style="list-style-type: none"> • This function does not work as long as the power has been supplied to the projector while the lamp is off. • After turning the lamp on by the DIRECT POWER ON function, if neither input nor operation is detected for about 30 minutes, the projector is turned off, even though the AUTO POWER OFF function (52) is disabled.

(continued on next page)

Item	Description
<p>AUTO POWER OFF</p>	<p>Using the ▲/▼ buttons adjusts the time to count down to automatically turn the projector off.</p> <p>Long (max. 99 minutes) ⇔ Short (min. 0 minute = DISABLE)</p> <div style="display: flex; justify-content: space-around; align-items: center;">   </div> <p>When the time is set to 0, the projector is not turned off automatically. When the time is set to 1 to 99, and when the passed time with no-signal or an unsuitable signal reaches at the set time, the projector lamp will be turned off.</p> <p>If one of the projector's buttons or the remote control buttons is pressed during the corresponding time, projector will not be turned off.</p> <p>Please refer to the section Turning off the power (📖18).</p>
<p>LAMP TIME</p>	<p>The lamp time is the usage time of the lamp, counted after the last resetting. It is shown in the OPTION menu.</p> <p>Pressing the RESET button on the remote control or the ► button of the projector displays a dialog.</p> <p>To reset the lamp time, select the OK using the ► button.</p> <p>CANCEL ⇨ OK</p> <ul style="list-style-type: none"> • Please reset the lamp time only when you have replaced the lamp, for a suitable indication about the lamp. • For the lamp replacement, see the section Replacing the lamp (📖62).
<p>FILTER TIME</p>	<p>The filter time is the usage time of the air filter, counted after the last resetting. It is shown in the OPTION menu.</p> <p>Pressing the RESET button on the remote control or the ► button of the projector displays a dialog.</p> <p>To reset the filter time, select the OK using the ► button.</p> <p>CANCEL ⇨ OK</p> <ul style="list-style-type: none"> • Please reset the filter time only when you have cleaned or replaced the air filter, for a suitable indication about the air filter. • For the air filter cleaning, see the section Cleaning and replacing the air filter (📖64, 65).

(continued on next page)

Item	Description
<p>MY BUTTON</p>	<p>This item assigns one of the following functions to the ECO button on the control panel (📖5) and MY BUTTON 1/2 on the remote control (📖6).</p> <p>(1) Choose a button to assign a function from ECO, MY BUTTON-1 and MY BUTTON-2. Use the ▲/▼ buttons to select the desired function on the menu and press the ► button.</p> <p>(2) Then using the ▲/▼/◀/▶ buttons sets one of the following functions to the chosen button. Press the ENTER or INPUT button to save the setting.</p> <ul style="list-style-type: none"> • COMPUTER IN1: Selects the input from COMPUTER IN1 port. • COMPUTER IN2: Selects the input from COMPUTER IN2 port. • HDMI: Selects input from HDMI port. • S-VIDEO: Selects the input from S-VIDEO port. • VIDEO: Selects the input from VIDEO port. • INFORMATION: Displays SYSTEM_INFORMATION, INPUT_INFORMATION (📖56) or nothing. • MY MEMORY: Loads one of adjustment data stored (📖33). When more than one data are saved, the adjustment changes every time the MY BUTTON is pressed. When no data is saved in memory, the dialog "No saved data" appears. When the current adjustment is not saved to memory, the dialog as shown in the right appears. <p>If you want to keep the current adjustment, please press the ► button to exit. Otherwise loading a data will overwrite the current adjusted condition.</p> <ul style="list-style-type: none"> • PICTURE MODE: Changes the PICTURE MODE (📖29). • FILTER RESET: Displays the filter time reset confirmation dialogue (📖55). • TEMPLATE: Makes the template pattern selected to the TEMPLATE item (📖49) appear or disappear. • AV MUTE: Turns the picture and audio on/off. • RESOLUTION: Turns on/off the RESOLUTION dialog (📖40). • ECO MODE: Changes the ECO MODE (📖41). • BLANK: Turns on/off the blank function. (ECO button only) • FREEZE: Turns on/off the freeze function. (ECO button only) • VOLUME: Turns on/off the volume dialog. (ECO button only) • AUTO: Performs the automatic adjustment function. (ECO button only) <div style="display: flex; justify-content: space-around; align-items: center;"> <div data-bbox="826 710 986 730" style="border: 1px solid black; padding: 2px;"> <p>⇒ No saved data</p> </div> <div data-bbox="781 751 1033 804" style="border: 1px solid black; padding: 2px;"> <p>Temporary condition</p> <p>MY BUTTON : Recall saved parameters</p> <p>(MY MEMORY)</p> <p>← → :Exit</p> </div> </div>

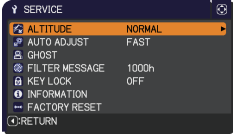

(continued on next page)

Item	Description
<p>MY SOURCE</p>	<p>Using ▲/▼ buttons selects the picture input port to be selected with pressing the MY SOURCE/DOC.CAMERA button on the remote control.</p> <p>You can use this function not only for document cameras but also computers and other equipment.</p> <p>↔ VIDEO ↔ COMPUTER IN1 ↔ COMPUTER IN2 ↔ ↔ S-VIDEO ↔ HDMI ↔</p>
<p>SERVICE</p>	<p>Selecting this item displays the SERVICE menu.</p> <p>Select an item using the ▲/▼ buttons, and press the ► button or the ENTER button on the remote control to execute the item.</p>  <p>ALTITUDE</p> <p>Using the ▲/▼ buttons switches the rotation speed of the cooling fans. The HIGH is the mode for use at highlands etc. If the projector is used at an altitude of about 1600 m (5250 feet) or higher, select HIGH. Otherwise, select NORMAL. Note that the projector is noisier when the HIGH is selected.</p> <p>HIGH ↔ NORMAL</p> <p>AUTO ADJUST</p> <p>Using the ▲/▼ buttons to select one of the mode. When the DISABLE is selected, the automatic adjustment feature is disabled.</p> <p>FINE ↔ FAST ↔ DISABLE</p> <p>↑—————↑</p> <p>FINE: Finer tuning including H.SIZE adjustment. FAST: Faster tuning, setting H.SIZE to prearranged data for the input signal.</p> <ul style="list-style-type: none"> Depending on conditions, such as input image, signal cable to the projector, environment around the projector, etc., the automatic adjustment may not work correctly. In such a case, please choose DISABLE to disable the automatic adjustment, and make adjustment manually.

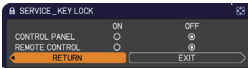
(continued on next page)

Item	Description
<p>SERVICE (continued)</p>	<p>GHOST Adjust the settings using the ▲/▼ buttons to eliminate ghosting.</p>
	<p>FILTER MESSAGE Use the ▲/▼ button to set the timer for notifying by the message when to replace the filter unit 100h ⇄ 200h ⇄ 500h ⇄ 1000h ⇄ 2000h ⇄ 3000h ⇄ 4000h ⇄ 5000h ⇄ OFF After choosing an item except OFF, the message “REMINDER *** HRS PASSED” will appear after the timer reaches the interval time set by this feature (📖68). When the OFF is chosen, the message will not appear. Utilize this feature to keep the air filter clean, setting the suitable time according to your environment of this projector. • Please take care of the filter unit periodically, even if there is no message. If the air filter becomes to be blocked by dust or other matter, the internal temperature will rise, which could cause malfunction, or reduce the lifetime of the projector. • Please be careful with the operating environment of the projector and the condition of the filter unit.</p>
	<p>KEY LOCK (1) Use the ▲/▼ buttons to choose the operations control. CONTROL PANEL ⇄ REMOTE CONTROL (2) Use the ◀/▶ buttons to select ON or OFF. ON ⇄ OFF</p>  <p>Selecting ON in Step 2 locks the buttons except STANDBY/ON on the operations control selected in Step 1. Selecting OFF releases the locked buttons on the operations control selected in Step 1. • Please use this function to prevent tampering or accidental operation.</p>

(continued on next page)

Item	Description
<p>SERVICE (continued)</p>	<p>INFORMATION</p> <p>Selecting this item displays a dialog titled “INPUT_INFORMATION”. It shows the information about the current input.</p> <div style="display: flex; justify-content: space-around; align-items: center;">    </div> <ul style="list-style-type: none"> • The “FRAME LOCK” message on the dialog means the frame lock function is working. • This item can't be selected for no signal and sync out. • When the MY TEXT DISPLAY is set to ON, the MY TEXT is displayed together with the input information in the INPUT_INFORMATION box (📖61).
	<p>FACTORY RESET</p> <p>Selecting OK using the ► button performs this function. By this function, all the items in all of menus will collectively return to the initial setting. Note that the items LAMP TIME, FILTER TIME, LANGUAGE, FILTER MESSAGE and SECURITY settings are not reset.</p> <p>CANCEL ⇨ OK</p> <p>Be sure to set ALTITUDE after resetting all the settings (📖54).</p>

SECURITY menu

This projector is equipped with security functions.

From the SECURITY menu, items shown in the table below can be performed.

To use SECURITY menu: User registration is required before using the security functions.

Enter to the SECURITY menu

1. Press the ► button. The ENTER PASSWORD box will be displayed.
2. Use the ▲/▼/◀/▶ buttons to enter the registered password.
The factory default password is as follows.

3792

This password can be changed (see below). Move the cursor to the right side of the ENTER PASSWORD box and press the ► button to display the SECURITY menu.

- It is strongly recommended the factory default password to be changed as soon as possible.
- If an incorrect password is input, the ENTER PASSWORD box will be displayed again. If incorrect password is input 3 times, the projector will turn off. Afterwards the projector will turn off every time an incorrect password is input.

3. Items shown in the table below can be performed.

If you have forgotten your password

- (1) While the ENTER PASSWORD box is displayed, press and hold the **RESET** button on the remote control for about 3 seconds or press and hold the **INPUT** button for 3 seconds while pressing the ► button on the projector.

- (2) The 10 digit Inquiring Code will be displayed. Contact your dealer with the 10 digit Inquiring Code. Your password will be sent after your user registration information is confirmed.



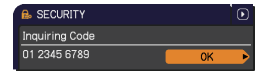
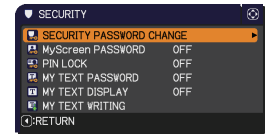
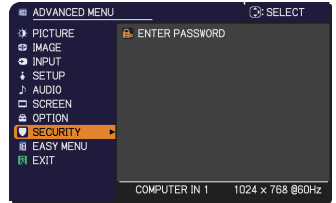

- If there is no key input for about 55 seconds while the Inquiring Code is displayed, the menu will close. If necessary, repeat the process from (1).

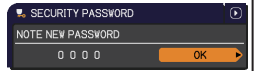

Item	Description
<p style="text-align: center;">SECURITY PASSWORD CHANGE</p>	<ol style="list-style-type: none"> (1) Use the ▲/▼ buttons on the SECURITY menu to select SECURITY PASSWORD CHANGE and press the ► button to display the ENTER NEW PASSWORD box. (2) Use the ▲/▼/◀/▶ buttons to enter the new password. (3) Move the cursor to the right side of the ENTER NEW PASSWORD box and press the ► button to display the NEW PASSWORD AGAIN box, enter the same password again. (4) Move the cursor to the right side of the NEW PASSWORD AGAIN box and press the ► button and the NOTE NEW PASSWORD box will be displayed for about 30 seconds, please make note of the password during this time. Pressing the ENTER button on the remote control or ► button on the projector will close the NOTE NEW PASSWORD box. <ul style="list-style-type: none"> • Please do not forget your password.

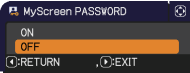

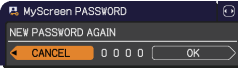
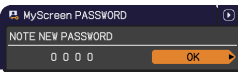

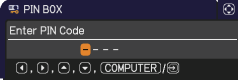
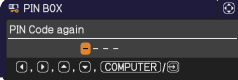
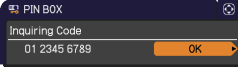

(continued on next page)

Item	Description
<p>MyScreen PASSWORD</p>	<p>The MyScreen PASSWORD function can be used to prohibit access to the MyScreen function and prevent the currently registered MyScreen image from being overwritten.</p> <p>1 Turning on the MyScreen PASSWORD</p> <p>1-1 Use the ▲/▼ buttons on the SECURITY menu to select MyScreen PASSWORD and press the ► button to display the MyScreen PASSWORD on/off menu.</p>  <p>1-2 Use the ▲/▼ buttons on the MyScreen PASSWORD on/off menu to select ON. The ENTER NEW PASSWORD box (small) will be displayed.</p>  <p>1-3 Use the ▲/▼/◀/▶ buttons to enter the password. Move the cursor to the right side of the ENTER NEW PASSWORD box (small) and press the ► button to display the NEW PASSWORD AGAIN box, enter the same PASSWORD again.</p>  <p>1-4 Move the cursor to the right side of the NEW PASSWORD AGAIN box and press the ► button to display the NOTE NEW PASSWORD box for about 30 seconds, please make note of the password during this time.</p>  <p>Pressing the ENTER button on the remote control or ► button on the projector will return to MyScreen PASSWORD on/off menu.</p> <p>When a password is set for MyScreen:</p> <ul style="list-style-type: none"> • The MyScreen registration function (and menu) will be unavailable. • The MyScreen Lock menu will be unavailable. • The START UP setting will be locked on MyScreen (and the menu will be unavailable). <p>Turning the MyScreen PASSWORD off will allow normal operation of these functions.</p> <ul style="list-style-type: none"> • Please do not forget your MyScreen PASSWORD. <p>2 Turning off the MyScreen PASSWORD</p> <p>2-1 Follow the procedure in 1-1 to display the MyScreen PASSWORD on/off menu.</p> <p>2-2 Select OFF to display the ENTER PASSWORD box (large). Enter the registered password and the screen will return to the MyScreen PASSWORD on/off menu.</p>  <p>If an incorrect PASSWORD is input, the menu will close. If necessary, repeat the process from 2-1.</p> <p>3 If you have forgotten your password</p> <p>3-1 Follow the procedure in 1-1 to display the MyScreen PASSWORD on/off menu.</p> <p>3-2 Select OFF to display the ENTER PASSWORD box (large). The 10 digit Inquiring Code will be displayed inside the box.</p> <p>3-3 Contact your dealer with the 10 digit Inquiring Code. Your password will be sent after your user registration information is confirmed.</p>

(continued on next page)

Item	Description
PIN LOCK	<p>PIN LOCK is a function which prevents the projector from being used unless a registered Code is input.</p> <p>1 Turning on the PIN LOCK</p> <p>1-1 Use the ▲/▼ buttons on the SECURITY menu to select PIN LOCK and press the ► button or the ENTER button to display the PIN LOCK on/off menu.</p>  <p>1-2 Use the ▲/▼ buttons on the PIN LOCK on/off menu to select ON and the Enter PIN Code box will be displayed.</p>  <p>1-3 Input a 4 part PIN code using the ▲/▼/◀/▶, COMPUTER or INPUT button. The PIN Code again box will appear. Reenter the same PIN code. This will complete the PIN code registration.</p>  <ul style="list-style-type: none"> • If there is no key input for about 55 seconds while the Enter PIN Code box or the PIN Code again box is displayed, the menu will close. If necessary, repeat the process from 1-1. <p>Afterwards, anytime the projector is restarted after AC power is turned off the Enter PIN Code box will be displayed. Enter the registered PIN code. The projector can be used after entering the registered PIN code. If an incorrect PIN code is input, the Enter PIN code box will be displayed again. If an incorrect PIN code is input 3 times, the projector will turn off. Afterwards the projector will turn off every time an incorrect PIN code is input. The projector will also turn off if there is no key input for about 5 minutes while the Enter PIN code box is displayed.</p> <p>This function will activate only when the projector is started after AC power is turned off.</p> <ul style="list-style-type: none"> • Please do not forget your PIN code. <p>2 Turning off the PIN LOCK</p> <p>2-1 Follow the procedure in 1-1 to display the PIN LOCK on/off menu.</p> <p>2-2 Use the ▲/▼ buttons to select OFF and the Enter PIN Code box will be displayed.</p> <p>Enter the registered PIN code to turn the PIN LOCK function off.</p> <p>If an incorrect PIN code is input 3 times, the projector will turn off.</p> <p>3 If you have forgotten your PIN code</p> <p>3-1 While the Enter PIN Code box is displayed, press and hold the RESET button for three seconds or press and hold the INPUT button for 3 seconds while pressing the ► button on the projector. The 10 digit Inquiring Code will be displayed.</p> <ul style="list-style-type: none"> • If there is no key input for about 5 minutes while the Inquiring Code is displayed, the projector will turn off.  <p>3-2 Contact your dealer with the 10 digit Inquiring Code. Your PIN code will be sent after your user registration information is confirmed.</p>

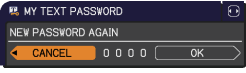
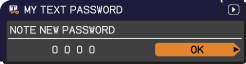
(continued on next page)

Item	Description
<p>MY TEXT PASSWORD</p>	<p>The MY TEXT PASSWORD function can prevent the MY TEXT from being overwritten. When the password is set for the MY TEXT;</p> <ul style="list-style-type: none"> • The MY TEXT DISPLAY menu will be unavailable, which can prohibit changing the DISPLAY setting. • The MY TEXT WRITING menu will be unavailable, which can prevent the MY TEXT from being overwritten. <p>1 Turning on the MY TEXT PASSWORD</p> <p>1-1 Use the ▲/▼ buttons on the SECURITY menu to select the MY TEXT PASSWORD and press the ► button to display the MY TEXT PASSWORD on/off menu.</p>  <p>1-2 Use the ▲/▼ buttons on the MY TEXT PASSWORD on/off menu to select ON. The ENTER NEW PASSWORD box (small) will be displayed.</p>  <p>1-3 Use the ▲/▼/◀/▶ buttons to enter the password. Move the cursor to the right side of the ENTER NEW PASSWORD box (small) and press the ► button to display the NEW PASSWORD AGAIN box, and then enter the same password again.</p>  <p>1-4 Move the cursor to the right side of the NEW PASSWORD AGAIN box and press ► button to display the NOTE NEW PASSWORD box for about 30 seconds, then please make note of the password during this time.</p>  <p>Pressing the ENTER button on the remote control or ► button on the projector will return to the MY TEXT PASSWORD on/off menu.</p> <p>2 Turning off the MY TEXT PASSWORD</p> <p>2-1 Follow the procedure in 1-1 to display the MY TEXT PASSWORD on/off menu.</p> <p>2-2 Select OFF to display the ENTER PASSWORD box (large). Enter the registered password and the screen will return to the MY TEXT PASSWORD on/off menu.</p>  <p>If an incorrect password is input, the menu will close. If necessary, repeat the process from 2-1</p> <p>3 If you have forgotten your password</p> <p>3-1 Follow the procedure in 1-1 to display the MY TEXT PASSWORD on/off menu.</p> <p>3-2 Select OFF to display the ENTER PASSWORD box (large). The 10 digit inquiring code will be displayed inside the box.</p> <p>3-3 Contact your dealer with the 10 digit inquiring code. Your password will be sent after your user registration information is confirmed.</p>

(continued on next page)

Item	Description
<p>MY TEXT DISPLAY</p>	<p>(1) Use the ▲/▼ buttons on the SECURITY menu to select the MY TEXT DISPLAY and press the ► or ENTER button to display the MY TEXT DISPLAY on/off menu.</p> <p>(2) Use the ▲/▼ buttons on the MY TEXT DISPLAY on/off menu to select on or off.</p> <p>ON ⇔ OFF</p> <p>When it is set ON, the MY TEXT will be displayed on the START UP screen and the INPUT_INFORMATION when the INFORMATION on the SERVICE menu is chosen.</p> <ul style="list-style-type: none"> • This function is available only when the MY TEXT PASSWORD function is set to the OFF.
<p>MY TEXT WRITING</p>	<p>(1) Use the ▲/▼ buttons on the SECURITY menu to select the MY TEXT WRITING and press the ► button. The MY TEXT WRITING dialog will be displayed.</p> <p>(2) The current MY TEXT will be displayed on the first 3 lines. If not yet written, the lines will be blank.</p> <p>Use the ▲/▼/◀/▶ buttons and the ENTER or INPUT button to select and enter characters. To erase 1 character at one time, press the RESET button or press the ◀ and INPUT button at the same time. Also if you move the cursor to DELETE or ALL CLEAR on screen and press the ENTER or INPUT button, 1 character or all characters will be erased. The MY TEXT can be input up to 24 characters on each line.</p> <p>(3) To change an already inserted character, press the ▲/▼ button to move the cursor to one of the first 3 lines, and use the ◀/▶ buttons to move the cursor on the character to be changed.</p> <p>After pressing the ENTER or INPUT button, the character is selected. Then, follow the same procedure as described at the item (2) above.</p> <p>(4) To finish entering text, move the cursor to the OK on screen and press the ►, ENTER or INPUT button. To revert to the previous MY TEXT without saving changes, move the cursor to the CANCEL on screen and press the ◀, ENTER or INPUT button.</p> <ul style="list-style-type: none"> • The MY TEXT WRITING function is available only when the MY TEXT PASSWORD function is set to OFF.

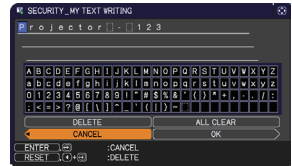
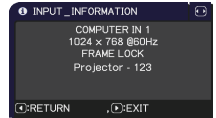

Maintenance

Replacing the lamp

A lamp has finite product life. Using the lamp for long periods of time could cause the pictures darker or the color tone poor. Note that each lamp has a different lifetime, and some may burst or burn out soon after you start using them. Preparation of a new lamp and early replacement are recommended. To prepare a new lamp, make contact with your dealer and tell the lamp type number.

Type number : DT01241

Replacing the lamp

1. Turn the projector off, and unplug the power cord. Allow the projector to cool for at least 45 minutes.
2. Prepare a new lamp. If the projector is mounted on a ceiling, or if the lamp has broken, also ask the dealer to replace the lamp.

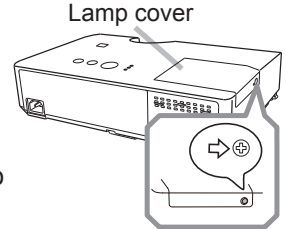

In case of replacement by yourself, follow the following procedure.

3. Loosen the screw (marked by arrow) of the lamp cover and then slide and lift the lamp cover to the side to remove it.
4. Loosen the 2 screws (marked by arrow) of the lamp, and slowly pick up the lamp by the handle. Never loosen any other screws.
5. Insert the new lamp, and retighten firmly the 2 screws of the lamp that are loosened in the previous process to lock it in place.
6. While putting the interlocking parts of the lamp cover and the projector together, slide the lamp cover back in place. Then firmly fasten the screw of the lamp cover.
7. Turn the projector on and reset the lamp time using the LAMP TIME item in the OPTION menu.
 - (1) Press the **MENU** button to display a menu.
 - (2) Point at the **ADVANCED MENU** in the menu using the **▼/▲** button, then press the **▶** button.
 - (3) Point at the **OPTION** in the left column of the menu using the **▼/▲** button, then press the **▶** button.
 - (4) Point at the **LAMP TIME** using the **▼/▲** button, then press the **▶** button. A dialog will appear.
 - (5) Press the **▶** button to select "OK" on the dialog. It performs resetting the lamp time.

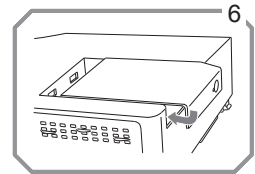
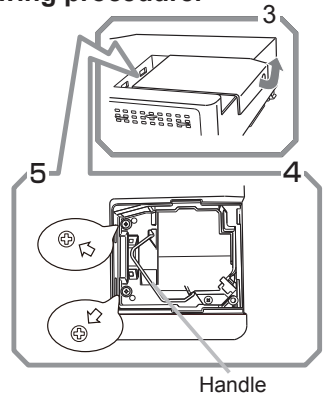

⚠ CAUTION ▶ Do not touch any inner space of the projector, while the lamp is taken out.

NOTE • Please reset the lamp time only when you have replaced the lamp, for a suitable indication about the lamp.

Replacing the lamp (continued)

Lamp warning

 **HIGH VOLTAGE**  **HIGH TEMPERATURE**  **HIGH PRESSURE**

⚠ WARNING ► The projector uses a high-pressure mercury glass lamp. The lamp can break with a loud bang, or burn out, if jolted or scratched, handled while hot, or worn over time. Note that each lamp has a different lifetime, and some may burst or burn out soon after you start using them. In addition, if the bulb bursts, it is possible for shards of glass to fly into the lamp housing, and for gas containing mercury and dust containing fine particles of glass to escape from the projector's vent holes.

► **About disposal of a lamp:** This product contains a mercury lamp; do not put it in a trash. Dispose of it in accordance with environmental laws.

- For lamp recycling, go to www.lamprecycle.org (in the US).
- For product disposal, consult your local government agency or www.eiae.org (in the US) or www.epsc.ca (in Canada).

For more information, call your dealer.



Disconnect
the plug
from the
power
outlet

- If the lamp should break (it will make a loud bang when it does), unplug the power cord from the outlet, and make sure to request a replacement lamp from your local dealer. Note that shards of glass could damage the projector's internals, or cause injury during handling, so please do not try to clean the projector or replace the lamp yourself.
- If the lamp should break (it will make a loud bang when it does), ventilate the room well, and make sure not to inhale the gas or fine particles that come out from the projector's vent holes, and not to get them into your eyes or mouth.
- Before replacing the lamp, turn the projector off and unplug the power cord, then wait at least 45 minutes for the lamp to cool sufficiently. Handling the lamp while hot can cause burns, as well as damaging the lamp.



- Never unscrew except the appointed (marked by an arrow) screws.
- Do not open the lamp cover while the projector is suspended from a ceiling. This is dangerous, since if the lamp's bulb has broken, the shards will fall out when the cover is opened. In addition, working in high places is dangerous, so ask your local dealer to have the lamp replaced even if the bulb is not broken.
- Do not use the projector with the lamp cover removed. At the lamp replacing, make sure that the screws are screwed in firmly. Loose screws could result in damage or injury.



- Use only the lamp of the specified type. Use of a lamp that does not meet the lamp specifications for this model could cause a fire, damage or shorten the life of this product.
- If the lamp breaks soon after the first time it is used, it is possible that there are electrical problems elsewhere besides the lamp. If this happens, consult your local dealer or a service representative.
- Handle with care: jolting or scratching could cause the lamp bulb to burst during use.
- Using the lamp for long periods of time, could cause it dark, not to light up or to burst. When the pictures appear dark, or when the color tone is poor, please replace the lamp as soon as possible. Do not use old (used) lamps; this is a cause of breakage.

Cleaning and replacing the air filter

Please check and clean the air filter periodically. When the indicators or a message prompts you to clean the air filter, comply with it as soon as possible. Replace the filters when they are damaged or too soiled. To prepare the new filters, make contact with your dealer and tell the following type number.

Type number : NJ27424

When you replace the lamp, please replace the air filter. An air filter of specified type will come together with a replacement lamp for this projector.

1. Turn the projector off, and unplug the power cord.
• Allow the projector to sufficiently cool down.
2. Use a vacuum cleaner on and around the filter cover.
3. Pick and pull up the filter cover knobs to take it off.
4. Use a vacuum cleaner for the filter vent of the projector.
5. Take the filter out pulling the filter's knob up while holding the filter cover.
6. Use a vacuum cleaner on both sides of the filter. If the filter is damaged or heavily soiled, replace it with the new one.
7. Put the filter back into the filter cover.
8. Put the filter unit back into the projector.

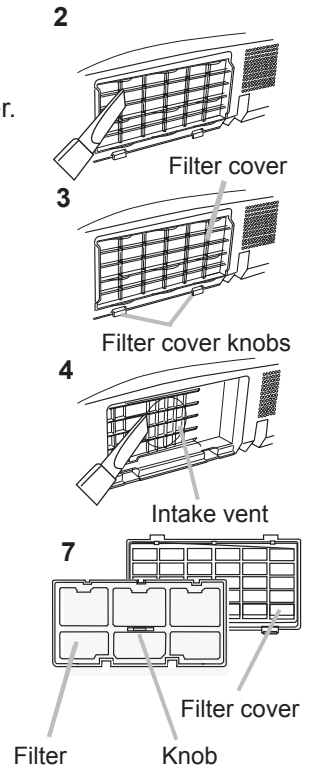

(continued on next page)

Cleaning and replacing the air filter (continued)

9. Turn the projector on and reset the filter time using the FILTER TIME item in the EASY MENU.
- (1) Press the **MENU** button to display a menu.
 - (2) Point at the FILTER TIME using the ▼/▲ button, then press the ► button. A dialog will appear.
 - (3) Press the ► button to select “OK” on the dialog. It performs resetting the filter time.

⚠ WARNING ► Before taking care of the air filter, make sure the power cable is not plugged in, then allow the projector to cool sufficiently. Taking care of the air filter in a high temperature state of the projector could cause an electric shock, a burn or malfunction to the projector.

► Use only the air filter of the specified type. Do not use the projector without the air filter or the filter cover. It could result in a fire or malfunction to the projector.

► Clean the air filter periodically. If the air filter becomes clogged by dust or the like, internal temperatures rise and could cause a fire, a burn or malfunction to the projector.

NOTE • Please replace the air filter when it is damaged or too soiled.

- When you replace the projection lamp, please replace the air filter. An air filter of specified type will come together with a replacement lamp for this projector.
- Please reset the filter time only when you have cleaned or replaced the air filter, for a suitable indication about the air filter.
- The projector may display the message such as “CHECK THE AIR FLOW” or turn off the projector, to prevent the internal heat level rising.

Other care

Inside of the projector

In order to ensure the safe use of your projector, please have it cleaned and inspected by your dealer about once every year.

Caring for the lens

If the lens is flawed, soiled or fogged, it could cause deterioration of display quality. Please take care of the lens, being cautious of handling.

1. Turn the projector off, and unplug the power cord. Allow the projector to cool sufficiently.
2. After making sure that the projector is cool adequately, lightly wipe the lens with a commercially available lens-cleaning wipe. Do not touch the lens directly with your hand.

Caring for the cabinet and remote control

Incorrect care could have adverse influence such as discoloration, peeling paint, etc.

1. Turn the projector off, and unplug the power cord. Allow the projector to cool sufficiently.
2. After making sure that the projector is cool adequately, lightly wipe with gauze or a soft cloth.
If the projector is extremely dirty, dip soft cloth in water or a neutral cleaner diluted in water, and wipe lightly after wringing well. Then, wipe lightly with a soft, dry cloth.

▲ WARNING ► Before caring, make sure the power cord is not plugged in, and then allow the projector to cool sufficiently. The care in a high temperature state of the projector could cause a burn and/or malfunction to the projector.

► Never try to care for the inside of the projector personally. Doing is so dangerous.

► Avoid wetting the projector or inserting liquids in the projector. It could result in a fire, an electric shock, and/or malfunction to the projector.

- Do not put anything containing water, cleaners or chemicals near the projector.
- Do not use aerosols or sprays.

▲ CAUTION ► Please take right care of the projector according to the following. Incorrect care could cause not only an injury but adverse influence such as discoloration, peeling paint, etc.

► Do not use cleaners or chemicals other than those specified in this manual.

► Do not polish or wipe with hard objects.

NOTICE ► Do not directly touch the lens surface with hands.

Troubleshooting

If an abnormal operation should occur, stop using the projector immediately.

⚠ WARNING ▶ Never use the projector if abnormal operations such as smoke, strange odor, excessive sound, damaged casing or elements or cables, penetration of liquids or foreign matter, etc. should occur. In such cases, immediately disconnect the power plug from the power outlet. After making sure that the smoke or odor has stopped, contact to your dealer or service company.

Otherwise if a problem occurs with the projector, the following checks and measures are recommended before requesting repair. If this does not resolve the problem, please contact your dealer or service company. They will tell you what warranty condition is applied.

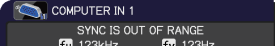
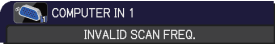

Related messages

When some message appears, check and cope with it according to the following table. Although these messages will be automatically disappeared around several minutes, it will be reappeared every time the power is turned on.

Message	Description
	<p>There is no input signal. Please confirm the signal input connection, and the status of the signal source.</p>
	<p>The horizontal or vertical frequency of the input signal is not within the specified range. Please confirm the specs for your projector or the signal source specs.</p>
	<p>An improper signal is input. Please confirm the specs for your projector or the signal source specs.</p>

(continued on next page)

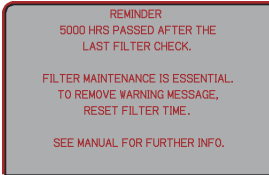
Related messages (continued)

Message	Description
	<p>The internal temperature is rising. Please turn the power off, and allow the projector to cool down at least 20 minutes. After having confirmed the following items, please turn the power ON again.</p> <ul style="list-style-type: none"> • Is there blockage of the air passage aperture? • Is the air filter dirty? • Does the peripheral temperature exceed 35°C? • If the projector is used at an altitude of about 1600 m (5250 feet) or higher, set ALTITUDE of the SERVICE item in the OPTION menu to HIGH (📖 54). <p>If the projector is used with a wrong setting, it may cause damage to the projector itself or the parts inside.</p>
	<p>A note of precaution when cleaning the air filter. Please immediately turn the power off, and clean or change the air filter referring to the Cleaning and replacing the air filter section of this manual. After you have cleaned or changed the air filter, please be sure to reset the filter timer (📖 52, 64, 65).</p>
	<p>The button operation is not available.</p>

Regarding the indicator lamps

When operation of the **LAMP**, **TEMP** and **POWER** indicators differs from usual, check and cope with it according to the following table.

POWER indicator	LAMP indicator	TEMP indicator	Description
Lighting In Orange	Turned off	Turned off	The projector is in a standby state. Please refer to the section "Power on/off".
<i>Blinking</i> In Green	Turned off	Turned off	The projector is warming up. Please wait.
Lighting In Green	Turned off	Turned off	The projector is in an on state. Ordinary operations may be performed.
<i>Blinking</i> In Orange	Turned off	Turned off	The projector is cooling down. Please wait.
<i>Blinking</i> In Red	(discre- tionary)	(discre- tionary)	The projector is cooling down. A certain error has been detected. Please wait until POWER indicator finishes blinking, and then perform the proper measure using the item descriptions below.
<i>Blinking</i> In Red or Lighting In Red	Lighting In Red	Turned off	The lamp does not light, and there is a possibility that interior portion has become heated. Please turn the power off, and allow the projector to cool down at least 20 minutes. After the projector has sufficiently cooled down, please make confirmation of the following items, and then turn the power on again. <ul style="list-style-type: none"> • Is there blockage of the air passage aperture? • Is the air filter dirty? • Does the peripheral temperature exceed 35°C? If the same indication is displayed after the remedy, please change the lamp referring to the section Replacing the lamp.
<i>Blinking</i> In Red or Lighting In Red	<i>Blinking</i> In Red	Turned off	The lamp cover has not been properly fixed. Please turn the power off, and allow the projector to cool down at least 45 minutes. After the projector has sufficiently cooled down, please make confirmation of the attachment state of the lamp cover. After performing any needed maintenance, turn the power on again. If the same indication is displayed after the remedy, please contact your dealer or service company.
<i>Blinking</i> In Red or Lighting In Red	Turned off	<i>Blinking</i> In Red	The cooling fan is not operating. Please turn the power off, and allow the projector to cool down at least 20 minutes. After the projector has sufficiently cooled down, please make confirmation that no foreign matter has become caught in the fan, etc., and then turn the power on again. If the same indication is displayed after the remedy, please contact your dealer or service company.

(continued on next page)

Regarding the indicator lamps (continued)

POWER indicator	LAMP indicator	TEMP indicator	Description
Blinking In Red or Lighting In Red	Turned off	Lighting In Red	<p>There is a possibility that the interior portion has become heated.</p> <p>Please turn the power off, and allow the projector to cool down at least 20 minutes. After the projector has sufficiently cooled down, please make confirmation of the following items, and then turn the power on again.</p> <ul style="list-style-type: none"> • Is there blockage of the air passage aperture? • Is the air filter dirty? • Does the peripheral temperature exceed 35°C? • If the projector is used at an altitude of about 1600 m (5250 feet) or higher, set ALTITUDE of the SERVICE item in the OPTION menu to HIGH (☐54). If the projector is used with a wrong setting, it may cause damage to the projector itself or the parts inside.
Lighting In Green	Simultaneous blinking in Red		<p>It is time to clean the air filter.</p> <p>Please immediately turn the power off, and clean or change the air filter referring to the section Cleaning and replacing the air filter. After cleaning or changing the air filter, please be sure to reset the filter timer. After the remedy, reset the power to ON.</p>
Lighting In Green	Alternative blinking in Red		<p>There is a possibility that the interior portion has become overcooled.</p> <p>Please use the unit within the usage temperature parameters (5°C to 35°C). After the treatment, reset the power to ON.</p>
Blinking In Green for approx. 3 seconds.	Turned off	Turned off	<p>At least 1 Power ON schedule is saved to the projector.</p>

NOTE • When the interior portion has become overheated, for safety purposes, the projector is automatically shut down, and the indicator lamps may also be turned off. In such a case, disconnect the power cord, and wait at least 45 minutes. After the projector has sufficiently cooled down, please make confirmation of the attachment state of the lamp and lamp cover, and then turn the power on again. If the projector is used at an altitude of about 1600 m (5250 feet) or higher, set ALTITUDE of the SERVICE item in the OPTION menu to HIGH (☐54). Otherwise, set it to NORMAL.

Resetting all settings

When it is hard to correct some wrong settings, the FACTORY RESET function of SERVICE item in OPTION menu (📖56) can reset all settings (except LANGUAGE, FILTER TIME, LAMP TIME, FILTER MESSAGE and SECURITY settings and etc.) to the factory default. Be sure to set ALTITUDE after resetting all the settings (📖54).

Phenomena that may be easy to be mistaken for machine defects

About the phenomenon confused with a machine defect, check and cope with it according to the following table.

Phenomenon	Cases not involving a machine defect	Reference page
Power does not come on.	The electrical power cord is not plugged in. Correctly connect the power cord.	14
	The main power source has been interrupted during operation such as by a power outage (blackout), etc. Please disconnect the power plug from the power outlet, and allow the projector to cool down at least 10 minutes, then turn the power on again.	14
	Either there is no lamp and/or lamp cover, or either of these has not been properly fixed. Please turn the power off and disconnect the power plug from the power outlet, and allow the projector to cool down at least 45 minutes. After the projector has sufficiently cooled down, please make confirmation of the attachment state of the lamp and lamp cover, and then turn the power on again.	62
Neither sounds nor pictures are outputted.	The signal cables are not correctly connected. Correctly connect the connection cables.	10 ~ 13
	Signal source does not correctly work. Correctly set up the signal source device by referring to the manual of the source device.	–
	The input changeover settings are mismatched. Select the input signal, and correct the settings.	21
	The BLANK function for pictures and the MUTE function for sounds are working. AV MUTE may be active. Refer to the item “Sound does not come out” and “No pictures are displayed” on the next page to turn off the MUTE and BLANK functions.	26, 53, 71

(continued on next page)

Phenomena that may be easy to be mistaken for machine defects (continued)

Phenomenon	Cases not involving a machine defect	Reference page
Sound does not come out.	The signal cables are not correctly connected. Correctly connect the audio cables.	10 ~ 13
	The MUTE function is working. Restore the sound pressing MUTE or VOLUME +/- button on the remote control.	19
	The volume is adjusted to an extremely low level. Adjust the volume to a higher level using the menu function or the remote control.	19, 44
	The AUDIO SOURCE/SPEAKER setting is not correct. Correctly set the AUDIO SOURCE/SPEAKER in AUDIO menu.	44
	The mode selected for HDMI AUDIO is not suitable. Check each of the two modes provided and select the suitable one for your HDMI™ audio device.	44
No pictures are displayed.	The signal cables are not correctly connected. Correctly connect the connection cables.	10 ~ 13
	The brightness is adjusted to an extremely low level. Adjust BRIGHTNESS to a higher level using the menu function.	31
	The computer cannot detect the projector as a plug and play monitor. Make sure that the computer can detect a plug and play monitor using another plug and play monitor.	10
	The BLANK screen is displayed. Press BLANK button on the remote control.	26

(continued on next page)

Phenomena that may be easy to be mistaken for machine defects (continued)

Phenomenon	Cases not involving a machine defect	Reference page
Video screen display freezes.	<p>The FREEZE function is working. Press FREEZE button to restore the screen to normal.</p>	26
Colors have a faded- out appearance, or Color tone is poor.	<p>Color settings are not correctly adjusted. Perform picture adjustments by changing the COLOR TEMP, COLOR, TINT and/or COLOR SPACE settings, using the menu functions.</p>	32, 37
	<p>COLOR SPACE setting is not suitable. Change the COLOR SPACE setting to AUTO, RGB, SMPTE240, REC709 or REC601.</p>	37
Pictures appear dark.	<p>The brightness and/or contrast are adjusted to an extremely low level. Adjust BRIGHTNESS and/or CONTRAST settings to a higher level using the menu function.</p>	31
	<p>The projector is operating in Eco mode. Set ECO MODE to NORMAL, and set AUTO ECO MODE to OFF, in the SETUP menu.</p>	41
	<p>The lamp is approaching the end of its product lifetime. Replace the lamp.</p>	62, 63
Pictures appear blurry.	<p>Either the focus and/or horizontal phase settings are not properly adjusted. Adjust the focus using the focus ring, and/or H PHASE using the menu function.</p>	22, 35
	<p>The lens is dirty or misty. Clean the lens referring to the section Caring for the lens.</p>	66

(continued on next page)

Phenomena that may be easy to be mistaken for machine defects (continued)

Phenomenon	Cases not involving a machine defect	Reference page
Some kind of image degradation such as flickering or stripes appear on screen.	<p>When the projector is operating in Eco mode, flickering may appear on screen. Set ECO MODE to NORMAL, and set AUTO ECO MODE to OFF, in the SETUP menu.</p>	41
	<p>The OVER SCAN ratio is too big. Adjust OVER SCAN in the IMAGE menu smaller.</p>	34
	<p>Excessive VIDEO NR. Change the setting of VIDEO NR in the INPUT menu.</p>	37
	<p>The FRAME LOCK function cannot work on the current input signal. Set FRAME LOCK in the INPUT menu to OFF.</p>	39

NOTE • Although bright spots or dark spots may appear on the screen, this is a unique characteristic of liquid crystal displays, and it does not constitute or imply a machine defect.

Specifications

Please see the **Specifications** in the **User's Manual (concise)** which is a book.