

Projector CP-RX93

User's Manual (detailed) Operating Guide

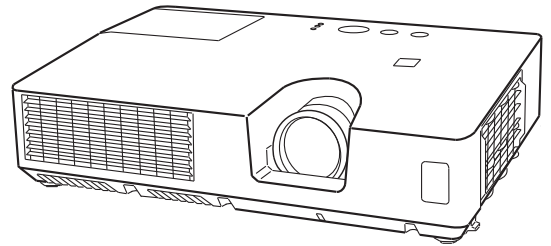

Thank you for purchasing this projector.

⚠ WARNING ▶ Before using this product, please read all manuals for this product. Be sure to read **Safety Guide** first. After reading them, store them in a safe place for future reference.

About this manual

Various symbols are used in this manual. The meanings of these symbols are described below.

⚠ WARNING This symbol indicates information that, if ignored, could possibly result in personal injury or even death due to incorrect handling.

⚠ CAUTION This symbol indicates information that, if ignored, could possibly result in personal injury or physical damage due to incorrect handling.

NOTICE This entry notices of fear of causing trouble.

 Please refer to the pages written following this symbol.

NOTE • The information in this manual is subject to change without notice.
• The illustrations in this manual are for illustrative purposes. They may differ slightly from your projector.
• The manufacturer assumes no responsibility for any errors that may appear in this manual.
• The reproduction, transfer or copy of all or any part of this document is not permitted without express written consent.

Trademark acknowledgment

- Mac[®] is a registered trademark of Apple Inc.
- Windows[®], DirectDraw[®] and Direct3D[®] are registered trademarks of Microsoft Corporation in the U.S. and/or other countries.
- VESA and DDC are trademarks of the Video Electronics Standard Association.
- Blu-ray Disc[™] and Blu-ray[™] are trademarks of Blu-ray Disc Association.

All other trademarks are the properties of their respective owners.

Projector

User's Manual - Safety Guide

Thank you for purchasing this projector.



 **WARNING** • Before using, read these user's manuals of this projector to ensure correct usage through understanding. After reading, store them in a safe place for future reference. Incorrect handling of this product could possibly result in personal injury or physical damage. The manufacturer assumes no responsibility for any damage caused by mishandling that is beyond normal usage defined in these manuals of this projector.

NOTE • The information in this manual is subject to change without notice.

- The manufacturer assumes no responsibility for any errors that may appear in this manual.
- The reproduction, transmission or use of this document or contents is not permitted without express written authority.

About The Symbols

Various symbols are used in this manual, the user's manual and on the product itself to ensure correct usage, to prevent danger to the user and others, and to prevent property damage. The meanings of these symbols are described below. It is important that you read these descriptions thoroughly and fully understand the contents.

| | |
|--|--|
|  WARNING | This symbol indicates information that, if ignored, could possibly result in personal injury or even death due to incorrect handling. |
|  CAUTION | This symbol indicates information that, if ignored, could result possibly in personal injury or physical damage due to incorrect handling. |

Typical Symbols



This symbol indicates an additional warning (including cautions). An illustration is provided to clarify the contents.



This symbol indicates a prohibited action. The contents will be clearly indicated in an illustration or nearby (the symbol to the left indicates that disassembly is prohibited).



This symbol indicates a compulsory action. The contents will be clearly indicated in an illustration or nearby (the symbol to the left indicates that the power plug should be disconnected from the power outlet).

Safety Precautions

WARNING

Never use the projector if a problem should occur.

Abnormal operations such as smoke, strange odor, no image, no sound, excessive sound, damaged casing or elements or cables, penetration of liquids or foreign matter, etc. can cause a fire or electrical shock.

In such case, immediately turn off the power switch and then disconnect the power plug from the power outlet. After making sure that the smoke or odor has stopped, contact your dealer. Never attempt to make repairs yourself because this could be dangerous.

- The power outlet should be close to the projector and easily accessible.

Use special caution for children and pets.

Incorrect handling could result in fire, electrical shock, injury, burn or vision problem.

Use special caution in households where children and pets are present.

Do not insert liquids or foreign object.

Penetration of liquids or foreign objects could result in fire or electrical shock.

Use special caution in households where children are present.

If liquids or foreign object should enter the projector, immediately turn off the power switch, disconnect the power plug from the power outlet and contact your dealer.

- Do not place the projector near water (ex. a bathroom, a beach, etc.).
- Do not expose the projector to rain or moisture. Do not place the projector outdoors.
- Do not place flower vases, pots, cups, cosmetics, liquids such as water, etc on or around the projector.
- Do not place metals, combustibles, etc on or around the projector.
- To avoid penetration of foreign objects, do not put the projector into a case or bag together with any thing except the accessories of the projector, signal cables and connectors.

Never disassemble and modify.

The projector contains high voltage components. Modification and/or disassembly of the projector or accessories could result in fire or electrical shock.

- Never open the cabinet.
- Ask your dealer to repair and clean insides.

Do not give the projector any shock or impact.

If the projector should be shocked and/or broken, it could result in an injury, and continued use could result in fire or electrical shock.

If the projector is shocked, immediately turn off the power switch, disconnect the power plug from the power outlet and contact your dealer.

Do not place the projector on an unstable surface.

If the projector should be dropped and/or broken, it could result in an injury, and continued use could result in fire or electrical shock.

- Do not place the projector on an unstable, slant or vibrant surface such as a wobbly or inclined stand.
- Use the caster brakes placing the projector on a stand with casters.
- Do not place the projector in the side up position, the lens up position or the lens down position.
- In the case of a ceiling installation or the like, contact your dealer before installation.



Disconnect the plug from the power outlet.



Do not disassemble.



Safety Precautions (continued)

WARNING

Be cautious of High temperatures of the projector.

High temperatures are generated when the lamp is lit. It could result in fire or burn. Use special caution in households where children are present.

Do not touch about the lens, air fans and ventilation openings during use or immediately after use, to prevent a burn. Take care of ventilation.

- Keep a space of 30 cm or more between the sides and other objects such as walls.
- Do not place the projector on a metallic table or anything weak in heat.
- Do not place anything about the lens, air fans and ventilation openings of the projector.
- Never block the air fan and ventilation openings.
- Do not cover the projector with a tablecloth, etc.
- Do not place the projector on a carpet or bedding.



Never look through the lens or openings when the lamp is on.

The powerful light could adversely affect vision.

Use special caution in households where children are present.



Use only the correct power cord and the correct power outlet.

Incorrect power supply could result in fire or electrical shock.

- Use only the correct power outlet depending on the indication on the projector and the safety standard.
- The enclosed power cord must be used depending on the power outlet to be used.



Be cautious of the power cord connection.

Incorrect connection of the power cord could result in fire or electrical shock.

- Do not touch the power cord with a wet hand.
- Check that the connecting portion of the power cord is clean (with no dust), before using. Use a soft and dry cloth to clean the power plug.
- Insert the power plug into a power outlet firmly. Avoid using a loose, unsound outlet or contact failure.



Be sure to connect with ground wire.

Connect the ground terminal of AC inlet of this unit with the ground terminal provided at the building using the correct power cord; otherwise, fire or electric shock can result.

- Don't take the core of power cord away.



Surely connect the ground wire.

Safety Precautions (continued)

WARNING

Be careful in handling the light source lamp.

The projector uses a high-pressure mercury glass lamp made of glass. The lamp can break with a loud bang, or burn out. When the bulb bursts, it is possible for shards of glass to fly into the lamp housing, and for gas containing mercury to escape from the projector's vent holes.



Please carefully read the section "Lamp".

Be careful in handling the power cord and external connection cables.

If you keep using a damaged the power cord or cables, it can cause a fire or electrical shock. Do not apply too much heat, pressure or tension to the power cord and cables.

If the power cord or cables is damaged (exposed or broken core wires, etc.), contact your dealer.

- Do not place the projector or heavy objects on the power cord and cables. Also, do not place a spread, cover, etc, over them because this could result in the inadvertent placing of heavy objects on the concealed power cord or cables.



- Do not pull the power cord and cables. When connecting and disconnecting the power cord or cables, do it with your hand holding the plug or connector.

- Do not place the cord near the heater.

- Avoid bending the power cord sharply.

- Do not attempt to work on the power cord.

Be careful in handling the battery of the remote control.

Incorrect handling of the battery could result in fire or personal injury. The battery may explode if not handled properly.

- Keep the battery away from children and pets. If swallowed consult a physician immediately for emergency treatment.

- Do not allow the battery in a fire or water.

- Avoid fire or high-temperature environment.

- Do not hold the battery with the metallic tweezers.

- Keep the battery in a dark, cool and dry place.

- Do not short circuit the battery.

- Do not recharge, disassemble or solder the battery.

- Do not give the battery a physical impact.

- Use only the battery specified in the other manual of this projector.

- Make sure the plus and minus terminals are correctly aligned when loading the battery.

- If you observe a leakage of the battery, wipe out the leakage and then replace the battery. If the leakage adheres your body or clothes, rinse well with water.

- Obey the local laws on disposing the battery.



Safety Precautions (continued)

CAUTION

Be careful in moving the projector.

Neglect could result in an injury or damage.

- Do not move the projector during use. Before moving, disconnect the power cord and all external connections, and close the slide lens door or attach the lens cap.
- Avoid any impact or shock to the projector.
- Do not drag the projector.
- For moving the projector, use the enclosed case or bag if provided.



Do not put anything on top of the projector.

Placing anything on the projector could result in loss of balance or falling, and cause an injury or damage. Use special caution in households where children are present.



Do not attach anything other than specified things to the projector.

Neglect could result in an injury or damage.

- Some projector has a screw thread in a lens part. Do not attach anything other than specified options (such as conversion lens) to the screw thread.



Avoid a smoky, humid or dusty place.

Placing the projector in a smoke, a highly humid, dusty place, oily soot or corrosive gas could result in fire or electrical shock.

- Do not place the projector near a smoky, humid or dusty place (ex. a smoking space, a kitchen, a beach, etc.). Do not place the projector outdoors.
- Do not use a humidifier near the projector.



Take care of the air filter to normal ventilate.

The air filter should be cleaned periodically. If the air filter becomes clogged by dust or the like, internal temperature rises and could cause malfunction. The projector may display the message such as "CHECK THE AIR FLOW" or turn off the projector, to prevent the internal heat level rising.

- When the indicators or a message prompts you to clean the air filter, clean the air filter as soon as possible.
- If the soiling will not come off the air filter, or it becomes damaged, replace the air filter.
- Use the air filter of the specified type only. Please order the air filter specified in the other manual of this projector to your dealer.
- When you replace the lamp, replace also the air filter. The air filter may be attached when you buy a replacement lamp for this projector.
- Do not turn on the projector without air filter.



Avoid a high temperature environment.

The heat could have adverse influence on the cabinet of the projector and other parts. Do not place the projector, the remote control and other parts in direct sunlight or near a hot object such as heater, etc.



Avoid Magnetism.

Manufacture strongly recommends to avoid any magnetic contact that is not shielded or protected on or near the projector itself. (ie., Magnetic Security Devices, or other projector accessory that contains magnetic material that has not been provided by the manufacture etc.) Magnetic objects may cause interruption of the projector's internal mechanical performance which may interfere with cooling fans speed or stopping, and may cause the projector to completely shut down.



Safety Precautions (continued)

CAUTION

Remove the power cord for complete separation.

- For safety purposes, disconnect the power cord if the projector is not to be used for prolonged periods of time.
- Before cleaning, turn off and unplug the projector. Neglect could result in fire or electrical shock.



Disconnect the plug from the power outlet.

Ask your dealer to cleaning inside of the projector about every year.

Accumulations of dust inside the projector cause result in fire or malfunction. Cleaning inside is more effective if performed before every humid periods such as rainy season.



- Do not clean inside yourself because it is dangerous.

NOTE

Do not give the remote control any physical impact.

A physical impact could cause damage or malfunction of the remote control.

- Take care not to drop the remote control.
- Do not place the projector or heavy objects on the remote control.

Take care of the lens.

- Close the slide lens door or attach the lens cap to prevent the lens surface being scratched when the projector is not used.
- Do not touch the lens to prevent fog or dirt of the lens that cause deterioration of display quality.
- Use commercially available lens tissue to clean the lens (used to clean cameras, eyeglasses, etc.). Be careful not to scratch the lens with hard objects.

Take care of the cabinet and the remote control.

Incorrect care could have adverse influence such as discoloration, peeling paint, etc.

- Use a soft cloth to clean the cabinet and control panel of the projector and the remote control. When excessively soiled dilute a neutral detergent in water, wet and wring out the soft cloth and afterward wipe with a dry soft cloth. Do not use undiluted detergent directly.
- Do not use an aerosol sprays, solvents, volatile substances or abrasive cleaner.
- Before using chemical wipes, be sure to read and observe the instructions.
- Do not allow long-term close contact with rubber or vinyl.

About bright spots or dark spots.

Although bright spots or dark spots may appear on the screen, this is a unique characteristic of liquid crystal displays, and such do not constitute or imply a machine defect.

Be careful of printing of the LCD panel.

If the projector continues projecting a still image, inactive images or 16:9 aspect images in case of 4:3 panel, etc., for long time, the LCD panel might possibly be printed.

Safety Precautions (continued)

NOTE

About consumables.

Lamp, LCD panels, polarizers and other optical components, and air filter and cooling fans have a different lifetime in each. These parts may need to be replaced after a long usage time.

- This product isn't designed for continuous use of long time. In the case of continuous use for 6 hours or more, or use for 6 hours or more every day (even if it isn't continuous), or repetitious use, the lifetime may be shortened, and these parts may need to be replaced even if one year has not passed since the beginning of using.
- Any inclining use beyond the adjustment range explained in these user's manuals may shorten the lifetimes of the consumables.

Before turning on the power, make the projector cool down adequately.

After turning the projector off, pushing the restart switch or interrupting of the power supply, make the projector cool down adequately. Operation in a high temperature state of the projector causes a damage of the electrode and un-lighting of the lamp.

Avoid strong rays.

Any strong ray (such as direct rays of the sun or room lighting) onto the remote control sensors could invalidate the remote control.

Avoid radio interference.

Any interfering radiation could cause disordered image or noises.

- Avoid radio generator such as a mobile telephone, transceiver, etc. around the projector.

About displaying characteristic.

The display condition of the projector (such as color, contrast, etc.) depends on characteristic of the screen, because the projector uses a liquid crystal display panel. The display condition can differ from the display of CRT.

- Do not use a polarized screen. It can cause red image.

Turn the power on/off in right order.

To prevent any trouble, turn on/off the projector in right order mentioned below unless specifying.

- Power on the projector before the computer or video tape recorder.
- Power off the projector after the computer or video tape recorder.

Take care not to fatigue your eyes.

Rest the eyes periodically.

Set the sound volume at a suitable level to avoid bothering other people.

- It is better to keep the volume level low and close the windows at night to protect the neighborhood environment.

Connecting with notebook computer

When connecting with notebook computer, set to valid the RGB external image output (setting CRT display or simultaneous display of LCD and CRT).

Please read instruction manual of the notebook for more information.

Lamp

WARNING



HIGH VOLTAGE



HIGH TEMPERATURE



HIGH PRESSURE

The projector uses a high-pressure mercury glass lamp. The lamp can **break with a loud bang, or burn out**, if jolted or scratched, handled while hot, or worn over time. Note that each lamp has a different lifetime, and some may burst or burn out soon after you start using them. In addition, when the bulb bursts, it is possible for **shards of glass** to fly into the lamp housing, and for **gas containing mercury** to escape from the projector's vent holes.

About disposal of a lamp • This product contains a mercury lamp; do not put in trash. Dispose of in accord with environmental laws.

For lamp recycling, go to www.lamprecycle.org. (in USA)

For product disposal, contact your local government agency or www.eiae.org (in the US) or www.epsc.ca (in Canada).

For more information, call your dealer.



Disconnect
the plug from
the power
outlet

- If the lamp should break (it will make a loud bang when it does), unplug the power cord from the outlet, and make sure to request a replacement lamp from your local dealer. Note that shards of glass could damage the projector's internals, or cause injury during handling, so please do not try to clean the projector or replace the lamp yourself.
- If the lamp should break (it will make a loud bang when it does), ventilate the room well, and make sure not to breathe the gas that comes out of the projector vents, or get it in your eyes or mouth.
- Before replacing the lamp, make sure the power switch is off and the power cable is not plugged in, then wait at least 45 minutes for the lamp to cool sufficiently. Handling the lamp while hot can cause burns, as well as damaging the lamp.



- Do not open the lamp cover while the projector is suspended from above. This is dangerous, since if the lamp's bulb has broken, the shards will fall out when the cover is opened. In addition, working in high places is dangerous, so ask your local dealer to have the lamp replaced even if the bulb is not broken.
- Do not use the projector with the lamp cover removed. At the lamp replacing, make sure that the screws are screwed in firmly. Loose screws could result in damage or injury.



- Use the lamp of the specified type only.
- If the lamp breaks soon after the first time it is used, it is possible that there are electrical problems elsewhere besides the lamp. If this happens, contact your local dealer or a service representative.
- Handle with care: jolting or scratching could cause the lamp bulb to burst during use.
- Using the lamp for long periods of time, could cause it dark, not to light up or to burst. When the pictures appear dark, or when the color tone is poor, please replace the lamp as soon as possible. Do not use old (used) lamps; this is a cause of breakage.

Regulatory Notices

FCC Statement Warning

This device complies with part 15 of the FCC Rules. Operation is subject to the following two conditions: (1) This device may not cause harmful interference, and (2) this device must accept any interference received, including interference that may cause undesired operation.

WARNING: This equipment has been tested and found to comply with the limits for a Class B digital device, pursuant to Part 15 of the FCC Rules. These limits are designed to provide reasonable protection against harmful interference in a residential installation. This equipment generates, uses, and can radiate radio frequency energy and, if not installed and used in accordance with the instructions, may cause harmful interference to radio communications. However, there is no guarantee that interference will not occur in a particular installation. If this equipment does cause harmful interference to radio or television reception, which can be determined by turning the equipment off and on, the user is encouraged to try to correct the interference by one or more of the following measures:

- Reorient or relocate the receiving antenna.
- Increase the separation between the equipment and receiver.
- Connect the equipment into an outlet on a circuit different from that to which the receiver is connected.
- Consult the dealer or an experienced radio/TV technician for help.

INSTRUCTIONS TO USERS: This equipment complies with the requirements of FCC (Federal Communication Commission) equipment provided that the following conditions are met. Some cables have to be used with the core set. Use the accessory cable or a designated-type cable for the connection. For cables that have a core only at one end, connect the core to the projector.

CAUTION: Changes or modifications not expressly approved by the party responsible for compliance could void the user's authority to operate the equipment.

For the Customers in CANADA

NOTICE: This Class B digital apparatus complies with Canadian ICES-003.

Warranty And After-Service

Unless seen any abnormal operations (mentioned with the first paragraph of WARNING in this manual), when a problem occurs with the equipment, first refer to the "Troubleshooting" section of the "Operating Guide", and run through the suggested checks. If this does not resolve the problem contact your dealer or service company. They will tell you what warranty condition is applied.

Contents

| | | | |
|---|-----------|--|-----------|
| Introduction | 3 | SETUP menu | 38 |
| Features | 3 |  KEYSTONE, AUTO ECO MODE, ECO MODE, INSTALLATION | |
| Checking the contents of package . . . | 3 | SCREEN menu | 39 |
| Part names | 4 | LANGUAGE, MENU POSITION, BLANK, START UP, MyScreen, MyScreen Lock, MESSAGE, SOURCE NAME, TEMPLATE, C.C. | |
| Setting up | 7 | OPTION menu | 45 |
| Arrangement | 7 | AUTO SEARCH, DIRECT POWER ON, AUTO POWER OFF, LAMP TIME, FILTER TIME, MY BUTTON, MY SOURCE, SERVICE | |
| Connecting with your devices | 10 | SECURITY menu | 51 |
| Connecting to a power supply | 13 | SECURITY PASSWORD CHANGE, MYSCREEN PASSWORD, PIN LOCK, MY TEXT PASSWORD, MY TEXT DISPLAY, MY TEXT WRITING | |
| Using the security bar and slot | 14 | Maintenance | 56 |
| Remote control | 15 | Replacing the lamp | 56 |
| Installing the batteries | 15 | Cleaning and replacing the air filter . . | 58 |
| About the remote control signal . . . | 15 | Other care | 60 |
| Power on/off | 16 | Troubleshooting | 61 |
| Turning on the power | 16 | Related messages | 61 |
| Turning off the power | 17 | Regarding the indicator lamps | 63 |
| Operating | 18 | Resetting all settings | 65 |
| Selecting an input signal | 18 | Phenomena that may be easy to be mistaken for machine defects . . | 65 |
| Searching an input signal | 19 | Specifications | 68 |
| Selecting an aspect ratio | 19 | | |
| Adjusting the projector's elevator . . | 20 | | |
| Adjusting the zoom and focus | 20 | | |
| Using the automatic adjustment feature . . | 21 | | |
| Adjusting the position | 21 | | |
| Correcting the keystone distortions . . | 22 | | |
| Using the magnify feature | 23 | | |
| Temporarily freezing the screen . . . | 24 | | |
| Temporarily blanking the screen . . | 24 | | |
| Using the menu function | 25 | | |
| EASY MENU | 27 | | |
| ASPECT,  KEYSTONE, PICTURE MODE, ECO MODE, INSTALLATION, RESET, FILTER TIME, LANGUAGE, ADVANCED MENU, EXIT | | | |
| PICTURE menu | 29 | | |
| BRIGHTNESS, CONTRAST, GAMMA, COLOR TEMP, COLOR, TINT, SHARPNESS, MY MEMORY | | | |
| IMAGE menu | 32 | | |
| ASPECT, OVER SCAN, V POSITION, H POSITION, H PHASE, H SIZE, AUTO ADJUST EXECUTE | | | |
| INPUT menu | 35 | | |
| PROGRESSIVE, VIDEO NR, COLOR SPACE, VIDEO FORMAT, COMPUTER IN, FRAME LOCK, RESOLUTION | | | |

Introduction

Features

The projector provides you with the broad use by the following features.

- ✓ This projector has a variety of I/O ports that supposedly cover for any business scene.
- ✓ This compact, lightweight projector uses a front exhaust system that keeps the user comfortable by directing hot air away from the user.

Checking the contents of package

Please see the **Contents of package** section in the **User's Manual (concise)** which is a book. Your projector should come with the items shown there. Require of your dealer immediately if any items are missing.

⚠ WARNING ► Keep small parts away from children and pets. Take care not to put in the mouth. If swallowed, consult a physician immediately for emergency treatment.

NOTE • Keep the original packing materials, for future reshipment. Be sure to use the original packing materials when moving the projector. Use special caution for the lens.

- The projector may make a rattling sound when tilted, moved or shaken, since a flap to control the air flow inside of the projector has moved. Be aware that this is not a failure or malfunction.

Part names

- (1) Lamp cover (📖56)
The lamp unit is inside.
- (2) **FOCUS** ring (📖20)
- (3) **ZOOM** ring (📖20)
- (4) Control panel (📖5)
- (5) Elevator buttons (x 2) (📖20)
- (6) Elevator feet (x 2) (📖20)
- (7) Remote sensor (📖15)
- (8) Lens (📖60)
- (9) Intake vents
- (10) Filter cover (📖58)
The air filter and intake vent are inside.
- (11) Exhaust vent
- (12) **AC IN** (AC inlet) (📖13)
- (13) Rear panel (📖5)
- (14) Security bar (📖14)
- (15) Security slot (📖14)

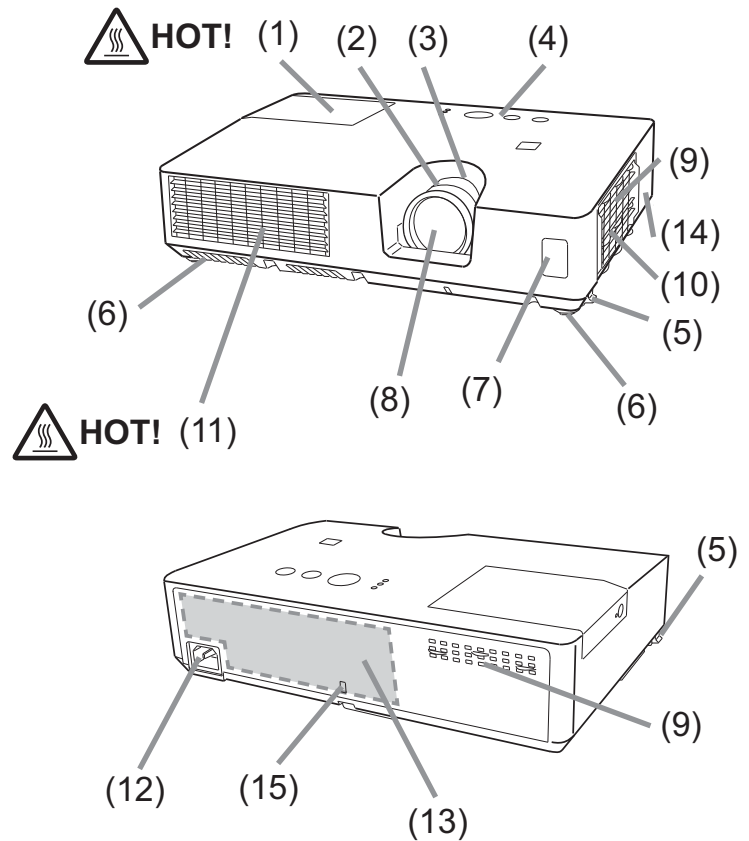

⚠️ WARNING ► Do not open or remove any portion of the product, unless the manuals direct it.

► Do not subject the projector to unstable conditions.

► Do not apply a shock or pressure to this product.

► Do not look into the lens and the openings on the projector while the lamp is on.

⚠️ CAUTION ► Do not touch around the lamp cover and the exhaust vents during use or just after use, since it is too hot.

► Do not attach anything onto the lens because it could damage the lens, such as melting the lens.



(continued on next page)

Part names (continued)**Control panel**

- (1) **STANDBY/ON** button (📖 16)
- (2) **INPUT** button (📖 18, 25)
- (3) **MENU** button (📖 25)

It consists of four cursor buttons.

- (4) **ECO** button (📖 47)
- (5) **POWER** indicator (📖 16, 63)
- (6) **TEMP** indicator (📖 63)
- (7) **LAMP** indicator (📖 63)

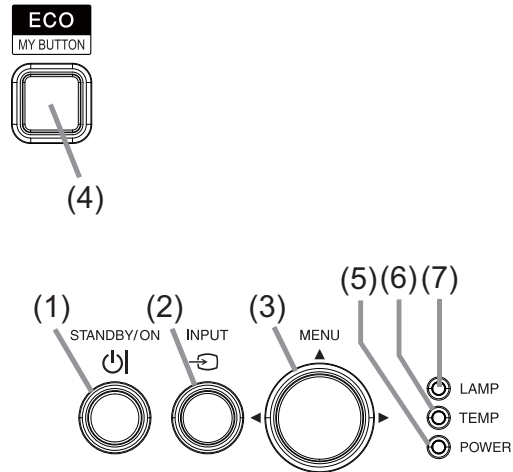
**Rear panel (📖 11, 12)**

- (1) **VIDEO** port
- (2) **COMPUTER IN** port

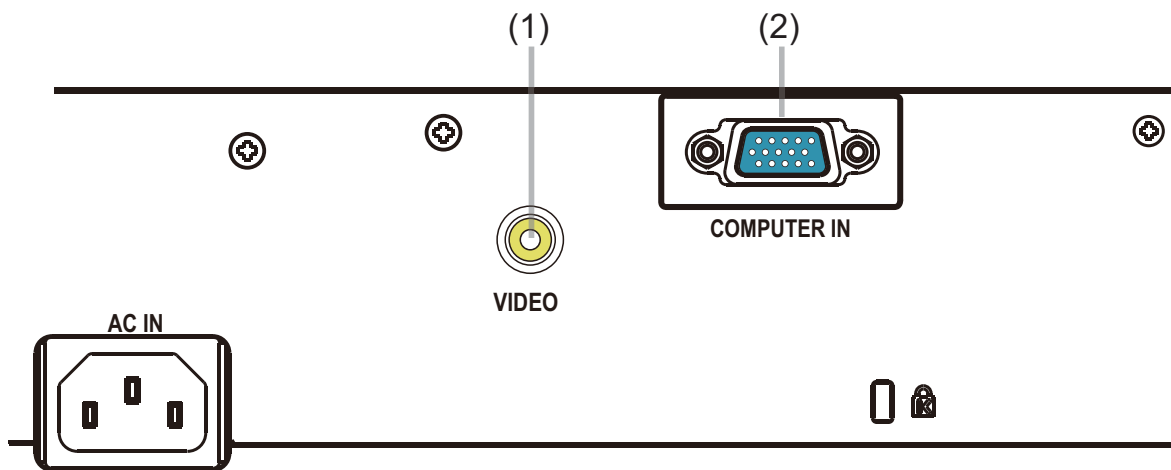

(continued on next page)

Part names (continued)

Remote control

- (1) **VIDEO** button (📖18)
- (2) **COMPUTER** button (📖18)
- (3) **SEARCH** button (📖19)
- (4) **STANDBY/ON** button (📖16)
- (5) **ASPECT** button (📖19)
- (6) **AUTO** button (📖21)
- (7) **BLANK** button (📖24)
- (8) **MAGNIFY - ON** button (📖23)
- (9) **MAGNIFY - OFF** button (📖23)
- (10) **MY SOURCE/DOC.CAMERA** button (📖18, 48)
- (11) **VOLUME -** button *
- (12) **PAGE UP** button *
- (13) **PAGE DOWN** button *
- (14) **VOLUME +** button *
- (15) **MUTE** button *
- (16) **FREEZE** button (📖24)
- (17) **MY BUTTON - 1** button (📖47)
- (18) **MY BUTTON - 2** button (📖47)
- (19) **KEystone** button (📖22)
- (20) **POSITION** button (📖21, 25)
- (21) **MENU** button (📖25)
- (22) **▲/▼/◀/▶** cursor buttons (📖25)
- (23) **ENTER** button (📖25)
- (24) **ESC** button (📖25)
- (25) **RESET** button (📖25)
- (26) Battery cover (📖15)

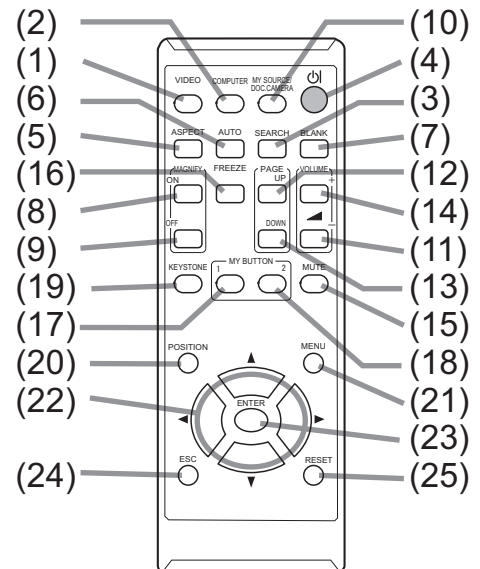

Back of the remote control

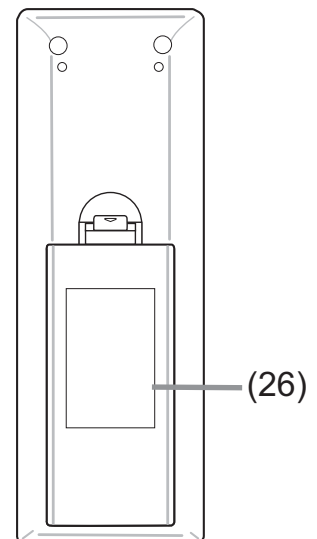

NOTE • Any button marked with “*” is not supported on this projector (📖62).

Setting up

Install the projector according to the environment and manner the projector will be used in.

For the case of installation in a special state such as ceiling mount, the specified mounting accessories ( **Specifications** in the **User's Manual (concise)**) and service may be required. Before installing the projector, consult your dealer about your installation.

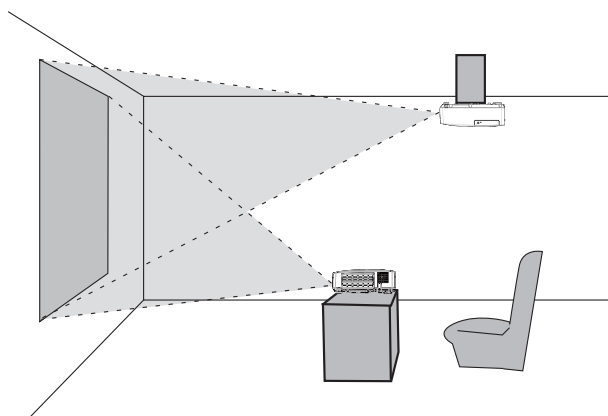

Arrangement

Refer to tables **T-1** and **T-2** at the back of **User's Manual (concise)** as well as the following to determine the screen size and projection distance.

The values shown in the table are calculated for a full size screen.

- (a) Screen size (diagonal)
 - (b) Projection distance ($\pm 10\%$, from the projector's end)
 - (c1), (c2) Screen height ($\pm 10\%$)
- If the projector is used at an altitude of about 1600 m (5250 feet) or higher, set ALTITUDE of the SERVICE item in the OPTION menu to HIGH ( 48). Otherwise, set it to NORMAL. If the projector is used with a wrong setting, it may cause damage to the projector itself or the parts inside.

(continued on next page)

Arrangement (continued)

⚠ WARNING ▶ Install the projector where you can access the power outlet easily. If an abnormality should occur, unplug the projector urgently. Otherwise it could cause a fire or electric shock.

▶ Do not subject the projector to unstable conditions. If the projector falls or topples over, it could result in injury or damage to the projector and the surrounding things. Using a damaged projector could result in a fire and an electric shock.

- Do not place the projector in unstable places, such as an inclined surface, places subject to vibration, on top of a wobbly table or cart, or a surface that is smaller than the projector.
- Do not put the projector on its side, front or rear position.
- Do not attach nor place anything on the projector unless otherwise specified in the manual.
- Do not use any mounting accessories except the accessories specified by the manufacturer. Read and keep the manuals of the accessories used.
- For special installation such as ceiling mounting, be sure to consult your dealer beforehand.

▶ Do not install the projector near thermally conductive or flammable things. Such things when heated by the projector could result in a fire and burns.

- Do not place the projector on a metal stand.

▶ Do not place the projector where any oils, such as cooking or machine oil, are used. Oil may harm the product, resulting in malfunction, or falling from the mounted position.

▶ Do not place the projector in a place where it may get wet. Getting the projector wet or inserting liquid into the projector could cause a fire and an electric shock, and damage the projector.

- Do not place the projector near water, such as in a bathroom, kitchen, or poolside.
- Do not place the projector outdoors or by the window.
- Do not place anything containing liquid near the projector.

(continued on next page)

Arrangement (continued)

⚠ CAUTION ▶ Place the projector in a cool place with sufficient ventilation. The projector may shutdown automatically or may malfunction if its internal temperature is too high.

Using a damaged projector could result in a fire and an electric shock.

- Do not place the projector in direct sunlight or near hot objects such as heaters.
- Do not place the projector where the air from an air conditioner or similar unit will blow on it directly.
- Keep a space of 30 cm or more between a side of the projector and other objects such as walls.
- Do not place the projector on carpet, cushions or bedding.
- Do not stop up, block nor cover the projector's vent holes. Do not place anything around the projector that could be sucked in or stuck to the projector's intake vents.
- Do not place the projector at places that are exposed to magnetic fields, doing so can cause the cooling fans inside the projector to malfunction.

▶ Avoid placing the projector in smoky, humid or dusty place. Placing the projector in such places could cause a fire, an electric shock and malfunction of the projector.

- Do not place the projector near humidifiers. Especially for an ultrasonic humidifier, chlorine and minerals contained in tap water are atomized and could be deposited in the projector causing image degradation or other problems.

NOTICE • Do not place the projector in a smoking area, kitchen, passageway or by the window.

- Position the projector to prevent light from directly hitting the projector's remote sensor.
- Do not place the product in a place where radio interference may be caused.
- Check and correct the setting for ALTITUDE of SERVICE in the OPTION menu according to the usage environment ( 48). If the projector is used with a wrong setting, it may cause damage to the projector itself or the parts inside.
- Keep heat-sensitive things away from the projector. Otherwise, they may be damaged by the heat from the projector.

Connecting with your devices

Before connecting the projector to a device, consult the manual of the device to confirm that the device is suitable for connecting with this projector and prepare the required accessories, such as a cable in accord with the signal of the device. Consult your dealer when the required accessory did not come with the product or the accessory is damaged.

After making sure that the projector and the devices are turned off, perform the connection, according to the following instructions. Refer to the figures in subsequent pages.

⚠ WARNING ▶ Use only the appropriate accessories. Otherwise it could cause a fire or damage the projector and devices.

- Use only the accessories specified or recommended by the projector's manufacturer. It may be regulated under some standard.
- Neither disassemble nor modify the projector and the accessories.
- Do not use the damaged accessory. Be careful not to damage the accessories. Route a cable so that it is neither stepped on nor pinched out.

⚠ CAUTION ▶ For a cable with a core at only one end, connect the end with the core to the projector. That may be required by EMI regulations.

NOTE • Do not turn on or off the projector while connected to a device in operation, unless that is directed in the manual of the device. Otherwise it may cause malfunction in the device or projector.

- The function of some input ports can be selected according to your usage requirements. Check the reference page indicated beside each port in the following illustration.
- Be careful not to mistakenly connect a connector to a wrong port. Otherwise it may cause malfunction in the device or projector.
 - When connecting a connector to a port, make sure that the shape of the connector fits the port.
 - Tighten the screws to connect a connector equipped with screws to a port.
 - Use the cables with straight plugs, not L-shaped ones, as the input ports of the projector are recessed.

About Plug-and-Play capability

- Plug-and-Play is a system composed of a computer, its operating system and peripheral equipment (i.e. display devices). This projector is VESA DDC 2B compatible. Plug-and-Play can be used by connecting this projector to a computer that is VESA DDC (display data channel) compatible.
 - Take advantage of this feature by connecting a computer cable to the **COMPUTER IN** port (DDC 2B compatible). Plug-and-Play may not work properly if any other type of connection is attempted.
 - Please use the standard drivers in your computer as this projector is a Plug-and-Play monitor.

(continued on next page)

Connecting with your devices (continued)

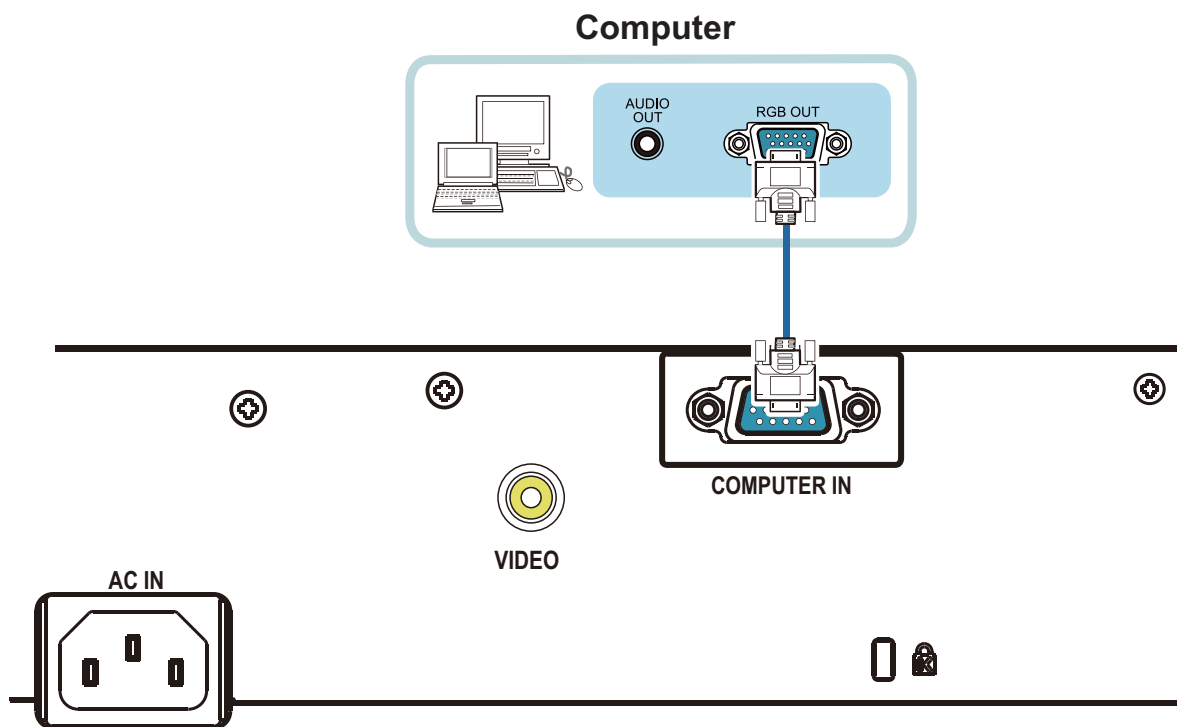

NOTE • Before connecting the projector to a computer, consult the computer's manual and check the compatibility of the signal level, the synchronization methods and the display resolution output to the projector.

- Some signal may need an adapter to input this projector.
- Some computers have multiple screen display modes that may include some signals which are not supported by this projector.
- Although the projector can display signals with resolution up to UXGA (1600x1200), the signal will be converted to the projector's panel resolution before being displayed. The best display performance will be achieved if the resolutions of the input signal and the projector panel are identical.
- If you connect this projector and a notebook computer, you need output the display to an external monitor, or output simultaneously to the internal display and an external monitor. Consult the computer's manual for the setting.
- Depending on the input signal, the automatic adjustment function of this projector may take some time and not function correctly.
- Note that a composite sync signal or sync-on-green signal may confuse the automatic adjustment function of this projector ([36](#)).
- If the automatic adjustment function does not work correctly, you may not see the dialog to set the display resolution. In such a case, use an external display device. You may be able to see the dialog and set an appropriate display resolution.

(continued on next page)

Connecting with your devices (continued)

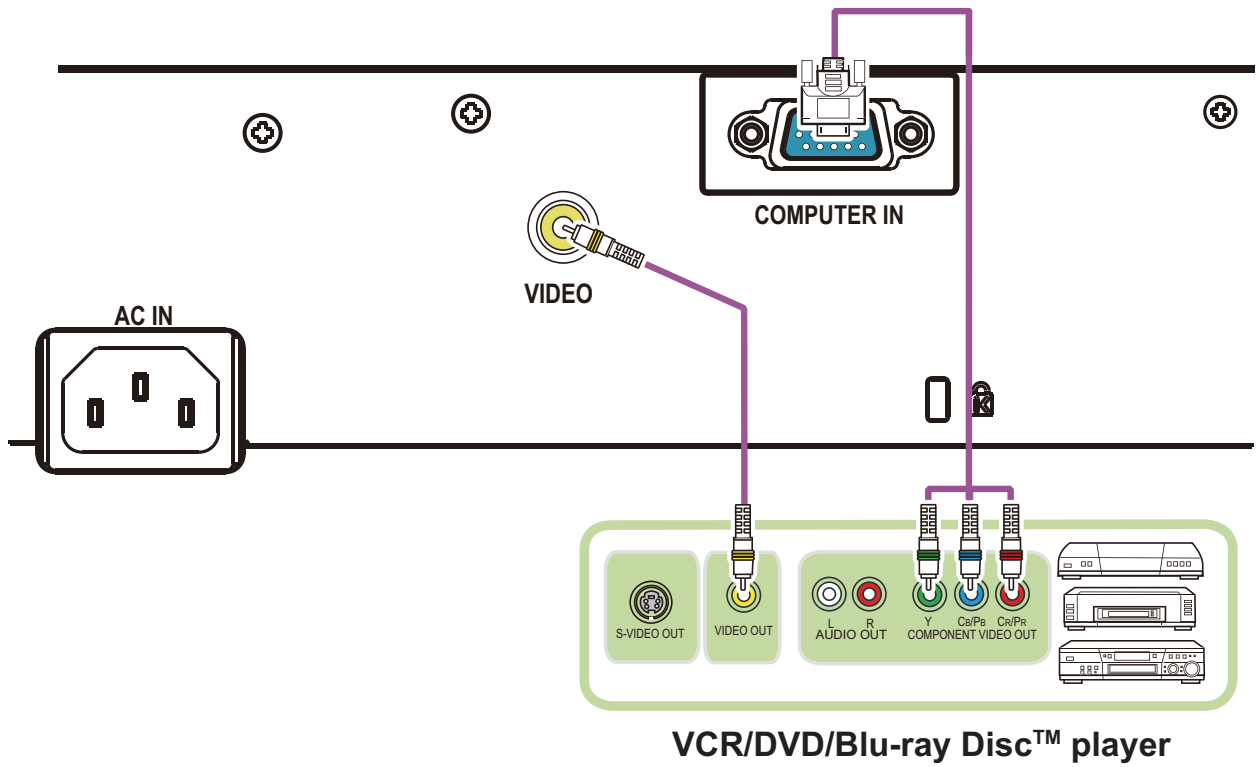

Connecting to a power supply

1. Put the connector of the power cord into the **AC IN** (AC inlet) of the projector.
2. Firmly plug the power cord's plug into the outlet. In a couple of seconds after the power supply connection, the **POWER** indicator will light up in steady orange.

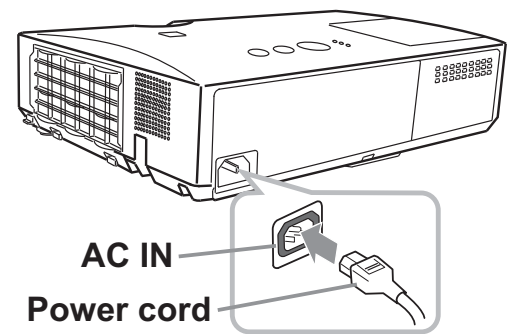

Please remember that when the DIRECT POWER ON function activated (📖45), the connection of the power supply make the projector turn on.

⚠ WARNING ► Please use extra caution when connecting the power cord, as incorrect or faulty connections may result in fire and/or electrical shock.

- Do not touch the power cord with a wet hand.
- Only use the power cord that came with the projector. If it is damaged, consult your dealer to get a new one. Never modify the power cord.
- Only plug the power cord into an outlet whose voltage is matched to the power cord. The power outlet should be close to the projector and easily accessible. Remove the power cord for complete separation.
- Do not distribute the power supply to multiple devices. Doing so may overload the outlet and connectors, loosen the connection, or result in fire, electric shock or other accidents.
- Connect the ground terminal for the AC inlet of this unit to the ground terminal of the building using an appropriate power cord (bundled).

NOTICE ► This product is also designed for IT power systems with a phase-to-phase voltage of 220 to 240 V.

Using the security bar and slot

A commercially available anti-theft chain or wire can be attached to the security bar on the projector. Refer to the figure to choose an anti-theft chain or wire.

Also this product has the security slot for the Kensington lock.

For details, see the manual of the security tool.

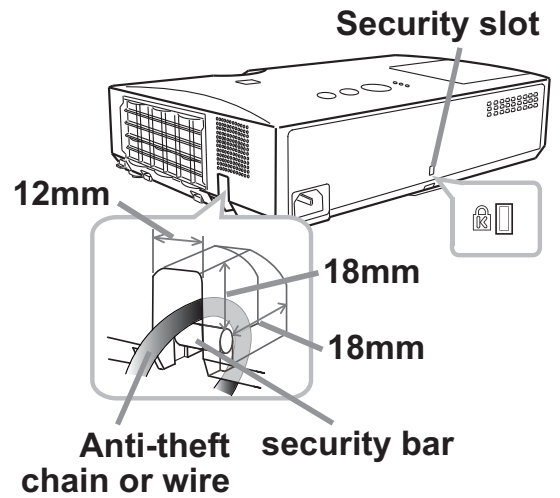
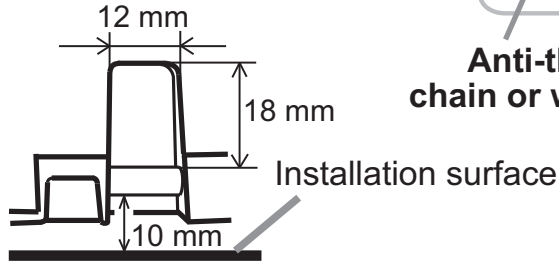
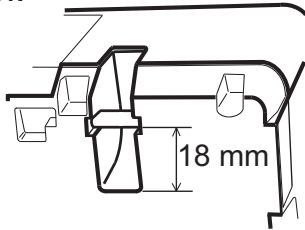

⚠ WARNING ► Do not use the security bar and slot to prevent the projector from falling down, since it is not designed for it.

⚠ CAUTION ► Do not place anti-theft chain or wire near the exhaust vents. It may become too hot.

NOTE • The security bar and slot is not comprehensive theft prevention measures. It is intended to be used as supplemental theft prevention measure.

Remote control

Installing the batteries

Please insert the batteries into the remote control before using it. If the remote control starts to malfunction, try to replace the batteries. If you will not use the remote control for long period, remove the batteries from the remote control and store them in a safe place.

1. Holding the hook part of the battery cover, remove it.
2. Align and insert the two AA batteries (**HITACHI MAXELL or HITACHI MAXELL ENERGY, Part No.LR6 or R6P**) according to their plus and minus terminals as indicated in the remote control.
3. Replace the battery cover in the direction of the arrow and snap it back into place.

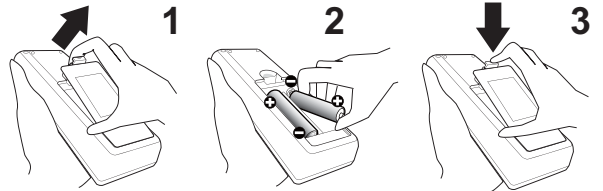

- ⚠ WARNING** ► Always handle the batteries with care and use them only as directed. Improper use may result in battery explosion, cracking or leakage, which could result in fire, injury and/or pollution of the surrounding environment.
- Be sure to use only the batteries specified. Do not use batteries of different types at the same time. Do not mix a new battery with used one.
 - Make sure the plus and minus terminals are correctly aligned when loading a battery.
 - Keep a battery away from children and pets.
 - Do not recharge, short circuit, solder or disassemble a battery.
 - Do not place a battery in a fire or water. Keep batteries in a dark, cool and dry place.
 - If you observe battery leakage, wipe out the leakage and then replace a battery. If the leakage adheres to your body or clothes, rinse well with water immediately.
 - Obey the local laws on disposing the battery.

About the remote control signal

The remote control works with the projector's remote sensor. This projector has a remote sensor on the front. The sensor senses the signal within the following range when the sensor is active:

60 degrees (30 degrees to the left and right of the sensor)
within 3 meters about.

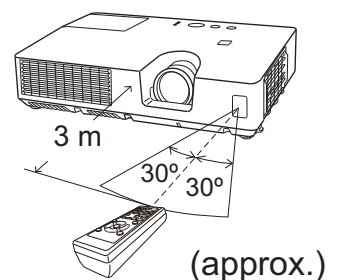

- NOTE** • The remote control signal reflected in the screen or the like may be available. If it is difficult to send the signal to the sensor directly, attempt to make the signal reflect.
- The remote control uses infrared light to send signals to the projector (Class 1 LED), so be sure to use the remote control in an area free from obstacles that could block the remote control's signal to the projector.
 - The remote control may not work correctly if strong light (such as direct sun light) or light from an extremely close range (such as from an inverter fluorescent lamp) shines on the remote sensor of the projector. Adjust the position of projector avoiding those lights.

Power on/off

Turning on the power

1. Make sure that the power cord is firmly and correctly connected to the projector and the outlet.
2. Make sure that the **POWER** indicator is steady orange (📖63).
3. Press **STANDBY/ON** button on the projector or the remote control.
The projection lamp will light up and **POWER** indicator will begin blinking in green. When the power is completely on, the indicator will stop blinking and light in steady green (📖63).

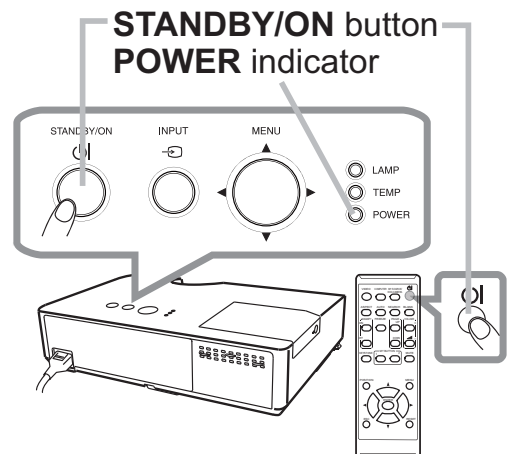

To display the picture, select an input signal according to the section **Selecting an input signal** (📖18).

The INITIAL SETTING Menu will be displayed by factory default upon startup. Once the INITIAL SETTING Menu is set, it will not appear until **FACTORY RESET** (📖50) is executed. If you wish to change the settings, refer to the **LANGUAGE** (📖39) and **ALTITUDE** (📖48) menu.

- (1) **LANGUAGE**: Use the ▲/▼/◀/▶ buttons to select the desired language and press the **ENTER** button of the remote control or the **INPUT** button of the projector to execute.

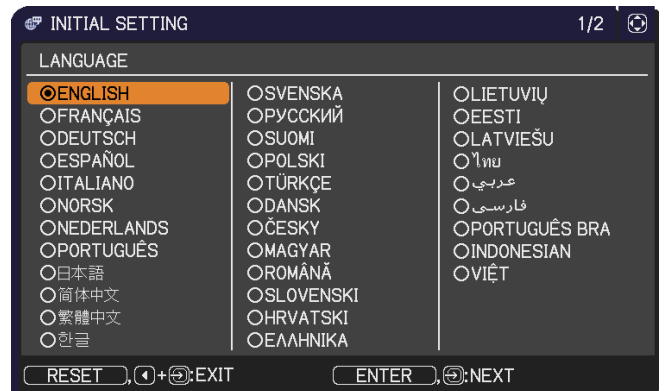

- (2) **ALTITUDE**: Use the ▲/▼ buttons to select **NORMAL** for altitude below 1600 m (5250 feet), otherwise select **HIGH** and press the **ENTER** button of the remote control or the **INPUT** button of the projector to execute.

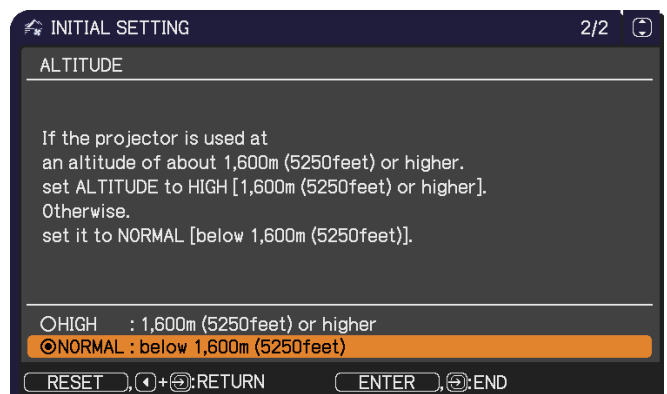

Turning off the power

1. Press the **STANDBY/ON** button on the projector or the remote control.
 - The message “Power off?” will appear on the screen for about 5 seconds.
2. Press the **STANDBY/ON** button again while the message appears.
 - The projector lamp will go off, and the **POWER** indicator will begin blinking in orange. Then **POWER** indicator will stop blinking and light in steady orange when the lamp cooling is complete ([📖63](#)).

Do not turn the projector on for about 10 minutes or more after turning it off. Also, do not turn the projector off shortly after turning it on. Such operations might cause the lamp to malfunction or shorten the lifetime of some parts including the lamp.

⚠ WARNING ▶ A strong light is emitted when the projector’s power is on. Do not look into the lens of the projector or look inside of the projector through any of the projector’s openings.
▶ Do not touch around the lamp cover and the exhaust vents during use or just after use, since it is too hot.

NOTE • Turn the power on/off in right order. Please power on the projector prior to the connected devices.
• This projector has the function that can make the projector automatically turn on/off. Please refer to the **DIRECT POWER ON** ([📖45](#)) and **AUTO POWER OFF** ([📖45](#)) items of the **OPTION** menu.

Operating

Selecting an input signal

1. Press **INPUT** button on the projector.
 - Each time you press the button, the projector switches its input port from the current port as below.

COMPUTER IN ⇔ VIDEO

INPUT button

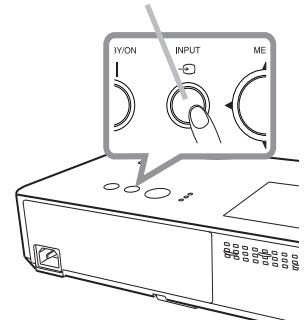

- While ON is selected for AUTO SEARCH item in OPTION menu (📖45), the projector will keep checking the ports in above order repeatedly till an input signal is detected.

1. Press **COMPUTER** button on the remote control to select the **COMPUTER IN** port.

COMPUTER button

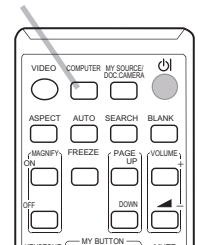

1. Press **VIDEO** button on the remote control.

VIDEO button

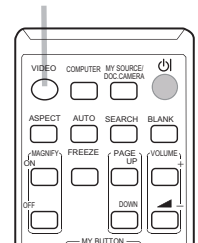

1. Press the **MY SOURCE / DOC. CAMERA** button on the remote control. The input signal will be changed into the signal you set as MY SOURCE (📖48).

MY SOURCE / DOC. CAMERA button

- This function also can use for document camera. Select the input port that connected the document camera.

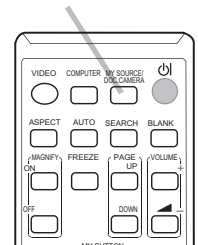

Searching an input signal

1. Press **SEARCH** button on the remote control.
 - The projector will start to check its input ports as below in order to find any input signals. When an input is found, the projector will stop searching and display the image. If no signal is found, the projector will return to the state selected before the operation.

COMPUTER IN ⇔ VIDEO

SEARCH button

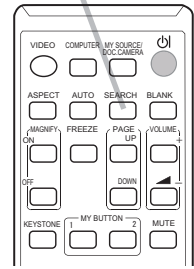

- While ON is selected for AUTO SEARCH item in OPTION menu (📖45), the projector will keep checking the ports in above order repeatedly till an input signal is detected.

Selecting an aspect ratio

1. Press **ASPECT** button on the remote control.
 - Each time you press the button, the projector switches the mode for aspect ratio in turn.

○ For a computer signal

NORMAL → 4:3 → 16:9 → 16:10
 ↑

○ For a video signal or component video signal

4:3 → 16:9 → 14:9
 ↑

○ For no signal

4:3 (fixed)

- **ASPECT** button does not work when no proper signal is inputted.
- **NORMAL** mode keeps the original aspect ratio setting.

ASPECT button

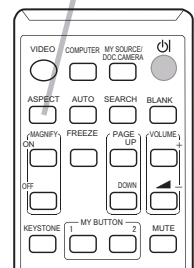

Adjusting the projector's elevator

When the place to put the projector is slightly uneven to the left or right, use the elevator feet to place the projector horizontally.

Using the feet can also tilt the projector in order to project at a suitable angle to the screen, elevating the front side of the projector within 12 degrees.

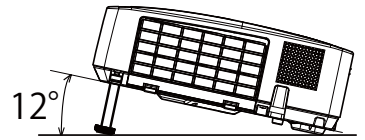

This projector has 2 elevator feet and 2 elevator knobs. An elevator foot is adjustable while pulling up the elevator knob on the same side as it.

1. Holding the projector, pull the elevator knobs up to loose the elevator feet.
2. Position the front side of the projector to the desired height.
3. Release the elevator knobs in order to lock the elevator feet.
4. After making sure that the elevator feet are locked, put the projector down gently.
5. If necessary, the elevator feet can be manually twisted to make more precise adjustments. Hold the projector when twisting the feet.

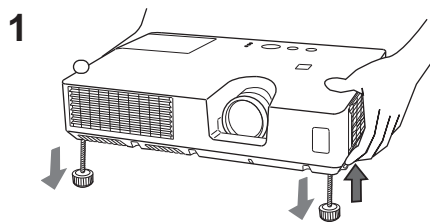

To loose an elevator foot, pull up the elevator knob on the same side as it.

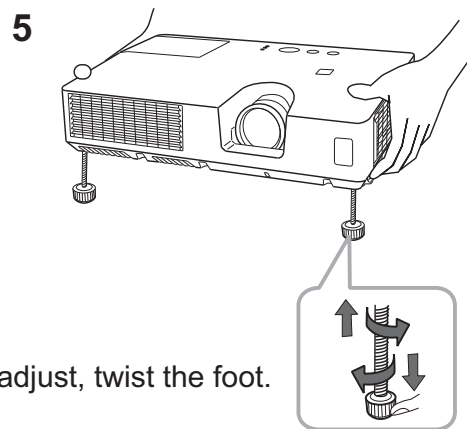

To finely adjust, twist the foot.

⚠ CAUTION ► Do not handle the elevator buttons without holding the projector, since the projector may drop down.

► Do not tilt the projector other than elevating its front within 12 degrees using the adjuster feet. A tilt of the projector exceeding the restriction could cause malfunction or shortening the lifetime of consumables, or the projector itself.

Adjusting the zoom and focus

1. Use the **ZOOM** ring to adjust the screen size.
2. Use the **FOCUS** ring to focus the picture.

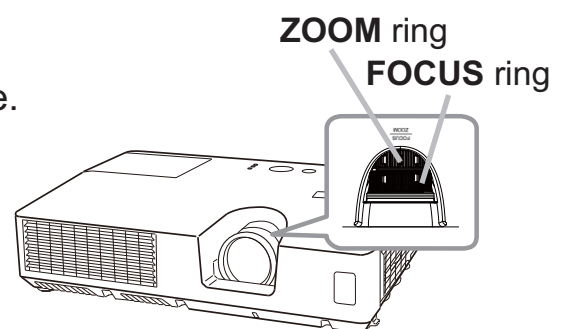

Using the automatic adjustment feature

1. Press **AUTO** button on the remote control.
- Pressing this button performs the following.

- **For a computer signal**

The vertical position, the horizontal position and the horizontal phase will be automatically adjusted.

Make sure that the application window is set to its maximum size prior to attempting to use this feature. A dark picture may still be incorrectly adjusted. Use a bright picture when adjusting.

- **For a video signal**

The video format best suited for the respective input signal will be selected automatically. This function is available only when the AUTO is selected for the VIDEO FORMAT item in the INPUT menu (📖36). The vertical position and horizontal position will be automatically set to the default.

- **For a component video signal**

The vertical position and horizontal position will be automatically set to the default. The horizontal phase will be automatically adjusted.

- The automatic adjustment operation requires approx. 10 seconds. Also please note that it may not function correctly with some input.
- When this function is performed for a video signal, a certain extra such as a line may appear outside a picture.
- When this function is performed for a computer signal, a black frame may be displayed on the edge of the screen, depending on the computer model.
- The items adjusted by this function may vary when the FINE or DISABLE is selected for the AUTO ADJUST item of the SERVICE item in the OPTION menu (📖48).

AUTO button

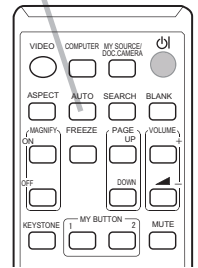

Adjusting the position

1. Press **POSITION** button on the remote control when no menu is indicated.

The “POSITION” indication will appear on the screen.

2. Use the ▲/▼/◀/▶ cursor buttons to adjust the picture position.
- When you want to reset the operation, press **RESET** button on the remote control during the operation.

To complete this operation, press **POSITION** button again. Even if you do not do anything, the dialog will automatically disappear after a few seconds.

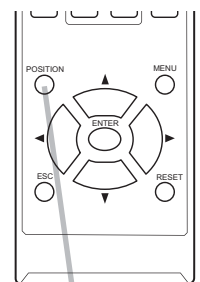

POSITION button

- When this function is performed on a video signal or component video signal, some image such as an extra-line may appear at outside of the picture.
- When this function is performed on a video signal, the range of this adjustment depends on OVER SCAN in IMAGE menu (📖32) setting. It is not possible to adjust when OVER SCAN is set to 10.
- If **POSITION** button is pressed when a menu is indicated on screen, the displayed picture does not move its position but the menu does.

Correcting the keystone distortions

1. Press **KEYSTONE** button on the remote control. A dialog will appear on the screen to aid you in correcting the distortion.
2. Use the ◀/▶ buttons for adjustment.
To close the dialog and complete this operation, press **KEYSTONE** button again. Even if you do not do anything, the dialog will automatically disappear after a few seconds.

KEYSTONE button

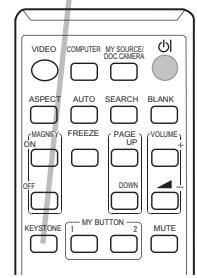

- The menu or dialog will automatically disappear after several seconds of inactivity. Pressing the **KEYSTONE** button again finishes the operation and closes the menu or dialog.
- The adjustable range of this function will vary among inputs. For some input, this function may not work well.
- When the projector is placed on the level (about $\pm 4^\circ$), the automatic keystone distortion correction may not work.
- When the projector is inclined to near ± 30 degree or over, this function may not work well.

Using the magnify feature

1. Press the **MAGNIFY ON** button on the remote control.
 - The picture will be magnified, and the MAGNIFY dialog will appear on the screen. When the **MAGNIFY ON** button is pressed for the first time after the projector is turned on, the picture will be zoomed by 1.5 times. On the dialog, triangle marks to show each direction will be displayed.



MAGNIFY ON/OFF button

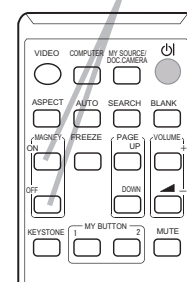

2. The display magnification of the projector switches in order with every press of the **MAGNIFY ON** button.

○ **For computer signals**

1.5 times → 2 times → 3 times → 4 times → 1 time

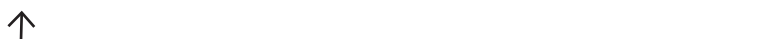

○ **For video signals or component video signals**

1.5 times → 2 times → 1 time



3. While the triangles are displayed on the dialog, use the ▲/▼/◀/▶ cursor buttons to shift the magnifying area.

4. Press the **MAGNIFY OFF** button on the remote control to exit magnification.

- The MAGNIFY dialog will automatically disappear in several seconds with no operation. The dialog will appear again if the **MAGNIFY ON** button is pressed when the dialog has automatically disappeared.
- The magnification is automatically disabled when the displaying signal or its display condition is changed.
- While the magnification is active, the keystone distortion condition may vary. It will be restored when the magnification is disabled.
- Some horizontal stripes might be visible on the image while magnification is active.
- This function is not available in the following cases:
 - A sync signal in the range not supported is input.
 - There is no input signal.

Temporarily freezing the screen

1. Press the **FREEZE** button on the remote control.
 - The “FREEZE” indication will appear on the screen (however, the indication will not appear when the OFF is selected for the MESSAGE item in the SCREEN menu (📖41)), and the projector will go into the FREEZE mode, which the picture is frozen.

To exit the FREEZE mode and restore the screen to normal, press the **FREEZE** button again.

- The projector automatically exits from the FREEZE mode when some control buttons are pressed.
- If the projector continues projecting a still image for a long time, the LCD panel might possibly be burned in. Do not leave the projector in the FREEZE mode for too long.
- Images might appear degraded when this function is operated, but it is not a malfunction.

FREEZE button

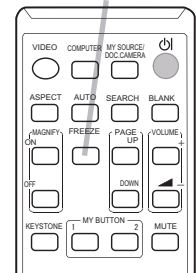

Temporarily blanking the screen

1. Press **BLANK** button on the remote control.
 - The BLANK screen will be displayed instead of the screen of input signal. Please refer to BLANK item in SCREEN menu (📖39).

To exit from the BLANK screen and return to the input signal screen, press **BLANK** button again.

- The projector automatically exits from the BLANK mode when some control buttons are pressed.

BLANK button

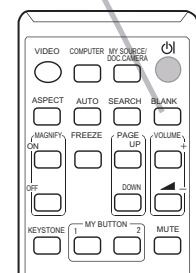

⚠ CAUTION ► If you wish to have a blank screen while the projector's lamp is on, use the BLANK function above. Taking any other action may cause the damage on the projector.

Using the menu function

This projector has the following menus:

PICTURE, IMAGE, INPUT, SETUP, SCREEN, OPTION, SECURITY and EASY MENU. EASY MENU consists of functions often used, and the other menus are classified into each purpose and brought together as the ADVANCED MENU.

Each of these menus is operated using the same methods. While the projector is displaying any menu, the **MENU** button on the projector works as the cursor buttons. The basic operations of these menus are as follows.

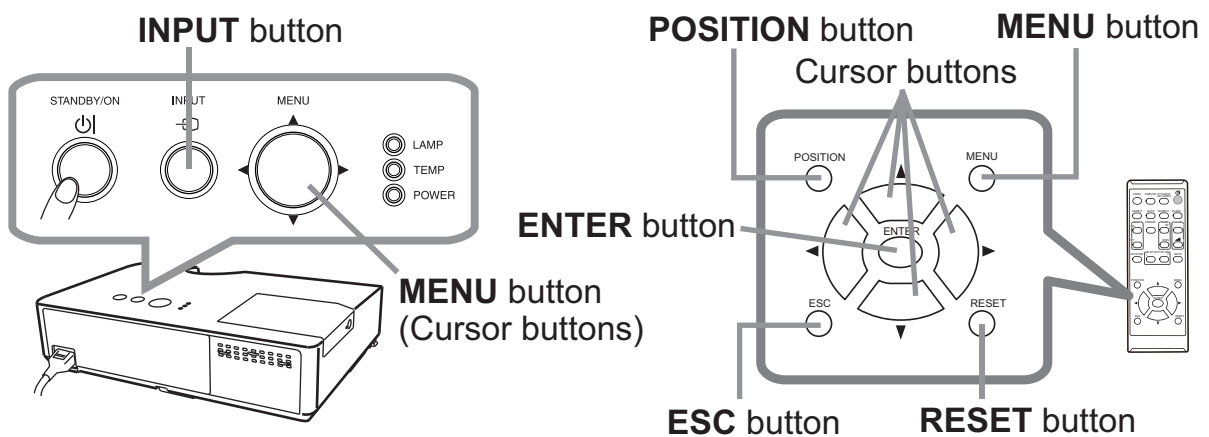

1. To start the MENU, press the **MENU** button. The MENU you last used (EASY or ADVANCED) will appear. EASY MENU has priority to appear just after powered on.

2. In the EASY MENU

- (1) Use the ▲/▼ cursor buttons to select an item to operate. If you want to change it to the ADVANCED MENU, select the ADVANCED MENU.
- (2) Use the ◀/▶ cursor buttons to operate the item.

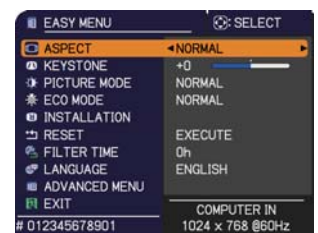

In the ADVANCED MENU

- (1) Use the ▲/▼ cursor buttons to select a menu. If you want to change it to the EASY MENU, select the EASY MENU. The items in the menu appear on the right side.
- (2) Press the ▶ cursor button or **ENTER** button to move the cursor to the right side. Then use the ▲/▼ cursor buttons to select an item to operate and press the ▶ cursor button or **ENTER** button to progress. The operation menu or dialog of the selected item will appear.
- (3) Use the buttons as instructed in the OSD to operate the item.



(continued on next page)

Using the menu function (continued)

3. To close the MENU, press the **MENU** button again or select EXIT and press the ◀ cursor button or **ENTER** button. Even if you do not do anything, the dialog will automatically disappear after about 30 seconds.
 - If you want to move the menu position, use the cursor buttons after pressing the **POSITION** button.
 - Some functions cannot be performed when a certain input port is selected, or when a certain input signal is displayed.
 - When you want to reset the operation, press **RESET** button on the remote control during the operation. Note that some items (ex. LANGUAGE, VOLUME) cannot be reset.
 - In the ADVANCED MENU, when you want to return to the previous display, press the ◀ cursor button or **ESC** button on the remote control.

Indication in OSD (On Screen Display)

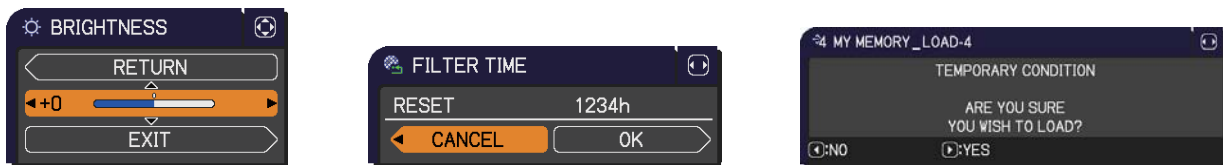

The meanings of the general words on the OSD are as follows.

| Indication | Meaning |
|--------------|---|
| EXIT | Selecting this word finishes the OSD menu. It's the same as pressing the MENU button. |
| RETURN | Selecting this word returns the menu to the previous menu. |
| CANCEL or NO | Selecting this word cancels the operation in the present menu and returns to the previous menu. |
| OK or YES | Selecting this word executes the prepared function or shifts the menu to the next menu. |

EASY MENU

From the EASY MENU, items shown in the table below can be performed.

Select an item using the ▲/▼ cursor buttons. Then perform it according to the following table.



| Item | Description | | | | | | | | | | | | | | | | | | | | | | | | |
|---------------------|---|---------------|-------|------------|--------|-----------|-------|--------|-----------|-------|---------|-----------|--------|--------------|-----------|---------------|--------------|-----------|---------------|------------|-----------|-------|---------|-----------|---------------|
| ASPECT | Using the ◀/▶ buttons switches the mode for aspect ratio. See the ASPECT item in IMAGE menu (📖32). | | | | | | | | | | | | | | | | | | | | | | | | |
| KEYSTONE | Using the ◀/▶ buttons corrects the vertical keystone distortion. See the KEYSTONE item in SETUP menu (📖38). | | | | | | | | | | | | | | | | | | | | | | | | |
| PICTURE MODE | <p>Using the ◀/▶ buttons switches the picture mode. The picture modes are combinations of GAMMA and COLOR TEMP settings. Choose a suitable mode according to the projected source.</p> <p> ↪ NORMAL ↔ CINEMA ↔ DYNAMIC ↔ BOARD(BLACK) ↩ ↪ DAYTIME ↔ WHITEBOARD ↔ BOARD(GREEN) ↩ </p> <table border="1"> <thead> <tr> <th></th> <th>GAMMA</th> <th>COLOR TEMP</th> </tr> </thead> <tbody> <tr> <td>NORMAL</td> <td>1 DEFAULT</td> <td>2 MID</td> </tr> <tr> <td>CINEMA</td> <td>2 DEFAULT</td> <td>3 LOW</td> </tr> <tr> <td>DYNAMIC</td> <td>3 DEFAULT</td> <td>1 HIGH</td> </tr> <tr> <td>BOARD(BLACK)</td> <td>4 DEFAULT</td> <td>4 Hi-BRIGHT-1</td> </tr> <tr> <td>BOARD(GREEN)</td> <td>4 DEFAULT</td> <td>5 Hi-BRIGHT-2</td> </tr> <tr> <td>WHITEBOARD</td> <td>5 DEFAULT</td> <td>2 MID</td> </tr> <tr> <td>DAYTIME</td> <td>6 DEFAULT</td> <td>6 Hi-BRIGHT-3</td> </tr> </tbody> </table> <ul style="list-style-type: none"> • When the combination of GAMMA and COLOR TEMP differs from pre-assigned modes above, the display on the menu for the PICTURE MODE is "CUSTOM". Please refer to the GAMMA and COLOR TEMP (📖29, 30) items in PICTURE menu. • Lines or other noise might appear on the screen when this function is operated, but it is not a malfunction. | | GAMMA | COLOR TEMP | NORMAL | 1 DEFAULT | 2 MID | CINEMA | 2 DEFAULT | 3 LOW | DYNAMIC | 3 DEFAULT | 1 HIGH | BOARD(BLACK) | 4 DEFAULT | 4 Hi-BRIGHT-1 | BOARD(GREEN) | 4 DEFAULT | 5 Hi-BRIGHT-2 | WHITEBOARD | 5 DEFAULT | 2 MID | DAYTIME | 6 DEFAULT | 6 Hi-BRIGHT-3 |
| | GAMMA | COLOR TEMP | | | | | | | | | | | | | | | | | | | | | | | |
| NORMAL | 1 DEFAULT | 2 MID | | | | | | | | | | | | | | | | | | | | | | | |
| CINEMA | 2 DEFAULT | 3 LOW | | | | | | | | | | | | | | | | | | | | | | | |
| DYNAMIC | 3 DEFAULT | 1 HIGH | | | | | | | | | | | | | | | | | | | | | | | |
| BOARD(BLACK) | 4 DEFAULT | 4 Hi-BRIGHT-1 | | | | | | | | | | | | | | | | | | | | | | | |
| BOARD(GREEN) | 4 DEFAULT | 5 Hi-BRIGHT-2 | | | | | | | | | | | | | | | | | | | | | | | |
| WHITEBOARD | 5 DEFAULT | 2 MID | | | | | | | | | | | | | | | | | | | | | | | |
| DAYTIME | 6 DEFAULT | 6 Hi-BRIGHT-3 | | | | | | | | | | | | | | | | | | | | | | | |

(continued on next page)

EASY MENU

| Item | Description |
|----------------------|---|
| ECO MODE | Using the ◀/▶ buttons switches ECO MODE. See the ECO MODE item in SETUP menu (📖38). |
| INSTALLATION | Pressing the ▶ button displays the INSTALLATION dialog. See the INSTALLATION item in SETUP menu (📖38). |
| RESET | Performing this item resets all of the EASY MENU items except the FILTER TIME and LANGUAGE. A dialog is displayed for confirmation. Selecting the OK using the ▶ button performs resetting. |
| FILTER TIME | The usage time of the air filter is shown in the menu. Performing this item resets the filter time which counts usage time of the air filter. A dialog is displayed for confirmation. Selecting the OK using the ▶ button performs resetting. See the FILTER TIME item in OPTION menu (📖46). |
| LANGUAGE | Using the ◀/▶ buttons changes the display language. See the LANGUAGE item in SCREEN menu (📖39). |
| ADVANCED MENU | Press the ▶ or ENTER button to use the menu of PICTURE, IMAGE, INPUT, SETUP, SCREEN, OPTION or SECURITY. |
| EXIT | Press the ◀ or ENTER button to finish the OSD menu. |

PICTURE menu



From the PICTURE menu, items shown in the table below can be performed.

Select an item using the ▲/▼ cursor buttons, and press the ► cursor button or **ENTER** button to execute the item. Then perform it according to the following table.



| Item | Description |
|-------------------|--|
| BRIGHTNESS | Using the ◀/▶ buttons adjusts the brightness. Dark ⇔ Light |
| CONTRAST | Using the ◀/▶ buttons adjusts the contrast. Weak ⇔ Strong |
| GAMMA | <p>Using the ▲/▼ buttons switches the gamma mode.</p> <p>1 DEFAULT ⇔ 1 CUSTOM ⇔ 2 DEFAULT ⇔ 2 CUSTOM ⇔ 3 DEFAULT ⇔ 3 CUSTOM ⇔ 6 CUSTOM ⇔ 6 DEFAULT ⇔ 5 CUSTOM ⇔ 5 DEFAULT ⇔ 4 CUSTOM ⇔ 4 DEFAULT</p> <p>To adjust CUSTOM</p> <p>Selecting a mode whose name includes CUSTOM and then pressing the ► button or the ENTER button displays a dialog to aid you in adjusting the mode. This function is useful when you want to change the brightness of particular tones.</p> <p>Choose an item using the ◀/▶ buttons, and adjust the level using the ▲/▼ buttons.</p> <p>You can display a test pattern for checking the effect of your adjustment by pressing the ENTER button. Each time you press the ENTER button, the pattern changes as below.</p> <p>No pattern ⇔ Gray scale of 9 steps ⇔ Ramp ⇔ Gray scale of 15 steps</p> <p>The eight equalizing bars correspond to eight tone levels of the test pattern (Gray scale of 9 steps) except the darkest in the left end. If you want to adjust the 2nd tone from left end on the test pattern, use the equalizing adjustment bar "1". The darkest tone at the left end of the test pattern cannot be controlled with any of equalizing adjustment bar.</p> <ul style="list-style-type: none"> • Lines or other noise might appear on the screen when this function is operated, but it is not a malfunction. |

(continued on next page)

| Item | Description |
|--------------------------|--|
| <p>COLOR TEMP</p> | <p>Using the ▲/▼ buttons switches the color temperature mode.</p> <p style="text-align: center;"> 1 HIGH ⇔ 1 CUSTOM ⇔ 2 MID ⇔ 2 CUSTOM ⇕ 6 CUSTOM ⇕ 6 Hi-BRIGHT-3 ⇕ 5 CUSTOM ⇔ 5 Hi-BRIGHT-2 ⇔ 4 CUSTOM ⇔ 4 Hi-BRIGHT-1 ⇕ 3 LOW ⇕ 3 CUSTOM ⇕ </p> <p>To adjust CUSTOM</p> <p>Selecting a mode whose name includes CUSTOM and then pressing the ► button or the ENTER button displays a dialog to aid you in adjusting the OFFSET and GAIN of the selected mode.</p>  <p>OFFSET adjustments change the color intensity on the whole tones of the test pattern.</p> <p>GAIN adjustments mainly affect color intensity on the brighter tones of the test pattern.</p> <p>Choose an item using the ◀/▶ buttons, and adjust the level using the ▲/▼ buttons.</p> <p>You can display a test pattern for checking the effect of your adjustment by pressing the ENTER button.</p> <p>Each time you press the ENTER button, the pattern changes as below.</p> <p>No pattern ⇔ Gray scale of 9 steps ⇔ Ramp ⇔ Gray scale of 15 steps</p> <ul style="list-style-type: none"> • Lines or other noise might appear on the screen when this function is operated, but it is not a malfunction.  |
| <p>COLOR</p> | <p>Using the ◀/▶ buttons adjusts the strength of whole color.</p> <p style="text-align: center;">Weak ⇔ Strong</p> <ul style="list-style-type: none"> • This item can be selected only for a video and component video signal. |
| <p>TINT</p> | <p>Using the ◀/▶ buttons adjusts the tint.</p> <p style="text-align: center;">Reddish ⇔ Greenish</p> <ul style="list-style-type: none"> • This item can be selected only for a video and component video signal. |

(continued on next page)

| Item | Description |
|------------------|--|
| SHARPNESS | <p>Using the ◀/▶ buttons adjusts the sharpness. Weak ⇔ Strong</p> <ul style="list-style-type: none"> • There may be some noise and/or the screen may flicker for a moment when an adjustment is made. This is not a malfunction. |
| MY MEMORY | <p>This projector has 4 memories for adjustment data (for all the items of the PICTURE menu). Selecting a function using the ▲/▼ buttons and pressing the ▶ or ENTER button performs each function.</p> <p>↪ SAVE-1 ⇔ SAVE-2 ⇔ SAVE-3 ⇔ SAVE-4 ↩ ↩ LOAD-4 ⇔ LOAD-3 ⇔ LOAD-2 ⇔ LOAD-1 ↪</p> <p><u>SAVE-1, SAVE-2, SAVE-3, SAVE-4</u> Performing a SAVE function saves the current adjustment data into the memory linked in the number included in the function's name.</p> <ul style="list-style-type: none"> • Remember that the current data being stored of a memory will be lost by saving new data into the memory. <p><u>LOAD-1, LOAD-2, LOAD-3, LOAD-4</u> Performing a LOAD function loads the data from the memory linked in the number included in the function's name, and adjusts the picture automatically depending on the data.</p> <ul style="list-style-type: none"> • The LOAD functions whose linked memory has no data are skipped. • Remember that the current adjusted condition will be lost by loading data. If you want to keep the current adjustment, please save it before performing a LOAD function. • There may be some noise and the screen may flicker for a moment when loading data. This is not malfunction. • You can perform the LOAD function using MY BUTTON. Please see MY BUTTON item in OPTION menu (📖47). |

IMAGE menu

From the IMAGE menu, items shown in the table below can be performed.

Select an item using the ▲/▼ cursor buttons, and press the ► cursor button or **ENTER** button to execute the item. Then perform it according to the following table.

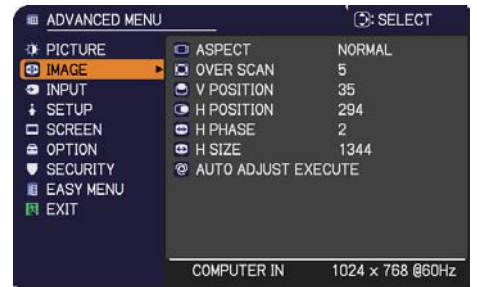

| Item | Description |
|-------------------------|---|
| <p>ASPECT</p> | <p>Using the ▲/▼ buttons switches the mode for aspect ratio.</p> <p>For a computer signal NORMAL ⇔ 4:3 ⇔ 16:9 ⇔ 16:10 ↑—————↑</p> <p>For a video signal or component video signal 4:3 ⇔ 16:9 ⇔ 14:9 ↑—————↑</p> <p>For no signal 4:3 (fixed)</p> <ul style="list-style-type: none"> • The NORMAL mode keeps the original aspect ratio of the signal. |
| <p>OVER SCAN</p> | <p>Using the ◀/▶ buttons adjusts the over-scan ratio. Small (It magnifies picture) ⇔ Large (It reduces picture)</p> <ul style="list-style-type: none"> • This item can be selected only for a video and component video signal. |

(continued on next page)

| Item | Description |
|-------------------|---|
| V POSITION | <p>Using the ◀/▶ buttons adjusts the vertical position. Down ⇔ Up</p> <ul style="list-style-type: none"> • Over-adjusting the vertical position may cause noise to appear on the screen. If this occurs, please reset the vertical position to the default setting. Pressing the RESET button when the V POSITION is selected will reset the V POSITION to the default setting. • When this function is performed on a video signal or component video signal, the range of this adjustment depends on the OVER SCAN (📖32) setting. It is not possible to adjust when OVER SCAN is set to 10. |
| H POSITION | <p>Using the ◀/▶ buttons adjusts the horizontal position. Right ⇔ Left</p> <ul style="list-style-type: none"> • Over-adjusting the horizontal position may cause noise to appear on the screen. If this occurs, please reset the horizontal position to the default setting. Pressing the RESET button when the H POSITION is selected will reset the H POSITION to the default setting. • When this function is performed on a video signal or component video signal, the range of this adjustment depends on the OVER SCAN (📖32) setting. It is not possible to adjust when OVER SCAN is set to 10. |

(continued on next page)

| Item | Description |
|-----------------------------------|---|
| <p>H PHASE</p> | <p>Using the ◀/▶ buttons adjusts the horizontal phase to eliminate flicker. Right ⇔ Left</p> <ul style="list-style-type: none"> • This item can be selected only for a computer signal or a component video signal. |
| <p>H SIZE</p> | <p>Using the ◀/▶ buttons adjusts the horizontal size. Small ⇔ Large</p> <ul style="list-style-type: none"> • This item can be selected only for a computer signal. • When this adjustment is excessive, the picture may not be displayed correctly. In such a case, please reset the adjustment by pressing the RESET button on the remote control during this operation. • Images might appear degraded when this function is operated, but it is not a malfunction. |
| <p>AUTO ADJUST EXECUTE</p> | <p>Selecting this item performs the automatic adjustment feature.</p> <p>For a computer signal The vertical position, the horizontal position and the horizontal phase will be automatically adjusted. Make sure that the application window is set to its maximum size prior to attempting to use this feature. A dark picture may still be incorrectly adjusted. Use a bright picture when adjusting.</p> <p>For a video signal The video format best suited for the respective input signal will be selected automatically. This function is available only when the AUTO is selected for the VIDEO FORMAT item in the INPUT menu (📖36). The vertical position and horizontal position will be automatically set to the default.</p> <p>For a component video signal The vertical position and horizontal position will be automatically set to the default. The horizontal phase will be automatically adjusted.</p> <ul style="list-style-type: none"> • The automatic adjustment operation requires approx. 10 seconds. Also please note that it may not function correctly with some input. • When this function is performed for a video signal, a certain extra such as a line may appear outside a picture. • When this function is performed for a computer signal, a black frame may be displayed on the edge of the screen, depending on the computer model. • The items adjusted by this function may vary when the FINE or DISABLE is selected for the AUTO ADJUST item of the SERVICE item in the OPTION menu (📖48). |

INPUT menu

From the INPUT menu, items shown in the table below can be performed.

Select an item using the ▲/▼ cursor buttons, and press the ► cursor button or **ENTER** button to execute the item. Then perform it according to the following table.

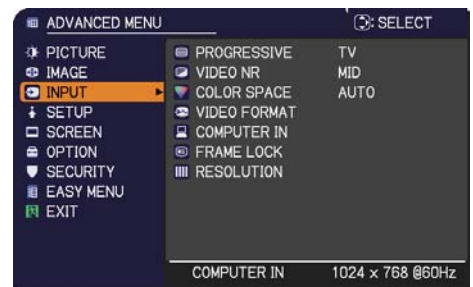



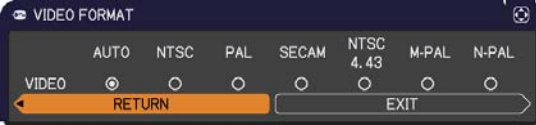
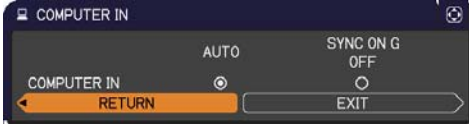
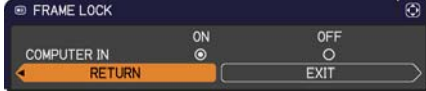

| Item | Description |
|--------------------|---|
| PROGRESSIVE | <p>Using the ▲/▼ buttons switches the progress mode. TV ⇄ FILM ⇄ OFF ↑—————↑</p> <ul style="list-style-type: none"> • This function works only for video signal and component video signal (of 480i@60 or 576i@50 or 1080i@50/60). • When TV or FILM is selected, the screen image will be sharp. FILM adapts to the 2-3 Pull-Down conversion system. But these may cause a certain defect (for example, jagged line) of the picture for a quick moving object. In such a case, please select OFF, even though the screen image may lose sharpness. |
| VIDEO NR | <p>Using the ▲/▼ buttons switches the noise reduction mode. HIGH ⇄ MID ⇄ LOW ↑—————↑</p> <ul style="list-style-type: none"> • This function works only for video signal and component video signal (of 480i@60 or 576i@50 or 1080i@50/60). |
| COLOR SPACE | <p>Using the ▲/▼ buttons switches the mode for color space. AUTO ⇄ RGB ⇄ SMPTE240 ⇄ REC709 ⇄ REC601 ↑—————↑</p> <ul style="list-style-type: none"> • This item can be selected only for a computer signal or a component video signal. • The AUTO mode automatically selects the optimum mode. • The AUTO operation may not work well at some signals. In such a case, it might be good to select a suitable mode except AUTO. |

(continued on next page)

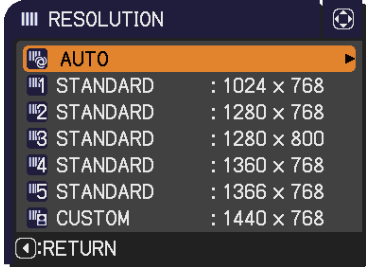
| Item | Description |
|----------------------------|--|
| <p>VIDEO FORMAT</p> | <p>The video format for VIDEO port can be set. Using the ◀/▶ buttons switches the mode for video format.</p>  <p>AUTO ⇔ NTSC ⇔ PAL ⇔ SECAM ⇕ N-PAL ⇔ M-PAL ⇔ NTSC4.43 ⇕</p> <ul style="list-style-type: none"> • This item is performed only for video signal from the VIDEO port. • The AUTO mode automatically selects the optimum mode. • The AUTO operation may not work well for some signals. If the picture becomes unstable (e.g. an irregular picture, lack of color), please select the mode according to the input signal. |
| <p>COMPUTER IN</p> | <p>The computer input signal type for COMPUTER IN port can be set. Use the ◀/▶ buttons to select the computer input signal type.</p>  <p>AUTO ⇔ SYNC ON G OFF</p> <ul style="list-style-type: none"> • Selecting the AUTO mode allows you to input a sync on G signal or component video signal from the port (11, 12). • In the AUTO mode, the picture may be distorted with certain input signals. In such a case, remove the signal connector so that no signal is received and select the SYNC ON G OFF, and then reconnect the signal. |
| <p>FRAME LOCK</p> | <p>Set the frame lock function on/off for the COMPUTER IN port. Use the ◀/▶ buttons to turn the frame lock function on/off .</p>  <p>ON ⇔ OFF</p> <ul style="list-style-type: none"> • This item can be performed only on a signal with a vertical frequency of 49 to 51Hz, 59 to 61 Hz. • When ON is selected, moving pictures are displayed more smoothly. |

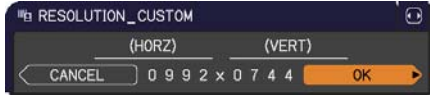
(continued on next page)

| Item | Description |
|--------------------------|--|
| <p>RESOLUTION</p> | <p>The resolution for the COMPUTER IN input signal can be set on this projector.</p> <p>(1) In the INPUT menu select the RESOLUTION using the ▲/▼ buttons and press the ► button. The RESOLUTION menu will be displayed.</p>  <p>(2) In the RESOLUTION menu select the resolution you wish to display using the ▲/▼ buttons. Selecting AUTO will set a resolution appropriate to the input signal.</p> <p>(3) Pressing the ► or ENTER button when selecting a STANDARD resolution will automatically adjust the horizontal and vertical positions, clock phase and horizontal size. The INPUT_INFORMATION dialog will be displayed.</p>  <p>(4) To set a custom resolution use the ▲/▼ buttons to select the CUSTOM and the RESOLUTION_CUSTOM box will be displayed. Set the horizontal (HORZ) and vertical (VERT) resolutions using the ▲/▼/◀/▶ buttons. This function may not support all resolutions.</p>  <p>(5) Move the cursor to OK on screen and press the ► or ENTER button. The message "ARE YOU SURE YOU WISH TO CHANGE RESOLUTION?" appears. To save the setting, press the ► button. The horizontal and vertical positions, clock phase and horizontal size will be automatically adjusted. The INPUT_INFORMATION dialog will be displayed.</p>  <p>(6) To revert back to the previous resolution without saving changes, move the cursor to CANCEL on screen and press the ◀ or ENTER button. The screen will then return to the RESOLUTION menu displaying the previous resolution.</p> <ul style="list-style-type: none"> • For some pictures, this function may not work well. |

SETUP menu

From the SETUP menu, items shown in the table below can be performed.

Select an item using the ▲/▼ cursor buttons, and press the ► cursor button or **ENTER** button to execute the item. Then perform it according to the following table.

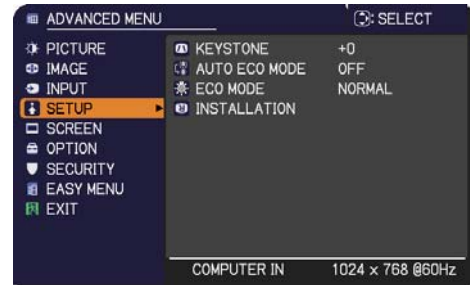

| Item | Description |
|----------------------|--|
| KEYSTONE | <p>Using the ◀/▶ buttons corrects the vertical keystone distortion.</p> <p>Shrink the bottom of the image ⇔ Shrink the top of the image</p> <ul style="list-style-type: none"> The adjustable range of this function will vary among inputs. For some input, this function may not work well. |
| AUTO ECO MODE | <p>Using the ▲/▼ buttons turns on/off the AUTO ECO MODE.</p> <p>ON ⇔ OFF</p> <ul style="list-style-type: none"> When ON is selected, the projector will always be set to Eco mode at start-up regardless of the ECO MODE (📖below) setting. An OSD message “AUTO ECO MODE” will be displayed for a while when the projector starts with this function activated. |
| ECO MODE | <p>Using the ◀/▶ buttons switches ECO MODE.</p> <p>ECO ⇔ NORMAL</p> <ul style="list-style-type: none"> When the ECO is selected, acoustic noise and screen brightness are reduced. When AUTO ECO MODE (📖above) is set to ON, the projector will always be set to Eco mode at start-up regardless this setting. |
| INSTALLATION | <p>Pressing the ► button displays the dialog for changing the INSTALLATION setting.</p> <div data-bbox="612 1429 1273 1899" data-label="Image"> </div> <p>Use the ▲/▼ buttons to select the desired setting on the INSTALLATION dialog, and press the ENTER button of the remote control or the INPUT button of the projector to execute.</p> |

SCREEN menu

From the SCREEN menu, items shown in the table below can be performed.

Select an item using the ▲/▼ cursor buttons, and press the ► cursor button or **ENTER** button to execute the item. Then perform it according to the following table.

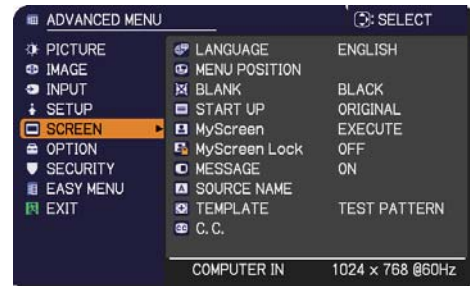

| Item | Description |
|----------------------|---|
| LANGUAGE | <p>Using the ▲/▼/◀/▶ buttons switches the OSD (On Screen Display) language.</p> <p>ENGLISH ⇄ FRANÇAIS ⇄ DEUTSCH ⇄ ESPAÑOL ⤴ (shown in the LANGUAGE dialog) ⤵</p> <p>Press the ENTER or INPUT button to save the language setting.</p> |
| MENU POSITION | <p>Using the ▲/▼/◀/▶ buttons adjusts the menu position. To quit the operation, press the MENU button on the remote control or keep no operation for about 10 seconds.</p> |
| BLANK | <p>Using the ▲/▼ buttons switches the mode for the blank screen. The blank screen is a screen for the temporarily blanking feature (📖24). It is displayed by pressing the BLANK button on the remote control.</p> <p>MyScreen ⇄ ORIGINAL ⇄ BLUE ⇄ WHITE ⇄ BLACK ⤴—————⤵</p> <p><u>MyScreen</u> : Screen can be registered by the MyScreen item (📖40). <u>ORIGINAL</u> : Screen preset as the standard screen. <u>BLUE, WHITE, BLACK</u> : Plain screens in each color.</p> <ul style="list-style-type: none"> • To avoid remaining as an afterimage, the MyScreen or ORIGINAL screen will change to the plain black screen after several minutes. |
| START UP | <p>Using the ▲/▼ buttons switches the mode for the start-up screen. The start-up screen is a screen displayed when no signal or an unsuitable signal is detected.</p> <p>MyScreen ⇄ ORIGINAL ⇄ OFF ⤴—————⤵</p> <p><u>MyScreen</u> : Screen can be registered by the MyScreen item (📖40). <u>ORIGINAL</u> : Screen preset as the standard screen. <u>OFF</u> : Plain black screen.</p> <ul style="list-style-type: none"> • To avoid remaining as an afterimage, the MyScreen or ORIGINAL screen will change to the BLANK screen (📖above) after several minutes. If also the BLANK screen is the MyScreen or ORIGINAL, the plain black screen is instead used. • When the ON is selected to the MyScreen PASSWORD item in the SECURITY menu (📖52), the START UP is fixed to MyScreen. |

(continued on next page)

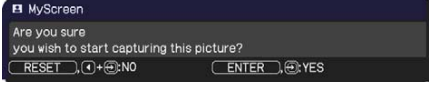
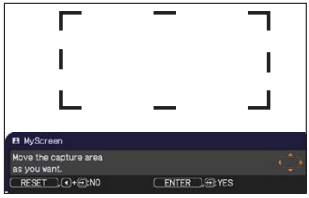
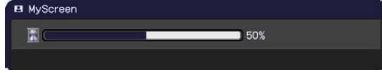
| Item | Description |
|------------------------|---|
| <p>MyScreen</p> | <p>This item allows you to capture an image for use as a MyScreen image which can be used as the BLANK screen and START UP screen. Display the image you want to capture before executing the following procedure.</p> <ol style="list-style-type: none"> <p>Selecting this item displays a dialog titled “MyScreen”. It will ask you if you start capturing an image from the current screen.</p>  <p>Please wait for the target image to be displayed, and press the ENTER or INPUT button when the image is displayed. The image will freeze and the frame for capturing will appear.</p> <p>To stop performing, press the RESET button on the remote control.</p> <p>Using the ▲/▼/◀/▶ buttons adjusts the frame position.</p>  <p>Please move the frame to the position of the image which you want to use. The frame may not be able to be moved for some input signals.</p>  <p>To start registration, press the ENTER or INPUT button on the remote control.</p> <p>To restore the screen and return to the previous dialog, press the RESET button on the remote control.</p> <p>Registration may take several minutes.</p> <p>When the registration is completed, the registered screen and the following message is displayed for several seconds:</p> <p>“MyScreen registration is finished.”</p> <p>If the registration failed, the following message is displayed:</p> <p>“A capturing error has occurred. Please try again.”</p> <ul style="list-style-type: none"> • This function cannot be selected when the ON is selected to the MyScreen Lock item (📖41). • This function cannot be selected when the ON is selected to the MyScreen PASSWORD item in SECURITY menu (📖52). |

(continued on next page)

| Item | Description |
|----------------------|---|
| MyScreen Lock | <p>Using the ▲/▼ buttons turns on/off the MyScreen lock function. ON ⇔ OFF</p> <p>When the ON is selected, the item MyScreen is locked. Use this function for protecting the current MyScreen.</p> <ul style="list-style-type: none"> • This function cannot be selected when the ON is selected to the MyScreen PASSWORD item in SECURITY menu (📖52). |
| MESSAGE | <p>Using the ▲/▼ buttons turns on/off the message function. ON ⇔ OFF</p> <p>When the ON is selected, the following message function works.</p> <p>“AUTO IN PROGRESS” while automatically adjusting “NO INPUT IS DETECTED” “SYNC IS OUT OF RANGE” “INVALID SCAN FREQ.” “Searching....” while searching for the input “Detecting....” while an input signal is detected “AUTO ECO MODE” while starting up with AUTO ECO MODE</p> <p>The indication of the input signal displayed by changing The indication of the aspect ratio displayed by changing The indication of the PICTURE MODE displayed by changing The indication of the MY MEMORY displayed by changing The indication of “FREEZE” and “II” while freezing the screen by pressing the FREEZE button. The indication of the TEMPLATE displayed by changing. The indication of the ECO MODE displayed by changing.</p> <ul style="list-style-type: none"> • When the OFF is selected, please remember if the picture is frozen. Do not mistake freezing for a malfunction (📖24). |

(continued on next page)

| Item | Description |
|---------------------------|---|
| <p>SOURCE NAME</p> | <p>Each input port for this projector can have a name applied to it.</p> <p>(1) Use the ▲/▼ buttons on the SCREEN menu to select SOURCE NAME and press the ► or ENTER button. The SOURCE NAME menu will be displayed.</p> <p>(2) Use the ▲/▼ buttons on the SOURCE NAME menu to select the port to be named and press the ► button. The SOURCE NAME dialog will be displayed. Right side of the menu is blank until a name is specified.</p> <p>(3) Select an icon you would like to assign to the port in the SOURCE NAME dialog. The name assigned to the port will also be automatically switched according to your icon selection. Press the ENTER or INPUT button to determine your icon selection.</p> <p>(4) Select a number you would like to assign to the port along with the icon. You can select the number either from blank (no number assigned), 1, 2, 3, or 4. Then press the ENTER or INPUT button.</p> <p>(5) If you would like to modify the name assigned to the port, select CUSTOM NAME and press the ENTER or INPUT button.</p> <p>(continued on next page)</p> |

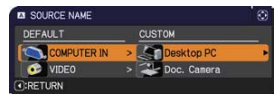
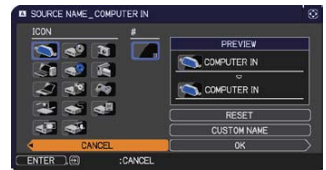
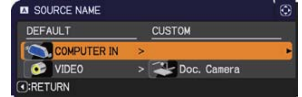

(continued on next page)

| Item | Description |
|---|---|
| <p>SOURCE NAME (continued)</p> | <p>(6) The current name will be displayed on the first line. Use the ▲/▼/◀/▶ buttons and the ENTER or INPUT button to select and enter characters. To erase 1 character at one time, press the RESET button or press the ◀ and INPUT button at the same time. Also if you move the cursor to DELETE or ALL CLEAR on screen and press the ENTER or INPUT button, 1 character or all characters will be erased. The name can be a maximum of 16 characters.</p> <p>(7) To change an already inserted character, press the ▲ button to move the cursor to the first line, and use the ◀/▶ buttons to move the cursor on the character to be changed.</p> <p>After pressing the ENTER or INPUT button, the character is selected. Then, follow the same procedure as described at the item (6) above.</p> <p>(8) To finish entering text, move the cursor to the OK on screen and press the ▶, ENTER or INPUT button. To revert to the previous name without saving changes, move the cursor to the CANCEL on screen and press the ◀, ENTER or INPUT button.</p>  <p>The three screenshots show the 'SOURCE NAME' screen with 'COMPUTER IN 1' and 'desktop PC' entered. The first shows the cursor on 'P'. The second shows the cursor on 'C'. The third shows the cursor on 'P' after a character change.</p> |
| <p>TEMPLATE</p> | <p>Using the ▲/▼ cursor buttons switches the mode for the template screen.</p> <p>Press the ▶ cursor (or the ENTER) button to display the selected template, and press the ◀ cursor button to close the displayed screen.</p> <p>The last selected template is displayed when the MY BUTTON allocated to the TEMPLATE function is pressed (📖47).</p> <p style="text-align: center;"> TEST PATTERN ⇔ DOT-LINE1 ⇔ DOT-LINE2 ⇔ DOT-LINE3 ⇕ ⇕ MAP2 ⇔ MAP1 ⇔ CIRCLE2 ⇔ CIRCLE1 ⇔ DOT-LINE4 </p> <p>You can turn a map upside down and scroll it horizontally when MAP1 or MAP2 is selected. To invert or scroll the map, display the guidance by pressing the RESET button on the remote three seconds or more when MAP1 or MAP2 appears.</p> |

(continued on next page)

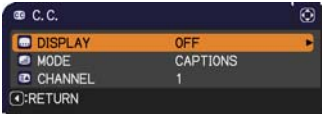

| Item | Description |
|---|---|
| <p align="center">C.C. (Closed Caption)</p> | <p>The C.C. is the function that displays a transcript or dialog of the audio portion of a video, files or other presentation or other relevant sounds. It is required to have NTSC format video or 480i@60 format component video source supporting C.C. feature to utilize this function.</p> <p>It may not work properly, depending on equipment or signal source. In this case, please turn off the Closed Caption.</p>  |
| | <p>DISPLAY</p> <p>Select Closed Caption DISPLAY setting from following options using ▲/▼ buttons.</p> <p>ON ⇔ OFF</p> <p><u>ON</u> : Closed Caption is on.</p> <p><u>OFF</u> : Closed Caption is off.</p> <ul style="list-style-type: none"> • The caption is not displayed when the OSD menu is active. • The Closed Caption is the function to display the dialogue, narration, and / or sound effects of a television program or other video sources. The Closed Caption availability is depending upon broadcaster and/or content. |
| | <p>MODE</p> <p>Select Closed Caption MODE setting from following options using ▲/▼ buttons.</p> <p>CAPTIONS ⇔ TEXT</p> <p><u>CAPTIONS</u> : Display Closed Caption.</p> <p><u>TEXT</u> : Display Text data, which is for additional information such as news reports or a TV program guide. The information covers the entire screen. Not all of the C.C. program has Text information.</p> |
| | <p>CHANNEL</p> <p>Select Closed Caption CHANNEL from following options using ▲/▼ buttons.</p> <p>1 ⇔ 2 ⇔ 3 ⇔ 4</p> <p>↑—————↑</p> <p><u>1</u>: Channel 1, primary channel / language</p> <p><u>2</u>: Channel 2</p> <p><u>3</u>: Channel 3</p> <p><u>4</u>: Channel 4</p> <p>The channel data may vary, depending on the content. Some channel might be used for secondary language or empty.</p> |

OPTION menu

From the OPTION menu, items shown in the table below can be performed.

Select an item using the ▲/▼ cursor buttons, and press the ► cursor button or **ENTER** button to execute the item, except for the items LAMP TIME and FILTER TIME. Then perform it according to the following table.



| Item | Description |
|-------------------------------|---|
| <p>AUTO SEARCH</p> | <p>Using the ▲/▼ buttons turns on/off the automatic signal search function.</p> <p>ON ⇔ OFF</p> <p>When the ON is selected, detecting no signal automatically cycles through input ports in the following order. The search is started from the current port. Then when an input is found, the projector will stop searching and display the image.</p> <p>COMPUTER IN ⇔ VIDEO</p> |
| <p>DIRECT POWER ON</p> | <p>Using the ▲/▼ buttons turns on/off the DIRECT POWER ON function.</p> <p>ON ⇔ OFF</p> <p>When set to the ON, the lamp in projector will be automatically turned on without the usual procedure (📖16), only when the projector is supplied with the power after the power was cut while the lamp was on.</p> <ul style="list-style-type: none"> • This function does not work as long as the power has been supplied to the projector while the lamp is off. • After turning the lamp on by the DIRECT POWER ON function, if neither input nor operation is detected for about 30 minutes, the projector is turned off, even though the AUTO POWER OFF function (📖45) is disabled. |
| <p>AUTO POWER OFF</p> | <p>Using the ▲/▼ buttons adjusts the time to count down to automatically turn the projector off.</p> <p>Long (max. 99 minutes) ⇔ Short (min. 0 minute = DISABLE)</p> <div style="display: flex; justify-content: space-around; align-items: center;">   </div> <p>When the time is set to 0, the projector is not turned off automatically. When the time is set to 1 to 99, and when the passed time with no-signal or an unsuitable signal reaches at the set time, the projector lamp will be turned off.</p> <p>If one of the projector's buttons or the remote control buttons is pressed during the corresponding time, projector will not be turned off.</p> <p>Please refer to the section Turning off the power (📖17).</p> |

(continued on next page)

| Item | Description |
|---------------------------|---|
| <p>LAMP TIME</p> | <p>The lamp time is the usage time of the lamp, counted after the last resetting. It is shown in the OPTION menu. Pressing the RESET button on the remote control or the ► button of the projector displays a dialog. To reset the lamp time, select the OK using the ► button. CANCEL ⇒ OK</p> <ul style="list-style-type: none"> • Please reset the lamp time only when you have replaced the lamp, for a suitable indication about the lamp. • For the lamp replacement, see the section Replacing the lamp (📖56). |
| <p>FILTER TIME</p> | <p>The filter time is the usage time of the air filter, counted after the last resetting. It is shown in the OPTION menu. Pressing the RESET button on the remote control or the ► button of the projector displays a dialog. To reset the filter time, select the OK using the ► button. CANCEL ⇒ OK</p> <ul style="list-style-type: none"> • Please reset the filter time only when you have cleaned or replaced the air filter, for a suitable indication about the air filter. • For the air filter cleaning, see the section Cleaning and replacing the air filter (📖58). |

(continued on next page)

| Item | Description |
|-------------------------|--|
| <p>MY BUTTON</p> | <p>This item assigns one of the following functions to the ECO button on the control panel (📖5) and MY BUTTON 1/2 on the remote control (📖6).</p> <p>(1) Choose a button to assign a function from ECO, MY BUTTON-1 and MY BUTTON-2. Use the ▲/▼ buttons to select the desired function on the menu and press the ► button.</p> <p>(2) Then using the ▲/▼/◀/▶ buttons sets one of the following functions to the chosen button. Press the ENTER or INPUT button to save the setting.</p> <ul style="list-style-type: none"> • COMPUTER IN: Selects the input from COMPUTER IN port. • VIDEO: Selects the input from VIDEO port. • INFORMATION: Displays SYSTEM_INFORMATION, INPUT_INFORMATION (📖50) or nothing. • MY MEMORY: Loads one of adjustment data stored (📖31). When more than one data are saved, the adjustment changes every time the MY BUTTON is pressed. When no data is saved in memory, the dialog "No saved data" appears. When the current adjustment is not saved to memory, the dialog as shown in the right appears. <p>If you want to keep the current adjustment, please press the ► button to exit. Otherwise loading a data will overwrite the current adjusted condition.</p> <ul style="list-style-type: none"> • PICTURE MODE: Changes the PICTURE MODE (📖27). • FILTER RESET: Displays the filter time reset confirmation dialogue (📖46). • TEMPLATE: Makes the template pattern selected to the TEMPLATE item (📖43) appear or disappear. • RESOLUTION: Turns on/off the RESOLUTION dialog (📖37). • ECO MODE: Changes the ECO MODE (📖38). • BLANK: Turns on/off the blank function. (ECO button only) • FREEZE: Turns on/off the freeze function. (ECO button only) • AUTO: Performs the automatic adjustment function. (ECO button only) |

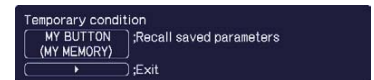
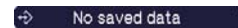

(continued on next page)

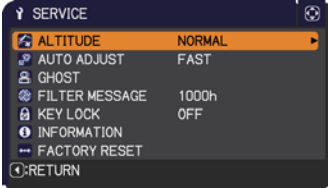
| Item | Description |
|-------------------------|---|
| <p>MY SOURCE</p> | <p>Using ▲/▼ buttons selects the picture input port to be selected with pressing the MY SOURCE/DOC.CAMERA button on the remote control.</p> <p>You can use this function not only for document cameras but also computers and other equipment.</p> <p>VIDEO ⇄ COMPUTER IN</p> |
| <p>SERVICE</p> | <p>Selecting this item displays the SERVICE menu.</p> <p>Select an item using the ▲/▼ buttons, and press the ► button or the ENTER button on the remote control to execute the item.</p>  <p>ALTITUDE</p> <p>Using the ▲/▼ buttons switches the rotation speed of the cooling fans. The HIGH is the mode for use at highlands etc. If the projector is used at an altitude of about 1600 m (5250 feet) or higher, select HIGH. Otherwise, select NORMAL. Note that the projector is noisier when the HIGH is selected.</p> <p>HIGH ⇄ NORMAL</p> <p>AUTO ADJUST</p> <p>Using the ▲/▼ buttons to select one of the mode. When the DISABLE is selected, the automatic adjustment feature is disabled.</p> <p>FINE ⇄ FAST ⇄ DISABLE</p> <p style="text-align: center;">↑—————↑</p> <p><u>FINE</u>: Finer tuning including H.SIZE adjustment. <u>FAST</u>: Faster tuning, setting H.SIZE to prearranged data for the input signal.</p> <ul style="list-style-type: none"> Depending on conditions, such as input image, signal cable to the projector, environment around the projector, etc., the automatic adjustment may not work correctly. In such a case, please choose DISABLE to disable the automatic adjustment, and make adjustment manually. |

(continued on next page)

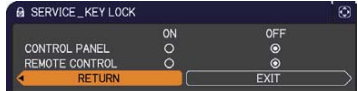
| Item | Description |
|---------------------------------------|---|
| <p>SERVICE (continued)</p> | <p>GHOST Adjust the settings using the ▲/▼ buttons to eliminate ghosting.</p> |
| | <p>FILTER MESSAGE Use the ▲/▼ button to set the timer for notifying by the message when to replace the filter unit 100h ⇔ 200h ⇔ 500h ⇔ 1000h ⇔ 2000h ⇔ 3000h ⇔ 4000h ⇔ 5000h ⇔ OFF After choosing an item except OFF, the message “REMINDER *** HRS PASSED ...” will appear after the timer reaches the interval time set by this feature (📖62). When the OFF is chosen, the message will not appear. Utilize this feature to keep the air filter clean, setting the suitable time according to your environment of this projector. • Please take care of the filter unit periodically, even if there is no message. If the air filter becomes to be blocked by dust or other matter, the internal temperature will rise, which could cause malfunction, or reduce the lifetime of the projector. • Please be careful with the operating environment of the projector and the condition of the filter unit.</p> |
| | <p>KEY LOCK (1) Use the ▲/▼ buttons to choose the operations control. CONTROL PANEL ⇔ REMOTE CONTROL (2) Use the ◀/▶ buttons to select ON or OFF. ON ⇔ OFF</p>  <p>Selecting ON in Step 2 locks the buttons except STANDBY/ON on the operations control selected in Step 1. Selecting OFF releases the locked buttons on the operations control selected in Step 1. • Please use this function to prevent tampering or accidental operation.</p> |

(continued on next page)

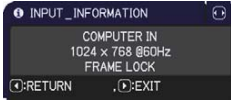
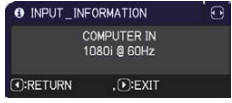
| Item | Description |
|---------------------------------------|---|
| <p>SERVICE (continued)</p> | <p>INFORMATION</p> <p>Selecting this item displays a dialog titled “INPUT_INFORMATION”. It shows the information about the current input.</p> <div style="display: flex; justify-content: space-around;">   </div> <ul style="list-style-type: none"> • The “FRAME LOCK” message on the dialog means the frame lock function is working. • This item can't be selected for no signal and sync out. • When the MY TEXT DISPLAY is set to ON, the MY TEXT is displayed together with the input information in the INPUT_INFORMATION box (📖55). |
| | <p>FACTORY RESET</p> <p>Selecting OK using the ► button performs this function. By this function, all the items in all of menus will collectively return to the initial setting. Note that the items LAMP TIME, FILTER TIME, LANGUAGE, FILTER MESSAGE and SECURITY settings are not reset.</p> <p>CANCEL ⇔ OK</p> <p>Be sure to set ALTITUDE after resetting all the settings (📖48).</p> |

SECURITY menu

This projector is equipped with security functions.

From the SECURITY menu, items shown in the table below can be performed.

To use SECURITY menu: User registration is required before using the security functions.

Enter to the SECURITY menu

1. Press the ► button. The ENTER PASSWORD box will be displayed.
2. Use the ▲/▼/◀/▶ buttons to enter the registered password.
The factory default password is as follows.

3792

This password can be changed ([below](#)). Move the cursor to the right side of the ENTER PASSWORD box and press the ► button to display the SECURITY menu.

- It is strongly recommended the factory default password to be changed as soon as possible.
 - If an incorrect password is input, the ENTER PASSWORD box will be displayed again. If incorrect password is input 3 times, the projector will turn off. Afterwards the projector will turn off every time an incorrect password is input.
3. Items shown in the table below can be performed.

If you have forgotten your password

- (1) While the ENTER PASSWORD box is displayed, press and hold the **RESET** button on the remote control for about 3 seconds or press and hold the **INPUT** button for 3 seconds while pressing the ► button on the projector.

- (2) The 10 digit Inquiring Code will be displayed. Contact your dealer with the 10 digit Inquiring Code. Your password will be sent after your user registration information is confirmed.



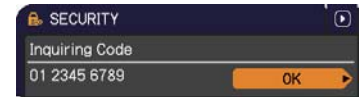
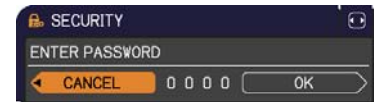

- If there is no key input for about 55 seconds while the Inquiring Code is displayed, the menu will close. If necessary, repeat the process from (1).

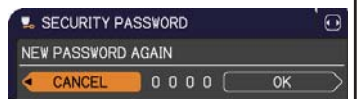



| Item | Description |
|--|--|
| <p>SECURITY PASSWORD CHANGE</p> | <ol style="list-style-type: none"> (1) Use the ▲/▼ buttons on the SECURITY menu to select SECURITY PASSWORD CHANGE and press the ► button to display the ENTER NEW PASSWORD box. (2) Use the ▲/▼/◀/▶ buttons to enter the new password. (3) Move the cursor to the right side of the ENTER NEW PASSWORD box and press the ► button to display the NEW PASSWORD AGAIN box, enter the same password again. (4) Move the cursor to the right side of the NEW PASSWORD AGAIN box and press the ► button and the NOTE NEW PASSWORD box will be displayed for about 30 seconds, please make note of the password during this time. Pressing the ENTER button on the remote control or ► button on the projector will close the NOTE NEW PASSWORD box. <ul style="list-style-type: none"> • Please do not forget your password. |

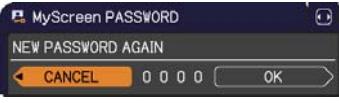



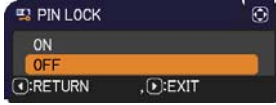

(continued on next page)

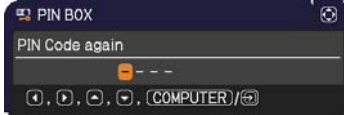
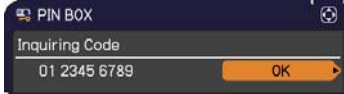
| Item | Description |
|-------------------------------------|--|
| <p>MyScreen PASSWORD</p> | <p>The MyScreen PASSWORD function can be used to prohibit access to the MyScreen function and prevent the currently registered MyScreen image from being overwritten.</p> <p>1 Turning on the MyScreen PASSWORD</p> <p>1-1 Use the ▲/▼ buttons on the SECURITY menu to select MyScreen PASSWORD and press the ► button to display the MyScreen PASSWORD on/off menu.</p>  <p>1-2 Use the ▲/▼ buttons on the MyScreen PASSWORD on/off menu to select ON. The ENTER NEW PASSWORD box (small) will be displayed.</p>  <p>1-3 Use the ▲/▼/◀/▶ buttons to enter the password. Move the cursor to the right side of the ENTER NEW PASSWORD box (small) and press the ► button to display the NEW PASSWORD AGAIN box, enter the same PASSWORD again.</p>  <p>1-4 Move the cursor to the right side of the NEW PASSWORD AGAIN box and press the ► button to display the NOTE NEW PASSWORD box for about 30 seconds, please make note of the password during this time.</p>  <p>Pressing the ENTER button on the remote control or ► button on the projector will return to MyScreen PASSWORD on/off menu.</p> <p>When a password is set for MyScreen:</p> <ul style="list-style-type: none"> • The MyScreen registration function (and menu) will be unavailable. • The MyScreen Lock menu will be unavailable. • The START UP setting will be locked on MyScreen (and the menu will be unavailable). <p>Turning the MyScreen PASSWORD off will allow normal operation of these functions.</p> <ul style="list-style-type: none"> • Please do not forget your MyScreen PASSWORD. <p>2 Turning off the MyScreen PASSWORD</p> <p>2-1 Follow the procedure in 1-1 to display the MyScreen PASSWORD on/off menu.</p> <p>2-2 Select OFF to display the ENTER PASSWORD box (large). Enter the registered password and the screen will return to the MyScreen PASSWORD on/off menu.</p>  <p>If an incorrect PASSWORD is input, the menu will close. If necessary, repeat the process from 2-1.</p> <p>3 If you have forgotten your password</p> <p>3-1 Follow the procedure in 1-1 to display the MyScreen PASSWORD on/off menu.</p> <p>3-2 Select OFF to display the ENTER PASSWORD box (large). The 10 digit Inquiring Code will be displayed inside the box.</p> <p>3-3 Contact your dealer with the 10 digit Inquiring Code. Your password will be sent after your user registration information is confirmed.</p> |





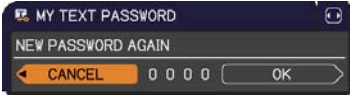

(continued on next page)

| Item | Description |
|------------------------|---|
| <p>PIN LOCK</p> | <p>PIN LOCK is a function which prevents the projector from being used unless a registered Code is input.</p> <p>1 Turning on the PIN LOCK</p> <p>1-1 Use the ▲/▼ buttons on the SECURITY menu to select PIN LOCK and press the ► button or the ENTER button to display the PIN LOCK on/off menu.</p>  <p>1-2 Use the ▲/▼ buttons on the PIN LOCK on/off menu to select ON and the Enter PIN Code box will be displayed.</p>  <p>1-3 Input a 4 part PIN code using the ▲/▼/◀/▶, COMPUTER or INPUT button. The PIN Code again box will appear. Reenter the same PIN code. This will complete the PIN code registration.</p>  <ul style="list-style-type: none"> • If there is no key input for about 55 seconds while the Enter PIN Code box or the PIN Code again box is displayed, the menu will close. If necessary, repeat the process from 1-1. <p>Afterwards, anytime the projector is restarted after AC power is turned off the Enter PIN Code box will be displayed. Enter the registered PIN code. The projector can be used after entering the registered PIN code. If an incorrect PIN code is input, the Enter PIN code box will be displayed again. If an incorrect PIN code is input 3 times, the projector will turn off. Afterwards the projector will turn off every time an incorrect PIN code is input. The projector will also turn off if there is no key input for about 5 minutes while the Enter PIN code box is displayed. This function will activate only when the projector is started after AC power is turned off.</p> <ul style="list-style-type: none"> • Please do not forget your PIN code. <p>2 Turning off the PIN LOCK</p> <p>2-1 Follow the procedure in 1-1 to display the PIN LOCK on/off menu.</p> <p>2-2 Use the ▲/▼ buttons to select OFF and the Enter PIN Code box will be displayed. Enter the registered PIN code to turn the PIN LOCK function off. If an incorrect PIN code is input 3 times, the projector will turn off.</p> <p>3 If you have forgotten your PIN code</p> <p>3-1 While the Enter PIN code box is displayed, press and hold the RESET button for three seconds or press and hold the INPUT button for 3 seconds while pressing the ► button on the projector. The 10 digit Inquiring Code will be displayed.</p>  <ul style="list-style-type: none"> • If there is no key input for about 5 minutes while the Inquiring Code is displayed, the projector will turn off. <p>3-2 Contact your dealer with the 10 digit Inquiring Code. Your PIN code will be sent after your user registration information is confirmed.</p> |

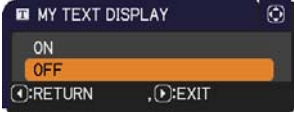
(continued on next page)

| Item | Description |
|------------------------------------|---|
| <p>MY TEXT PASSWORD</p> | <p>The MY TEXT PASSWORD function can prevent the MY TEXT from being overwritten. When the password is set for the MY TEXT;</p> <ul style="list-style-type: none"> • The MY TEXT DISPLAY menu will be unavailable, which can prohibit changing the DISPLAY setting. • The MY TEXT WRITING menu will be unavailable, which can prevent the MY TEXT from being overwritten. <p>1 Turning on the MY TEXT PASSWORD</p> <p>1-1 Use the ▲/▼ buttons on the SECURITY menu to select the MY TEXT PASSWORD and press the ► button to display the MY TEXT PASSWORD on/off menu.</p>  <p>1-2 Use the ▲/▼ buttons on the MY TEXT PASSWORD on/off menu to select ON. The ENTER NEW PASSWORD box (small) will be displayed.</p>  <p>ENTER NEW PASSWORD box (small)</p> <p>1-3 Use the ▲/▼/◀/▶ buttons to enter the password. Move the cursor to the right side of the ENTER NEW PASSWORD box (small) and press the ► button to display the NEW PASSWORD AGAIN box, and then enter the same password again.</p>  <p>1-4 Move the cursor to the right side of the NEW PASSWORD AGAIN box and press ► button to display the NOTE NEW PASSWORD box for about 30 seconds, then please make note of the password during this time.</p>  <p>Pressing the ENTER button on the remote control or ► button on the projector will return to the MY TEXT PASSWORD on/off menu.</p> <p>2 Turning off the MY TEXT PASSWORD</p> <p>2-1 Follow the procedure in 1-1 to display the MY TEXT PASSWORD on/off menu.</p> <p>2-2 Select OFF to display the ENTER PASSWORD box (large). Enter the registered password and the screen will return to the MY TEXT PASSWORD on/off menu.</p>  <p>ENTER PASSWORD box (large)</p> <p>If an incorrect password is input, the menu will close. If necessary, repeat the process from 2-1</p> <p>3 If you have forgotten your password</p> <p>3-1 Follow the procedure in 1-1 to display the MY TEXT PASSWORD on/off menu.</p> <p>3-2 Select OFF to display the ENTER PASSWORD box (large). The 10 digit inquiring code will be displayed inside the box.</p> <p>3-3 Contact your dealer with the 10 digit inquiring code. Your password will be sent after your user registration information is confirmed.</p> |

(continued on next page)

| Item | Description |
|-------------------------------|---|
| <p>MY TEXT DISPLAY</p> | <p>(1) Use the ▲/▼ buttons on the SECURITY menu to select the MY TEXT DISPLAY and press the ► or ENTER button to display the MY TEXT DISPLAY on/off menu.</p>  <p>(2) Use the ▲/▼ buttons on the MY TEXT DISPLAY on/off menu to select on or off. ON ⇔ OFF</p> <p>When it is set ON, the MY TEXT will be displayed on the START UP screen and the INPUT_INFORMATION when the INFORMATION on the SERVICE menu is chosen.</p> <ul style="list-style-type: none"> • This function is available only when the MY TEXT PASSWORD function is set to the OFF.   |
| <p>MY TEXT WRITING</p> | <p>(1) Use the ▲/▼ buttons on the SECURITY menu to select the MY TEXT WRITING and press the ► button. The MY TEXT WRITING dialog will be displayed.</p>  <p>(2) The current MY TEXT will be displayed on the first 3 lines. If not yet written, the lines will be blank. Use the ▲/▼/◀/▶ buttons and the ENTER or INPUT button to select and enter characters. To erase 1 character at one time, press the RESET button or press the ◀ and INPUT button at the same time. Also if you move the cursor to DELETE or ALL CLEAR on screen and press the ENTER or INPUT button, 1 character or all characters will be erased. The MY TEXT can be input up to 24 characters on each line.</p>  <p>(3) To change an already inserted character, press the ▲/▼ button to move the cursor to one of the first 3 lines, and use the ◀/▶ buttons to move the cursor on the character to be changed. After pressing the ENTER or INPUT button, the character is selected. Then, follow the same procedure as described at the item (2) above.</p>  <p>(4) To finish entering text, move the cursor to the OK on screen and press the ►, ENTER or INPUT button. To revert to the previous MY TEXT without saving changes, move the cursor to the CANCEL on screen and press the ◀, ENTER or INPUT button.</p> <ul style="list-style-type: none"> • The MY TEXT WRITING function is available only when the MY TEXT PASSWORD function is set to OFF. |

Maintenance

Replacing the lamp

A lamp has finite product life. Using the lamp for long periods of time could cause the pictures darker or the color tone poor. Note that each lamp has a different lifetime, and some may burst or burn out soon after you start using them. Preparation of a new lamp and early replacement are recommended. To prepare a new lamp, make contact with your dealer and tell the lamp type number.

Type number : DT01151

Replacing the lamp

1. Turn the projector off, and unplug the power cord.
1. Allow the projector to cool for at least 45 minutes.
2. Prepare a new lamp. If the projector is mounted on a ceiling, or if the lamp has broken, also ask the dealer to replace the lamp.

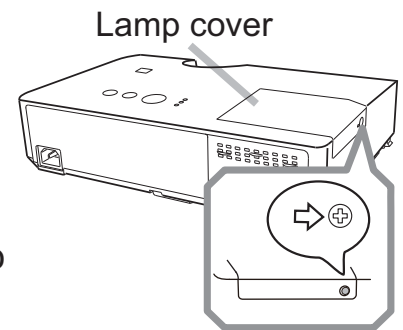

In case of replacement by yourself, follow the following procedure.

3. Loosen the screw (marked by arrow) of the lamp cover and then slide and lift the lamp cover to the side to remove it.
4. Loosen the 2 screws (marked by arrow) of the lamp, and slowly pick up the lamp by the handle. Never loosen any other screws.
5. Insert the new lamp, and retighten firmly the 2 screws of the lamp that are loosened in the previous process to lock it in place.
6. While putting the interlocking parts of the lamp cover and the projector together, slide the lamp cover back in place. Then firmly fasten the screw of the lamp cover.
7. Turn the projector on and reset the lamp time using the LAMP TIME item in the OPTION menu.
 - (1) Press the **MENU** button to display a menu.
 - (2) Point at the **ADVANCED MENU** in the menu using the **▼/▲** button, then press the **▶** button.
 - (3) Point at the **OPTION** in the left column of the menu using the **▼/▲** button, then press the **▶** button.
 - (4) Point at the **LAMP TIME** using the **▼/▲** button, then press the **▶** button. A dialog will appear.
 - (5) Press the **▶** button to select "OK" on the dialog. It performs resetting the lamp time.

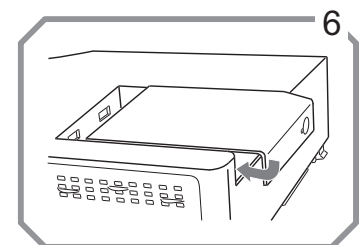
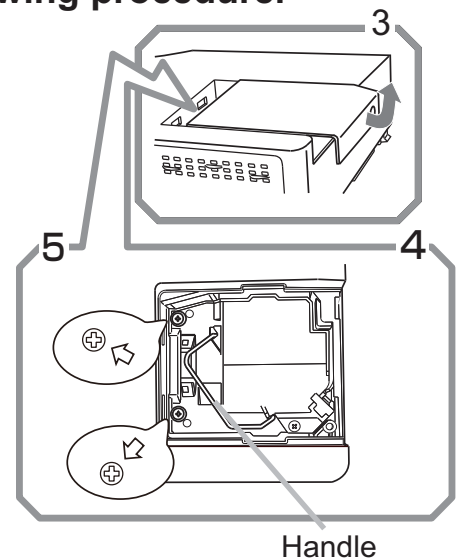

⚠ CAUTION ▶ Do not touch any inner space of the projector, while the lamp is taken out.

NOTE • Please reset the lamp time only when you have replaced the lamp, for a suitable indication about the lamp.

Replacing the lamp (continued)

Lamp warning



HIGH VOLTAGE



HIGH TEMPERATURE



HIGH PRESSURE

⚠ WARNING ► The projector uses a high-pressure mercury glass lamp. The lamp can break with a loud bang, or burn out, if jolted or scratched, handled while hot, or worn over time. Note that each lamp has a different lifetime, and some may burst or burn out soon after you start using them. In addition, if the bulb bursts, it is possible for shards of glass to fly into the lamp housing, and for gas containing mercury and dust containing fine particles of glass to escape from the projector's vent holes.

► **About disposal of a lamp:** This product contains a mercury lamp; do not put it in a trash. Dispose of it in accordance with environmental laws.

- For lamp recycling, go to www.lamprecycle.org (in the US).
- For product disposal, consult your local government agency or www.eiae.org (in the US) or www.epsc.ca (in Canada).

For more information, call your dealer.



Disconnect
the plug
from the
power
outlet

- If the lamp should break (it will make a loud bang when it does), unplug the power cord from the outlet, and make sure to request a replacement lamp from your local dealer. Note that shards of glass could damage the projector's internals, or cause injury during handling, so please do not try to clean the projector or replace the lamp yourself.
- If the lamp should break (it will make a loud bang when it does), ventilate the room well, and make sure not to inhale the gas or fine particles that come out from the projector's vent holes, and not to get them into your eyes or mouth.
- Before replacing the lamp, turn the projector off and unplug the power cord, then wait at least 45 minutes for the lamp to cool sufficiently. Handling the lamp while hot can cause burns, as well as damaging the lamp.



- Never unscrew except the appointed (marked by an arrow) screws.
- Do not open the lamp cover while the projector is suspended from a ceiling. This is dangerous, since if the lamp's bulb has broken, the shards will fall out when the cover is opened. In addition, working in high places is dangerous, so ask your local dealer to have the lamp replaced even if the bulb is not broken.
- Do not use the projector with the lamp cover removed. At the lamp replacing, make sure that the screws are screwed in firmly. Loose screws could result in damage or injury.



- Use only the lamp of the specified type. Use of a lamp that does not meet the lamp specifications for this model could cause a fire, damage or shorten the life of this product.
- If the lamp breaks soon after the first time it is used, it is possible that there are electrical problems elsewhere besides the lamp. If this happens, consult your local dealer or a service representative.
- Handle with care: jolting or scratching could cause the lamp bulb to burst during use.
- Using the lamp for long periods of time, could cause it dark, not to light up or to burst. When the pictures appear dark, or when the color tone is poor, please replace the lamp as soon as possible. Do not use old (used) lamps; this is a cause of breakage.

Cleaning and replacing the air filter

Please check and clean the air filter periodically. When the indicators or a message prompts you to clean the air filter, comply with it as soon as possible. Replace the filters when they are damaged or too soiled. To prepare the new filters, make contact with your dealer and tell the following type number.

Type number : NJ27422

When you replace the lamp, please replace the air filter. An air filter of specified type will come together with a replacement lamp for this projector.

1. Turn the projector off, and unplug the power cord.
 - Allow the projector to sufficiently cool down.
2. Use a vacuum cleaner on and around the filter cover.
3. Pick and pull up the filter cover knobs to take it off.
4. Use a vacuum cleaner for the filter vent of the projector.
5. Take the filter out pulling the filter's knob up while holding the filter cover.
6. Use a vacuum cleaner on both sides of the filter.
 - If the filter is damaged or heavily soiled, replace it with the new one.
7. Put the filter back into the filter cover.
8. Put the filter unit back into the projector.

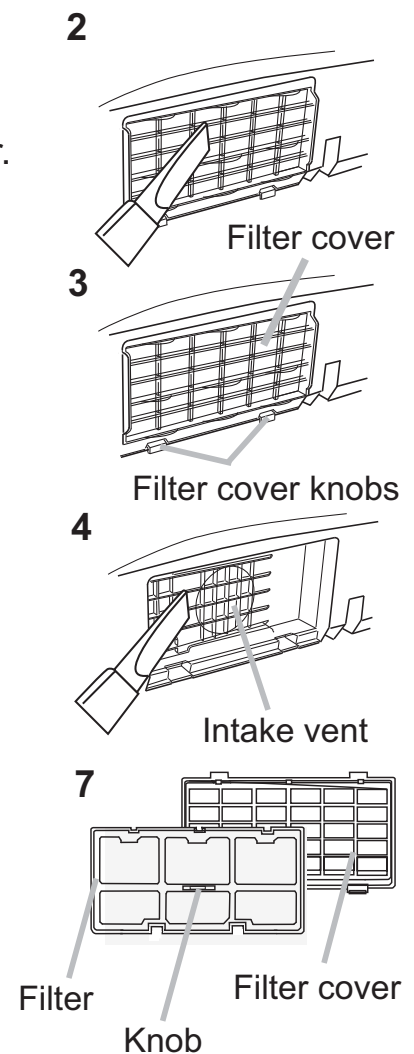

(continued on next page)

Cleaning and replacing the air filter (continued)

9. Turn the projector on and reset the filter time using the FILTER TIME item in the EASY MENU.
 - (1) Press the **MENU** button to display a menu.
 - (2) Point at the FILTER TIME using the ▼/▲ button, then press the ► button. A dialog will appear.
 - (3) Press the ► button to select “OK” on the dialog. It performs resetting the filter time.

⚠ WARNING ► Before taking care of the air filter, make sure the power cable is not plugged in, then allow the projector to cool sufficiently. Taking care of the air filter in a high temperature state of the projector could cause an electric shock, a burn or malfunction to the projector.

- Use only the air filter of the specified type. Do not use the projector without the air filter or the filter cover. It could result in a fire or malfunction to the projector.
- Clean the air filter periodically. If the air filter becomes clogged by dust or the like, internal temperatures rise and could cause a fire, a burn or malfunction to the projector.

- NOTE**
- Please replace the air filter when it is damaged or heavily soiled.
 - When you replace the projection lamp, please replace the air filter. An air filter of specified type will come together with a replacement lamp for this projector.
 - Please reset the filter time only when you have cleaned or replaced the air filter, for a suitable indication about the air filter.
 - The projector may display the message such as “CHECK THE AIR FLOW” or turn off the projector, to prevent the internal heat level rising.

Other care

Inside of the projector

In order to ensure the safe use of your projector, please have it cleaned and inspected by your dealer about once every year.

Caring for the lens

If the lens is flawed, soiled or fogged, it could cause deterioration of display quality. Please take care of the lens, being cautious of handling.

1. Turn the projector off, and unplug the power cord. Allow the projector to cool sufficiently.
2. After making sure that the projector is cool adequately, lightly wipe the lens with a commercially available lens-cleaning wipe. Do not touch the lens directly with your hand.

Caring for the cabinet and remote control

Incorrect care could have adverse influence such as discoloration, peeling paint, etc.

1. Turn the projector off, and unplug the power cord. Allow the projector to cool sufficiently.
2. After making sure that the projector is cool adequately, lightly wipe with gauze or a soft cloth.
If the projector is extremely dirty, dip soft cloth in water or a neutral cleaner diluted in water, and wipe lightly after wringing well. Then, wipe lightly with a soft, dry cloth.

⚠ WARNING ▶ Before caring, make sure the power cord is not plugged in, and then allow the projector to cool sufficiently. The care in a high temperature state of the projector could cause a burn and/or malfunction to the projector.

▶ Never try to care for the inside of the projector personally. Doing is so dangerous.

▶ Avoid wetting the projector or inserting liquids in the projector. It could result in a fire, an electric shock, and/or malfunction to the projector.

- Do not put anything containing water, cleaners or chemicals near the projector.
- Do not use aerosols or sprays.

⚠ CAUTION ▶ Please take right care of the projector according to the following. Incorrect care could cause not only an injury but adverse influence such as discoloration, peeling paint, etc.

▶ Do not use cleaners or chemicals other than those specified in this manual.

▶ Do not polish or wipe with hard objects.

NOTICE ▶ Do not directly touch the lens surface with hands.

Troubleshooting



If an abnormal operation should occur, stop using the projector immediately.

⚠ WARNING ▶ Never use the projector if abnormal operations such as smoke, strange odor, excessive sound, damaged casing or elements or cables, penetration of liquids or foreign matter, etc. should occur. In such cases, immediately disconnect the power plug from the power outlet. After making sure that the smoke or odor has stopped, contact to your dealer or service company.

Otherwise if a problem occurs with the projector, the following checks and measures are recommended before requesting repair.
If this does not resolve the problem, please contact your dealer or service company. They will tell you what warranty condition is applied.

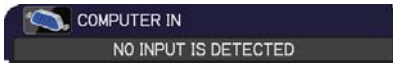

Related messages

When some message appears, check and cope with it according to the following table. Although these messages will be automatically disappeared around several minutes, it will be reappeared every time the power is turned on.

| Message | Description |
|---|---|
|  | <p>There is no input signal. Please confirm the signal input connection, and the status of the signal source.</p> |
|  | <p>The horizontal or vertical frequency of the input signal is not within the specified range. Please confirm the specs for your projector or the signal source specs.</p> |
|  | <p>An improper signal is input. Please confirm the specs for your projector or the signal source specs.</p> |

(continued on next page)

Related messages (continued)

| Message | Description |
|---|--|
|  | <p>The internal temperature is rising. Please turn the power off, and allow the projector to cool down at least 20 minutes. After having confirmed the following items, please turn the power ON again.</p> <ul style="list-style-type: none"> • Is there blockage of the air passage aperture? • Is the air filter dirty? • Does the peripheral temperature exceed 35°C? • If the projector is used at an altitude of about 1600 m (5250 feet) or higher, set ALTITUDE of the SERVICE item in the OPTION menu to HIGH (📖48). <p>If the projector is used with a wrong setting, it may cause damage to the projector itself or the parts inside.</p> |
|  | <p>A note of precaution when cleaning the air filter. Please immediately turn the power off, and clean or change the air filter referring to the Cleaning and replacing the air filter section of this manual. After you have cleaned or changed the air filter, please be sure to reset the filter timer (📖46, 59).</p> |
|  | <p>The button operation is not available (📖6).</p> |

Regarding the indicator lamps

When operation of the **LAMP**, **TEMP** and **POWER** indicators differs from usual, check and cope with it according to the following table.

| POWER indicator | LAMP indicator | TEMP indicator | Description |
|---|----------------------------------|----------------------------------|--|
| Lighting In Orange | Turned off | Turned off | The projector is in a standby state. Please refer to the section "Power on/off". |
| <i>Blinking</i> In Green | Turned off | Turned off | The projector is warming up. Please wait. |
| Lighting In Green | Turned off | Turned off | The projector is in an on state. Ordinary operations may be performed. |
| <i>Blinking</i> In Orange | Turned off | Turned off | The projector is cooling down. Please wait. |
| <i>Blinking</i> In Red | (discre- tionary) | (discre- tionary) | The projector is cooling down. A certain error has been detected. Please wait until POWER indicator finishes blinking, and then perform the proper measure using the item descriptions below. |
| <i>Blinking</i> In Red or Lighting In Red | Lighting In Red | Turned off | The lamp does not light, and there is a possibility that interior portion has become heated. Please turn the power off, and allow the projector to cool down at least 20 minutes. After the projector has sufficiently cooled down, please make confirmation of the following items, and then turn the power on again. <ul style="list-style-type: none"> • Is there blockage of the air passage aperture? • Is the air filter dirty? • Does the peripheral temperature exceed 35°C? If the same indication is displayed after the remedy, please change the lamp referring to the section Replacing the lamp . |
| <i>Blinking</i> In Red or Lighting In Red | <i>Blinking</i> In Red | Turned off | The lamp cover has not been properly fixed. Please turn the power off, and allow the projector to cool down at least 45 minutes. After the projector has sufficiently cooled down, please make confirmation of the attachment state of the lamp cover. After performing any needed maintenance, turn the power on again. If the same indication is displayed after the remedy, please contact your dealer or service company. |
| <i>Blinking</i> In Red or Lighting In Red | Turned off | <i>Blinking</i> In Red | The cooling fan is not operating. Please turn the power off, and allow the projector to cool down at least 20 minutes. After the projector has sufficiently cooled down, please make confirmation that no foreign matter has become caught in the fan, etc., and then turn the power on again. If the same indication is displayed after the remedy, please contact your dealer or service company. |

(continued on next page)

Regarding the indicator lamps (continued)

| POWER indicator | LAMP indicator | TEMP indicator | Description |
|--|-------------------------------------|------------------------|--|
| Blinking In Red or Lighting In Red | Turned off | Lighting In Red | <p>There is a possibility that the interior portion has become heated.</p> <p>Please turn the power off, and allow the projector to cool down at least 20 minutes. After the projector has sufficiently cooled down, please make confirmation of the following items, and then turn the power on again.</p> <ul style="list-style-type: none"> • Is there blockage of the air passage aperture? • Is the air filter dirty? • Does the peripheral temperature exceed 35°C? • If the projector is used at an altitude of about 1600 m (5250 feet) or higher, set ALTITUDE of the SERVICE item in the OPTION menu to HIGH (📖48). If the projector is used with a wrong setting, it may cause damage to the projector itself or the parts inside. |
| Lighting In Green | Simultaneous blinking in Red | | <p>It is time to clean the air filter.</p> <p>Please immediately turn the power off, and clean or change the air filter referring to the section Cleaning and replacing the air filter. After cleaning or changing the air filter, please be sure to reset the filter timer. After the remedy, reset the power to ON.</p> |
| Lighting In Green | Alternative blinking in Red | | <p>There is a possibility that the interior portion has become overcooled.</p> <p>Please use the unit within the usage temperature parameters (5°C to 35°C). After the treatment, reset the power to ON.</p> |
| Blinking In Green for approx. 3 seconds. | Turned off | Turned off | <p>At least 1 Power ON schedule is saved to the projector.</p> |

NOTE • When the interior portion has become overheated, for safety purposes, the projector is automatically shut down, and the indicator lamps may also be turned off. In such a case, disconnect the power cord, and wait at least 45 minutes. After the projector has sufficiently cooled down, please make confirmation of the attachment state of the lamp and lamp cover, and then turn the power on again. If the projector is used at an altitude of about 1600 m (5250 feet) or higher, set ALTITUDE of the SERVICE item in the OPTION menu to HIGH (📖48). Otherwise, set it to NORMAL.

Resetting all settings

If you have any problem correcting some wrong settings, you can use the **FACTORY RESET** function under the **SERVICE** item in the **OPTION** menu (📖50) to reset all settings (except **LANGUAGE**, **LAMP TIME**, **FILTER TIME**, **FILTER MESSAGE** and **SECURITY**) to factory default. Be sure to set **ALTITUDE** after resetting all the settings (📖48).

Phenomena that may be easy to be mistaken for machine defects

About the phenomenon confused with a machine defect, check and cope with it according to the following table.

| Phenomenon | Cases not involving a machine defect | Reference page |
|----------------------------|--|----------------|
| Power does not come on. | The electrical power cord is not plugged in. Correctly connect the power cord. | 13 |
| | The main power source has been interrupted during operation such as by a power outage (blackout), etc. Please disconnect the power plug from the power outlet, and allow the projector to cool down at least 10 minutes, then turn the power on again. | 13 |
| | Either there is no lamp and/or lamp cover, or either of these has not been properly fixed. Please turn the power off and disconnect the power plug from the power outlet, and allow the projector to cool down at least 45 minutes. After the projector has sufficiently cooled down, please make confirmation of the attachment state of the lamp and lamp cover, and then turn the power on again. | 56 |
| No pictures are displayed. | The signal cables are not correctly connected. Correctly connect the connection cables. | 10 ~ 12 |
| | The brightness is adjusted to an extremely low level. Adjust BRIGHTNESS to a higher level using the menu function. | 29 |
| | The computer cannot detect the projector as a plug and play monitor. Make sure that the computer can detect a plug and play monitor using another plug and play monitor. | 10 |
| | The BLANK screen is displayed. Press BLANK button on the remote control. | 24 |

(continued on next page)

Phenomena that may be easy to be mistaken for machine defects (continued)

| Phenomenon | Cases not involving a machine defect | Reference page |
|---|---|----------------|
| Video screen display freezes. | The FREEZE function is working. Press FREEZE button to restore the screen to normal. | 24 |
| Colors have a faded- out appearance, or Color tone is poor. | Color settings are not correctly adjusted. Perform picture adjustments by changing the COLOR TEMP, COLOR, TINT and/or COLOR SPACE settings, using the menu functions. | 30, 35 |
| | COLOR SPACE setting is not suitable. Change the COLOR SPACE setting to AUTO, RGB, SMPTE240, REC709 or REC601. | 35 |
| Pictures appear dark. | The brightness and/or contrast are adjusted to an extremely low level. Adjust BRIGHTNESS and/or CONTRAST settings to a higher level using the menu function. | 29 |
| | The projector is operating in Eco mode. Set ECO MODE to NORMAL, and set AUTO ECO MODE to OFF, in the SETUP menu. | 38 |
| | The lamp is approaching the end of its product lifetime. Replace the lamp. | 56, 57 |
| Pictures appear blurry. | Either the focus and/or horizontal phase settings are not properly adjusted. Adjust the focus using the focus ring, and/or H PHASE using the menu function. | 20, 34 |
| | The lens is dirty or misty. Clean the lens referring to the section Caring for the lens. | 60 |

(continued on next page)

Phenomena that may be easy to be mistaken for machine defects (continued)

| Phenomenon | Cases not involving a machine defect | Reference page |
|--|--|----------------|
| Some kind of image degradation such as flickering or stripes appear on screen. | <p>When the projector is operating in Eco mode, flickering may appear on screen. Set ECO MODE to NORMAL, and set AUTO ECO MODE to OFF, in the SETUP menu.</p> | 38 |
| | <p>The OVER SCAN ratio is too big. Adjust OVER SCAN in the IMAGE menu smaller.</p> | 32 |
| | <p>Excessive VIDEO NR. Change the setting of VIDEO NR in the INPUT menu.</p> | 35 |
| | <p>The FRAME LOCK function cannot work on the current input signal. Set FRAME LOCK in the INPUT menu to OFF.</p> | 36 |

NOTE • Although bright spots or dark spots may appear on the screen, this is a unique characteristic of liquid crystal displays, and it does not constitute or imply a machine defect.

Specifications

Please see the **Specifications** in the **User's Manual (concise)** which is a book.

Projector CP-RX93

User's Manual (detailed) Operating Guide – Technical

Example of PC signal

| Resolution (H x V) | H. frequency (kHz) | V. frequency (Hz) | Rating | Signal mode |
|--------------------|--------------------|-------------------|--------|-------------------|
| 720 x 400 | 37.9 | 85.0 | VESA | TEXT |
| 640 x 480 | 31.5 | 59.9 | VESA | VGA (60Hz) |
| 640 x 480 | 37.9 | 72.8 | VESA | VGA (72Hz) |
| 640 x 480 | 37.5 | 75.0 | VESA | VGA (75Hz) |
| 640 x 480 | 43.3 | 85.0 | VESA | VGA (85Hz) |
| 800 x 600 | 35.2 | 56.3 | VESA | SVGA (56Hz) |
| 800 x 600 | 37.9 | 60.3 | VESA | SVGA (60Hz) |
| 800 x 600 | 48.1 | 72.2 | VESA | SVGA (72Hz) |
| 800 x 600 | 46.9 | 75.0 | VESA | SVGA (75Hz) |
| 800 x 600 | 53.7 | 85.1 | VESA | SVGA (85Hz) |
| 832 x 624 | 49.7 | 74.5 | | Mac 16" mode |
| 1024 x 768 | 48.4 | 60.0 | VESA | XGA (60Hz) |
| 1024 x 768 | 56.5 | 70.1 | VESA | XGA (70Hz) |
| 1024 x 768 | 60.0 | 75.0 | VESA | XGA (75Hz) |
| 1024 x 768 | 68.7 | 85.0 | VESA | XGA (85Hz) |
| 1152 x 864 | 67.5 | 75.0 | VESA | 1152 x 864 (75Hz) |
| 1280 x 768 | 47.7 | 60.0 | VESA | W-XGA (60Hz) |
| 1280 x 800 | 49.7 | 60.0 | VESA | 1280 x 800 (60Hz) |
| 1280 x 960 | 60.0 | 60.0 | VESA | 1280 x 960 (60Hz) |
| 1280 x 1024 | 64.0 | 60.0 | VESA | SXGA (60Hz) |
| 1280 x 1024 | 80.0 | 75.0 | VESA | SXGA (75Hz) |
| *1280 x 1024 | 91.1 | 85.0 | VESA | SXGA (85Hz) |
| 1400 x 1050 | 65.2 | 60.0 | VESA | SXGA+ (60Hz) |
| 1440 x 900 | 55.9 | 59.9 | VESA | WXGA+ (60Hz) |
| *1600 x 1200 | 75.0 | 60.0 | VESA | UXGA (60Hz) |

- NOTE** • Be sure to check jack type, signal level, timing and resolution before connecting this projector to a PC.
- Some PCs may have multiple display screen modes. Use of some of these modes will not be possible with this projector.
 - Depending on the input signal, full-size display may not be possible in some cases. Refer to the number of display pixels above.
 - Although the projector can display signals with resolution up to UXGA (1600x1200), the signal will be converted to the projector's panel resolution before being displayed. The best display performance will be achieved if the resolutions of the input signal and projector panel are identical.
 - Automatic adjustment may not function correctly with some input signals.
 - The image may not be displayed correctly when the input sync signal is a composite sync or a sync on G.

Initial set signals

The following signals are used for the initial settings. The signal timing of some PC models may be different. In such case, adjust the items V POSITION and H POSITION in the IMAGE menu.

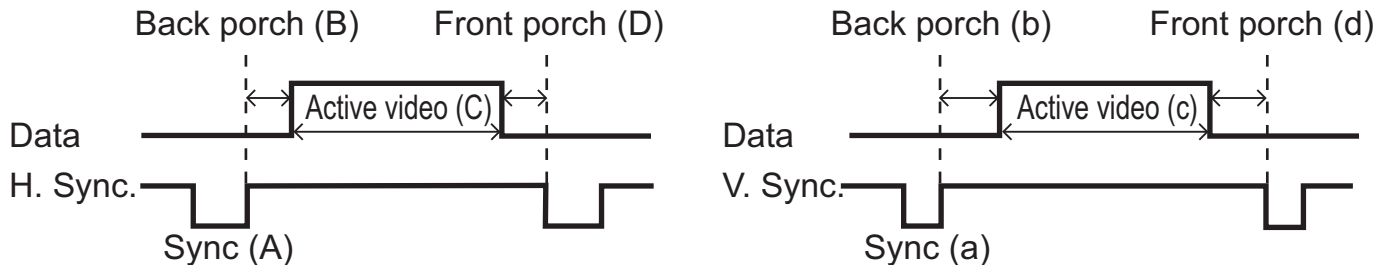

| Resolution (H x V) | Horizontal signal timing (μ s) | | | | Vertical signal timing (lines) | | | | Signal mode |
|-----------------------|-------------------------------------|-----|------|-----|--------------------------------|-----|------|-----|-------------------|
| | (A) | (B) | (C) | (D) | (a) | (b) | (c) | (d) | |
| 720 x 400 | 2.0 | 3.0 | 20.3 | 1.0 | 3 | 42 | 400 | 1 | TEXT |
| 640 x 480 | 3.8 | 1.9 | 25.4 | 0.6 | 2 | 33 | 480 | 10 | VGA (60Hz) |
| 640 x 480 | 1.3 | 4.1 | 20.3 | 0.8 | 3 | 28 | 480 | 9 | VGA (72Hz) |
| 640 x 480 | 2.0 | 3.8 | 20.3 | 0.5 | 3 | 16 | 480 | 1 | VGA (75Hz) |
| 640 x 480 | 1.6 | 2.2 | 17.8 | 1.6 | 3 | 25 | 480 | 1 | VGA (85Hz) |
| 800 x 600 | 2.0 | 3.6 | 22.2 | 0.7 | 2 | 22 | 600 | 1 | SVGA (56Hz) |
| 800 x 600 | 3.2 | 2.2 | 20.0 | 1.0 | 4 | 23 | 600 | 1 | SVGA (60Hz) |
| 800 x 600 | 2.4 | 1.3 | 16.0 | 1.1 | 6 | 23 | 600 | 37 | SVGA (72Hz) |
| 800 x 600 | 1.6 | 3.2 | 16.2 | 0.3 | 3 | 21 | 600 | 1 | SVGA (75Hz) |
| 800 x 600 | 1.1 | 2.7 | 14.2 | 0.6 | 3 | 27 | 600 | 1 | SVGA (85Hz) |
| 832 x 624 | 1.1 | 3.9 | 14.5 | 0.6 | 3 | 39 | 624 | 1 | Mac 16" mode |
| 1024 x 768 | 2.1 | 2.5 | 15.8 | 0.4 | 6 | 29 | 768 | 3 | XGA (60Hz) |
| 1024 x 768 | 1.8 | 1.9 | 13.7 | 0.3 | 6 | 29 | 768 | 3 | XGA (70Hz) |
| 1024 x 768 | 1.2 | 2.2 | 13.0 | 0.2 | 3 | 28 | 768 | 1 | XGA (75Hz) |
| 1024 x 768 | 1.0 | 2.2 | 10.8 | 0.5 | 3 | 36 | 768 | 1 | XGA (85Hz) |
| 1152 x 864 | 1.2 | 2.4 | 10.7 | 0.6 | 3 | 32 | 864 | 1 | 1152 x 864 (75Hz) |
| 1280 x 768 | 1.7 | 2.5 | 16.0 | 0.8 | 3 | 23 | 768 | 1 | W-XGA (60Hz) |
| 1280 x 800 | 1.6 | 2.4 | 15.3 | 0.8 | 3 | 24 | 800 | 1 | W-XGA (60Hz) |
| 1280 x 960 | 1.0 | 2.9 | 11.9 | 0.9 | 3 | 36 | 960 | 1 | W-XGA (60Hz) |
| 1280 x 1024 | 1.0 | 2.3 | 11.9 | 0.4 | 3 | 38 | 1024 | 1 | SXGA (60Hz) |
| 1280 x 1024 | 1.1 | 1.8 | 9.5 | 0.1 | 3 | 38 | 1024 | 1 | SXGA (75Hz) |
| 1280 x 1024 | 1.0 | 1.4 | 8.1 | 0.4 | 3 | 44 | 1024 | 1 | SXGA (85Hz) |
| 1400 x 1050 | 1.2 | 2.0 | 11.4 | 0.7 | 3 | 33 | 1050 | 1 | SXGA+ (60Hz) |
| 1440 x 900 | 1.4 | 2.2 | 13.5 | 0.8 | 6 | 25 | 900 | 3 | WXGA+ (60Hz) |
| 1600 x 1200 | 1.2 | 1.9 | 9.9 | 0.4 | 3 | 46 | 1200 | 1 | UXGA (60Hz) |

Connection to the ports

NOTICE ▶ Use the cables with straight plugs, not L-shaped ones, as the input ports of the projector are recessed.

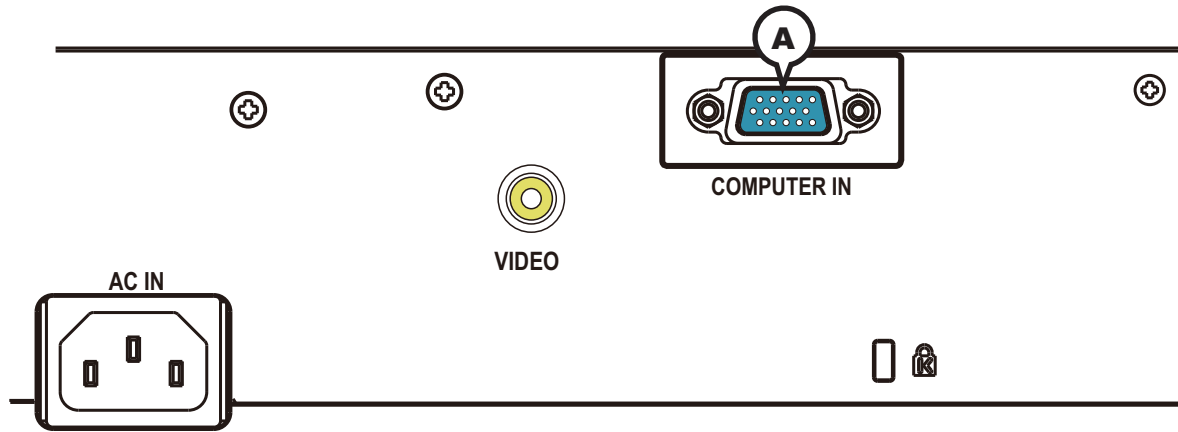

ⒶCOMPUTER

D-sub 15pin mini shrink jack

<Computer signal>

- Video signal: RGB separate, Analog, 0.7Vp-p, 75Ω terminated (positive)
- H/V. sync. signal: TTL level (positive/negative)
- Composite sync. signal: TTL level

<Component video signal>

- Video signal:
 - Y, Analog, 1.0±0.1Vp-p with composite sync, 75Ω terminated
 - Cb/Pb, Analog, 0.7±0.1Vp-p, 75Ω terminated
 - Cr/Pr, Analog, 0.7±0.1Vp-p 75Ω terminated

System: 480i@60, 480p@60, 576i@50, 576p@50, 720p@50/60, 1080i@50/60, 1080p@50/60

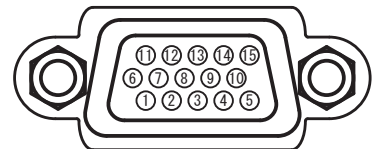

| Pin | Signal | Pin | Signal |
|-----|---------------------------|-----|--|
| 1 | Video Red, Cr/Pr | 9 | (No connection) |
| 2 | Video Green, Y | 10 | Ground |
| 3 | Video Blue, Cb/Pb | 11 | (No connection) |
| 4 | (No connection) | 12 | SDA (DDC data), (No connection) |
| 6 | Ground Red, Ground Cr/Pr | 13 | H. sync / Composite sync., (No connection) |
| 7 | Ground Green, Ground Y | 14 | V. sync., (No connection) |
| 8 | Ground Blue, Ground Cb/Pb | 15 | SCL (DDC clock), (No connection) |

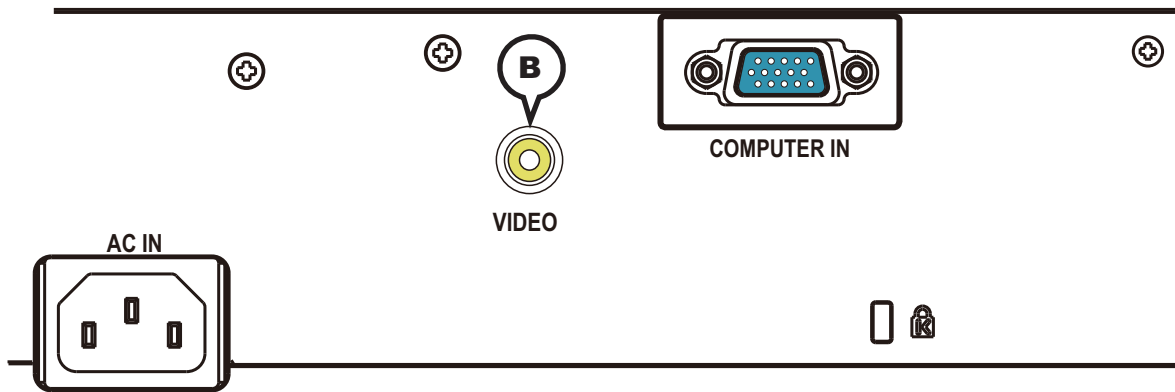

ⓑ VIDEO

RCA jack

- System: NTSC, PAL, SECAM, PAL-M, PAL-N, NTSC4.43, PAL (60Hz)
- $1.0 \pm 0.1V_{p-p}$, 75Ω terminator

To input component video signal to **COMPUTER IN** ports

ex.

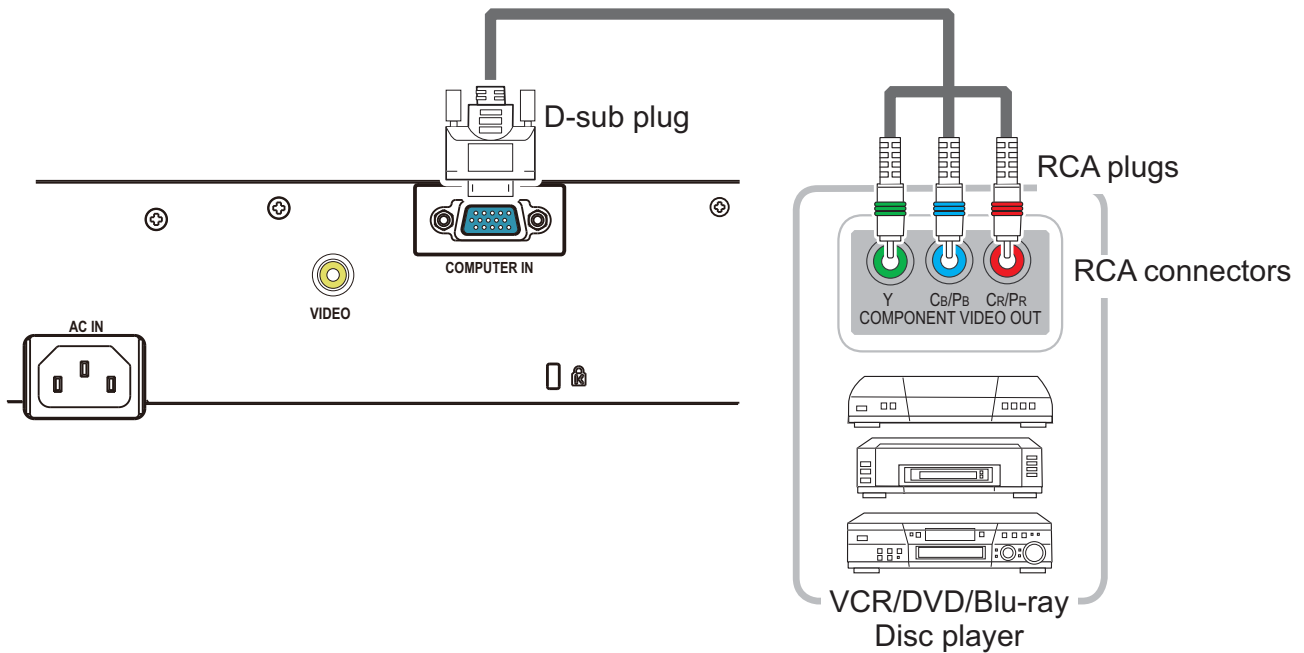

To input component video signal to the **COMPUTER IN** port of the projector, use a RCA to D-sub cable or adapter.

For about the pin description of the required cable or adapter, refer to the descriptions about **COMPUTER IN** port ([📖3](#)).

Projector

CP-RX93

User's Manual (concise)

Thank you for purchasing this projector.

Please read through this manual before using this product, in order to use safely and utilize well the product.

- ⚠ WARNING** ▶ Before using this product, be sure to read all manuals for this product. After reading them, store them in a safe place for future reference.
- ▶ Heed all the warnings and cautions in the manuals or on the product.
 - ▶ Follow all the instructions in the manuals or on the product.

NOTE • In this manual, unless any comments are accompanied, “the manuals” means all the documents provided with this product, and “the product” means this projector and all the accessories came with the projector.

Contents

| | |
|---|---|
| First of all 2 | Turning on the power..... 9 |
| Entries and graphical symbols explanation2 | Adjusting the projector's elevator 10 |
| Important safety instruction2 | Displaying the picture 11 |
| Regulatory notices..... 3 | Turning off the power..... 12 |
| About Electro-Magnetic Interference3 | Replacing the lamp..... 13 |
| About Waste Electrical and Electronic Equipment...4 | Cleaning and replacing the air filter .. 15 |
| Contents of package..... 4 | Using the CD manual 16 |
| Preparing for the remote control..... 5 | Specifications 17 |
| Arrangement..... 6 | Troubleshooting |
| Connecting with your devices..... 7 | - Warranty and after-service 18 |
| Connecting power supply 8 | |

First of all

Entries and graphical symbols explanation

The following entries and graphical symbols are used for the manuals and the product as follows, for safety purpose. Please know their meanings beforehand, and heed them.

- ⚠ **WARNING** This entry warns of a risk of serious personal injury or even death.
- ⚠ **CAUTION** This entry warns of a risk of personal injury or physical damage.
- NOTICE** This entry notices of fear of causing trouble.

Important safety instruction

The followings are important instructions for safely using the product. Be sure to follow them always when handling the product. The manufacturer assumes no responsibility for any damage caused by mishandling that is beyond normal usage defined in these manuals of this projector.

- ⚠ **WARNING** ▶ Never use the product in or after an abnormality (ex. giving off smoke, smelling strange, took a liquid or an object inside, broken, etc.) If an abnormality should occur, unplug the projector urgently.
- ▶ Situate the product away from children and pets.
- ▶ Keep small parts away from children and pets. If swallowed, consult a physician immediately for emergency treatment.
- ▶ Do not use the product when there is fear of a thunderbolt.
- ▶ Unplug the projector from the power outlet if the projector is not used for the time being.
- ▶ Do not open or remove any portion of the product, unless the manuals direct it. For internal maintenance, leave it to your dealer or their service personnel.
- ▶ Use only the accessories specified or recommended by the manufacturer.
- ▶ Do not modify the projector or accessories.
- ▶ Do not let any things or any liquids enter to the inside of the product.
- ▶ Do not wet the product.
- ▶ Do not place the projector where any oils, such as cooking or machine oil, are used. Oil may harm the product, resulting in malfunction, or falling from the mounted position.
- ▶ Do not apply a shock or pressure to this product.
- Do not place the product on an unstable place such as the uneven surface or the leaned table.
- Do not place the product unstably. Place the projector so that it does not protrude from the surface where the projector is placed on.
- Remove all the attachments including the power cord and cables, from the projector when carrying the projector.
- ▶ Do not look into the lens and the openings on the projector, while the lamp is on.
- ▶ Do not approach the lamp cover and the exhaust vents, while the projection lamp is on. Also after the lamp goes out, do not approach them for a while, since too hot.

Regulatory notices

About Electro-Magnetic Interference

In CANADA

This Class B digital apparatus complies with Canadian ICES-003.

In the US, and other places where the FCC regulations are applicable

Declaration of Conformity

| | |
|-------------------|--|
| Trade name | HITACHI |
| Model Number | CP-RX93 |
| Responsible Party | Hitachi America, Ltd. |
| Address | 900 Hitachi way, Chula Vista, CA 91914-3556 U.S.A. |
| Telephone Number | +1 -800-225-1741 |

This device complies with part 15 of the FCC Rules. Operation is subject to the following two conditions: (1) This device may not cause harmful interference, and (2) this device must accept any interference received, including interference that may cause undesired operation. This equipment has been tested and found to comply with the limits for a Class B digital device, pursuant to Part 15 of the FCC Rules.

These limits are designed to provide reasonable protection against harmful interference in a residential installation. This equipment generates, uses, and can radiate radio frequency energy and, if not installed and used in accordance with the instructions, may cause harmful interference to radio communications. However, there is no guarantee that interference will not occur in a particular installation. If this equipment does cause harmful interference to radio or television reception, which can be determined by turning the equipment off and on, the user is encouraged to try to correct the interference by one or more of the following measures:

- Reorient or relocate the receiving antenna.
- Increase the separation between the equipment and receiver.
- Connect the equipment into an outlet on a circuit different from that to which the receiver is connected.
- Consult the dealer or an experienced radio/TV technician for help.

INSTRUCTIONS TO USERS: This equipment complies with the requirements of FCC (Federal Communication Commission) equipment provided that the following conditions are met. Some cables have to be used with the core set. Use the accessory cable or a designated-type cable for the connection. For cables that have a core only at one end, connect the core to the projector.

CAUTION: Changes or modifications not expressly approved by the party responsible for compliance could void the user's authority to operate the equipment.

Regulatory notices (continued)

About Waste Electrical and Electronic Equipment



The mark is in compliance with the Waste Electrical and Electronic Equipment Directive 2002/96/EC (WEEE).

The mark indicates the requirement NOT to dispose the equipment including any spent or discarded batteries or accumulators as unsorted municipal waste, but use the return and collection systems available. If the batteries or accumulators included with this equipment, display the chemical symbol Hg, Cd, or Pb, then it means that the battery has a heavy metal content of more than 0.0005% Mercury or more than, 0.002% Cadmium, or more than 0.004% Lead.

Contents of package

Your projector should come with the items shown below. Check that all the items are included. Require of your dealer immediately if any items are missing.

- (1) Remote control with two AA batteries
- (2) Power cord
- (3) Computer cable
- (4) User's manuals (Book x1, CD x1)

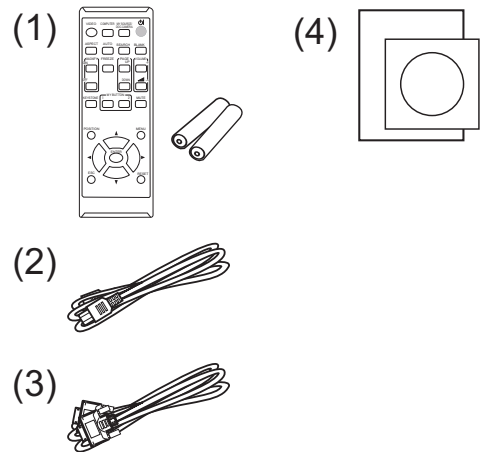

⚠ WARNING ► Keep small parts away from children and pets. Take care not to put in the mouth. If swallowed, consult a physician immediately for emergency treatment.

NOTE • Keep the original packing materials for future reshipment. Be sure to use the original packing materials when moving the projector. Use special caution for the lens.

• The projector may make a rattling sound when tilted, moved or shaken, since a flap to control the air flow inside of the projector has moved. Be aware that this is not a failure or malfunction.

Preparing for the remote control

Please insert the batteries into the remote control before using it. If the remote control starts to malfunction, try to replace the batteries. If you will not use the remote control for long period, remove the batteries from the remote control and store them in a safe place.

1. Holding the hook part of the battery cover, remove it.
2. Align and insert the two AA batteries (HITACHI MAXELL or HITACHI MAXELL ENERGY, Part No.LR6 or R6P) according to their plus and minus terminals as indicated in the remote control.
3. Replace the battery cover in the direction of the arrow and snap it back into place.

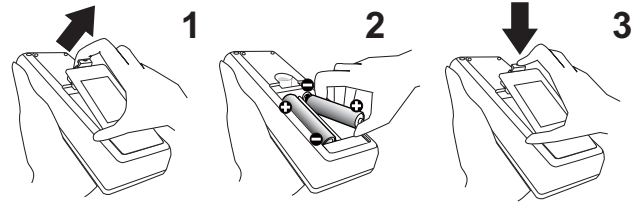

ENGLISH

⚠ WARNING ▶ Always handle the batteries with care and use them only as directed. Improper use may result in battery explosion, cracking or leakage, which could result in fire, injury and/or pollution of the surrounding environment.

- When replacing the batteries, replace both of the batteries with new batteries of the same type. Do not use a new battery with a used battery.
- Be sure to use only the batteries specified. Do not use batteries of different types at the same time. Do not mix a new battery with used one.
- Make sure the plus and minus terminals are correctly aligned when loading a battery.
- Keep a battery away from children and pets.
- Do not recharge, short circuit, solder or disassemble a battery.
- Do not place a battery in a fire or water. Keep batteries in a dark, cool and dry place.
- If you observe battery leakage, wipe out the leakage and then replace a battery. If the leakage adheres to your body or clothes, rinse well with water immediately.
- Obey the local laws on disposing the battery.

Arrangement

Refer to table **T-1** and figures **F-1** and **F-2** at the end of this manual to determine the screen size and projection distance (from the projector's end). The values shown in the table are calculated for a full size screen.

Ⓐ Screen size (diagonal)

Ⓑ Projection distance ($\pm 10\%$, from the projector's end)

Ⓒ¹, Ⓒ² Screen height ($\pm 10\%$)

• If the projector is used at an altitude of about 1600 m (5250 feet) or higher, set ALTITUDE of the SERVICE item in the OPTION menu to HIGH. Otherwise, set it to NORMAL.

If the projector is used with a wrong setting, it may cause damage to the projector itself or the parts inside.

⚠ WARNING ▶ Install the projector where you can access the power outlet easily.

▶ Install the projector in a stable horizontal position.

- Do not use any mounting accessories except the accessories specified by the manufacturer. Read and keep the manuals of the accessories used.
- For special installation such as ceiling mounting, be sure to consult your dealer beforehand. Specific mounting accessories and services may be required.
- Do not put the projector on its side, front or rear position.
- Do not attach nor place anything on the projector unless otherwise specified in the manual.
- ▶ Do not install the projector near thermally conductive or flammable things.
- ▶ Do not place the projector where any oils, such as cooking or machine oil, are used.
- ▶ Do not place the projector in a place where it may get wet.

⚠ CAUTION ▶ Place the projector in a cool place with sufficient ventilation.

- Keep a space of 30 cm or more between a side of the projector and other objects such as walls.
- Do not stop up, block nor cover the projector's vent holes.
- Do not place the projector at places that are exposed to magnetic fields, doing so can cause the cooling fans inside the projector to malfunction.
- ▶ Avoid placing the projector in smoky, humid or dusty place.
- Do not place the projector near humidifiers.

NOTICE ▶ Position the projector to prevent light from directly hitting the projector's remote sensor.

- ▶ Do not place the product in a place where radio interference may be caused.
- ▶ Check and correct the setting for ALTITUDE of SERVICE in the OPTION menu according to the usage environment. For details, see **User's Manual - Operating Guide**.

Connecting with your devices

Before connecting the projector to a device, consult the manual of the device to confirm that the device is suitable for connecting with this projector and prepare the required accessories, such as a cable in accord with the signal of the device. Consult your dealer when the required accessory did not come with the product or the accessory is damaged.

After making sure that the projector and the devices are turned off, perform the connection, according to the following instructions. Refer to figures **F-3** and **F-4** at the end of this manual.

For details, see **User's Manual - Operating Guide**.

⚠ WARNING ► Use only the appropriate accessories. Otherwise it could cause a fire or damage the projector and devices.

- Use only the accessories specified or recommended by the projector's manufacturer. It may be regulated under some standard.
- Neither disassemble nor modify the projector and the accessories.
- Do not use the damaged accessory. Be careful not to damage the accessories. Route a cable so that it is neither stepped on nor pinched out.

⚠ CAUTION ► For a cable with a core at only one end, connect the end with the core to the projector. That may be required by EMI regulations.

NOTE • Do not turn on or off the projector while connected to a device in operation, unless that is directed in the manual of the device.

- Some input ports are selectable in the use. For details, see **User's Manual - Operating Guide**.
- Be careful not to mistakenly connect a connector to a wrong port.

Connecting power supply

1. Put the connector of the power cord into the **AC IN** (AC inlet) of the projector.
2. Firmly plug the power cord's plug into the outlet. In a couple of seconds after the power supply connection, the **POWER** indicator will light up in steady orange.

Please remember that when the DIRECT POWER ON function activated, the connection of the power supply make the projector turn on.

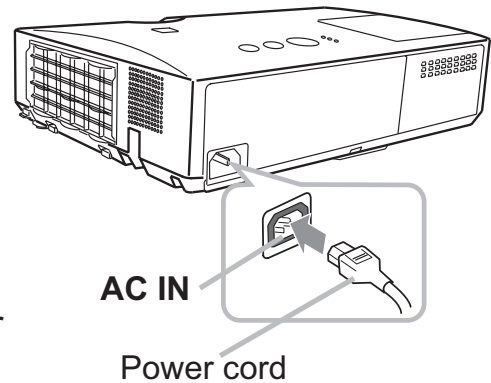

⚠ WARNING ► Please use extra caution when connecting the power cord, as incorrect or faulty connections may result in fire and/or electrical shock.

- Do not touch the power cord with a wet hand.
- Only use the power cord that came with the projector. If it is damaged, consult your dealer to get a new one. Never modify the power cord.
- Only plug the power cord into an outlet whose voltage is matched to the power cord. The power outlet should be close to the projector and easily accessible. Remove the power cord for complete separation.
- Do not distribute the power supply to multiple devices. Doing so may overload the outlet and connectors, loosen the connection, or result in fire, electric shock or other accidents.
- Connect the ground terminal for the AC inlet of this unit to the ground terminal of the building using an appropriate power cord (bundled).

NOTICE ► This product is also designed for IT power systems with a phase-to-phase voltage of 220 to 240 V.

Turning on the power

1. Make sure that the power cord is firmly and correctly connected to the projector and the outlet.
2. Make sure that the **POWER** indicator is steady orange.
3. Press the **STANDBY/ON** button on the projector or the remote control.

The projection lamp will light up and the **POWER** indicator will begin blinking in green. When the power is completely on, the indicator will stop blinking and light in steady green.

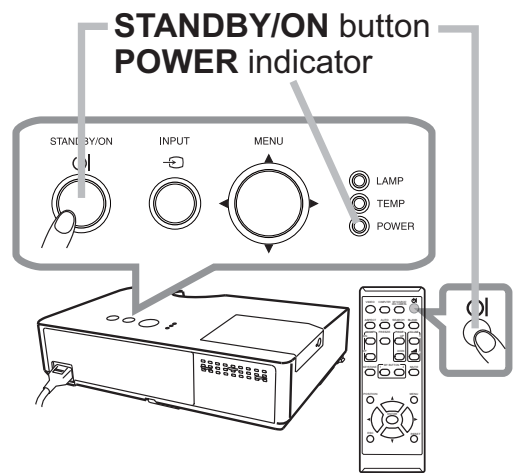

⚠ WARNING ► A strong light is emitted when the projector's power is on. Do not look into the lens of the projector or look inside of the projector through any of the projector's openings.

NOTE • Please power on the projector prior to the connected devices.
• The projector has the **DIRECT POWER ON** function, which can make the projector automatically turn on. For more information, please see **User's Manual - Operating Guide**.

Adjusting the projector's elevator

When the place to put the projector is slightly uneven to the left or right, use the elevator feet to place the projector horizontally.

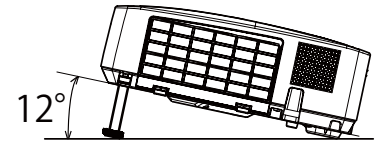

Using the feet can also tilt the projector in order to project at a suitable angle to the screen, elevating the front side of the projector within 12 degrees.

This projector has 2 elevator feet and 2 elevator knobs. An elevator foot is adjustable while pulling up the elevator knob on the same side as it.

1. Holding the projector, pull the elevator knobs up to loose the elevator feet.
2. Position the front side of the projector to the desired height.
3. Release the elevator knobs in order to lock the elevator feet.
4. After making sure that the elevator feet are locked, put the projector down gently.
5. If necessary, the elevator feet can be manually twisted to make more precise adjustments. Hold the projector when twisting the feet.

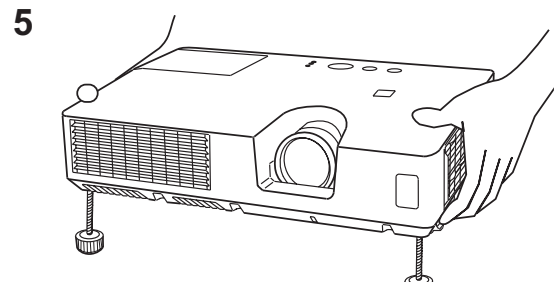
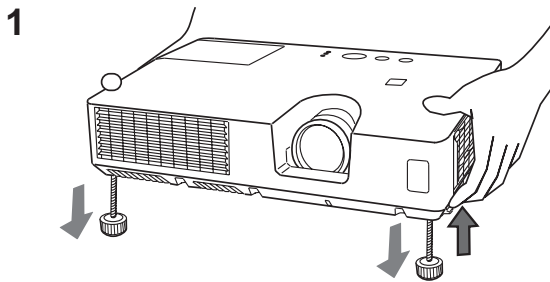

To loose an elevator foot, pull up the elevator knob on the same side as it.

To finely adjust, twist the foot.

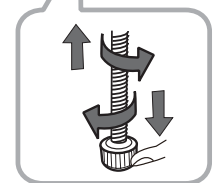

⚠ CAUTION ► Do not handle the elevator buttons without holding the projector, since the projector may drop down.

► Do not tilt the projector other than elevating its front within 12 degrees using the adjuster feet. A tilt of the projector exceeding the restriction could cause malfunction or shortening the lifetime of consumables, or the projector itself.

Displaying the picture

1. Activate your signal source. Turn the signal source on, and make it send the signal to the projector.
2. Press the **INPUT** button on the projector. Each time you press the button, the projector switches its input port in turn. You can also use the remote control to select an input signal. Press the **VIDEO** button for selecting an input signal from the **VIDEO** port, or the **COMPUTER** button for selecting an input signal from the **COMPUTER IN** port.
3. Press the **ASPECT** button on the remote control. Each time you press the button, the projector switches the mode for aspect ratio in turn.
4. Use the **ZOOM** ring to adjust the screen size.
5. Use the **FOCUS** ring to focus the picture.

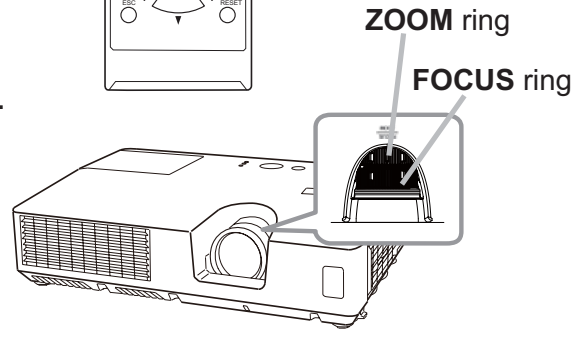
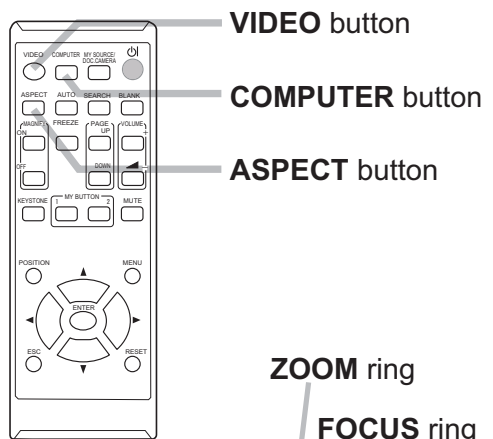
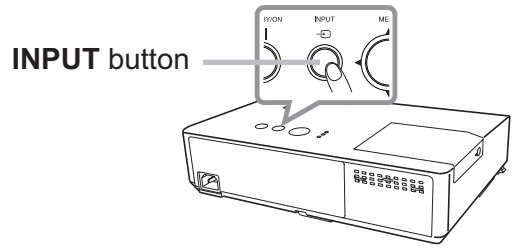

⚠ CAUTION ► If you wish to have a blank screen while the projector's lamp is on, use the BLANK function. (see **User's Manual - Operating Guide**)
Taking any other action may cause the damage on the projector.

NOTE • The **ASPECT** button does not work when no proper signal is inputted.
• For the details of how to adjust the picture, please see **User's Manual - Operating Guide**.

Turning off the power

1. Press the **STANDBY/ON** button on the projector or the remote control.
The message “Power off?” will appear on the screen for about 5 seconds.
2. Press the **STANDBY/ON** button again while the message appears.
The projector lamp will go off, and the **POWER** indicator will begin blinking in orange. Then the **POWER** indicator will stop blinking and light in steady orange when the lamp cooling is complete.

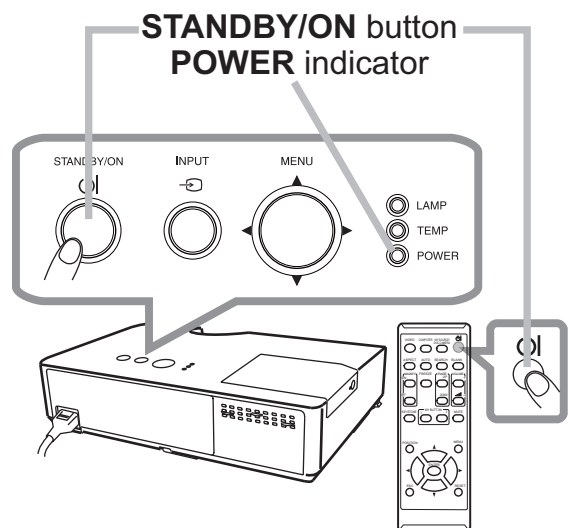

Do not turn the projector on for about 10 minutes or more after turning it off. Also, do not turn the projector off shortly after turning it on. Such operations might cause the lamp to malfunction or shorten the lifetime of some parts including the lamp.

⚠ WARNING ▶ Do not touch around the lamp cover and the exhaust vents during use or just after use, since it is too hot.
▶ Remove the power cord for complete separation. The power outlet should be close to the projector and easily accessible.

NOTE • Please power off the projector after any connected devices are powered off.
• This projector has the AUTO POWER OFF function that can make the projector turn off automatically. For more information, please see **User's Manual - Operating Guide**.

Replacing the lamp

A lamp has finite product life. Using the lamp for long periods of time could cause the pictures darker or the color tone poor. Note that each lamp has a different lifetime, and some may burst or burn out soon after you start using them.

Preparation of a new lamp and early replacement are recommended. To prepare a new lamp, make contact with your dealer and tell the lamp type number.

Type number : DT01151

1. Turn the projector off, and unplug the power cord.
Allow the projector to cool for at least 45 minutes.
2. Prepare a new lamp. If the projector is mounted on a ceiling, or if the lamp has broken, also ask the dealer to replace the lamp.

In case of replacement by yourself, follow the following procedure.

3. Loosen the screw (marked by arrow) of the lamp cover and then slide and lift the lamp cover to the side to remove it.
4. Loosen the 2 screws (marked by arrow) of the lamp, and slowly pick up the lamp by the handle. Never loosen any other screws.
5. Insert the new lamp, and retighten firmly the 2 screws of the lamp that are loosened in the previous process to lock it in place.
6. While putting the interlocking parts of the lamp cover and the projector together, slide the lamp cover back in place. Then firmly fasten the screw of the lamp cover.
7. Turn the projector on and reset the lamp time using the LAMP TIME item in the OPTION menu.

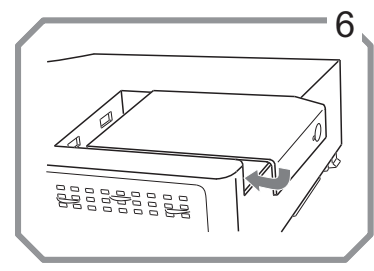
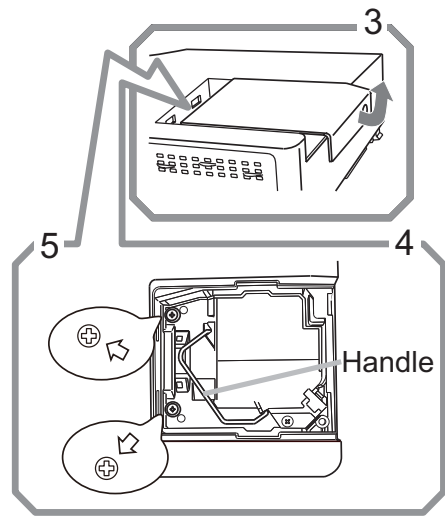
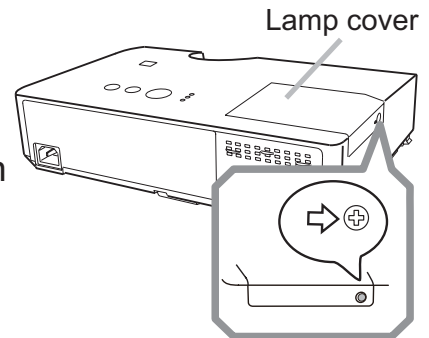

- (1) Press the **MENU** button to display a menu.
- (2) Point at the **ADVANCED MENU** in the menu using the **▼/▲** button, then press the **▶** button.
- (3) Point at the **OPTION** in the left column of the menu using the **▼/▲** button, then press the **▶** button.
- (4) Point at the **LAMP TIME** using the **▼/▲** button, then press the **▶** button. A dialog will appear.
- (5) Press the **▶** button to select "OK" on the dialog. It performs resetting the lamp time.

⚠ CAUTION ▶ Do not touch any inner space of the projector, while the lamp is taken out.

NOTE • Please reset the lamp time only when you have replaced the lamp, for a suitable indication about the lamp.

Replacing the lamp (continued)

 **HIGH VOLTAGE**  **HIGH TEMPERATURE**  **HIGH PRESSURE**

⚠ WARNING ▶ The projector uses a high-pressure mercury glass lamp. The lamp can break with a loud bang, or burn out, if jolted or scratched, handled while hot, or worn over time. Note that each lamp has a different lifetime, and some may burst or burn out soon after you start using them. In addition, if the bulb bursts, it is possible for shards of glass to fly into the lamp housing, and for gas containing mercury and dust containing fine particles of glass to escape from the projector's vent holes.

▶ **About disposal of a lamp:** This product contains a mercury lamp; do not put it in a trash. Dispose of it in accordance with environmental laws.

- For lamp recycling, go to www.lamprecycle.org (in the US).
- For product disposal, consult your local government agency or www.eiae.org (in the US) or www.epsc.ca (in Canada).

For more information, ask your dealer.



Disconnect
the plug
from the
power
outlet

- If the lamp should break (it will make a loud bang when it does), unplug the power cord from the outlet, and make sure to request a replacement lamp from your local dealer. Note that shards of glass could damage the projector's internals, or cause injury during handling, so please do not try to clean the projector or replace the lamp yourself.

- If the lamp should break (it will make a loud bang when it does), ventilate the room well, and make sure not to inhale the gas or fine particles that come out from the projector's vent holes, and not to get them into your eyes or mouth.

- Before replacing the lamp, turn the projector off and unplug the power cord, then wait at least 45 minutes for the lamp to cool sufficiently. Handling the lamp while hot can cause burns, as well as damaging the lamp.



- Never unscrew except the appointed (marked by an arrow) screws.
- Do not open the lamp cover while the projector is suspended from a ceiling. This is dangerous, since if the lamp's bulb has broken, the shards will fall out when the cover is opened. In addition, working in high places is dangerous, so ask your local dealer to have the lamp replaced even if the bulb is not broken.

- Do not use the projector with the lamp cover removed. At the lamp replacing, make sure that the screws are screwed in firmly. Loose screws could result in damage or injury.



- Use only the lamp of the specified type. Use of a lamp that does not meet the lamp specifications for this model could cause a fire, damage or shorten the life of this product.

- If the lamp breaks soon after the first time it is used, it is possible that there are electrical problems elsewhere besides the lamp. If this happens, consult your local dealer or a service representative.

- Handle with care: jolting or scratching could cause the lamp bulb to burst during use.
- Using the lamp for long periods of time, could cause it dark, not to light up or to burst. When the pictures appear dark, or when the color tone is poor, please replace the lamp as soon as possible. Do not use old (used) lamps; this is a cause of breakage.

Cleaning and replacing the air filter

Please check and clean the air filter periodically. When the indicators or a message prompts you to clean the air filter, comply with it as soon as possible. Replace the filters when they are damaged or too soiled. To prepare the new filters, make contact with your dealer and tell the following type number.

Type number : NJ27422

When you replace the lamp, please replace the air filter. An air filter of specified type will come together with a replacement lamp for this projector.

1. Turn the projector off, and unplug the power cord. Allow the projector to sufficiently cool down.
2. Use a vacuum cleaner on and around the filter cover.
3. Pick and pull up the filter cover knobs to take it off.
4. Use a vacuum cleaner for the filter vent of the projector.
5. Take the filter out pulling the filter's knob up while holding the filter cover.
6. Use a vacuum cleaner on both sides of the filter. If the filter is damaged or heavily soiled, replace it with the new one.
7. Put the filter back into the filter cover.
8. Put the filter unit back into the projector.
9. Turn the projector on and reset the filter time using the FILTER TIME item in the EASY MENU.
 - (1) Press the **MENU** button to display a menu.
 - (2) Point at the FILTER TIME using the ▼/▲ button, then press the ► button. A dialog will appear.
 - (3) Press the ► button to select "OK" on the dialog. It performs resetting the filter time.

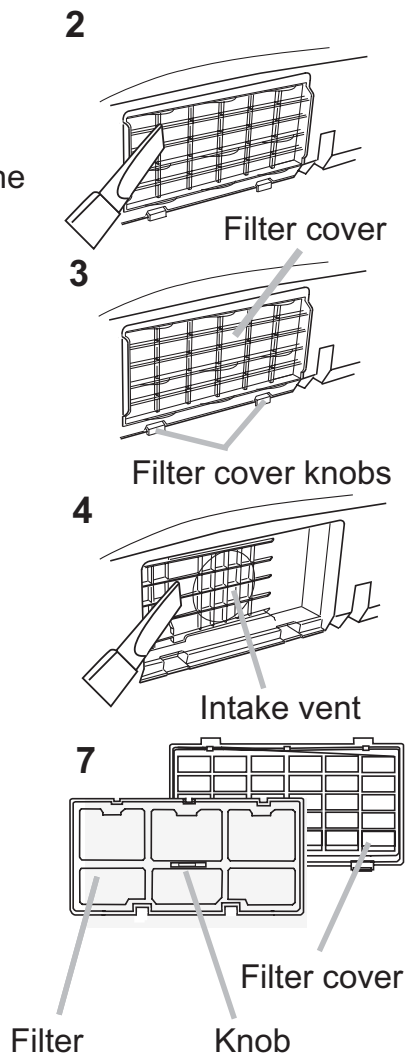

⚠ WARNING ► Before taking care of the air filter, make sure the power cable is not plugged in, then allow the projector to cool sufficiently.
 ► Use only the air filter of the specified type. Do not use the projector without the air filter or the filter cover. It could result in a fire or malfunction to the projector.
 ► Clean the air filter periodically. If the air filter becomes clogged by dust or the like, internal temperatures rise and could cause a fire, a burn or malfunction to the projector.

NOTE • Please reset the filter time only when you have cleaned or replaced the air filter, for a suitable indication about the air filter.
 • The projector may display the message such as "CHECK THE AIR FLOW" or turn off the projector, to prevent the internal heat level rising.

Using the CD manual

The other manuals for this product are written into the included CD-ROM titled “User’s Manual (detailed)”. Before using the CD-ROM, please read the following to ensure the proper use.

■ System requirements

The system for using the CD-ROM requires the following.

- Windows®:** OS:Microsoft®
Windows® XP, Windows Vista® Windows®7 or later
- Macintosh®:** OS:Mac OS® 10.2 or later
- CD-ROM/DVD-ROM drive:**
- Applications:** Microsoft® Internet Explorer®6.0 or later
Adobe® Acrobat® Reader® 8.0 or later

■ How to use the CD

1. Insert CD into computer’s CD-ROM/DVD-ROM drive.

Windows®: In a while, Web browser automatically starts. Start up window comes up.

Macintosh®: (1) Double-click on the “Projectors” icon appeared on the desktop screen.
(2) When “main.html” file is clicked, Web browser will start and Initial window will appear.

2. Click the model name of your projector first, and then click language you want from the displayed list. The User’s manual (detailed) will open.

⚠ CAUTION ▶ Only use the CD-ROM in a computer CD/DVD drive. The CD-ROM is designed for computer use only. NEVER INSERT THE CD-ROM INTO A NON-COMPUTER CD/DVD PLAYER! Inserting the CD-ROM into an incompatible CD/DVD drive may produce a loud noise, which in turn MAY RESULT IN EAR AND SPEAKER DAMAGE!

- After using CD-ROM, please put it into CD case and keep it. Please keep the CD neither in direct sunlight nor in a high temperature and high humidity environment.

NOTE • The information in the CD-ROM is subject to change without notice. Please check our website where you may find the latest information for this projector. (📖 18)

- No responsibility is taken for any obstacle and defect to hardware and software of your computer as a result of the use of the CD-ROM.
- All or Any part of the information in the CD-ROM must not be copied, reproduced or republished without notice to our company.

Specifications

| Item | Specification |
|--------------------------------|---|
| Product name | Liquid crystal projector |
| Liquid Crystal Panel | 786,432 pixels (1024 horizontal x 768 vertical) |
| Lamp | 200 W UHB |
| Power supply/ Rated current | AC 100-120 V: 2.9 A, AC 220-240 V: 1.4 A |
| Power consumption | AC 100-120 V: 290 W, AC 220-240 V: 270 W |
| Temperature range | 5 ~ 35 °C (Operating) |
| Size | 306 (W) x 77 (H) x 221 (D) mm * Not including protruding parts. Refer to figure F-5 at the back of this manual. |
| Weight (mass) | approx. 2.2 kg |
| Ports | COMPUTER IN D-sub 15 pin mini jack x1 VIDEO RCA jack x1 |
| Optional parts | Lamp: DT01151 Filter set: NJ27422 Mounting accessory: HAS-X1 (Bracket for ceiling mount) HAS-204L (Fixing adaptor for low ceilings) HAS-304H (Fixing adaptor for high ceilings) Laser remote control: RC-R008 * For more information, please consult your dealer. |

Troubleshooting - Warranty and after-service

If an abnormal operation (such as smoke, strange odor or excessive sound) should occur, stop using the projector immediately.

Otherwise if a problem occurs with the projector, first refer to “Troubleshooting” of **User’s Manual - Operating Guide** and run through the suggested checks.

If this does not resolve the problem, please consult your dealer or service company. They will tell you what warranty condition is applied.

Please check the following web address where you may find the latest information for this projector.

| | |
|--|--|
| Product information and Manuals : | <u>http://www.hitachi-america.us/digitalmedia</u> |
| Production information : | <u>http://www.hitachidigitalmedia.com</u> |
| Direct link to manual download : | <u>http://www.hitachiserviceeu.com/support/guides/userguides.htm</u> |

NOTE • The information in this manual is subject to change without notice.

- The illustrations in this manual are for illustrative purposes. They may differ slightly from your projector.
- The manufacturer assumes no responsibility for any errors that may appear in this manual.
- The reproduction, transfer or copy of all or any part of this document is not permitted without express written consent.

Trademark acknowledgment

- Mac[®], Macintosh[®] and Mac OS[®] are registered trademarks of Apple Inc.
 - Pentium[®] is a registered trademark of Intel Corp.
 - Adobe[®] and Acrobat[®], Reader[®] are registered trademarks of Adobe Systems Incorporated.
 - Microsoft[®], Internet Explorer[®], Windows[®], Windows NT[®] and Windows Vista[®] are registered trademarks of Microsoft Corporation in the U.S. and/or other countries.
 - Blu-ray Disc[™] and Blu-ray[™] are trademarks of Blu-ray Disc Association.
- All other trademarks are the properties of their respective owners.

End User License Agreement for the Projector Software

- Software in the projector consists of the plural number of independent software modules and there exist our copyright or/and third party copyrights for each of such software modules.
- Be sure to read “End User License Agreement for the Projector Software” which is separated document. (in the CD)

| a Screen size (diagonal) | | 4 : 3 screen | | | | | | | | 16 : 9 screen | | | | | | | |
|--------------------------------|-----|--------------------------|------|------|------|---------------------|------|---------------------|------|--------------------------|------|------|------|---------------------|------|---------------------|------|
| | | b Projection distance | | | | c1 Screen height | | c2 Screen height | | b Projection distance | | | | c1 Screen height | | c2 Screen height | |
| | | min. | | max. | | cm | | inch | | min. | | max. | | cm | | inch | |
| type (inch) | m | m | inch | m | inch | cm | inch | cm | inch | m | inch | m | inch | cm | inch | cm | inch |
| 30 | 0.8 | 0.9 | 34 | 1.0 | 40 | 39 | 15 | 7 | 3 | 0.9 | 37 | 1.1 | 44 | 36 | 14 | 1 | 0 |
| 40 | 1.0 | 1.2 | 46 | 1.4 | 54 | 52 | 21 | 9 | 3 | 1.3 | 50 | 1.5 | 59 | 49 | 19 | 1 | 0 |
| 50 | 1.3 | 1.5 | 58 | 1.7 | 68 | 65 | 26 | 11 | 4 | 1.6 | 64 | 1.9 | 75 | 61 | 24 | 1 | 1 |
| 60 | 1.5 | 1.8 | 70 | 2.1 | 83 | 78 | 31 | 13 | 5 | 2.0 | 77 | 2.3 | 90 | 73 | 29 | 2 | 1 |
| 70 | 1.8 | 2.1 | 82 | 2.5 | 97 | 91 | 36 | 15 | 6 | 2.3 | 90 | 2.7 | 106 | 85 | 34 | 2 | 1 |
| 80 | 2.0 | 2.4 | 95 | 2.8 | 111 | 105 | 41 | 17 | 7 | 2.6 | 103 | 3.1 | 121 | 97 | 38 | 2 | 1 |
| 90 | 2.3 | 2.7 | 107 | 3.2 | 125 | 118 | 46 | 20 | 8 | 3.0 | 116 | 3.5 | 136 | 109 | 43 | 3 | 1 |
| 100 | 2.5 | 3.0 | 119 | 3.5 | 139 | 131 | 51 | 22 | 9 | 3.3 | 130 | 3.9 | 152 | 122 | 48 | 3 | 1 |
| 120 | 3.0 | 3.6 | 143 | 4.3 | 167 | 157 | 62 | 26 | 10 | 4.0 | 156 | 4.6 | 183 | 146 | 57 | 4 | 1 |
| 150 | 3.8 | 4.6 | 179 | 5.3 | 210 | 196 | 77 | 33 | 13 | 5.0 | 196 | 5.8 | 229 | 182 | 72 | 4 | 2 |
| 200 | 5.1 | 6.1 | 240 | 7.1 | 280 | 261 | 103 | 44 | 17 | 6.6 | 262 | 7.8 | 306 | 243 | 96 | 6 | 2 |
| 250 | 6.4 | 7.6 | 300 | 8.9 | 351 | 327 | 129 | 54 | 21 | 8.3 | 328 | 9.7 | 383 | 304 | 120 | 7 | 3 |
| 300 | 7.6 | 9.2 | 361 | 10.7 | 422 | 392 | 154 | 65 | 26 | 10.0 | 393 | 11.7 | 460 | 365 | 144 | 9 | 4 |

F-1

• On a horizontal surface

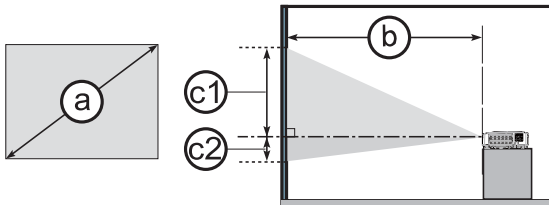

F-2

• Suspended from the ceiling

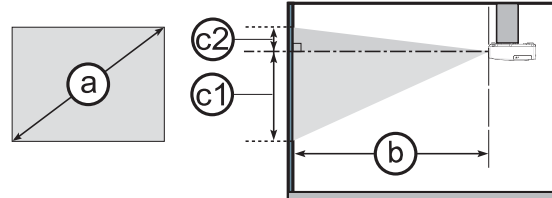

F-3

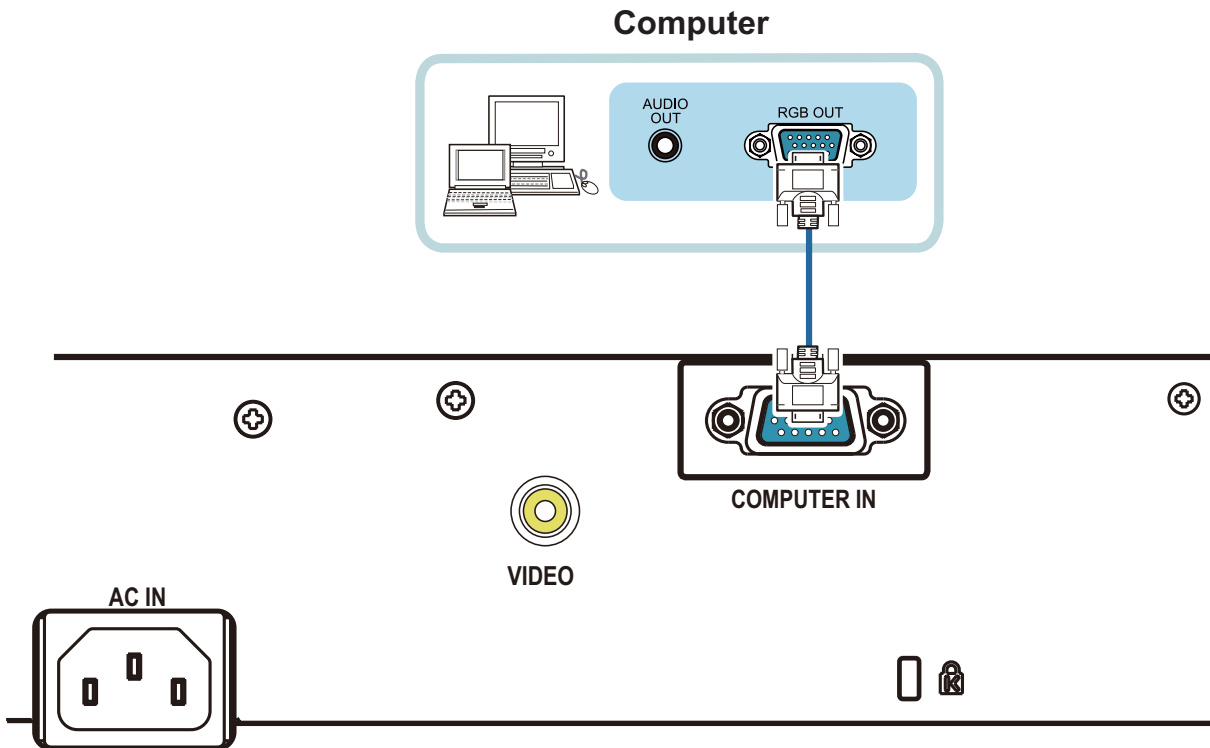

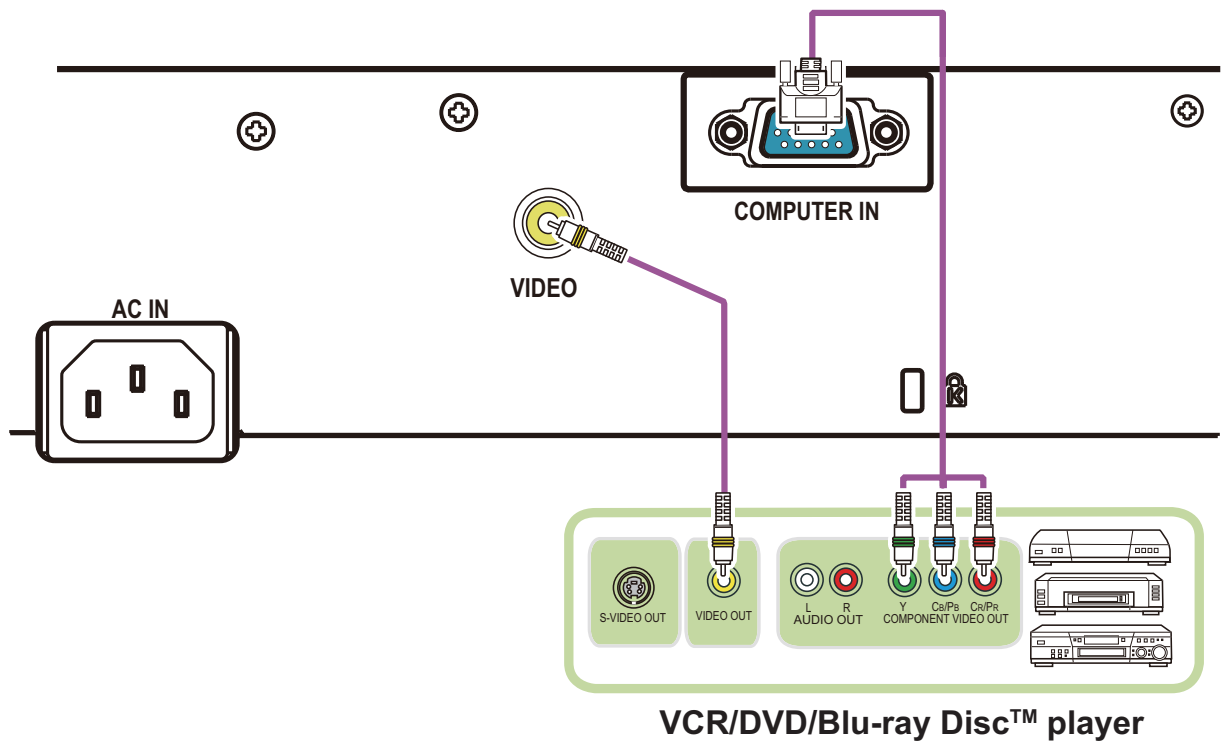

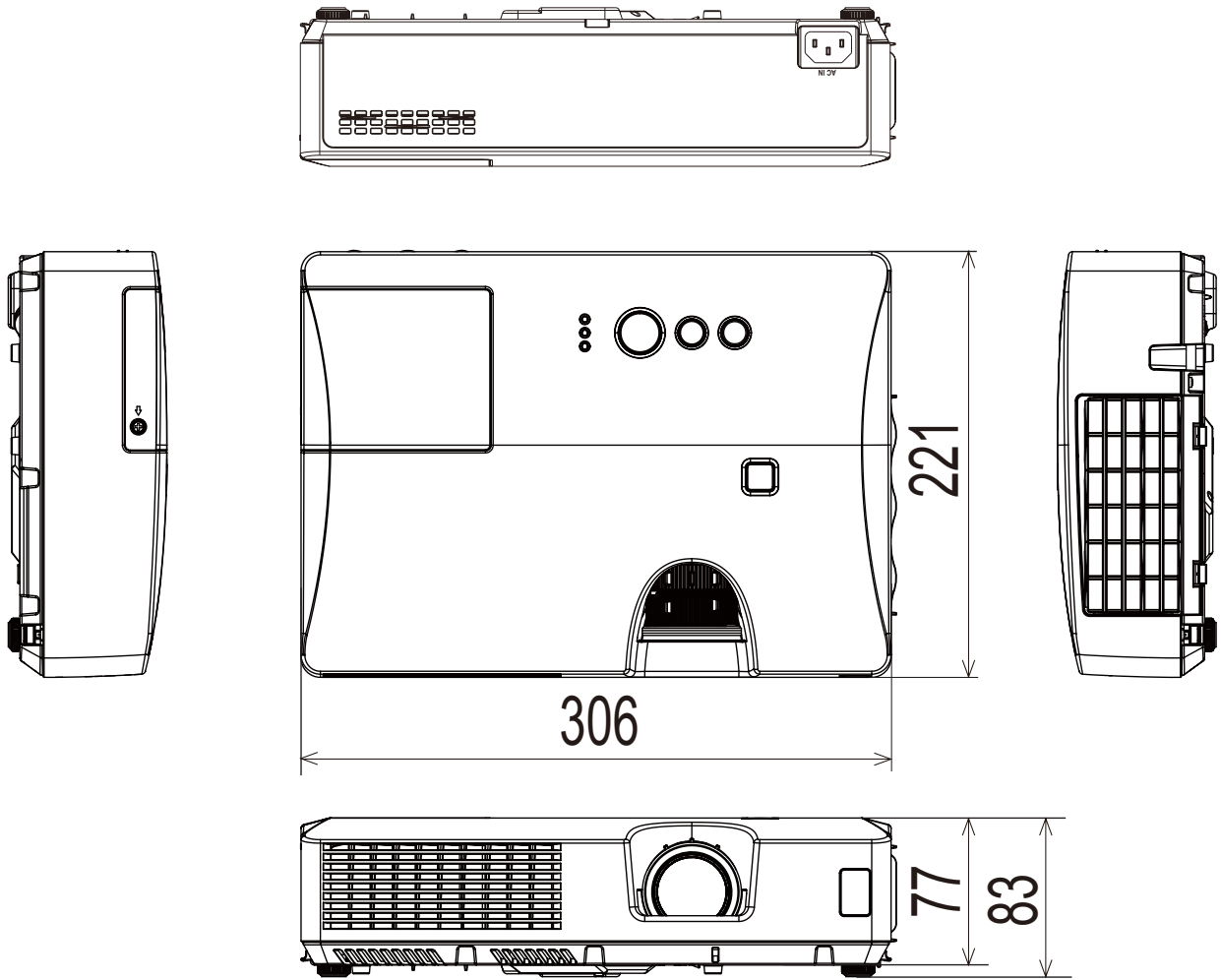

[unit: mm]

NOTE • The information in this manual is subject to change without notice. • The manufacturer assumes no responsibility for any errors that may appear in this manual. • The reproduction, transfer or copy of all or any part of this document is not permitted without express written consent.

REMARQUE • Les informations contenues dans ce manuel peuvent faire l'objet de changements sans avertissement préalable. • Le fabricant ne prend aucune responsabilité pour les erreurs qui pourraient se trouver dans ce manuel. • La reproduction, la transmission ou l'utilisation de ce document ou de son contenu est interdite sauf autorisation spéciale écrite.

HINWEIS • Die Informationen in diesem Handbuch können ohne vorherige Ankündigung geändert werden. • Der Hersteller übernimmt keine Verantwortung für etwaige in diesem Handbuch enthaltene Fehler. • Die Vervielfältigung, Übertragung oder Verwendung dieses Dokuments oder dessen Inhalts ist ohne ausdrückliche schriftliche Genehmigung nicht gestattet.

NOTA • La información de este manual puede sufrir modificaciones sin previo aviso. • El fabricante no asume ninguna responsabilidad por los errores que puedan aparecer en este manual. • No está permitida la reproducción, transmisión o utilización de este documento ni de su contenido sin autorización expresa por escrito.

NOTA • Le informazioni riportate in questo manuale sono soggette a modifica senza preavviso. • Il produttore declina qualsiasi responsabilità per eventuali errori che potrebbero comparire nel presente manuale. • E' vietata la riproduzione, la trasmissione o l'utilizzo del presente documento o del suo contenuto senza espressa autorizzazione scritta.

MERK • Informasjonen i denne håndboken kan endres uten varsel. • Produsenten påtar seg intet ansvar for eventuelle feil som fremkommer i denne håndboken. • Reproduksjon, overføring eller bruk av dette dokumentet eller deler av det, er ikke tillatt uten uttrykt skriftlig tillatelse.

OPMERKING • De informatie in deze handleiding kan zonder voorafgaande kennisgeving veranderd worden. • De fabrikant neemt geen enkele verantwoordelijkheid voor de eventuele fouten in deze handleiding. • Reproductie, overdracht of het gebruik van dit document is niet toegestaan, zonder uitdrukkelijke toestemming van de betreffende partij.

NOTA • As informações contidas neste manual estão sujeitas a alterações sem aviso prévio.
• O fabricante não se responsabiliza por quaisquer erros que possam surgir neste manual.
• A reprodução, transmissão ou utilização deste documento ou do seu conteúdo não é permitida sem autorização expressa por escrito.

通知事項 • 本书中刊载的内容有可能不经预告而发生变更。• 本产品的制造者对本书中的刊载错误不负任何责任。• 未经允许请勿复制、转载和使用本书的部分或全部内容。

알림 • 본서에 기재되어 있는 내용은 예고 없이 변경하는 일이 있습니다. • 본제품의 제조자는, 본서에 있어서의 기재 오류에 대해서 일절의 책임도 지지 않습니다. • 본서 내용의 일부 혹은 전부를 무단으로 복사하거나 전재하여 사용하는 것을 절대 금합니다.

NOTERA • Informationen i denna bruksanvisning kan komma att ändras utan förvarning. • Tillverkaren påtar sig inget ansvar för eventuella fel i denna bruksanvisning. • Återgivning, översändande eller användning av detta dokument eller dess innehåll är inte tillåten utan uttrycklig skriftligt medgivande.

ПРИМЕЧАНИЕ. • Содержание данного руководства может изменяться без предварительного уведомления. • Производитель не несет ответственности за ошибки в данном руководстве. • Воспроизведение, передача и использование данного документа или его содержания запрещено без письменного разрешения.

HUOM! • Tämän ohjekirjan tiedot voivat muuttua ilman eri ilmoitusta. • Valmistaja ei ota mitään vastuuta ohjekirjassa mahdollisesti olevista virheistä. • Dokumentin tai sen sisällön jäljentäminen, siirto tai käyttö ei ole sallittua ilmannimenomaista kirjallista valtuutusta.

UWAGA • Informacje podane w tym podręczniku mogą ulec zmianie bez uprzedzenia. • Producent nie ponosi odpowiedzialności za ewentualne błędy w podręczniku. • Powielanie, przesyłanie lub inne wykorzystanie tego dokumentu lub jego treści nie jest dozwolone bez wyraźnej pisemnej zgody.

HITACHI

Inspire the Next

Hitachi America, Ltd.

Digital Media Division
900 Hitachi way, Chula Vista
CA 91914-3556 **USA** **CANADA**
Tel: +1 -800-225-1741
► <http://www.hitachi-america.us/digitalmedia>

Hitachi Europe Ltd., Digital Media Group Consumer Affairs Department

Whitebrook Park, Lower Cookham Road,
Maidenhead
Berkshire SL6 8YA **UNITED KINGDOM**
Tel: 0844 481 0297
Email: consumer.mail@hitachi-eu.com

Hitachi Europe S.A.S., Digital Media Group

31 bis rue du 35ème Régiment de l'aviation
ZAC DU CHENE, 69500 BRON **FRANCE**
Tel: 043 742 8430
Email: france.consommateur@hitachi-eu.com

Hitachi Europe GmbH

Am Seestern 18
40547 Düsseldorf **GERMANY**
Tel: 0211-5283-801
Email: Service.germany@hitachi-eu.com

Hitachi Europe S.A.

364, Kifissias Ave. & 1, Delfon Str.
152 33 Chalandri
Athens **GREECE**
Tel: 210 6837200
Email: tech.assist@hitachi-eu.com

Hitachi Europe S.r.l.

Via T. Gulli, 39
20147 MILANO **ITALY**
Tel: +39 02 487861
Email: customerservice.italy@hitachi-eu.com

Hitachi Europe S.A.

Gran Via Carles III, 86 Planta 5ª
Edificios Trade - Torre Este
08028 Barcelona **SPAIN**
Tel: 0034 934 092 5 50
Email: Atencion.Cliente@hitachi-eu.com

Hitachi Europe AB

Frösundaviks Alle 15
169 29 Solna **SWEDEN**
Sweden Tel: +46 8 562 711 00
Finland Tel: +358 10 8503 085
Norway Tel: +47 9847 3898
Denmark Tel: +46 8 562 711 00
► <http://www.hitachidigitalmedia.com>

Hitachi Australia Pty Ltd.

Level 3, 82 Waterloo Road
North Ryde N.S.W 2113 **AUSTRALIA**
Tel: +61 -2-9888-4100
► <http://www.hitachi.com.au>

Hitachi (Hong Kong), Ltd.

18/F., Ever Gain Centre, 28 On Muk Street.,
Shatin, N.T. **HONG KONG**
Tel: +852 -2113-8883
► <http://www.hitachi-hk.com.hk>

Hitachi Sales (Malaysia) Sdn. Bhd.

Lot 12, Jalan Kamajuan, Bangi Industrial Estate,
43650 Bandar Baru Bangi, Selangor Darul Ehsan
MALAYSIA
Tel: +60 -3-8911-2670
► <http://www.hitachiconsumer.com.my>

Hitachi Home Electronics Asia (S) Pte. Ltd.

438A Alexandra Road #01-01/02/03
Alexandra Technopark, 119967 **SINGAPORE**
Tel: +65 -6536-2520
► <http://www.hitachiconsumer.com.sg>

Hitachi Sales Corp. of Taiwan

2nd Floor, No.65, Nanking East Road, Section 3,
Taipei 104 **TAIWAN**
Tel: +886-2-2516-0500
► <http://www.hsct.com.tw>

Hitachi Sales (Thailand), Ltd.

994, 996 Soi Thonglor, Sukhumvit 55 Rd.,
Klongtonnua, Vadhana, Bangkok 10110
THAILAND
Tel: +66 -2381-8381-98
► <http://www.hitachi-th.com>

Hitachi Consumer Electronics Co.,Ltd.

292 Yoshida-cho, Totsuka-ku
Yokohama 244-0817 **JAPAN**
Tel: +81-45-415-2625
► <http://www.hitachi.co.jp/proj/>