

Projector
CP-DX301
User Manual

Thank you for purchasing this product.
Please read this manual before you operate your projector.
Save it for future reference.

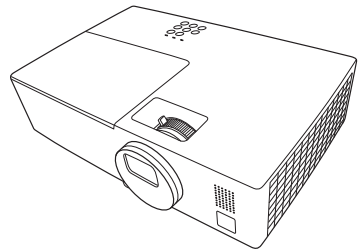



Table of contents

Important safety instructions	2
Introduction.....	4
Projector features	4
Shipping contents.....	5
Projector exterior view.....	6
Controls and functions	7
Positioning your projector.....	10
Choosing a location.....	10
Projection dimensions	11
Connection	12
Connecting a computer or monitor	13
Connecting Video source devices	14
Operation	17
Starting up the projector.....	17
Using the menus.....	18
Utilizing the password function	19
Switching input signal.....	21
Adjusting the projected image	22
Magnifying and searching for details.	23
Selecting the aspect ratio	24
Optimizing the image.....	26
Setting the presentation timer	29
Hiding the image.....	30
Locking control keys.....	30
Freezing the image.....	30
Operating in a high altitude environment	31
Shutting down the projector.....	31
Menu operation	32

Maintenance	41
Care of the projector	41
Lamp information	42
Troubleshooting	47
Specifications	48
Projector specifications.....	48
Dimensions	49
.....	49
Timing chart	50
Regulation Statements...54	
FCC statement	54
ICES-003	54
WEEE	54
Copyright information...56	
Warranty and after-service	57

Entries and graphical symbols explanation

The following entries and graphical symbols are used for the manuals and the product as follows, for safety purpose. Please know their meanings beforehand, and heed them.

 **WARNING:** This entry warns of a risk of serious personal injury or even death.



 **CAUTION:** This entry warns of a risk of personal injury or physical damage.

Important safety instructions

Your projector is designed and tested to meet the latest standards for safety of information technology equipment. However, to ensure safe use of this product, it is important that you follow the instructions mentioned in this manual and marked on the product.

Safety Instructions

WARNING

1. **Please read this manual before you operate your projector.** Save it for future reference.
2.  **Do not look straight at the projector lens during operation.** The intense light beam may damage your eyes.
3. **Refer servicing to qualified service personnel.**
4. In some countries, the line voltage is NOT stable. This projector is designed to operate safely within a mains voltage between 100 to 240 volts AC, but could fail if power cuts or surges of ± 10 volts occur. **In areas where the mains voltage may fluctuate or cut out, it is recommended that you connect your projector through a power stabilizer, surge protector or uninterruptible power supply (UPS).**
5.  Do not block the projection lens with any objects when the projector is under operation as this could cause the objects to become heated and deformed or even cause a fire. To temporarily turn off the display, press BLANK on the remote control.
6. The lamp becomes extremely hot during operation. Allow the projector to cool for approximately 45 minutes prior to removing the lamp assembly for replacement.
7. Never replace the lamp assembly or any electronic components unless the projector is unplugged.
8. Do not place this product on an unstable cart, stand, or table. The product may fall, sustaining serious damage.
9. Do not attempt to disassemble this projector. There are dangerous high voltages inside which may cause death if you should come into contact with live parts. The only user serviceable part is the lamp which has its own removable cover.
Under no circumstances should you ever undo or remove any other covers. Refer servicing only to suitably qualified professional service personnel.
10. Do not place this projector in any of the following environments.
 - Space that is poorly ventilated or confined. Allow at least 50 cm clearance from walls and free flow of air around the projector.
 - Locations where temperatures may become excessively high, such as the inside of a car with all windows rolled up.
 - Locations where excessive humidity, dust, or cigarette smoke may contaminate optical components, shortening the projector's life span and darkening the picture.
 - Locations near fire alarms
 - Locations with an ambient temperature above 40°C / 104°F
 - Locations where the altitudes are higher than 3050 m (10007 feet).
11. Do not block the ventilation holes. Otherwise the components inside the projector will become overheated and result in a fire or malfunction. In addition, do not place the projector in locations near an air conditioner, fan or dryer because direct contact with constant heat or warm air may cause deformation to the outer casing of the projector.

- Do not place this projector on a blanket, bedding or any other soft surface.
 - Do not cover this projector with a cloth or any other item.
 - Do not place inflammables near the projector.
12. Always place the projector on a level, horizontal surface during operation.
 - Do not use if tilted at an angle of more than 10 degrees left to right, nor at angle of more than 15 degrees front to back. Using the projector when it is not fully horizontal may cause a malfunction of, or damage to, the lamp.
 13. Do not stand the projector on end vertically. Doing so may cause the projector to fall over, causing injury or resulting in damage to the projector.
 14. Do not step on the projector or place any objects upon it. Besides probable physical damage to the projector, doing so may result in accidents and possible injury.
 15. Do not place liquids near or on the projector. Liquids spilled into the projector may cause it to fail. If the projector does become wet, disconnect it from the power supply's wall socket and call your local service center to have the projector serviced.
 16. When the projector is under operation, you may sense some heated air and odor from its ventilation grill. It is a normal phenomenon and not a product defect.
 17. Do not use the security lock slot for transporting or installation. It should be used with a commercially available theft prevention cable.

Introduction

Projector features

The projector integrates high-performance optical engine projection and a user-friendly design to deliver high reliability and ease of use.

The projector offers the following features.

- Presentation timer for better control of time during presentations
- Supports 3D display
- Color Management allowing color adjustments to your liking
- Less than 0.5W power consumption when standby mode is saving
- Wall Color correction allowing projection on surfaces of several predefined colors
- Quick auto search speeding up the signal detecting process
- Multiple sets of preset modes providing choices for different projection purposes
- One-key auto-adjustment to display the best picture quality
- Digital keystone correction to correct distorted images
- Adjustable color management control for data/video display
- High brightness projection lamp
- Ability to display 1.07 billion colors
- Multi-language On-Screen Display (OSD) menus
- Switchable normal and economic modes to reduce the power consumption
- Component HDTV compatibility (YPbPr)



- **The apparent brightness of the projected image will vary depending on the ambient lighting conditions, selected input signal contrast/brightness settings, and is directly proportional to projection distance.**
- **The lamp brightness will decline over time and may vary within the lamp manufacturers specifications. This is normal and expected behavior.**

Shipping contents

Carefully unpack and verify that you have all of the items shown below. If any of these items are missing, please contact your place of purchase.

Standard accessories

 The supplied accessories will be suitable for your region, and may differ from those illustrated.

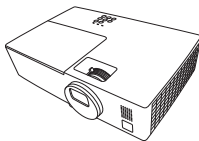

Projector

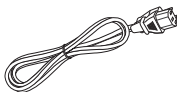

Power Cord

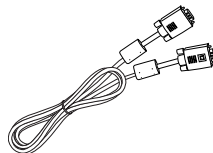

VGA Cable



Multi-language user manual CD



User manual



Remote Control & Battery



CU-TR Declaration

Optional accessories

1. Replacement lamp: DT01851
2. Ceiling mount: HAS-DX301

Projector exterior view

Front/upper side

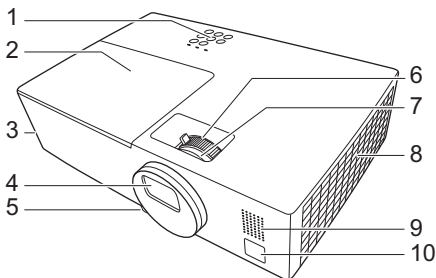

Rear/lower side

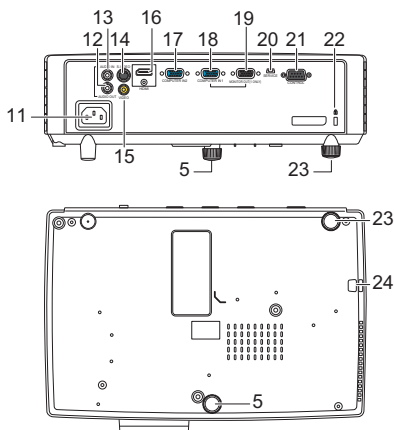

1. Control panel
(See "Control panel" on page 7 for details.)
2. Lamp cover
3. Vent (heated air exhaust)
4. Projection lens
5. Front elevator foot
6. Zoom ring
7. Focus ring
8. Vent (cool air intake)
9. Speaker
10. Front IR remote sensor
11. AC power cord inlet
12. AUDIO OUT port
13. AUDIO IN port
14. S-VIDEO port
15. VIDEO port
16. HDMI port
17. COMPUTER IN2 port
18. COMPUTER IN1 port
19. MONITOR OUT port
20. SERVICE port
21. CONTROL port
22. Security lock slot
23. Rear elevator foot
24. Name tag bar

WARNING

- **THIS APPARATUS MUST BE EARTHED.**
- **When installing the unit, incorporate a readily accessible disconnect device in the fixed wiring, or connect the power plug to an easily accessible socket-outlet near the unit. If a fault should occur during operation of the unit, operate the disconnect device to switch the power supply off, or disconnect the power plug.**

Controls and functions

Control panel

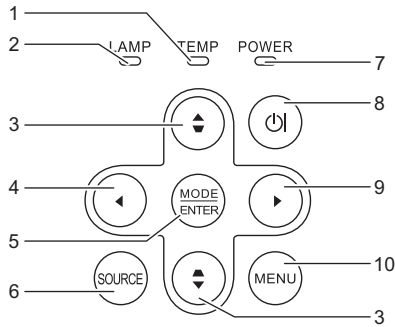

- 1. TEMPERATURE indicator light**
Lights up red if the projector's temperature becomes too high.
- 2. LAMP indicator light**
Indicates the status of the lamp. Lights up or flashes when the lamp has developed a problem.
- 3. Keystone/Arrow keys (▲▼Up, ▼▲Down)**
Manually corrects distorted images resulting from an angled projection.
- 4. ◀Left**
Used to hide the screen picture.
- 5. MODE/ENTER**
Selects an available picture setup mode. Enacts the selected On-Screen Display (OSD) menu item.
- 6. SOURCE**
Displays the source selection bar.
- 7. POWER indicator light**
Lights up or flashes when the projector is under operation.
- 8. ⏻**
Toggles the projector between standby mode and on.
- 9. ▶Right**
Activates panel key lock. When the On-Screen Display (OSD) menu is activated, the #3, #4, and #9 keys are used as directional arrows to select the desired menu items and to make adjustments.
- 10. MENU**
Turns on the On-Screen Display (OSD) menu. Goes back to previous OSD menu, exits and saves menu settings.

Remote control

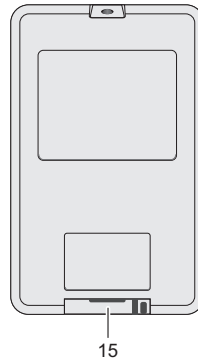
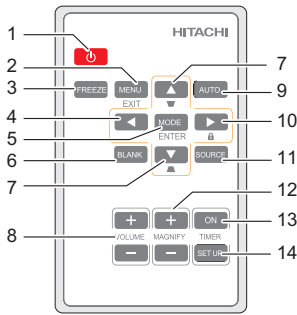

1. Toggles the projector between standby mode and on.
2. **MENU/EXIT**
Turns on the On-Screen Display (OSD) menu. Goes back to previous OSD menu, exits and saves menu settings.
3. **FREEZE**
Freezes the projected image.
4. **◀Left**
5. **MODE/ENTER**
Selects an available picture setup mode. Enacts the selected On-Screen Display (OSD) menu item.
6. **BLANK**
Used to hide the screen picture.
7. **Keystone/Arrow keys (▲▼Up, ▼▲Down)**
Manually corrects distorted images resulting from an angled projection.
8. **VOLUME (+, -)**
Adjusts the sound level.
9. **AUTO**
Automatically determines the best picture timings for the displayed image.
10. **▶Right**
Activates panel key lock. When the On-Screen Display (OSD) menu is activated, the #4, #7, and #10 keys are used as directional arrows to select the desired menu items and to make adjustments.
11. **SOURCE**
Displays the source selection bar.
12. **MAGNIFY (+, -)**
Magnifies or reduces the projected picture size.
13. **TIMER ON**
Activates or displays an on-screen timer based on your own timer setting.
14. **TIMER SET UP**
Enters presentation timer setting directly.
15. **Battery cover**

Remote control effective range

The Infra-Red (IR) remote control is located on the front of the projector. The remote control must be held at an angle within 30 degrees perpendicular to the projector's IR remote control sensor to function correctly. The distance between the remote control and the sensor should not exceed 4 meters (~ 13 feet).

Make sure that there are no obstacles between the remote control and the IR sensor on the projector that might obstruct the infra-red beam.

 **Remote control function may not work correctly, if the strong light or light from the inverter fluorescent lamp hits sensor window.**

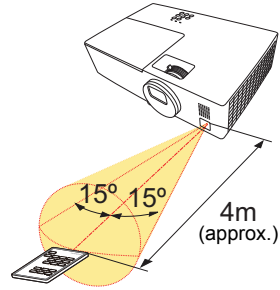

Replacing the remote control battery

1. Pull out the battery holder.

 **Please follow the illustrated instructions. Push and hold the locking arm while pulling out the battery holder.**

2. Insert the new battery in the holder. Note the positive polarity should face outward.
3. Push the holder into the remote control.



WARNING

Improper use may result in battery explosion, cracking or leakage, which could result in fire, injury and/or pollution of the surrounding environment. If you observe battery leakage, wipe out the leakage and then replace a battery. If the leakage adheres to your body or clothes, rinse well with water immediately.

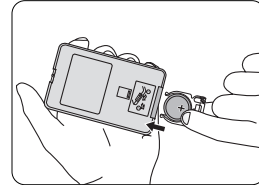
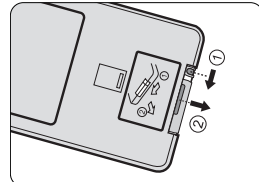

- **Keep the battery away from children and pets. Be careful for them not to swallow a battery.**
- **Avoid leaving the remote control and battery in an excessive heat or humid environment like the kitchen, bathroom, sauna, sunroom or in a closed car.**
- **Replace only with the same or equivalent type recommended by the battery manufacturer: [type: CR2025]**
- **Dispose of the used battery according to the manufacturer's instructions and local environment regulations for your region.**
- **Never throw the battery into a fire. There may be danger of an explosion.**
- **If the battery is dead or if you will not be using the remote control for an extended period of time, remove the battery to avoid damage to the remote control from possible battery leakage.**
- **Do not recharge, short circuit, solder or disassemble a battery.**

Positioning your projector

Choosing a location

Your room layout or personal preference will dictate which installation location you select. Take into consideration the size and position of your screen, the location of a suitable power outlet, as well as the location and distance between the projector and the rest of your equipment.

Your projector is designed to be installed in one of following possible installation locations:

1. Normal

Select this location with the projector placed near the floor in front of the screen. This is the most common way to position the projector for quick setup and portability.

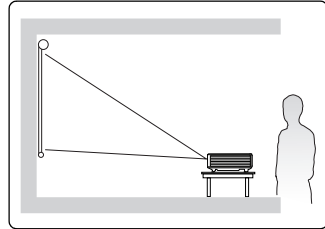

2. V Invert

Select this location with the projector suspended upside-down from the ceiling in front of the screen.

Note that a special rear projection screen is required.

Set **V Invert** in the **SYSTEM SETTING: BASIC > Mirror** menu after you turn the projector on.

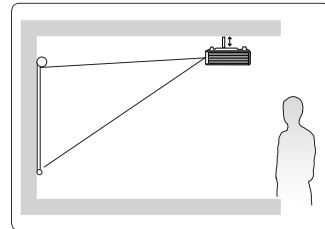

3. H Invert

Select this location with the projector placed near the floor behind the screen.

Note that a special rear projection screen is required.

Set **H Invert** in the **SYSTEM SETTING: BASIC > Mirror** menu after you turn the projector on.

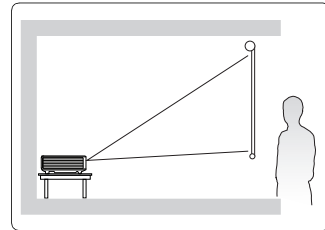

4. H & V Invert

Select this location with the projector suspended upside-down from the ceiling behind the screen.

Note that a special rear projection screen is required.

Set **H & V Invert** in the **SYSTEM SETTING: BASIC > Mirror** menu after you turn the projector on.

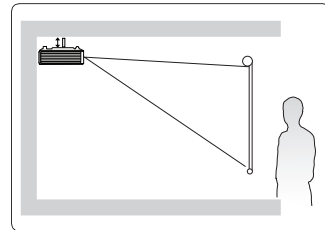

Projection dimensions

Refer to "[Dimensions](#)" on page 49 for the center of lens dimensions of this projector before calculating the appropriate position.

 The "screen" mentioned below refers to the projection screen usually consisting of a surface and a support structure.

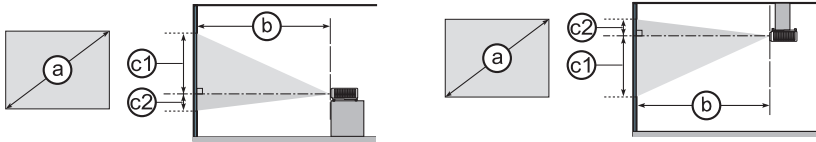

Zoom Ratio: 1.1 x

a: Screen size (Diagonal)		4:3 screen							
type (inch)	m	b: Projection distance				c1: Screen height		c2: Screen height	
		min.		max.		cm	inch	cm	inch
		m	inch	m	inch				
60	1.5	2.4	94	2.6	103	91	36	-9	-4
70	1.8	2.8	110	3.1	120	107	42	-11	-4
80	2.0	3.2	125	3.5	138	122	48	-12	-5
90	2.3	3.6	141	3.9	155	137	54	-14	-5
100	2.5	4.0	156	4.4	172	152	60	-15	-6
120	3.0	4.8	188	5.2	207	183	72	-18	-7
150	3.8	6.0	235	6.6	258	229	90	-23	-9
200	5.1	7.9	313	8.7	344	305	120	-30	-12
250	6.4	9.9	391	10.9	430	381	150	-38	-15

a: Screen size (Diagonal)		16:9 screen							
type (inch)	m	b: Projection distance				c1: Screen height		c2: Screen height	
		min.		max.		cm	inch	cm	inch
		m	inch	m	inch				
60	1.5	2.6	102	2.9	113	100	39	-25	-10
70	1.8	3.0	119	3.3	131	116	46	-29	-11
80	2.0	3.5	136	3.8	150	133	52	-33	-13
90	2.3	3.9	153	4.3	169	150	59	-37	-15
100	2.5	4.3	171	4.8	188	166	65	-42	-16
120	3.0	5.2	205	5.7	225	199	78	-50	-20
150	3.8	6.5	256	7.1	281	249	98	-62	-25
200	5.1	8.7	341	9.5	375	332	131	-83	-33
250	6.4	10.8	426	11.9	469	415	164	-104	-41

-  There is 3% tolerance among these numbers due to optical component variations. It is recommended that if you intend to permanently install the projector, you should physically test the projection size and distance using the actual projector in situ before you permanently install it, so as to make allowance for this projector's optical characteristics. This will help you determine the exact mounting position so that it best suits your installation location.
- To obtain the clearest image possible, we suggest that you keep the desired image size within 60" to 180".

Connection

When connecting a signal source to the projector, be sure to:

1. Turn all equipment off before making any connections.
2. Use the correct signal cables for each source.
3. Ensure the cables are firmly inserted.

 In the connections shown below, some cables may not be included with the projector (see **"Shipping contents"** on page 5). They are commercially available from electronics stores.

- The connection illustrations below are for reference only. The rear connecting ports available on the projector vary with each projector model.
- For detailed connection methods, see pages 13-16.

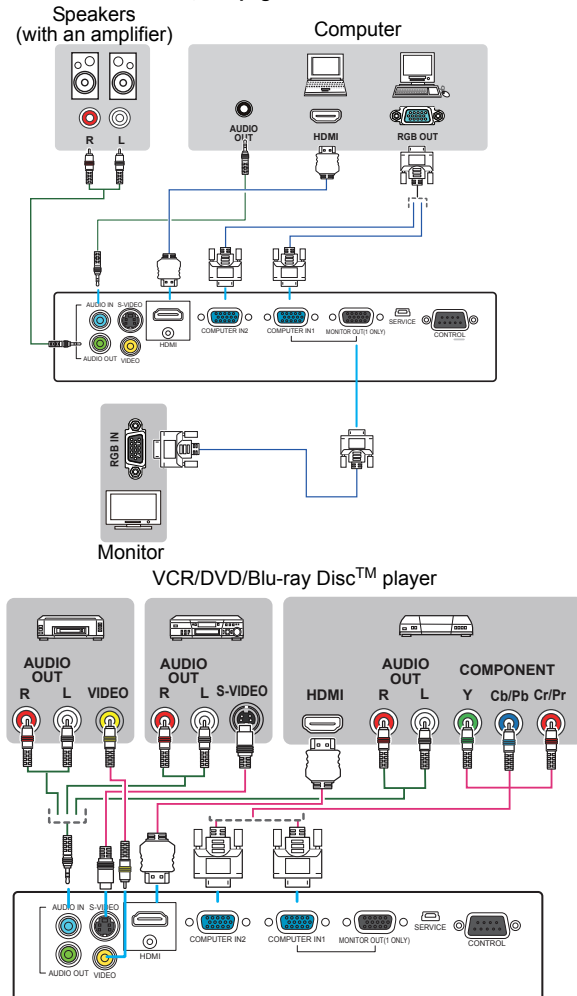

Connecting a computer or monitor

Connecting a computer

The projector provides two VGA input sockets that allow you to connect them to both IBM® compatibles and Macintosh® computers. A Mac adapter is needed if you are connecting legacy version Macintosh computers.

To connect the projector to a notebook or desktop computer:

1. Take the supplied VGA cable and connect one end to the D-Sub output socket of the computer.
2. Connect the other end of the VGA cable to the **COMPUTER IN1** or **COMPUTER IN2** signal input socket on the projector.



Many notebooks do not turn on their external video ports when connected to a projector. Usually a key combo like FN + F3 or CRT/LCD key turns the external display on/off. Locate a function key labeled CRT/LCD or a function key with a monitor symbol on the notebook. Press FN and the labeled function key simultaneously. Refer to your notebook's documentation to find your notebook's key combination.

Connecting a monitor

If you want to view your presentation close-up on a monitor as well as on the screen, you can connect the **MONITOR OUT** signal output socket on the projector to an external monitor with a VGA cable following the instructions below:

To connect the projector to a monitor:

1. Connect the projector to a computer as described in "[Connecting a computer](#)" on page 13.
2. Take a suitable VGA cable (only one supplied) and connect one end of the cable to the D-Sub input socket of the video monitor.
Or if your monitor is equipped with a DVI input socket, take a VGA to DVI-A cable and connect the DVI end of the cable to the DVI input socket of the video monitor.
3. Connect the other end of the cable to the **MONITOR OUT** socket on the projector.



The MONITOR OUT output only works when COMPUTER IN1 connection is made to the projector.

Connecting Video source devices

You can connect your projector to various Video source devices that provide any one of the following output sockets:

- HDMI
- Component Video
- S-Video
- Video (composite)

You need only connect the projector to a Video source device using just one of the above connecting methods, however each provides a different level of video quality. The method you choose will most likely depend upon the availability of matching terminals on both the projector and the Video source device as described below:

Best video quality

The best available video connection method is HDMI. If your source device is equipped with a HDMI socket, you can enjoy uncompressed digital video quality.

See ["Connecting an HDMI device" on page 15](#) for how to connect the projector to a HDMI source device and other details.

If no **HDMI** source is available, the next best video signal is Component video (not to be confused with composite video). Digital TV tuner and DVD players output Component video natively, so if available on your devices, this should be your connection method of choice in preference to (composite) video.

See ["Connecting a Component Video source device" on page 15](#) for how to connect the projector to a component video device.

Better video quality

The S-Video method provides a better quality analog video than standard composite Video. If you have both composite Video and S-Video output terminals on your Video source device, you should elect to use the S-Video option.

See ["Connecting an S-Video source device" on page 16](#) for how to connect the projector to an S-Video device.

Least video quality

Composite Video is an analog video and will result in a perfectly acceptable, but less than optimal result from your projector, being the least video quality of the available methods described here.

See ["Connecting a composite Video source device" on page 16](#) for how to connect the projector to a composite Video device.

Connecting audio

The projector has one built-in mono speaker which is designed to provide basic audio functionality accompanying data presentations for business purposes only. It is not designed for, nor intended for stereo audio reproduction use as might be expected in home theater or home cinema applications. Any stereo audio input (if provided), is mixed into a common mono audio output through the projector speaker.

If you wish, you can make use of the projector (mixed mono) speaker in your presentations, and also connect separate amplified speakers to the Audio Out socket of the projector. The audio output is a mixed mono signal and controlled by the projector Volume and Mute settings.

If you have a separate sound system, you will most likely want to connect the audio output of your Video source device to that sound system, instead of to the mono audio projector.

-  • **The audio output only works when a signal source is connected to the projector.**
- **When an audio cable is connected to the AUDIO OUT port, the projector's speaker will be muted.**

Connecting an HDMI device

You should use an HDMI cable when making connection between the projector and HDMI devices.

To connect the projector to an HDMI device:

1. Take an HDMI cable and connect one end to the HDMI output port of the video device.
2. Connect the other end of the cable to the **HDMI** input port on the projector.

-  **The projector is only capable of playing mixed mono audio. See ["Connecting audio" on page 14](#) for details.**

Connecting a Component Video source device

Examine your Video source device to determine if it has a set of unused Component Video output sockets available:

- If so, you can continue with this procedure.
- If not, you will need to reassess which method you can use to connect to the device.

To connect the projector to a Component Video source device:

1. Take a VGA (D-Sub)-Component adaptor cable and connect the end with 3 RCA type connectors to the Component Video output sockets of the Video source device. Match the color of the plugs to the color of the sockets; green to green, blue to blue, and red to red.
2. Connect the other end of the VGA (D-Sub)-Component adaptor cable (with a D-Sub type connector) to the **COMPUTER IN1** or **COMPUTER IN2** socket on the projector.

-  • **The projector is only capable of playing mixed mono audio, even if a stereo audio input is connected. See ["Connecting audio" on page 14](#) for details.**
- **If the selected video image is not displayed after the projector is turned on and the correct video source has been selected, check that the Video source device is turned on and operating correctly. Also check that the signal cables have been connected correctly.**

Connecting an S-Video source device

Examine your Video source device to determine if it has an unused S-Video output socket available:

- If so, you can continue with this procedure.
- If not, you will need to reassess which method you can use to connect to the device.

To connect the projector to an S-Video source device:

1. Take an S-Video cable and connect one end to the S-Video output socket of the Video source device.
2. Connect the other end of the S-Video cable to the **S-VIDEO** socket on the projector.



- **The projector is only capable of playing mixed mono audio, even if a stereo audio input is connected. See "Connecting audio" on page 14 for details.**
- **If the selected video image is not displayed after the projector is turned on and the correct video source has been selected, check that the Video source device is turned on and operating correctly. Also check that the signal cables have been connected correctly.**
- **If you have already made a Component Video connection between the projector and this S-Video source device using Component Video connections, you need not connect to this device using an S-Video connection as this makes an unnecessary second connection of poorer picture quality. See "Connecting Video source devices" on page 14 for details.**

Connecting a composite Video source device

Examine your Video source device to determine if it has a set of unused composite Video output sockets available:

- If so, you can continue with this procedure.
- If not, you will need to reassess which method you can use to connect to the device.

To connect the projector to a composite Video source device:

1. Take a Video cable and connect one end to the composite Video output socket of the Video source device.
2. Connect the other end of the Video cable to the **VIDEO** socket on the projector.





- **The projector is only capable of playing mixed mono audio, even if a stereo audio input is connected. See "Connecting audio" on page 14 for details.**
- **If the selected video image is not displayed after the projector is turned on and the correct video source has been selected, check that the Video source device is turned on and operating correctly. Also check that the signal cables have been connected correctly.**
- **You need only connect to this device using a composite Video connection if Component Video and S-Video inputs are unavailable for use. See "Connecting Video source devices" on page 14 for details.**

Operation

Starting up the projector

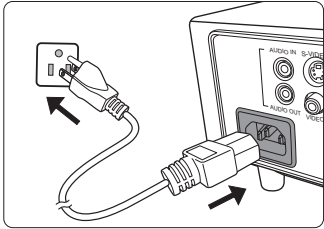
1. Plug the power cord into the projector and into a wall socket. Turn on the wall socket switch (where fitted).
2. Press  on the projector or remote control to start the projector. The **POWER indicator light** stays blue when the projector is on.
(If necessary) Rotate the focus ring to adjust the image clearness.



-  **If the projector is still hot from previous activity, it will run the cooling fan for approximately 60 seconds before energizing the lamp.**
- To maintain the lamp life, once you turn the projector on, wait at least 5 minutes before turning it off.**
- Also, do not turn the projector on for about 10 minutes or more after turning off.**

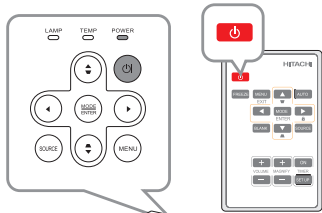

3. If the projector is activated for the first time, select your OSD language and **High Altitude Mode** following the on-screen instructions.

Language

See "[Using the menus](#)" on page 18 for details.

High Altitude Mode

See "[Operating in a high altitude environment](#)" on page 31 for details.

4. Switch all of the connected equipment on.
5. The projector will start to search for input signals. The current input signal being scanned appears in the upper left corner of the screen. If the projector doesn't detect a valid signal, the message 'No Signal' will continue to be displayed until an input signal is found.

You can also press **SOURCE** on the projector or remote control to select your desired input signal. See "[Switching input signal](#)" on page 21 for details.

-  **If the frequency/resolution of the input signal exceeds the projector's operating range, you will see the message 'Out of Range' displayed on a blank screen. Please change to an input signal which is compatible with the projector's resolution or set the input signal to a lower setting. See "[Timing chart](#)" on page 50 for details.**
- OSD languages and user manual languages may not match.**

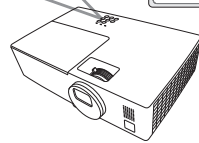

Using the menus

The projector is equipped with On-Screen Display (OSD) menus for making various adjustments and settings.

 The OSD screenshots below are for reference only, and may differ from the actual design.

Below is the overview of the OSD menu.

Main menu icon

Highlight

Sub-menu

Current input signal

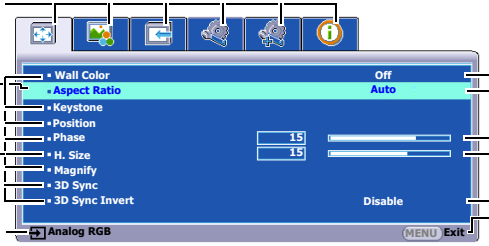

Status

Go to the previous page or to exit.

To use the OSD menus, please set them to your familiar language first.

1. Press **MENU** on the projector or **MENU/EXIT** on the remote control to turn the OSD menu on.

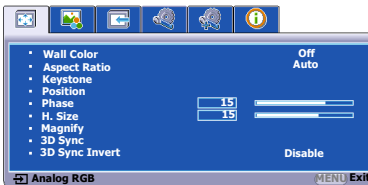



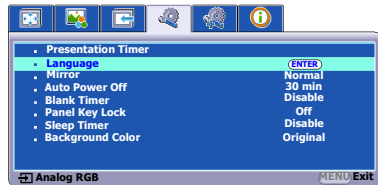

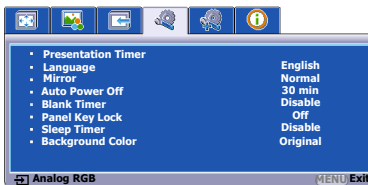

3. Press **▼** to highlight **Language** and press **MODE/ENTER**.



2. Use **◀▶** to highlight the **SYSTEM SETTING: Basic** menu.



4. Press **◀/▲/▼/▶** to select a preferred language and press **MODE/ENTER**.
5. Press **MENU** on the projector or **MENU/EXIT** on the remote control to leave and save the settings.

	: DISPLAY		: SYSTEM SETTING: Basic
	: PICTURE		: SYSTEM SETTING: Advanced
	: SOURCE		: INFORMATION

Utilizing the password function

For security purposes and to help prevent unauthorized use, the projector includes an option for setting up password security. The password can be set through the On-Screen Display (OSD) menu. For details of the OSD menu operation, please refer to "Using the menus" on page 18.

 You will be inconvenienced if you activate the password functionality and subsequently forget the password. Print this user manual (if necessary) and write the password you used in this manual, and keep it in a safe place for later use.

Setting a password

1. Open the OSD menu and go to the **SYSTEM SETTING: Advanced > Security Settings** menu. Press **MODE/ENTER** on the projector or remote control. The **Security Settings** page is displayed.
2. Highlight **Change Password** and press **MODE/ENTER**.
3. As pictured to the right, the four arrow keys

(**◀, ▲, ▼, ▶**) respectively represent 4 digits (1, 2, 3, 4). According to the password you desire to set, press the arrow keys to enter six digits for the password.

4. Confirm the new password by re-entering the new password.

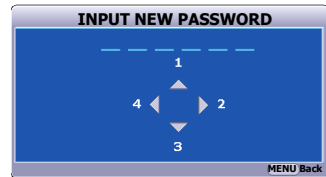

Once the password is set, the OSD menu returns to the **Security Settings** page.

5. To activate the **Power on Lock** function, press **▲/▼** to highlight **Power on Lock** and press **◀▶** to select **On**. When the **Power on Lock** function is activated, you have to enter the correct password to turn on the projector.
6. To leave the OSD menu, press **MENU** on the projector or **MENU/EXIT** on the remote control.

-  • **Once a password has been set, the projector cannot be used unless the correct password is entered every time the projector is started.**
- **The digits being input will be displayed as asterisks on-screen. Write your selected password down here in this user manual in advance or right after the password is entered so that it is available to you should you ever forget it.**
Password: _ _ _ _ _ _
Keep this user manual in a safe place.

If you forget the password

If the password function is activated, you will be asked to enter the six-digit password every time you turn on the projector. If you enter the wrong password, the password error message as pictured to the right is displayed lasting for three seconds, and the message 'INPUT PASSWORD' follows. You can retry by entering another six-digit password, or if you did not record the password in this user manual, and you absolutely do not remember it, you can use the password recall procedure. See "Entering the password recall procedure" on page 20 for details.

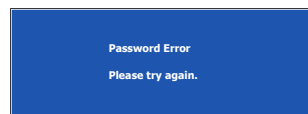

If you enter an incorrect password 5 times in succession, the projector will automatically shut down in a short time.

Entering the password recall procedure

1. Press and hold **AUTO** on the remote control for 3 seconds. The projector will display a coded number on the screen.
2. Write down the number and turn off your projector.
3. Seek help from the local dealer to decode the number. You may be required to provide proof of purchase documentation to verify that you are an authorized user of the projector.



Changing the password

1. Open the OSD menu and go to the **SYSTEM SETTING: Advanced > Security Settings > Change Password** menu.
2. Press **MODE/ENTER** on the projector or remote control. The message '**INPUT CURRENT PASSWORD**' is displayed.
3. Enter the old password.
 - If the password is correct, another message '**INPUT NEW PASSWORD**' is displayed.
 - If the password is incorrect, the password error message is displayed lasting for three seconds, and the message '**INPUT CURRENT PASSWORD**' is displayed for your retry. You can press **MENU** on the projector or **MENU/EXIT** on the remote control to cancel the change or try another password.
4. Enter a new password.
5. Confirm the new password by re-entering the new password.
6. You have successfully assigned a new password to the projector. Remember to enter the new password next time the projector is started.
7. To leave the OSD menu, press **MENU** on the projector or **MENU/EXIT** on the remote control.

 The digits being input will be displayed as asterisks on-screen. Write your selected password down here in this user manual in advance or right after the password is entered so that it is available to you should you ever forget it.

Password: _____

Keep this user manual in a safe place.

Disabling the password function

To disable password protection, go back to the **SYSTEM SETTING: Advanced > Security Settings > Power on Lock** menu after opening the OSD menu system. Select **Off** by pressing **◀/▶**. The message 'INPUT PASSWORD' is displayed. Enter the current password.

- If the password is correct, the OSD menu returns to the **Security Settings** page with 'Off' shown in the row of **Power on Lock**. You will not have to enter the password next time you turn on the projector.
- If the password is incorrect, the password error message is displayed lasting for three seconds, and the message 'INPUT PASSWORD' is displayed for your retry. You can press **MENU** on the projector or **MENU/EXIT** on the remote control to cancel the change or try another password.

 **Though the password function is disabled, you need to keep the old password in hand should you ever need to re-activate the password function by entering the old password.**

Switching input signal

The projector can be connected to multiple devices at the same time. However, it can only display one full screen at a time.

Be sure the **Quick Auto Search** function in the **SOURCE** menu is **On** if you want the projector to automatically search for the signals.

You can also manually select the desired signal by pressing one of the source selection keys on the remote control, or cycle through the available input signals. Once you have done this, the **Quick Auto Search** function will be turned off automatically.

1. Press **SOURCE** on the projector or remote control. A source selection bar is displayed.
2. Press **▲/▼** until your desired signal is selected and press **MODE/ENTER** on the projector or remote control.
Once detected, the selected source information will be displayed on the screen for seconds. If there are multiple devices connected to the projector, repeat steps 1-2 to search for another signal.

-  • **The brightness level of the projected image will change accordingly when you switch between different input signals. Data (graphic) "computer" presentations using mostly static images are generally brighter than "Video" using mostly moving images (movies).**
- **The input signal type effects the options available for the Preset Mode. See "Selecting a preset mode" on page 26 for details.**
 - **Please see "Projector specifications" on page 48 for the native display resolution of this projector. For best display picture results, you should select and use an input signal which outputs at this resolution. Any other resolutions will be scaled by the projector depending upon the 'aspect ratio' setting, which may cause some image distortion or loss of picture clarity. See "Selecting the aspect ratio" on page 24 for details.**

Adjusting the projected image

Adjusting the projection angle

The projector is equipped with two adjuster feet. They change the image height and vertical projection angle. Screw the adjuster feet to fine tune the angle until the image is positioned where you want it.

If the projector is not placed on a flat surface or the screen and the projector are not perpendicular to each other, the projected image becomes trapezoidal. To correct this situation, see "[Correcting keystone](#)" on page 23 for details.

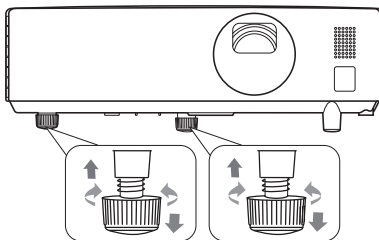

CAUTION



Do not look into the lens while the lamp is on. The strong light from the lamp may cause damage to your eyes.



Be careful when you screw the front adjuster foot as it is close to the exhaust vent where hot air comes from.

Auto-adjusting the image

In some cases, you may need to optimize the picture quality. To do this, press **AUTO** on the remote control or activate the **Auto Adjustment** function in the **SOURCE** menu. Within 3 seconds, the built-in Intelligent Auto Adjustment function will re-adjust the values of Frequency and Clock to provide the best picture quality.

The current source information will be displayed in the upper left corner of the screen for 3 seconds.



- The screen will be blank while **AUTO** is functioning.
- This function is only available when computer signal (analog RGB) is selected.

Fine-tuning the image clarity

1. Adjust the projected image to the size that you need using the zoom ring.
2. If necessary, sharpen the image by rotating the focus ring.

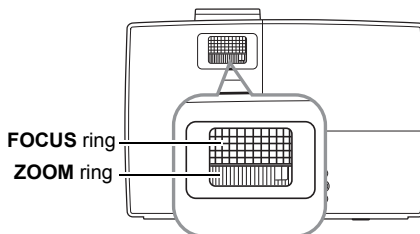

Correcting keystone

Keystoning refers to the situation where the projected image is noticeably wider at either the top or bottom. It occurs when the projector is not perpendicular to the screen.

To correct this, besides adjusting the height of the projector, you will need to manually correct it following one of these steps.

- Press **▼/▲** on the projector or remote control to display the Keystone correction page. Press **▲** to correct keystoning at the top of the image. Press **▼** to correct keystoning at the bottom of the image.
- Using the OSD menu



1. Press **MENU** on the projector or **MENU/EXIT** on the remote control and then press **◀▶** until the **DISPLAY** menu is highlighted.
2. Press **▼** to highlight **Keystone** and press **MODE/ENTER** on the projector or remote control. The **Keystone** correction page is displayed.
3. Press **▲** to correct keystoning at the top of the image or press **▼** to correct keystoning at the bottom of the image.

Magnifying and searching for details

If you need to find the details on the projected picture, magnify the picture. Use the direction arrow keys for navigating the picture.

- Using the remote control
 1. Press **Magnify + /Magnify -** on the remote control to display the Zoom bar.
 2. Press **Magnify +** on the remote control or **▲** on the projector repeatedly to magnify the picture to a desired size.
 3. To navigate the picture, press the directional arrows (**◀, ▲, ▼, ▶**).
 4. To reduce size of the picture, press **Magnify -** on the remote control, or **▼** on the projector. You can also restore the picture to its original size by pressing the **AUTO** button on the remote control.
- Using the OSD menu
 1. Press **MENU** on the projector or **MENU/EXIT** on the remote control and then press **◀▶** until the **DISPLAY** menu is highlighted.
 2. Press **▼** to highlight **Magnify** and press **MODE/ENTER** on the projector remote control. The Zoom bar is displayed.
 3. Repeat steps 2-4 in the section of [Using the remote control](#) above.

 **The picture can only be navigated after the picture is magnified. You can further magnify the picture while searching for details.**

Selecting the aspect ratio

The 'aspect ratio' is the ratio of the image width to the image height. Most analog TV and computers are in 4:3 ratio, and digital TV and DVDs are usually in 16:9 ratio.

With the advent of digital signal processing, digital display devices like this projector can dynamically stretch and scale the image output to a different aspect than that of the image input signal.

To change the projected image ratio (no matter what aspect the source is):

1. Press **MENU** on the projector or **MENU/EXIT** on the remote control and then press **◀▶** until the **DISPLAY** menu is highlighted.
2. Press **▼** to highlight **Aspect Ratio**.
3. Press **◀▶** to select an aspect ratio to suit the format of the video signal and your display requirements.

About the aspect ratio

 In the pictures below, the black portions are inactive areas and the white portions are active areas. OSD menus can be displayed on those unused black areas.

1. **Auto:** Scales an image proportionally to fit the projector's native resolution in its horizontal width. This is suitable for the incoming image which is neither in 4:3 nor 16:9 and you want to make most use of the screen without altering the image's aspect ratio.

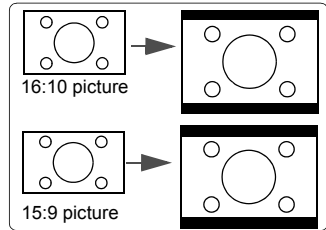

2. **Real:** The image is projected as its original resolution, and resized to fit within the display area. For input signals with lower resolutions, the projected image will display smaller than if resized to full screen. You could adjust the zoom setting or move the projector towards the screen to increase the image size if necessary. You may also need to refocus the projector after making these adjustments.

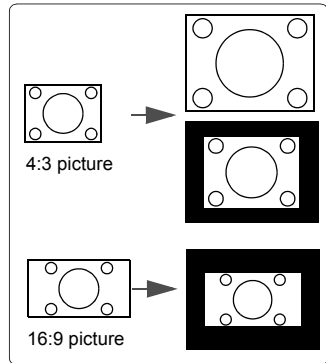

3. **4:3:** Scales an image so that it is displayed in the center of the screen with a 4:3 aspect ratio. This is most suitable for 4:3 images like computer monitors, standard definition TV and 4:3 aspect DVD movies, as it displays them without aspect alteration.

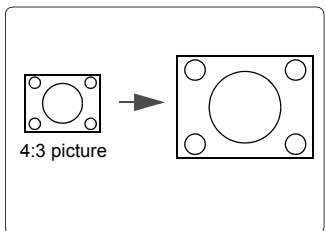

4. **16:9:** Scales an image so that it is displayed in the center of the screen with a 16:9 aspect ratio. This is most suitable for images which are already in a 16:9 aspect, like high definition TV, as it displays them without aspect alteration.

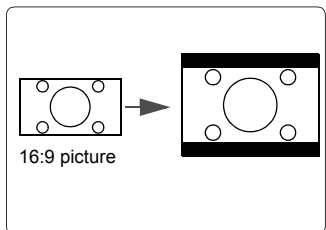

Optimizing the image

Selecting a preset mode

The projector is preset with several predefined preset modes so that you can choose one to suit your operating environment and input signal picture type.

To select an operation mode that suits your need, you can follow one of the following steps.

- Press **MODE/ENTER** on the projector remote control repeatedly until your desired mode is selected.
- Go to the **PICTURE > Preset Mode** menu and press ◀▶ to select a desired mode.

The preset modes available for different types of signals are listed below.

1. **Bright mode:** Maximizes the brightness of the projected image. This mode is suitable for environments where extra-high brightness is required, such as using the projector in well lit rooms.
2. **Presentation mode:** Is designed for presentations under daylight environment to match computer and notebook computer coloring.
3. **sRGB mode:** Maximizes the purity of RGB colors to provide true-to-life images regardless of brightness setting. It is most suitable for viewing photos taken with an sRGB compatible and properly calibrated camera, and for viewing computer graphic and drawing applications.
4. **Cinema mode:** Is appropriate for playing colorful movies, video clips from digital cameras or DVs through the computer input for best viewing in a blackened (little light) environment.
5. **Game mode:** Suitable for all types of entertainment media, including gaming and movies.
6. **User mode:** Recalls the settings customized based on the current available preset modes. See "[Setting the User mode](#)" on page 26 for details.

Setting the User mode

1. Press **MENU** on the projector or **MENU/EXIT** on the remote control to open the On-Screen Display (OSD) menu.
2. Go to the **PICTURE > Preset Mode** menu.
3. Press ◀▶ to select **User**. The adjustments you make in the **Brightness, Contrast, Color, Tint, Sharpness, Brilliant Color, Color Temperature** and **3D Color Management** will automatically be saved as the **User** mode.

Fine-tuning the image quality in user modes

According to the detected signal type, there are some user-definable functions available when **User** mode is selected. You can make adjustments to these functions based on your needs.

Adjusting Brightness

Highlight the **PICTURE > Brightness** menu and press ◀▶.

The higher the value, the brighter the image. And the lower the setting, the darker the image. Adjust this control so the black areas of the image appear just as black and that detail in the dark areas is visible.



Adjusting Contrast

Highlight the **PICTURE** > **Contrast** menu and press ◀▶.

The higher the value, the greater the contrast. Use this to set the peak white level after you have previously adjusted the **Brightness** setting to suit your selected input and viewing environment.



Adjusting Color

Highlight the **PICTURE** > **Color** menu and press ◀▶.

Lower setting produces less saturated colors. If the setting is too high, colors on the image will be overpowering, which makes the image unrealistic.

 This function is only available when a **Video, S-Video or Component Video** signal is selected.

Adjusting Tint

Highlight the **PICTURE** > **Tint** menu and press ◀▶.

The higher the value, the more reddish the picture becomes. The lower the value, the more greenish the picture becomes.

 This function is only available when a **Video, S-Video with NTSC** signal is selected.

Adjusting Sharpness

Highlight the **PICTURE** > **Sharpness** menu and press ◀▶.

The higher the value, the sharper the picture becomes. The lower the value, the softer the picture becomes.

 This function is only available when a **Video, S-Video or Component Video** signal is selected.

Adjusting Brilliant Color

Highlight the **PICTURE** > **Brilliant Color** menu and press ◀▶.

This feature utilizes a new color-processing algorithm and system level enhancements to enable higher brightness while providing truer, more vibrant colors in the projected picture. It enables a greater than 50% brightness increase in mid-tone images, which are common in video and natural scenes, so the projector reproduces images in realistic and true colors. If you prefer images with that quality, select **On**. If you don't need it, select **Off**.

When **Off** is selected, the **Color Temperature** and **3D Color Management** functions are not available.

Selecting a Color Temperature

Highlight the **PICTURE** > **Color Temperature** menu and press ◀▶.

The options available for color temperature* settings vary according to the signal type selected.

1. **Cool:** Makes images appear bluish white.
2. **Normal:** Maintains normal colorings for white.
3. **Warm:** Makes images appear reddish white.

*About color temperatures:

There are many different shades that are considered to be "white" for various purposes. One of the common methods of representing white color is known as the "color temperature". A white color with a low color temperature appears to be reddish white. A white color with a high color temperature appears to have more blue in it.

Color Management

Only in permanent installations with controlled lighting levels such as boardrooms, lecture theaters, or home theaters, should color management be considered. Color management provides fine color control adjustment to allow for more accurate color reproduction, should you require it.

If you have purchased a test disc which contains various color test patterns and can be used to test the color presentation on monitors, TVs, projectors, etc., you can project any image from the disc on the screen and enter the **3D Color Management** menu to make adjustments.

To adjust the settings:

1. Go to the **DISPLAY** menu and highlight **3D Color Management**.
2. Press **MODE/ENTER** on the projector or remote control and the **3D Color Management** page is displayed.
3. Highlight **Primary Color** and press ◀▶ to select a color from among Red, Yellow, Green, Cyan, Blue, or Magenta.
4. Press ▼ to highlight **Hue** and press ◀▶ to select its range. Increase in the range will include colors consisted of more proportions of its two adjacent colors.

Please refer to the illustration to the right for how the colors relate to each other.

For example, if you select Red and set its range at 0, only pure red in the projected picture will be selected. Increasing its range will include red close to yellow and red close to magenta.

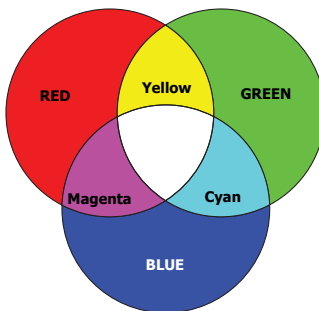

5. Press ▼ to highlight **Saturation** and adjust its values to your preference by pressing ◀/▶. Every adjustment made will reflect to the image immediately.

For example, if you select Red and set its value at 0, only the saturation of pure red will be affected.

 **Saturation is the amount of that color in a video picture. Lower settings produce less saturated colors; a setting of "0" removes that color from the image entirely. If the saturation is too high, that color will be overpowering and unrealistic.**

6. Press ▼ to highlight **Gain** and adjust its values to your preference by pressing ◀▶. The contrast level of the primary color you select will be affected. Every adjustment made will reflect to the image immediately.
7. Repeat steps 3 to 6 for other color adjustments.
8. Make sure you have made all of the desired adjustments.
9. Press **MENU** on the projector or **MENU/EXIT** on the remote control to exit and save the settings.

Setting the presentation timer

 This function is only available when an input signal is selected and active.

Presentation timer can indicate the presentation time on the screen to help you achieve better time management when giving presentations. Follow these steps to utilize this function:

1. Press **TIMER SET UP** on the remote control to access the **Presentation Timer** menu or go to the **SYSTEM SETTING: Basic > Presentation Timer** menu and press **MODE/ENTER** to display the **Presentation Timer** page.
2. Highlight **Timer Period** and decide the time period by pressing **◀▶**. The length of time can be set from 1 to 5 minutes in 1-minute increments and 5 to 240 minutes in 5-minute increments.

 If the timer is already on, the timer will restart whenever the Timer Period is reset.

3. Press **▼** to highlight **Timer Display** and choose if you want the timer to show up on the screen by pressing **◀▶**.

Selection	Description
Always	Displays the timer on screen throughout the presentation time.
1 min/2 min/3 min	Displays the timer on screen in the last 1/2/3 minute(s).
Never	Hides the timer throughout the presentation time.

4. Press **▼** to highlight **Timer Position** and set the timer position by pressing **◀▶**.

Top-Left → Bottom-Left → Top-Right → Bottom-Right

5. Press **▼** to highlight **Timer Counting Direction** and select your desired counting direction by pressing **◀▶**.

Selection	Description
Count Up	Increases from 0 to the preset time.
Count Down	Decreases from the preset time to 0.

6. Press **▼** to highlight **Sound Reminder** and decide if you want to activate sound reminder by pressing **◀▶**. If you select **On**, a double beep sound will be heard at the last 30 seconds of counting down/up, and a triple beep sound will be produced when the timer is up.
7. To activate the presentation timer, press **▼** and press **◀▶** to highlight **On** and press **MODE/ENTER**.
8. A confirmation message displays. Highlight **Yes** and press **MODE/ENTER** on the projector or remote control to confirm. You will see the message “**Timer is On**” displaying on the screen. The timer starts counting when the timer is on.

To cancel the timer, perform the following steps:

1. Go to the **SYSTEM SETTING: Basic > Presentation Timer** menu and highlight **Off**. Press **MODE/ENTER**. A confirmation message displays.
2. Highlight **Yes** and press **MODE/ENTER** to confirm. You will see the message “**Timer is Off**” displaying on the screen.

Hiding the image

In order to draw the audience's full attention to the presenter, you can use ◀ on the projector or **BLANK** on the remote control to hide the screen image. Press any key on the projector or remote control to restore the image.

You can set the blank time in the **SYSTEM SETTING: Basic > Blank Timer** menu to let the projector return the image automatically after a period of time when there is no action taken on the blank screen.



Do not block the projection lens from projecting as this could cause the blocking object to become heated and deformed or even cause a fire.

Locking control keys

With the control keys on the projector locked, you can prevent your projector settings from being changed accidentally (by children, for example). When the **Panel Key Lock** is on, no control keys on the projector will operate except ⏻.

1. Press ▶ on the projector or **Lock** 🔒 on the remote control, or go to the **SYSTEM SETTING: Basic > Panel Key Lock** menu, and select **On** by pressing ◀▶ on the projector or remote control.
2. A confirmation message is displayed. Select **Yes** to confirm.

To release panel key lock, press and hold ▶ on the projector or **Lock** 🔒 on the remote control for 3 seconds.

You can also use the remote control to enter the **SYSTEM SETTING: Basic > Panel Key Lock** menu and press ◀▶ to select **Off**.

- **Keys on the remote control are still functional when panel key lock is enabled.**
- **If you press ⏻ to turn off the projector without disabling panel key lock, the projector will still be in locked status the next time it is turned on.**

Freezing the image

Press **FREEZE** on the remote control to freeze the image. The word '**FREEZE**' will be displayed in the upper left corner of the screen. To release the function, press any key on the projector or remote control.

Even if an image is frozen on the screen, the pictures are running on the video or other device. If the connected devices have active audio output, you will still hear the audio even though the image is frozen on screen.





Operating in a high altitude environment

We recommend you use the **High Altitude Mode** when your environment is between 1500 m–3050 m above sea level, and temperature is between 0°C–30°C.

CAUTION

 **Do not use the High Altitude Mode if your altitude is between 0 m and 1499 m and temperature is between 0°C and 35°C. The projector will be over cooled, if you turn the mode on under such a condition.**

To activate the **High Altitude Mode**:

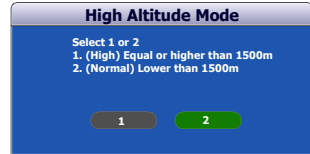

1. Press **MENU** on the projector or **MENU/EXIT** on the remote control and then press   until the **SYSTEM SETTING: Advanced** menu is highlighted.
2. Press  to highlight **High Altitude Mode** and press   to select **1** or **2**.
3. A confirmation message is displayed.
4. Highlight **1** and press **MODE/ENTER** on the projector or remote control.



Operation under "**High Altitude Mode**" may cause a higher decibel operating noise level because of increased fan speed necessary to improve overall system cooling and performance.

If you use this projector under other extreme conditions excluding the above, it may display auto shut-down symptoms, which is designed to protect your projector from over-heating. In cases like this, you should switch to **High Altitude Mode** to solve these symptoms. However, this is not to state that this projector can operate under any and all harsh or extreme conditions.

Shutting down the projector

1. Press  and a confirmation message is displayed prompting you. If you don't respond in a few seconds, the message will disappear.
2. Press  a second time.
3. Disconnect the power cord from the wall socket if the projector will not be used in an extended period of time.

CAUTION

- **To protect the lamp, the projector will not respond to any commands during the cooling process.**
- **Do not unplug the power cord before the projector shutdown sequence is complete.**

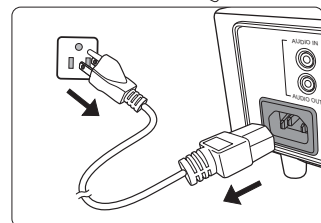
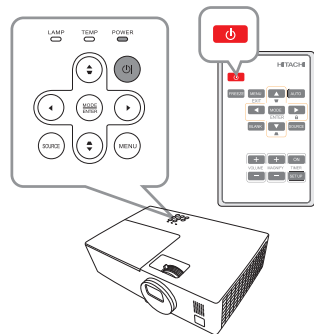



Menu operation



Menu system

Please note that the on-screen display (OSD) menus vary according to the signal type selected.





The menu items are available when the projector detects at least one valid signal. If there is no equipment connected to the projector or no signal detected, limited menu items are accessible.



Main menu	Sub-menu	Options	
1. DISPLAY 	Wall Color	Off/Light Yellow/Pink/Light Green/Blue/Blackboard	
	Aspect Ratio	Auto/Real/4:3/16:9	
	Keystone		
	Position		
	Phase		
	H. Size		
	Magnify		
	3D Sync	Auto/Frame Sequential/Frame Packing/Top-Bottom/Side-by-Side/Off	
3D Sync Invert	Disable/Invert		
2. PICTURE 	Preset Mode	Bright/Presentation/sRGB/Cinema/Game/User	
	Brightness		
	Contrast		
	Color		
	Tint		
	Sharpness		
	Brilliant Color	On/Off	
	Color Temperature	Cool/Normal/Warm	
	3D Color Management	Primary Color	R/G/B/C/M/Y
		Hue	
		Saturation	
	Gain		



Main menu	Sub-menu	Options	
3. SOURCE	Quick Auto Search	Off/On	
	Auto Adjustment		
4. SYSTEM SETTING: Basic 	Presentation Timer	Timer Period	1~240 minutes
		Timer Display	Always/1 min/2 min/3 min/ Never
		Timer Position	Top-Left/Bottom-Left/Top-Right/Bottom-Right
		Timer Counting Direction	Count Down/Count Up
		Sound Reminder	On/Off
		On/Off	
	Language	Multi-language OSD selection	
	Mirror	Normal/H Invert/V Invert/H & V Invert	
	Auto Power Off	Disable/5 min/10 min/15 min/ 20 min/25 min/30 min	
	Blank Timer	Disable/5 min/10 min/15 min/ 20 min/25 min/30 min	
	Panel Key Lock	On/Off	
Sleep Timer	Disable/30 min/1 hr/2 hr/3 hr/4 hr/8 hr/12 hr		
Background Color	Black/Blue/Original		

Main menu	Sub-menu	Options	
5. SYSTEM SETTING: Advanced 	Quick Cooling	On/Off	
	High Altitude Mode	1 (High) Equal or higher than 1500 m 2 (Normal) Lower than 1500 m	
	Audio Settings	Mute	On/Off
		Volume	
	Menu Settings	Menu Display Time	5 sec/10 sec/15 sec/20 sec/25 sec/30 sec
		Menu Position	Center/Top-Left/Top-Right/Bottom-Right/Bottom-Left
	Standby Mode	Normal/Saving	
	Lamp Settings	Lamp Mode	Normal/Economic/Intelligent Eco
		Reset Lamp Timer	
		Equivalent Lamp Hour	
	Security Settings	Change Password	
Power on Lock		On/Off	
Closed Caption	Closed Caption Enable	On/Off	
	Caption Version	CC1/CC2/CC3/CC4	
Reset All Settings	Reset/Cancel		
6. INFORMATION 	Current System Status	<ul style="list-style-type: none"> • Source • Preset Mode • Color System • Resolution • Equivalent Lamp Hour • Serial Number 	



Description of each menu

Function	Description
1. DISPLAY menu	<p>Wall Color</p> <p>In the situation where you are projecting onto a colored surface such as a painted wall which may not be white, the Wall Color feature can help correct the projected picture' colors to prevent possible color difference between the source and projected pictures.</p> <p>Use the ◀▶ buttons to select a color which is closest to the color of the projection surface.</p> <p> This function is only available when a computer signal (analog RGB) is selected.</p>
	<p>Aspect Ratio</p> <p>There are three options to set the image's aspect ratio depending on your input signal source. See "Selecting the aspect ratio" on page 24 for details.</p>
	<p>Keystone</p> <p>Corrects any keystoneing of the image. See "Correcting keystone" on page 23 for details.</p>
	<p>Position</p> <p>Displays the position adjustment page. To move the projected image, use the directional arrow keys. The values shown on the lower position of the page change with every key press you made until they reach their maximum or minimum.</p> <p> This function is only available when a computer signal (analog RGB) is selected.</p>
	<p>Phase</p> <p>Adjusts the clock phase to reduce image distortion.</p> <div data-bbox="759 751 983 876" data-label="Image"> </div> <p> This function is only available when a computer signal (analog RGB) is selected.</p>
	<p>H. Size</p> <p>Adjusts the horizontal width of the image.</p> <p> This function is only available when a computer signal (analog RGB) is selected.</p>
	<p>Magnify</p> <p>Magnifies or reduces the projected image. See "Magnifying and searching for details" on page 23 for details.</p>

Function	Description
<div style="writing-mode: vertical-rl; transform: rotate(180deg);">1. DISPLAY menu</div> <div style="text-align: center; padding-top: 20px;">3D Sync</div>	<p>This projector features 3D function which enables you to enjoy 3D movies, videos, and sporting events in a more realistic way by presenting the depth of the images. You need to wear a pair of 3D glasses to view 3D images.</p> <ol style="list-style-type: none"> 1. Press the MODE/ENTER button to display the 3D Sync menu. 2. Use the ▼/▲ buttons to select a 3D sync mode. <ul style="list-style-type: none"> - When Auto is selected, the projector detects the input signal and determines a suitable 3D sync mode automatically. In case the 3D sync mode is not detected correctly and the 3D image is not displayed properly, select another 3D sync mode until the image is displayed correctly. - If Off is selected, the 3D function will be turned off. <p> The 3D function is only available when the refresh rate of the Video source is 60Hz and computer source is 120Hz.</p> <p> When the 3D Sync function is on:</p> <ul style="list-style-type: none"> • The brightness level of the projected image will decrease. • The Preset Mode cannot be adjusted. • Images cannot be magnified.
<div style="text-align: center;">3D Sync Invert</div>	<p>When you discover the inversion of the image depth, enable this function to correct the problem.</p>

Function	Description	
2. PICTURE menu	Preset Mode	Pre-defined preset modes are provided so you can optimize your projector image set-up to suit your program type. See " Selecting a preset mode " on page 26 for details.
	Brightness	Adjusts the brightness of the image. See " Adjusting Brightness " on page 26 for details.
	Contrast	Adjusts the degree of difference between dark and light in the image. See " Adjusting Contrast " on page 27 for details.
	Color	Adjusts the color saturation level -- the amount of each color in a video image. See " Adjusting Color " on page 27 for details.  This function is only available when a Video, S-Video or Component Video signal is selected.
	Tint	Adjusts the red and green color tones of the image. See " Adjusting Tint " on page 27 for details.  The function is only available when a Video or S-Video signal with NTSC system is selected.
	Sharpness	Adjusts the image to make it look sharper or softer. See " Adjusting Sharpness " on page 27 for details.  This function is only available when a Video, S-Video or Component Video signal is selected.
	Brilliant Color	Adjusts white peaking while maintaining correct color presentation. See " Adjusting Brilliant Color " on page 27 for details.
	Color Temperature	See " Selecting a Color Temperature " on page 27 for details.
	3D Color Management	See " Color Management " on page 28 for details.
3. SOURCE menu	Quick Auto Search	See " Switching input signal " on page 21 for details.
	Auto Adjustment	See " Auto-adjusting the image " on page 22 for details.

Function	Description
4. SYSTEM SETTING: Basic menu	Presentation Timer Reminds the presenter to finish the presentation within a certain time frame. See "Setting the presentation timer" on page 29 for details.
	Language Sets the language for the On-Screen Display (OSD) menus. See "Using the menus" on page 18 for details.
	Mirror See "Choosing a location" on page 10 for details.
	Auto Power Off Allows the projector to turn off automatically if no input signal is detected after a set period of time. See "Setting Auto Power Off" on page 42 for details.
	Blank Timer Sets the image blank time when the Blank feature is activated, once elapsed the image will return to the screen. See "Hiding the image" on page 30 for details.
	Panel Key Lock Disables or enables all panel key functions except POWER on the projector and keys on the remote control. See "Locking control keys" on page 30 for details.
	Sleep Timer This function allows the projector to turn off automatically if there is no user operation after a set period of time. Use the ◀▶ to select the period of time.
Background Color Allows you to select which logo screen will be displayed during projector start-up.	
5. SYSTEM SETTING: Advanced menu	Quick Cooling Enables or disables the Quick Cooling function. Use the ◀▶ buttons to select On or Off . Selecting On enables the function and projector cooling time will be shortened from a normal 70-second duration to approximately 13 seconds.
	High Altitude Mode A mode for operation in high altitude areas. See "Operating in a high altitude environment" on page 31 for details.
	Audio Settings The sound adjustments made as below will have an effect on the projector speaker. Be sure you have made a correct connection to the projector audio input/output ports. See "Connection" on page 12 for more details. Mute Mutes the sound received from AUDIO IN and HDMI . Volume Adjusts the sound level received from AUDIO IN and HDMI .
	Menu Settings Menu Display Time Sets the length of time the OSD will remain active after your last key press. The range is from 5 to 30 seconds in 5-second increments. Menu Position Sets the On-Screen Display (OSD) menu position.

Function	Description
5. SYSTEM SETTING: Advanced menu	<p>Use ◀▶ to select a standby mode.</p> <p>Normal The projector is able to provide the following functions when it is in standby mode.</p> <ul style="list-style-type: none"> • The projector can output a VGA signal when it is in standby mode and the COMPUTER IN 1 port is correctly connected to devices. • The projector can output audio signals when it is in standby mode and the corresponding ports are correctly connected to devices. Speaker is disabled in standby mode. <p>See "Connection" on page 12 for how to make the connections.</p> <p>Saving The projector consumes less than 0.5W power during standby when this mode is selected. The Monitor out and Audio out functions are disabled.</p>
	<p>Lamp Mode See "Setting Lamp Mode as Economic or Intelligent Eco" on page 42 for details.</p> <p>Reset Lamp Timer See "Resetting the lamp timer" on page 45 for details.</p> <p>Equivalent Lamp Hour See "Getting to know the lamp hour" on page 42 for details on how the total lamp hour is calculated.</p>
	<p>Security Settings See "Utilizing the password function" on page 19 for details.</p>
	<p>Closed Caption Enable Activates the function by selecting On when the selected input signal carries closed captions.</p> <ul style="list-style-type: none"> • Captions: An on-screen display of the dialogue, narration, and sound effects of TV programs and videos that are closed captioned (usually marked as "CC" in TV listings). <p> This function is only available when a Composite video or S-Video input signal is selected and its system format is NTSC.</p> <p>Caption Version Selects a preferred closed captioning mode. To view captions, select CC1, CC2, CC3, or CC4 (CC1 displays captions in the primary language in your area).</p>
	<p>Reset All Settings Returns all settings to the factory preset values.</p> <p> The following settings will still remain: Language, Mirror, High Altitude Mode, Security Settings.</p>

Function	Description
<p style="writing-mode: vertical-rl; transform: rotate(180deg);">6. INFORMATION menu</p> <p>Current System Status</p>	<p>Model name Shows the model name.</p> <p>Source Shows the current signal source.</p> <p>Preset Mode Shows the selected mode in the PICTURE menu.</p> <p>Color System Shows input system format, NTSC, PAL, SECAM, or RGB.</p> <p>Resolution Shows the native resolution of the input signal.</p> <p>Equivalent Lamp Hour Displays the number of hours the lamp has been used.</p> <p>Serial Number Shows the serial number of the projector.</p>

Maintenance

Care of the projector

Your projector needs little maintenance. The only thing you need to do on a regular basis is to keep the lens clean.

Never remove any parts of the projector except the lamp. Contact your dealer if other parts need replacing.

Cleaning the lens

Clean the lens whenever you notice dirt or dust on the surface.

- Use a canister of compressed air to remove dust.
- If there is dirt or smears, use lens-cleaning paper or moisten a soft cloth with lens cleaner and gently wipe the lens surface.

CAUTION

Never rub the lens with abrasive materials.

Cleaning the projector case

Before you clean the case, turn the projector off using the proper shutdown procedure as described in "[Shutting down the projector](#)" on page 31 and unplug the power cord.

- To remove dirt or dust, wipe the case with a soft, lint-free cloth.
- To remove stubborn dirt or stains, moisten a soft cloth with water and a neutral pH detergent. Then wipe the case.

CAUTION

Never use wax, alcohol, benzene, thinner or other chemical detergents. These can damage the case.

Storing the projector

If you need to store the projector for an extended time, please follow the instructions below:

- Make sure the temperature and humidity of the storage area are within the recommended range for the projector. Please refer to "[Specifications](#)" on page 48 or consult your dealer about the range.
- Retract the adjuster feet.
- Remove the battery from the remote control.
- Pack the projector in its original packing or equivalent.

Transporting the projector

It is recommended that you ship the projector with its original packing or equivalent.

Lamp information

Getting to know the lamp hour

When the projector is in operation, the duration (in hours) of lamp usage is automatically calculated by the built-in timer. The method of calculating the equivalent lamp hour is as follows:

Total lamp hour = (hours used in **Normal** mode) + (hours used in **Economic** mode) + (hours used in **Intelligent Eco** mode)

To obtain the lamp hour information:

1. Press **MENU** on the projector or **MENU/EXIT** on the remote control and then press **◀▶** until the **SYSTEM SETTING: ADVANCED** menu is highlighted.
2. Press **▼** to highlight **Lamp Settings** and press **MODE/ENTER** on the projector or remote control. The **Lamp Settings** page is displayed.
3. You will see the **Equivalent lamp hour** information on the menu.
4. To leave the menu, press **MENU** on the projector or **MENU/EXIT** on the remote control.

You can also get the lamp hour information on the **INFORMATION** menu.

Extending lamp life

The projection lamp is a consumable item. To keep the lamp life as long as possible, you can do the following settings via the OSD menu.

Setting Lamp Mode as Economic or Intelligent Eco

Using **Economic/Intelligent Eco** mode reduces system noise and power consumption. If the **Economic/Intelligent Eco** mode is selected, the light output will be reduced and result in darker projected pictures.

Setting the projector in **Economic/Intelligent Eco** mode also extends the lamp operation life. To set **Intelligent Eco** mode, go into the **SYSTEM SETTING: ADVANCED > Lamp Settings > Lamp Mode** menu and press **◀▶**.

Setting Auto Power Off

This function allows the projector to turn off automatically if no input source is detected after a set period of time to prevent unnecessary waste of lamp life.

To set **Auto Power Off**, go into the **SYSTEM SETTING: BASIC > Auto Power Off** menu and press **◀▶**. If the preset time lengths are not suitable for your presentation, select **Disable**. The projector will not automatically shut down in a certain time period.

Replacing the lamp

To prepare a new lamp, contact your dealer and tell the lamp type number.

Type number: DT01851

WARNING

- The projector uses a high-pressure mercury glass lamp.
- The lamp can break with a loud bang, or burn out, if jolted or scratched, handled while hot, or worn over time. Note that each lamp has a different lifetime, and some may burst or burn out soon after you start using them.

Hg - Lamp contains mercury. Manage in accordance with local disposal laws. See www.lamprecycle.org

- To reduce the risk of electrical shock, always turn the projector off and disconnect the power cord before changing the lamp.
- To reduce the risk of severe burns, allow the projector to cool for at least 45 minutes before replacing the lamp.
- To reduce the risk of injuries to fingers and damage to internal components, use caution when removing lamp glass that has shattered into sharp pieces. Before replacing the lamp, clean the lamp compartment and dispose of cleaning materials. Be careful of sharp edges in the lamp compartment. Wash hands after lamp replacement.
- If the lamp should break (it will make a loud bang when it does), ventilate the room well, and make sure not to inhale the gas or fine particles that come out from the projector's vent holes, and not to get them into your eyes or mouth.
- Only certified lamps are tested with this projector. Use of other lamps may cause electrical shock and fire.
- Be sure to place the projector on a flat surface to replace the lamp.

1. Turn the power off and disconnect the power cord from the wall socket. If the lamp is hot, avoid burns by waiting for approximately 45 minutes until the lamp has cooled.
2. Prepare a new lamp. If the projector is mounted in a high position, or if the lamp has broken, also ask the dealer to replace the lamp.
3. Loosen the screw of the lamp cover. Refer to the right figure to identify the screw.
4. Remove the lamp cover from the projector.

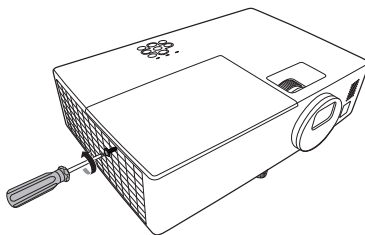

WARNING

- Do not turn the power on with the lamp cover removed.
- Do not insert your fingers between the lamp and the projector. It may cause injuries.

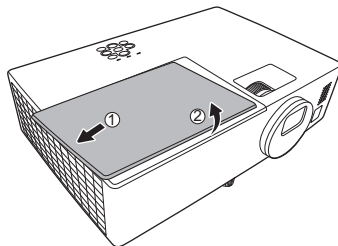

-
5. Remove the protection film. Loosen the screw that secures the lamp. Refer to the right figure to identify the screw.

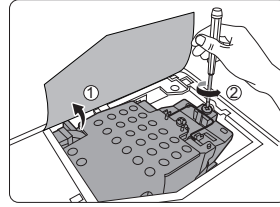

-
6. Disconnect the lamp's wire connector from the projector, and then slowly pick up the lamp by the handle.

⚠ CAUTION

- Pulling it too quickly may cause the lamp to break and scatter broken glass in the projector.
- Do not place the lamp in locations where water might splash on it, children can reach it, or near flammable materials.
- Do not insert your hands into the projector after the lamp is removed. If you touch the optical components inside, it could cause color unevenness and distortion of the projected images.

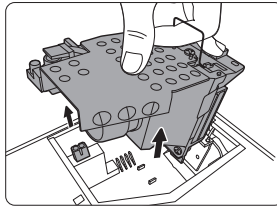

-
7. Insert the new lamp into the lamp compartment and make sure it fits in the projector. Connect the new lamp's wire connector to the projector.

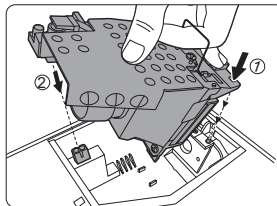

-
8. Tighten the screw that secures the lamp.

⚠ CAUTION

- Loose screw may cause a bad connection, which could result in malfunction.
- Do not over tighten the screw.

9. Ensure the handle is fully laid flat and locked in place.
10. Replace the new protection film that comes with the new lamp.

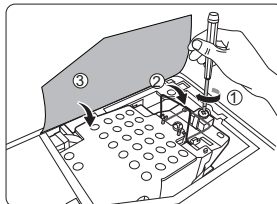

-
11. Replace the lamp cover on the projector.

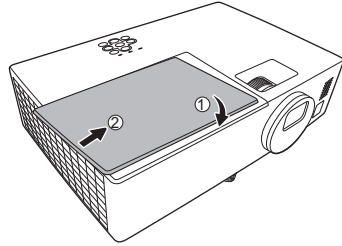

-
12. Tighten the screw that secures the lamp cover.

⚠ CAUTION

- Loose screw may cause a bad connection, which could result in malfunction.
- Do not over tighten the screws.

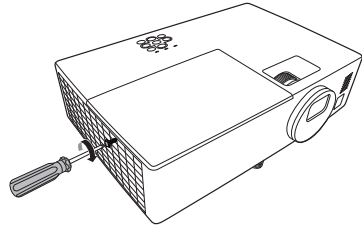

13. Restart the projector.

⚠ CAUTION

Do not turn the power on with the lamp cover removed.

Resetting the lamp timer

14. After the startup logo, open the On-Screen Display (OSD) menu.
15. Go to the **SYSTEM SETTING: ADVANCED > Lamp Settings** menu. Press **MODE/ENTER** on the projector or remote control. The **Lamp Settings** page is displayed.
16. Press **▼** to highlight **Reset lamp timer** and press **MODE/ENTER** on the projector or remote control. A warning message is displayed asking if you want to reset the lamp timer.
17. Highlight **Reset** and press **MODE/ENTER** on the projector or remote control. The lamp time will be reset to '0'.

⚠ CAUTION

Do not reset if the lamp is not new or replaced as this could cause damage.



Indicators

Light			Status & Description
POWER	TEMP	LAMP	
System Messages			
Purple	Off	Off	Stand-by
Blue Flashing	Off	Off	Powering up
Blue	Off	Off	Normal operation
Purple Flashing	Off	Off	Power-down cooling
Blue	Off	Red	CW start fail. Please contact your dealer for assistance.
Red Flashing	Off	Off	Scaler shutdown fail. Please contact your dealer for assistance.
Lamp Error Messages			
Off	Off	Red	Lamp error. Please contact your dealer for assistance.
Off	Off	Red Flashing	Lamp is not lit up. Please contact your dealer for assistance.
Red	Off	Red Flashing	Lamp door is open.
Thermal Error Messages			
Red	Red	Off	Fan 1 error. Please contact your dealer for assistance.
Red	Red Flashing	Off	Fan 2 error. Please contact your dealer for assistance.
Blue	Red	Off	Over heated. Please contact your dealer for assistance.

Troubleshooting

① The projector does not turn on.

Cause	Remedy
There is no power from the power cord.	Plug the power cord into the AC inlet on the projector, and plug the power cord into the power outlet. If the power outlet has a switch, make sure that it is switched on.
Attempting to turn the projector on again during the cooling process.	Wait until the cooling down process has completed.

① No picture

Cause	Remedy
The video source is not turned on or connected correctly.	Turn the video source on and check that the signal cable is connected correctly.
The projector is not correctly connected to the input signal device.	Check the connection.
The input signal has not been correctly selected.	Select the correct input signal with the SOURCE key on the projector or remote control.

① Blurred image

Cause	Remedy
The projection lens is not correctly focused.	Adjust the focus of the lens using the focus ring.
The projector and the screen are not aligned properly.	Adjust the projection angle and direction as well as the height of the projector if necessary.

① Remote control does not work

Cause	Remedy
The battery is out of power.	Replace the battery with a new one.
There is an obstacle between the remote control and the projector.	Remove the obstacle.
You are too far away from the projector.	Stand within 4 meters (~13 feet) of the projector.

Specifications

Projector specifications

-  • All specifications are subject to change without notice.
- Not all models can be purchased in your region.

General	
Product name	Projector
Optical	
Resolution	1024 x 768 XGA
Display system	1-CHIP DMD
Lamp	196 W lamp
Electrical	
Power supply	AC 100-120V: 2.9 A, AC 220-240V: 1.2 A
Power consumption	AC 100-120V: 276W, AC 220-240V: 266W
Mechanical	
Weight	Approx. 2.3 kg
Input terminal	
Computer input	
COMPUTER IN1 port COMPUTER IN2 port	D-Sub 15-pin (female) x 2
Video signal input	
S-VIDEO port	Mini DIN 4-pin x 1
VIDEO port	RCA x 1
SD/HDTV signal input	
Analog –	D-Sub <-> Component RCA x 3 (through COMPUTER IN1/COMPUTER IN2 input port)
Digital –	HDMI x 1
Audio signal input	
AUDIO IN port	Stereo mini x 1

Output terminal	
MONITOR OUT port	D-Sub 15-pin (female) x 1
AUDIO OUT port	Stereo mini x 1
Speaker	2 watt x 1
Control terminal	
CONTROL port	RS-232 serial control 9 pin x 1
IR receiver	x 1 (Front)
Service terminal	
SERVICE port	USB mini B x 1
Environmental Requirements	
Operating temperature	0°C–40°C at sea level
Operating relative humidity	10%–90% (without condensation)
Operating altitude	<ul style="list-style-type: none"> • 0–1499 m at 0°C–35°C (with High Altitude Mode 2 (Normal)) • 1500–3050 m at 0°C–30°C (with High Altitude Mode 1 (High))

Dimensions

Max. size 314.6 mm (W) x 91.2 mm (H) x 218.8 mm (D)

Min. size 314.6 mm (W) x 89.1 mm (H) x 208 mm (D)

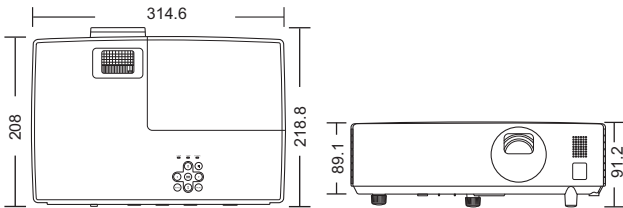

Unit: mm

Timing chart

Supported timing for PC input

Resolution	Mode	Refresh rate (Hz)	H-frequency (kHz)	Clock (MHz)
640 x 480	VGA_60***	59.940	31.469	25.175
	VGA_72	72.809	37.861	31.500
	VGA_75	75.000	37.500	31.500
	VGA_85	85.008	43.269	36.000
800 x 600	SVGA_60***	60.317	37.879	40.000
	SVGA_72	72.188	48.077	50.000
	SVGA_75	75.000	46.875	49.500
	SVGA_85	85.061	53.674	56.250
	SVGA_120* (Reduce Blanking)	119.854	77.425	83.000
1024 x 768	XGA_60***	60.004	48.363	65.000
	XGA_70	70.069	56.476	75.000
	XGA_75	75.029	60.023	78.750
	XGA_85	84.997	68.667	94.500
	XGA_120* (Reduce Blanking)	119.989	97.551	115.500
1152 x 864	1152 x 864_75	75.00	67.500	108.000
1280x720	1280 x 720_60***	60	45.000	74.250
1280 x 768	1280 x 768_60***	59.870	47.776	79.5
1280 x 800	WXGA_60***	59.810	49.702	83.500
	WXGA_75	74.934	62.795	106.500
	WXGA_85	84.880	71.554	122.500
	WXGA_120* (Reduce Blanking)	119.909	101.563	146.25
1280 x 1024	SXGA_60**	60.020	63.981	108.000
	SXGA_75	75.025	79.976	135.000
	SXGA_85	85.024	91.146	157.500
1280 x 960	1280 x 960_60**	60.000	60.000	108
	1280 x 960_85	85.002	85.938	148.500
1360 x 768	1360 x 768_60**	60.015	47.712	85.500
1440 x 900	WXGA+_60**	59.887	55.935	106.500
1400X1050	SXGA+_60**	59.978	65.317	121.750
1600x1200	UXGA**	60.000	75.000	162.000
1680 x 1050	1680 x 1050_60**	59.954	65.290	146.250
640 x 480@67Hz	MAC13	66.667	35.000	30.240
832 x 624@75Hz	MAC16	74.546	49.722	57.280
1024 x 768@75Hz	MAC19	74.93	60.241	80.000
1152 x 870@75Hz	MAC21	75.06	68.68	100.00

 *Supported timing for 3D signal in Frame Sequential format.

- ****Supported timing for 3D signal in Top-Bottom and Side-by-Side formats.**
- *****Supported timing for 3D signal in Frame Sequential, Top-Bottom and Side-by-Side formats.**

Supported timing for HDMI input

Resolution	Mode	Refresh rate (Hz)	H-frequency (kHz)	Clock (MHz)
640 x 480	VGA_60***	59.940	31.469	25.175
	VGA_72	72.809	37.861	31.500
	VGA_75	75.000	37.500	31.500
	VGA_85	85.008	43.269	36.000
800 x 600	SVGA_60***	60.317	37.879	40.000
	SVGA_72	72.188	48.077	50.000
	SVGA_75	75.000	46.875	49.500
	SVGA_85	85.061	53.674	56.250
	SVGA_120* (Reduce Blanking)	119.854	77.425	83.000
1024 x 768	XGA_60***	60.004	48.363	65.000
	XGA_70	70.069	56.476	75.000
	XGA_75	75.029	60.023	78.750
	XGA_85	84.997	68.667	94.500
	XGA_120* (Reduce Blanking)	119.989	97.551	115.500
1152 x 864	1152 x 864_75	75.00	67.500	108.000
1280 x 720	1280x720_60***	60	45.000	74.250
1280 x 768	1280 x 768_60***	59.870	47.776	79.5
1280 x 800	WXGA_60***	59.810	49.702	83.500
	WXGA_75	74.934	62.795	106.500
	WXGA_85	84.880	71.554	122.500
	WXGA_120* (Reduce Blanking)	119.909	101.563	146.25
1280 x 1024	SXGA_60**	60.020	63.981	108.000
	SXGA_75	75.025	79.976	135.000
	SXGA_85	85.024	91.146	157.500
1280 x 960	1280 x 960_60**	60.000	60.000	108
	1280 x 960_85	85.002	85.938	148.500
1360 x 768	1360 x 768_60**	60.015	47.712	85.500
1440 x 900	WXGA+_60**	59.887	55.935	106.500
1400 x 1050	SXGA+_60**	59.978	65.317	121.750
1600 x 1200	UXGA**	60.000	75.000	162.000
1680 x 1050	1680x1050_60**	59.954	65.290	146.250
640x480@67Hz	MAC13	66.667	35.000	30.240
832x624@75Hz	MAC16	74.546	49.722	57.280
1024x768@75Hz	MAC19	75.020	60.241	80.000
1152x870@75Hz	MAC21	75.06	68.68	100.00

 • ***Supported timing for 3D signal in Frame Sequential format.**

- ****Supported timing for 3D signal in Top-Bottom and Side-by-Side formats.**
- *****Supported timing for 3D signal in Frame Sequential, Top-Bottom and Side-by-Side formats.**

Timing	Resolution	Horizontal frequency (KHz)	Vertical frequency (Hz)	Dot Clock Frequency (MHz)
480i*	720 (1440) x 480	15.73	59.94	27
480p	720 x 480	31.47	59.94	27
576i	720 (1440) x 576	15.63	50	27
576p	720 x 576	31.25	50	27
720/50p**	1280 x 720	37.5	50	74.25
720/60p**	1280 x 720	45.00	60	74.25
1080/24P**	1920 x 1080	27	24	74.25
1080/30P	1920 x 1080	33.75	30	74.25
1080/50i***	1920 x 1080	28.13	50	74.25
1080/60i***	1920 x 1080	33.75	60	74.25
1080/50P	1920 x 1080	56.25	50	148.5
1080/60P	1920 x 1080	67.5	60	148.5

- ☞ • ***Supported timing for 3D signal in Frame Sequential format.**
- ****Supported timing for 3D signal in Frame Packing and Top-Bottom formats.**
- *****Supported timing for 3D signal in Side-by-Side format.**

Supported timing for Component-YPbPr input

Timing	Resolution	Horizontal frequency (KHz)	Vertical Frequency (Hz)	Dot Clock Frequency (MHz)
480i	720 x 480	15.73	59.94	13.5
480p	720 x 480	31.47	59.94	27
576i	720 x 576	15.63	50	13.5
576p	720 x 576	31.25	50	27
720/50p	1280 x 720	37.5	50	74.25
720/60p	1280 x 720	45.00	60	74.25
1080/50i	1920 x 1080	28.13	50	74.25
1080/60i	1920 x 1080	33.75	60	74.25
1080/24P	1920 x 1080	27	24	74.25
1080/30P	1920 x 1080	33.75	30	74.25
1080/50P	1920 x 1080	56.25	50	148.5
1080/60P	1920 x 1080	67.5	60	148.5

- ☞ Displaying a 1080i(1125i)@60Hz or 1080i(1125i)@50Hz signal may result in slight image vibration.

Supported timing for Video and S-Video inputs

Video mode	Horizontal Frequency (kHz)	Vertical Frequency (Hz)	Color sub-carrier Frequency (MHz)
NTSC	15.73	60	3.58
PAL	15.63	50	4.43
SECAM	15.63	50	4.25 or 4.41
PAL-M	15.73	60	3.58
PAL-N	15.63	50	3.58
PAL-60	15.73	60	4.43
NTSC4.43	15.73	60	4.43

Regulation Statements

FCC statement

This device complies with Part 15 of the FCC Rules. Operation is subject to the following two conditions: (1) this device may not cause harmful interference, and (2) this device must accept any interference received, including interference that may cause undesired operation.

This equipment has been tested and found to comply with the limits for a Class B digital device, pursuant to part 15 of the FCC Rules. These limits are designed to provide reasonable protection against harmful interference in a residential installation. This equipment generates, uses and can radiate radio frequency energy and, if not installed and used in accordance with the instructions, may cause harmful interference to radio communications. However, there is no guarantee that interference will not occur in a particular installation. If this equipment does cause harmful interference to radio or television reception, which can be determined by turning the equipment off and on, the user is encouraged to try to correct the interference by one or more of the following measures:

- Reorient or relocate the receiving antenna.
- Increase the separation between the equipment and receiver.
- Connect the equipment into an outlet on a circuit different from that to which the receiver is connected.
- Consult the dealer or an experienced radio/TV technician for help.

CAUTION: Changes or modifications not expressly approved by the manufacturer void the user's authority to operate the equipment.

ICES-003

This Class B digital apparatus complies with Canadian ICES-003.

Cet appareil numérique de la classe B est conforme à la norme NMB-003 du Canada.

WEEE

Disposing of this product correctly will help save valuable resources and prevent any potential negative effects on human health and the environment, which could otherwise arise from inappropriate waste handling.

Please contact your local authority for further details of your nearest designated collection point.

Penalties may be applicable for incorrect disposal of this waste, in accordance with your national legislation.

For business users in the European Union

If you wish to discard electrical and electronic equipment, please contact your dealer or supplier for further information.

Information on Disposal in other Countries outside the European Union

This symbol is only valid in the European Union. If you wish to discard this product please contact your local authorities or dealer and ask for the correct method of disposal.



Copyright information

Copyright

Copyright 2015. All rights reserved. No part of this publication may be reproduced, transmitted, transcribed, stored in a retrieval system or translated into any language or computer language, in any form or by any means, electronic, mechanical, magnetic, optical, chemical, manual or otherwise, without the prior written permission of this company.

Disclaimer

This company makes no representations or warranties, either expressed or implied, with respect to the contents hereof and specifically disclaims any warranties, merchantability or fitness for any particular purpose. Further, this company reserves the right to revise this publication and to make changes from time to time in the contents hereof without obligation to notify any person of such revision or changes.

The illustrations in this manual are for illustrative purposes. They may differ slightly from your projector.

The reproduction, transfer or copy of all or any part of this document is not permitted without express written consent.

*DLP and Digital Micromirror Device (DMD) are trademarks of Texas Instruments. Others are copyrights of their respective companies or organizations.

*Registered trademarks of HDMI Licensing LLC in the United States and other countries.

*Mac[®] and Macintosh[®] are registered trademarks of Apple Inc.

*Microsoft[®] and PowerPoint[®] are registered trademarks of Microsoft Corporation in the U.S. and/or other countries.

All other trademarks are the properties of their respective owners.

Warranty and after-service

If an abnormal operation (such as smoke, strange odor or excessive sound) should occur, stop using the projector immediately.

Otherwise if a problem occurs with the projector, first refer to “Troubleshooting”, and run through the suggested checks.

If this does not resolve the problem, please consult your dealer or service company. They will tell you what warranty condition is applied.

HITACHI

Inspire the Next

Hitachi America, Ltd.

Business Solutions Group
2420 Fenton Street, Suite 200
Chula Vista, CA 91914 [USA](#) [CANADA](#)
Tel: +1 -800-448-2244
► <http://www.hitachi-america.us/projectors>

Hitachi Europe Ltd., Digital Media Group Consumer Affairs Department

Whitebrook Park, Lower Cookham Road,
Maidenhead
Berkshire SL6 8YA [UNITED KINGDOM](#)
Tel: 0844 481 0297
(international call is NOT available for this number)
Email: tech.assist@hitachi-eu.com
► <http://www.equinox.co.uk/hitachi/>

Hitachi Europe S.A.S., Digital Media Group

31 bis rue du 35ème Régiment de l'aviation
ZAC DU CHENE, 69500 BRON [FRANCE](#)
Tel: 0 478 262135 +33 478 262135
Email: france.consommateur@hitachi-eu.com

Hitachi Europe GmbH

Am Seestern 18
40547 Düsseldorf [GERMANY](#)
Tel: 0 40 73353 468 +49 (0) 40 73353 468
Email: Service.germany@hitachi-eu.com

Hitachi Europe S.A.

364, Kifissias Ave. & 1, Delfon Str.
152 33 Chalandri
Athens [GREECE](#)
Tel: +30 210 921 0800
Email: dmgservice.gr@hitachi-eu.com

Hitachi Europe S.r.l.

Via T. Gulli, 39
20147 MILANO [ITALY](#)
Tel: +39 2 257 12355
Email: Aerta_bsd@iol.it

Hitachi Europe S.A.

Gran Via Carles III, 86 Planta 5ª
Edificios Trade - Torre Este
08028 Barcelona [SPAIN](#)
Tel: 0 93 266 4747 +34 93 266 4747
Email: Atencion.Cliente@hitachi-eu.com

Hitachi Europe AB

Frösundaviks Alle 15
169 29 Solna [SWEDEN](#)
Sweden Tel: +46 36 16 16 90
Finland Tel: +358 9 8494 133
Norway Tel: +47 2290 1930
Denmark Tel: +45 7562 4577
► <http://www.hitachidigitalmedia.com>

Hitachi Australia Pty Ltd.

Suite 801, Level 8, 123 Epping Road
North Ryde N.S.W 2113 [AUSTRALIA](#)
Tel: +61 -2-9888-4100
► <http://www.hitachi.com.au>

Hitachi (Hong Kong), Ltd.

18/F., Ever Gain Centre, 28 On Muk Street.,
Shatin, N.T. [HONG KONG](#)
Tel: +852 -2113-8883
► <http://www.hitachi-hk.com.hk>

Hitachi Sales (Malaysia) Sdn. Bhd.

Lot 12, Jalan Kamajuan, Bangi Industrial Estate,
43650 Bandar Baru Bangi, Selangor Darul Ehsan
[MALAYSIA](#)
Tel: +60 -3-8911-2670
► <http://www.hitachiconsumer.com.my>

Hitachi Home Electronics Asia (S) Pte. Ltd.

438A Alexandra Road #01-01/02/03
Alexandra Technopark, 119967 [SINGAPORE](#)
Tel: +65 -6536-2520
► <http://www.hitachiconsumer.com.sg>

Hitachi Sales Corp. of Taiwan

2nd Floor, No.65, Nanking East Road, Section 3,
Taipei 104 [TAIWAN](#)
Tel: +886-2-2516-0500
► <http://www.hsct.com.tw>

Hitachi Sales (Thailand), Ltd.

994, 996 Soi Thonglor, Sukhumvit 55 Rd.,
Klongtonna, Vadhana, Bangkok 10110 [THAILAND](#)
Tel: +66 -2381-8381-98
► <http://www.hitachi-th.com>

Hitachi Maxell, Ltd.

[JAPAN](#)
► <http://www.hitachi.co.jp/proj/>