

# Projector

# CP-DW10N

## User's Manual (detailed)

## Operating Guide

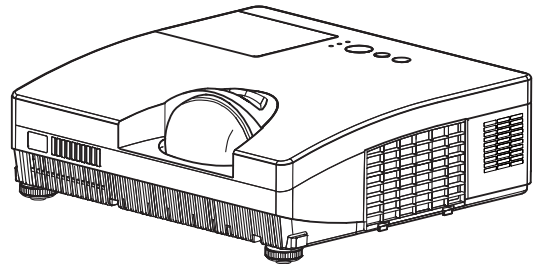

Thank you for purchasing this projector.

**⚠ WARNING** ▶ Before using this product, please read all manuals for this product. Be sure to read “**Safety Guide**” first. After reading them, store them in a safe place for future reference.

### About this manual

Various symbols are used in this manual. The meanings of these symbols are described below.

**⚠ WARNING** This symbol indicates information that, if ignored, could possibly result in personal injury or even death due to incorrect handling.

**⚠ CAUTION** This symbol indicates information that, if ignored, could possibly result in personal injury or physical damage due to incorrect handling.

**NOTICE** This entry notices of fear of causing trouble.

 Please refer to the pages written following this symbol.

**NOTE**



- The information in this manual is subject to change without notice.
- The manufacturer assumes no responsibility for any errors that may appear in this manual.
- The reproduction, transfer or copy of all or any part of this document is not permitted without express written consent.

### Trademark acknowledgment

- Mac<sup>®</sup> is a registered trademark of Apple Inc.
- Windows<sup>®</sup> is a registered trademark of Microsoft Corporation in the U.S. and/or other countries.
- VESA and DDC are trademarks of the Video Electronics Standard Association.
- HDMI, the HDMI logo and High-Definition Multimedia Interface are trademarks or registered trademarks of HDMI Licensing LLC.
- DVI is a trademark of Digital Display Working Group.
- Trademark PJLink is a trademark applied for trademark rights in Japan, the United States of America and other countries and areas.
- "Blu-ray Disc" is a trademark.

All other trademarks are the properties of their respective owners.

**PJLink**<sup>™</sup>

			
<b>About this manual</b> . . . . .	<b>1</b>	COLOR TEMP, COLOR, TINT, SHARPNESS, MY MEMORY	
<b>Contents</b> . . . . .	<b>2</b>	<b>IMAGE menu</b> . . . . .	<b>32</b>
<b>Projector features</b> . . . . .	<b>3</b>	ASPECT, OVER SCAN, V POSITION, H POSITION, H PHASE, H SIZE, AUTO ADJUST EXECUTE	
<b>Preparations</b> . . . . .	<b>3</b>	<b>INPUT menu</b> . . . . .	<b>34</b>
Checking the contents of package . . . . .	3	PROGRESSIVE, VIDEO NR, COLOR SPACE, VIDEO FORMAT, HDMI FORMAT, HDMI RANGE, COMPUTER IN, FRAME LOCK, RESOLUTION	
Fastening the lens cover . . . . .	4	<b>SETUP menu</b> . . . . .	<b>38</b>
<b>Part names</b> . . . . .	<b>5</b>	D-ZOOM, D-SHIFT V, D-SHIFT H, PICT. POSIT. H, KEYSTONE, ECO MODE, MIRROR, STANDBY MODE, MONITOR OUT	
Projector . . . . .	5	<b>AUDIO menu</b> . . . . .	<b>40</b>
Control panel . . . . .	6	VOLUME, SPEAKER, AUDIO SOURCE, HDMI AUDIO	
Rear panel . . . . .	6	<b>SCREEN menu</b> . . . . .	<b>41</b>
Remote control . . . . .	7	LANGUAGE, MENU POSITION, BLANK, START UP, MyScreen, MyScreen Lock, MESSAGE, SOURCE NAME, TEMPLATE, C.C.	
<b>Setting up</b> . . . . .	<b>8</b>	<b>OPTION menu</b> . . . . .	<b>47</b>
Arrangement . . . . .	8	AUTO SEARCH, DIRECT POWER ON, AUTO POWER OFF, LAMP TIME, FILTER TIME, MY BUTTON, MY SOURCE, SERVICE	
Connecting your devices . . . . .	10	<b>NETWORK menu</b> . . . . .	<b>55</b>
Connecting power supply . . . . .	14	SETUP, PROJECTOR NAME, MY IMAGE, AMX D.D., INFORMATION, SERVICE	
Using the security bar and slot . . . . .	14	<b>SECURITY menu</b> . . . . .	<b>60</b>
<b>Remote control</b> . . . . .	<b>15</b>	SECURITY PASSWORD CHANGE, MyScreen PASSWORD, PIN LOCK, TRANSITION DETECTOR, MY TEXT PASSWORD, MY TEXT DISPLAY, MY TEXT WRITING	
Installing the batteries . . . . .	15	<b>Maintenance</b> . . . . .	<b>66</b>
About the remote control signal . . . . .	15	Replacing the lamp . . . . .	66
Changing the frequency of remote control signal . . . . .	16	Cleaning and replacing the air filter . . . . .	68
<b>Power on/off</b> . . . . .	<b>17</b>	Replacing the internal clock battery . . . . .	69
Turning on the power . . . . .	17	Other care . . . . .	70
Turning off the power . . . . .	17	<b>Troubleshooting</b> . . . . .	<b>71</b>
<b>Operating</b> . . . . .	<b>18</b>	Related messages . . . . .	72
Adjusting the volume . . . . .	18	Regarding the indicator lamps . . . . .	73
Temporarily muting the sound . . . . .	18	Shutting the projector down . . . . .	75
Selecting an input signal . . . . .	18	Resetting all settings . . . . .	75
Searching an input signal . . . . .	20	Phenomena that may be easy to be mistaken for machine defects . . . . .	75
Selecting an aspect ratio . . . . .	20	<b>Specifications</b> . . . . .	<b>80</b>
Adjusting the projector's elevator . . . . .	21		
Adjusting the focus . . . . .	21		
Using the automatic adjustment feature . . . . .	22		
Adjusting the position . . . . .	22		
Correcting the keystone distortions . . . . .	23		
Using the magnify feature . . . . .	23		
Temporarily freezing the screen . . . . .	24		
Temporarily blanking the screen . . . . .	24		
Using the menu function . . . . .	25		
<b>EASY MENU</b> . . . . .	<b>27</b>		
ASPECT, D-ZOOM, KEYSTONE, PICTURE MODE, ECO MODE, MIRROR, RESET, FILTER TIME, LANGUAGE, ADVANCED MENU, EXIT			
<b>PICTURE menu</b> . . . . .	<b>29</b>		
BRIGHTNESS, CONTRAST, GAMMA,			

## Projector features

The projector provides you with the broad use by the following features.

- ✓ The unique optics system produces a large projected image in a short distance, which provides you with various ways of use.
- ✓ The double layer filter system is expected to function longer and offers you less maintenance frequency.
- ✓ The HDMI port can support various image equipment which have digital interface to get clearer pictures on a screen.
- ✓ This projector can be controlled and monitored via LAN connection.
- ✓ This projector's network supports the PJLink™ standard.
- ✓ PJLink™ is a unified standard for operating and controlling data projectors. PJLink™ enables central control of projectors manufactured by different vendors and projectors can be operated by a controller. PJLink™ compliant equipment can be managed and controlled at any time and in any place, regardless of manufacturer.

For the command of PJLink™, see "Technical".

For specifications of PJLink™, see the web site of the Japan Business Machine and Information System Industries Association.

URL: <http://pjlink.jbmia.or.jp>

## Preparations

### Checking the contents of package

Your projector should come with the items shown below. Check that all the items are included. Require of your dealer immediately if any items are missing.

- (1) Remote control with two AA batteries
- (2) Power cord
- (3) Computer cable
- (4) Lens cover and Strap
- (5) User's manuals (Book x1, CD x1)
- (6) Security label

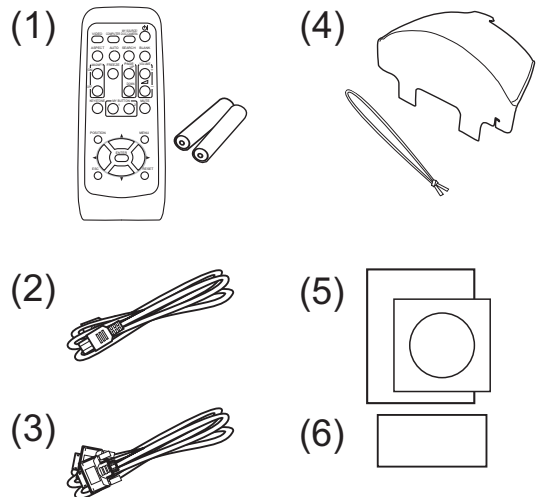

**NOTE** • Keep the original packing materials, for future reshipment. Be sure to use the original packing materials when moving the projector. Use special caution for the lens.

## Fastening the lens cover

To avoid losing the cover, please fasten the lens cover to the projector using the included strap.

1. Fasten the strap to the strap hole as shown in the figure for step 1. Please note that the knot on the strap is used to fasten it to the lens cover in step 2.
2. Put the strap end into the slit of the lens cover with the knot on the side of the lens. Make sure that the strap is inserted to the end of the slit.

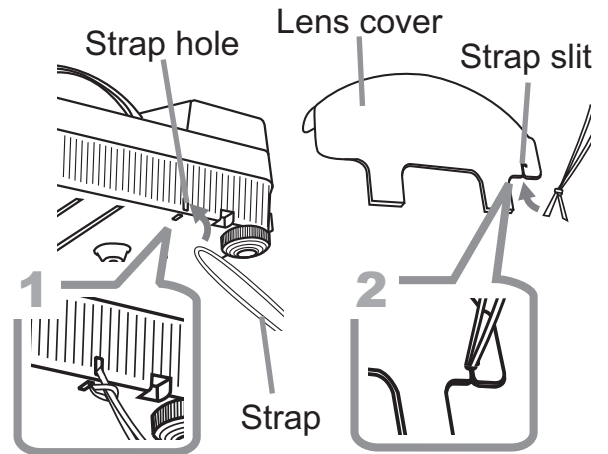

**⚠ CAUTION** ► Do not hang the lens cover in front of the lens when the projector is mounted upside down such as when mounted on the ceiling. Otherwise, the lens cover may block the light from the projector or hit the lens, which may cause damage to it. When mounting the projector upside down, hang the lens cover on the side of the projector or place it on the projector. For instance, wrap the strap around the elevator foot to hang the lens cover (refer to the figure).

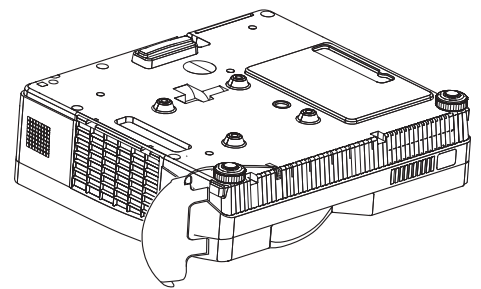

## Part names

## Projector

- (1) Lamp cover (📖66)  
The lamp unit is inside.
- (2) Focus ring (📖21)
- (3) Control panel (📖6)
- (4) Elevator buttons (x 2) (📖21)
- (5) Elevator feet (x 2) (📖21)
- (6) Remote sensor (📖15)
- (7) Lens (📖70)
- (8) Intake vents
- (9) Filter cover (📖68)  
The air filter and intake vent are inside.
- (10) Speaker (📖40)
- (11) Exhaust vent
- (12) **AC IN** (AC inlet) (📖14)
- (13) Rear panel (📖6)
- (14) Security bar (📖14)
- (15) Security slot (📖14)
- (16) Strap hole (📖4)
- (17) Battery cover (📖69)

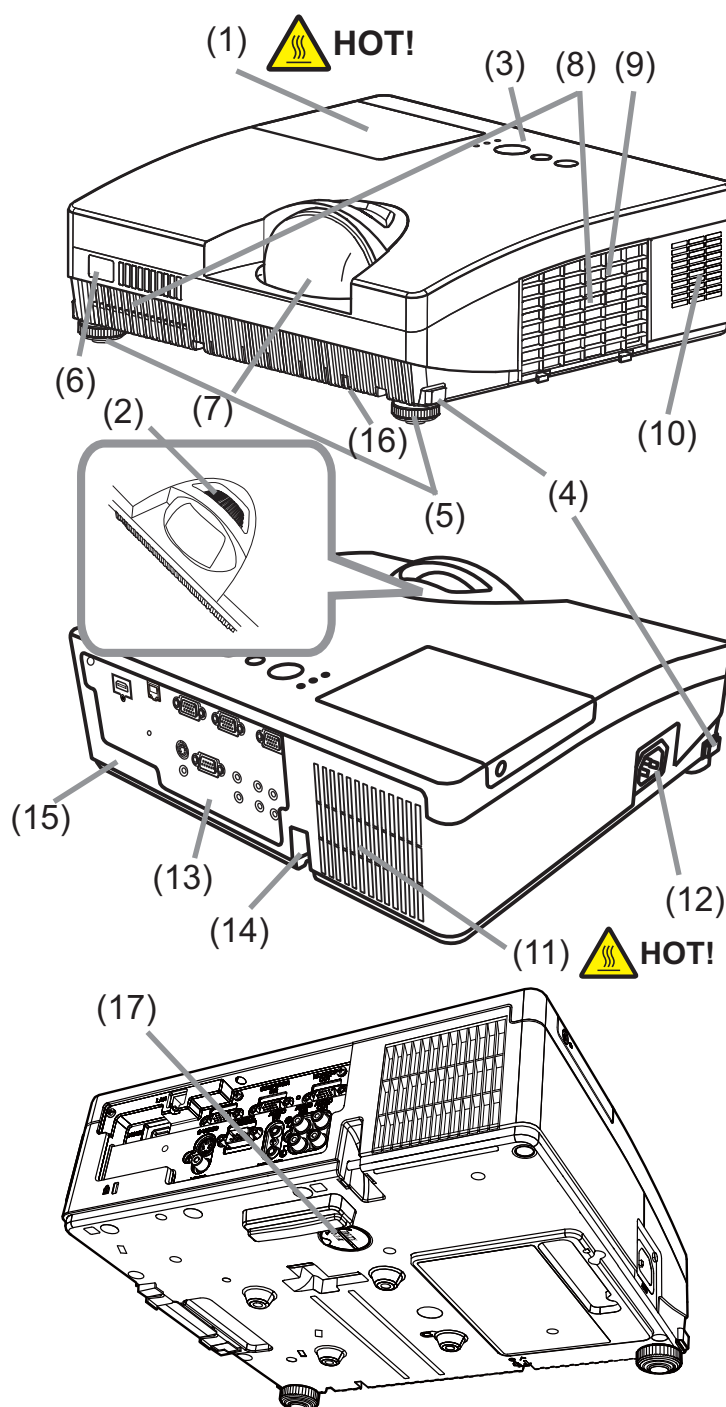

**⚠ WARNING ► HOT!** : Do not touch around the lamp cover and the exhaust vent during use or just after use, since it is too hot.

► Do not look into the lens or vent while the lamp is on, since the strong light is not good for your eyes.

► Do not handle the elevator buttons without holding the projector, since the projector may drop down.

**⚠ CAUTION ►** Maintain normal ventilation to prevent the projector from heating up. Do not cover, block or plug up the vents. Do not place anything that can stick or be sucked to the vents, around the intake vents. Clean the air filter periodically.

► Do not use the security bar and slot to prevent the projector from falling down, since it is not designed for it.

## Control panel

- (1) **STANDBY/ON** button (📖17)
- (2) **INPUT** button (📖18, 25)
- (3) **MENU** button (📖25)  
It consists of four cursor buttons.
- (4) **POWER** indicator (📖14, 17, 73)
- (5) **TEMP** indicator (📖73)
- (6) **LAMP** indicator (📖73)

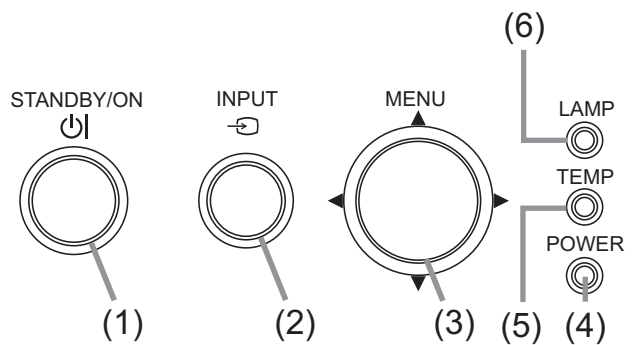

## Rear panel (📖10)

- (1) **AUDIO IN1** port
- (2) **AUDIO IN2** port
- (3) **COMPUTER IN1** port
- (4) **COMPUTER IN2** port
- (5) **MONITOR OUT** port
- (6) Shutdown switch (📖75)
- (7) **CONTROL** port
- (8) **VIDEO** port
- (9) **S-VIDEO** port
- (10) **AUDIO IN3 (R, L)** ports
- (11) **AUDIO OUT (R, L)** ports
- (12) **HDMI** port
- (13) **LAN** port

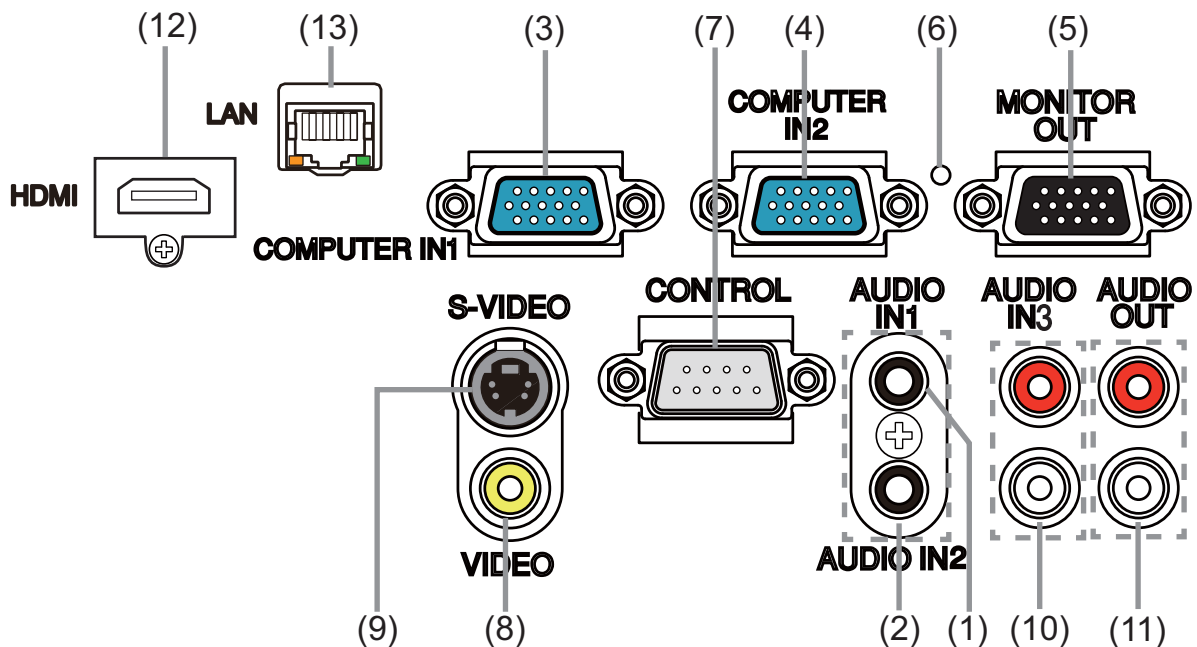

**⚠ CAUTION** ► Use the shutdown switch only when the projector is not turned off by normal procedure, since pushing this switch stops operation of the projector without cooling it down.

## Remote control

- (1) **VIDEO** button (📖 19)
- (2) **COMPUTER** button (📖 19)
- (3) **SEARCH** button (📖 20)
- (4) **STANDBY/ON** button (📖 17)
- (5) **ASPECT** button (📖 20)
- (6) **AUTO** button (📖 22)
- (7) **BLANK** button (📖 24)
- (8) **MAGNIFY - ON** button (📖 23)
- (9) **MAGNIFY - OFF** button (📖 16, 23)
- (10) **MY SOURCE/DOC.CAMERA** button (📖 19, 49)
- (11) **VOLUME -** button (📖 16, 18)
- (12) **PAGE UP** button \*
- (13) **PAGE DOWN** button \*
- (14) **VOLUME +** button (📖 18)
- (15) **MUTE** button (📖 18)
- (16) **FREEZE** button (📖 24)
- (17) **MY BUTTON - 1** button (📖 49)
- (18) **MY BUTTON - 2** button (📖 49)
- (19) **KEystone** button (📖 23)
- (20) **POSITION** button (📖 22, 26)
- (21) **MENU** button (📖 25)
- (22) **▲/▼/◀/▶** cursor buttons (📖 25)
- (23) **ENTER** button (📖 25)
- (24) **ESC** button (📖 25)
- (25) **RESET** button (📖 25)
- (26) **Battery cover** (📖 15)

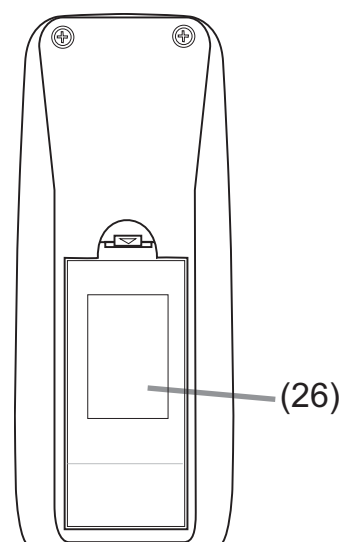
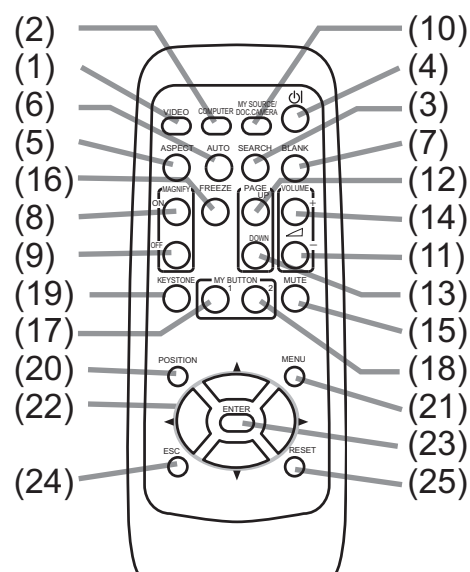

Back of  
the remote control

**NOTE** • Any button marked with “\*” is not supported on this projector (📖 72).

## Setting up

Install the projector according to the environment and manner the projector will be used in.

### Arrangement

Refer to the illustrations and tables below to determine screen size and projection distance.

The values shown in the table are calculated for a full size screen: 1280 x 800

- Ⓐ Screen size (diagonal)      Ⓑ Projection distance (±8%)  
 Ⓒ1, Ⓒ2 Screen height

On a horizontal surface

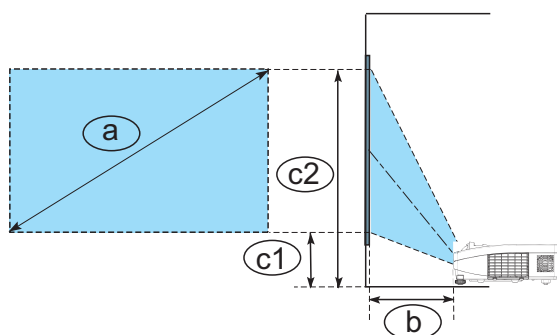

Suspended from the ceiling

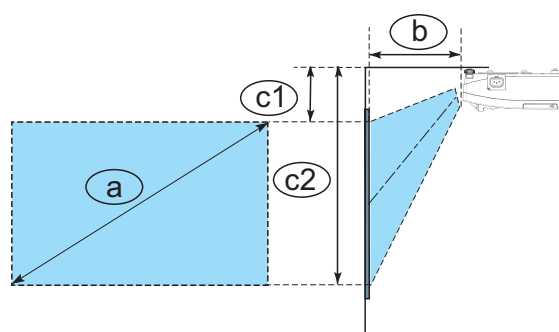

Ⓐ Screen size (diagonal)		Ⓑ Projection distance		Ⓒ1 Screen height		Ⓒ2 Screen height	
type(inch)	m	m	inch	m	inch	m	inch
60	1.5	0.634	25	0.264	10	1.072	42
70	1.8	0.748	29	0.298	12	1.240	49
80	2.0	0.862	34	0.331	13	1.408	55
90	2.3	0.975	38	0.364	14	1.575	62
100	2.5	1.089	43	0.397	16	1.743	69

- Keep a space of 30 cm or more between the sides of the projector and other objects such as walls.
- For the case of installation in a special state such as ceiling mount, the specified mounting accessories (📖 80) and service may be required. Before installing the projector, consult your dealer about your installation.
- The screen position may shift after installation if the projector is suspended from the ceiling or other location due to the flexibility of the plastic projector body. If readjustment is necessary, consult with your dealer or service personnel.
- The projected image position and/or focus may change during warm-up (approx. 30 minutes after the lamp is turned on) or when the ambient conditions change. Readjust the image position and/or focus as necessary.



**Arrangement (continued)**

**⚠ WARNING** ► Place the projector in a stable horizontal position. If the projector falls or is knocked over, it could cause injury and/or damage to the projector. Using a damaged projector could then result in fire and/or electric shock.

- Do not place the projector on an unstable, slanted or vibrational surface such as a wobbly or inclined stand.
- Do not place the projector on its side, front or rear position.
- Consult with your dealer before a special installation such as suspending from a ceiling or somewhere else.
- Place the projector in a cool place, and ensure that there is sufficient ventilation. The high temperature of the projector could cause fire, burns and/or malfunction of the projector.
- Do not place or attach anything that would block the lens or vent holes.
- Keep a space of 30 cm or more between the sides of the projector and other objects such as walls.
- Do not place the projector on metallic thing or anything weak in heat.
- Do not place the projector on carpet, cushions or bedding.
- Do not place the projector in direct sunlight or near hot objects such as heaters. Do not place the projector where the air from an air conditioner or similar unit will blow on it directly.
- Do not place anything near the projector lens or vents, or on top of the projector.
- Do not place anything that may be sucked into or stick to the vents on the bottom of the projector. This projector has some intake vents also on the bottom.
- Do not place the projector anyplace where it may get wet. Getting the projector wet or inserting liquid into the projector could cause fire, electric shock and/or malfunction of the projector.
- Do not place the projector in a bathroom or the outdoors.
- Do not place anything containing liquid near the projector.
- Use only the mounting accessories the manufacturer specified, and leave installing and removing the projector with the mounting accessories to the service personnel.
- Read and keep the user's manual of the mounting accessories used.

**⚠ CAUTION** ► Avoid placing the projector in smoky, humid or dusty place. Placing the projector in such places could cause fire, electric shock and/or malfunction of the projector.

- Do not place the projector near humidifiers, smoking spaces or a kitchen.
- Position the projector to prevent light from directly hitting the projector's remote sensor.
- Do not place the product in a place where radio interference may be caused.
- Do not place this product in a magnetic field.

**NOTE** • The projector may make a rattling sound when tilted, moved or shaken, since a flap to control the air flow inside of the projector has moved. Be aware that this is not a failure or malfunction.

## Connecting your devices

Be sure to read the manuals for devices before connecting them to the projector. Make sure that all the devices are suitable to be connected with this product, and prepare the cables required to connect. Please refer to the following illustrations to connect them.

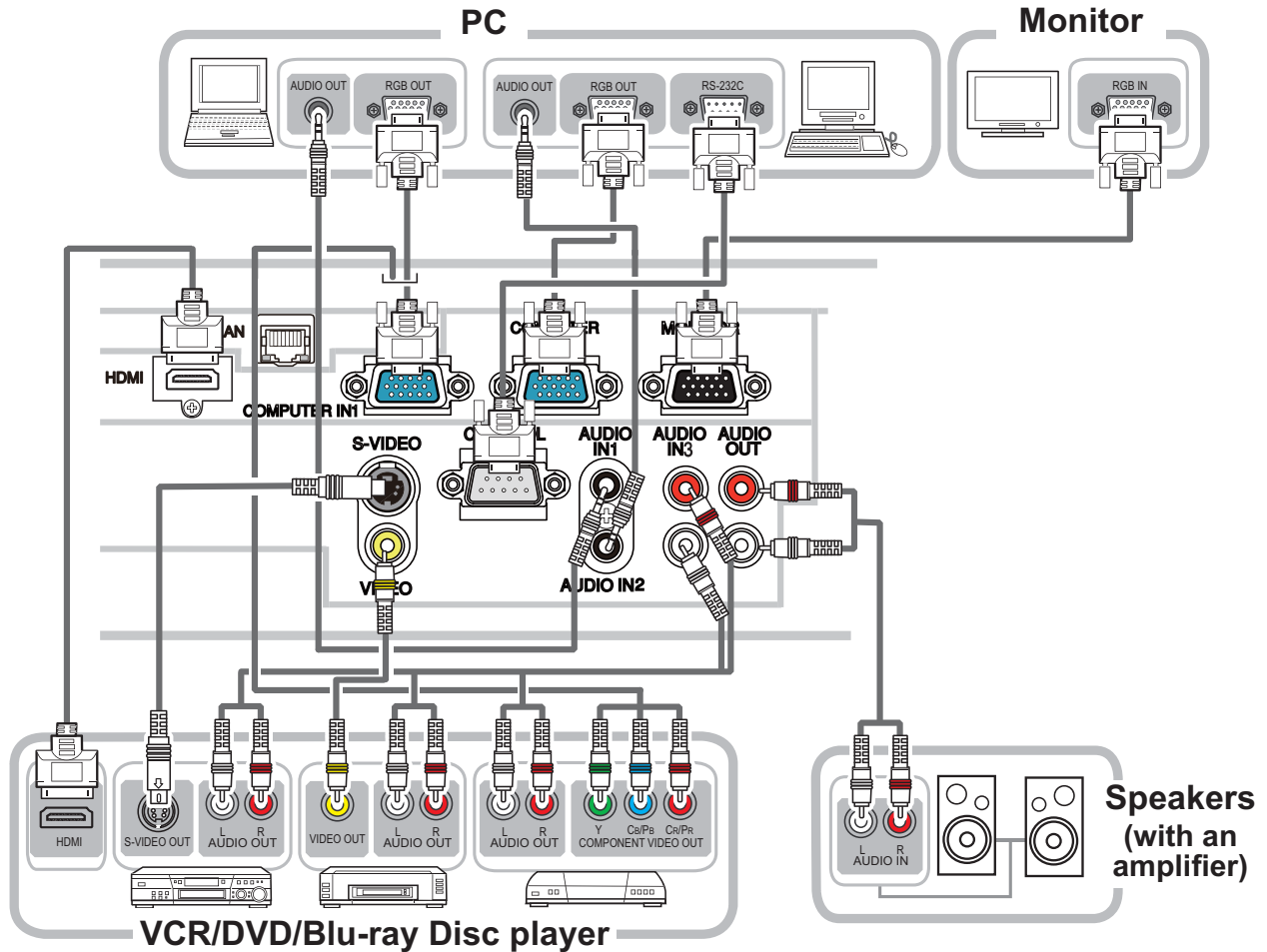

## Connecting your devices (continued)

To use network functions of the projector, connect the LAN port to the computer's LAN port.

To use NETWORK BRIDGE function, also connect the CONTROL port and an RS-232C port of the external device to communicate as a network terminal. See the User's Manual - Network Guide for details of network functions.

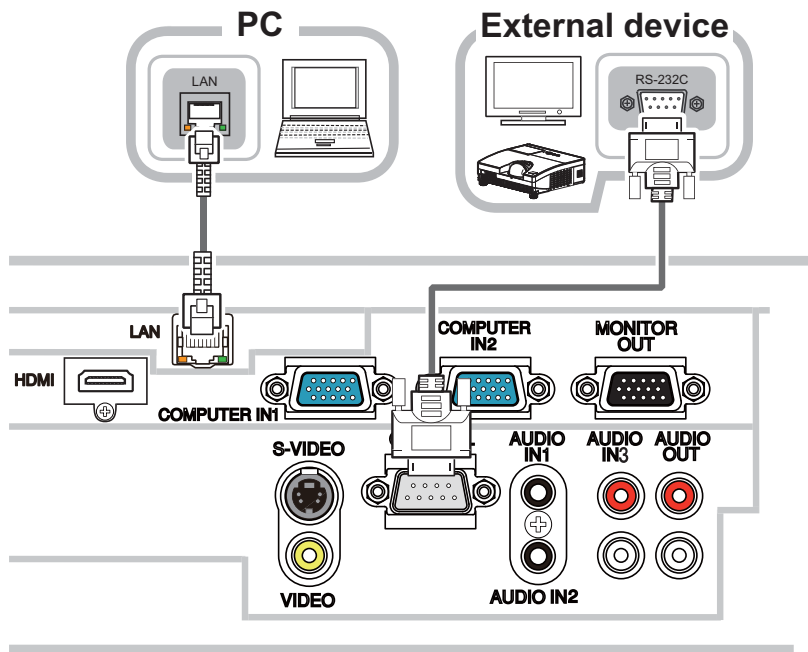

**⚠ WARNING** ▶ Do not disassemble or modify the projector and accessories.

▶ Be careful not to damage the cables, and do not use damaged cables.

**⚠ CAUTION** ▶ Turn off all devices and unplug their power cords prior to connecting them to projector. Connecting a live device to the projector may generate extremely loud noises or other abnormalities that may result in malfunction or damage to the device and the projector.

▶ Use appropriate accessory or designated cables. Ask your dealer about non-accessory cables which may be required a specific length or a ferrite core by the regulations. For cables with a core only at one end, connect the end with the core to the projector.

▶ Make sure that devices are connected to the correct ports. An incorrect connection may result in malfunction or damage to the device and the projector.

▶ Be sure to consult the administrator of the network. Do not connect LAN port to any network that might have the excessive voltage.

**NOTICE** ▶ Use the cables with straight plugs, not L-shaped ones, as the input ports of the projector are recessed.

**NOTE** • The **COMPUTER IN1/2** port can support a component signal also. The specific adapter or the specific cable is required for a component video input to the projector.

## Connecting your devices (continued)

- NOTE** • Be sure to read the manuals for devices before connecting them to the projector, and make sure that all the devices are suitable to be connected with this product. Before connecting to a PC, check the signal level, the signal timing, and the resolution.
- Some signal may need an adapter to input this projector.
  - Some PCs have multiple screen display modes that may include some signals which are not supported by this projector.
  - Although the projector can display signals with resolution up to UXGA (1600X1200), the signal will be converted to the projector's panel resolution before being displayed. The best display performance will be achieved if the resolutions of the input signal and the projector panel are identical.
  - While connecting, make sure that the shape of the cable's connector fits the port to connect with. And be sure to tighten the screws on connectors with screws.
  - When connecting a laptop PC to the projector, be sure to activate the PC's external RGB output. (Set the laptop PC to CRT display or to simultaneous LCD and CRT display.) For details on how this is done, please refer to the instruction manual of the corresponding laptop PC.
  - When the picture resolution is changed on a PC depending on an input, automatic adjustment function may take some time and may not be completed. In this case, you may not be able to see a check box to select "Yes/No" for the new resolution on Windows. Then the resolution will go back to the original. It might be recommended to use other CRT or LCD monitors to change the resolution.
  - In some cases, this projector may not display a proper picture or display any picture on screen. For example, automatic adjustment may not function correctly with some input signals. An input signal of composite sync or sync on G may confuse this projector, so the projector may not display a proper picture.
  - The **HDMI** port of this model is compatible with HDCP (High-bandwidth Digital Content Protection) and therefore capable of displaying a video signal from HDCP compatible DVD players or the like.

## Connecting your devices (continued)

### About Plug-and-Play capability

Plug-and-Play is a system composed of a PC, its operating system and peripheral equipment (i.e. display devices). This projector is VESA DDC 2B compatible. Plug-and-Play can be used by connecting this projector to a PC that is VESA DDC (display data channel) compatible.

- Take advantage of this feature by connecting a computer cable to the **COMPUTER IN1** port (DDC 2B compatible). Plug-and-Play may not work properly if any other type of connection is attempted.
- Please use the standard drivers in your PC as this projector is a Plug-and-Play monitor.

### NOTE for HDMI

- The **HDMI** supports the following signals.
  - Video signal : 480i@60,480p@60,576i@50,576p@50,720p@50/60,1080i@50/60,1080p@50/60
  - PC signals : See **User's Manual(detailed) - Technical**
- This projector can be connected with another equipment that has HDMI or DVI connector, but with some equipment the projector may not work properly, something like no video.
- Be sure to use an HDMI cable that has the HDMI logo.
- When the projector is connected with a device having DVI connector, use a DVI to HDMI cable to connect with the **HDMI** input.

## Connecting power supply

1. Put the connector of the power cord into the **AC IN** (AC inlet) of the projector.
2. Firmly plug the power cord's plug into the outlet. In a couple of seconds after the power supply connection, the **POWER** indicator will light up in steady orange.

Please remember that when the DIRECT POWER ON function activated (📖47), the connection of the power supply make the projector turn on.

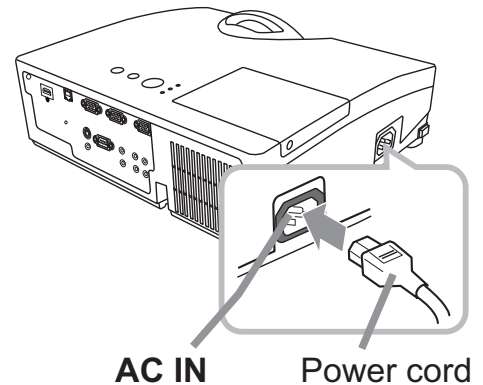

**⚠ WARNING** ▶ Please use extra caution when connecting the power cord, as incorrect or faulty connections may result in fire and/or electrical shock.

- Only use the power cord that came with the projector. If it is damaged, consult your dealer to get a new one.
- Only plug the power cord into an outlet whose voltage is matched to the power cord. The power outlet should be close to the projector and easily accessible. Remove the power cord for complete separation.
- Never modify the power cord.

## Using the security bar and slot

A commercial anti-theft chain or wire up to 10 mm in diameter can be attached to the security bar on the projector. Also this product has the security slot for the Kensington lock. For details, see the manual of the security tool.

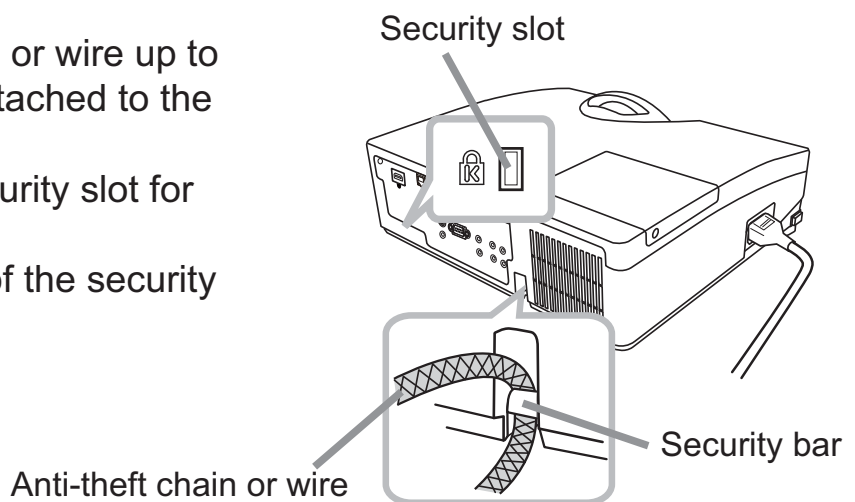

**⚠ WARNING** ▶ Do not use the security bar and slot to prevent the projector from falling down, since it is not designed for it.

**⚠ CAUTION** ▶ Do not place anti-theft chain or wire near the exhaust vent. It may become too hot.

**NOTE** • The security bar and slot is not comprehensive theft prevention measures. It is intended to be used as supplemental theft prevention measure.

## Remote control

## Installing the batteries

Please insert the batteries into the remote control before using it. If the remote control starts to malfunction, try to replace the batteries. If you will not use the remote control for long period, remove the batteries from the remote control and store them in a safe place.

1. Holding the hook part of the battery cover, remove it.
2. Align and insert the two AA batteries (**HITACHI MAXELL, Part No. LR6 or R6P**) according to their plus and minus terminals as indicated in the remote control.
3. Replace the battery cover in the direction of the arrow and snap it back into place.

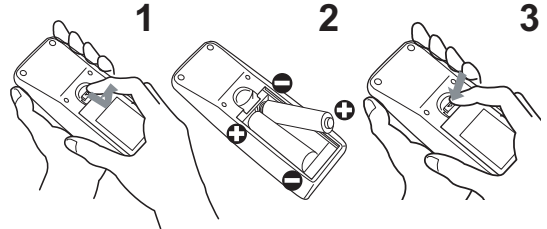

**⚠ WARNING** ► Always handle the batteries with care and use them only as directed. Improper use may result in battery explosion, cracking or leakage, which could result in fire, injury and/or pollution of the surrounding environment.

- Be sure to use only the batteries specified. Do not use batteries of different types at the same time. Do not mix a new battery with used one.
- Make sure the plus and minus terminals are correctly aligned when loading a battery.
- Keep a battery away from children and pets.
- Do not recharge, short circuit, solder or disassemble a battery.
- Do not place a battery in a fire or water. Keep batteries in a dark, cool and dry place.
- If you observe battery leakage, wipe out the leakage and then replace a battery. If the leakage adheres to your body or clothes, rinse well with water immediately.
- Obey the local laws on disposing the battery.

## About the remote control signal

The remote control works with the projector's remote sensor. This projector has a remote sensor on the front. The sensor senses the signal within the following range when the sensor is active:

60 degrees (30 degrees to the left and right of the sensor) within 3 meters about.

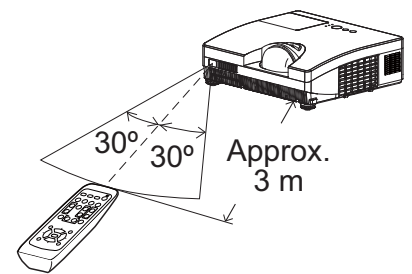

**NOTE** • The remote control signal reflected in the screen or the like may be available. If it is difficult to send the signal to the sensor directly, attempt to make the signal reflect.

- The remote control uses infrared light to send signals to the projector (Class 1 LED), so be sure to use the remote control in an area free from obstacles that could block the remote control's signal to the projector.
- The remote control may not work correctly if strong light (such as direct sun light) or light from an extremely close range (such as from an inverter fluorescent lamp) shines on the remote sensor of the projector. Adjust the position of projector avoiding those lights.

## Changing the frequency of remote control signal

The accessory remote control has the two choices on signal frequency, Mode 1:NORMAL and Mode 2:HIGH. If the remote control does not function properly, attempt to change the signal frequency.

In order to set the Mode, please keep pressing the combination of the two buttons listed below simultaneously for about 3 seconds.

(1) Set to Mode 1:NORMAL... the **VOLUME -** and the **RESET** buttons

(2) Set to Mode 2:HIGH... the **MAGNIFY OFF** and the **ESC** buttons

Please remember that the REMOTE FREQ. in the SERVICE item of the OPTION menu (📖 51) of the projector to be controlled should be set to the same mode as the remote control.

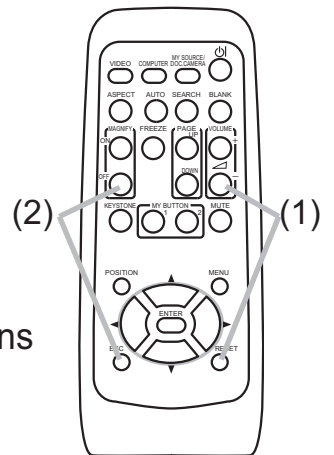



## Power on/off

### Turning on the power

1. Make sure that the power cord is firmly and correctly connected to the projector and the outlet.
2. Make sure that the **POWER** indicator is steady orange (📖73). Then remove the lens cover.
3. Press the **STANDBY/ON** button on the projector or the remote control.  
The projection lamp will light up and the **POWER** indicator will begin blinking in green. When the power is completely on, the indicator will stop blinking and light in steady green (📖73).

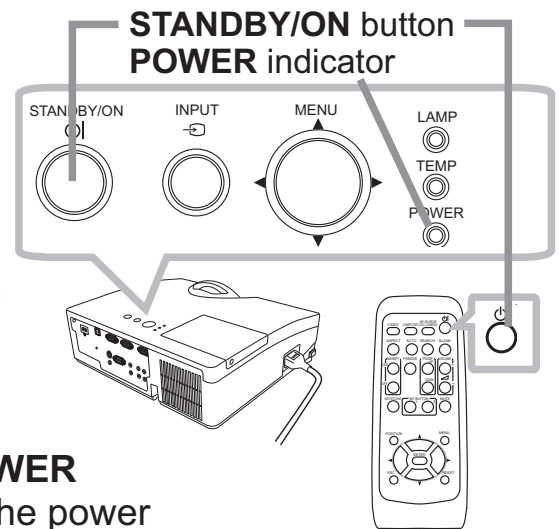

To display the picture, select an input signal according to the section “Selecting an input signal” (📖18).

### Turning off the power

1. Press the **STANDBY/ON** button on the projector or the remote control. The message “Power off?” will appear on the screen for about 5 seconds.
2. Press the **STANDBY/ON** button again while the message appears.  
The projector lamp will go off, and the **POWER** indicator will begin blinking in orange. Then the **POWER** indicator will stop blinking and light in steady orange when the lamp cooling is complete (📖73).
3. Attach the lens cover, after the **POWER** indicator turns in steady orange.

Do not turn the projector on for about 10 minutes or more after turning it off. Turning the projector on again too soon could shorten the lifetime of some consumable parts of the projector.

**⚠ WARNING** ▶ A strong light is emitted when the projector’s power is on. Do not look into the lens of the projector or look inside of the projector through any of the projector’s openings.

▶ Do not touch around the lamp cover and the exhaust vent during use or just after use, since it is too hot.

**NOTE** • Turn the power on/off in right order. Please power on the projector prior to the connected devices.

- This projector has the function that can make the projector automatically turn on/off. Please refer to the DIRECT POWER ON (📖47) and the AUTO POWER OFF (📖48) items of the OPTION menu.
- Use the shutdown switch (📖75) only when the projector is not turned off by normal procedure.

Operating

## Adjusting the volume

VOLUME +/- buttons

- Use the **VOLUME +/-** buttons to adjust the volume.
  - A dialog will appear on the screen to aid you in adjusting the volume. If you do not do anything, the dialog will automatically disappear after a few seconds.
  - When  $\times$  is selected for current picture input port, the volume adjustment is disabled. Please see the **AUDIO SOURCE** item of the **AUDIO** menu (📖40).
  - When the projector is in the standby state, the volume can be adjusted if  $\times$  is not selected for the **AUDIO OUT STANDBY** and the **NORMAL** is selected to the **STANDBY MODE** in the **SETUP** menu (📖39).

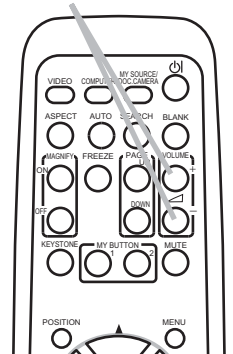

## Temporarily muting the sound

MUTE button

- Press the **MUTE** button on the remote control.
  - A dialog will appear on the screen indicating that you have muted the sound. To restore the sound, press the **MUTE**, **VOLUME +** or **VOLUME -** button. Even if you do not do anything, the dialog will automatically disappear after a few seconds.
  - When  $\times$  is selected for current picture input port, the sound is always muted. Please see the **AUDIO SOURCE** item of the **AUDIO** menu (📖40).
  - The C.C. (Closed Caption) is automatically activated when sound is muted and an input signal containing C.C. is received. This function is available only when the signal is NTSC for the **VIDEO** or **S-VIDEO**, or 480i@60 for the **COMPUTER IN1** or **COMPUTER IN2**, and when the **AUTO** is selected for the **DISPLAY** in the **C.C.** menu under the **SCREEN** menu (📖46).

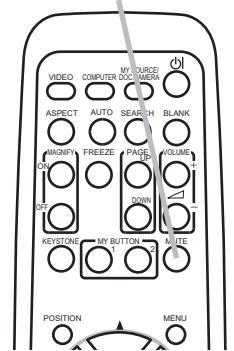

## Selecting an input signal

- Press the **INPUT** button on the projector.
  - Each time you press the button, the projector switches its input port from the current port as below.
 

→ COMPUTER IN1 → COMPUTER IN2  
 VIDEO ← S-VIDEO ← HDMI ←
  - While the **ON** is selected for the **AUTO SEARCH** item in the **OPTION** menu (📖47), the projector will keep checking the ports in above order repeatedly till an input signal is detected.

INPUT button

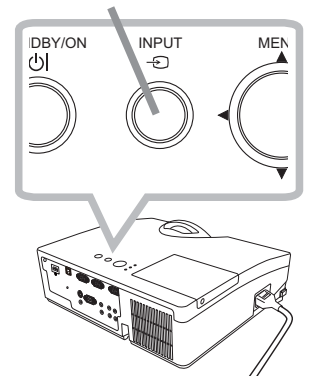

(continued on next page)

### Selecting an input signal (continued)

- 1 Press the **COMPUTER** button on the remote control.
  - Each time you press the button, the projector switches its input port from the current port as below.



- While the ON is selected for the AUTO SEARCH item in the OPTION menu, the projector will keep checking every port sequentially till an input signal is detected (📖47). If the **COMPUTER** button is pressed when the **VIDEO** or **S-VIDEO** port is selected, the projector will check the **COMPUTER IN1** port first.

**COMPUTER** button

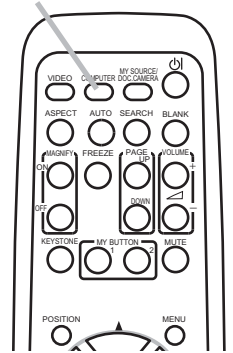

- 1 Press the **VIDEO** button on the remote control.
  - Each time you press the button, the projector switches its input port from the current port as below.



- While ON is selected for AUTO SEARCH item in OPTION menu, the projector will keep checking every port sequentially till an input signal is detected (📖47). If the **VIDEO** button is pressed when the **COMPUTER IN1** or the **COMPUTER IN2** port is selected, the projector will check the **S-VIDEO** port first.

**VIDEO** button

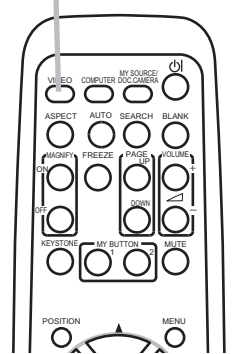

- 1 Press the **MY SOURCE / DOC. CAMERA** button on the remote control. The input signal will be changed into the signal you set as the MY SOURCE (📖49).

- This function also can use for document camera. Select the input port that connected the document camera.

**MY SOURCE / DOC. CAMERA** button

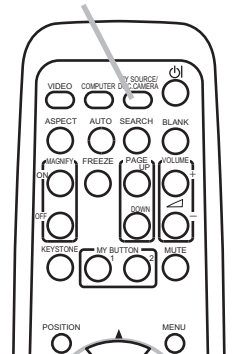

## Searching an input signal

1. Press the **SEARCH** button on the remote control.
  - The projector will start to check its input ports as below in order to find any input signals. When an input is found, the projector will stop searching and display the image. If no signal is found, the projector will return to the state selected before the operation.



- While the ON is selected for the AUTO SEARCH item in the OPTION menu (47), the projector will keep checking the ports in above order repeatedly till an input signal is detected.

SEARCH button

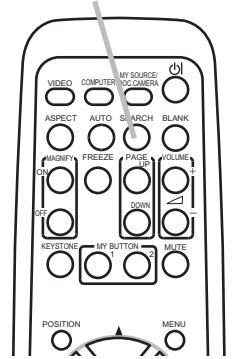

## Selecting an aspect ratio

1. Press the **ASPECT** button on the remote control.
  - Each time you press the button, the projector switches the mode for aspect ratio in turn.

○ For a computer signal

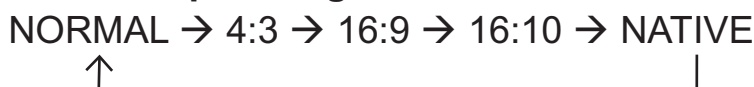

○ For an HDMI signal

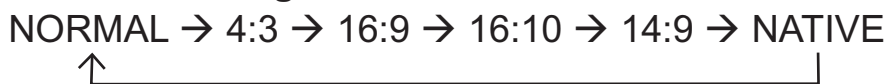

○ For a video signal, s-video signal or component video signal

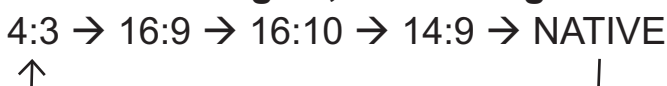

○ For no signal

16:10 (fixed)

- The **ASPECT** button does not work when no proper signal is inputted.
- The NORMAL mode keeps the original aspect ratio setting.
- The on-screen menu might be displayed outside of the image display area depending on the adjustment value of the ASPECT, D-ZOOM and KEYSTONE. Changing the values of ASPECT, D-ZOOM and KEYSTONE may fix the symptom.

ASPECT button

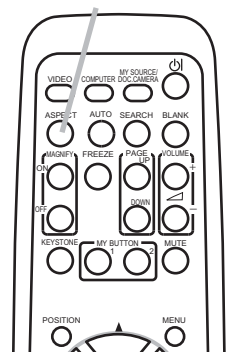

## Adjusting the projector's elevator

When the place to put the projector is slightly uneven to the left or right, use the elevator feet to place the projector horizontally.

Using the feet can also tilt the projector in order to project at a suitable angle to the screen, elevating the front side of the projector within 3 degrees.

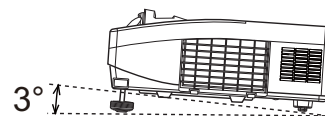

This projector has 2 elevator feet and 2 elevator buttons. An elevator foot is adjustable while pushing the elevator button on the same side as it.

1. Holding the projector, push the elevator buttons to loose the elevator feet.
2. Position the front side of the projector to the desired height.
3. Release the elevator buttons in order to lock the elevator feet.
4. After making sure that the elevator feet are locked, put the projector down gently.
5. If necessary, the elevator feet can be manually twisted to make more precise adjustments. Hold the projector when twisting the feet.

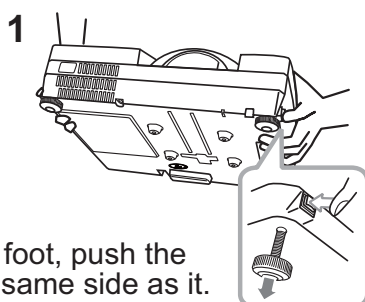

To loose an elevator foot, push the elevator button on the same side as it.

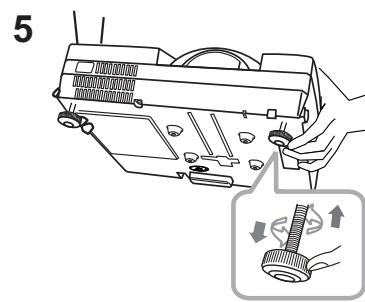

To finely adjust, twist the foot.

**⚠ CAUTION** ► Do not handle the elevator buttons without holding the projector, since the projector may drop down.

► Do not tilt the projector other than elevating its front within 3 degrees using the adjuster feet. A tilt of the projector exceeding the restriction could cause malfunction or shortening the lifetime of consumables, or the projector itself.

## Adjusting the focus

Use the focus ring to focus the picture.

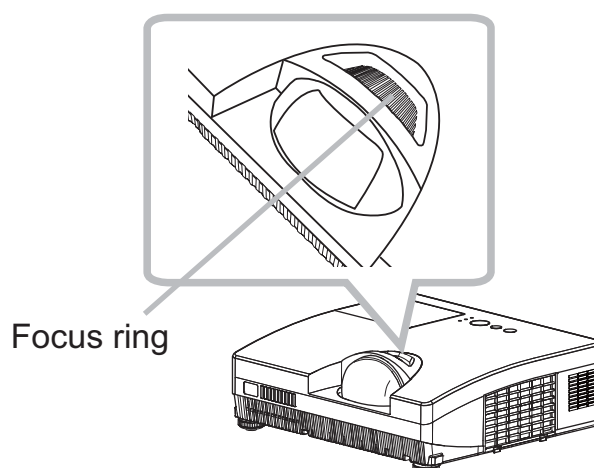

## Using the automatic adjustment feature

1. Press the **AUTO** button on the remote control.
  - Pressing this button performs the following.
    - **For a computer signal**  
The vertical position, the horizontal position and the horizontal phase will be automatically adjusted. Make sure that the application window is set to its maximum size prior to attempting to use this feature. A dark picture may still be incorrectly adjusted. Use a bright picture when adjusting.

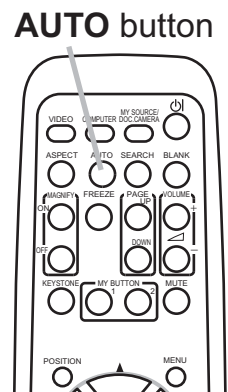

- **For a video signal and s-video signal**  
The video format best suited for the respective input signal will be selected automatically. This function is available only when the AUTO is selected for the VIDEO FORMAT item in the INPUT menu (📖35). The vertical position and horizontal position will be automatically set to the default.
- **For a component video signal**  
The vertical position and horizontal position will be automatically set to the default. The horizontal phase will be automatically adjusted.
  - The automatic adjustment operation requires approx. 10 seconds. Also please note that it may not function correctly with some input.
  - When this function is performed for a video signal, a certain extra such as a line may appear outside a picture.
  - When this function is performed for a computer signal, a black frame may be displayed on the edge of the screen, depending on the PC model.
  - The items adjusted by this function may vary when the FINE or DISABLE is selected for the AUTO ADJUST item of the SERVICE item in the OPTION menu (📖50).

## Adjusting the position

1. Press the **POSITION** button on the remote control while no menu is on screen, to display the D-SHIFT (📖38) dialog on screen.
2. Use the ▲, ▼, ◀ and ▶ buttons to adjust the picture position.
  - Press the **POSITION** button again to finish this operation.

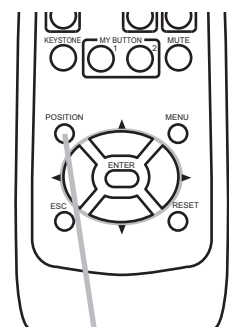

- This is a function to shift the position of the shrunken picture by the D-ZOOM (📖38) function.
- When an OSD (On Screen Display) menu is displayed, this operation moves the position of the OSD menu, but the picture position is not (📖26).
- The D-SHIFT adjustment values are not valid when the D-ZOOM is set to 320 (full screen).

## Correcting the keystone distortions

1. Press the **KEYSTONE** button on the remote control.
  - A dialog will appear on the screen to aid you in correcting the distortion.
2. Use the ◀/▶ cursor buttons for adjustment.
  - To close the dialog and complete this operation, press the **KEYSTONE** button again. Even if you do not do anything, the dialog will automatically disappear after a few seconds.

KEYSTONE button

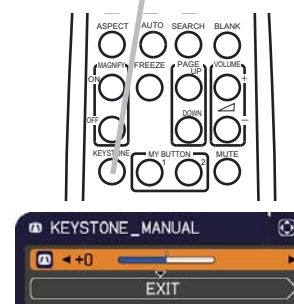

- The adjustable range of this function varies for each input signal. For some input, this function may not work well.
- When the projector is inclined to near  $\pm 6$  degrees or over, this function may not work well.
- This function will be unavailable when the Transition Detector is activated (📖 63).
- The OSD menu might be displayed outside of the image display area depending on the adjustment value of the ASPECT, D-ZOOM and KEYSTONE. Changing the values of ASPECT, D-ZOOM and KEYSTONE may fix the symptom.

## Using the magnify feature

1. Press the **MAGNIFY ON** button on the remote control. The picture will be magnified, and the MAGNIFY dialog will appear on the screen. When the **MAGNIFY ON** button is pressed for the first time after the projector is turned on, the picture will be zoomed by 1.5 times. On the dialog, triangle marks to show each direction will be displayed.
2. While the triangles are displayed on the dialog, use the ▲/▼/◀/▶ cursor buttons to shift the magnifying area.
3. A magnifying glass icon will be displayed on the dialog when the **MAGNIFY ON** button is pressed while the dialog with the triangles is displayed.
4. While the magnifying glass icon is displayed on the dialog, use the ▲/▼ cursor buttons to adjust the magnification ratio. The magnification ratio will be adjusted with fine steps. And changes in the ratio in single steps are subtle so they may be hard to recognize.
5. Press the **MAGNIFY OFF** button on the remote control to exit magnification.

MAGNIFY ON/OFF buttons

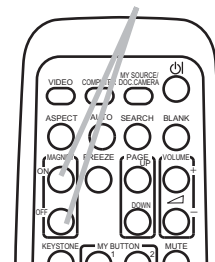

**NOTE** • The MAGNIFY dialog will automatically disappear in several seconds with no operation. The dialog will appear again if the **MAGNIFY ON** button is pressed when the dialog has automatically disappeared.

- While the MAGNIFY dialog is displayed, press the **MAGNIFY ON** button to switch the dialog between magnifying area shifting (with the triangles) and magnification ratio adjustment (with the magnifying glass icon).
- The magnification is automatically disabled when the displaying signal or its display condition is changed.
- While the magnification is active, the keystone distortion condition may vary. It will be restored when the magnification is disabled.
- Some horizontal stripes might be visible on the image while magnification is active.

## Temporarily freezing the screen

1. Press the **FREEZE** button on the remote control.
  - The “FREEZE” indication will appear on the screen (however, the indication will not appear when the OFF is selected for the MESSAGE item in the SCREEN menu (📖43)), and the projector will go into the FREEZE mode, which the picture is frozen.
  - To exit the FREEZE mode and restore the screen to normal, press the **FREEZE** button again.

**FREEZE** button

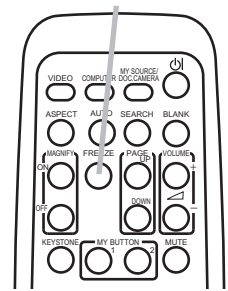

- The projector automatically exits from the FREEZE mode when some control buttons are pressed.
- If the projector continues projecting a still image for a long time, the LCD panel might possibly be burned in. Do not leave the projector in the FREEZE mode for too long.
- Images might appear degraded when this function is operated, but it is not a malfunction.

## Temporarily blanking the screen

1. Press the **BLANK** button on the remote control.
  - The BLANK screen will be displayed instead of the screen of input signal. Please refer to the BLANK item in the SCREEN menu (📖41).
  - To exit from the BLANK screen and return to the input signal screen, press the **BLANK** button again.

**BLANK** button

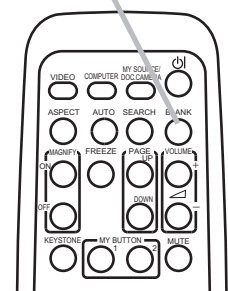

- The projector automatically exits from the BLANK mode when some control buttons are pressed.

**⚠ CAUTION** ► If you wish to have a blank screen while the projector's lamp is on, use the BLANK function above. Any other method of blocking the projection light, such as attaching something to the lens or placing something in front of the lens, may cause the damage to the projector.

**NOTE** • The sound is not connected with the BLANK screen function. If necessary, set the volume or mute first. To display the BLANK screen and mute the sound at one time, use the AV MUTE function (📖49).



## Using the menu function

This projector has the following menus:

PICTURE, IMAGE, INPUT, SETUP, AUDIO, SCREEN, OPTION, NETWORK, SECURITY and EASY MENU.

The EASY MENU consists of functions often used, and the other menus are classified into each purpose and brought together as the ADVANCED MENU. Each of these menus is operated using the same methods. While the projector is displaying any menu, the **MENU** button on the projector works as the cursor buttons. The basic operations of these menus are as follows.

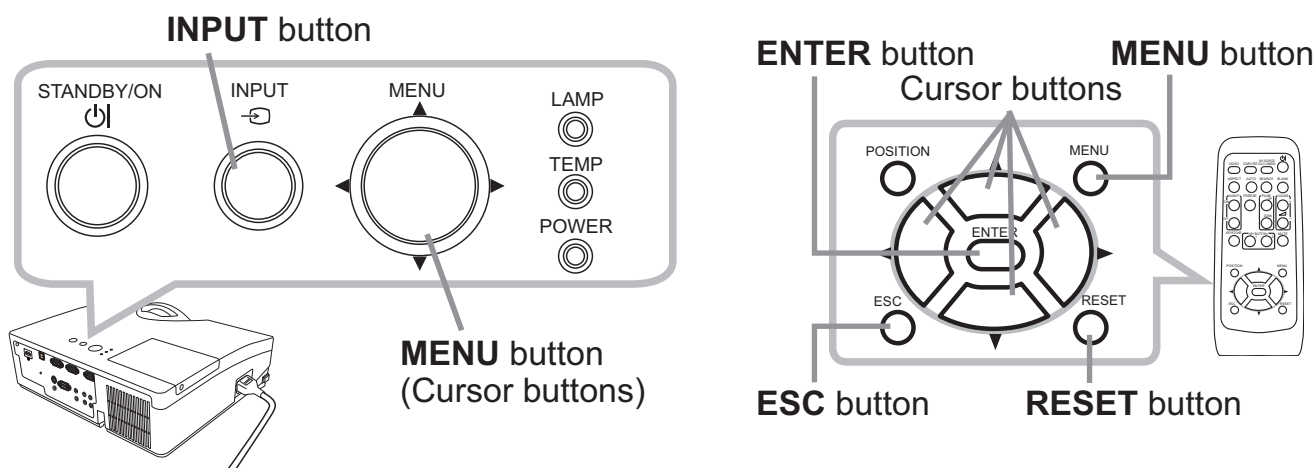

1. To start the MENU, press the **MENU** button. The MENU you last used (EASY or ADVANCED) will appear. The EASY MENU has priority to appear just after powered on.

### 2. In the EASY MENU

- (1) Use the ▲/▼ cursor buttons to select an item to operate. If you want to change it to the ADVANCED MENU, select the ADVANCED MENU.
- (2) Use the ◀/▶ cursor buttons to operate the item.



### In the ADVANCED MENU

- (1) Use the ▲/▼ cursor buttons to select a menu. The items in the menu appear on the right side. If you want to change it to the EASY MENU, select the EASY MENU.
- (2) Press the ▶ cursor (or the **ENTER**) button to move the cursor to the right side. Then use the ▲/▼ cursor buttons to select an item to operate and press the ▶ cursor (or the **ENTER**) button to progress. The operation menu or dialog of the selected item will appear.
- (3) Use the buttons as instructed in the OSD to operate the item.



(continued on next page)

### Using the menu function (continued)

3. To close the MENU, press the **MENU** button again or select the EXIT and press the ◀ cursor (or the **ENTER**) button. Even if you do not do anything, the dialog will automatically disappear after about 30 seconds.
- If you want to move the menu position, use the cursor buttons after pressing the **POSITION** button.
  - Some functions cannot be performed when a certain input port is selected, or when a certain input signal is displayed.
  - When you want to reset the operation, press the **RESET** button on the remote control during the operation. Note that some items (ex. LANGUAGE, VOLUME) cannot be reset.
  - In the ADVANCED MENU, when you want to return to the previous display, press the ◀ cursor (or the **ESC**) button on the remote control.

### Indication in OSD (On Screen Display)



The meanings of the general words on the OSD are as follows.

Indication	Meaning
EXIT	Selecting this word finishes the OSD menu. It's the same as pressing the <b>MENU</b> button on the remote control.
RETURN	Selecting this word returns the menu to the previous menu.
CANCEL or NO	Selecting this word cancels the operation in the present menu and returns to the previous menu.
OK or YES	Selecting this word executes the prepared function or shifts the menu to the next menu.

## EASY MENU

From the EASY MENU, items shown in the table below can be performed.

Select an item using the ▲/▼ cursor buttons. Then perform it according to the following table.

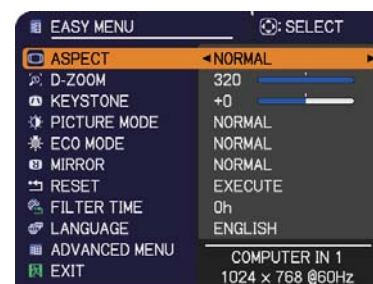

Item	Description																								
<b>ASPECT</b>	<p>Using the ◀/▶ cursor buttons switches the mode for aspect ratio. See the ASPECT item in the IMAGE menu (📖32).</p> <ul style="list-style-type: none"> <li>The on-screen menu might be displayed outside of the image display area depending on the adjustment value of the ASPECT, D-ZOOM and KEYSTONE. Changing the values of ASPECT, D-ZOOM and KEYSTONE may fix the symptom.</li> </ul>																								
<b>D-ZOOM</b>	<p>Using the ◀/▶ cursor buttons adjusts the magnification ratio. Small ⇄ Large</p> <p>See the D-ZOOM item in the SETUP menu (📖38).</p> <ul style="list-style-type: none"> <li>The on-screen menu might be displayed outside of the image display area depending on the adjustment value of the ASPECT, D-ZOOM and KEYSTONE. Changing the values of ASPECT, D-ZOOM and KEYSTONE may fix the symptom.</li> </ul>																								
<b>KEYSTONE</b>	<p>Using the ◀/▶ cursor buttons corrects the vertical keystone distortion. See the KEYSTONE item in the SETUP menu (📖38).</p> <ul style="list-style-type: none"> <li>The on-screen menu might be displayed outside of the image display area depending on the adjustment value of the ASPECT, D-ZOOM and KEYSTONE. Changing the values of ASPECT, D-ZOOM and KEYSTONE may fix the symptom.</li> </ul>																								
<b>PICTURE MODE</b>	<p>Using the ◀/▶ cursor buttons switches the picture mode. The picture modes are combinations of the GAMMA and the COLOR TEMP settings. Choose a suitable mode according to the projected source.</p> <p> </p> <table border="1"> <thead> <tr> <th></th> <th>GAMMA</th> <th>COLOR TEMP</th> </tr> </thead> <tbody> <tr> <td>NORMAL</td> <td>1 DEFAULT</td> <td>2 MID</td> </tr> <tr> <td>CINEMA</td> <td>2 DEFAULT</td> <td>3 LOW</td> </tr> <tr> <td>DYNAMIC</td> <td>3 DEFAULT</td> <td>1 HIGH</td> </tr> <tr> <td>BOARD(BLACK)</td> <td>4 DEFAULT</td> <td>4 Hi-BRIGHT-1</td> </tr> <tr> <td>BOARD(GREEN)</td> <td>4 DEFAULT</td> <td>5 Hi-BRIGHT-2</td> </tr> <tr> <td>WHITEBOARD</td> <td>5 DEFAULT</td> <td>2 MID</td> </tr> <tr> <td>DAYTIME</td> <td>6 DEFAULT</td> <td>6 Hi-BRIGHT-3</td> </tr> </tbody> </table> <ul style="list-style-type: none"> <li>When the combination of the GAMMA and the COLOR TEMP differs from pre-assigned modes above, the display on the menu for the PICTURE MODE is “CUSTOM”. Please refer to the GAMMA and the COLOR TEMP (📖29, 30) items in the PICTURE menu.</li> <li>Lines or other noise might appear on the screen when this function is operated, but it is not a malfunction.</li> </ul>		GAMMA	COLOR TEMP	NORMAL	1 DEFAULT	2 MID	CINEMA	2 DEFAULT	3 LOW	DYNAMIC	3 DEFAULT	1 HIGH	BOARD(BLACK)	4 DEFAULT	4 Hi-BRIGHT-1	BOARD(GREEN)	4 DEFAULT	5 Hi-BRIGHT-2	WHITEBOARD	5 DEFAULT	2 MID	DAYTIME	6 DEFAULT	6 Hi-BRIGHT-3
	GAMMA	COLOR TEMP																							
NORMAL	1 DEFAULT	2 MID																							
CINEMA	2 DEFAULT	3 LOW																							
DYNAMIC	3 DEFAULT	1 HIGH																							
BOARD(BLACK)	4 DEFAULT	4 Hi-BRIGHT-1																							
BOARD(GREEN)	4 DEFAULT	5 Hi-BRIGHT-2																							
WHITEBOARD	5 DEFAULT	2 MID																							
DAYTIME	6 DEFAULT	6 Hi-BRIGHT-3																							

## EASY MENU

Item	Description
<b>ECO MODE</b>	Using the ◀/▶ cursor buttons turns off/on the eco mode. See the ECO MODE item in the SETUP menu (📖38).
<b>MIRROR</b>	Using the ◀/▶ cursor buttons switches the mode for mirror status. See the MIRROR item in the SETUP menu (📖39).
<b>RESET</b>	Performing this item resets all of the EASY MENU items except the FILTER TIME and the LANGUAGE. A dialog is displayed for confirmation. Selecting the OK using the ▶ cursor button performs resetting.
<b>FILTER TIME</b>	The usage time of the air filter is shown in the menu. Performing this item resets the filter time which counts usage time of the air filter. A dialog is displayed for confirmation. Selecting the OK using the ▶ cursor button performs resetting. See the FILTER TIME item in the OPTION menu (📖48).
<b>LANGUAGE</b>	Using the ◀/▶ cursor buttons changes the display language. See the LANGUAGE item in the SCREEN menu (📖41).
<b>ADVANCED MENU</b>	Press the ▶ cursor (or the <b>ENTER</b> ) button to use the ADVANCED MENU.
<b>EXIT</b>	Press the ◀ cursor (or the <b>ENTER</b> ) button to finish the OSD menu.

PICTURE menu

From the PICTURE menu, items shown in the table below can be performed.



Select an item using the ▲/▼ cursor buttons, and press the ► cursor (or the **ENTER**) button to execute the item. Then perform it according to the following table.

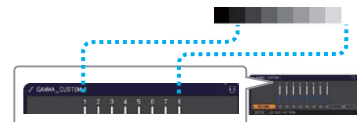
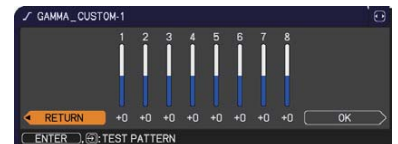

Item	Description
<b>BRIGHTNESS</b>	Using the ◀/▶ cursor buttons adjusts the brightness. Dark ⇔ Light
<b>CONTRAST</b>	Using the ◀/▶ cursor buttons adjusts the contrast. Weak ⇔ Strong
<b>GAMMA</b>	<p>Using the ▲/▼ cursor buttons switches the gamma mode.</p> <p>1 DEFAULT ⇔ 1 CUSTOM ⇔ 2 DEFAULT ⇔ 2 CUSTOM ⇔ 3 DEFAULT                      ⇕ ⇕                      6 CUSTOM ⇔ 3 CUSTOM                      ⇕ ⇕                      6 DEFAULT ⇔ 5 CUSTOM ⇔ 5 DEFAULT ⇔ 4 CUSTOM ⇔ 4 DEFAULT</p> <p><b>To adjust CUSTOM</b></p> <p>Selecting a mode whose name includes the <b>CUSTOM</b> and then pressing the ► cursor (or the <b>ENTER</b>) button displays a dialog to aid you in adjusting the mode.</p> <p>This function is useful when you want to change the brightness of particular tones.</p> <p>Choose an item using the ◀/▶ cursor buttons, and adjust the level using the ▲/▼ cursor buttons.</p> <p>You can display a test pattern for checking the effect of your adjustment by pressing the <b>ENTER</b> (or the <b>INPUT</b>) button. Each time you press the <b>ENTER</b> (or the <b>INPUT</b>) button, the pattern changes as below.</p> <p>No pattern ⇔ Gray scale of 9 steps ⇨                      ⇨ ⇨ Ramp ⇔ Gray scale of 15 steps</p> <p>The eight equalizing bars correspond to eight tone levels of the test pattern (Gray scale of 9 steps) except the darkest in the left end. If you want to adjust the 2nd tone from left end on the test pattern, use the equalizing adjustment bar "1". The darkest tone at the left end of the test pattern cannot be controlled with any of equalizing adjustment bar.</p> <ul style="list-style-type: none"> <li>• Lines or other noise might appear on the screen when this function is operated, but it is not a malfunction.</li> </ul>



(continued on next page)

Item	Description
<p><b>COLOR TEMP</b></p>	<p>Using the ▲/▼ cursor buttons switches the color temperature mode.</p> <p style="text-align: center;">             1 HIGH ⇔ 1 CUSTOM ⇔ 2 MID ⇔ 2 CUSTOM              ⇕              6 CUSTOM              ⇕              6 Hi-BRIGHT-3              ⇕              5 CUSTOM ⇔ 5 Hi-BRIGHT-2 ⇔ 4 CUSTOM ⇔ 4 Hi-BRIGHT-1  <span style="float: right;">⇕ 3 LOW ⇕ 3 CUSTOM ⇕</span> </p> <p><b>To adjust CUSTOM</b></p> <p>Selecting a mode whose name includes the CUSTOM and then pressing the ► cursor (or the <b>ENTER</b>) button displays a dialog to aid you in adjusting the OFFSET and GAIN of the selected mode.</p>  <p>The OFFSET adjustments change the color intensity on the whole tones of the test pattern.          GAIN adjustments mainly affect color intensity on the brighter tones of the test pattern.</p> <p>Choose an item using the ◀/▶ cursor buttons, and adjust the level using the ▲/▼ cursor buttons.</p> <p>You can display a test pattern for checking the effect of your adjustment by pressing the <b>ENTER</b> (or the <b>INPUT</b>) button.</p> <p>Each time you press the <b>ENTER</b> (or the <b>INPUT</b>) button, the pattern changes as below.</p> <p style="text-align: center;">             No pattern ⇔ Gray scale of 9 steps ↘              ↙ Ramp ⇔ Gray scale of 15 steps         </p> <ul style="list-style-type: none"> <li>• Lines or other noise might appear on the screen when this function is operated, but it is not a malfunction.</li> </ul> 
<p><b>COLOR</b></p>	<p>Using the ◀/▶ cursor buttons adjusts the strength of whole color.</p> <p style="text-align: center;">Weak ⇔ Strong</p> <ul style="list-style-type: none"> <li>• This item can be selected when input signals are video, s-video or component video signals.</li> <li>• When input signal is HDMI, this item can also be selected if either 1) or 2) applies.                     <ol style="list-style-type: none"> <li>1) HDMI FORMAT is set to VIDEO.</li> <li>2) HDMI FORMAT is set to AUTO, and the projector recognizes that it receives video signals.</li> </ol> </li> </ul>

(continued on next page)

Item	Description
<p><b>TINT</b></p>	<p>Using the ◀/▶ cursor buttons adjusts the tint.                      Reddish ↔ Greenish</p> <ul style="list-style-type: none"> <li>• This item can be selected when input signals are video, s-video or component video signals.</li> <li>• When input signal is HDMI, this item can also be selected if either 1) or 2) applies.                      1) HDMI FORMAT is set to VIDEO.                      2) HDMI FORMAT is set to AUTO, and the projector recognizes that it receives video signals.</li> </ul>
<p><b>SHARPNESS</b></p>	<p>Using the ◀/▶ cursor buttons adjusts the sharpness.                      Weak ↔ Strong</p> <ul style="list-style-type: none"> <li>• There may be some noise and/or the screen may flicker for a moment when an adjustment is made. This is not a malfunction.</li> </ul>
<p><b>MY MEMORY</b></p>	<p>This projector has 4 memories for adjustment data (for all the items of the PICTURE menu).                      Selecting a function using the ▲/▼ cursor buttons and pressing the ▶ cursor (or the <b>ENTER</b>) button performs each function.</p> <p>↻ SAVE-1 ↔ SAVE-2 ↔ SAVE-3 ↔ SAVE-4 ↻                      ↻ LOAD-4 ↔ LOAD-3 ↔ LOAD-2 ↔ LOAD-1 ↻</p> <p><u>SAVE-1, SAVE-2, SAVE-3, SAVE-4</u>                      Performing a SAVE function saves the current adjustment data into the memory linked in the number included in the function's name.</p> <ul style="list-style-type: none"> <li>• Remember that the current data being stored of a memory will be lost by saving new data into the memory.</li> </ul> <p><u>LOAD-1, LOAD-2, LOAD-3, LOAD-4</u>                      Performing a LOAD function loads the data from the memory linked in the number included in the function's name, and adjusts the picture automatically depending on the data.</p> <ul style="list-style-type: none"> <li>• The LOAD functions whose linked memory has no data are skipped.</li> <li>• Remember that the current adjusted condition will be lost by loading data. If you want to keep the current adjustment, please save it before performing a LOAD function.</li> <li>• There may be some noise and the screen may flicker for a moment when loading data. This is not malfunction.</li> <li>• You can perform the LOAD function using the <b>MY BUTTONS</b>. Please see the MY BUTTON item in the OPTION menu (📖49).</li> </ul>

IMAGE menu

From the IMAGE menu, items shown in the table below can be performed.

Select an item using the ▲/▼ cursor buttons, and press the ► cursor (or the **ENTER**) button to execute the item. Then perform it according to the following table.

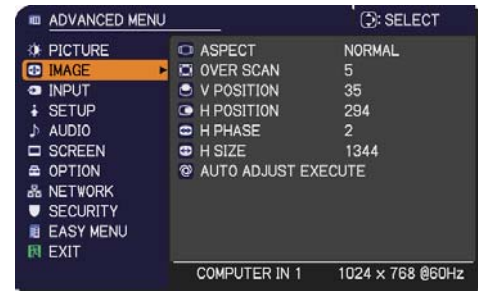

Item	Description
<p><b>ASPECT</b></p>	<p>Using the ▲/▼ cursor buttons switches the mode for aspect ratio.</p> <p><b>For a computer signal</b>                      NORMAL ⇔ 4:3 ⇔ 16:9 ⇔ 16:10 ⇔ NATIVE                      ↑↑↑↑↑↑↑↑↑↑↑↑</p> <p><b>For an HDMI signal</b>                      NORMAL ⇔ 4:3 ⇔ 16:9 ⇔ 16:10 ⇔ 14:9 ⇔ NATIVE                      ↑↑↑↑↑↑↑↑↑↑↑↑</p> <p><b>For a video signal, s-video signal or component video signal</b>                      4:3 ⇔ 16:9 ⇔ 16:10 ⇔ 14:9 ⇔ NATIVE                      ↑↑↑↑↑↑↑↑↑↑↑↑</p> <p><b>For no signal</b>                      16:10 (fixed)</p> <ul style="list-style-type: none"> <li>• The NORMAL mode keeps the original aspect ratio of the signal.</li> <li>• The on-screen menu might be displayed outside of the image display area depending on the adjustment value of the ASPECT, D-ZOOM and KEYSTONE. Changing the values of ASPECT, D-ZOOM and KEYSTONE may fix the symptom.</li> </ul>
<p><b>OVER SCAN</b></p>	<p>Using the ◀/▶ cursor buttons adjusts the over-scan ratio.                      Small (It magnifies picture) ⇔ Large (It reduces picture)</p> <ul style="list-style-type: none"> <li>• This item can be selected when input signals are video, s-video or component video signals.</li> <li>• When input signal is HDMI, this item can also be selected if either 1) or 2) applies.                          1) HDMI FORMAT is set to VIDEO.                          2) HDMI FORMAT is set to AUTO, and the projector recognizes that it receives video signals.</li> <li>• When this adjustment is too large, certain degradation may appear at the frame area of the picture. In such a case, please adjust small.</li> </ul>
<p><b>V POSITION</b></p>	<p>Using the ◀/▶ cursor buttons adjusts the vertical position.                      Down ⇔ Up</p> <ul style="list-style-type: none"> <li>• Over-adjusting the vertical position may cause noise to appear on the screen. If this occurs, please reset the vertical position to the default setting. Pressing the <b>RESET</b> button on the remote control when the V POSITION is selected will reset the V POSITION to the default setting.</li> <li>• When this function is performed on a video signal or s-video signal, the range of this adjustment depends on the OVER SCAN (<b>above</b>) setting. It is not possible to adjust when the OVER SCAN is set to 10.</li> <li>• This item cannot be selected for an HDMI signal.</li> </ul>

(continued on next page)



Item	Description
<b>H POSITION</b>	<p>Using the ◀/▶ cursor buttons adjusts the horizontal position. Right ⇔ Left</p> <ul style="list-style-type: none"> <li>• Over-adjusting the horizontal position may cause noise to appear on the screen. If this occurs, please reset the horizontal position to the default setting. Pressing the <b>RESET</b> button on the remote control when the H POSITION is selected will reset the H POSITION to the default setting.</li> <li>• When this function is performed on a video signal or s-video signal, the range of this adjustment depends on the OVER SCAN (📖32) setting. It is not possible to adjust when the OVER SCAN is set to 10.</li> <li>• This item cannot be selected for an HDMI signal.</li> </ul>
<b>H PHASE</b>	<p>Using the ◀/▶ cursor buttons adjusts the horizontal phase to eliminate flicker. Right ⇔ Left</p> <ul style="list-style-type: none"> <li>• This item can be selected only for a computer signal or a component video signal.</li> </ul>
<b>H SIZE</b>	<p>Using the ◀/▶ cursor buttons adjusts the horizontal size. Small ⇔ Large</p> <ul style="list-style-type: none"> <li>• This item can be selected only for a computer signal.</li> <li>• When this adjustment is excessive, the picture may not be displayed correctly. In such a case, please reset the adjustment by pressing the <b>RESET</b> button on the remote control during this operation.</li> <li>• Images might appear degraded when this function is operated, but it is not a malfunction.</li> </ul>
<b>AUTO ADJUST EXECUTE</b>	<p>Selecting this item performs the automatic adjustment feature.</p> <p><b>For a computer signal</b> The vertical position, the horizontal position and the horizontal phase will be automatically adjusted. Make sure that the application window is set to its maximum size prior to attempting to use this feature. A dark picture may still be incorrectly adjusted. Use a bright picture when adjusting.</p> <p><b>For a video signal and s-video signal</b> The video format best suited for the respective input signal will be selected automatically. This function is available only when the AUTO is selected for the VIDEO FORMAT item in the INPUT menu (📖35). The vertical position and horizontal position will be automatically set to the default.</p> <p><b>For a component video signal</b> The vertical position and horizontal position will be automatically set to the default. The horizontal phase will be automatically adjusted.</p> <ul style="list-style-type: none"> <li>• The automatic adjustment operation requires approx. 10 seconds. Also please note that it may not function correctly with some input.</li> <li>• When this function is performed for a video signal, a certain extra such as a line may appear outside a picture.</li> <li>• When this function is performed for a computer signal, a black frame may be displayed on the edge of the screen, depending on the PC model.</li> <li>• The items adjusted by this function may vary when the FINE or the DISABLE is selected for the AUTO ADJUST item of the SERVICE item in the OPTION menu (📖50).</li> </ul>

INPUT menu

From the INPUT menu, items shown in the table below can be performed.

Select an item using the ▲/▼ cursor buttons, and press the ► cursor (or the **ENTER**) button to execute the item. Then perform it according to the following table.

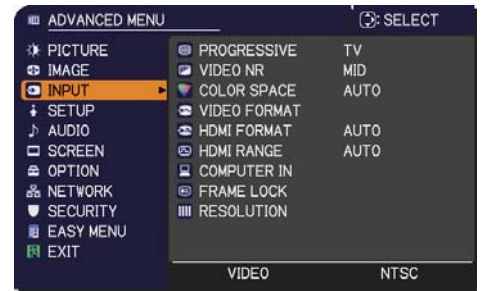

Item	Description
<b>PROGRESSIVE</b>	<p>Using the ▲/▼ cursor buttons switches the progress mode.                      TV ⇄ FILM ⇄ OFF                      ↑—————↑</p> <ul style="list-style-type: none"> <li>• This function works only for a video signal, s-video signal, component video signal or HDMI signal of 480i@60 or 576i@50.</li> <li>• When the TV or the FILM is selected, the screen image will be sharp. The FILM adapts to the 2-3 Pull-Down conversion system. But these may cause a certain defect (for example, jagged line) of the picture for a quick moving object. In such a case, please select the OFF, even though the screen image may lose sharpness.</li> </ul>
<b>VIDEO NR</b>	<p>Using the ▲/▼ cursor buttons switches the noise reduction mode.                      HIGH ⇄ MID ⇄ LOW                      ↑—————↑</p> <ul style="list-style-type: none"> <li>• This function works only for a video signal, s-video signal, component video signal or HDMI signal of 480i@60 or 576i@50.</li> <li>• When this function is excessive, it may cause a certain degradation of the picture.</li> </ul>
<b>COLOR SPACE</b>	<p>Using the ▲/▼ cursor buttons switches the mode for color space.                      AUTO ⇄ RGB ⇄ SMPTE240 ⇄ REC709 ⇄ REC601                      ↑—————↑</p> <ul style="list-style-type: none"> <li>• This item can be selected only for a computer signal or a component video signal.</li> <li>• The AUTO mode automatically selects the optimum mode.</li> <li>• The AUTO operation may not work well at some signals. In such a case, it might be good to select a suitable mode except the AUTO.</li> </ul>

(continued on next page)

Item	Description								
<p><b>VIDEO FORMAT</b></p>	<p>The video format for the <b>S-VIDEO</b> port and the <b>VIDEO</b> port can be set.</p> <p>(1) Use the ▲/▼ cursor buttons to select the input port.  <b>S-VIDEO ⇔ VIDEO</b></p> <p>(2) Using the ◀/▶ cursor buttons switches the mode for video format.  <b>AUTO ⇔ NTSC ⇔ PAL ⇔ SECAM</b>  <b>↶ N-PAL ⇔ M-PAL ⇔ NTSC4.43 ↷</b></p>  <ul style="list-style-type: none"> <li>• This item is performed only for a video signal from the <b>VIDEO</b> port or the <b>S-VIDEO</b> port.</li> <li>• The AUTO mode automatically selects the optimum mode.</li> <li>• The AUTO operation may not work well for some signals. If the picture becomes unstable (e.g. an irregular picture, lack of color), please select the mode according to the input signal.</li> </ul>								
<p><b>HDMI FORMAT</b></p>	<p>Set the video format for the <b>HDMI</b> port.          Using the ▲/▼ cursor buttons switches the digital signal format.  <b>AUTO ⇔ VIDEO ⇔ COMPUTER</b></p> <table border="1" data-bbox="443 1079 1465 1276"> <thead> <tr> <th></th> <th>Feature</th> </tr> </thead> <tbody> <tr> <td>AUTO</td> <td>Selecting the optimum mode automatically.</td> </tr> <tr> <td>VIDEO</td> <td>Suitable for DVD signals.</td> </tr> <tr> <td>COMPUTER</td> <td>Suitable for computer signals.</td> </tr> </tbody> </table> <ul style="list-style-type: none"> <li>• If the <b>COMPUTER</b> is selected, <b>COLOR</b>, <b>TINT</b>, <b>OVERSCAN</b> can not be selected.</li> </ul>		Feature	AUTO	Selecting the optimum mode automatically.	VIDEO	Suitable for DVD signals.	COMPUTER	Suitable for computer signals.
	Feature								
AUTO	Selecting the optimum mode automatically.								
VIDEO	Suitable for DVD signals.								
COMPUTER	Suitable for computer signals.								
<p><b>HDMI RANGE</b></p>	<p>Set the digital range for <b>HDMI</b> port.          Using the ▲/▼ cursor buttons changes the digital signal mode.  <b>AUTO ⇔ NORMAL ⇔ ENHANCED</b></p> <table border="1" data-bbox="443 1563 1465 1760"> <thead> <tr> <th></th> <th>Feature</th> </tr> </thead> <tbody> <tr> <td>AUTO</td> <td>Selecting the optimum mode automatically.</td> </tr> <tr> <td>NORMAL</td> <td>Suitable for DVD signals (16-235)</td> </tr> <tr> <td>ENHANCED</td> <td>Suitable for computer signals (0-255)</td> </tr> </tbody> </table> <ul style="list-style-type: none"> <li>• If the contrast of the screen image is too strong or too weak, try finding a more suitable mode.</li> </ul>		Feature	AUTO	Selecting the optimum mode automatically.	NORMAL	Suitable for DVD signals (16-235)	ENHANCED	Suitable for computer signals (0-255)
	Feature								
AUTO	Selecting the optimum mode automatically.								
NORMAL	Suitable for DVD signals (16-235)								
ENHANCED	Suitable for computer signals (0-255)								

(continued on next page)

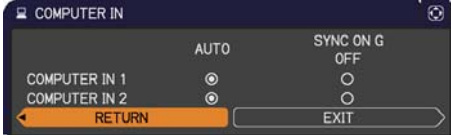
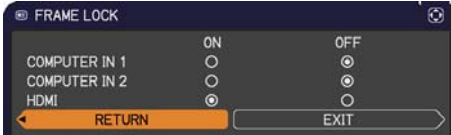
Item	Description
<p><b>COMPUTER IN</b></p>	<p>The computer input signal type for the <b>COMPUTER IN1</b> and <b>IN2</b> ports can be set.</p> <p>(1) Use the ▲/▼ cursor buttons to select the <b>COMPUTER IN</b> port to be set.  <b>COMPUTER IN1 ⇔ COMPUTER IN2</b></p> <p>(2) Use the ◀/▶ cursor buttons to select the computer input signal type.  <b>AUTO ⇔ SYNC ON G OFF</b></p>  <ul style="list-style-type: none"> <li>• Selecting the AUTO mode allows you to input a sync on G signal or component video from the port.</li> <li>• In the AUTO mode, the picture may be distorted with certain input signals. In such a case, remove the signal connector so that no signal is received and select the SYNC ON G OFF, and then reconnect the signal.</li> <li>• The <b>COMPUTER IN1/2</b> port can support a component signal also (10).</li> </ul>
<p><b>FRAME LOCK</b></p>	<p>Set the frame lock function on/off for each port.</p> <p>(1) Use the ▲/▼ cursor buttons to select the input ports.</p> <p>(2) Use the ◀/▶ cursor buttons to turn the frame lock function on/off.  <b>ON ⇔ OFF</b></p>  <ul style="list-style-type: none"> <li>• This item can be performed only on a signal with a vertical frequency of 50 to 60 Hz.</li> <li>• When the ON is selected, moving pictures are displayed more smoothly.</li> <li>• This function may cause a certain degradation of the picture. In such a case, please select the OFF.</li> </ul>

(continued on next page)

Item	Description
<p><b>RESOLUTION</b></p>	<p>The resolution for the <b>COMPUTER IN1</b> and the <b>COMPUTER IN2</b> input signals can be set on this projector.</p> <p>In the RESOLUTION menu select the resolution you wish to display using the ▲/▼ cursor buttons.</p> <p>■ <b>AUTO</b>            Selecting AUTO will set a resolution appropriate to the input signal.</p> <p>■ <b>STANDARD</b>            Pressing the ► cursor (or the <b>ENTER</b>) button when selecting a STANDARD resolution will automatically adjust the horizontal and vertical positions, clock phase and horizontal size. The INPUT_INFORMATION dialog will be displayed.</p> <p>■ <b>CUSTOM</b>            (1) To set a custom resolution use the ▲/▼ cursor buttons to select the CUSTOM and the RESOLUTION_CUSTOM box will be displayed. Set the horizontal (HORZ) and vertical (VERT) resolutions using the ▲/▼/◀/▶ cursor buttons. This function is may not support all resolutions.            (2) Move the cursor to the OK on screen and press the ► cursor (or the <b>ENTER</b>) button. The message "ARE YOU SURE YOU WISH TO CHANGE RESOLUTION?" appears. To save the setting, press the ► cursor button. The horizontal and vertical positions, clock phase and horizontal size will be automatically adjusted.</p> <p>To revert back to the previous resolution without saving changes, move the cursor to the CANCEL on screen and press the ◀ cursor (or the <b>ENTER</b>) button. The screen will then return to the RESOLUTION menu displaying the previous resolution.</p> <ul style="list-style-type: none"> <li>• For some pictures, this function may not work well.</li> </ul>

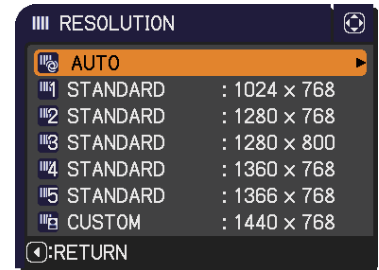

STANDARD

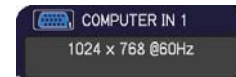

CUSTOM

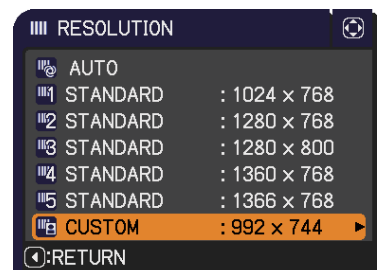
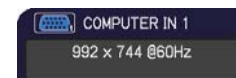
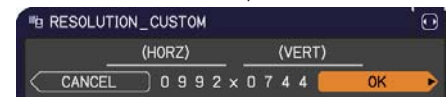

## SETUP menu

From the SETUP menu, items shown in the table below can be performed.

Select an item using the ▲/▼ cursor buttons, and press the ► cursor (or the **ENTER**) button to execute the item. Then perform it according to the following table.

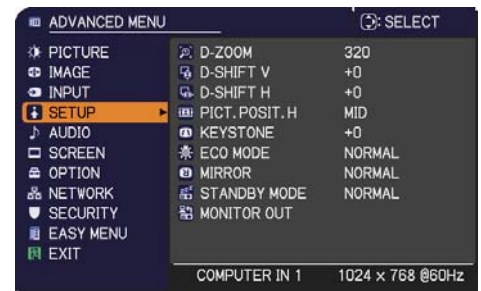

Item	Description
<b>D-ZOOM</b>	Using the ◀/▶ cursor buttons adjusts the magnification ratio. Small ⇔ Large <ul style="list-style-type: none"> <li>The on-screen menu might be displayed outside of the image display area depending on the adjustment value of the ASPECT, D-ZOOM and KEYSTONE. Changing the values of ASPECT, D-ZOOM and KEYSTONE may fix the symptom.</li> </ul>
<b>D-SHIFT V</b>	Using the ◀/▶ cursor buttons adjusts the vertical picture position. Down ⇔ Up <ul style="list-style-type: none"> <li>The D-SHIFT adjustment values are not valid when the D-ZOOM is set to 320 (full screen).</li> </ul>
<b>D-SHIFT H</b>	Using the ◀/▶ cursor buttons adjusts the horizontal picture position. Left ⇔ Right <ul style="list-style-type: none"> <li>The D-SHIFT adjustment values are not valid when the D-ZOOM is set to 320 (full screen).</li> </ul>
<b>PICT. POSIT. H</b>	Using the ▲/▼ cursor buttons selects the horizontal picture position. LEFT ⇔ MID ⇔ RIGHT The PICTURE POSITION is not changed if any of the following cases apply. <ul style="list-style-type: none"> <li>The ASPECT is set to 16:9 or 16:10.</li> <li>The input signal has an aspect ratio of 16:9, 16:10 or vertically smaller than 16:10, while ASPECT is set to NORMAL.</li> <li>Horizontal size of the displayed image is full on the effective display area, while the ASPECT is set to NATIVE.</li> <li>One of the following messages is displayed on the screen: "NO INPUT IS DETECTED" "SYNC IS OUT OF RANGE" "INVALID SCAN FREQ."</li> <li>The BLANK or TEMPLATE function is selected.</li> </ul>
<b>KEYSTONE</b>	Using the ◀/▶ cursor buttons corrects the vertical keystone distortion. Shrink the bottom of the image ⇔ Shrink the top of the image <ul style="list-style-type: none"> <li>The adjustable range of this function will vary among inputs. For some input, this function may not work well.</li> <li>This function will be unavailable when the Transition Detector is on (63).</li> <li>The on-screen menu might be displayed outside of the image display area depending on the adjustment value of the ASPECT, D-ZOOM and KEYSTONE. Changing the values of ASPECT, D-ZOOM and KEYSTONE may fix the symptom.</li> </ul>
<b>ECO MODE</b>	Using the ▲/▼ cursor buttons turns off/on the eco mode. NORMAL ⇔ ECO <ul style="list-style-type: none"> <li>When the ECO is selected, acoustic noise and screen brightness are reduced.</li> </ul>

(continued on next page)

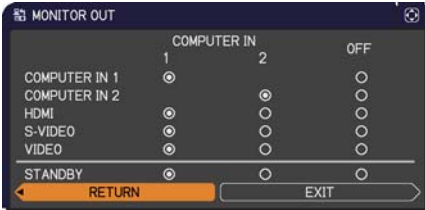
Item	Description
<p><b>MIRROR</b></p>	<p>Using the ▲/▼ cursor buttons switches the mode for mirror status.</p>  <p>NORMAL ⇔ H:INVERT ⇔ V:INVERT ⇔ H&amp;V:INVERT</p> <p>If the Transition Detector is on and the MIRROR status is changed, the TRANSITION DETECTOR ON alarm (📖63) will be displayed when projector is restarted after the AC power is turned off.</p>
<p><b>STANDBY MODE</b></p>	<p>Using ▲/▼ cursor buttons switches the standby mode setting between the NORMAL and the SAVING.</p> <p>NORMAL ⇔ SAVING</p> <ul style="list-style-type: none"> <li>• When the SAVING is selected and the projector is in the standby state, the power consumption is lowered with some functional restriction as below. <ul style="list-style-type: none"> <li>- The RS-232C communication control is disabled except turning the projector on and changing the STANDBY MODE setting.</li> <li>- The STANDBY of the MONITOR OUT (📖below) is invalid, and no signal is output from the <b>MONITOR OUT</b> port.</li> <li>- The AUDIO OUT STANDBY of the AUDIO SOURCE (📖40) is invalid, and no signal is output from the <b>AUDIO OUT</b> ports (📖18).</li> </ul> </li> <li>• If the COMMUNICATION TYPE in the COMMUNICATION menu is set to NETWORK BRIDGE, all of the RS-232C commands are disabled (📖52).</li> </ul>
<p><b>MONITOR OUT</b></p>	<p>The combination of a picture shown on screen and output from the <b>MONITOR OUT</b> port can be arranged in the menu.</p> <p>The picture coming into the port selected in the (2) is output to the <b>MONITOR OUT</b> port while an image from the port chosen in the (1) is on screen.</p> <p>(1) Choose a picture input port using ▲/▼ cursor buttons.</p> <ul style="list-style-type: none"> <li>• Select STANDBY to specify the output from the <b>MONITOR OUT</b> port in the standby state. This selection is available only when NORMAL is selected for the STANDBY MODE (📖above).</li> </ul> <p>(2) Select one of the <b>COMPUTER IN</b> ports using the ◀/▶ cursor buttons.</p> <p>Choosing the COMPUTER IN1 allows the following choice. COMPUTER IN1 ⇔ OFF</p> <p>Choosing the COMPUTER IN2 allows the following choice. COMPUTER IN2 ⇔ OFF</p> <p>Choosing other input or the STANDBY allows the following choice. COMPUTER IN1 ⇔ COMPUTER IN2 ⇔ OFF</p>  <ul style="list-style-type: none"> <li>• The OFF disables the <b>MONITOR OUT</b> port.</li> </ul>

## AUDIO menu

From the AUDIO menu, items shown in the table below can be performed. Select an item using the ▲/▼ cursor buttons, and press the ► cursor (or the **ENTER**) button to execute the item. Then perform it according to the following table.

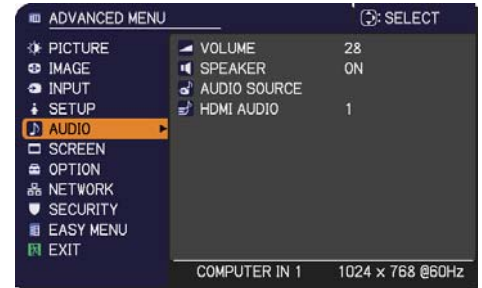

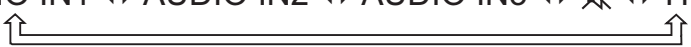
Item	Description
<b>VOLUME</b>	Using the ◀/▶ cursor buttons adjusts the volume. Low ⇔ High
<b>SPEAKER</b>	Using the ▲/▼ cursor buttons turns on/off the built-in speaker. ON ⇔ OFF When the OFF is selected, the built-in speaker does not work.
<b>AUDIO SOURCE</b>	<p>The combination of a picture and audio input port can be arranged in the menu. The audio coming into the port selected in the (2) is output while an image from the port chosen in the (1) is on screen.</p> <p>(1) Choose a picture input port using the ▲/▼ cursor buttons.</p> <ul style="list-style-type: none"> <li>Choose the AUDIO OUT STANDBY, to select the audio output to the <b>AUDIO OUT</b> ports in the standby state. The built-in speaker does not work in the standby state.</li> <li>While the RETURN is selected, pressing the ◀ cursor (or the <b>ENTER</b>) button returns to the previous menu.</li> </ul> <p>(2) Select one of the <b>AUDIO IN</b> ports using the ◀/▶ cursor buttons.</p> <p style="text-align: center;">AUDIO IN1 ⇔ AUDIO IN2 ⇔ AUDIO IN3 ⇔ <del>X</del> ⇔ H</p> <div style="text-align: center;">  </div> <ul style="list-style-type: none"> <li>"H" is abbreviation of HDMI.</li> <li>H can be selected for <b>HDMI</b> port only. When H is selected, the audio signal to <b>HDMI</b> port will be output if HDMI is chosen as a picture source.</li> <li><del>X</del> disables the audio output.</li> <li>The C.C. (Closed Caption) is automatically activated when <del>X</del> is selected and an input signal containing C.C. is received. This function is available only when the signal is NTSC for the <b>VIDEO</b> or the <b>S-VIDEO</b>, or 480i@60 for the <b>COMPUTER IN1</b> or the <b>COMPUTER IN2</b>, and when the AUTO is selected for the DISPLAY in the C.C. menu under the SCREEN menu (<a href="#">46</a>).</li> </ul>
<b>HDMI AUDIO</b>	The HDMI AUDIO is set to 1 as default. In case the HDMI audio does not work well, try 2. 1 ⇔ 2





SCREEN menu

From the SCREEN menu, items shown in the table below can be performed.

Select an item using the ▲/▼ cursor buttons, and press the ► cursor (or the **ENTER**) button to execute the item. Then perform it according to the following table.

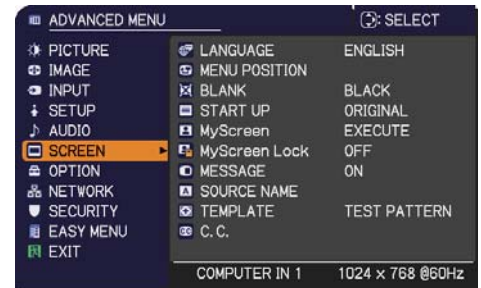

Item	Description
<p><b>LANGUAGE</b></p>	<p>Using the ▲/▼/◀/▶ cursor buttons switches the OSD (On Screen Display) language.                      ENGLISH, FRANÇAIS, DEUTSCH, ESPAÑOL...                      (shown in the LANGUAGE dialog)                      Press the <b>ENTER</b> (or the <b>INPUT</b>) button to save the language setting.</p>
<p><b>MENU POSITION</b></p>	<p>Using the ▲/▼/◀/▶ cursor buttons adjusts the menu position. To quit the operation, press the <b>MENU</b> button on the remote control or keep no operation for about 10 seconds.</p>
<p><b>BLANK</b></p>	<p>Using the ▲/▼ cursor buttons switches the mode for the blank screen. The blank screen is a screen for the temporarily blanking feature (📖24). It is displayed by pressing the <b>BLANK</b> button on the remote control.</p> <p style="text-align: center;">MyScreen ⇔ ORIGINAL ⇔ BLUE ⇔ WHITE ⇔ BLACK  <span style="display: inline-block; width: 100%; border-top: 1px solid black; position: relative; top: -10px;"> <span style="position: absolute; left: 50%; transform: translate(-50%, -50%);">↑</span> </span></p> <p><u>MyScreen</u> : Screen can be registered by the MyScreen item (📖42).  <u>ORIGINAL</u> : Screen preset as the standard screen.  <u>BLUE, WHITE, BLACK</u> : Plain screens in each color.</p> <ul style="list-style-type: none"> <li>• To avoid remaining as an afterimage, the MyScreen or the ORIGINAL screen will change to the plain black screen after several minutes.</li> </ul>
<p><b>START UP</b></p>	<p>Using the ▲/▼ cursor buttons switches the mode for the start-up screen. The start-up screen is a screen displayed when no signal or an unsuitable signal is detected.</p> <p style="text-align: center;">MyScreen ⇔ ORIGINAL ⇔ OFF  <span style="display: inline-block; width: 100%; border-top: 1px solid black; position: relative; top: -10px;"> <span style="position: absolute; left: 50%; transform: translate(-50%, -50%);">↑</span> </span></p> <p><u>MyScreen</u> : The screen can be registered by the MyScreen item (📖42).  <u>ORIGINAL</u> : The screen preset as the standard screen.  <u>OFF</u> : Plain black screen.</p> <ul style="list-style-type: none"> <li>• To avoid remaining as an afterimage, the MyScreen or the ORIGINAL screen will change to the BLANK screen (📖24) after several minutes. If also the BLANK screen is the MyScreen or the ORIGINAL, the plain black screen is instead used.</li> <li>• When the ON is selected to the MyScreen PASSWORD item in the SECURITY menu (📖61), the START UP is fixed to the MyScreen.</li> </ul>





(continued on next page)

Item	Description
<p><b>MyScreen</b></p>	<p>This item allows you to capture an image for use as a MyScreen image which can be used as the BLANK screen and the START UP screen. Display the image you want to capture before executing the following procedure.</p> <ol style="list-style-type: none"> <li>1. Selecting this item displays a dialog titled “MyScreen”. It will ask you if you start capturing an image from the current screen.           <div data-bbox="1043 423 1474 510" data-label="Image"> </div> <p>Please wait for the target image to be displayed, and press the <b>ENTER</b> (or the <b>INPUT</b>) button when the image is displayed. The image will freeze and the frame for capturing will appear. To stop performing, press the <b>RESET</b> (or press the ◀ cursor and the <b>INPUT</b> buttons at the same time) button.</p> </li> <li>2. Using the ▲/▼/◀/▶ cursor buttons adjusts the frame position.           <div data-bbox="1139 786 1452 981" data-label="Image"> </div> <p>Please move the frame to the position of the image which you want to use. The frame may not be able to be moved for some input signals. To start registration, press the <b>ENTER</b> (or the <b>INPUT</b>) button on the remote control.</p> <div data-bbox="1099 987 1474 1066" data-label="Image"> </div> <p>To restore the screen and return to the previous dialog, press the <b>RESET</b> (or press the ◀ cursor and the <b>INPUT</b> buttons at the same time) button. Registration takes several minutes. When the registration is completed, the registered screen and the following message is displayed for several seconds:  <b>“MyScreen registration is finished.”</b>            If the registration failed, the following message is displayed:  <b>“A capturing error has occurred. Please try again.”</b> </p> <ul style="list-style-type: none"> <li>• This function cannot be selected when the ON is selected to the MyScreen Lock item (📖43).</li> <li>• This function cannot be selected when the ON is selected to the MyScreen PASSWORD item in the SECURITY menu (📖61).</li> <li>• This item cannot be selected for an HDMI signal.</li> </ul> </li> </ol>

(continued on next page)

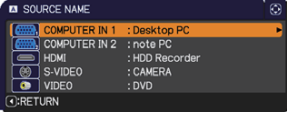
Item	Description
<b>MyScreen Lock</b>	<p>Using the ▲/▼ cursor buttons turns on/off the MyScreen lock function.</p> <p>ON ⇔ OFF</p> <p>When the ON is selected, the item MyScreen is locked. Use this function for protecting the current MyScreen.</p> <ul style="list-style-type: none"> <li>• This function cannot be selected when the ON is selected to the MyScreen PASSWORD item in the SECURITY menu (📖61).</li> </ul>
<b>MESSAGE</b>	<p>Using the ▲/▼ cursor buttons turns on/off the message function.</p> <p>ON ⇔ OFF</p> <p>When the ON is selected, the following message function works.</p> <p>“AUTO IN PROGRESS” while automatically adjusting</p> <p>“NO INPUT IS DETECTED”</p> <p>“SYNC IS OUT OF RANGE”</p> <p>“INVALID SCAN FREQ.”</p> <p>“NOT AVAILABLE”</p> <p>“Searching...” while searching for the input</p> <p>“Detecting...” while an input signal is detected</p> <p>The indication of the input signal displayed by changing</p> <p>The indication of the aspect ratio displayed by changing</p> <p>The indication of the PICTURE MODE displayed by changing</p> <p>The indication of the MY MEMORY displayed by changing</p> <p>The indication of “FREEZE” and “II” while freezing the screen by pressing the <b>FREEZE</b> button.</p> <p>The indication of the TEMPLATE displayed by changing.</p> <ul style="list-style-type: none"> <li>• When the OFF is selected, please remember if the picture is frozen. Do not mistake freezing for a malfunction (📖24).</li> </ul>

(continued on next page)

Item	Description
<p><b>SOURCE NAME</b></p>	<p>Each input port for this projector can have a name applied to it.</p> <p>(1) Use the ▲/▼ cursor buttons on the SCREEN menu to select the SOURCE NAME and press the ► cursor (or the <b>ENTER</b>) button. The SOURCE NAME menu will be displayed.</p> <p>(2) Use the ▲/▼ cursor buttons on the SOURCE NAME menu to select the port to be named and press the ► cursor button. Right side of the menu is blank until a name is specified. The SOURCE NAME dialog will be displayed.</p> <p>(3) The current name will be displayed on the first line. Use the ▲/▼/◀/▶ cursor buttons and the <b>ENTER</b> (or the <b>INPUT</b>) button to select and enter characters. To erase 1 character at one time, press the <b>RESET</b> (or press the ◀ cursor and the <b>INPUT</b> buttons at the same time) button. Also if you move the cursor to the DELETE or the ALL CLEAR on screen and press the <b>ENTER</b> (or the <b>INPUT</b>) button, 1 character or all characters will be erased. The name can be a maximum of 16 characters.</p> <p>(4) To change an already inserted character, press the ▲ cursor button to move the cursor to the first line, and use the ◀/▶ cursor buttons to move the cursor on the character to be changed. After pressing the <b>ENTER</b> (or the <b>INPUT</b>) button, the character is selected. Then, follow the same procedure as described at the item (3) above.</p> <p>(5) To finish entering text, move the cursor to the OK on screen and press the ► cursor (or the <b>ENTER</b> / the <b>INPUT</b>) button. To revert to the previous name without saving changes, move the cursor to the CANCEL on screen and press the ◀ cursor (or the <b>ENTER</b> / the <b>INPUT</b>) button.</p> <div style="display: flex; flex-direction: column; align-items: flex-end;">     </div>

(continued on next page)

Item	Description
<b>TEMPLATE</b>	<p>Using the ▲/▼ cursor buttons switches the mode for the template screen.</p> <p>Press the ► cursor (or the <b>ENTER</b>) button to display the selected template, and press the ◀ cursor button to close the displayed screen.</p> <p>The last selected template is displayed when the <b>MY BUTTON</b> allocated to the <b>TEMPLATE</b> function is pressed (📖49).</p> <p>TEST PATTERN ⇄ DOT-LINE1 ⇄ DOT-LINE2 ⇄ DOT-LINE3  ⇅ ⇅</p> <p>MAP2 ⇄ MAP1 ⇄ CIRCLE2 ⇄ CIRCLE1 ⇄ DOT-LINE4</p> <p>You can turn a map upside down and scroll it horizontally when MAP1 or MAP2 is selected. To invert or scroll the map, display the guidance by pressing the <b>RESET</b> button on the remote three seconds or more when MAP1 or MAP2 appears.</p> <p>While the guidance is displayed:</p> <ul style="list-style-type: none"> <li>• Press the ▲ cursor button and then press the <b>ENTER</b> or <b>INPUT</b> button to place the Northern Hemisphere on the top.</li> <li>• Press the ▼ cursor button and then press the <b>ENTER</b> or <b>INPUT</b> button to place the Southern Hemisphere on the top.</li> <li>• Press the ◀/▶ cursor button and then press the <b>ENTER</b> or <b>INPUT</b> button to scroll the map horizontally.</li> </ul>

(continued on next page)

Item	Description
<p align="center"><b>C.C. (Closed Caption)</b></p>	<p>The C.C. is the function that displays a transcript or dialog of the audio portion of a video, files or other presentation or other relevant sounds. It is required to have NTSC format video or 480i@60 format component video source supporting C.C. feature to utilize this function.</p> <p>It may not work properly, depending on equipment or signal source. In this case, please turn off the Closed Caption.</p>
	<p><b>DISPLAY</b></p> <p>Select the Closed Caption DISPLAY setting from following options using the ▲/▼ cursor buttons.</p> <p>AUTO ⇔ ON ⇔ OFF</p> <p align="center">↑—————↑</p> <p><u>AUTO</u> : Closed Caption automatically displays when the volume is muted.</p> <p><u>ON</u> : The Closed Caption is on.</p> <p><u>OFF</u> : The Closed Caption is off.</p> <ul style="list-style-type: none"> <li>• The caption is not displayed when the OSD menu is active.</li> <li>• The Closed Caption is the function to display the dialogue, narration, and / or sound effects of a television program or other video sources. The Closed Caption availability is depending upon broadcaster and/or content.</li> </ul>
	<p><b>MODE</b></p> <p>Select the Closed Caption MODE setting from following options using the ▲/▼ cursor buttons.</p> <p>CAPTIONS ⇔ TEXT</p> <p><u>CAPTIONS</u> : Display Closed Caption.</p> <p><u>TEXT</u> : Display Text data, which is for additional information such as news reports or a TV program guide. The information covers the entire screen. Not all of the C.C. program has Text information.</p>
	<p><b>CHANNEL</b></p> <p>Select the Closed Caption CHANNEL from following options using the ▲/▼ cursor buttons.</p> <p>1 ⇔ 2 ⇔ 3 ⇔ 4</p> <p align="center">↑—————↑</p> <p><u>1</u>: Channel 1, primary channel / language</p> <p><u>2</u>: Channel 2</p> <p><u>3</u>: Channel 3</p> <p><u>4</u>: Channel 4</p> <p>The channel data may vary, depending on the content. Some channel might be used for secondary language or empty.</p>

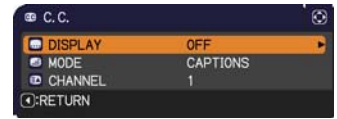

OPTION menu

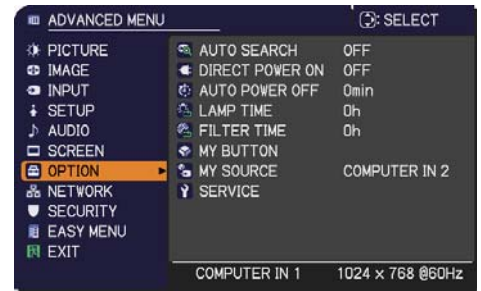

From the OPTION menu, items shown in the table below can be performed.

Select an item using the ▲/▼ cursor buttons, and press the ► cursor (or the **ENTER**) button to execute the item, except for the items LAMP TIME and FILTER TIME. Then perform it according to the following table.



Item	Description
<p><b>AUTO SEARCH</b></p>	<p>Using the ▲/▼ cursor buttons turns on/off the automatic signal search function.</p> <p>ON ⇔ OFF</p> <p>When the ON is selected, detecting no signal automatically cycles through input ports in the following order. The search is started from the current port. Then when an input is found, the projector will stop searching and display the image.</p> <p> </p>
<p><b>DIRECT POWER ON</b></p>	<p>Using the ▲/▼ cursor buttons turns on/off the DIRECT POWER ON function.</p> <p>ON ⇔ OFF</p> <p>When set to the ON, the lamp in projector will be automatically turned on without the usual procedure (17), only when the projector is supplied with the power after the power was cut while the lamp was on.</p> <ul style="list-style-type: none"> <li>• This function does not work as long as the power has been supplied to the projector while the lamp is off.</li> <li>• After turning the lamp on by the DIRECT POWER ON function, if neither input nor operation is detected for about 30 minutes, the projector is turned off, even though the AUTO POWER OFF function (48) is disabled.</li> </ul>

(continued on next page)

Item	Description
<p><b>AUTO POWER OFF</b></p>	<p>Using the ▲/▼ cursor buttons adjusts the time to count down to automatically turn the projector off.</p> <p>Long (max. 99 minutes) ⇔ Short (min. 0 minute = DISABLE)</p> <div style="display: flex; justify-content: space-around; align-items: center;">   </div> <p>When the time is set to 0, the projector is not turned off automatically. When the time is set to 1 to 99, and when the passed time with no-signal or an unsuitable signal reaches at the set time, the projector lamp will be turned off.</p> <p>If one of the projector's buttons or the remote control buttons is pressed or one of the commands (except get commands) is transmitted to the <b>CONTROL</b> port during the corresponding time, projector will not be turned off.</p> <p>Please refer to the section the "Turning off the power" (📖17).</p>
<p><b>LAMP TIME</b></p>	<p>The lamp time is the usage time of the lamp, counted after the last resetting. It is shown in the OPTION menu.</p> <p>Pressing the ► cursor (or the <b>ENTER</b> / the <b>RESET</b>) button displays a dialog.</p> <p>To reset the lamp time, select the OK using the ► cursor button.</p> <p>CANCEL ⇔ OK</p> <ul style="list-style-type: none"> <li>• Please reset the lamp time only when you have replaced the lamp, for a suitable indication about the lamp.</li> <li>• For the lamp replacement, see the section the "Replacing the lamp" (📖66,67).</li> </ul>
<p><b>FILTER TIME</b></p>	<p>The filter time is the usage time of the air filter, counted after the last resetting. It is shown in the OPTION menu.</p> <p>Pressing the ► cursor (or the <b>ENTER</b> / the <b>RESET</b>) button displays a dialog.</p> <p>To reset the filter time, select the OK using the ► cursor button.</p> <p>CANCEL ⇔ OK</p> <ul style="list-style-type: none"> <li>• Please reset the filter time only when you have cleaned or replaced the air filter, for a suitable indication about the air filter.</li> <li>• For the air filter cleaning, see the section the "Cleaning and replacing the air filter" (📖68).</li> </ul>

(continued on next page)



Item	Description
<p><b>MY BUTTON</b></p>	<p>This item is to assign one of the following functions to the <b>MY BUTTON 1/2</b> on the remote control (📖7).</p> <p>(1) Use the ▲/▼ cursor buttons on the MY BUTTON menu to select a MY BUTTON - (1/2) and press the ► cursor (or the <b>ENTER</b>) button to display the MY BUTTON setup dialog.</p> <p>(2) Then using the ▲/▼/◀/▶ cursor buttons sets one of the following functions to the chosen button. Press the <b>ENTER</b> (or the <b>INPUT</b>) button to save the setting.</p> <ul style="list-style-type: none"> <li>• <b>COMPUTER IN1</b>: Sets port to the <b>COMPUTER IN1</b>.</li> <li>• <b>COMPUTER IN2</b>: Sets port to the <b>COMPUTER IN2</b>.</li> <li>• <b>HDMI</b>: Sets port to <b>HDMI</b>.</li> <li>• <b>S-VIDEO</b>: Sets port to the <b>S-VIDEO</b>.</li> <li>• <b>VIDEO</b>: Sets port to the <b>VIDEO</b>.</li> <li>• <b>MY IMAGE</b>: Displays the MY IMAGE menu (📖58).</li> <li>• <b>MESSENGER</b>: Turns the messenger text displayed on the screen on/off (📖Messenger Function of the User's Manual - Network Guide). When there is no transferred text data to display, the message "NO MESSENGER DATA" appears.</li> <li>• <b>INFORMATION</b>: Displays the SYSTEM_INFORMATION, INPUT_INFORMATION (📖54), NETWORK_INFORMATION(📖59) or nothing.</li> <li>• <b>MY MEMORY</b>: Loads one of adjustment data stored (📖31). When more than one data are saved, the adjustment changes every time the <b>MY BUTTON</b> is pressed. When no data is saved in memory, the dialog "No saved data" appears. When the current adjustment is not saved to memory, the dialog as shown in the right appears.</li> </ul> <div data-bbox="1161 1115 1394 1142" style="border: 1px solid black; padding: 2px;">         → No saved data     </div> <div data-bbox="1114 1169 1474 1245" style="border: 1px solid black; padding: 2px;">         Temporary condition          MY BUTTON (MY MEMORY) Recall saved parameters          ▶ Exit     </div> <p>If you want to keep the current adjustment, please press the ► cursor button to exit. Otherwise loading a data will overwrite the current adjusted condition.</p> <ul style="list-style-type: none"> <li>• <b>PICTURE MODE</b>: Changes the PICTURE MODE (📖27).</li> <li>• <b>FILTER RESET</b>: Displays the filter time reset confirmation dialogue (📖48).</li> <li>• <b>TEMPLATE</b>: Makes the template pattern selected to the TEMPLATE item (📖45) appear or disappear.</li> <li>• <b>AV MUTE</b>: Turns the picture and audio on/off.</li> <li>• <b>D-ZOOM</b>: Turns the D-ZOOM mode on/off. When the D-ZOOM mode is on, use the ▲/▼ cursor buttons to adjust the magnification ratio.</li> <li>• <b>D-SHIFT</b>: Turns the D-SHIFT mode on/off. When the D-SHIFT mode is on, use the ▲/▼/◀/▶ cursor buttons to move the magnifying area.</li> <li>• <b>RESOLUTION</b>: Turns the RESOLUTION menu on/off (📖37).</li> </ul>
<p><b>MY SOURCE</b></p>	<p>Using the ▲/▼ cursor buttons selects the picture input port to be selected with pressing the <b>MY SOURCE/DOC.CAMERA</b> button on the remote control.</p> <p>Select the picture input that is connected with a document camera.</p> <div style="text-align: center;">  </div>

(continued on next page)

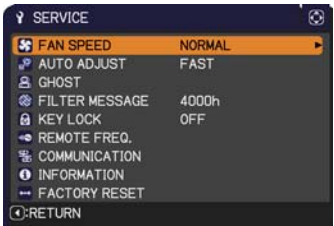
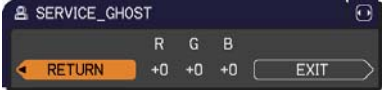
Item	Description
<b>SERVICE</b>	<p>Selecting this item displays the SERVICE menu.</p> <p>Select an item using the ▲/▼ cursor buttons, and press the ► cursor (or the <b>ENTER</b>) button on the remote control to execute the item.</p> 
	<p><b>FAN SPEED</b></p> <p>Using the ▲/▼ cursor buttons switches the rotation speed of the cooling fans. The HIGH is the mode for use at highlands etc. Note that the projector is noisier when the HIGH is selected.</p> <p>HIGH ⇔ NORMAL</p>
	<p><b>AUTO ADJUST</b></p> <p>Using the ▲/▼ cursor buttons to select one of the mode. When the DISABLE is selected, the automatic adjustment feature is disabled.</p> <p>FINE ⇔ FAST ⇔ DISABLE</p> <p style="text-align: center;">↑—————↑</p> <p><u>FINE</u>: Finer tuning including the H.SIZE adjustment.  <u>FAST</u>: Faster tuning, setting the H.SIZE to prearranged data for the input signal.</p> <ul style="list-style-type: none"> <li>Depending on conditions, such as input image, signal cable to the projector, environment around the projector, etc., the automatic adjustment may not work correctly. In such a case, please choose the DISABLE to disable the automatic adjustment, and make adjustment manually.</li> </ul>
	<p><b>GHOST</b></p> <ol style="list-style-type: none"> <li>Select a color element of ghost using the ◀/▶ cursor buttons.</li> <li>Adjust the selected element using the ▲/▼ cursor buttons to disappear ghost.</li> </ol> 
	<p><b>FILTER MESSAGE</b></p> <p>Use the ▲/▼ cursor button to set the timer for notifying by the message when to replace the filter unit</p> <p>500h ⇔ 1000h ⇔ 2000h ⇔ 3000h ⇔ 4000h ⇔ 5000h ⇔ OFF</p> <p>After choosing an item except the OFF, the message the “REMINDER ***HRS PASSED ....” will appear after the timer reaches the interval time set by this feature (72).</p> <p>When the OFF is chosen, the message will not appear. Utilize this feature to keep the air filter clean, setting the suitable time according to your environment of this projector.</p> <ul style="list-style-type: none"> <li>Please take care of the filter unit periodically, even if there is no message. If the air filter becomes to be blocked by dust or other matter, the internal temperature will rise, which could cause malfunction, or reduce the lifetime of the projector.</li> <li>Please be careful with the operating environment of the projector and the condition of the filter unit.</li> </ul>

(continued on next page)

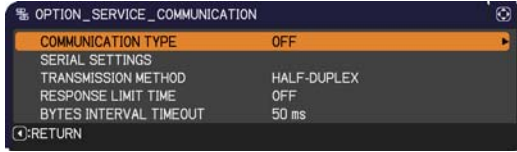
Item	Description
<p><b>SERVICE</b> (continued)</p>	<p><b>KEY LOCK</b> Using the ▲/▼ buttons turns on/off the key lock feature. When ON is selected, the buttons on the projector except the <b>STANDBY/ON</b> button are locked. ON ⇔ OFF</p> <ul style="list-style-type: none"> <li>• Please use this function to prevent tampering or accidental operation. This function does not have any effect on the remote control.</li> </ul> <p><b>REMOTE FREQ.</b> (1) Use the ▲/▼ button to change the projector's remote sensor frequency setting (📖5). 1:NORMAL ⇔ 2:HIGH</p> <p>(2) Use the ◀/▶ button to change the projector's remote sensor on or off. ON ⇔ OFF</p> <p>The factory default setting is for both 1:NORMAL and 2:HIGH to be on. If the remote control does not function correctly, disable either of them (📖16). It's not possible to disable both options at the same time.</p>
	<p><b>COMMUNICATION</b></p> <p>Selecting this item displays COMMUNICATION menu. In this menu, you can configure the serial communication settings of the projector using the <b>CONTROL</b> port.</p>   <ul style="list-style-type: none"> <li>• Select an item using the cursor buttons ▲/▼. Then pressing the ▶ button opens the submenu for the setting item you selected. Or, pressing the ◀ button instead of the ▶ button makes the menu back to the previous one without changing the setup. Each submenu can be operated as described above.</li> <li>• When COMMUNICATION TYPE (📖52) is set to OFF, the other items in COMMUNICATION menu are invalid.</li> <li>• For the function of serial communication, refer to <b>the User's Manual - Network Guide</b>.</li> </ul>



(continued on next page)

Item	Description
<p><b>SERVICE</b> (continued)</p>	<p><b>COMMUNICATION</b> (continued)</p> <p><b>COMMUNICATION TYPE</b> Select the communication type for transmission via the <b>CONTROL</b> port. NETWORK BRIDGE ⇔ OFF <u>NETWORK BRIDGE</u>: Select this type, if it is required to control an external device as a network terminal, via this projector from the computer. The <b>CONTROL</b> port doesn't accept RS-232C commands. (📖 <b>Controlling the external device via the projector (using the NETWORK BRIDGE function) of the User's Manual - Network Guide</b>) <u>OFF</u>: Select this mode to receive RS-232C commands using the <b>CONTROL</b> port. • OFF is selected as the default setting. • When you select the NETWORK BRIDGE, check the item, TRANSMISSION METHOD (📖 <i>below</i>).</p> <p><b>SERIAL SETTINGS</b> Select the serial communication condition for the <b>CONTROL</b> port. <b>BAUD RATE</b> 4800bps ⇔ 9600bps ⇔ 19200bps ⇔ 38400bps ↑—————↑ <b>PARITY</b> NONE ⇔ ODD ⇔ EVEN ↑—————↑ • The BAUD RATE is fixed to 19200bps and PARITY is fixed NONE when the COMMUNICATION TYPE is set to OFF (📖 <i>above</i>).</p> <p><b>TRANSMISSION METHOD</b> Select the transmission method for communication by the NETWORK BRIDGE from the <b>CONTROL</b> port. HALF-DUPLEX ⇔ FULL-DUPLEX <u>HALF-DUPLEX</u>: This method lets the projector make two way communication, but only one direction, either transmitting or receiving data, is allowed at a time. <u>FULL-DUPLEX</u>: This method lets the projector make two way communication, transmitting and receiving data at the same time. • HALF-DUPLEX is selected as the default setting. • When you select HALF-DUPLEX, check the items, RESPONSE LIMIT TIME and BYTES INTERVAL TIMEOUT (📖 <b>53</b>).</p>

(continued on next page)

Item	Description	
<b>SERVICE (continued)</b>	<b>COMMUNICATION (continued)</b>	<p><b>RESPONSE LIMIT TIME</b>                      Select the time period to wait for receiving response data from other device communicating by the NETWORK BRIDGE and the HALF-DUPLEX through the <b>CONTROL</b> port.</p> <p style="text-align: center;">OFF ⇔ 1s ⇔ 2s ⇔ 3s                      ↑—————↑</p> <p><u>OFF</u>: Select this mode if it is not required to check the responses from the device that the projector sends data to. In this mode, the projector can send out data from the computer continuously.</p> <p><u>1s /2s /3s</u>: Select the time period to keep the projector waiting for response from the device that the projector sends data to. While waiting the response, the projector does not send out any data from the <b>CONTROL</b> port.</p> <ul style="list-style-type: none"> <li>• This menu is available only when the NETWORK BRIDGE is selected for the COMMUNICATION TYPE and the HALF-DUPLEX is selected for the TRANSMISSION METHOD (📖52).</li> <li>• OFF is selected as the default setting.</li> </ul> <hr/> <p><b>BYTES INTERVAL TIMEOUT</b>                      Select the blank time length to judge that the response data has finished in the communicating in the condition of the NETWORK BRIDGE and the HALF-DUPLEX through the <b>CONTROL</b> port.</p> <p style="text-align: center;">50ms ⇔ 100ms ⇔ 150ms ⇔ 200ms                      ↑—————↑</p> <ul style="list-style-type: none"> <li>• This menu is available only when NETWORK BRIDGE is selected for the COMMUNICATION TYPE and HALF-DUPLEX is selected for the TRANSMISSION METHOD (📖52).</li> <li>• 50ms is selected as the default setting.</li> </ul>

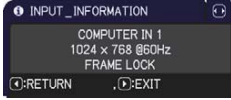
(continued on next page)

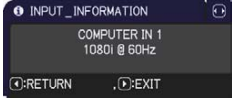
Item	Description
<p><b>SERVICE (continued)</b></p>	<p><b>INFORMATION</b></p> <p>Selecting this item displays a dialog titled “INPUT_INFORMATION”. It shows the information about the current input.</p> <div style="display: flex; justify-content: space-around; align-items: center;">    </div> <ul style="list-style-type: none"> <li>• The “FRAME LOCK” message on the dialog means the frame lock function is working.</li> <li>• This item can't be selected for no signal and sync out.</li> <li>• When the MY TEXT DISPLAY is set to ON, the MY TEXT is displayed together with the input information in the INPUT_INFORMATION box (📖 65).</li> </ul>
	<p><b>FACTORY RESET</b></p> <p>Selecting OK using the ► cursor button performs this function. By this function, all the items in all of menus will collectively return to the initial setting. Note that the LAMP TIME, FILTER TIME, LANGUAGE, FILTER MESSAGE, NETWORK, STANDBY MODE, SECURITY settings, and others are not reset.</p> <p>CANCEL ⇨ OK</p>

**NETWORK menu**

Remember that incorrect network settings on this projector may cause trouble on the network. Be sure to consult with your network administrator before connecting to an existing access point on your network.

Select “NETWORK” from the main menu to access the following functions.

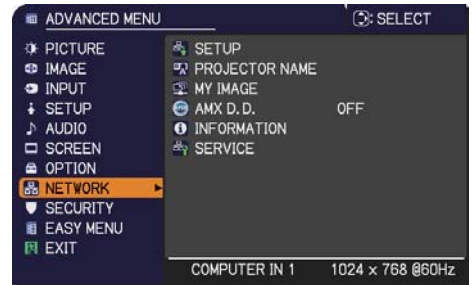

Select an item using the ▲/▼ cursor buttons on the projector or remote control, and press the ► cursor button on the projector or remote control, or **ENTER** button on the remote control to execute the item. Then perform it according to the following table.

See the **User’s Manual - Network Guide** for details of NETWORK operation.

**NOTE** • If you are not utilizing SNTP (📖 **Date/Time Settings of the User’s Manual - Network Guide**), then you must set the DATE AND TIME during the initial installation.

- The network communication control is disabled while the projector is in standby mode if the STANDBY MODE item of SETUP menu is set to SAVING. Please connect the network communication to the projector after setting the STANDBY MODE to NORMAL (📖 39).

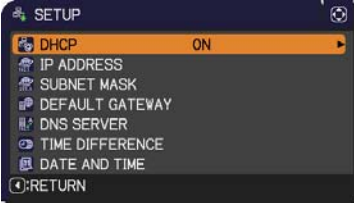

Item	Description	
<p><b>SETUP</b></p>	<p>Selecting this item displays the SETUP Menu for the network. Use the ▲/▼ buttons to select an item, and the ► or <b>ENTER</b> button on the remote control to perform the item.</p> 	
	<p><b>DHCP (Dynamic Host Configuration Protocol)</b></p>	<p>Use the ▲/▼ buttons to turn DHCP on/off. ON ⇔ OFF</p> <p>Select OFF when the network does not have DHCP enabled.</p> <ul style="list-style-type: none"> <li>• When the “DHCP” setting changes to “ON”, it takes a little time to obtain IP address from DHCP server.</li> <li>• Auto IP function will be assigned an IP address if the projector could not obtain an IP address from server even if DHCP is “ON”.</li> </ul>

(continued on next page)



Item	Description	
<b>SETUP</b> (continued)	<b>IP ADDRESS</b>	Use the ▲/▼/◀/▶ buttons to enter the IP ADDRESS. This function can only be used when DHCP is set to OFF. <ul style="list-style-type: none"> <li>• The IP ADDRESS is the number that identifies this projector on the network. You cannot have two devices with the same IP ADDRESS on the same network.</li> <li>• The IP ADDRESS “0.0.0.0” is prohibited.</li> </ul>
	<b>SUBNET MASK</b>	Use the ▲/▼/◀/▶ buttons to enter the same SUBNET MASK used by your computer. This function can only be used when DHCP is set to OFF. <ul style="list-style-type: none"> <li>• The SUBNET MASK “0.0.0.0” is prohibited.</li> </ul>
	<b>DEFAULT GATEWAY</b>	Use the ▲/▼/◀/▶ buttons to enter the DEFAULT GATEWAY (a node on a computer network that serves as an access point to another network) address. This function can only be used when DHCP is set to OFF.
	<b>DNS SERVER</b>	Use the ▲/▼/◀/▶ buttons to input the DNS server address. The DNS server is a system to control domain names and IP addresses on the Network.
	<b>TIME DIFFERENCE</b>	Use the ▲/▼ buttons to enter the TIME DIFFERENCE. Set the same TIME DIFFERENCE as the one set on your computer. If unsure, consult your IT manager. Use the ▶ button to return to the menu after setting the TIME DIFFERENCE.
	<b>DATE AND TIME</b>	Use the ▲/▼/◀/▶ buttons to enter the Year (last two digits), Month, Date, Hour and Minute. <ul style="list-style-type: none"> <li>• The projector will override this setting and retrieve DATE AND TIME information from the Time server when SNTP is enabled. (📖 <b>Date/Time Settings of the User’s Manual - Network Guide</b>)</li> </ul>

(continued on next page)

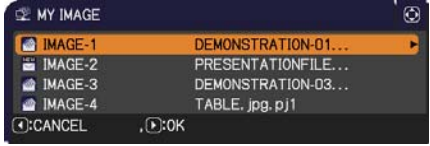

Item	Description
<p><b>PROJECTOR NAME</b></p>	<p>(1) Use the ▲/▼ buttons on the NETWORK menu to select the PROJECTOR NAME and press the ► button. The PROJECTOR NAME dialog will be displayed.</p>  <p>(2) The current PROJECTOR NAME will be displayed on the first 3 lines. If not yet written, the lines will be blank. Use the ▲/▼/◀/► buttons and the <b>ENTER</b> or <b>INPUT</b> button to select and enter characters. To erase 1 character at one time, press the <b>RESET</b> button or press the ◀ and <b>INPUT</b> button at the same time. Also if you move the cursor to <b>DELETE</b> or <b>ALL CLEAR</b> on screen and push the <b>ENTER</b> or <b>INPUT</b> button, 1 character or all characters will be erased. The PROJECTOR NAME can be input up to 64 characters.</p> <p>(3) To change an already inserted character, press the ▲/▼ button to move the cursor to one of the first 3 lines, and use the ◀/► buttons to move the cursor on the character to be changed. After pressing the <b>ENTER</b> or <b>INPUT</b> button, the character is selected. Then, follow the same procedure as described at the item (2) above.</p>   <p>(4) To finish entering text, move the cursor to the <b>OK</b> on screen and press the ►, <b>ENTER</b> or <b>INPUT</b> button. To revert to the previous PROJECTOR NAME without saving changes, move the cursor to the <b>CANCEL</b> on screen and press the ◀, <b>ENTER</b> or <b>INPUT</b> button.</p>

(continued on next page)

Item	Description
<p><b>MY IMAGE</b></p>	<p>Selecting this item displays the MY IMAGE menu.</p> <p>The application software “PJImage” is required to store image(s) into the projector.</p> <p>Use the ▲/▼ buttons to select an item which is a still image by the MY IMAGE (📖 <b>MY IMAGE (Still Image Transfer) Display of the User’s Manual - Network Guide</b>) and the ► or ENTER button to display the image.</p> <ul style="list-style-type: none"> <li>• The item without image stored cannot be selected.</li> <li>• The image names are each displayed in 16 characters or less.</li> </ul> <p><b>To switch the image displayed</b> Use the ▲/▼ buttons.</p> <p><b>To return to the menu</b> Press the ◀ button on the remote control.</p> <p><b>To erase the image displayed and its source file in the projector.</b></p> <p>(1) Press the <b>RESET</b> button on the remote control while displaying an image to display the MY IMAGE DELETE menu.</p> <p>(2) Press the ► button to perform to erase. To stop erasing, press the ◀ button.</p>  
<p><b>AMX D.D. (AMX Device Discovery)</b></p>	<p>Use the ▲/▼ buttons to turn the AMX Device Discovery on/off. ON ⇔ OFF</p> <p>When ON is selected, the projector can be detected by controllers of AMX connected to the same network. For the details of AMX Device Discovery, visit the AMX web site. <u>URL: <a href="http://www.amx.com/">http://www.amx.com/</a></u></p>

(continued on next page)

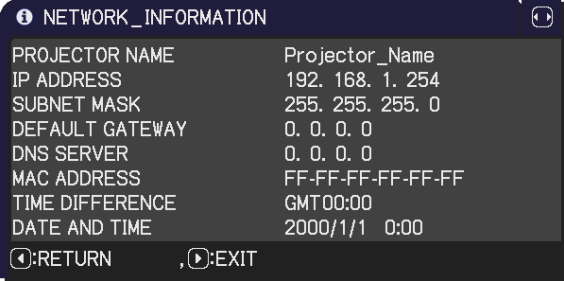
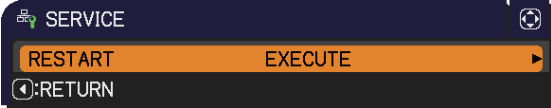
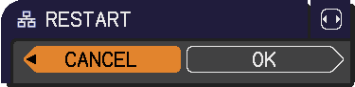
Item	Description
<p><b>INFORMATION</b></p>	<p>Selecting this item displays the NETWORK_INFORMATION dialog for confirming the network settings.</p>  <ul style="list-style-type: none"> <li>• Only the first 16 characters of the projector name are displayed.</li> <li>• Nothing (blank) is shown in the “PROJECTOR NAME” field until you setup the item (📖57).</li> <li>• When the voltage level of the battery for the built in clock decreases, the set time may become incorrect even though accurate date and time are input. Replace the battery suitably (📖69).</li> <li>• IP ADDRESS, SUBNET MASK and DEFAULT GATEWAY indicate “0.0.0.0” when DHCP is ON and the projector has not gotten address from DHCP server.</li> </ul>
<p><b>SERVICE</b></p>	<p>Executing this item restarts and initializes the network functions. Choose the RESTART EXECUTE using the button ►.</p>  <p>Then use the button ► to execute.</p>  <p>Network will be once cut off when choose restart. If DHCP is selected on, IP address may be changed. After selecting RESTART EXECUTE, NETWORK menu may not be controlled approx. 30 seconds.</p>

# SECURITY menu

This projector is equipped with security functions.

From the SECURITY menu, items shown in the table below can be performed.

To use SECURITY menu: User registration is required before using the security functions.

## Enter the SECURITY menu

1. Use the ▲/▼ cursor buttons on the SECURITY menu to select ENTER PASSWORD and press the ► cursor (or the **ENTER**) button. The ENTER PASSWORD box will be displayed.
2. Use the ▲/▼/◀/▶ cursor buttons to enter the registered password. The factory default password is **3410**. This password can be changed ([below](#)). Move the cursor to the right side of the ENTER PASSWORD box and press the ► cursor (or the **ENTER**) button to display the SECURITY menu.
  - It is strongly recommended the factory default password to be changed as soon as possible.
  - If an incorrect password is input, the ENTER PASSWORD box will be displayed again. If incorrect password is input 3 times, the projector will turn off. Afterwards the projector will turn off every time an incorrect password is input.
3. Items shown in the table below can be performed.



## If you have forgotten your password



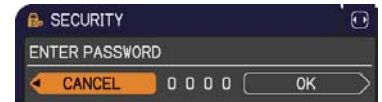

- (1) While the ENTER PASSWORD box is displayed, press and hold the **RESET** (or press the ◀ cursor and the **INPUT** buttons at the same time) button for about 3 seconds.
  - (2) The 10 digit Inquiring Code will be displayed. Contact your dealer with the 10 digit Inquiring Code. Your password will be sent after your user registration information is confirmed.
- If there is no key input for about 55 seconds while the Inquiring Code is displayed, the menu will close. If necessary, repeat the process from (1).

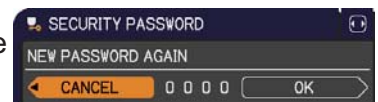



Item	Description
<p><b>SECURITY PASSWORD CHANGE</b></p>	<ol style="list-style-type: none"> <li>(1) Use the ▲/▼ cursor buttons on the SECURITY menu to select SECURITY PASSWORD CHANGE and press the ► cursor (or the <b>ENTER</b>) button to display the ENTER NEW PASSWORD box.</li> <li>(2) Use the ▲/▼/◀/▶ cursor buttons to enter the new password.</li> <li>(3) Move the cursor to the right side of the ENTER NEW PASSWORD box and press the ► cursor (or the <b>ENTER</b>) button to display the NEW PASSWORD AGAIN box, enter the same password again.</li> <li>(4) Move the cursor to the right side of the NEW PASSWORD AGAIN box and press the ► cursor (or the <b>ENTER</b>) button and the NOTE NEW PASSWORD box will be displayed for about 30 seconds, please make note of the password during this time. Pressing the ► cursor (or the <b>ENTER</b>) button will close the NOTE NEW PASSWORD box.</li> </ol> <ul style="list-style-type: none"> <li>• Please do not forget your password.</li> </ul>

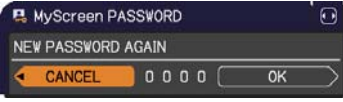

(continued on next page)

Item	Description
<p><b>MyScreen PASSWORD</b></p>	<p>The MyScreen PASSWORD function can be used to prohibit access to the MyScreen function and prevent the currently registered MyScreen image from being overwritten.</p> <p><b>1 Turning on the MyScreen PASSWORD</b></p> <p>1-1 Use the ▲/▼ cursor buttons on the SECURITY menu to select MyScreen PASSWORD and press the ► cursor (or the <b>ENTER</b>) button to display the MyScreen PASSWORD on/off menu.</p>  <p>1-2 Use the ▲/▼ cursor buttons on the MyScreen PASSWORD on/off menu to select ON. The ENTER NEW PASSWORD box (small) will be displayed.</p>  <p>1-3 Use the ▲/▼/◀/▶ cursor buttons to enter the password. Move the cursor to the right side of the ENTER NEW PASSWORD box (small) and press the ► cursor (or the <b>ENTER</b>) button to display the NEW PASSWORD AGAIN box, enter the same PASSWORD again.</p>  <p>1-4 Move the cursor to the right side of the NEW PASSWORD AGAIN box and press the ► cursor (or the <b>ENTER</b>) button to display the NOTE NEW PASSWORD box for about 30 seconds, please make note of the password during this time.</p>  <p>Pressing the ► cursor (or the <b>ENTER</b>) button will return to the MyScreen PASSWORD on/off menu.</p> <p>When a password is set for the MyScreen:</p> <ul style="list-style-type: none"> <li>• The MyScreen registration function (and menu) will be unavailable.</li> <li>• The MyScreen Lock menu will be unavailable.</li> <li>• The START UP setting will be locked on MyScreen (and the menu will be unavailable).</li> </ul> <p>Turning the MyScreen PASSWORD off will allow normal operation of these functions.</p> <ul style="list-style-type: none"> <li>• Please do not forget your MyScreen PASSWORD.</li> </ul> <p><b>2 Turning off the MyScreen PASSWORD</b></p> <p>2-1 Follow the procedure in 1-1 to display the MyScreen PASSWORD on/off menu.</p> <p>2-2 Select the OFF to display the ENTER PASSWORD box (large). Enter the registered password and the screen will return to the MyScreen PASSWORD on/off menu.</p>  <p>If an incorrect PASSWORD is input, the menu will close. If necessary, repeat the process from 2-1.</p> <p><b>3 If you have forgotten your password</b></p> <p>3-1 Follow the procedure in 1-1 to display the MyScreen PASSWORD on/off menu.</p> <p>3-2 Select the OFF to display the ENTER PASSWORD box (large). The 10 digit Inquiring Code will be displayed inside the box.</p> <p>3-3 Contact your dealer with the 10 digit Inquiring Code. Your password will be sent after your user registration information is confirmed.</p>

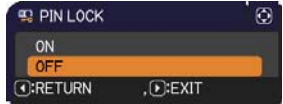

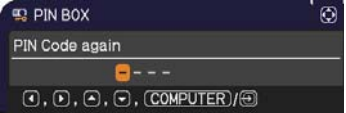
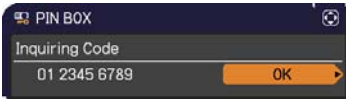

(continued on next page)

Item	Description
<p><b>PIN LOCK</b></p>	<p>The PIN LOCK is a function which prevents the projector from being used unless a registered Code is input.</p> <p><b>1 Turning on the PIN LOCK</b></p> <p>1-1 Use the ▲/▼ cursor buttons on the SECURITY menu to select PIN LOCK and press the ► cursor (or the <b>ENTER</b>) button to display the PIN LOCK on/off menu.</p>  <p>1-2 Use the ▲/▼ cursor buttons on the PIN LOCK on/off menu to select ON and the Enter PIN Code box will be displayed.</p>  <p>1-3 Input a 4 part PIN code using the ▲/▼/◀/▶ cursor and the <b>COMPUTER</b> (or the <b>INPUT</b>) button.</p> <p>The PIN Code again box will appear. Reenter the same PIN code. This will complete the PIN code registration.</p>  <ul style="list-style-type: none"> <li>• If there is no key input for about 55 seconds while the Enter PIN Code box or the PIN Code again box is displayed, the menu will close. If necessary, repeat the process from 1-1.</li> </ul> <p>Afterwards, anytime the projector is restarted after AC power is turned off the Enter PIN Code box will be displayed. Enter the registered the PIN code. The projector can be used after entering the registered the PIN code. If an incorrect PIN code is input, the Enter PIN code box will be displayed again. If an incorrect PIN Code is input 3 times, the projector will turn off. Afterwards the projector will turn off every time an incorrect PIN code is input. The projector will also turn off if there is no key input for about 5 minutes while the Enter PIN code box is displayed. This function will activate only when the projector is started after AC power is turned off.</p> <ul style="list-style-type: none"> <li>• Please do not forget your PIN code.</li> </ul> <p><b>2 Turning off the PIN LOCK</b></p> <p>2-1 Follow the procedure in 1-1 to display the PIN LOCK on/off menu.</p> <p>2-2 Use the ▲/▼ cursor buttons to select the OFF and the Enter PIN Code box will be displayed.</p> <p>Enter the registered the PIN code to turn the PIN LOCK function off. If an incorrect the PIN Code is input 3 times, the menu will close.</p> <p><b>3 If you have forgotten your PIN Code</b></p> <p>3-1 While the Enter PIN Code box is displayed, press and hold the <b>RESET</b> (or press the ◀ cursor and the <b>INPUT</b> buttons at the same time) button for 3 seconds.</p> <p>The 10 digit Inquiring Code will be displayed.</p>  <ul style="list-style-type: none"> <li>• If there is no key input for about 5 minutes while the Inquiring Code is displayed, the projector will turn off.</li> </ul> <p>3-2 Contact your dealer with the 10 digit Inquiring Code. Your PIN Code will be sent after your user registration information is confirmed.</p>

(continued on next page)

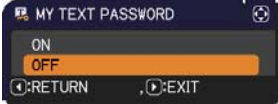
Item	Description
<p><b>TRANSITION DETECTOR</b></p>	<ul style="list-style-type: none"> <li>• Transition Detector alarm shown below might appear on screen, if the projector has been moved or re-installed.</li> <li>• Transition Detector alarm might appear on screen, if the MIRROR setting has been changed.</li> <li>• To display the signal again, set this function to the OFF.</li> <li>• After about 5 minutes of displaying the TRANSITION DETECTOR ON alarm, the lamp will turn off.</li> <li>• Keystone adjustment feature has been prohibited as long as the Transition Detector function is on.</li> </ul> <div data-bbox="1214 250 1474 416" style="border: 1px solid black; padding: 5px; margin-bottom: 10px;"> <p style="text-align: center;">&lt;&lt;TRANSITION DETECTOR ON&gt;&gt;</p> <p style="text-align: center; font-size: small;">The projector has been transferred from previously installed position.</p> <p style="text-align: center; font-size: x-small;">If you wish to have a square image on screen again, disable Transition Detector on Menu.</p> </div> <p><b>1 Turning on the TRANSITION DETECTOR</b></p> <p>1-1 Use the ▲/▼ cursor buttons on the SECURITY menu to select the TRANSITION DETECTOR and press the ► cursor (or the <b>ENTER</b>) button to display the TRANSITION DETECTOR on/off menu.</p> <div data-bbox="1193 651 1474 757" style="border: 1px solid black; padding: 5px; margin-bottom: 10px;"> <p style="text-align: center; font-size: x-small;">TRANSITION DETECTOR</p> <p style="text-align: center;">ON</p> <p style="text-align: center; background-color: orange;">OFF</p> <p style="text-align: center; font-size: x-small;">◀:RETURN    ▶:EXIT</p> </div> <p>1-2 Use the ▲/▼ cursor buttons on the TRANSITION DETECTOR on/off menu to select the ON. Select the ON and the current angle and the MIRROR setting will be recorded. The ENTER NEW PASSWORD box (small) will be displayed.</p> <div data-bbox="1129 819 1474 913" style="border: 1px solid black; padding: 5px; margin-bottom: 10px;"> <p style="text-align: center; font-size: x-small;">TRANSITION DETECTOR</p> <p style="text-align: center; font-size: x-small;">ENTER NEW PASSWORD</p> <p style="text-align: center; font-size: x-small;">◀ CANCEL 0 0 0 0 OK ▶</p> </div> <p style="text-align: center; font-size: small;">ENTER NEW PASSWORD box (small)</p> <p>1-3 Use the ▲/▼/◀/▶ cursor buttons to enter a password. Move the cursor to the right side of the ENTER NEW PASSWORD box (small) and press the ► cursor (or the <b>ENTER</b>) button to display the NEW PASSWORD AGAIN box, enter the same password again.</p> <div data-bbox="1129 1032 1474 1126" style="border: 1px solid black; padding: 5px; margin-bottom: 10px;"> <p style="text-align: center; font-size: x-small;">TRANSITION DETECTOR</p> <p style="text-align: center; font-size: x-small;">NEW PASSWORD AGAIN</p> <p style="text-align: center; font-size: x-small;">◀ CANCEL 0 0 0 0 OK ▶</p> </div> <p>1-4 Move the cursor to the right side of the NEW PASSWORD AGAIN box and press the ► cursor (or the <b>ENTER</b>) button to display the NOTE NEW PASSWORD box for about 30 seconds, please make note of the password during this time.</p> <div data-bbox="1129 1200 1474 1294" style="border: 1px solid black; padding: 5px; margin-bottom: 10px;"> <p style="text-align: center; font-size: x-small;">TRANSITION DETECTOR</p> <p style="text-align: center; font-size: x-small;">NOTE NEW PASSWORD</p> <p style="text-align: center; font-size: x-small;">0 0 0 0    OK ▶</p> </div> <p>Pressing the ► cursor (or the <b>ENTER</b>) button will return to the TRANSITION DETECTOR on/off menu.</p> <ul style="list-style-type: none"> <li>• Please do not forget your TRANSITION DETECTOR password.</li> <li>• This function will activate only when the projector is started after turning off the AC power.</li> <li>• This feature may not function properly if the projector is not in a stable position when the ON is selected.</li> </ul> <p><b>2 Turning off the TRANSITION DETECTOR</b></p> <p>2-1 Follow the procedure in 1-1 to display the TRANSITION DETECTOR on/off menu.</p> <p>2-2 Select the OFF to display the ENTER PASSWORD box (large). Enter the registered password and the screen will return to the TRANSITION DETECTOR on/off menu.</p> <div data-bbox="1129 1700 1474 1816" style="border: 1px solid black; padding: 5px; margin-bottom: 10px;"> <p style="text-align: center; font-size: x-small;">TRANSITION DETECTOR</p> <p style="text-align: center; font-size: x-small;">ENTER PASSWORD</p> <p style="text-align: center; font-size: x-small;">Inquiring Code    01 2345 6789</p> <p style="text-align: center; font-size: x-small;">◀ CANCEL 0 0 0 0 OK ▶</p> </div> <p style="text-align: center; font-size: small;">ENTER PASSWORD box (large)</p> <p>If an incorrect password is input, the menu will close. If necessary, repeat the process from 2-1.</p> <p><b>3 If you have forgotten your password</b></p> <p>3-1 Follow the procedure in 1-1 to display the TRANSITION DETECTOR on/off menu.</p> <p>3-2 Select the OFF to display the ENTER PASSWORD box (large). The 10 digit Inquiring Code will be displayed inside the box.</p> <p>3-3 Contact your dealer with the 10 digit Inquiring Code. Your password will be sent after your user registration information is confirmed.</p>

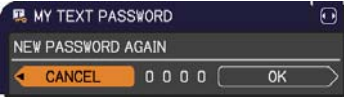
(continued on next page)

Item	Description
<p><b>MY TEXT PASSWORD</b></p>	<p>The MY TEXT PASSWORD function can prevent the MY TEXT from being overwritten. When the password is set for the MY TEXT;</p> <ul style="list-style-type: none"> <li>• The MY TEXT DISPLAY menu will be unavailable, which can prohibit changing the DISPLAY setting.</li> <li>• The MY TEXT WRITING menu will be unavailable, which can prevent the MY TEXT from being overwritten.</li> </ul> <p><b>1 Turning on the MY TEXT PASSWORD</b></p> <p>1-1 Use the ▲/▼ cursor buttons on the SECURITY menu to select the MY TEXT PASSWORD and press the ► cursor (or the <b>ENTER</b>) button to display the MY TEXT PASSWORD on/off menu.</p>  <p>1-2 Use the ▲/▼ cursor buttons on the MY TEXT PASSWORD on/off menu to select the ON. The ENTER NEW PASSWORD box (small) will be displayed.</p>  <p>1-3 Use the ▲/▼/◀/▶ cursor buttons to enter the password. Move the cursor to the right side of the ENTER NEW PASSWORD box (small) and press the ► cursor (or the <b>ENTER</b>) button to display the NEW PASSWORD AGAIN box, and then enter the same password again.</p>  <p>1-4 Move the cursor to the right side of the NEW PASSWORD AGAIN box and press the ► cursor (or the <b>ENTER</b>) button to display the NOTE NEW PASSWORD box for about 30 seconds, then please make note of the password during this time.</p>  <p>Pressing the ► cursor (or the <b>ENTER</b>) button will return to the MY TEXT PASSWORD on/off menu.</p> <p><b>2 Turning off the MY TEXT PASSWORD</b></p> <p>2-1 Follow the procedure in 1-1 to display the MY TEXT PASSWORD on/off menu.</p> <p>2-2 Select the OFF to display the ENTER PASSWORD box (large). Enter the registered password and the screen will return to the MY TEXT PASSWORD on/off menu.</p>  <p>If an incorrect password is input, the menu will close. If necessary, repeat the process from 2-1.</p> <p><b>3 If you have forgotten your password</b></p> <p>3-1 Follow the procedure in 1-1 to display the MY TEXT PASSWORD on/off menu.</p> <p>3-2 Select the OFF to display the ENTER PASSWORD box (large). The 10 digit inquiring code will be displayed inside the box.</p> <p>3-3 Contact your dealer with the 10 digit inquiring code. Your password will be sent after your user registration information is confirmed.</p>

(continued on next page)



Item	Description
<p><b>MY TEXT DISPLAY</b></p>	<p>(1) Use the ▲/▼ cursor buttons on the SECURITY menu to select the MY TEXT DISPLAY and press the ► cursor (or the <b>ENTER</b>) button to display the MY TEXT DISPLAY on/off menu.</p> <p>(2) Use the ▲/▼ cursor buttons on the MY TEXT DISPLAY on/off menu to select on or off.</p> <p>ON ⇔ OFF</p> <p>When it is set to the ON, the MY TEXT will be displayed on the START UP screen and the INPUT_INFORMATION when the INFORMATION on the SERVICE menu is chosen.</p> <ul style="list-style-type: none"> <li>• This function is available only when the MY TEXT PASSWORD function is set to the OFF.</li> </ul>
<p><b>MY TEXT WRITING</b></p>	<p>(1) Use the ▲/▼ cursor buttons on the SECURITY menu to select the MY TEXT WRITING and press the ► cursor (or the <b>ENTER</b>) button. The MY TEXT WRITING dialog will be displayed.</p> <p>(2) The current the MY TEXT will be displayed on the first 3 lines. If not yet written, the lines will be blank. Use the ▲/▼/◀/▶ cursor buttons and the <b>ENTER</b> (or the <b>INPUT</b>) button to select and enter characters. To erase 1 character at one time, press the <b>RESET</b> (or press the ◀ cursor and the <b>INPUT</b> buttons at the same time) button. Also if you move the cursor to the <b>DELETE</b> or the <b>ALL CLEAR</b> on screen and press the <b>ENTER</b> (or the <b>INPUT</b>) button, 1 character or all characters will be erased. The MY TEXT can be input up to 24 characters on each line.</p> <p>(3) To change an already inserted character, press the ▲/▼ cursor button to move the cursor to one of the first 3 lines, and use the ◀/▶ cursor buttons to move the cursor on the character to be changed. After pressing the <b>ENTER</b> (or the <b>INPUT</b>) button, the character is selected. Then, follow the same procedure as described at the item (2) above.</p> <p>(4) To finish entering text, move the cursor to the <b>OK</b> on screen and press the ► cursor (or the <b>ENTER</b>/the <b>INPUT</b>) button. To revert to the previous MY TEXT without saving changes, move the cursor to the <b>CANCEL</b> on screen and press the ◀ cursor (or the <b>ENTER</b>/the <b>INPUT</b>) button.</p> <ul style="list-style-type: none"> <li>• The MY TEXT WRITING function is available only when the MY TEXT PASSWORD function is set to the OFF.</li> </ul>

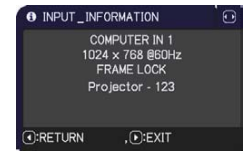
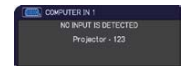

## Maintenance

## Replacing the lamp

A lamp has finite product life. Using the lamp for long periods of time could cause the pictures darker or the color tone poor. Note that each lamp has a different lifetime, and some may burst or burn out soon after you start using them. Preparation of a new lamp and early replacement are recommended. To prepare a new lamp, make contact with your dealer and tell the lamp type number.

Type number : DT01091

## Replacing the lamp

1. Turn the projector off, and unplug the power cord.
  - Allow the projector to cool for at least 45 minutes.
2. Prepare a new lamp. If the projector is mounted on a ceiling, or if the lamp has broken, also ask the dealer to replace the lamp.

**In case of replacement by yourself, follow the following procedure.**

3. Loosen the screw (marked by arrow) of the lamp cover and then slide and lift the lamp cover to the side to remove it.
4. Loosen the 2 screws (marked by arrow) of the lamp, and slowly pick up the lamp by the handles. **Never** loosen any other screws.
5. Insert the new lamp, and retighten firmly the 2 screws of the lamp that are loosened in the previous process to lock it in place.
6. While putting the interlocking parts of the lamp cover and the projector together, slide the lamp cover back in place. Then firmly fasten the screw of the lamp cover.
7. Turn the projector on and reset the lamp time using the LAMP TIME item in the OPTION menu.
  - (1) Press the **MENU** button to display a menu.
  - (2) Point at the ADVANCED MENU in the menu using the ▲/▼ cursor buttons, then press the ► cursor (or the **ENTER**) button.
  - (3) Point at the OPTION in the left column of the menu using the ▲/▼ cursor buttons, then press the ► cursor (or the **ENTER**) button.
  - (4) Point at the LAMP TIME using the ▲/▼ cursor buttons, then press the ► cursor (or the **ENTER** / the **RESET**) button. A dialog will appear.
  - (5) Press the ► cursor button to select the "OK" on the dialog. It performs resetting the lamp time.

lamp cover

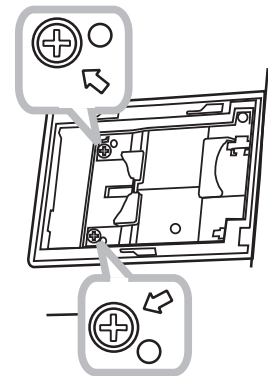
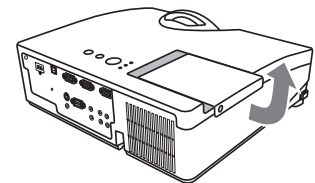
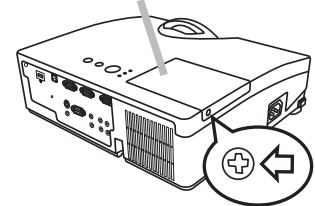

Handles

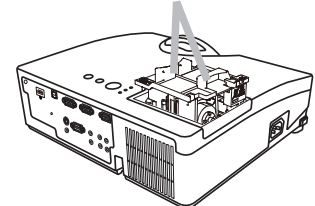

**⚠ CAUTION** ► Do not touch any inner space of the projector, while the lamp is taken out.

**NOTE** • Please reset the lamp time only when you have replaced the lamp, for a suitable indication about the lamp.

## Replacing the lamp (continued)

### Lamp warning

 **HIGH VOLTAGE**    **HIGH TEMPERATURE**    **HIGH PRESSURE**

**⚠ WARNING** ► The projector uses a high-pressure mercury glass lamp. The lamp can break with a loud bang, or burn out, if jolted or scratched, handled while hot, or worn over time. Note that each lamp has a different lifetime, and some may burst or burn out soon after you start using them. In addition, if the bulb bursts, it is possible for shards of glass to fly into the lamp housing, and for gas containing mercury and dust containing fine particles of glass to escape from the projector's vent holes.

► **About disposal of a lamp:** This product contains a mercury lamp; do not put it in a trash. Dispose of it in accordance with environmental laws.

- For lamp recycling, go to [www.lamprecycle.org](http://www.lamprecycle.org) (in the US).
- For product disposal, consult your local government agency or [www.eiae.org](http://www.eiae.org) (in the US) or [www.epsc.ca](http://www.epsc.ca) (in Canada).

For more information, call your dealer.



Disconnect  
the plug  
from the  
power  
outlet

- If the lamp should break (it will make a loud bang when it does), unplug the power cord from the outlet, and make sure to request a replacement lamp from your local dealer. Note that shards of glass could damage the projector's internals, or cause injury during handling, so please do not try to clean the projector or replace the lamp yourself.
- If the lamp should break (it will make a loud bang when it does), ventilate the room well, and make sure not to inhale the gas or fine particles that come out from the projector's vent holes, and not to get them into your eyes or mouth.
- Before replacing the lamp, turn the projector off and unplug the power cord, then wait at least 45 minutes for the lamp to cool sufficiently. Handling the lamp while hot can cause burns, as well as damaging the lamp.



- Never unscrew except the appointed (marked by an arrow) screws.
- Do not open the lamp cover while the projector is suspended from a ceiling. This is dangerous, since if the lamp's bulb has broken, the shards will fall out when the cover is opened. In addition, working in high places is dangerous, so ask your local dealer to have the lamp replaced even if the bulb is not broken.
- Do not use the projector with the lamp cover removed. At the lamp replacing, make sure that the screws are screwed in firmly. Loose screws could result in damage or injury.



- Use only the lamp of the specified type. Use of a lamp that does not meet the lamp specifications for this model could damage or shorten the life of this product.
- If the lamp breaks soon after the first time it is used, it is possible that there are electrical problems elsewhere besides the lamp. If this happens, consult your local dealer or a service representative.
- Handle with care: jolting or scratching could cause the lamp bulb to burst during use.
- Using the lamp for long periods of time, could cause it dark, not to light up or to burst. When the pictures appear dark, or when the color tone is poor, please replace the lamp as soon as possible. Do not use old (used) lamps; this is a cause of breakage.

## Cleaning and replacing the air filter

The air filter has two kinds of filters inside. Please check and clean the air filter periodically. When the indicators or a message prompts you to clean the air filter, comply with it as soon as possible. If the filters are damaged or heavily soiled, replace them with the new ones. To prepare the new filters, make contact with your dealer and tell the following type number.

**Type number : UX35971** (Filter unit)

When you replace the lamp, please replace the air filter. An air filter of specified type will come together with a replacement lamp for this projector.

1. Turn the projector off, and unplug the power cord. Allow the projector to sufficiently cool down.
2. Use a vacuum cleaner on and around the filter cover.
3. Pick and pull up the filter cover knobs to take it off.
4. Use a vacuum cleaner for the filter vent of the projector.
5. Take the fine meshed filter out while holding the filter cover. It is recommended to leave the coarse meshed filter in the filter cover as it is.
6. Use a vacuum cleaner on both sides of the fine meshed filter while holding it so it will not be sucked in. Use a vacuum cleaner for the inside of the filter cover to clean up the coarse meshed filter. If the filters are damaged or heavily soiled, replace them with new ones.
7. Put the fine meshed filter on the coarse meshed one, turning its stitched side up.
8. Put the filter unit back into the projector.
9. Turn the projector on and reset the filter time using the FILTER TIME item in the EASY MENU.
  - (1) Press the **MENU** button to display a menu.
  - (2) Point at the FILTER TIME using the ▲/▼ cursor buttons, then press the ► cursor (or the **ENTER** / the **RESET**) button. A dialog will appear.
  - (3) Press the ► cursor button to select the “OK” on the dialog. It performs resetting the filter time.

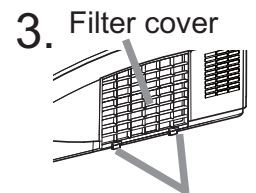
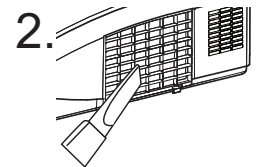

Filter cover knobs

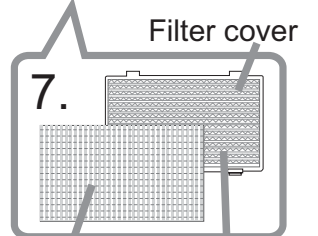
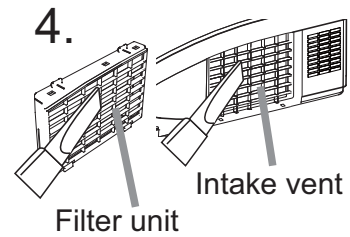

Filter (coarse meshed)  
Filter (fine meshed)

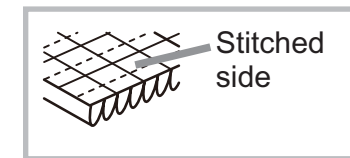

Stitched side

**⚠ WARNING** ► Before taking care of the air filter, make sure the power cable is not plugged in, then allow the projector to cool sufficiently.  
 ► Use only the air filter of the specified type. Do not use the projector without the air filter or the filter cover. It could result in a fire or malfunction to the projector.  
 ► Clean the air filter periodically. If the air filter becomes clogged by dust or the like, internal temperatures rise and could cause a fire, a burn or malfunction to the projector.

**NOTE** • Please reset the filter time only when you have cleaned or replaced the air filter, for a suitable indication about the air filter.  
 • The projector may display the message such as the “CHECK THE AIR FLOW” or turn off the projector, to prevent the internal heat level rising.

## Replacing the internal clock battery

Consumption of the battery makes the clock not to work correctly. When the clock is wrong or it has stopped, please replace the battery according to the following procedures..

1. Turn the projector off, and unplug the power cord. Allow the projector to cool sufficiently.
2. After making sure that the projector has cooled adequately, slowly turn over the projector, so that the bottom is facing.
3. Turn the battery cover fully in the direction indicated “**OPEN**” using a coin or the like, and pick the cover up to remove it.
4. Pry up the battery using a flathead screwdriver or the like to take it out. While prying it up, put a finger lightly on the battery since it may pop out of the holder.
5. Replace the battery with a new **HITACHI MAXELL**, Part No. **CR2032** or **CR2032H**.  
Slide the battery in under the plastic claw, and push it into the holder until it clicks.
6. Replace the battery cover in place, then turn it in the direction indicated “**CLOSE**” using such as coins, to fix.

Battery Cover

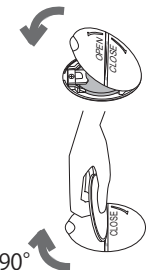
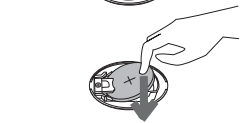
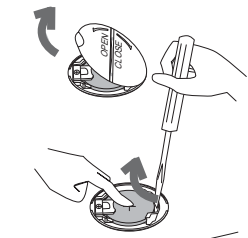
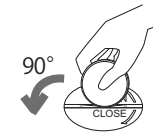
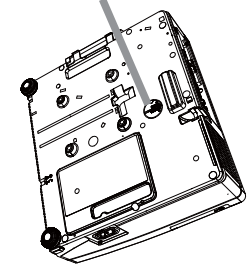

**⚠ WARNING** ► Always handle the batteries with care and use them only as directed. Battery may explode if mistreated. Do not recharge, disassemble or dispose of in fire.

And also improper use may result in cracking or leakage, which could result in fire, injury and/or pollution of the surrounding environment.

- Be sure to use only the batteries specified.
- Make sure the plus and minus terminals are correctly aligned when loading a battery.
- Keep a battery away from children and pets. If swallowed consult a physician immediately for emergency treatment.
- Do not short circuit or solder a battery.
- Do not allow a battery in a fire or water. Keep batteries in a dark, cool and dry place.
- If you observe battery leakage, wipe out the leakage and then replace a battery. If the leakage adheres to your body or clothes, rinse well with water immediately.
- Obey the local laws on disposing a battery.

## Other care

### Inside of the projector

In order to ensure the safe use of your projector, please have it cleaned and inspected by your dealer about once every year.

### Caring for the lens

- If the lens is flawed, soiled or fogged, it can cause deterioration in display quality. Handle the projector carefully to prevent the lens from being scratched or soiled.
- If the lens is soiled or fogged, please take care of the lens by following steps below.

1. Turn the projector off, and unplug the power cord. Allow the projector to cool sufficiently.
2. After making sure that the projector is cool adequately, lightly wipe the lens with a commercially available lens-cleaning wipe. Do not touch the lens directly with your hand.

### Caring for the cabinet and remote control

Incorrect care could have adverse influence such as discoloration, peeling paint, etc.

1. Turn the projector off, and unplug the power cord. Allow the projector to cool sufficiently.
2. After making sure that the projector is cool adequately, lightly wipe with gauze or a soft cloth.  
If the projector is extremely dirty, dip soft cloth in water or a neutral cleaner diluted in water, and wipe lightly after wringing well. Then, wipe lightly with a soft, dry cloth.

**⚠ WARNING** ▶ Before caring, make sure the power cord is not plugged in, and then allow the projector to cool sufficiently. The care in a high temperature state of the projector could cause a burn and/or malfunction to the projector.

▶ Never try to care for the inside of the projector personally. Doing is so dangerous.

▶ Avoid wetting the projector or inserting liquids in the projector. It could result in a fire, an electric shock, and/or malfunction to the projector.

- Do not put anything containing water, cleaners or chemicals near the projector.
- Do not use aerosols or sprays.

**⚠ CAUTION** ▶ Please take right care of the projector according to the following. Incorrect care could cause not only an injury but adverse influence such as discoloration, peeling paint, etc.

▶ Do not use cleaners or chemicals other than those specified in this manual.

▶ Do not polish or wipe with hard objects.

## Troubleshooting

If an abnormal operation should occur, stop using the projector immediately.

**⚠ WARNING** ► Never use the projector if abnormal operations such as smoke, strange odor, excessive sound, damaged casing or elements or cables, penetration of liquids or foreign matter, etc. should occur. In such cases, immediately disconnect the power plug from the power outlet. After making sure that the smoke or odor has stopped, contact to your dealer or service company.





Otherwise if a problem occurs with the projector, the following checks and measures are recommended before requesting repair.

If this does not resolve the problem, please contact your dealer or service company. They will tell you what warranty condition is applied.

(continued on next page)

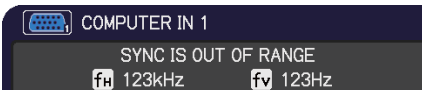
## Related messages

When some message appears, check and cope with it according to the following table. Although these messages will be automatically disappeared around several minutes, it will be reappeared every time the power is turned on.

Message	Description
	<p><b>There is no input signal.</b> Please confirm the signal input connection, and the status of the signal source.</p>
	<p><b>The horizontal or vertical frequency of the input signal is not within the specified range.</b> Please confirm the specs for your projector or the signal source specs.</p>
	<p><b>An improper signal is input.</b> Please confirm the specs for your projector or the signal source specs.</p>
	<p><b>The interior temperature is too high, or has increased or decreased in a short term.</b> Please turn the power off, and allow the projector to cool down at least 20 minutes. After having confirmed the following items, please turn the power on again.</p> <ul style="list-style-type: none"> <li>• Is there blockage of the air passage aperture?</li> <li>• Is the air filter dirty?</li> <li>• Does the peripheral temperature exceed 35°C?</li> <li>• Does warm or cool air from an air conditioner or similar unit blow on the projector directly?</li> </ul> <p>If the same indication is displayed after the remedy, please set FAN SPEED of the SERVICE item in the OPTION menu to HIGH.</p>
	<p><b>A note of precaution when cleaning the air filter.</b> Please immediately turn the power off, and clean or change the air filter referring to the “Cleaning and replacing the air filter” section of this manual. After you have cleaned or changed the air filter, please be sure to reset the filter time (📖48).</p>
	<p><b>The button operation is not available (📖7).</b></p>



## Regarding the indicator lamps

When operation of the **POWER**, **TEMP** and **LAMP** indicators differs from usual, check and cope with it according to the following table.

POWER	TEMP	LAMP	Description
Lighting In <b>Orange</b>	Turned <b>off</b>	Turned <b>off</b>	<b>The projector is in a standby state.</b> Please refer to the section “Power on/off”.
<i>Blinking</i> In <b>Green</b>	Turned <b>off</b>	Turned <b>off</b>	<b>The projector is warming up.</b> Please wait.
Lighting In <b>Green</b>	Turned <b>off</b>	Turned <b>off</b>	<b>The projector is in an on state.</b> Ordinary operations may be performed.
<i>Blinking</i> In <b>Orange</b>	Turned <b>off</b>	Turned <b>off</b>	<b>The projector is cooling down.</b> Please wait.
<i>Blinking</i> In <b>Red</b>	(discre- tionary)	(discre- tionary)	<b>The projector is cooling down. A certain error has been detected.</b> Please wait until <b>POWER</b> indicator finishes blinking, and then perform the proper measure using the item descriptions below.
<i>Blinking</i> In <b>Red</b> or Lighting In <b>Red</b>	Turned <b>off</b>	Lighting In <b>Red</b>	<b>The lamp does not light, and there is a possibility that interior portion has become heated.</b> Please turn the power off, and allow the projector to cool down at least 20 minutes. After the projector has sufficiently cooled down, please make confirmation of the following items, and then turn the power on again. <ul style="list-style-type: none"> <li>• Is there blockage of the air passage aperture?</li> <li>• Is the air filter dirty?</li> <li>• Does the peripheral temperature exceed 35°C?</li> </ul> If the same indication is displayed after the remedy, please change the lamp referring to the section “Replacing the lamp”.
<i>Blinking</i> In <b>Red</b> or Lighting In <b>Red</b>	Turned <b>off</b>	<i>Blinking</i> In <b>Red</b>	<b>The lamp cover has not been properly fixed.</b> Please turn the power off, and allow the projector to cool down at least 45 minutes. After the projector has sufficiently cooled down, please make confirmation of the attachment state of the lamp cover. After performing any needed maintenance, turn the power on again. If the same indication is displayed after the remedy, please contact your dealer or service company.

(Continued on next page)

Regarding the indicator lamps (continued)

POWER	TEMP	LAMP	Description
Blinking In <b>Red</b> or Lighting In <b>Red</b>	Blinking In <b>Red</b>	Turned <b>off</b>	<b>The cooling fan is not operating.</b> Please turn the power off, and allow the projector to cool down at least 20 minutes. After the projector has sufficiently cooled down, please make confirmation that no foreign matter has become caught in the fan, etc., and then turn the power on again. If the same indication is displayed after the remedy, please contact your dealer or service company.
Blinking In <b>Red</b> or Lighting In <b>Red</b>	Lighting In <b>Red</b>	Turned <b>off</b>	<b>There is a possibility that the interior portion has become heated.</b> Please turn the power off, and allow the projector to cool down at least 20 minutes. After the projector has sufficiently cooled down, please make confirmation of the following items, and then turn the power on again. <ul style="list-style-type: none"> <li>• Is there blockage of the air passage aperture?</li> <li>• Is the air filter dirty?</li> <li>• Does the peripheral temperature exceed 35°C?</li> <li>• Does air from an air conditioner or similar unit blow on the projector directly?</li> </ul> If the same indication is displayed after the remedy, please set FAN SPEED of SERVICE item in OPTION menu to HIGH (📖50).
Lighting In <b>Green</b>	Simultaneous <i>blinking in <b>Red</b></i>		<b>It is time to clean the air filter.</b> Please immediately turn the power off, and clean or change the air filter referring to the section “Cleaning and replacing the air filter”. After cleaning or changing the air filter, please be sure to reset the filter timer. After the remedy, reset the power to ON.
Lighting In <b>Green</b>	Alternative <i>blinking in <b>Red</b></i>		<b>There is a possibility that the interior portion has become overcooled.</b> Please use the unit within the usage temperature parameters (5°C to 35°C). After the treatment, reset the power to ON.
Blinking In <b>Green</b> for approx. 3 seconds	Turned <b>off</b>	Turned <b>off</b>	<b>At least 1 Power ON schedule is saved to the projector.</b> Please refer to "Schedule Settings" section of <b>User's Manual - Network Guide</b> .

**NOTE** • When the interior portion has become overheated, for safety purposes, the projector is automatically shut down, and the indicator lamps may also be turned off. In such a case, disconnect the power cord, and wait at least 45 minutes. After the projector has sufficiently cooled down, please make confirmation of the attachment state of the lamp and lamp cover, and then turn the power on again.

## Shutting the projector down

Only when the projector can not be turned off by usual procedure (📖17), please push the shutdown switch using a pin or similar, and disconnect the power plug from the power outlet. Before turning it on again, wait at least 10 minutes to make the projector cool down enough.

Shutdown switch

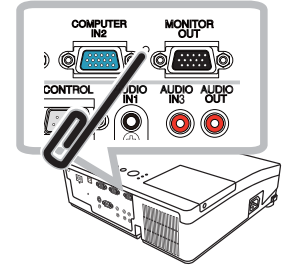

## Resetting all settings

If it is hard to correct some wrong settings, the FACTORY RESET function of SERVICE item in OPTION menu (📖54) can reset all settings (except LANGUAGE, FILTER TIME, LAMP TIME, FILTER MESSAGE, NETWORK, STANDBY MODE, SECURITY settings, and others) to the factory default.

## Phenomena that may be easy to be mistaken for machine defects

About the phenomenon confused with a machine defect, check and cope with it according to the following table.

Phenomenon	Cases not involving a machine defect	Reference page
Power does not come on.	<b>The electrical power cord is not plugged in.</b> Correctly connect the power cord.	14
	<b>The main power source has been interrupted during operation such as by a power outage (blackout), etc.</b> Please disconnect the power plug from the power outlet, and allow the projector to cool down at least 10 minutes, then turn the power on again.	14, 17
	<b>Either there is no lamp and/or lamp cover, or either of these has not been properly fixed.</b> Please turn the power off and disconnect the power plug from the power outlet, and allow the projector to cool down at least 45 minutes. After the projector has sufficiently cooled down, please make confirmation of the attachment state of the lamp and lamp cover, and then turn the power on again.	66, 67
Neither sounds nor pictures are outputted.	<b>The signal cables are not correctly connected.</b> Correctly connect the connection cables.	10
	<b>Signal source does not correctly work.</b> Correctly set up the signal source device by referring to the manual of the source device.	—
	<b>The input changeover settings are mismatched.</b> Select the input signal, and correct the settings.	18, 19
	<b>The BLANK function for pictures and the MUTE function for sounds are working.</b> AV MUTE may be active. Refer to the item “Sound does not come out” and “No pictures are displayed” on the next page to turn off the MUTE and BLANK functions.	18, 24, 49

(Continued on next page)

*Phenomena that may be easy to be mistaken for machine defects (continued)*

Phenomenon	Cases not involving a machine defect	Reference page
Sound does not come out.	<b>The signal cables are not correctly connected.</b> Correctly connect the audio cables.	10
	<b>The MUTE function is working.</b> Restore the sound pressing <b>MUTE</b> or <b>VOLUME +/-</b> button on the remote control.	18
	<b>The volume is adjusted to an extremely low level.</b> Adjust the volume to a higher level using the menu function or the remote control.	18
	<b>The AUDIO SOURCE/SPEAKER setting is not correct.</b> Correctly set the AUDIO SOURCE/SPEAKER in AUDIO menu.	40
	<b>The audio on your HDMI equipment is not set to Linear PCM.</b> The <b>HDMI</b> input on this projector supports Linear PCM audio only. Check the audio setting on your HDMI equipment.	11
	<b>The audio on the HDMI input is muted.</b> Change the audio setting in the AUDIO menu.	40
	<b>The digital audio in HDMI signal does not work well.</b> Use the analogue audio, connecting either an RCA audio cable or stereo mini cable.	10
No pictures are displayed.	<b>The lens cover is attached.</b> Remove the lens cover.	4
	<b>The signal cables are not correctly connected.</b> Correctly connect the connection cables.	10
	<b>The brightness is adjusted to an extremely low level.</b> Adjust BRIGHTNESS to a higher level using the menu function.	29
	<b>The computer cannot detect the projector as a plug and play monitor.</b> Make sure that the computer can detect a plug and play monitor using another plug and play monitor.	13
	<b>The BLANK screen is displayed.</b> Press the <b>BLANK</b> button on the remote control.	24

(Continued on next page)

**Phenomena that may be easy to be mistaken for machine defects (continued)**

Phenomenon	Cases not involving a machine defect	Reference page
No pictures or disturbed pictures are displayed on <b>HDMI</b> input.	<p><b>The HDMI cable is not correctly connected.</b> Correctly connect the HDMI cable.</p>	10
	<p><b>Your HDMI equipment is not compatible with the projector.</b> This projector can be connected with another equipment that has HDMI or DVI connector, but with some equipment the projector may not work properly.</p>	11
	<p><b>Your HDMI equipment and the projector are not harmonized.</b> Turn off the both equipment, and turn on them again.</p>	-
	<p><b>The signal format on the HDMI is not supported.</b> Check the video setting on your HDMI equipment.</p>	11
Video screen display freezes.	<p><b>The FREEZE function is working.</b> Press the <b>FREEZE</b> button to restore the screen to normal.</p>	24
Colors have a faded- out appearance, or Color tone is poor.	<p><b>Color settings are not correctly adjusted.</b> Perform picture adjustments by changing the COLOR TEMP, COLOR, TINT and/or COLOR SPACE settings, using the menu functions.</p>	30, 31, 34
	<p><b>COLOR SPACE setting is not suitable.</b> Change the COLOR SPACE setting to AUTO, RGB, SMPTE240, REC709 or REC601.</p>	34
Pictures appear dark.	<p><b>The brightness and/or contrast are adjusted to an extremely low level.</b> Adjust the BRIGHTNESS and/or the CONTRAST settings to a higher level using the menu function.</p>	29
	<p><b>The ECO MODE function is working.</b> Select the NORMAL for the ECO MODE item in the SETUP menu.</p>	38
	<p><b>The lamp is approaching the end of its product lifetime.</b> Replace the lamp.</p>	66, 67
Pictures appear blurry.	<p><b>Either the focus and/or horizontal phase settings are not properly adjusted.</b> Adjust the focus using the focus ring, and/or the H PHASE using the menu function.</p>	21, 33
	<p><b>The lens is dirty or misty.</b> Clean the lens referring to the section “Caring for the lens”.</p>	70

(Continued on next page)

*Phenomena that may be easy to be mistaken for machine defects (continued)*

Phenomenon	Cases not involving a machine defect	Reference page
When the ASPECT is set to NATIVE, PICTURE POSITION does not work even if the vertical size of the displayed image does not fit visually on the effective display area.	<b>Vertical resolution of the input signal is equal to or more than the vertical resolution of display area that is determined by 1.5 x D-ZOOM adjustment value.</b> Change input signal resolution or/and D-ZOOM adjustment value so that vertical resolution of the input signal is less than 1.5 x D-ZOOM adjustment value (📖34).	38
No signal is output from the <b>MONITOR OUT</b> and <b>AUDIO OUT</b> ports.	<b>The SAVING function is working in the standby state.</b> Select the NORMAL for the STANDBY MODE item in the SETUP menu.	39
RS-232C does not work.		
RS-232C does not work.	<b>The COMMUNICATION TYPE for the CONTROL port is set to NETWORK BRIDGE.</b> Select OFF for COMMUNICATION TYPE item in the OPTION - SERVICE - COMMUNICATION menu.	52
Network does not work.	<b>The SAVING function is working.</b> Select the NORMAL for the STANDBY MODE item in the SETUP menu.	39
NETWORK BRIDGE function does not work.	<b>The NETWORK BRIDGE function is turned off.</b> Select NETWORK BRIDGE for COMMUNICATION TYPE item in the OPTION - SERVICE - COMMUNICATION menu.	52
Schedule function does not work.	<b>The SAVING function is working.</b> Select the NORMAL for the STANDBY MODE item in the SETUP menu.	39
Scheduled Power command does not work.	<b>Some specific kinds of errors have been detected.</b> Check the status of the <b>POWER, TEMP, LAMP</b> indicators on the control panel of the projector and take countermeasures referring to the table on page 73 and 74.	73, 74
Scheduled Input Source command function does not work.	<b>Security features are activated and the projector is locked.</b> Please release the security lock.	60

*Phenomena that may be easy to be mistaken for machine defects (continued)*

Phenomenon	Cases not involving a machine defect	Reference page
<p>Scheduled Display Image command does not work.</p>	<p><b>The lamp is turned off.</b>                      If the projector is in the standby state, please press the <b>STANDBY/ON</b> button on the projector or the remote control to turn on the lamp. If the <b>POWER, TEMP, LAMP</b> indicators on the control panel of the projector represent some errors (such as temperature error, lamp error), take countermeasures referring to the table on page 73 and 74 and then turn on the lamp.</p>	<p>17, 73, 74</p>
	<p><b>Security features are activated and the projector is locked.</b>                      Please release the security lock.</p>	<p>60</p>
	<p><b>Image data for display is not stored in the projector.</b>                      No image data for display is registered in the specified data store number.                      Store image data for display in the projector.                      (📖 please refer to "3.5 MY IMAGE (Still Image Transfer) Display" in the Network guide.)</p>	<p>-</p>
<p>Scheduled Display Text command does not work.</p>	<p><b>The lamp is turned off.</b>                      If the projector is in the standby state, please press the <b>STANDBY/ON</b> button on the projector or the remote control to turn on the lamp. If the <b>POWER, TEMP, LAMP</b> indicators on the control panel of the projector represent some errors (such as temperature error, lamp error), take countermeasures referring to the table on page 73 and 74 and then turn on the lamp.</p>	<p>17, 73, 74</p>
	<p><b>No text data for display is registered.</b>                      No text data for display is registered in the specified data store number.                      Store the text data for display.                      (📖 please refer to "3.6 Messenger Function" in the Network guide.)</p>	<p>-</p>
	<p><b>High-priority text data is being displayed.</b>                      (📖 please refer to "3.6 Messenger Function" in the Network guide and the application manual for the Messenger function.)                      The projector is forced to turn the lamp on and displayed the high-priority text data. Text display by the scheduling function will not start until the projector completes the display of high-priority text data.</p>	<p>-</p>

**NOTE** • Although bright spots or dark spots may appear on the screen, this is a unique characteristic of liquid crystal displays, and it does not constitute or imply a machine defect.





Specifications (continued)

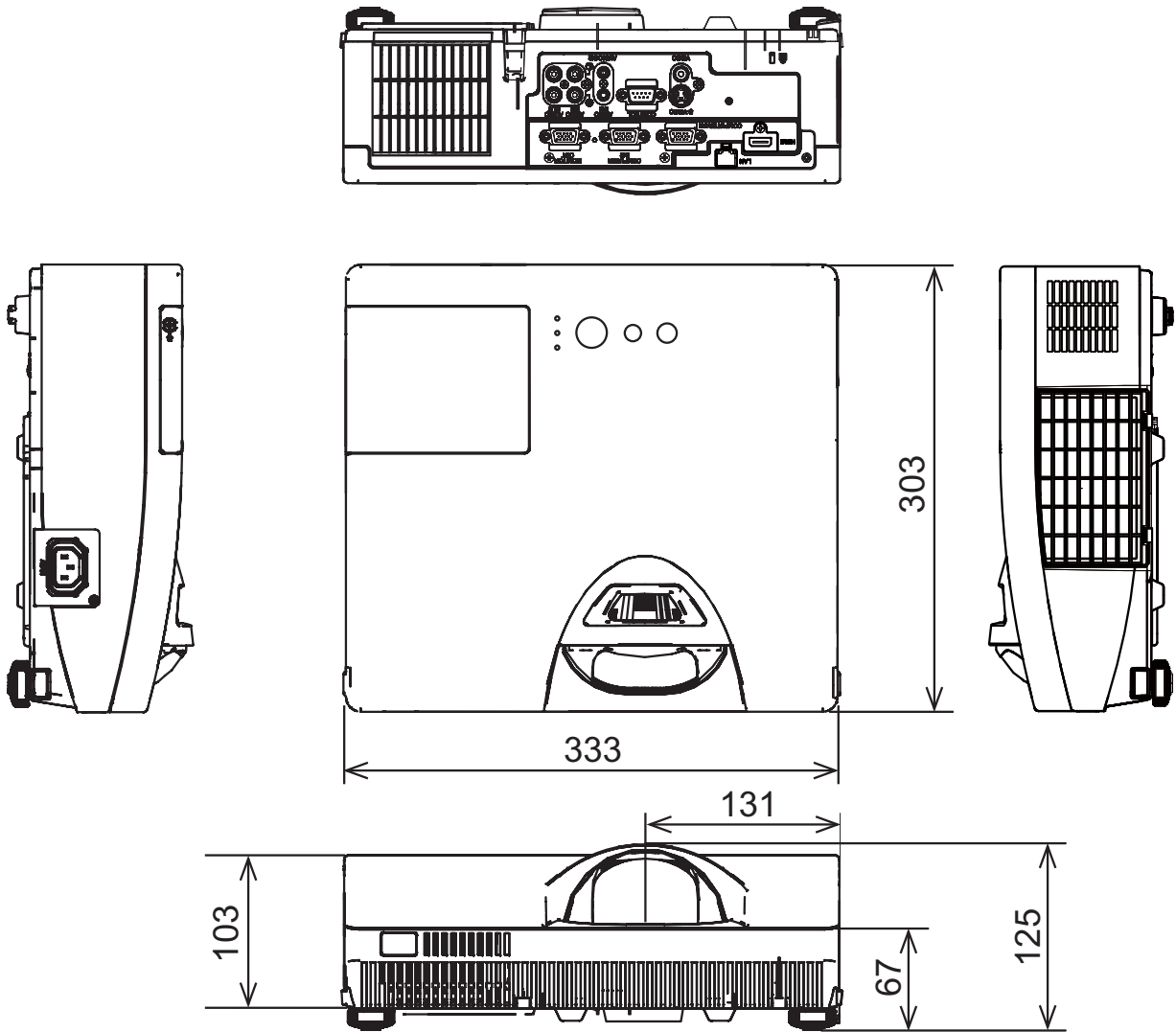

[unit: mm]