

myprojectorlamps.com

**The most trusted, dependable name
in projector lamp sales.**



<http://www.myprojectorlamps.com>



<http://www.myprojectorlamps.ca>



<http://www.myprojectorlamps.eu>

The following projector manual has not been modified or altered in any way.

Contents

Introduction.....	1
Notational conventions	2
Important notes.....	2
Safety notes.....	2
Cleaning notes	3
Transport notes	3
Manufacturer's notes	4
FCC Class A Compliance Statement	4
Important note on power cable	5
Disposal and recycling	5
Preparing for use	6
Unpacking and checking the delivery.....	6
Preparing remote control	7
Setting up the projector	7
Connecting the projector to a computer	7
Connecting the projector to the mains voltage	9
Operating the projector.....	10
Switching the projector on and off.....	11
Changing projector settings.....	13
Changing the OSD settings.....	14
Technical data	24
VESA-DDC-compatible DVI interface	25
Preset resolutions.....	25
DVI M1-D/A projector connection	26
Trouble shooting.....	27
Alarm indicator on the projector operator panel	27
The remote control does not work.....	27
Problems with the projected picture	27
Replacing the projector lamp.....	29

Introduction

Your new projector SCENICVIEW XP70 possesses a whole range of useful features and functions, e.g.:

- DLP technology (Digital Light Processing)
- minimal space requirements thanks to small casing
- easy to transport thanks to its low weight
- quiet operation
- high degree of brightness and good contrast
- Automatic Room Light Sensing - ARLS
- high resolution (1024x768); other resolutions (640x480 through 1280x1024) are converted to 1024x768
- presentation of up to 16.7 million colours (in conjunction with an appropriate graphics card)
- automatic scanning of all horizontal frequencies from 15 kHz to 100 kHz and all refresh rates (vertical frequencies) from 43.5 Hz to 130 Hz (all absolutely flicker-free)
- freely adjustable colour alignment for matching the screen colours to the colours of various input and output devices
- convenient operation via integrated OSD (On-Screen-display) menu
- Ability to control the computer from the projector's remote control (requires USB port on the computer)
- VESA-DDC compatibility
- plug&play capability
- power management for reducing power consumption when the connected computer is not in use

This operating manual contains important information you require to start up and run your projector.

A graphics card (screen controller) with VGA or DVI interface is required to control the projector. The projector processes the data supplied to it by the graphics card. The screen controller/the associated driver software is responsible for setting the modes (resolution and refresh rate).

The projector can also be controlled by various video signal sources via the integrated video interfaces.

When you operate the computer with an analogue signal source for the first time, you should adjust the projected image for the video card and set it to your requirements (see chapter "Operating the projector").

Target group

You don't need to be an "expert" to perform the operations described here. Do, however, read the "Important notes" chapter in the operating manual of the computer and in this operating manual.

In the event of any problems occurring, please contact your sales outlet or our customer service centre.

Additional information

Details of how you set the resolution and refresh rate are provided in the documentation on your screen controller/the associated driver software.

Notational conventions

The meanings of the symbols and fonts used in this manual are as follows:



Pay particular attention to text marked with this symbol. Failure to observe this warning endangers your life, destroys the device, or may lead to loss of data.



Supplementary information, remarks, and tips follow this symbol.

- Text which follows this symbol describes activities that must be performed in the order shown. "Quotation marks" indicate names of chapters or terms.

Important notes



Here you will find essential safety information regarding your projector.

Safety notes

This device complies with the relevant safety regulations for data processing equipment, including electronic office machines for use in an office environment. If you have any questions, contact your sales outlet or our customer service centre.

- Before you operate the project for the first time, read this operating manual carefully.
- Never open the unit. The projector contains no user-replaceable parts. Any repairs should only be performed by a qualified repair shop.
- If the device is brought into the installation site from a cold environment, condensation can form. Before operating the device, wait until it is absolutely dry and has reached approximately the same temperature as the installation site.
- During installation and before operating the device, observe the instructions on environmental conditions in the "Technical data" chapter.
- To keep the projector from overheating, never cover it while it is running. Keep all air openings clear. Do not place the projector on heat-sensitive material.
- Do not operate the projector near any heat sources.
- The projector automatically sets itself to the correct voltage within the range from 100 V to 240 V. Ensure that the local mains voltage lies within these limits.
- Ensure that the power socket on the projector or the grounded mains outlet is freely accessible.
- The ON/OFF switch does not disconnect the device from the mains voltage. To completely disconnect the mains voltage, remove the power plug from the socket.

- If you do not use the projector for a longer period of time, shut off the power source completely (for example, by switching off a power bar) or disconnect the power cable from the projector.
- Use only the included power cable or a cable that is approved for your country.
- Lay all cables so that nobody can stand on them or trip over them. When attaching the device, observe the relevant notes in the "Preparing for use chapter.
- No data transfer cables should be connected or disconnected during a thunderstorm.
- Make sure that no objects (e.g. jewellery chains, paper clips, etc.) or liquids get inside the device (danger of electric shock, short circuit).
- If you notice an unusual smell, see smoke, and in emergencies (e.g. damaged casing, components or cables, penetration of liquids or foreign matter), switch the unit off, disconnect the power plug and contact your sales outlet or our customer service center.
- Only qualified technicians should repair the device. Unauthorised opening and incorrect repair may greatly endanger the user (electric shock, fire risk).
- Do not look into the lens while the projector is running.
- To avoid injuries, always place the projector on a solid surface and use only the approved cover mount.
- You may set only those resolutions and refresh rates specified in the "Technical data" chapter.
- Allow the projector to cool down before you pack it up or transport it.
- Keep this operating manual together with your device. If you pass on the device to third parties, you should include this manual.

Cleaning notes

- Always pull out the power plug before you clean the projector.
- Do not clean any interior parts yourself, leave this job to a service technician.
- Do not use any cleaning agents that contain abrasives or may corrode colours.
- Ensure that no liquid will run into the system.
- Regularly clean the projector's air vents to maintain sufficient cooling air flow.
- The surface of the lens is sensitive to pressure and scratches. Clean it only using a soft, slightly moistened cloth.

Wipe the projector casing with a dry cloth. If the monitor is particularly dirty, use a cloth which has been moistened in mild domestic detergent and then carefully wrung out.

Transport notes

- Allow the projector to cool down before you pack it up or transport it.
- Transport the projector with care and only in its original packaging or another corresponding packaging fit to protect it against knocks and jolts.
- Above all, never drop the projector.

Manufacturer's notes

Energy Star



The Fujitsu Siemens projector SCENICVIEW XP70 is designed to conserve electricity by dropping to less than 11 W when it goes into standby, suspend and OFF mode. With this new power management the SCENICVIEW XP70 qualifies for the U.S. Environmental Protection Agency's (EPA) Energy Star Computers award.

The EPA estimates that computer equipment uses 5% percent of all business electricity and that this is growing rapidly. If all desktop computers and peripherals enter a low-power mode when not in use, the overall savings in electricity could amount to \$ 2 thousand million annually. These savings could also prevent the emission of 20 million tons of carbon dioxide into the atmosphere - the equivalent of 5 million automobiles.

As an Energy Star Partner, Fujitsu Siemens Computers GmbH has determined that this product meets the Energy Star guidelines for energy efficiency.

CE marking



The shipped version of this device complies with the requirements of the EEC directives 89/336/EEC "Electromagnetic compatibility" and 73/23/EEC "Low voltage directive".



Warning!

This is Class A device. This equipment may cause radio interference in a residential installation. In this case the user is encouraged to perform appropriate measures to correct the interference.

FCC Class A Compliance Statement

The following statement applies to the products covered in this manual, unless otherwise specified herein. The statement for other products will appear in the accompanying documentation.

NOTE:

This equipment has been tested and found to comply with the limits for a "Class A" digital device, pursuant to Part 15 of the FCC rules and meets all requirements of the Canadian Interference-Causing Equipment Regulations. These limits are designed to provide reasonable protection against harmful interference in a residential installation. This equipment generates, uses and can radiate radio frequency energy and, if not installed and used in strict accordance with the instructions, may cause harmful interference to radio communications. However, there is no guarantee that interference will not occur in a particular installation.

If this equipment does cause harmful interference to radio or television reception, which can be determined by turning the equipment off and on, the user is encouraged to try to correct the interference by one or more of the following measures:

- Reorient or relocate the receiving antenna.
- Increase the separation between equipment and the receiver.
- Connect the equipment into an outlet on a circuit different from that to which the receiver is connected.
- Consult the dealer or an experienced radio/TV technician for help.

Fujitsu Siemens Computers GmbH is not responsible for any radio or television interference caused by unauthorised modifications of this equipment or the substitution or attachment of connecting cables and equipment other than those specified by Fujitsu Siemens Computers GmbH. The correction of interference caused by such unauthorised modification, substitution or attachment will be the responsibility of the user.

The use of shielded I/O cables is required when connecting this equipment to any and all optional peripheral or host devices. Failure to do so may violate FCC rules.

Important note on power cable

To guarantee safe operation, use the cable supplied. Use the following guidelines if it is necessary to replace the original cable set.

- The female/male receptacles of the cord set must meet IEC60320/CEE-22 requirements.
- The cable has to be HAR-certified or VDE-certified. The mark HAR or VDE will appear on the outer sheath.
- For devices which are mounted on a desk or table, type SVT or SJT cable sets may be used. For devices which sit on the floor, only SJT type cable sets may be used.
- The cable set must be selected according to the rated current for your device.

Disposal and recycling

This device has been manufactured to the highest possible degree from materials which can be recycled or disposed of in a manner that is not environmentally damaging. The device may be taken back after use to be recycled, provided that it is returned in a condition that is the result of normal use. Any components not reclaimed will be disposed of in an environmentally acceptable manner.

If you have any questions about disposal of the batteries or system, please contact your local sales outlet or:

Germany	Belgium	Switzerland
Fujitsu Siemens Computers GmbH Remarketing und Recycling D-33106 Paderborn Tel.: +49 5251 / 81 80 10 Fax: +49 5251 / 81 80 15 <i>www.fujitsu-siemens.de/wvm</i>	RECUPEL Boulevard Reyers, 80 B-1030 Brussels Tel.: +32 2 / 706 86 16 Fax: +32 2 / 706 86 13 E-Mail: info@recupel.be <i>www.recupel.be</i>	SWICO Schweizerischer Wirtschaftsverband der Informations-, Kommunikations- und Organisationstechnik A list of the SWICO Acceptance places can be found at: <i>www.swico.ch</i>



The device may not be disposed of with household rubbish. This appliance is labelled in accordance with European Directive 2002/96/EG concerning used electrical and electronic appliances (waste electrical and electronic equipment - WEEE).

The guideline determines the framework for the return and recycling of used appliances as applicable throughout the EU. To return your used device, please use the return and collection systems available to you. You will find further information on this at www.fujitsu-siemens.com/recycling

Preparing for use



Please take note of the safety information in the "Important notes" chapter.

Unpacking and checking the delivery

- ▶ Check whether the delivery agrees with the details in the delivery note.
- ▶ Unpack all the individual parts.
- ▶ Check the delivery for damage incurred during transportation.
- ▶ Make sure that the following components are included.

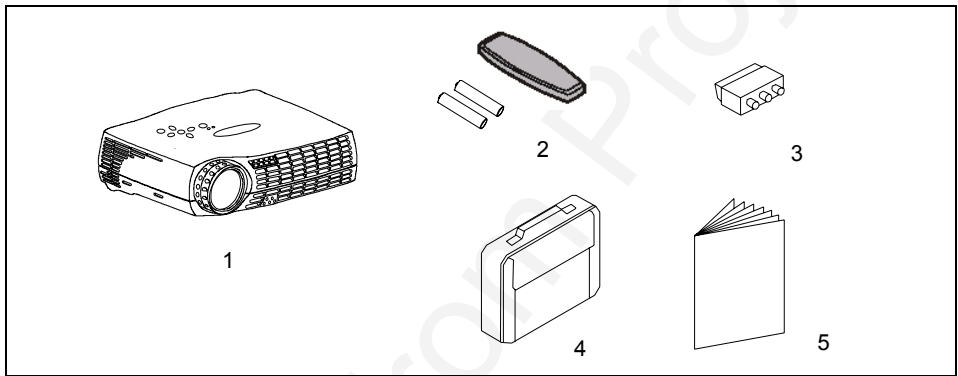

1 = Projector

2 = Remote control with batteries

3 = SCART adapter

4 = Carrying case

5 = Operating manual

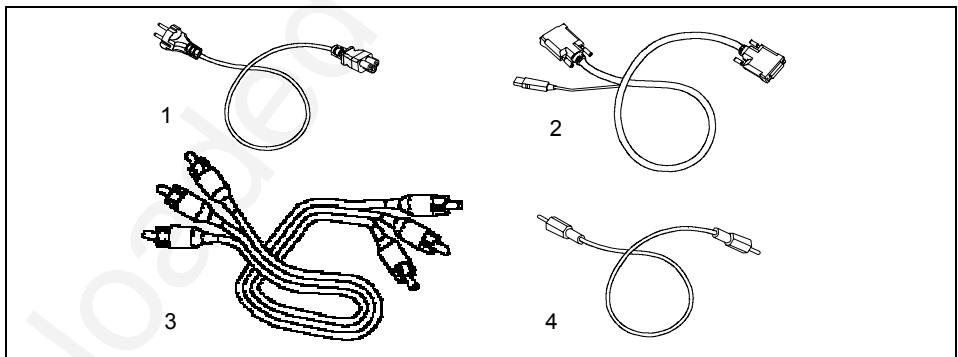

1 = Power cable

2 = Data cable DVI-VGA (M1-A with USB)
Data cable DVI-DVI (M1-D with USB)

3 = Audio/video cable (composite)

4 = Audio cable

Should you discover that the delivery does not correspond to the delivery note, notify your local sales outlet immediately.



It is recommended not to throw away the original packaging material. Keep it for future transportation.

Preparing remote control

Inserting batteries

- ▶ Open the back cover of the remote control by sliding it in the direction of the arrow.
- ▶ Place the batteries supplied in the battery compartment. Ensure correct polarity.
- ▶ Close the battery compartment by sliding the cover back on until you hear and feel it click into place.

Replacing batteries

- ▶ When the batteries are used up (indicator no longer lights up), replace them with two batteries of the same type (LR03-AAA, 1.5 V).

Do not throw batteries or accumulators into the household waste.

Setting up the projector

We recommend that you place your projector on a surface with good anti-slip qualities. In view of the multitude of different finishes and varnishes used on furniture, it is possible that the rubber feet of the projector as well as the high temperatures at the bottom of the projector will mark the surface the projector stands on.

Connecting the projector to a computer

Information on the computer connections and interfaces is contained in the operating manual for your computer.



Observe the safety precautions in the "Important notes" chapter in this operating manual.

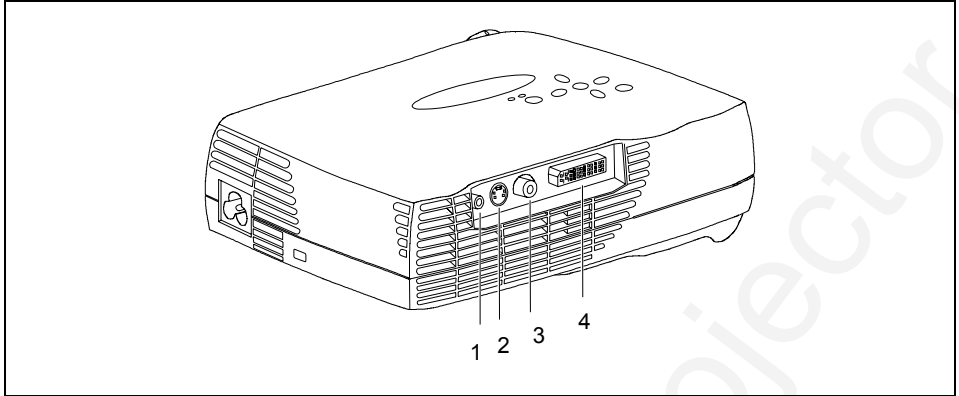

- | | |
|-----------------------------|----------------------------|
| 1 = Audio input (Audio in) | 3 = Video input (Video) |
| 2 = S-Video input (S-Video) | 4 = Computer input (M1-DA) |

► Be sure that the projector and the computer are switched off.



The computer power plug must be pulled out!

Connecting the data cable



Select the suitable data cable for your computer.

Analog: data cable DVI-VGA (M1-A with USB)

Digital: data cable DVI-DVI (M1-D with USB)

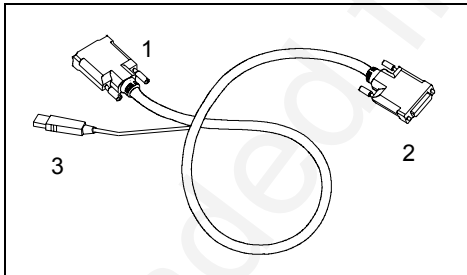

- | |
|--|
| 1 = Data connector for connection to computer |
| 2 = Data connector for connection to projector |
| 3 = USB connector |

► Connect the connector (1) of the data cable to the active monitor port on the computer and secure the plug-in connection by tightening the safety screws.



If your computer has two monitor ports ("onboard" screen controller and separate graphics card), the monitor port for the separate graphics card is usually active.

► Connect the plug (1) of the data cable to the M1-DA connector (4) at the back of the projector.

Connecting the USB cable

The projector has a computer interface with integrated USB functions. If your computer has a USB port and a driver for a USB mouse is loaded, you can control the computer with the projector's remote control as with a mouse. Proceed as follows:

- ▶ Insert the USB connector of the data cable (3) into the USB port on the computer (consult your computer's manual).

Connecting projector to video sources

You can connect a camcorder or similar video device with the included accessory cable to the "Video" and "Audio in" sockets. With the SCART cable, you can connect other video sources, for example a video recorder.

You can connect corresponding video signal sources to the "S-Video" connection. The necessary S-Video cable is not included.

You can connect a stereo output signal from your computer or from your audio/video source to the "Audio in" port with the cables provided in the accessories pack. Playback then takes place via the integrated loudspeaker. The volume can be adjusted with the "Volume" buttons in the control panel of the projector or in the control panel of the remote control.

Check the respective device manuals for additional information.

Connecting the projector to the mains voltage

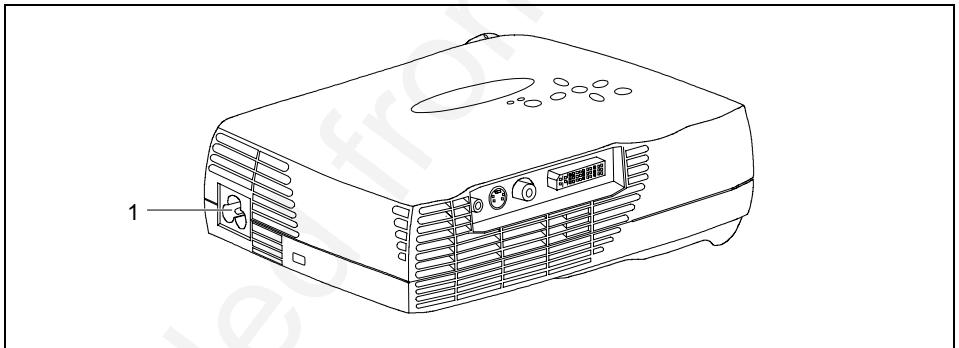

1 = Power connector

- ▶ Firmly insert the socket with the power cable supplied into the power connector (1) on the side of the projector and check whether the socket is securely connected.
- ▶ Connect the plug on the power cable supplied into a properly grounded mains outlet.
- ▶ If necessary, plug the power connector of the connected device into a properly grounded mains outlet.

Operating the projector

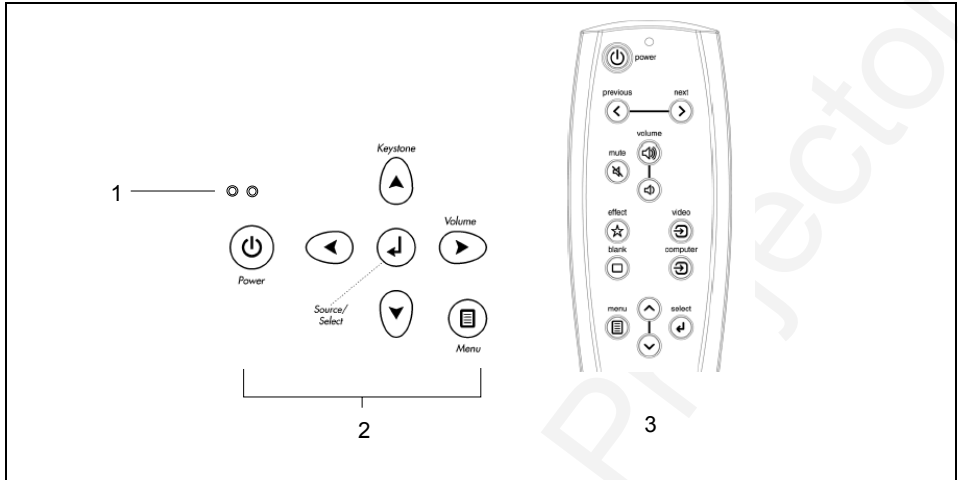

1 = Indicators (power indicator and alarm indicator)

2 = Control panel of the projector

3 = Control panel of the remote control



If the projector has power, the power indicator (1) glows orange.

Switching the projector on and off

Always turn the system units on in the following order.

- Switch the projector on.
- Switch the computer on.
- ▶ Turn the projector on with the power switch on the projector's operating panel (2) or on the remote control (3).

The power indicator (1) signals to current operating condition as follows:

Stage	Power indicator	Function	Power consumption
ON	lights green	The projector starts up and operates. If there is no signal, the preset logo is displayed.	< 175 W
OFF Cool-down phase	blinks slowly orange	The projector is shut down, the projector lamp is shut off (no image) and is being cooled, the fan runs. The projector cannot be turned on in this stage!	< 11 W
Standby mode	glows orange	The projector is in standby mode.	< 11 W



The projector can be turned on only when it is in standby mode.



Even when the projector is turned off, it is still connected to the power. Remove the plug from the mains outlet so that the system is totally disconnected from the mains voltage. Remove the power plug only when the power indicated glows orange!

Notes on power management



If your computer is equipped with power management, the projector supports this function. The projector is equipped with a two-level power management, which you can activate with the OSD menu (see section "Changing the OSD settings").

If your computer during a longer period detects no input (inactivity) or if the projector cannot find a signal source, it switches to power-saving mode. Refer to the following table for further information. For detailed information on how energy-saving mode operates refer to the operating manual or technical manual of the computer.

When the energy-saving mode is activated, the power indicator signals to current operating condition as follows:

Stage	Power indicator	Function	Power consumption
ON	lights green	The projector starts up and operates.	< 175 W
	flashes slowly green	The present logo is displayed, the projector searches for about three minute for a signal source. If the projector fails to find a signal source, it switches into the energy-saving mode after approximately three minutes.	< 175 W
Energy saving mode (power management)	flashes slowly green	The projector lamp is shut off (no image) and is being cooled, the projector searches for about five minutes for a signal source, the fan runs. As soon as the projector finds a signal source, the projector lamp is switched-on again. If the projector does not find any signal source within five minutes, it is switched into the standby mode.	< 11 W
OFF (standby mode)	glows orange	The projector is in standby mode.	< 11 W



If the energy-saving mode of the projector is not activated (*DPMS enable* deactivated), the projector is still switched on, even if there is no signal, the present logo is displayed.

When the projector is switched to the energy-saving mode by the power management system a power consumption of up to 11 W is maintained to feed the circuit for reswitching the projector.

To completely switch off the power consumption, pull the plug of the projector power cable out of the mains outlet. Remove the power plug only when the power indicated power orange!



Even when the projector is turned off, it is still connected to the power. Remove the plug from the mains outlet so that the system is totally disconnected from the mains voltage. Remove the power plug only when the power indicated glows orange!

Changing projector settings

Tilting the projector

With the projector foot (2 and 3) you can adjust the projector tilt within certain limits.

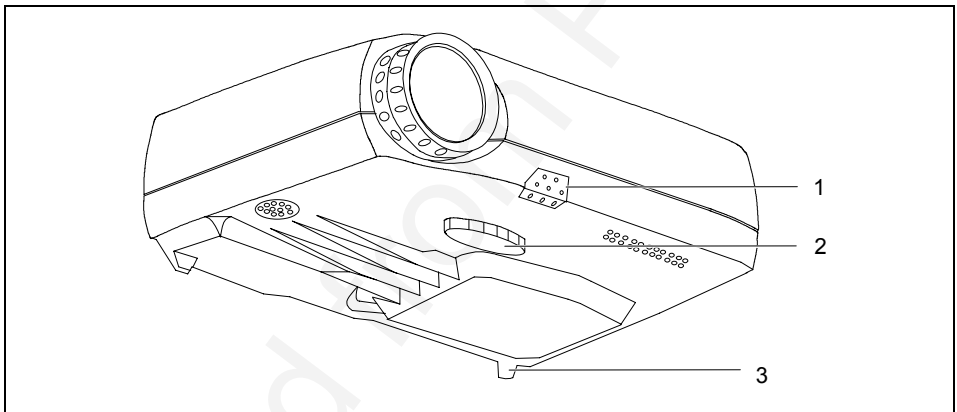

- ▶ Press the release button (1).
- ▶ Move the projector foot (2) into the desired position.
- ▶ Release the release button (1).
The projector foot is locked in the current position.
- ▶ Turn the projector foot (3) to change the inclination if necessary.

Adjusting picture definition and picture size

With the lens you can adjust the picture definition and picture size within certain limits.

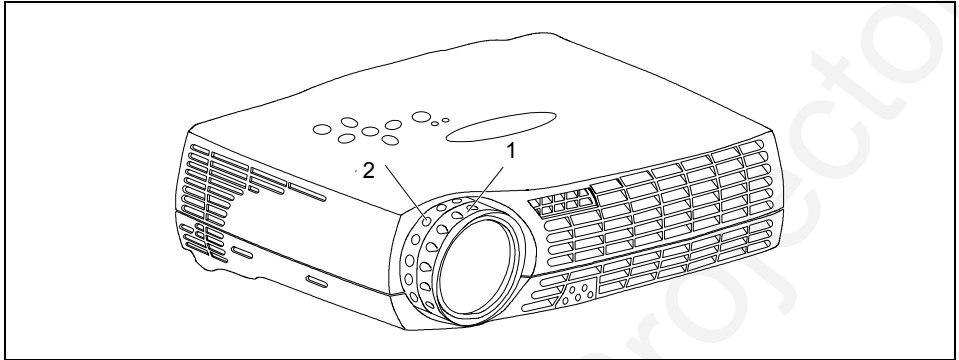

- ▶ Turn the focus ring (1) to adjust the picture sharpness.
- ▶ Turn the zoom ring (2) to adjust the picture size.

Correcting trapezoid distortion

With the ▲ and ▼ buttons you can correct for keystone distortion within certain limits. Keystone distortion occurs if the projector is not positioned at a right angle to the projection screen but projects from a higher or lower position. This function is also accessible via the OSD menu (see section "Changing the OSD settings").

- ▶ Press and hold the ▲ or ▼ button until the projected picture no longer looks distorted.

Other settings

During operation you can

- adjust the volume with the "Volume" button on the projector's operator panel or on the remote control
- switch between the signal sources with the "Source/Select" button on the projector's operator panel or with the "Computer" and "Video" buttons on the remote control

Changing the OSD settings

You can use the buttons on the control panels of the projector and the remote control to set the functions via an integrated OSD menu (On-Screen-display).



The OSD menu is available in eight languages (default setting: English). How to change the language for the OSD menu is described in the "Language menu" section. Most of the examples show the English OSD menu.

Operating the OSD menu with the projector's OSD menu

Activating the OSD menu

- ▶ Press the "Menu" button on the projector.

The basic menu is displayed.

Marking a function or submenu

- ▶ Use the arrow buttons to move the cursor to the desired function or submenu.

Selecting a function or submenu

- ▶ Press the "Source/Select" button.

The submenu opens, or you can make the desired settings.

Setting a function

- ▶ Press the ▲ or ▼ buttons until the setting is correct.

If the function can only be activated or deactivated:

- ▶ Select the desired function and activate it by pressing the "Source/Select" button.

Saving setting and terminating OSD menu

- ▶ Press the "Menu" button on the projector.



If you do not make a selection for about 40 seconds, the OSD menu closes, and the set value is stored.

Returning to the higher-level menu

- ▶ If you want to return to the higher-level menu, select the  symbol and confirm your selection with the "Select" button.

Operating the OSD menu with the remote control

Activating the OSD menu

- ▶ Press the "Menu" button on the remote control.

The basic menu is displayed.

Marking a function or submenu

- ▶ Use ▲ or ▼ buttons on the remote control to move the selection to the desired function or submenu.

Selecting a function or submenu

- ▶ Press the "Select" key.

The submenu opens, or you can make the desired settings.

Setting a function

- ▶ Press the ▲ or ▼ buttons on the remote control until the setting is correct.

If the function can only be activated or deactivated:

- ▶ Select the desired function and activate it by pressing the "Select" button.

Saving setting and terminating OSD menu

- ▶ Press the "Menu" button on the projector.



If you do not make a selection for about 40 seconds, the OSD menu closes, and the set value is stored.

Returning to the higher-level menu













- ▶ If you want to return to the higher-level menu, select the  symbol and confirm your selection with the "Select" button.

Basic menu

When you press the "Menu" button on the projector or the remote control, the basic menu appears.

	<p>With the basic menu, you can set contrast, brightness, colour and keystone or switch to the setup menu.</p>
---	--







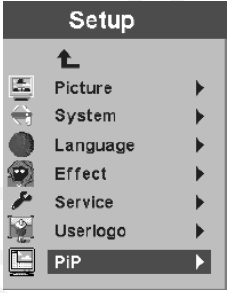

Possible adjustments in Basic menu



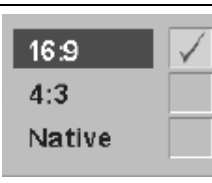



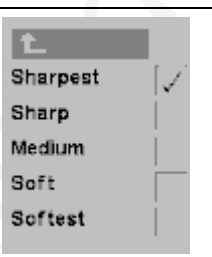

		Contrast You can adjust the contrast in the range from 0 to 100.
		Brightness You can adjust the brightness in the range from 0 to 100.
		Colour You can adjust the colour intensity of video images in the range from 0 to 100.
		White Level You can set the white level. The default values are 100% for signal sources from the computer and 20% for video signal sources. The changes are saved for each source when the projector is switched off.
		Keystone You can adjust the keystone correction in the range from -63 to +64.
		Setup The possible adjustments are described in the following.
		Reset The projector adjustments are synchronised for the active source.
		About Information on the active source is displayed.

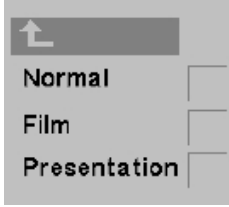
Setup menu

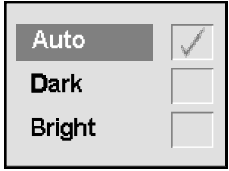



		From the setup menu you can select various submenus (Picture, System, Language, Effect, Service, User Logo, Picture in Picture).
---	---	--

Picture menu

	 <p>The screenshot shows the 'Picture' menu with the following options: Aspect Ratio, Colour Temp, Colour Space, Sharpness, Application, ARLS, Tune, Width, Position, and Tint. 'Aspect Ratio' is highlighted.</p>	<p>From the Picture menu you can set the picture's screen aspect, colour temperature, sharpness, application type, ARLS (Automatic Room Light Sensing), tuning, width, position, and colour tint.</p>
	 <p>The screenshot shows the 'Aspect Ratio' menu with three options: 16:9 (checked), 4:3, and Native.</p>	<p>Aspect Ratio</p> <p>You can select between 16:9 (wide-screen format), 4:3 (computer, conventional TV) and Native (original format)</p>
	 <p>The screenshot shows the 'Colour temperature' menu with two options: Film and Presentation.</p>	<p>Colour temperature</p> <p>You can select between different colour temperatures.</p>
	 <p>The screenshot shows the 'Color Space' menu with five options: Auto (checked), RGB (checked), SMPTE240, REC709, and REC601.</p>	<p>Color Space</p> <p>Color space: this option relates to computer sources. It allows you to select a color space that has been specially optimized for the video input signal.</p> <p><i>Auto</i> Standard settings are activated automatically</p> <ul style="list-style-type: none"> ▶ Deactivate <i>Auto</i> to select other settings. ▶ Then select RGB for computer sources or SMPTE240, REC709 or REC601 for component sources.
	 <p>The screenshot shows the 'Sharpness' menu with five options: Sharpest (checked), Sharp, Medium, Soft, and Softest.</p>	<p>Sharpness</p> <p>You can adjust the subjective sharpness from "Very Sharp" to "Very Soft".</p>

		<p>Application</p> <p>You can adjust the display to the current application type:</p> <ul style="list-style-type: none"> • Normal operation (computer) • Home theatre (video) • Photographs (with Gamma correction)
		<p>ARLS (Automatic Room Light Sensing)</p> <p>Automatically adapts the projector's brightness to the ambient light level. You can select between automatic adjustment, darker display, and brighter display.</p>
		<p>Tune</p> <p>You can set the phase length in the range from 0 to 100 and thus fine-tune analogue computer output if the automatic adjustment ("Reset" or basic settings in the basic menu) is unsatisfactory.</p>
		<p>Width</p> <p>You can set the horizontal frequency to optimise the picture width for analogue computer output if the automatic adjustment ("Reset" or basic settings in the basic menu) is unsatisfactory.</p>
		<p>Position</p> <p>You can adjust the picture position for analogue computer output if the automatic adjustment ("Reset" or basic settings in the basic menu) is unsatisfactory.</p>
		<p>Tint</p> <p>If you want to display video images in the NTSC format (American TV), you can adjust the tint in the range from 0 to 100. This setting has no effect on PAL or SECAM video images.</p>









System menu

	<p>System</p> <p>↑</p> <p>⌂ Rear <input type="checkbox"/></p> <p>🔍 SourceSearch <input type="checkbox"/></p> <p>📺 Hide OSD <input type="checkbox"/></p> <p>🔌 DPMS enable <input type="checkbox"/></p>	<p>In the System menu you can adjust general operating settings.</p>
	<p>Rear</p> <p>If you project the image from the back against a translucent surface, this setting flips the image horizontally.</p>	
	<p>SourceSearch</p> <p>With this function, the projector automatically looks for a signal source (computer or video).</p>	
	<p>Hide OSD</p> <p>If you activate this function, the menu functions are no longer displayed over the projected image (for example, when you adjust the volume or change the signal source). This function is useful if you have to adjust the volume during a presentation.</p>	
	<p>DPMS enable</p> <p>This function activates the DPMS (Display Power Management Signaling). When the projector receives a corresponding signal from the computer, it switches to power-saving mode.</p>	









Language menu

	<p>Language</p> <p>↑</p> <p>🇩🇪 Deutsch <input type="checkbox"/></p> <p>🇬🇧 English <input type="checkbox"/></p> <p>🇪🇸 Español <input type="checkbox"/></p> <p>🇫🇷 Français <input type="checkbox"/></p> <p>🇮🇹 Italiano <input type="checkbox"/></p> <p>🇳🇴 Norsk <input type="checkbox"/></p> <p>🇵🇹 Portuguese <input type="checkbox"/></p> <p>🇯🇵 日本語 <input type="checkbox"/></p> <p>🇨🇳 繁體中文 <input type="checkbox"/></p> <p>🇨🇳 簡體中文 <input type="checkbox"/></p>	<p>On the Language menu you can select the language for the OSD menu.</p>
--	--	---







Effect menu



		<p>In the Effect menu, you can assign one of the displayed functions to the "Effect" button on the remote control. You can select only one of these functions at a time.</p>
	<p>Magnify</p> <p>The picture is magnified until you press the "Effect" button again.</p> <p>▶ Set the magnification factor with the ▲ or ▼ buttons.</p>	
	<p>Freeze</p> <p>Freezes and displays the current picture until you press "Effect" again.</p>	
	<p>Mask</p> <p>The projected image is blacked out until you press the "Effect" button again.</p>	
	<p>Mute</p> <p>Mutes the sound until you press the "Effect" button again (works only with a video signal source).</p>	
	<p>16:9</p> <p>The picture is shown in the 16:9 format.</p>	
	<p>PIP</p> <p>Select "Picture in Picture" if you want to see a smaller picture of the video source over the computer picture.</p>	

Service menu





	<div style="border: 1px solid black; padding: 5px;"> <p style="text-align: center;">Service</p> <p style="text-align: center;">↑</p> <ul style="list-style-type: none">  Factory reset  Info  Reset lamptimer  Service code </div>	<p>With the Service menu you can look up certain information about the projector and can reset it to the factory settings.</p>
	<p>Factory reset</p> <p>All settings are reset to the factory settings.</p>	
	<p>Info</p> <p>Displays service information like the software version, operating hours, settings, etc.</p>	
	<p>Reset lamptimer</p> <p>▶ After replacing the lamp, set the lamp timer back to 0. Follow the instructions on the OSD menu.</p>	
	<p>Service code</p> <p>This function contains additional information that is only available to service personnel.</p>	

Userlogo menu

	<div style="border: 1px solid black; padding: 5px;"> <p style="text-align: center;">User's logo</p> <p style="text-align: center;">↑</p> <ul style="list-style-type: none"> Default <input type="checkbox"/>  Blue <input type="checkbox"/>  Black <input type="checkbox"/>  Captured <input type="checkbox"/>  Capture new <input type="checkbox"/> </div>	<p>In the user logo menu, you can select what the projector should display if it cannot find a signal source.</p>
<p>Default</p> <p>If the projector does not find a signal source it displays the Fujitsu Siemens Computers logo.</p>		
	<p>Blue</p> <p>If the projector does not find a signal source it displays a blue screen.</p>	

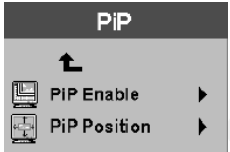
	<p>Black</p> <p>If the projector does not find a signal source it displays a black screen.</p>
	<p>Captured</p> <p>If the projector does not find a signal source it displays the logo captured by the user.</p>
	<p>Capture new</p> <p>You can capture your own logo. Proceed as follows:</p> <ul style="list-style-type: none"> ▶ Display the desired logo with the projector. ▶ Select the "Capture new" function. ▶ Select the range you want to display as the logo by moving the displayed frame with the ▲ or ▼ buttons over the logo. ▶ If necessary, adjust the frame to the logo size with the "Volume" buttons and confirm the selection with the "Select" button. ▶ Select the picture quality (High = 18bit, Low = 4bit) and confirm with the "Select" button. <p>The projector confirms that the capture was successful or reports an error.</p> <ul style="list-style-type: none"> ▶ Restart the projector.

PiP menu (Picture in Picture)

		<p>In the PiP menu you can select the position and size of the displayed picture.</p>
		<p>PiP Enable</p> <p>Select "PiP Enable" to activate the Picture in Picture mode and select the size of the Picture in Picture (PiP).</p>
	<p>PiP Position</p> <p>You can move the video picture on your screen with this function.</p>	

Technical data

Dimensions and weight (projector only)

Width	154 mm
Height	63 mm
Depth	195 mm
Weight	1,1 kg

Power connector

Rated mains voltage	100 V -240 V ($\pm 10\%$)
Frequency	50 Hz -60 Hz (± 3 Hz)
Total power consumption	< 175 W
Energy-saving mode	< 11 W

Display

Technology	DLP (Digital Light Processing)
Resolution	1024 x 768
Brightness	Max. 1400 ANSI lumen
Contrast	Typ. 1100:1
Colour	16.7 mio
Projector lamp	120 W UHP, life: 4000 h

Optical properties

Lens	1.85 - 2.35:1
Picture size	80 cm to 530 cm diagonal
Distance to projection screen	1.5 m – 10.0 m
Keystone correction	12° electronic

Compatibility

Projector

Computer	digital or analogue, PC, MAC, 1280 x 1024 max.
Horizontal frequency	15 kHz ... 100 kHz
Refresh rate	43.5 Hz ... 130 Hz
Maximum pixel rate	135 MHz

Video compatibility

Video	S-Video, Composite Video, PAL (all), SECAM (all), NTSC 3.58/4.43, HDTV
Audio	Stereo line in

Inputs/outputs**Projector**

Computer	M1-D/A for analogue and digital signals including USB
Video	RCA
S-Video	4 pin mini DIN
Loudspeakers	1 W Mono
Computer Audio	3.5 mm mini jack

Environmental conditions

Rated range of operation:	15 °C 35 °C
Humidity:	20 % 80 %
Limit range of operation:	5 °C 35 °C
Humidity:	20 % 80 %

Condensation must be avoided.

VESA-DDC-compatible DVI interface

The projector is equipped with a VESA-DDC-compatible DVI interface. VESA-DDC (Video Electronics Standard Association, Display Data Channel) is used as the communications interface between the projector and the computer. If your computer is equipped with a VESA-DDC-compatible DVI or VGA interface, it can automatically read the data for ensuring optimum operation from your projector and select the appropriate settings.

Preset resolutions

The projector can be used with the listed resolutions.

Screen resolution	Refresh rate
640 x 480	43.50 to 130 Hz
720 x 400	43.50 to 130 Hz
800 x 600	43.50 to 125 Hz
832 x 624	43.50 to 120 Hz
1024 x 768	43.50 to 95 Hz
1152 x 864	43.50 to 85 Hz
1152 x 870	43.50 to 85 Hz
1280 x 1024	43.50 to 75 Hz

DVI M1-D/A projector connection

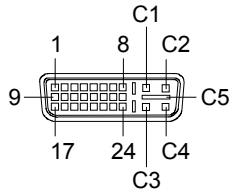

Pin	Meaning
1	TMDS Data 2-
2	TMDS Data 2+
3	TMDS Data 2/4 Shield
4	not used
5	not used
6	DDC Clock
7	DDC Data
8	Analogue Vertical Sync
9	TMDS Data 1-
10	TMDS Data 1+
11	TMDS Data 1/3 Shield
12	not used

C1	Analogue Red
C2	Analogue Green
C3	Analogue Blue

Pin	Meaning
13	not used
14	+5 V Power
15	Ground
16	Hot Plug Detect
17	TMDS Data 0-
18	TMDS Data 0+
19	TMDS Data 0/5 Shield
20	not used
21	not used
22	TMDS Clock Shield
23	TMDS Clock-
24	TMDS Clock+

C4	Analogue Horizontal Sync
C5	Analogue Ground

Trouble shooting

Should an error occur, first check the following points. If the distortion is still not eliminated, the projector should, if possible, be checked on another computer and/or with another data cable.

If you cannot solve the problem, contact our customer service centre.

Alarm indicator on the projector operator panel

Alarm indicator lights up red

Replace the projector lamp.

Alarm indicator blinks red rapidly

The projector has overheated.

- ▶ Turn the projector off and let it cool down.

Alarm indicator blinks red in intervals

The projector is being shut down due to overheating.

The remote control does not work.

Batteries may be empty.

- ▶ Change the batteries (see "Replacing batteries").

Problems with the projected picture

No display (power indicator does not light)

- ▶ Check whether the power cable is connected correctly on the projector and to the mains outlet.
- ▶ Check whether the mains socket is live.

No picture (power indicator glows orange)

- ▶ Check whether the projector is switched on.

No picture (power indicator glows green)

- ▶ Check whether the computer is switched on.
- ▶ Check whether the data cable for the projector is correctly attached to the monitor port on the computer.
- ▶ Press any key on the computer keyboard - the computer may be in energy saving mode.
- ▶ Alter the brightness and/or contrast until you get a picture.

Picture disturbances

- ▶ From the Basic menu (see "Changing the OSD settings") select the "Reset" function in order to reset the projector to its basic settings.

If the picture does still not improve:

- ▶ From the Setup menu (see "Changing the OSD settings") select the Picture menu and the "Tune" function.
- ▶ Adjust the projected image.
- ▶ From the Setup menu (see "Changing the OSD settings") select the Picture menu and the "Width" function.
- ▶ Adjust the projected picture width.

Unstable pixels or pixels that are constantly light or dark

The standard of production techniques today cannot guarantee an absolutely fault-free projection. There may be a few unstable or constantly light or dark pixels.

The following number of faulty pixels is permissible and no reason for a warranty claim:

- Unstable pixels: 3
- Light pixels: 5
- Dark pixels: 5

The projected picture is getting darker

The life of the projector lamp is limited, and its brightness decreases as it gets older. If the projected picture gets too dark, have the lamp replaced (after 4,000 operating hours at the latest).

Replacing the projector lamp

The projector lamp must be replaced once its useful life has expired.



Please only use lamps of the same type and strength!

Switch off the projector and disconnect the power cable. Wait for around 60 minutes before opening the lamp housing.

The lamp housing is intended to protect you from glass fragments in case the projector lamp explodes. Please therefore take special care when you open the lamp housing.



- ▶ Remove the three screws.



- ▶ Open the lamp housing with a screw driver.

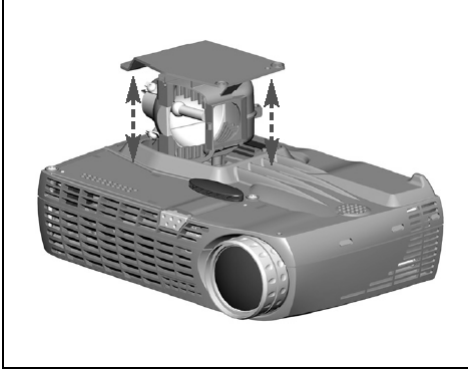

- ▶ Carefully remove the lamp housing and dispose of it in an environmentally friendly way.
- ▶ Insert the new lamp housing.
- ▶ Fasten the three screws again.
- ▶ After replacing the lamp, set the lamp timer back to 0. Follow the instructions on the OSD menu (see chapter Operating the projector".