

myprojectorlamps.com

**The most trusted, dependable name
in projector lamp sales.**



<http://www.myprojectorlamps.com>



<http://www.myprojectorlamps.ca>



<http://www.myprojectorlamps.eu>

The following projector manual has not been modified or altered in any way.

PROJECTOR

Betriebsanleitung / Operating Manual

XP60

Deutsch - English



Sie haben ...

... technische Fragen oder Probleme?

Wenden Sie sich bitte an
unseren Help Desk (siehe Garantieheft).

Aktuelle Informationen zu unseren Produkten, Tipps, Updates usw. finden Sie im Internet:
<http://www.fujitsu-siemens.com>

Are there ...

... any technical problems or other
questions you need clarified?

Please contact
our Help Desk (see Warranty booklet).

The latest information on our products, tips, updates, etc., can be found on the Internet under:
<http://www.fujitsu-siemens.com>

Dieses Handbuch wurde auf Recycling-Papier gedruckt.
This manual has been printed on recycled paper.
Ce manuel est imprimé sur du papier recyclé.
Este manual ha sido impreso sobre papel reciclado.
Questo manuale è stato stampato su carta da riciclaggio.
Denna handbok är tryckt på recyclingpapper.
Dit handboek werd op recycling-papier gedrukt.

Herausgegeben von/Published by
Fujitsu Siemens Computers GmbH

Bestell-Nr./Order No.: **A26361-K865-Z100-1-5E19**
Printed in Norway
AG 0602 06/02



A26361-K865-Z100-1-5E19

**XP60
Projektor
Projector**

**Betriebsanleitung
Operating Manual**

Deutsch

English

**Ausgabe Juni 2002
June 2002 edition**

VESA, DDC und DPMS sind eingetragene Warenzeichen der Video Electronics Standards Association.

Copyright © Fujitsu Siemens Computers GmbH 2002

Alle Rechte vorbehalten, insbesondere (auch auszugsweise) die der Übersetzung, des Nachdrucks, der Wiedergabe durch Kopieren oder ähnliche Verfahren.

Zu widerhandlungen verpflichten zu Schadenersatz.

Alle Rechte vorbehalten, insbesondere für den Fall der Patenterteilung oder GM-Eintragung.

Liefermöglichkeiten und technische Änderungen vorbehalten.

Dieses Handbuch wurde erstellt von
cognitas. Gesellschaft für Technik-Dokumentation mbH
www.cognitas.de

VESA, DDC and DPMS are registered trademarks of Video Electronics Standards Association.

Copyright © Fujitsu Siemens Computers GmbH 2002

All rights, including rights of translation, reproduction by printing, copying or similar methods, even of parts are reserved.

Offenders will be liable for damages.

All rights, including rights created by patent grant or registration of a utility model or design, are reserved.

Delivery subject to availability. Right of technical modification reserved.

This manual was produced by
cognitas. Gesellschaft für Technik-Dokumentation mbH
www.cognitas.de

Contents

Introduction.....	1
Notational conventions	2
Important notes.....	2
Safety	2
Cleaning notes.....	3
Transport notes	3
Manufacturer's notes	4
FCC Class A Compliance Statement	4
Important note on power cable.....	5
Disposal and recycling.....	5
Preparing for use	6
Unpacking and checking the delivery.....	6
Preparing remote control.....	7
Setting up the projector.....	8
Connecting the projector to a computer	8
Connecting the projector to the mains voltage	10
Operating the projector.....	10
Switching the projector on and off.....	11
Changing projector settings	13
Changing the OSD settings	14
Notes on ergonomic colour adjustment.....	23
Technical data	23
VESA-DDC-compatible DVI interface	25
Preset resolutions.....	25
DVI M1-D/A projector connection.....	26
Trouble shooting.....	27
Alarm indicator on the projector operator panel.....	27
The remote control does not work.....	27
Problems with the projected picture	27
Replacing the projector lamp	29

Introduction

Your new projector XP60 possesses a whole range of useful features and functions, e.g.:

- DLP technology (Digital Light Processing)
- minimal space requirements thanks to small casing
- easy to transport thanks to its low weight
- quiet operation
- high degree of brightness and good contrast
- Automatic Room Light Sensing – ARLS
- high resolution (1024x768); other resolutions (640x480 through 1280x1024) are converted to 1024x768
- presentation of up to 16.7 million colours (in conjunction with an appropriate graphics card)
- automatic scanning of all horizontal frequencies from 15 kHz to 100 kHz and all refresh rates (vertical frequencies) from 43,5 Hz to 130 Hz (all absolutely flicker-free)
- freely adjustable colour alignment for matching the screen colours to the colours of various input and output devices
- convenient operation via integrated OSD (On-Screen-Display) menu
- Ability to control the computer from the projector's remote control (requires USB port on the computer)
- VESA-DDC compatibility
- plug&play capability
- power management for reducing power consumption when the connected computer is not in use

This Operating Manual contains important information you require to start up and run your projector.

A graphics card (screen controller) with VGA or DVI interface is required to control the projector. The projector processes the data supplied to it by the graphics card. The screen controller/the associated driver software is responsible for setting the modes (resolution and refresh rate).

The projector can also be controlled by various video signal sources via the integrated video interfaces.

When you operate the computer with an analogue signal source for the first time, you should adjust the projected image for the video card and set it to your requirements (see section "Changing the OSD settings").

Target group

You don't need to be an "expert" to perform the operations described here. Do, however, read the chapter "Important notes" in the Operating Manual of the computer and in this Operating Manual.

In the event of any problems occurring, please contact your sales outlet or our customer service centre.

Further information

Details of how you set the resolution and refresh rate are provided in the documentation on your screen controller/the associated driver software.

Notational conventions

The meanings of the symbols and fonts used in this manual are as follows:



Pay particular attention to text marked with this symbol. Failure to observe this warning endangers your life, destroys the device, or may lead to loss of data.



Supplementary information, remarks, and tips follow this symbol.

- Text which follows this symbol describes activities that must be performed in the order shown. "Quotation marks" indicate names of chapters or terms.

Important notes



Here you will find essential safety information regarding your projector.

Safety

This device complies with the relevant safety regulations for data processing equipment, including electronic office machines for use in an office environment. If you have any questions, contact your sales outlet or our customer service centre.

- Before you operate the project for the first time, read this Operating Manual carefully.
- Never open the unit. The projector contains no user-replaceable parts. Any repairs should only be performed by a qualified repair shop.
- If the device is brought into the installation site from a cold environment, condensation can form. Before operating the device, wait until it is absolutely dry and has reached approximately the same temperature as the installation site.
- During installation and before operating the device, observe the instructions on environmental conditions in the chapter "Technical data".
- To keep the projector from overheating, never cover it while it is running. Keep all air openings clear. Do not place the projector on heat-sensitive material.
- Do not operate the projector near any heat sources.
- The projector automatically sets itself to the correct voltage within the range from 100 V to 240 V. Ensure that the local mains voltage lies within these limits.
- Ensure that the power socket on the projector or the grounded mains outlet is freely accessible.
- The ON/OFF switch does not disconnect the device from the mains voltage. To completely disconnect the mains voltage, remove the power plug from the socket.
- If you do not use the projector for a longer period of time, shut off the power source completely (for example, by switching off a power bar) or disconnect the power cable from the projector.
- Use only the included power cable or a cable that is approved for your country.
- Lay all cables so that nobody can stand on them or trip over them. When attaching the device, observe the relevant notes in the chapter "Preparing remove control".

- No data transmission cable should be connected or disconnected during a thunderstorm.
- Make sure that no objects (e.g. jewellery chains, paper clips, etc.) or liquids get inside the device (danger of electric shock, short circuit).
- If you notice an unusual smell, see smoke, and in emergencies (e.g. damaged casing, components or cables, penetration of liquids or foreign matter), switch the unit off, disconnect the power plug and contact your sales outlet or our customer service center.
- Only qualified technicians should repair the device. Unauthorised opening and incorrect repair may greatly endanger the user (electric shock, fire risk).
- Do not look into the lens while the projector is running.
- Never look into the remote control's laser pointer beam.
- Never point the laser pointer at living beings, especially not at their eyes.
- To avoid injuries, always place the projector on a solid surface and use only the approved cover mount.
- You may set only those resolutions and refresh rates specified in the "Technical data" chapter.
- Allow the projector to cool down before you pack it up or transport it.
- Keep this operating manual together with your device. If you pass on the device to third parties, you should include this manual.

Cleaning notes

- Always pull out the power plug before you clean the projector.
- Do not clean any interior parts yourself, leave this job to a service technician.
- Do not use any cleaning agents that contain abrasives or may corrode colours.
- Ensure that no liquid will run into the system.
- Regularly clean the projector's air vents to maintain sufficient cooling air flow.
- The surface of the lens is sensitive to pressure and scratches. Clean it only using a soft, slightly moistened cloth.

Wipe the projector casing with a dry cloth. If the monitor is particularly dirty, use a cloth which has been moistened in mild domestic detergent and then carefully wrung out.

Transport notes

- Allow the projector to cool down before you pack it up or transport it.
- Transport the projector with care and only in its original packaging or another corresponding packaging fit to protect it against knocks and jolts.
- Above all, never drop the projector.

Manufacturer's notes

Energy Star



The Fujitsu Siemens projector XP60 is designed to conserve electricity by dropping to less than 12 W when it goes into standby, suspend and OFF mode. With this new power management the XP60 qualifies for the U.S. Environmental Protection Agency's (EPA) Energy Star Computers award.

The EPA estimates that computer equipment uses 5% percent of all business electricity and that this is growing rapidly. If all desktop computers and peripherals enter a low-power mode when not in use, the overall savings in electricity could amount to \$ 2 thousand million annually. These savings could also prevent the emission of 20 million tons of carbon dioxide into the atmosphere - the equivalent of 5 million automobiles.

As an Energy Star Partner, Fujitsu Siemens Computers GmbH has determined that this product meets the Energy Star guidelines for energy efficiency.

CE marking



The shipped version of this device complies with the requirements of the EEC directives 89/336/EEC "Electromagnetic compatibility" and 73/23/EEC "Low voltage directive".



Warning!

This is Class A device. This equipment may cause radio interference in a residential installation. In this case the user is encouraged to perform appropriate measures to correct the interference.

FCC Class A Compliance Statement

The following statement applies to the products covered in this manual, unless otherwise specified herein. The statement for other products will appear in the accompanying documentation.

NOTE:

This equipment has been tested and found to comply with the limits for a "Class A" digital device, pursuant to Part 15 of the FCC rules and meets all requirements of the Canadian Interference-Causing Equipment Regulations. These limits are designed to provide reasonable protection against harmful interference in a residential installation. This equipment generates, uses and can radiate radio frequency energy and, if not installed and used in strict accordance with the instructions, may cause harmful interference to radio communications. However, there is no guarantee that interference will not occur in a particular installation.

If this equipment does cause harmful interference to radio or television reception, which can be determined by turning the equipment off and on, the user is encouraged to try to correct the interference by one or more of the following measures:

- Reorient or relocate the receiving antenna.
- Increase the separation between equipment and the receiver.
- Connect the equipment into an outlet on a circuit different from that to which the receiver is connected.
- Consult the dealer or an experienced radio/TV technician for help.

Fujitsu Siemens Computers GmbH is not responsible for any radio or television interference caused by unauthorised modifications of this equipment or the substitution or attachment of connecting cables and equipment other than those specified by Fujitsu Siemens Computers GmbH. The correction of interference caused by such unauthorised modification, substitution or attachment will be the responsibility of the user.

The use of shielded I/O cables is required when connecting this equipment to any and all optional peripheral or host devices. Failure to do so may violate FCC rules.

Important note on power cable

To guarantee safe operation, use the cable supplied. Use the following guidelines if it is necessary to replace the original cable set.

- The female/male receptacles of the cord set must meet CEE-22 requirements.
- The cable has to be HAR-certified or VDE-certified. The mark HAR or VDE will appear on the outer sheath or on the insulation of one of the inner conductors.
- For devices which are mounted on a desk or table, type SVT or SJT cable sets may be used. For devices which sit on the floor, only SJT type cable sets may be used.
- The cable set must be selected according to the rated current for your device.

Disposal and recycling

This device has been manufactured to the highest possible degree from materials which can be recycled or disposed of in a manner that is not environmentally damaging.

The device may be taken back after use to be recycled, provided that it is returned in a condition that is the result of normal use. Any components not reclaimed will be disposed of in an environmentally acceptable manner.

If you have any questions about disposal of the batteries or system, please contact your local sales outlet or:

Fujitsu Siemens Computers GmbH
Recyclingcenter
D-33106 Paderborn
Tel.: +49 (0) 5251 /81 80 10
Fax: +49 (0) 5251 /81 80 15

Preparing for use



Pay attention to the relevant safety notes provided in chapter "Important notes".

Unpacking and checking the delivery

- ▶ Check whether the delivery agrees with the details in the delivery note.
- ▶ Unpack all the individual parts.
- ▶ Check the delivery for damage incurred during transportation.
- ▶ Make sure that the following components are included.

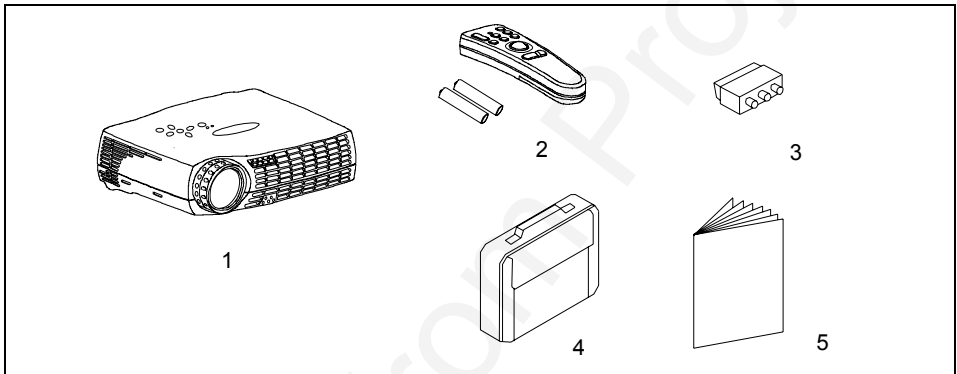

1 = Projector

2 = Remote control with batteries

3 = SCART adapter

4 = Carrying case

5 = Operating Manual

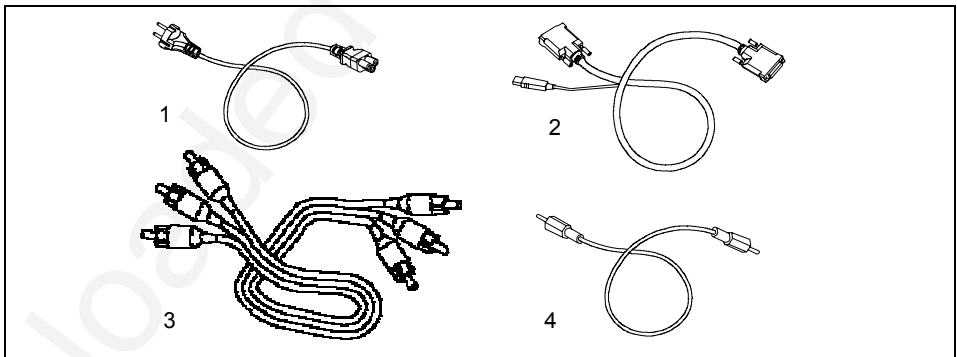

1 = Power cable

2 = Data cable DVI-VGA (M1-A with USB)

3 = Audio/video cable (composite)

4 = Audio cable

Should you discover that the delivery does not correspond to the delivery note, notify your local sales outlet immediately.

i

It is recommended not to throw away the original packaging material. Keep it for future transportation.

Preparing remote control

Inserting batteries

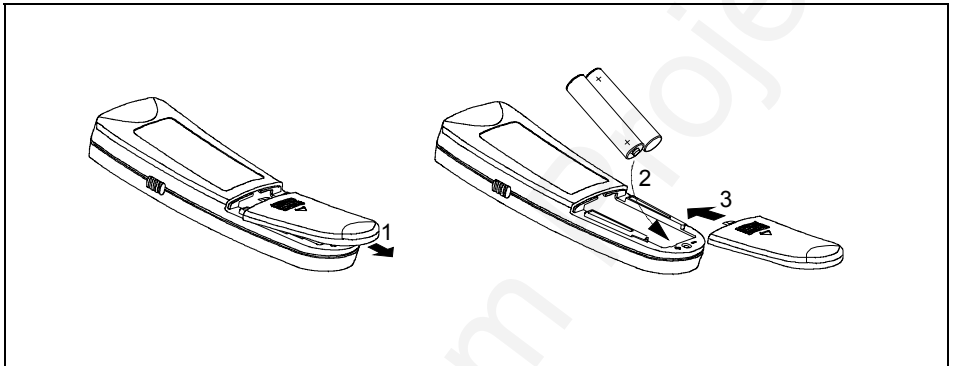

- ▶ Open the back cover of the remote control by sliding it in the direction of the arrow (1).
- ▶ Place the batteries supplied in the battery compartment (2). Ensure correct polarity.
- ▶ Close the battery compartment by sliding the cover back on in the direction of the arrow (3) until you hear and feel it click into place.

Switching the remote control on and off

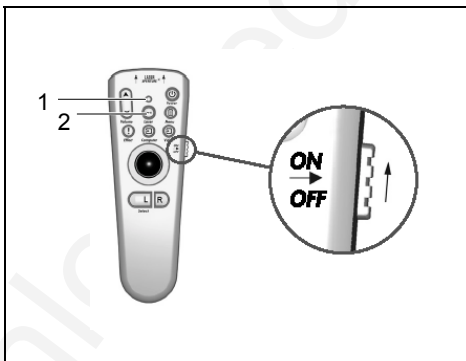

- ▶ Turn the remote control on by moving the sliding switch on its right side toward the front the remote control.

When the indicator (1) lights up shortly, the remote control is operational.

When you press a function button on the remote control or move the mouse ball, the indicator blinks.

- ▶ Press the Laser button (2) to activate the integrated laser pointer.



Never point the laser pointer at living beings, especially not at their eyes.

- ▶ If you will not use the remote control for a longer period of time, turn it off to conserve the batteries. Slide the switch on the right side of the remote control down.

Replacing batteries

- ▶ When the batteries are used up (indicator no longer lights up), replace them with two batteries of the same type (LR03-AAA, 1.5 V).

Do not throw lithium batteries into the household waste. They must be disposed of in accordance with local regulations concerning special waste.

Setting up the projector

We recommend that you place your projector on a surface with good anti-slip qualities. In view of the multitude of different finishes and varnishes used on furniture, it is possible that the rubber feet of the projector as well as the high temperatures at the bottom of the projector will mark the surface the projector stands on.

Connecting the projector to a computer

Information on the computer connections and interfaces is contained in the operating manual for your computer.



Observe the safety precautions in the chapter "Important notes" in this operating manual.

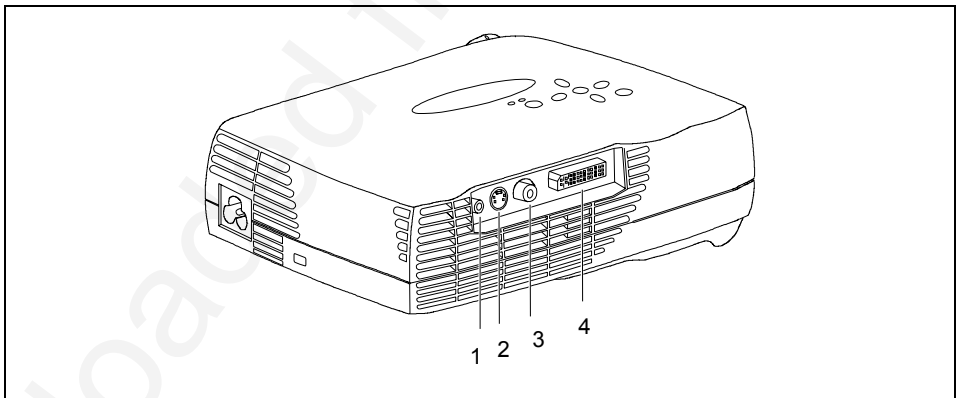

1 = Audio input (Audio in)

2 = S-Video input (S-Video)

3 = Video input (Video)

4 = Computer input (M1-DA)

- ▶ Be sure that the projector and the computer are switched off.



The computer power plug must be pulled out!

Connecting the data cable

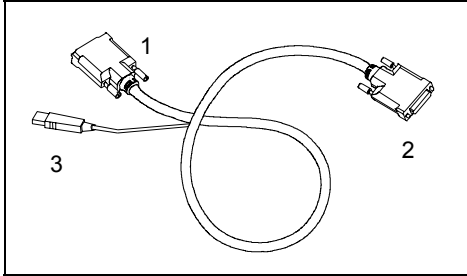

- 1 = Data connector for connection to computer
- 2 = Data connector for connection to projector
- 3 = USB connector

- ▶ Connect the connector (1) of the data cable to the active monitor port on the computer and secure the plug-in connection by tightening the safety screws.



If your computer has two monitor ports ("onboard" screen controller and separate graphics card), the monitor port for the separate graphics card is usually active.

- ▶ Connect the plug (1) of the data cable to the M1-DA connector (4) at the back of the projector.

Connecting the USB cable

The projector has a computer interface with integrated USB functions. If your computer has a USB port and a driver for a USB mouse is loaded, you can control the computer with the projector's remote control as with a mouse. Proceed as follows:

- ▶ Insert the USB connector of the data cable (3) into the USB port on the computer (consult your computer's manual).

Connecting projector to video sources

You can connect a camcorder or similar video device with the included accessory cable to the "Video" and "Audio in" sockets. With the SCART cable, you can connect other video sources, for example a video recorder.

You can connect corresponding video signal sources to the "S-Video" connection. The necessary S-Video cable is not included.

You can connect a stereo output signal from your computer or from your audio/video source to the "Audio in" port with the cables provided in the accessories pack. Playback then takes place via the integrated loudspeaker. The volume can be adjusted with the "Volume" buttons in the control panel of the projector or in the control panel of the remote control.

Check the respective device manuals for additional information.

Connecting the projector to the mains voltage

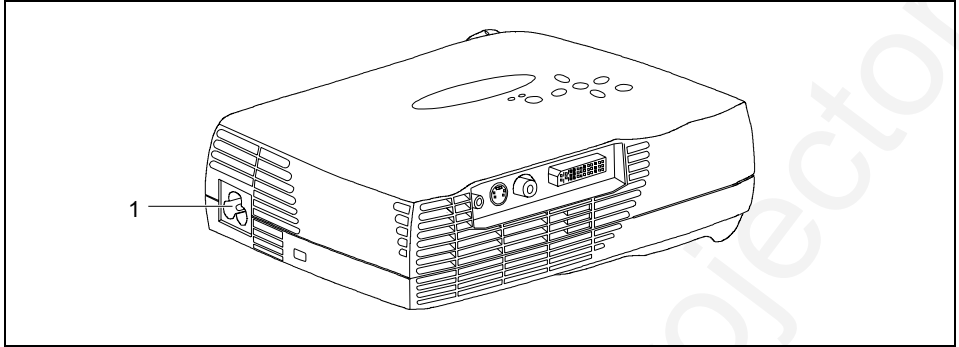

1 = Power connector

- ▶ Firmly insert the socket with the power cable supplied into the power connector (1) on the side of the projector and check whether the socket is securely connected.
- ▶ Connect the plug on the power cable supplied into a properly grounded mains outlet.
- ▶ If necessary, plug the power connector of the connected device into a properly grounded mains outlet.

Operating the projector

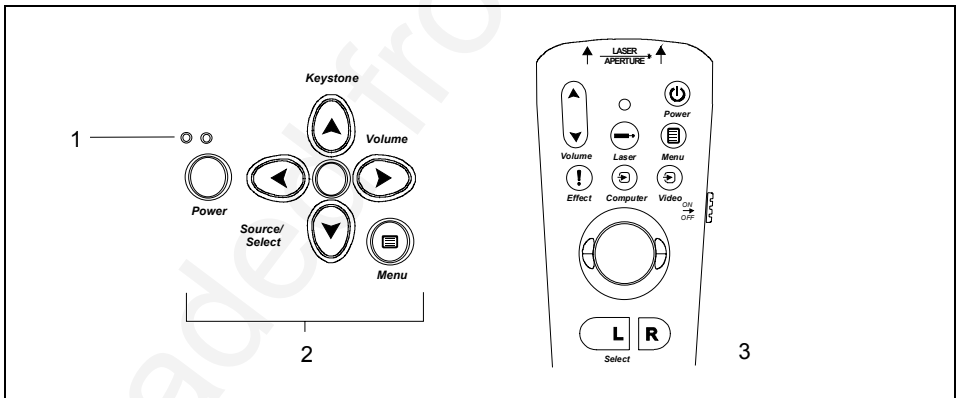

1 = Power indicator

2 = Control panel of the projector

3 = Control panel of the remote control



If the projector has power, the power indicator (1) glows orange.

Switching the projector on and off

Always turn the system units on in the following order.

- Switch the projector on.
- Switch the computer on.
- ▶ Turn the projector on with the power switch on the projector's operating panel (2) or on the remote control (3). To turn the projector on from the remote control, the remote control must be on (see "Switching the remote control on and off").

The power indicator (1) signals to current operating condition as follows:

Stage	Power indicator	Function	Power consumption
ON	lights green	The projector starts up and operates. If there is no signal, the preset logo is displayed.	< 155 W
OFF Cool-down phase	blinks slowly orange	The projector is shut down, the projector lamp is shut off (no image) and is being cooled, the fan runs. The projector cannot be turned on in this stage!	< 20 W
Standby mode	glows orange	The projector is in standby mode.	< 12 W



The projector can be turned on only when it is in standby mode.



Even when the projector is turned off, it is still connected to the power. Remove the plug from the mains outlet so that the system is totally disconnected from the mains voltage. Remove the power plug only when the power indicated glows orange!

Notes on power management



If your computer is equipped with power management, the projector supports this function. The projector is equipped with a two-level power management, which you can activate with the OSD menu (see "Changing the OSD settings").

If your computer during a longer period detects no input (inactivity) or if the projector cannot find a signal source, it switches to power-saving mode. Refer to the following table for further information. For detailed information on how energy-saving mode operates refer to the Operating Manual or Technical Manual of the computer.

When the energy-saving mode is activated, the power indicator signals to current operating condition as follows:

Stage	Power indicator	Function	Power consumption
ON	lights green	The projector starts up and operates.	< 155 W
	flashes slowly green	The present logo is displayed, the projector searches for about three minute for a signal source. If the projector fails to find a signal source, it switches into the energy-saving mode after approximately three minutes.	< 155 W
Energy saving mode (power management)	flashes slowly green	The projector lamp is shut off (no image) and is being cooled, the projector searches for about five minutes for a signal source, the fan runs. As soon as the projector finds a signal source, the projector lamp is switched-on again. If the projector does not find any signal source within five minutes, it is switched into the standby mode.	< 20 W
OFF (standby mode)	glows orange	The projector is in standby mode.	< 12 W



If the energy-saving mode of the projector is not activated (DPMS enable deactivated), the projector is still switched on, even if there is no signal, the present logo is displayed.

When the projector is switched to the energy-saving mode by the power management system a power consumption of up to 12 W is maintained to feed the circuit for reswitching the projector.

To completely switch off the power consumption, pull the plug of the projector power cable out of the mains outlet. Remove the power plug only when the power indicated glows orange!



Even when the projector is turned off, it is still connected to the power. Remove the plug from the mains outlet so that the system is totally disconnected from the mains voltage. Remove the power plug only when the power indicated glows orange!

Changing projector settings

Tilting the projector

With the projector foot (2 and 3) you can adjust the projector tilt within certain limits.

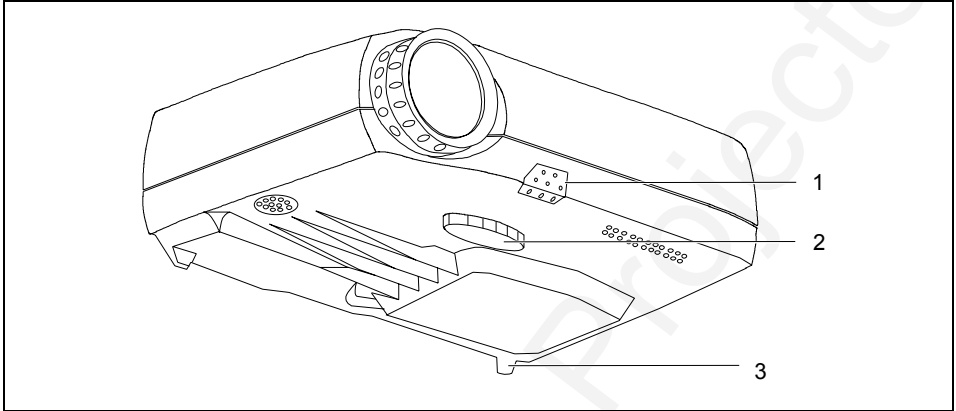

- ▶ Press the release button (1).
- ▶ Move the projector foot (2) into the desired position.
- ▶ Release the unlock button (1).
The projector foot is locked in the current position.
- ▶ Turn the projector foot (3) to change the inclination if necessary.

Adjusting picture definition and picture size

With the lens you can adjust the picture definition and picture size within certain limits.

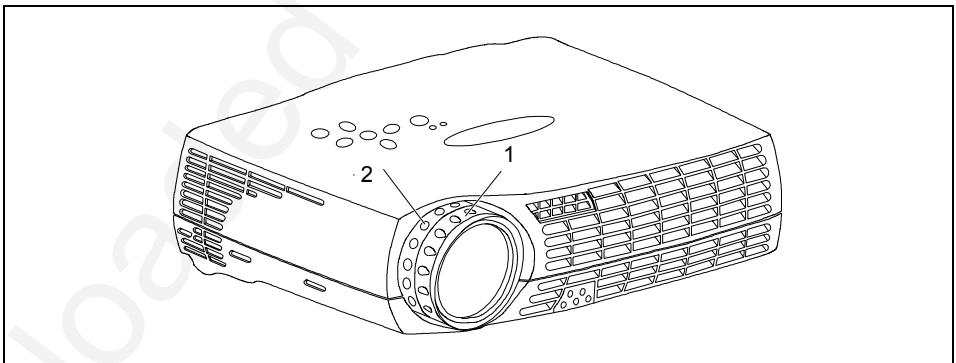

- ▶ Turn the focus ring (1) to adjust the picture sharpness.
- ▶ Turn the zoom ring (2) to adjust the picture size.

Correcting trapezoid distortion

With the ▲ and ▼ buttons you can correct for keystone distortion within certain limits. Keystone distortion occurs if the projector is not positioned at a right angle to the projection screen but projects from a higher or lower position. This function is also accessible via the OSD menu (see "Changing the OSD settings").

- ▶ Press and hold the ▲ or ▼ button until the projected picture no longer looks distorted.

Other settings

During operation you can

- adjust the volume with the "Volume" button on the projector's operator panel or on the remote control
- switch between the signal sources with the "Source/Select" button on the projector's operator panel or with the "Computer" and "Video" buttons on the remote control

Changing the OSD settings

You can use the buttons on the control panels of the projector and the remote control to set the functions via an integrated OSD menu (On-Screen-Display).



The OSD menu is available in eight languages (default setting: English). How to change the language for the OSD menu is described in the section "Language menu". Most of the examples show the English OSD menu.

Operating the OSD menu with the projector's OSD menu

Activating the OSD menu

- ▶ Press the "Menu" button on the projector.

The basic menu is displayed.

Marking a function or submenu

- ▶ Use the arrow buttons to move the cursor to the desired function or submenu.

Selecting a function or submenu

- ▶ Press the "Source/Select" button.

The submenu opens, or you can make the desired settings.

Setting a function

- ▶ Press the ◀ or ▶ buttons until the setting is correct.

If the function can only be activated or deactivated:

- ▶ Select the desired function and activate it by pressing the "Source/Select" button.

Saving setting and terminating OSD menu

- ▶ Press the "Menu" button on the projector.



If you do not make a selection for about 40 seconds, the OSD menu closes, and the set value is stored.

Returning to the previous menu

- ▶ Press the ◀ button.

Returning to the higher-level menu

- ▶ If you want to return to the higher-level menu, select the ↶ symbol and confirm your selection with the "Select" button.

Operating the OSD menu with the remote control

Activating the OSD menu

- ▶ Press the "Menu" button on the remote control.

The basic menu is displayed.

Marking a function or submenu

- ▶ Use the ball on the remote control to move the selection (up/down) to the desired function or submenu.

Selecting a function or submenu

- ▶ Press the "Select" key.

The submenu opens, or you can make the desired settings.

Setting a function

- ▶ Move the ball left or right until the setting is correct.

If the function can only be activated or deactivated:

- ▶ Select the desired function and activate it by pressing the "Select" button.

Saving setting and terminating OSD menu

- ▶ Press the "Menu" button on the projector.



If you do not make a selection for about 40 seconds, the OSD menu closes, and the set value is stored.

Returning to the previous menu

- ▶ Roll the ball to the left.

Returning to the higher-level menu











- ▶ If you want to return to the higher-level menu, select the ↶ symbol and confirm your selection with the "Select" button.

Basic menu

When you press the "Menu" button on the projector or the remote control, the basic menu appears.

	<p>With the basic menu, you can set contrast, brightness, colour and keystone or switch to the setup menu.</p>
--	--





Possible adjustments in Basic menu

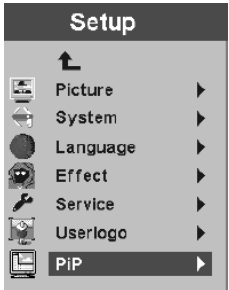



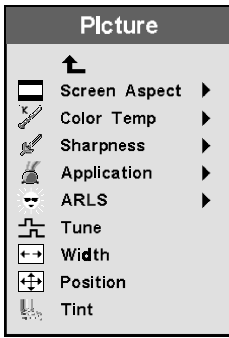

		<p>Contrast You can adjust the contrast in the range from 0 to 100.</p>
		<p>Brightness You can adjust the brightness in the range from 0 to 100.</p>
		<p>Color You can adjust the colour intensity of video images in the range from 0 to 100.</p>
		<p>Keystone You can adjust the keystone correction in the range from -63 to +64.</p>
		<p>Setup The possible adjustments are described in the following.</p>
		<p>Reset The projector adjustments are synchronised for the active source.</p>
		<p>About Information on the active source is displayed.</p>

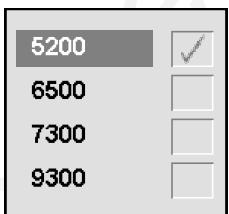
Setup menu





		<p>From the setup menu you can select various submenus (Picture, System, Language, Effect, Service, User Logo, Picture in Picture).</p>
--	---	---

Picture menu

		<p>From the Picture menu you can set the picture's screen aspect, colour temperature, sharpness, application type, ARLS (Automatic Room Light Sensing), tuning, width, position, and colour tint.</p>
		<p>Screen Aspect You can select between 16:9 (wide-screen format), 4:3 (computer, conventional TV) and Native (original format)</p>
		<p>Colour temperature (Color Temperature) You can select between four colour temperatures. As the colour temperature increases, the picture changes from yellowish to bluish.</p>

	<p>Sharpest <input checked="" type="checkbox"/></p> <p>Sharper <input type="checkbox"/></p> <p>Standard <input type="checkbox"/></p> <p>Softer <input type="checkbox"/></p> <p>Softest <input type="checkbox"/></p>	<p>Sharpness</p> <p>You can adjust the subjective sharpness from "Very Sharp" to "Very Soft".</p>
	<p>Normal <input checked="" type="checkbox"/></p> <p>Home theat. <input type="checkbox"/></p> <p>Photograph. <input type="checkbox"/></p>	<p>Application</p> <p>You can adjust the display to the current application type:</p> <ul style="list-style-type: none"> • Normal operation (computer) • Home theatre (video) • Photographs (with Gamma correction)
	<p>Auto <input checked="" type="checkbox"/></p> <p>Dark <input type="checkbox"/></p> <p>Bright <input type="checkbox"/></p>	<p>ARLS (Automatic Room Light Sensing)</p> <p>Automatically adapts the projector's brightness to the ambient light level. You can select between automatic adjustment, darker display, and brighter display.</p>
	<p>50 <input type="range"/></p>	<p>Tune</p> <p>You can set the phase length in the range from 0 to 100 and thus fine-tune analogue computer output if the automatic adjustment ("Reset" or basic settings in the basic menu) is unsatisfactory.</p>
		<p>Width</p> <p>You can set the horizontal frequency to optimise the picture width for analogue computer output if the automatic adjustment ("Reset" or basic settings in the basic menu) is unsatisfactory.</p>
		<p>Position</p> <p>You can adjust the picture position for analogue computer output if the automatic adjustment ("Reset" or basic settings in the basic menu) is unsatisfactory.</p>
	<p>50 <input type="range"/></p>	<p>Tint</p> <p>If you want to display video images in the NTSC format (American TV), you can adjust the tint in the range from 0 to 100. This setting has no effect on PAL or SECAM video images.</p>









System menu

	<div style="background-color: #cccccc; padding: 5px;"> <p style="text-align: center;">System</p> <p style="text-align: center;">↑</p> <p><input type="checkbox"/> Rear</p> <p><input type="checkbox"/> SourceSearch</p> <p><input type="checkbox"/> Hide OSD</p> <p><input type="checkbox"/> DPMS enable</p> </div>	<p>In the System menu you can adjust general operating settings.</p>
	<p>Rear</p> <p>If you project the image from the back against a translucent surface, this setting flips the image horizontally.</p>	
	<p>SourceSearch</p> <p>With this function, the projector automatically looks for a signal source (computer or video).</p>	
	<p>Hide OSD</p> <p>If you activate this function, the menu functions are no longer displayed over the projected image (for example, when you adjust the volume or change the signal source). This function is useful if you have to adjust the volume during a presentation.</p>	
	<p>DPMS enable</p> <p>This function activates the DPMS (Display Power Management Signaling). When the projector receives a corresponding signal from the computer, it switches to power-saving mode (< 9 W).</p>	









Language menu

	<div style="background-color: #cccccc; padding: 5px;"> <p style="text-align: center;">Language</p> <p style="text-align: center;">↑</p> <p><input type="checkbox"/> Deutsch</p> <p><input type="checkbox"/> English</p> <p><input type="checkbox"/> Español</p> <p><input type="checkbox"/> Français</p> <p><input type="checkbox"/> Italiano</p> <p><input type="checkbox"/> Norsk</p> <p><input type="checkbox"/> Portuguese</p> <p><input type="checkbox"/> 日本語</p> <p><input type="checkbox"/> 繁體中文</p> <p><input type="checkbox"/> 簡體中文</p> </div>	<p>On the Language menu you can select the language for the OSD menu.</p>
--	--	---





Effect menu

		<p>In the Effect menu, you can assign one of the displayed functions to the "Effect" button on the remote control. You can select only one of these functions at a time.</p>
	<p>Magnify</p> <p>The picture is magnified until you press the "Effect" button again.</p> <p>► Set the magnification factor by rolling the mouse ball forward.</p>	
	<p>Freeze</p> <p>Freezes and displays the current picture until you press "Effect" again.</p>	
	<p>Mask</p> <p>The projected image is blacked out until you press the "Effect" button again.</p>	
	<p>Mute</p> <p>Mutes the sound until you press the "Effect" button again (works only with a video signal source).</p>	
	<p>16:9</p> <p>The picture is shown in the 16:9 format.</p>	
	<p>PIP</p> <p>Select "Picture in Picture" if you want to see a smaller picture of the video source over the computer picture.</p>	

Service menu





	<div style="border: 1px solid black; padding: 5px;"> <p style="text-align: center;">Service</p> <p style="text-align: center;">↑</p> <ul style="list-style-type: none">  Factory reset  Info  Reset lamptimer  Service code </div>	<p>With the Service menu you can look up certain information about the projector and can reset it to the factory settings.</p>
	<p>Factory reset</p> <p>All settings are reset to the factory settings.</p>	
	<p>Info</p> <p>Displays service information like the software version, operating hours, settings, etc.</p>	
	<p>Reset lamptimer</p> <p>▶ After replacing the lamp, set the lamp timer back to 0. Follow the instructions on the OSD menu.</p>	
	<p>Service code</p> <p>This function contains additional information that is only available to service personnel.</p>	

Userlogo menu

	<div style="border: 1px solid black; padding: 5px;"> <p style="text-align: center;">User's logo</p> <p style="text-align: center;">↑</p> <ul style="list-style-type: none"> <input type="checkbox"/> Default <input type="checkbox"/> Blue <input type="checkbox"/> Black <input type="checkbox"/> Captured <input type="checkbox"/> Capture new </div>	<p>In the user logo menu, you can select what the projector should display if it cannot find a signal source.</p>
	<p>Default</p> <p>If the projector does not find a signal source it displays the Fujitsu Siemens Computers logo.</p>	
	<p>Blue</p> <p>If the projector does not find a signal source it displays a blue screen.</p>	
	<p>Black</p> <p>If the projector does not find a signal source it displays a black screen.</p>	
	<p>Captured</p> <p>If the projector does not find a signal source it displays the logo captured by the user.</p>	

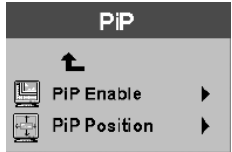
	<p>Capture new</p>
<p>You can capture your own logo. Proceed as follows:</p> <ul style="list-style-type: none"> ▶ Display the desired logo with the projector. ▶ Select the "Capture new" function. ▶ Select the range you want to display as the logo by moving the displayed frame with the mouse ball over the logo. ▶ If necessary, adjust the frame to the logo size with the "Volume" buttons and confirm the selection with the "Select" button. ▶ Select the picture quality (High = 18bit, Low = 4bit) and confirm with the "Select" button. <p>The projector confirms that the capture was successful or reports an error.</p> <ul style="list-style-type: none"> ▶ Restart the projector. 	

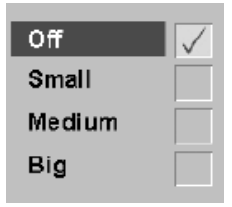
PiP menu (Picture in Picture)

		<p>In the PiP menu you can select the position and size of the displayed picture.</p>
		<p>PiP Enable</p> <p>Select "PiP Enable" to activate the Picture in Picture mode and select the size of the Picture in Picture (PiP).</p>
	<p>PiP Position</p> <p>You can move the video picture on your screen with this function.</p>	

Notes on ergonomic colour adjustment

If you select colours for the projector in your application programmes, take note of the information below.

The basic colour red and blue on a dark background do not achieve the minimum contrast of 3:1 and should not be used.

When using several colours for characters and background and giving the primary colours full modulation, you can obtain very suitable colour combinations (see the following table):

Background	Characters							
	black	white	purple	blue	cyan	green	yellow	red
black		+	+	-	+	+	+	-
white	+		+	+	-	-	-	+
purple	+	+		-	-	-	-	-
blue	-	+	-		+	-	+	-
cyan	+	-	-	+		-	-	-
green	+	-	-	+	-		-	-
yellow	+	-	+	+	-	-		+
red	-	+	-	-	-	-	+	

- + Colour combination very suitable
- Colour combination not suitable because colour locations are too close together, thin characters are not identifiable or rigorous focusing is demanded of the human eye.

Technical data

Dimensions and weight (projector only)

Width	154 mm
Height	63 mm
Depth	195 mm
Weight	1.1 kg

Power connector

Rated mains voltage	100 V -240 V ($\pm 10\%$)
Frequency	50 Hz -60 Hz ($\pm 5\%$)
Total power consumption	< 155 W
Energy-saving mode	< 12 W

Indicator

Technology	DLP (Digital Light Processing)
Resolution	1024 x 768
Brightness	Type 1100 ANSI lumen
Contrast	800:1
Colour	16.7 mio
Projector lamp	120 W UHP, life: 2000 h

Optical properties

Lens	1.85 - 2.35:1
Picture size	80 cm to 530 cm diagonal
Distance to projection screen	1.5 m -10.0 m
Keystone correction	12° electronic

Compatibility**Projector**

Computer	digital or analogue, PC, MAC, 1280 x 1024 max.
Horizontal frequency	15 kHz ... 100 kHz
Refresh rate	43.5 Hz ... 130 Hz
Maximum pixel rate	158 MHz analogue, 112 MHz digital

Video compatibility

Video	S-Video, Composite Video, PAL (all), SECAM (all), NTSC 3.58/4.43, HDTV, SDTV, EDTV
Audio	Stereo line in

Inputs/outputs**Projector**

Computer	M1-D/A for analogue and digital signals including USB
Video	RCA
S-Video	4 pin mini DIN
Loudspeakers	1 W Mono
Computer Audio	3.5 mm mini jack

Environmental conditions

Rated range of operation:	15 °C 35 °C
Humidity:	20 % 80 %
Limit range of operation:	5 °C 35 °C
Humidity:	20 % 80 %

Condensation must be avoided.

VESA-DDC-compatible DVI interface

The projector is equipped with a VESA-DDC-compatible DVI interface. VESA-DDC (Video Electronics Standard Association, Display Data Channel) is used as the communications interface between the projector and the computer. If your computer is equipped with a VESA-DDC-compatible DVI or VGA interface, it can automatically read the data for ensuring optimum operation from your projector and select the appropriate settings.

Preset resolutions

The projector can be used with the listed resolutions.

Screen resolution	Refresh rate
640 x 480	43.50 to 130 Hz
720 x 400	43.50 to 130 Hz
800 x 600	43.50 to 125 Hz
832 x 624	43.50 to 120 Hz
1024 x 768	43.50 to 95 Hz
1152 x 864	43.50 to 85 Hz
1152 x 870	43.50 to 85 Hz
1280 x 1024	43.50 to 75 Hz

DVI M1-D/A projector connection

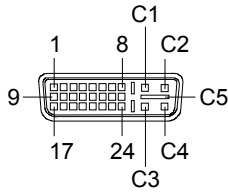

Pin	Meaning
1	TMDS Data 2-
2	TMDS Data 2+
3	TMDS Data 2/4 Shield
4	not used
5	not used
6	DDC Clock
7	DDC Data
8	Analogue Vertical Sync
9	TMDS Data 1-
10	TMDS Data 1+
11	TMDS Data 1/3 Shield
12	not used

C1	Analogue Red
C2	Analogue Green
C3	Analogue Blue

Pin	Meaning
13	not used
14	+5 V Power
15	Ground
16	Hot Plug Detect
17	TMDS Data 0-
18	TMDS Data 0+
19	TMDS Data 0/5 Shield
20	not used
21	not used
22	TMDS Clock Shield
23	TMDS Clock-
24	TMDS Clock+

C4	Analogue Horizontal Sync
C5	Analogue Ground

Trouble shooting

Should an error occur, first check the following points. If the distortion is still not eliminated, the projector should, if possible, be checked on another computer and/or with another data cable.

If you cannot solve the problem, contact our customer service centre.

Alarm indicator on the projector operator panel

Alarm indicator lights up red

- ▶ Replace the projector lamp.

Alarm indicator blinks red rapidly

The projector has overheated.

- ▶ Turn the projector off and let it cool down.

Alarm indicator blinks red in intervals

The projector is being shut down due to overheating.

The remote control does not work.

- ▶ Check if the remote control is turned on (see "Switching the remote control on and off").

Remote control is turned on but does not work

Batteries may be empty.

- ▶ Change the batteries (see "Replacing batteries").

Problems with the projected picture

No display (power indicator does not light)

- ▶ Check whether the power cable is connected correctly on the projector and to the mains outlet.
- ▶ Check whether the mains socket is live.

No picture (power indicator glows orange)

- ▶ Check whether the projector is switched on.

No picture (power indicator glows green)

- ▶ Check whether the computer is switched on.
- ▶ Check whether the data cable for the projector is correctly attached to the monitor port on the computer.
- ▶ Press any key on the computer keyboard – the computer may be in energy saving mode.
- ▶ Alter the brightness and/or contrast until you get a picture.

Picture disturbances

- ▶ From the Basic menu (see "Changing the OSD settings") select the "Reset" function in order to reset the projector to its basic settings.

If the picture does still not improve:

- ▶ From the Setup menu (see "Changing the OSD settings") select the Picture menu and the "Tune" function.
- ▶ Adjust the projected image.
- ▶ From the Setup menu (see "Changing the OSD settings") select the Picture menu and the "Width" function.
- ▶ Adjust the projected picture width.

Unstable pixels or pixels that are constantly light or dark

The standard of production techniques today cannot guarantee an absolutely fault-free projection. There may be a few unstable or constantly light or dark pixels.

The following number of faulty pixels is permissible and no reason for a warranty claim:

- Unstable pixels: 1
- Light pixels: 1
- Dark pixels: 5

The projected picture is getting darker

The life of the projector lamp is limited, and its brightness decreases as it gets older. If the projected picture gets too dark, have the lamp replaced (after 2,000 operating hours at the latest).

Replacing the projector lamp

The projector lamp must be replaced once its useful life has expired.



Please only use lamps of the same type and strength!

Switch off the projector and disconnect it from the mains supply. Wait for around 60 minutes before opening the lamp housing.

The lamp housing is intended to protect you from glass fragments in case the projector lamp explodes. Please therefore take special care when you open the lamp housing.



- ▶ Remove the three screws.



- ▶ Open the lamp housing with a screw driver.



- ▶ Carefully remove the lamp housing and dispose of it in an environmentally friendly way.
- ▶ Insert the new lamp housing.
- ▶ Fasten the three screws again.
- ▶ After replacing the lamp, set the lamp timer back to 0. Follow the instructions on the OSD menu.