

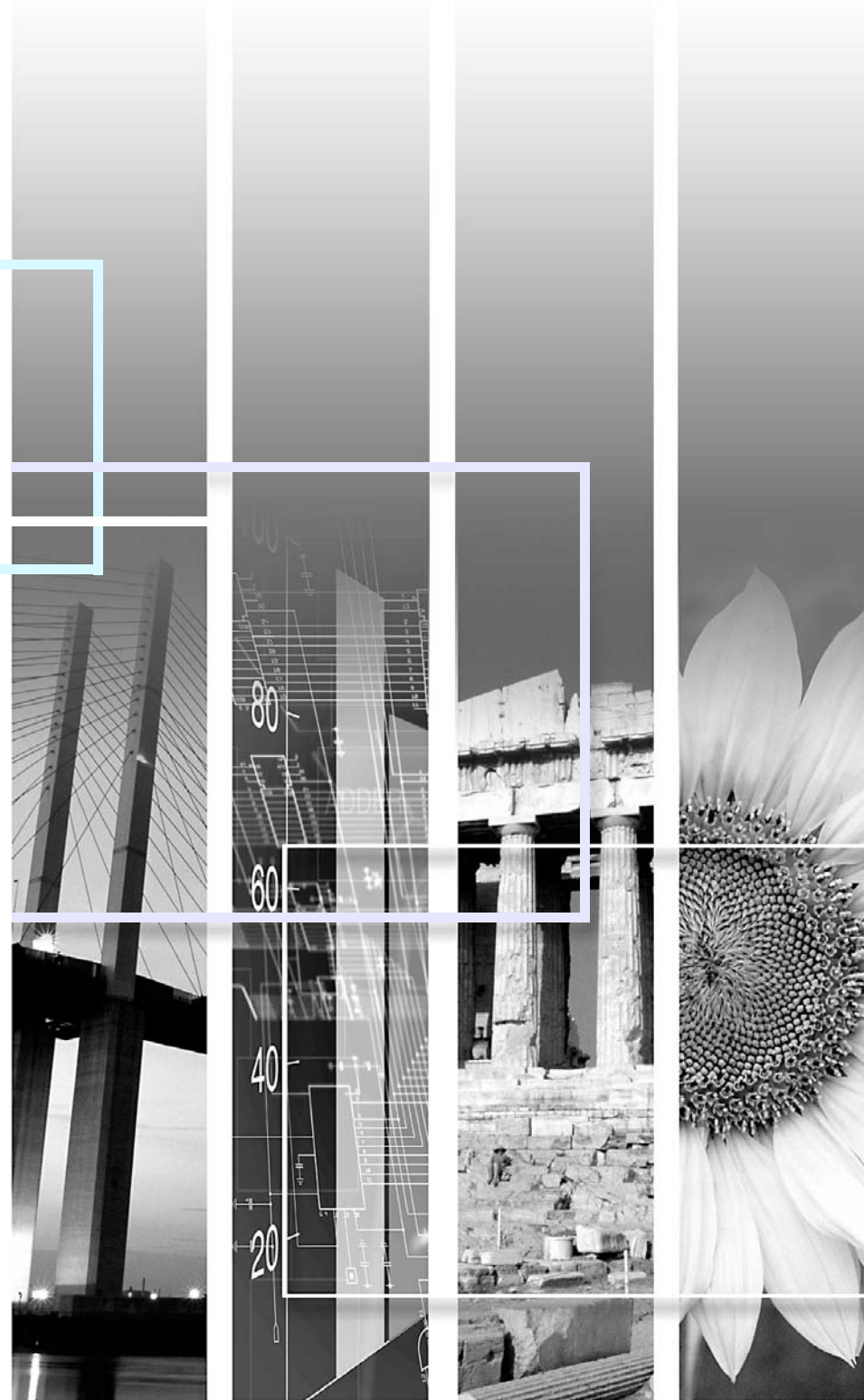

Epson PowerLite® S4

User's Guide



Meaning of Symbols

	Indicates the possibility that people may be injured or the equipment may be damaged if the instructions are not followed.
	Indicates tips or additional helpful information.

Copyright Notice

All rights reserved. No part of this publication may be reproduced, stored in a retrieval system, or transmitted in any form or by any means, electronic, mechanical, photocopying, recording, or otherwise, without the prior written permission of Seiko Epson Corporation. The information contained herein is designed only for use with this Epson product. Epson is not responsible for any use of this information as applied to other products.

Neither Seiko Epson Corporation nor its affiliates shall be liable to the purchaser of this product or third parties for damages, losses, costs, or expenses incurred by purchaser or third parties as a result of: accident, misuse, or abuse of this product or unauthorized modifications, repairs, or alterations to this product, or (excluding the U.S.) failure to strictly comply with Seiko Epson Corporation's operating and maintenance instructions.

Seiko Epson Corporation shall not be liable for any damages or problems arising from the use of any options or any consumable products other than those designated as Original Epson Products or Epson Approved Products by Seiko Epson Corporation.

Trademarks

Epson is a registered trademark of Seiko Epson Corporation.

Epson Connection, Epson Store, and Extra Care are service marks; and PrivateLine, Presenters Club, and PowerLite are registered trademarks of Epson America, Inc.

Pixelworks, DNX, and the DNX logo are trademarks of Pixelworks, Inc.

General Notice: Other product names used herein are for identification purposes only and may be trademarks of their respective owners. Epson disclaims any and all rights in those marks.

Contents

Meaning of Symbols	2
Copyright Notice	2
Trademarks	2

Projector Features

Setting Up the Projector	6
Part Names and Functions	7
Front/Top	7
Control Panel	8
Rear	9
Base	10
Remote Control	11

Adjusting and Changing the Image

Adjusting the Image Quality	12
Adjusting Computer Images and RGB Video Images	12
Selecting the Projection Quality (Color Mode)	14
Adjusting the Projection Position (Image Shift)	16
Adjusting the Volume	17
Selecting the Image Source	17
Automatically Detecting the Source (Source Search)	17
Selecting the Source from the Remote Control	18

Additional Projector Functions

Functions for Enhancing Projection	19
Muting the Image and Sound (A/V Mute)	19
Freezing the Image	20
Changing the Aspect Ratio	20
Displaying the Pointer	21
Enlarging Part of the Image (E-Zoom)	21
Using the Remote Control as a Mouse	22
Security Functions	24
Preventing theft (Password Protect)	24
Using the Operation Lock	26
Saving a User's Logo	28
Displaying Projected Images on an External Monitor	30

Configuration Menus

Using the Menu System	31
"Image" Menu	32
"Signal" Menu	33
"Settings" Menu	34
"Extended" Menu	35
"Info" Menu	37
"Reset" Menu	38

Maintenance

Cleaning	39
Cleaning the Projector	39
Cleaning the Lens	39
Cleaning the Air Filters and Air Intake Vent	39
Replacing Consumables	40
Replacing the Batteries	40
Lamp Replacement Period	40
Replacing the Lamp	41
Resetting the Lamp Operating Time	43
Replacing the Air Filter	44

Troubleshooting

Using the Help Menu	45
Problem Solving	47
Reading the Indicators	47
When the Indicators Provide No Help	50
Where To Get Help	57
Internet Support	57
Speak to a Support Representative	57
Purchase Supplies and Accessories	57

Appendix

Optional Accessories and Consumables	58
Screen Size and Projection Distance	59
Glossary	60
List of ESC/VP21 Commands	62
List of Supported Monitor Displays	63
Specifications	64
Dimensions	66
Declaration of Conformity	67
FCC Compliance Statement	67
Important Safety Instructions	68

Projector Features

Direct Power On and Instant Off

Use the Direct Power On function to turn the projector on simply by plugging the power cable into an electrical outlet. See [page 36](#).

When you're done using the projector, just turn it off, unplug it, and place it in the carrying case. The projector's Instant Off design means you don't have to let it cool down first.

Ease of Use

► Lens cover

Temporarily stop projection by closing the lens cover.

► Single foot design

Make height adjustments quickly with one hand.

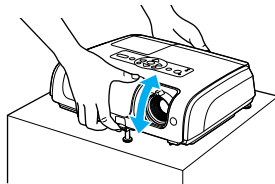
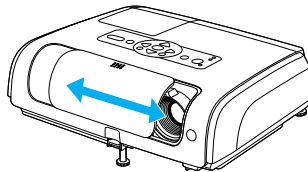

► Easy to use, big button control panel

► Automatic source search

Press the Source Search button to automatically detect and display the connected picture signal.

► On-screen Help

Quickly answer questions about common projection problems. See [page 45](#).

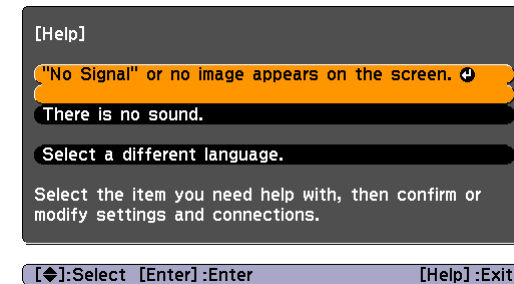

Color Modes

Project movies, photos, presentations, and games in the optimum color tone by choosing the most suitable mode for your surroundings. See [page 14](#).

Security Function

► Set up a password to restrict use of the projector. See [page 24](#).

► Disable all control panel buttons except for the Power button to prevent your settings being changed when the projector is used in a public place. See [page 26](#).

Setting Up the Projector

The projector supports the following four projection methods, allowing you to choose the best method for displaying your images.



- **For ceiling mount installation (suspending from the ceiling), a special installation procedure is required. Failure to install correctly may result in injury or damage if the projector falls.**
- **Do not turn the projector on its side during projection, or malfunctions may occur.**
- **To prolong the life of the projector, turn it off when not in use.**

▮ Front projection (Front projection)

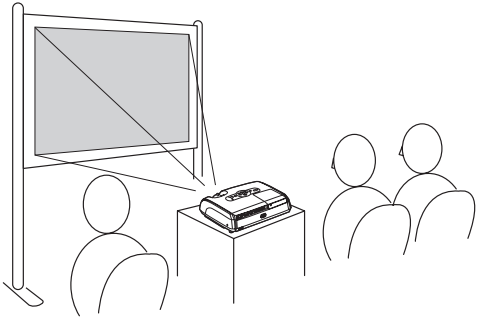

▮ Rear projection using a translucent screen (Rear projection)

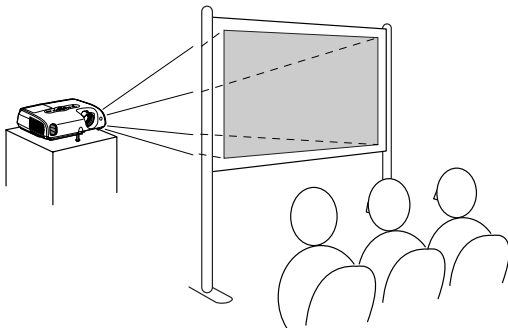

▮ Front/ceiling projection (Front/Ceiling projection)

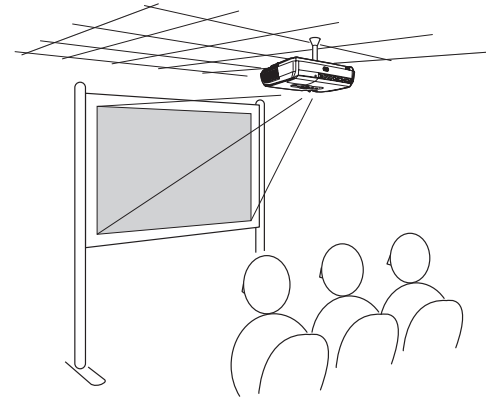

▮ Rear/ceiling projection using a translucent screen (Rear/Ceiling projection)

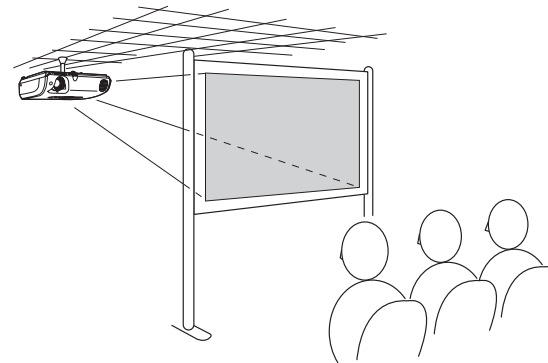

- **The optional ceiling mount is required when installing the projector on a ceiling. See [page 58](#).**
- **When using ceiling projection or projection using a translucent screen, set the "Projection" command in the "Extended" menu to match the installation method. See [page 35](#).**

Part Names and Functions

Front/Top

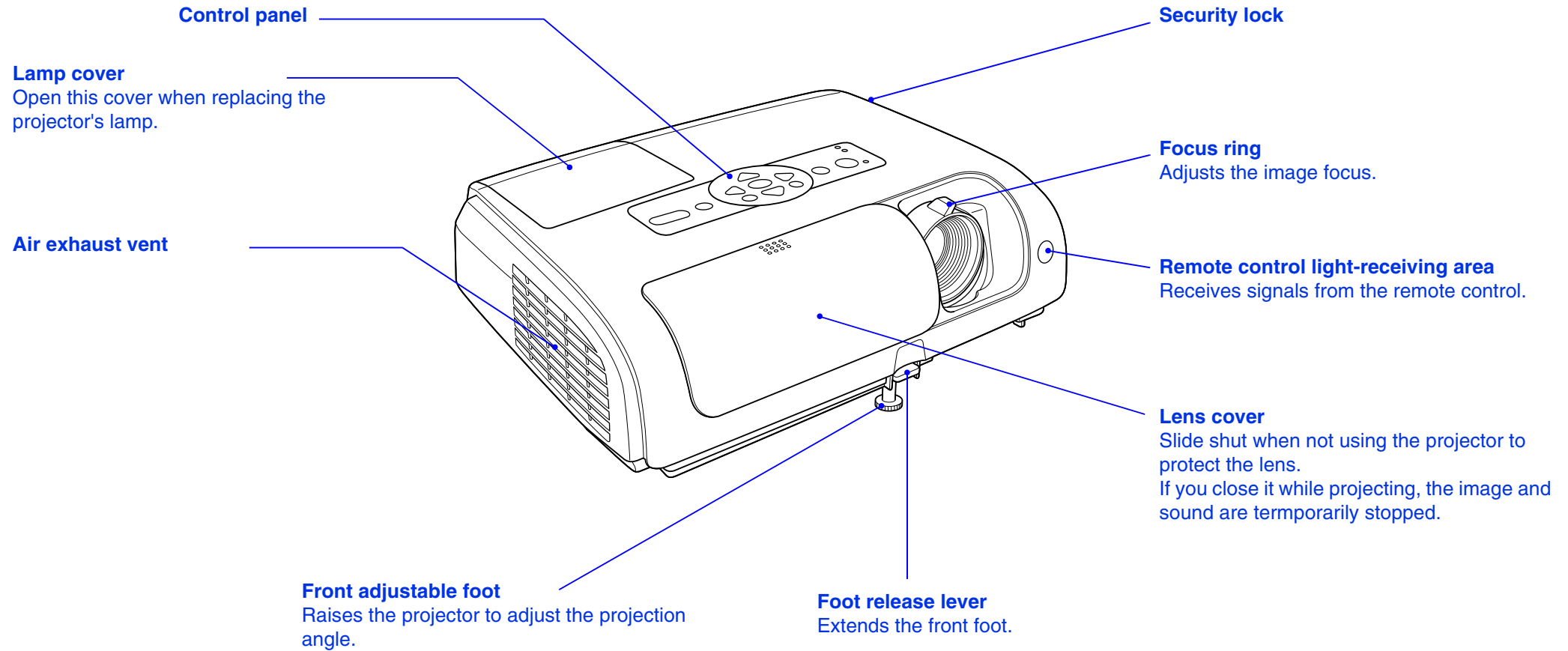

Control Panel

[Menu] button

Displays and closes the configuration menu.

[Power] button

Turns the projector power on or off.

LED indicators

The color of the indicators and whether they are flashing or lit shows the state of this projector.



[Source Search] button

The input source is automatically searched for in the following order, and the input image from the connected equipment is projected.

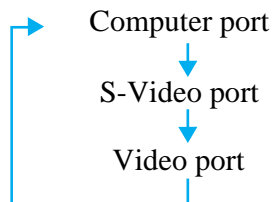

[Enter] button

Automatically adjusts analog RGB images from computers and RGB video images to the optimum images. If a configuration menu or help screen is displayed, it accepts and enters the current selection.

[Esc] button

Stops the current function. Displays the previous screen or menu while viewing a configuration menu.

[Help] button

Displays and closes the help, which shows solutions if a problem occurs.

[▲] [▼] button

Press to correct keystone distortion. If a configuration menu or help screen is displayed, it selects menu items and setting values.

[Wide] [Tele] button

Adjusts the image size. If a configuration menu or help screen is displayed, it selects menu items and setting values.

Rear

Computer port

Inputs analog RGB video signals from a computer and RGB video signals and component video signals from other video sources.

S-Video port

Inputs S-video signals to the projector from other video sources.

Video port

Inputs component video signals to the projector from other video sources.

USB port

Connects the projector to a computer via the USB cable when using the wireless mouse function.
Computer images cannot be projected by using the USB cable to connect the computer.

Monitor Out port

Outputs the projected computer's analog RGB signals or RGB video signals to an external monitor from the source that is connected to the Computer port. This feature is not available for video equipment signals.

Power inlet

Connects to the power cable.

Rear adjustable foot

Lets you level the image.

Audio input

Input audio signals from connected external equipment.
When you are connecting two or more pieces of external equipment that use the same input port, you need to disconnect one before connecting the other, or use an audio selector.

Remote control light-receiving area

Receives signals from the remote control.

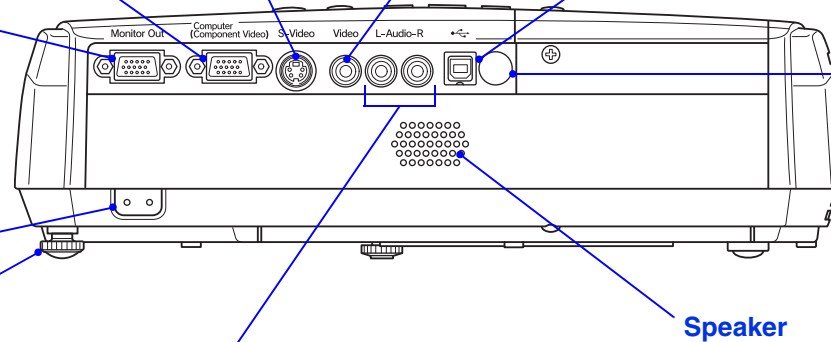

Base

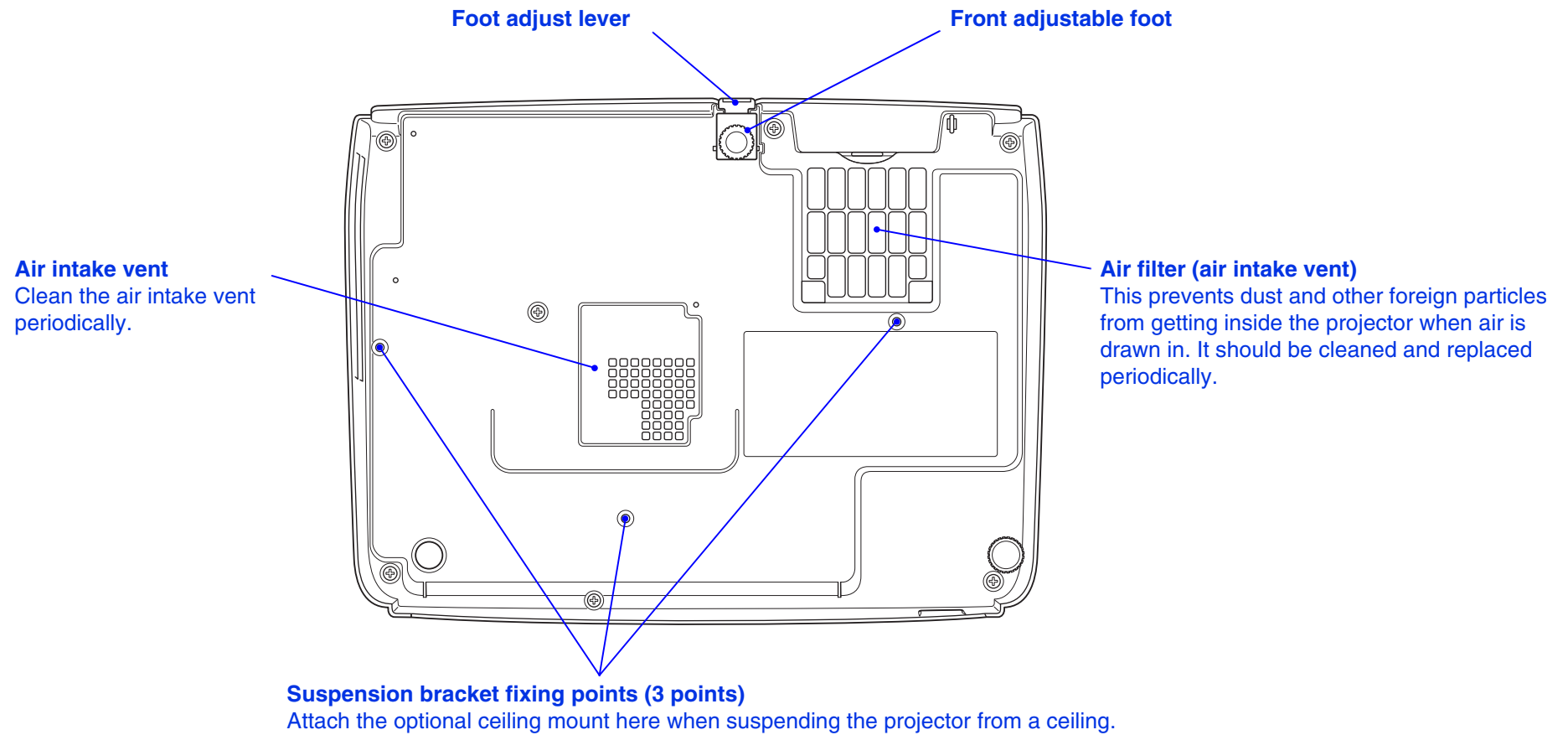

Remote Control

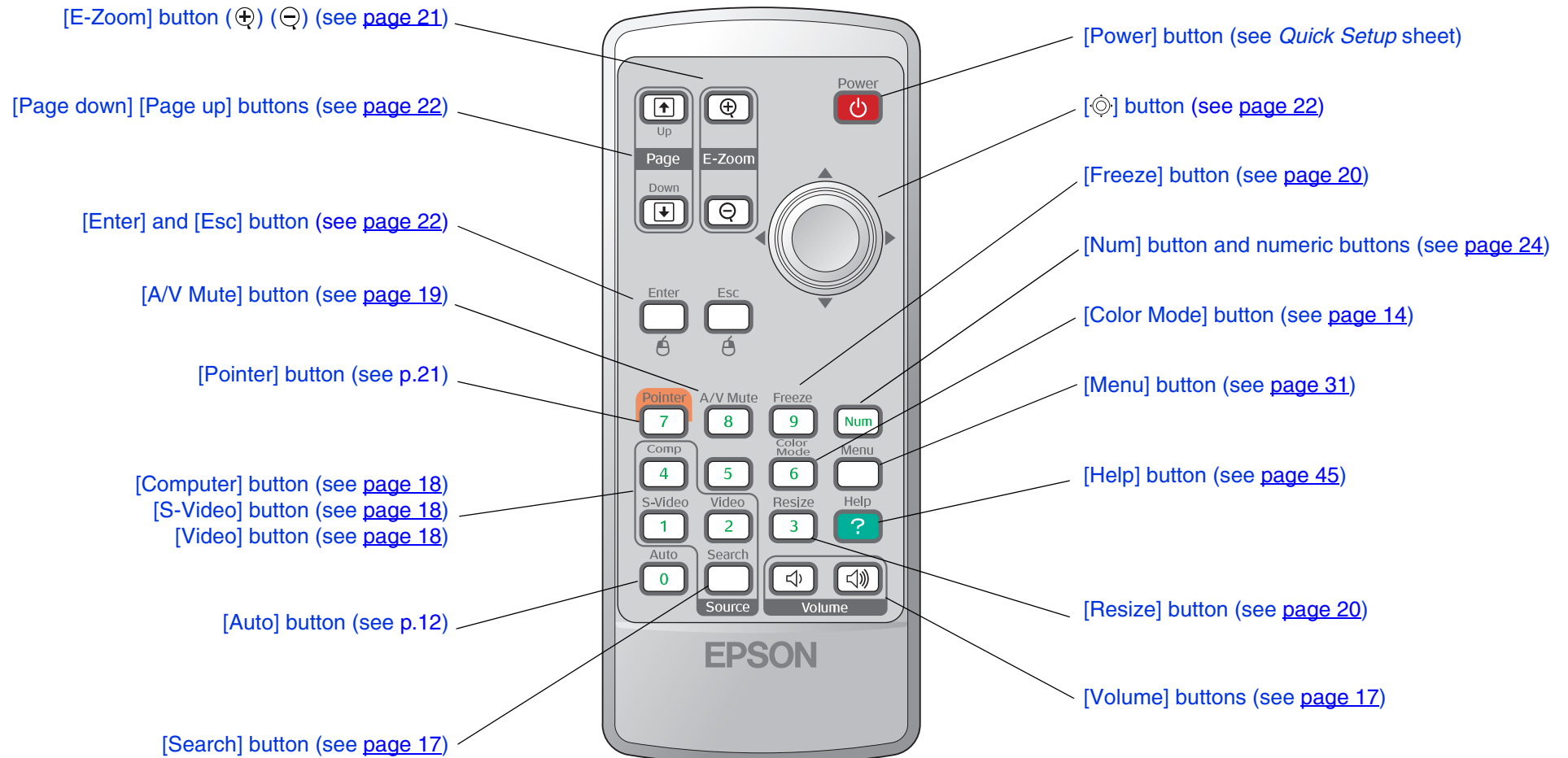

Adjusting and Changing the Image

Adjusting the Image Quality

Adjusting Computer Images and RGB Video Images

Automatic Setup

Automatic setup detects analog RGB signals coming from a connected computer, and automatically adjusts these signals so that the optimum images can be obtained.

Automatic setup involves adjustment of Tracking, Position, and Sync (synchronization).

If "Auto Setup" in the "Signal" menu is set to "Off", automatic setup is not carried out. In this case, press the [Auto] button on the remote control or the [Enter] button on the projector's control panel to make the adjustment while computer or RGB video images are being projected.

Using the remote control

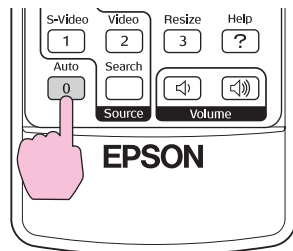

Using the control panel

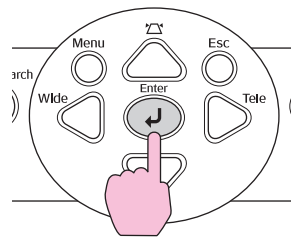

- If you try to make the adjustment while other functions such as E-zoom or Freeze are in use, these functions are canceled and then the adjustment is made.
- Sometimes the signals may not be adjusted correctly depending on the type of computer or RGB video signals being input. In such cases, use the configuration menu commands to adjust the tracking and sync settings manually. See [page 33](#).

Adjusting the Tracking

If vertical stripes appear in the projected computer or RGB video images, and this cannot be fixed using automatic setup, you will need to adjust the Tracking manually using the following procedure.

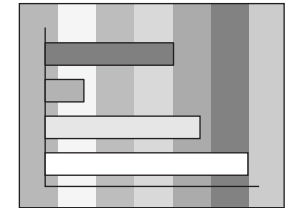

- 1 Select "Signal" from the configuration menu, and then select "Tracking".

Check the buttons you can use and the operations they perform in the guide at the bottom of the screen.

Using the remote control

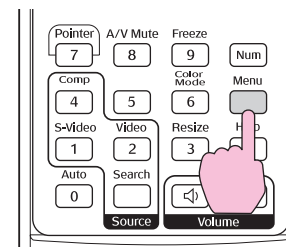

Using the control panel

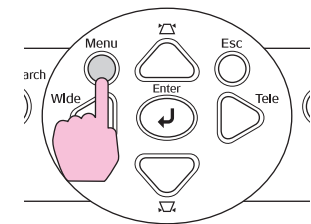

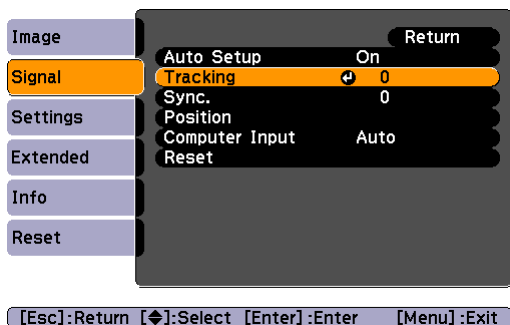

- Adjust the tracking until the vertical stripes disappear from the image.

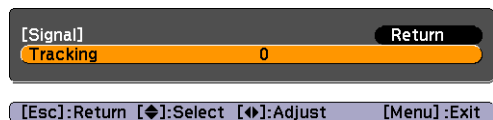

Using the remote control

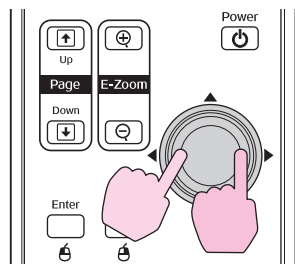

Using the control panel

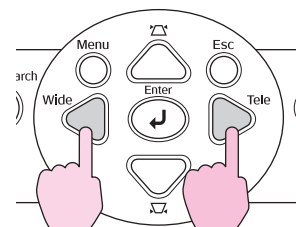

The tracking value increases or decreases each time a button is pressed.

- Press the [Menu] button to exit the configuration menu.



The image will flash when continuous tracking adjustment is carried out, but this is normal.

Adjusting the Sync

If flickering, fuzziness or interference appear in computer or RGB video images, and this cannot be fixed using automatic setup, you will need to adjust the Sync (synchronization) manually using the following procedure.

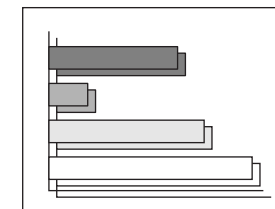

- Select "Signal" from the configuration menu, and then select "Sync."

Check the buttons you can use and the operations they perform in the guide at the bottom of the screen.

Using the remote control

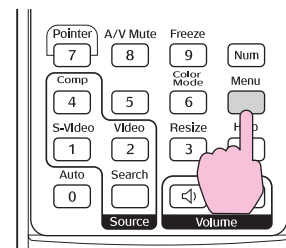

Using the control panel

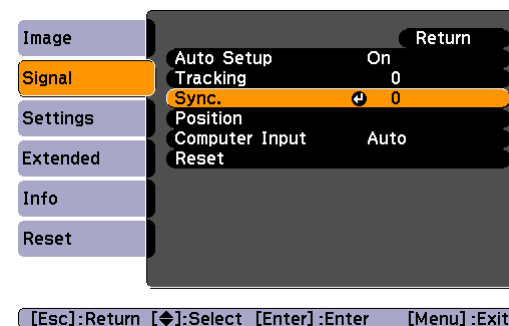
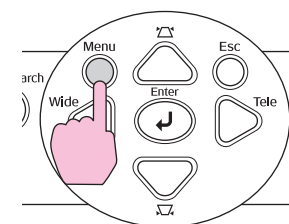

- Adjust the synchronization until the horizontal noise disappears from the image.

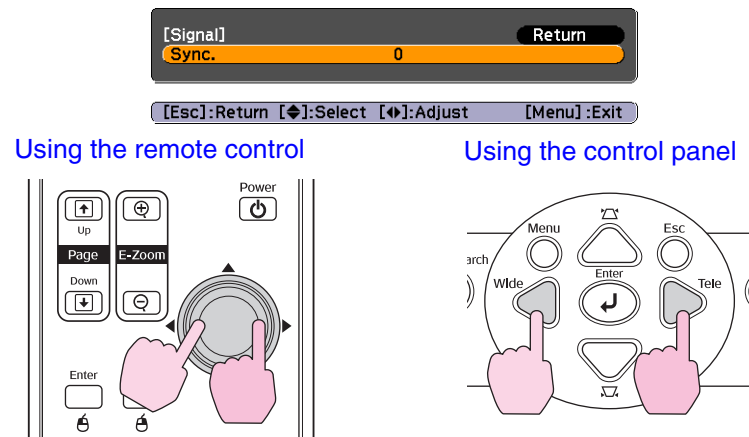

The sync value increases or decreases each time a button is pressed.

3 Press the [Menu] button to exit the configuration menu.



- If you adjust the sync without adjusting the tracking first, it will not be possible to get the best adjustment results. Incorrect tracking adjustment may not be noticeable with some types of images. However, images with lots of lines and shading will tend to show incorrect tracking adjustments more clearly, so check the tracking adjustment first.
- Flickering and fuzziness may also occur when the brightness, contrast, sharpness, zoom, and keystone correction settings are adjusted.

Selecting the Projection Quality (Color Mode)

The following seven preset color modes are available for use depending on the characteristics of the images that are being projected. You can easily obtain the optimum image quality simply by selecting the color mode that corresponds to the projected images. The brightness of the images will vary depending on which color mode is selected.

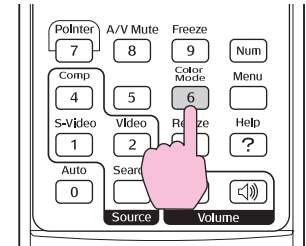

Mode	Application
Photo	(When computer and RGB video images are being input) The images are vivid and contrast is increased. Ideal for projecting still pictures, such as photos, in a bright room.
Sports	(When component video, S-video, or composite video images are being input) The images are vivid and brought to life. Ideal for watching TV programs and so on in a bright room.
Presentation	Ideal for giving presentations in a bright room
Theatre	Gives images a natural tone. Ideal for watching films in a dark room.
Game	Excels at emphasizing dark gradations. Ideal for playing video games in a bright room.
sRGB	Ideal for images that conform to the sRGB color standard
Blackboard	Even if you are projecting onto a blackboard (green board), this setting gives your images a natural tint, just like when projecting onto a screen

Each time you press the button, the color modes change in the following order.



The current setting appears in the top-right corner of the screen each time the color mode is changed. While the color mode name is displayed on the screen, it does not change to the next color mode setting unless you press the button.

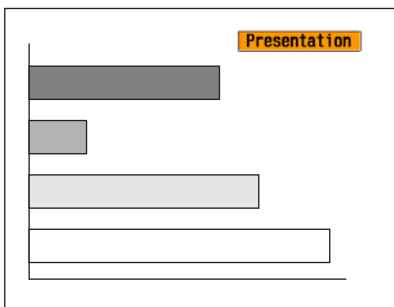

The color mode can also be set using the "Color Mode" command in the "Image" menu. See [page 32](#).

Adjusting the Projection Position (Image Shift)

When you cannot setup this projector directly in front of the screen, the projection position can be finely tuned without moving this projector.

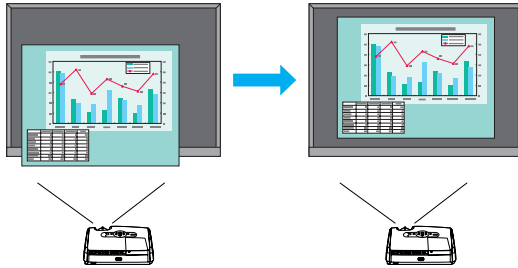

- 1 Using the button on the projector, perform zoom adjustment or keystone correction. See the **Quick Setup** sheet.

The Image Shift adjustment screen is displayed after you finish making adjustments.

- 2 Adjust projection position.

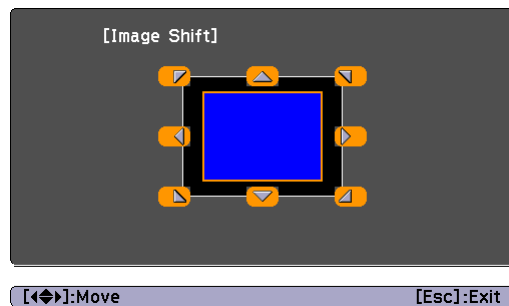

Using the Remote Control

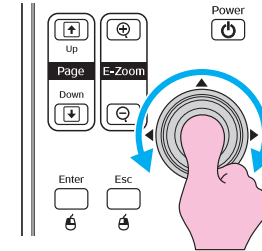

Using the Control Panel

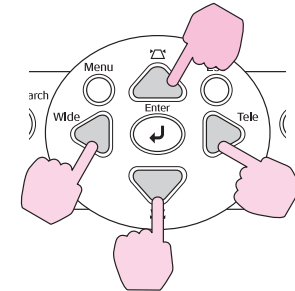

- 3 Press the [Esc] button to close the adjustment screen.

The screen closes automatically if no operations are performed for about 10 seconds.



- The projection position cannot be adjusted when zoom is set to maximum "wide".
- Even if you turn the power supply off, the "Image Shift" settings you make are kept. When either the projector position or the angle of the projector is changed, you can readjust or perform the following operations.

Control Panel

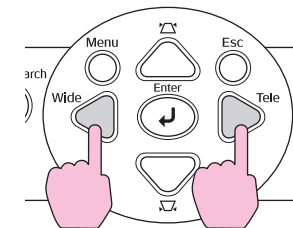

Press and hold down the [Wide] and [Tele] buttons for more than one second.

- You can also make adjustments from the configuration menu. See [page 33](#).

Adjusting the Volume

The volume of the projector's built-in speaker can be adjusted as follows.

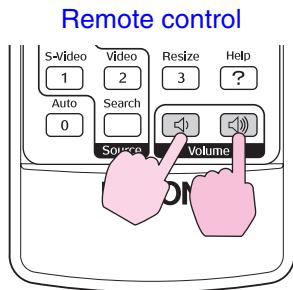

When the button is pressed to the [🔊] side, the volume increases, and when it is pressed to the [🔊] side, the volume decreases.

The volume gauge appears on the screen when the volume is being adjusted.



- If the value displayed in the gauge on the screen stops changing when the volume is being adjusted, it indicates that the limit for volume adjustment has been reached.
- The volume can also be adjusted using the configuration menu. See [page 34](#).

Selecting the Image Source

The image source is the projector port to which your video equipment is connected. You can select the image source automatically, using Source Search as described below. Or you can select a source yourself as described on [page 18](#).

Automatically Detecting the Source (Source Search)

Source Search automatically detects the picture signal from connected equipment and projects the image.

- 1 Turn on your computer or video equipment. If you are viewing a tape or DVD, start playback.
- 2 Press the Source Search button.

Using the Remote Control

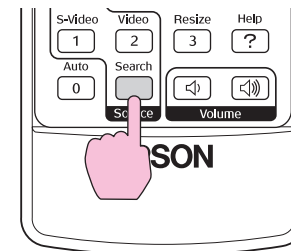

Using the Control Panel

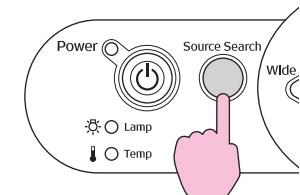

3 The projector searches for an active source and displays the image.

Unused sources are skipped, as shown below. When two or more pieces of equipment are connected, press the [Source Search] button repeatedly to select the desired source.

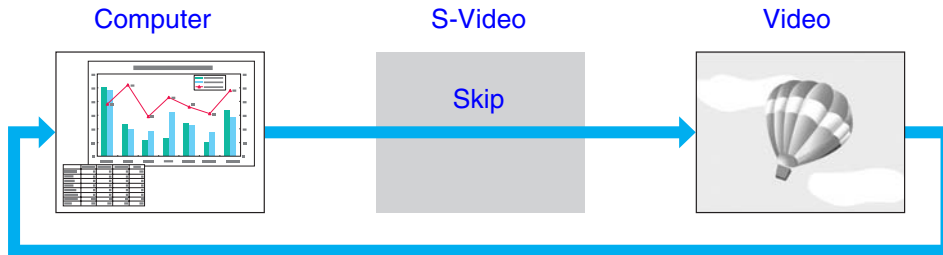

Selecting the Source from the Remote Control

You can use the remote control to select a specific image source.

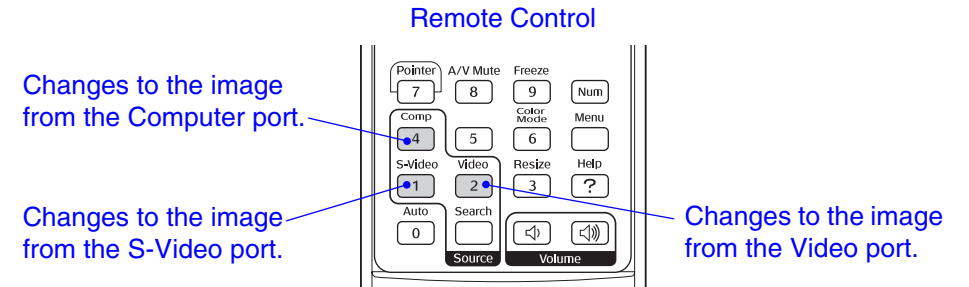

You see this screen if no picture signal is available. You can use the screen to choose the input source.

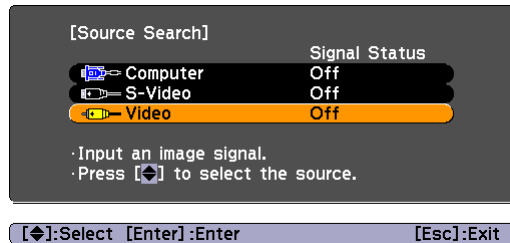

Additional Projector Functions

This chapter explains functions used when giving presentations and for using the projector's security functions.

Functions for Enhancing Projection

Muting the Image and Sound (A/V Mute)

For example, this can be used if you want to pause the projection for a moment and focus the audience's attention on what you are saying. Or if you are making a computer presentation and you do not want to show details, such as selecting different files.

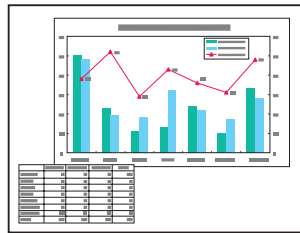

Using the projector

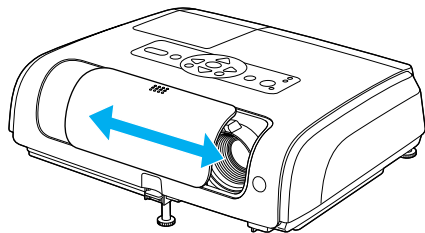

Closing the lens cover stops projection and sound.

Using the remote control

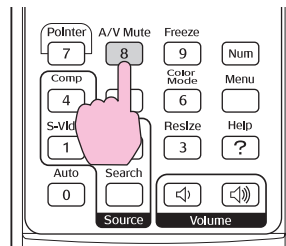

Pressing the [A/V Mute] button stops projection and sound.

You can temporarily turn off the image and sound in two ways:

- When you close the lens cover, projection and sound are turned off. Open the lens cover to restore projection and sound.
- When you press the A/V Mute button on the remote control, projection and sound are turned off. If you saved a user's logo (see [page 28](#)), you can set it to display when you press the A/V Mute button (see [page 35](#)). Press the A/V Mute button again to restore projection and sound.



- *If you're watching a moving picture, the video source continues to play while the screen is dark. You should pause the video if you wish to resume playback where you stopped it.*
- *The screen display in A/V mute can be chosen from black, blue, or a logo by using "Extended" - "Display" - "A/V Mute" in the configuration menu.*

Freezing the Image

The source image continues to project even when the screen is frozen. You can still perform operations such as changing files, without projecting any images.

Remote control

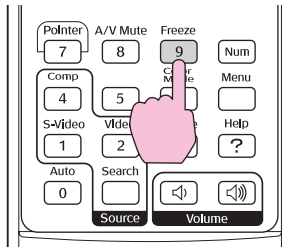

You can turn this function on or off by pressing the [Freeze] button.

Changing the Aspect Ratio

This function changes the aspect ratio of images from 4:3 to 16:9 when component video, S-video, or composite video images are being projected. Images which have been recorded in digital video or onto DVDs can be viewed in 16:9 wide-screen format.

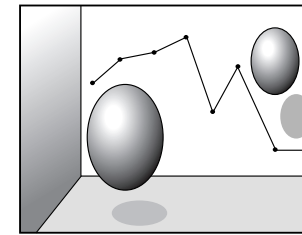

When images in Squeeze Mode are projected at 4:3

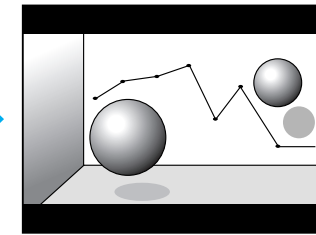

When images in Squeeze Mode are projected at 16:9

Remote control

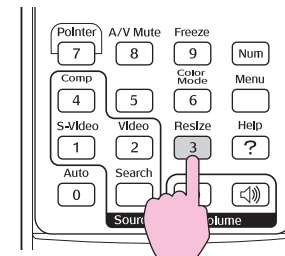

The display is changed whenever you press the button.



- Sound does not stop.
- Even though the image on the screen is frozen, the image source continues to project, and so it is not possible to resume projection from the point where it was paused.
- Pressing the [Freeze] button also clears configuration menu displays and help messages.
- The freeze function still works while the E-Zoom function is being used.



You can also make this setting using the "Resize" command in the "Signal" menu.

Displaying the Pointer

This allows you to move a pointer icon on the projected image, and helps you draw attention to the area you are talking about.

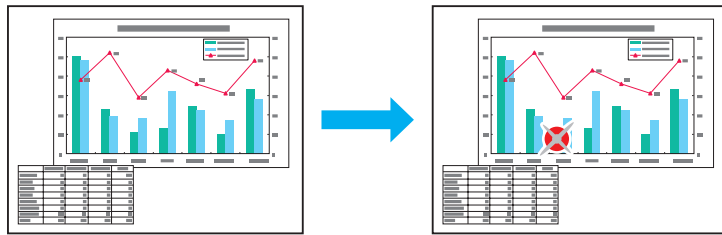

1 Display the pointer.

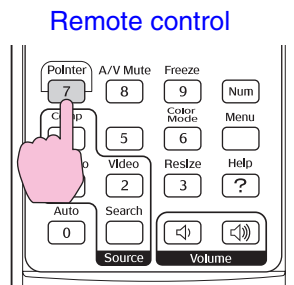

Each time you press the button the pointer appears or disappears.

2 Move the pointer icon.

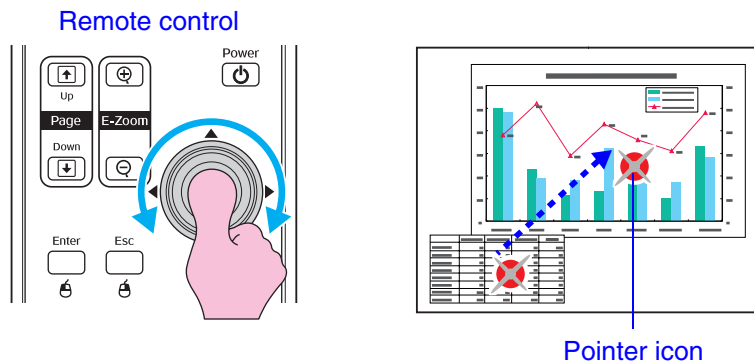

You can use the "Pointer Shape" command in the "Settings" menu to change the shape of the pointer to one of three different shapes. See [page 34](#).

Enlarging Part of the Image (E-Zoom)

This is useful when you want to see images in greater detail, such as graphs and details in a table.

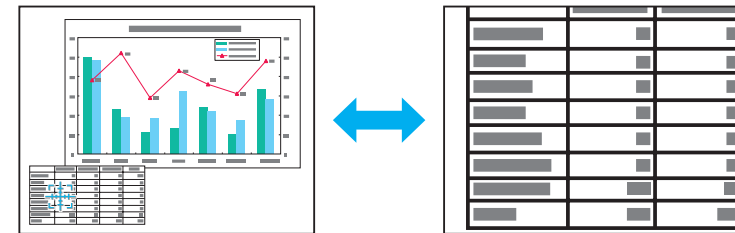

1 Start E-Zoom.

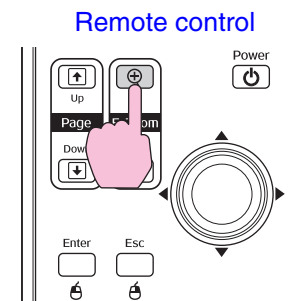

2 Move the cross to the area of the image that is to be enlarged or reduced.

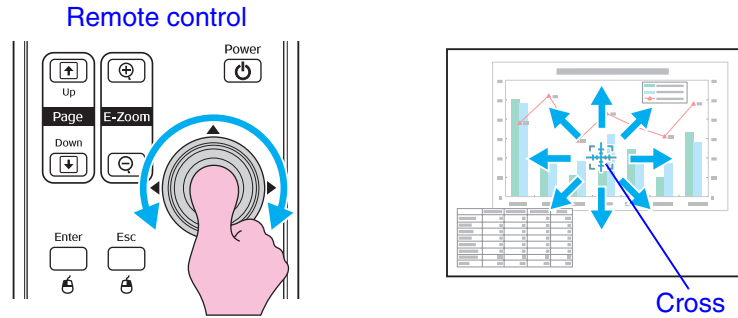

3 Enlarge.

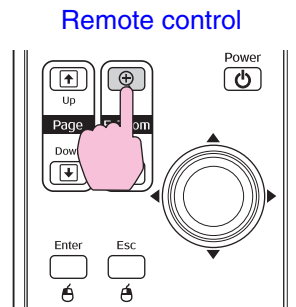

You can reduce the enlarged image by pressing the [-] button.
To cancel the E-Zoom, press the [Esc] button.

Using the Remote Control as a Mouse

If the USB terminal of a computer and the USB terminal on the back of this projector are connected by a commercially available USB A-B cable, you can use the projector's remote control like a wireless mouse to control the computer's mouse pointer.

Computer
Windows 98/2000/Me/XP Home Edition/XP Professional
Macintosh (OS 8.6–9.2/10.0–10.4)

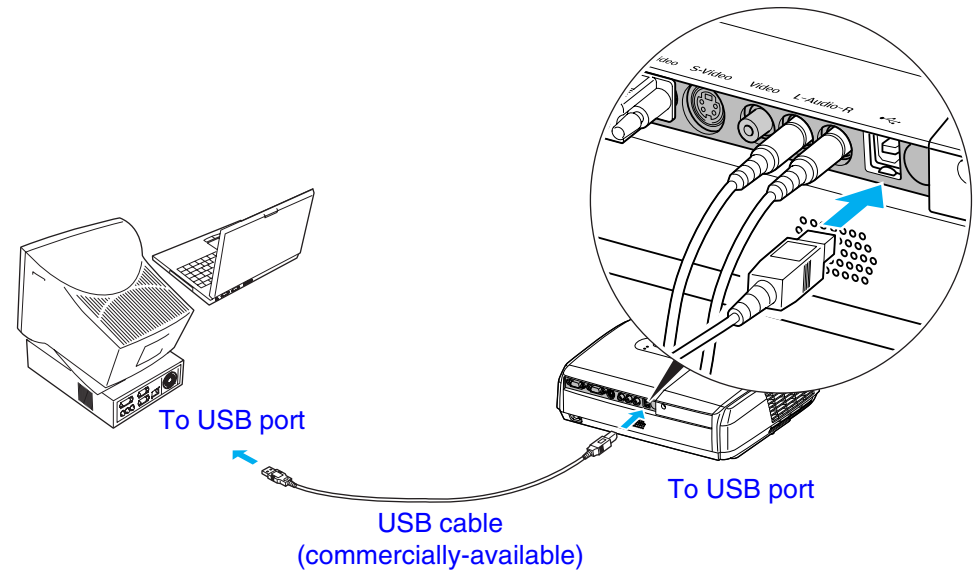

- The enlargement ratio will appear on the screen.
- You can scroll the screen by tilting the [⦿] button.
- The selected area can be enlarged up to 4 times, in 25 incremental steps.



- The USB cable can only be connected to computers with a standard USB interface. If using a computer which is running Windows, the computer must have had a full version of Windows 98/2000/Me/XP Home Edition/XP Professional installed. If the computer is running a version of Windows 98/2000/Me/XP Home Edition/XP Professional that has been upgraded from an earlier version of Windows, correct operation cannot be guaranteed.
- It may not be possible to use the mouse function under some versions of both the Windows and Macintosh operating systems.
- Some computer settings may have to be changed in order for the mouse function to be used. Consult the documentation for the computer for further details.

Once the connection has been made, the mouse pointer can be operated as follows.

Moving the mouse pointer

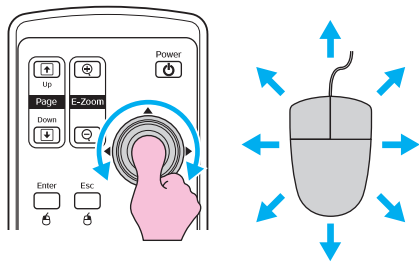

Mouse clicks

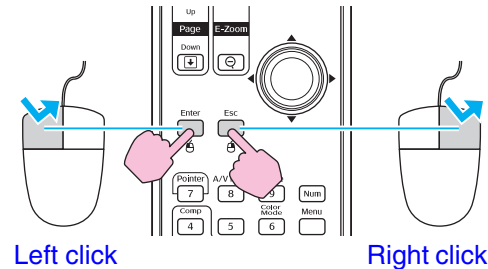

Left click

Right click

Double-click: Press twice in rapid succession.

Drag and drop

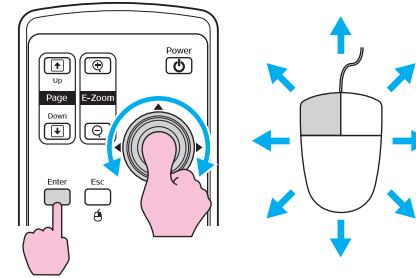

1. Hold down the [Enter] button and tilt and drag the [E-Zoom] button.
2. Release the [Enter] button to drop at the desired location.

This is useful for displaying the previous or next slide in a PowerPoint slideshow.

To previous slide

To next slide



- If the mouse button settings are set to reverse on the computer, the operation of the remote control buttons will also be reversed.
- The wireless mouse function cannot be used while the following functions are being used.
 - While a configuration menu is being displayed
 - While a help menu is being displayed
 - While the E-Zoom function is being used
 - While a user's logo is being captured
 - Pointer function
 - While adjusting sound volume
 - While Image Shift is being used

Security Functions

Preventing theft (Password Protect)

When the Password Protect function is activated, people who do not know the password will not be able to use the projector to project images, if the power has been disconnected since the password was last entered correctly. Furthermore, the user's logo that is displayed on the background of the screen cannot be changed. This is effective against theft. At the time of purchase, the password protection function is not enabled.

When Password Protect is Enabled

■ When "Power On Protect" is enabled (On)

When the power is turned on for the first time after the projector's power cable is connected to an electrical outlet, or when Direct Power On is carried out, the following password entry screen will be displayed.

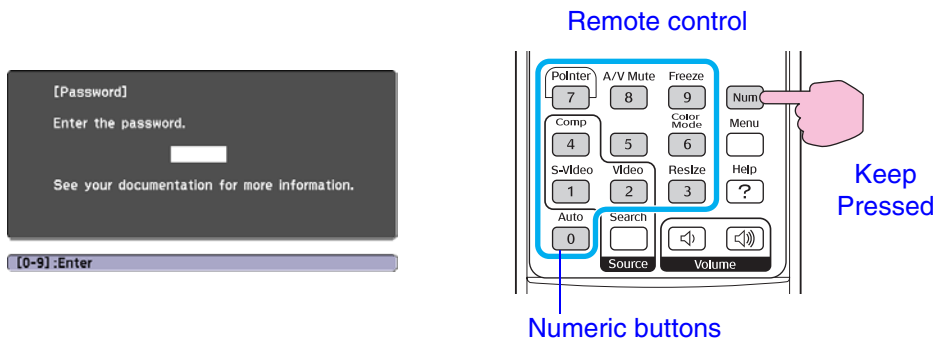

While holding down the [Num] button, press the numeric keypad buttons to enter the password. If the password is entered correctly, projection will start.

If you leave the power cable connected to the electrical outlet and turn the projector's power on when it is in standby mode, projection will start without the password entry screen appearing. The password entry screen will only be displayed when the power is turned on for

the first time after the power cable has been disconnected and then reconnected. If Direct Power On is set to "On" and you are using a circuit breaker or similar to centrally control the power, the password entry screen will be displayed the first time the projector is turned on after the power supply is restored.



- If an incorrect password is entered three times in succession, the message "The projector's operation will be locked." will be displayed for approximately five minutes, and then the projector will switch to standby mode. If this happens, disconnect the power plug from the electrical outlet and then reinsert it and turn the projector's power back on. A window requesting you to enter the password will be displayed, so enter the correct password. If you happen to forget the password, make a note of the "Request Code: xxxxx" number that appears in the Password screen and contact Epson (see [page 57](#)).
- If you continue to repeat the above operation and input the wrong password thirty times, the following message will be displayed and the projector will not accept password entries any more. "The projector's operation will be locked." Contact Epson (see [page 57](#)).

■ When "Password Timer" is set to "On" and "Timer" is used

The password entry screen will not be displayed at all when the power is turned on until the length of time that has been set has elapsed. When the set length of time has elapsed, the password entry screen will be displayed each time the power is turned on. The length of time referred to here is the total illumination time for the projector's lamp from the point when the projector's menu is closed.

If "Password Timer" is set to "Off", the password entry screen will be displayed each time the power plug is disconnected and reinserted from the electrical outlet. If the projector's power is on when it is in standby mode, the password entry screen will not be displayed.

■ When "User's Logo Protect" is enabled (On)

If an attempt is made to carry out any of the following user logo operations, a message is displayed and the setting cannot be changed. To change the setting, set "User's Logo Protect" to "Off" first. See [page 35](#).

- ▶ Capturing a user's logo
- ▶ When the "Extended" - "Display" - "Display Background" menu, or the "Extended" - "Display" - "A/V Mute" menu, is changed from "Logo" to "Black" or "Blue", or changed from "Black" or "Blue" to "Logo".
- ▶ When the "Extended" - "Display" - "Startup Screen" menu ("On" or "Off") is changed.

Setting Password Protect

Use the following procedure to set Password Protect.

1 Hold down the [Freeze] button for approximately 5 seconds.

The "Password Protect" menu will be displayed.

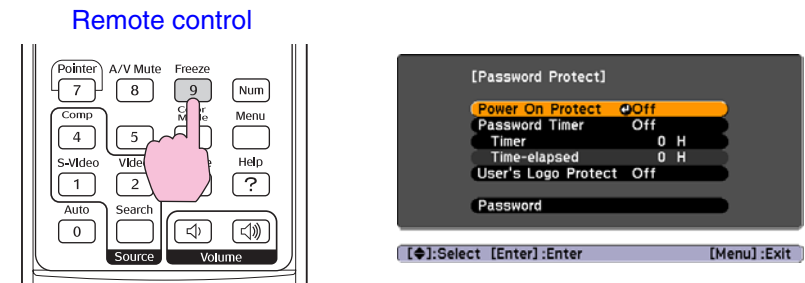

- If Password Protect has already been enabled, the "Password" screen will be displayed. If the password has been entered correctly, the "Password Protect" menu will be displayed. See ["When Password Protect is Enabled" on page 24](#).
- If Password Protect is set to "On", attach the accessory Password Protect sticker to your preferred position on the projector as a theft-prevention measure.

2 Turn "Power On Protect" on.

- (1) Select "Power On Protect", and then press the [Enter] button.
- (2) Select "On", and then press the [Enter] button.
- (3) Press the [Esc] button.

3 Turn "Password Timer" on.

If you don't use this setting, proceed to step 4.

- (1) Select "Password Timer", and then press the [Enter] button.
- (2) Select "On", and then press the [Enter] button.
- (3) Press the [Esc] button.
- (4) Select "Timer" and then press the [Enter] button.
- (5) While holding down the [Num] button, use the numeric keypad buttons to enter the setting time within the range of 1 to 9999 hours and then press the [Enter] button. If you make a mistake entering the time, press the [Esc] button

and re-enter the time.

When you have finished using the "Password Protect" menu, the countdown for the elapsed time will start.

4 Turn "User's Logo Protect" on.

- (1) Select "User's Logo Protect", and then press the [Enter] button.
- (2) Select "On", and then press the [Enter] button.
- (3) Press the [Esc] button.

5 Enter the password.

- (1) To set a password, select "Password" and then press the [Enter] button.
- (2) The message "Change the password?" will be displayed, so select "Yes" and then press the [Enter] button. The default setting for the password is "0000", but you should change this to your own desired password. If you select "No", the screen shown at step 1 will be displayed again.
- (3) While holding down the [Num] button, use the numeric keypad buttons to enter a 4-digit number. The number entered will be displayed as "* * * *". Once four digits have been entered, the confirmation screen will be displayed.
- (4) Re-enter the password.
The message "The new password is stored." will be displayed. If you enter the password incorrectly, a message will be displayed prompting you to re-enter the password.

Using the Operation Lock

This function locks the buttons on the projector's control panel. You can use it when projecting at tradeshows or in schools, so that projection can be carried out without interruption.

1 From the configuration menu, select "Settings" - "Operation Lock".

Check the buttons you can use and the operations they perform in the guide at the bottom of the screen.

Using the remote control

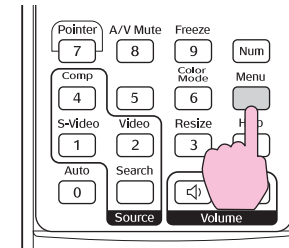

Using the control panel

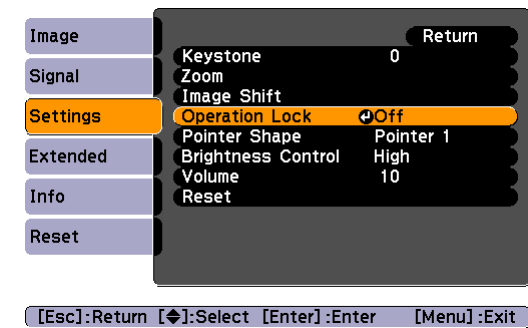
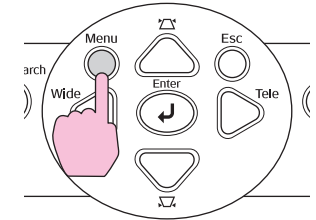

2 Set to "On".

If set to "On", none of the buttons on the control panel except the [Power] button can be operated.

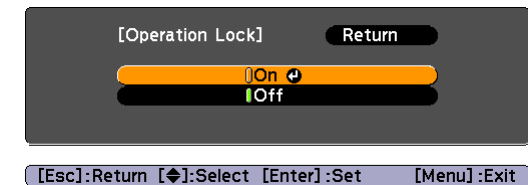

Using the remote control

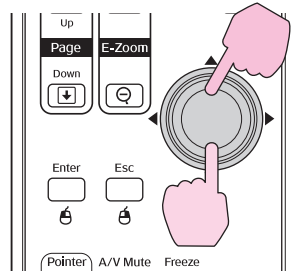

Using the control panel

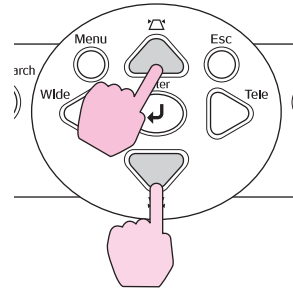

3 When the confirmation message is displayed, select "Yes".

The control panel buttons will be locked in accordance with the selected setting.



There are two methods to cancel the projector's control panel lock.

- *Using remote control, change the "Settings" - "Operation Lock" in the configuration menu to "Off".*
- *Hold down the projector's [Enter] button continuously for about 7 seconds. A message will be displayed and the lock will be cancelled.*

Saving a User's Logo

You can record the image that is currently being projected as a user's logo.



When a user's logo is recorded, the previous user's logo will be erased.

- 1 Project the image you would like to use as the user's logo, and then display the configuration menu.

Using the remote control

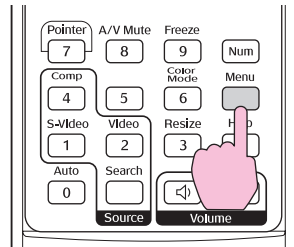

Using the control panel

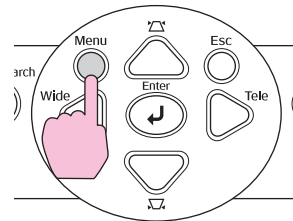

- 2 Select "Extended" from the configuration menu, and then select "User's Logo".

Check which buttons on the remote control or the control panel you can use, and the operations they perform, in the guide at the bottom of the screen.

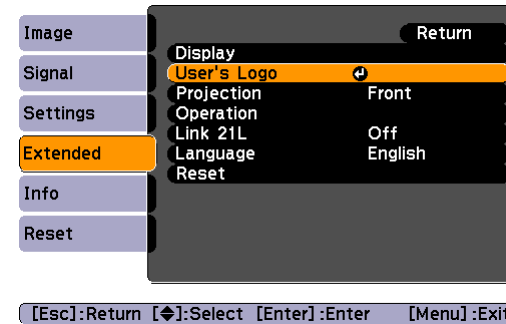

- If the "User's Logo Protect" function of "Password Protect" is set to "On", a message is displayed and the user's logo can not be recorded. To record a user's logo, set "User's Logo Protect" to "Off" first. See ["When "User's Logo Protect" is enabled \(On\)" on page 25.](#)
- If keystone correction, Zoom adjustment, or E-Zoom and so on, have been carried out, the function currently being performed is cancelled when the "User's Logo" menu is selected.

- 3** When "Choose this image as the User's Logo?" appears, select "Yes".



When you press the [Enter] button, the image will be displayed at its original resolution. For example, if a video image or an image with a resolution that is different from the projector's native resolution is being displayed, the image size will change.

- 4** The image to be recorded and a selection marquee box will be displayed. Move the marquee box to select the part of the image to use.



Using the remote control

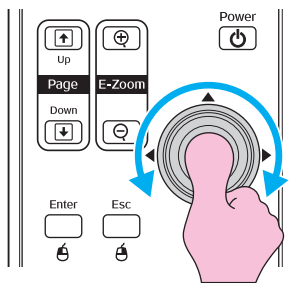

Using the control panel

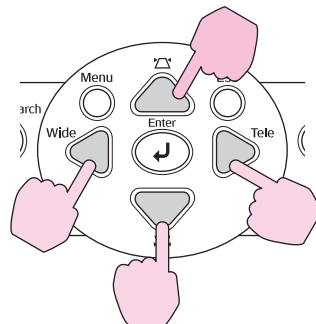

User's logos can be saved at up to 400 × 300 dots in size.

- 5** When "Select this image?" appears, select "Yes".

- 6** Select the zoom rate from the Zoom rate setting screen.

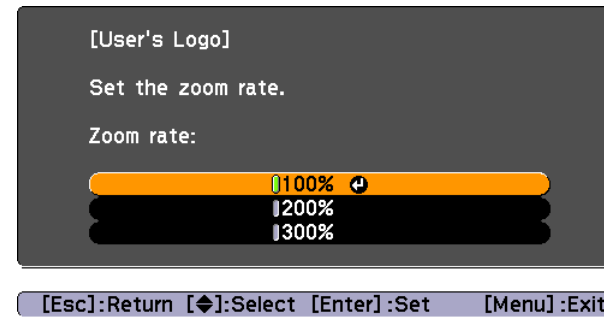

- 7** When "Save this image?" is displayed, select "Yes".

The image will then be saved. Once the image has been saved, the message "Completed." will be displayed.



- Saving the user's logo may take a few moments (about 15 seconds). Do not use the projector or any other sources which are connected to the projector while the user's logo is being saved, otherwise it may result in errors in projector operation.
- Once a user's logo has been saved, the logo setting cannot be returned to the factory default.

Displaying Projected Images on an External Monitor

When projecting from a computer (analog RGB or RGB video source), you can connect an external monitor to view the projected image.

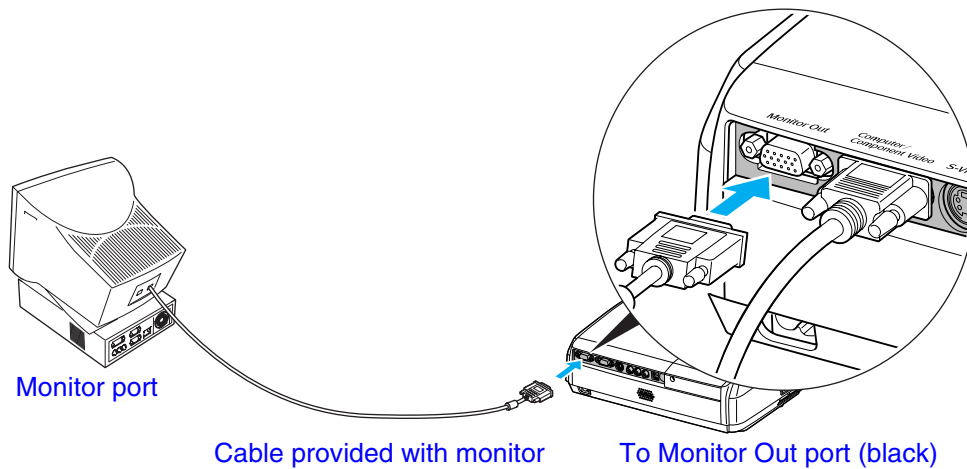

- *Component video and S-Video images cannot be output to an external monitor.*
- *The setting gauge for keystone correction and the configuration menus and help menus are not output to the external monitor.*

Configuration Menus

Using the Menu System

1 Select from the main menu

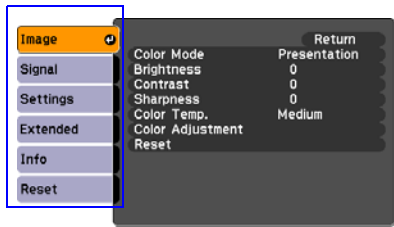

[Left Arrow]:Select [Enter]:Enter [Menu]:Exit

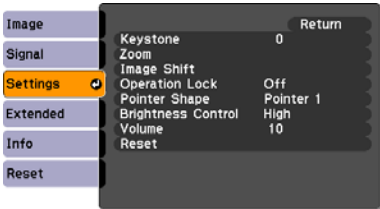
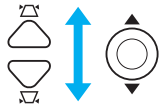

[Left Arrow]:Select [Enter]:Enter [Menu]:Exit

2 Select from the sub menu

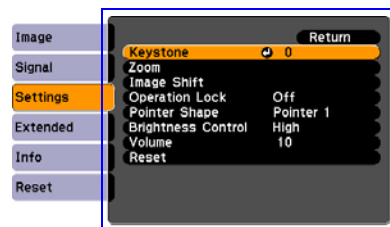

[Esc]:Return [Left Arrow]:Select [Enter]:Enter [Menu]:Exit

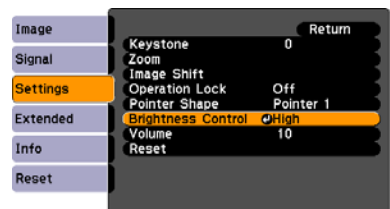
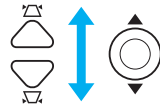

[Esc]:Return [Left Arrow]:Select [Enter]:Enter [Menu]:Exit

3 Change the selected item



[Esc]:Return [Left Arrow]:Select [Right Arrow]:Adjust [Menu]:Exit

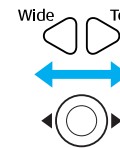

[Esc]:Return [Left Arrow]:Select [Enter]:Set [Menu]:Exit

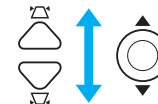

[Esc]:Return [Left Arrow]:Select [Enter]:Set [Menu]:Exit

Buttons used

Control panel

Remote control



[Esc]:Return [Left Arrow]:Select [Enter]:Set [Menu]:Exit

"Image" Menu

The items that can be set will vary depending on the input source that is currently being projected. Setting details are saved separately for each source.

Computer/RGB video

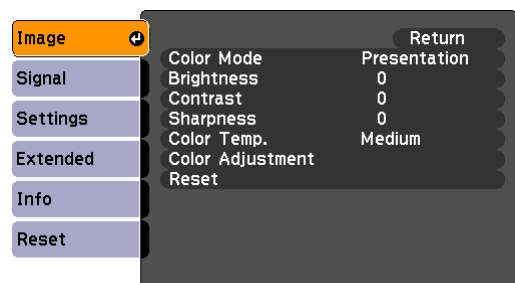

Component video/composite video/S-video

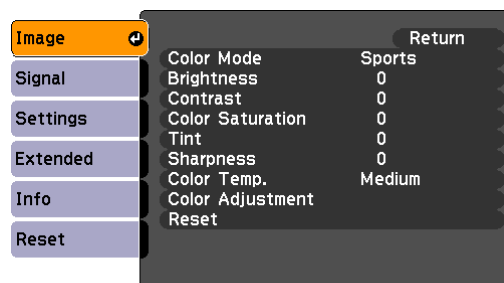

[Left Arrow]:Select [Enter]:Enter [Menu]:Exit

[Left Arrow]:Select [Enter]:Enter [Menu]:Exit

Sub-menu	Function
Color Mode	Select the quality of the image to suit your surroundings. See page 14 .
Brightness	Adjusts the image brightness.
Contrast	Adjusts the difference between light and dark in the images.
Color Saturation	Adjusts the color saturation for the images.
Tint	Adjusts the image tint. (Adjustment is only possible when component video or NTSC signals are being input.)
Sharpness	Adjusts the image sharpness.
Color Temp.	You can adjust the overall tint of images. If you select "High", images appear bluish, and if you select "Low", images appear reddish. (This item cannot be selected if "sRGB" has been selected as the "Color Mode" setting in the "Image" menu.)
Color Adjustment	Adjusts the red, green, and blue color strength of the image. Red: Adjusts the saturation of the red component. Green: Adjusts the saturation of the green component. Blue: Adjusts the saturation of the blue component. (This item cannot be selected if "sRGB" has been selected as the "Color Mode" setting in the "Image" menu.)
Reset	Resets all adjustment values for the "Image" menu functions to their default settings. If you would like to return all menu items to their default, see "Reset All" on page 38 .

"Signal" Menu

The items that can be set will vary depending on the input source that is currently being projected. Setting details are saved separately for each source.

Computer/RGB video

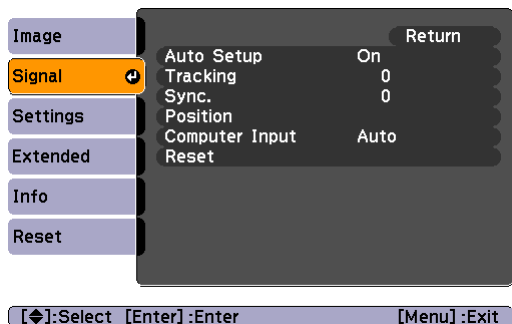

Component video

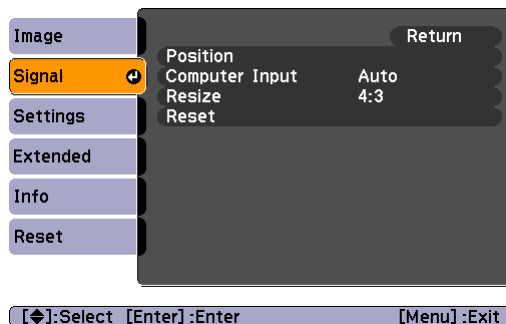

Component video/S-video

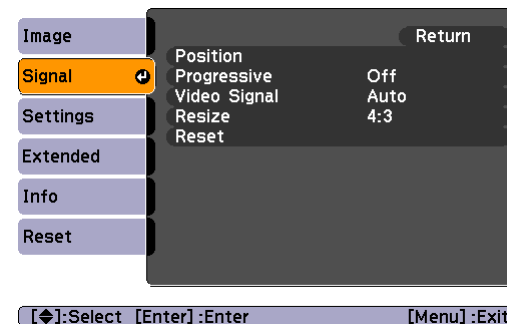

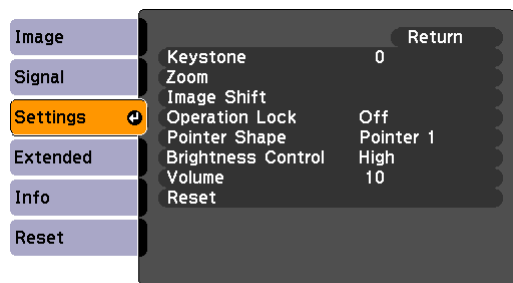

Sub-menu	Function
Auto Setup	Turns on or off the function for automatically optimizing images when the input source is changed.
Tracking	Adjusts computer images when vertical stripes appear in the images. See page 12 .
Sync.	Adjusts computer images when flickering, fuzziness or interference appear in the images. See page 13 .
Position	Moves the image display position vertically and horizontally.
Progressive	(Adjustment is only possible when composite Video or S-Video signals are being input.) Off: IP conversion is carried out for each field in the screen. This is ideal when viewing images with a large amount of movement. On: Interlaced (i) signals are converted into progressive (p) signals. This is ideal when viewing still images.
Computer1 Input	Selects the input signal in accordance with the equipment that is connected to the Computer port. If set to "Auto" the input signal is set automatically in accordance with the connected equipment. If the colors do not look correct when you select "Auto", select the appropriate signal for the connected equipment manually.
Video Signal	(Adjustment is only possible when composite video/S-Video signals are being input.) Sets the video signal format. With the "Auto" function, image signals are recognized automatically. If interference appears in the projected images or no images appear when you select "Auto", select the appropriate signal manually.
Resize	Sets the aspect ratio for projected images. See page 20 .
Reset	All the adjustment values on the "Signal" menu, except "Computer Input", are returned to their default values. Press the [Enter] button on the remote control or on the projector's control panel. If you would like to return all menu items to their default, see "Reset All" on page 38 .

"Settings" Menu



[◀]:Select [Enter]:Enter [Menu]:Exit

Sub-menu	Function
Keystone	Corrects vertical keystone distortion in images. See the <i>Quick Setup</i> sheet.
Zoom	Adjusts the size of the projected image. Wide: Larger Tele: Smaller
Image Shift	Adjusts the projection position. See page 16 .
Operation Lock	When set to "On", the operation of all buttons on the projector's control panel except for the [Power] button will be disabled. See page 26 .
Pointer Shape	The shape of the pointer can be selected. See page 21 . Pointer 1:  Pointer 2:  Pointer 3: 
Brightness Control	This lets you set the lamp brightness to one of two settings. Select "Low" if the images being projected are too bright such as when projecting images in a dark room or onto a small screen. When "Low" is selected, image brightness is reduced. This also reduces fan noise and electrical consumption while extending the lamp's operating life.
Volume	Adjusts the volume. See page 17 .
Reset	Adjustment values for the "Settings" menu functions are returned to their default settings, except for "Image Shift" and "Zoom". If you would like to return all menu items to their default, see "Reset All" on page 38 .

"Extended" Menu

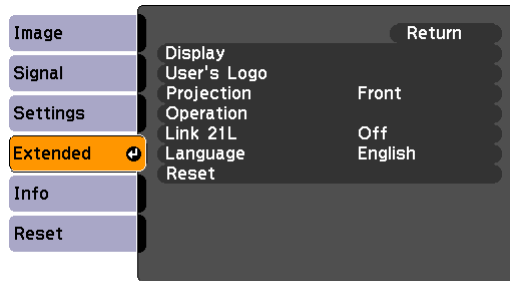

[↔]:Select [Enter]:Enter [Menu]:Exit

Sub-menu	Function
Display	<p>This lets you make settings related to the projector's display.</p> <p>Message: Sets whether on-screen messages are displayed. Messages include the input source, color mode, and "No Signal" message.</p> <p>Display Background: Determines the background screen displayed when no image signals are input. Options include "Black", "Blue" or "Logo".</p> <p>Startup Screen: Sets whether the startup screen is displayed (the image projected when the projector is started).</p> <p>A/V Mute: Determines the background screen displayed when the [A/V Mute] button on the remote control is pressed. Options include "Black", "Blue" or "Logo".</p>
User's Logo	<p>Change the user's logo that is displayed as a background or during A/V Mute. See page 28.</p>
Projection	<p>Sets the image orientation, depending on where you place the projector relative to the screen. See page 6.</p> <p>"Front" "Front/Ceiling" "Rear" "Rear/Ceiling"</p> <p>By holding down the [A/V Mute] button for about 5 seconds, you can change the projection setup in the following ways.</p> <p>Front ↔ Front Ceiling Rear ↔ Rear Ceiling</p>

Sub-menu	Function
Operation	<p>Direct Power On: Sets whether direct power on is enabled ("On") or disabled ("Off"). When you set to "On" and leave the power cable connected to a wall socket, the projector may turn on by itself when electricity is restored after a power outage.</p> <p>Sleep Mode: Sets whether projection stops automatically in the following situations: - When no image signals are input for approximately 30 minutes. - When the lens cover is shut and no operations are carried out for approximately 30 minutes. When Sleep Mode is "On" the power turns off after about 30 minutes. When Sleep Mode is "Off" the power and the lamp remain on continuously. When you finish using the projector, turn off the power and disconnect the cable.</p> <p>High Altitude Mode: When using above an altitude of about 1,500m, set to "On".</p>
Link 21L	<p>Sets whether the EMP Link 21L utility software is being used or not. To enable the EMP Link 21L, turn the projector's power off and wait until the cool down period has finished.</p>
Language	<p>Sets the language for the menu system and on-screen messages.</p>
Reset	<p>Returns "Display" and "Operation" settings in the "Extended" menu (except for "High Altitude Mode") to their default settings. If you would like to return all menu items to their default, see "Reset All" on page 38.</p>

"Info" Menu

Lets you check the type of image signal being projected and the status of the projector.

Computer/RGB video/component video

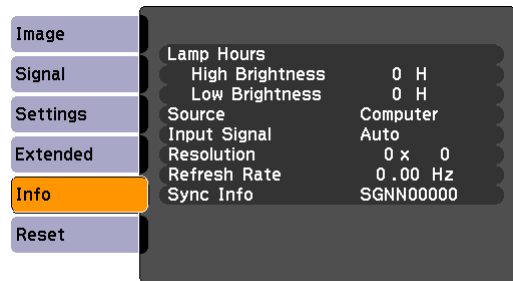

Composite video/S-video

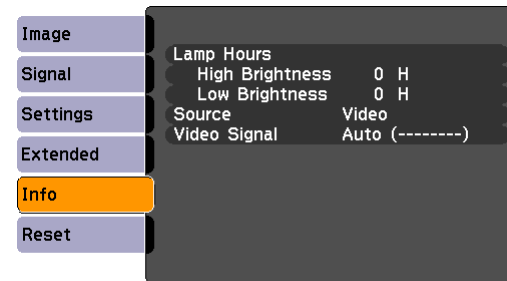

[↵]:Select [Menu]:Exit

[↵]:Select [Menu]:Exit

Sub-menu	Function
Lamp Hours	Shows the cumulative lamp operating time. If it reaches the lamp warning time, the characters are displayed in yellow. The cumulative operating time from 0 to 10 hours will be displayed as "0H". From "10H" onwards, the display will be in units of 1 hour.
Source	Displays the input source currently being projected.
Input Signal	Displays the Input Signal setting. (Does not appear when the input source is composite video or S-video.)
Resolution	Displays the input resolution. (Does not appear when the input source is composite video or S-video.)
Video Signal	Shows the video signal format. (Not displayed for computer, RGB video, or component video images.)
Refresh Rate	Displays the refresh rate. (Does not appear when the input source is composite video or S-video.)
Sync. Info	Information from this menu may be required when you ask for service from your dealer or from Epson. (Does not appear when the input source is composite video or S-video.)

"Reset" Menu

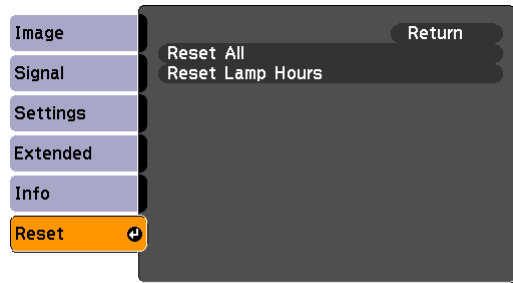

[◆]:Select [Enter]:Enter [Menu]:Exit

Sub-menu	Function
Reset All	Resets all items in all menus to their default settings. The "Computer1 Input", "Zoom", "Image Shift", "User's Logo", "Lamp Hours" and "Language" settings will not be reset to their defaults.
Reset Lamp Hours	Clears the cumulative lamp operating time and resets it to "0H". Perform this procedure when you replace the lamp.

Maintenance

This section describes maintenance tasks such as cleaning the projector and replacing consumable parts.

Cleaning

You should clean the projector if it becomes dirty or if the quality of projected images starts to deteriorate.

Cleaning the Projector

Clean the projector's surface by wiping it gently with a soft cloth.

If the projector is particularly dirty, moisten the cloth with water containing a small amount of neutral detergent, and then firmly wring the cloth dry before using it to wipe the projector's surface. Then wipe it again with a soft, dry cloth.



Do not use volatile substances such as wax, alcohol or thinner to clean the projector's surface. These can cause the projector to warp and make the coating finish peel off.

Cleaning the Lens

Use a commercially-available air blower, or use a lens cleaning paper to gently wipe the lens.



Do not rub the lens with harsh materials or subject the lens to shocks, as it can easily become damaged.

Cleaning the Air Filters and Air Intake Vent

If dust collects on the air filter or the air outlet, it can cause the internal temperature of the projector to rise, and this can lead to problems with operation and shortening of the optical engine's service life.

It is recommended that you clean these parts at least once every three months. Clean them more often than this if using the projector in particularly dusty environments.

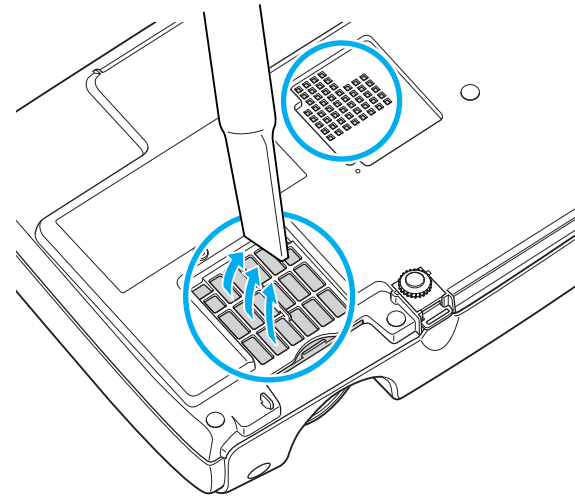

If the air filters are broken or if the warning message reappears after they have been cleaned, they should be replaced. Replace with a new air filter. See [“Replacing the Air Filter” on page 44](#).

Replacing Consumables

This section explains how to replace the remote control batteries, the lamp, and the air filters.

Replacing the Batteries

If delays in the responsiveness of the remote control occur or if it does not operate after it has been used for some time, it probably means that the batteries are getting low. Replace the batteries. Have two spare AAA-size alkali batteries ready to use when required.

1 Remove the battery cover.

While pushing the catch of the battery compartment cover, lift the cover up.

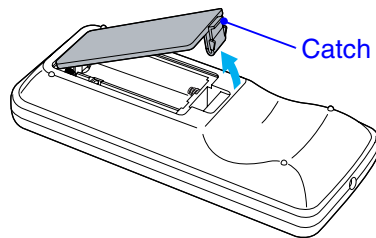

2 Insert the batteries.

Check the positions of the (+) and (-) marks inside the battery holder to ensure that the batteries are inserted the correct way.

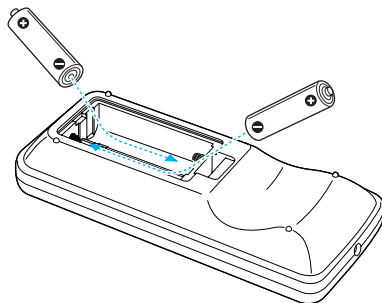

3 Replace the battery cover.

Press the battery compartment cover until it clicks into place.

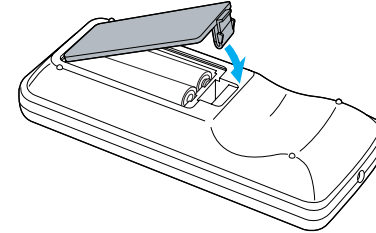

Lamp Replacement Period

It is time to replace the lamp when:

- The message "Replace the Lamp." appears on the screen when projection starts

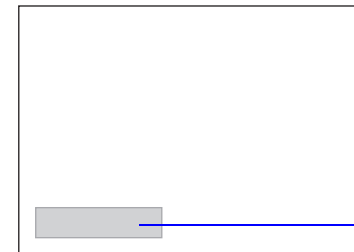

- When the Lamp indicator is flashing orange

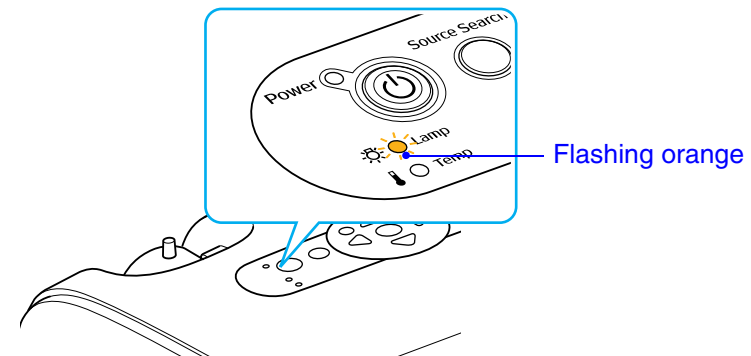

- The projected image gets darker or starts to deteriorate



- *The lamp replacement message is set to appear after the following periods of time in order to maintain the initial brightness and quality of the projected images.*
 - *When used at high brightness: Approx. 2000 hours*
 - *When used at low brightness: Approx. 3000 hours*
- *If you continue to use the lamp after this period, the possibility of the lamp breaking becomes greater. When the lamp replacement message appears, replace the lamp with a new one as soon as possible, even if it is still working.*
- *Depending on the characteristics of the lamp and on the way it has been used, the lamp may become darker or stop working before the lamp warning message appears. You should always have a spare lamp ready in case it is needed.*
- *Contact Epson for a spare lamp (see [page 57](#)).*
- *Lamp life results vary depending on mode selected, environmental conditions, and usage. Lamp brightness decreases over time. Turn off this product when not in use to prolong the life of the projector.*

Replacing the Lamp



- *If you are replacing the lamp, it is possible that the glass around the lamp is broken.*
- *If replacing the lamp on a ceiling-mounted projector, be careful when removing the lamp cover; broken glass could fall out of the lamp area and get in your eyes.*
- *Wait until the lamp has cooled down sufficiently (about one hour) before removing the lamp cover.*

- 2 **Wait until the lamp has cooled down, then remove the lamp cover from the base of the projector.**

Loosen the lamp cover screw with the screwdriver that is supplied with the spare lamp (or your own Phillips head screwdriver).

Then slide the lamp cover straight back and lift it off.

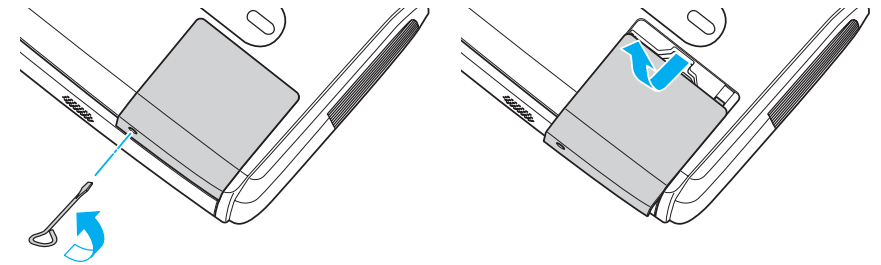

- 3 **Loosen the two lamp screws.**

Loosen the two screws that secure the lamp.

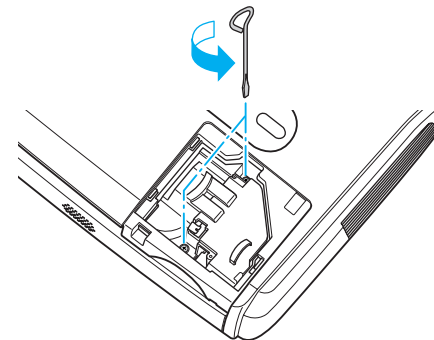

- 1 **Turn off the projector's power, wait until it beeps twice, and disconnect the power cable.**

4 Take out the lamp.

Hold the lamp as shown in the illustration below and lift it up and out of the projector.

If the lamp is broken replace it with a new lamp, or contact Epson for further advice (see [page 57](#)). If replacing the lamp yourself, be careful to avoid pieces of broken glass.

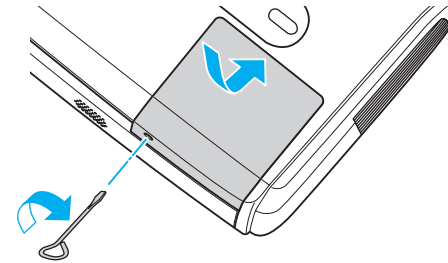
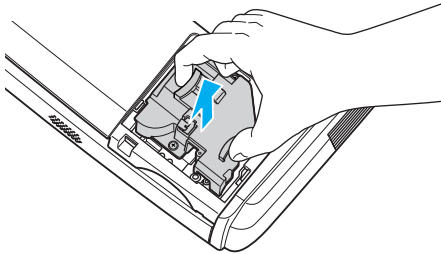

- *Install the lamp securely. If the lamp cover is removed, the lamp turns off automatically as a safety precaution. The lamp will not turn on if the lamp or the lamp cover is not installed correctly.*
- *(Hg) This product includes a lamp component that contains mercury (Hg). Please consult your state and local regulations regarding disposal or recycling. Do not put in the trash.*

5 Install the new lamp.

Insert the new lamp so that the lamp fits in place correctly. After inserting it fully, tighten the two screws.

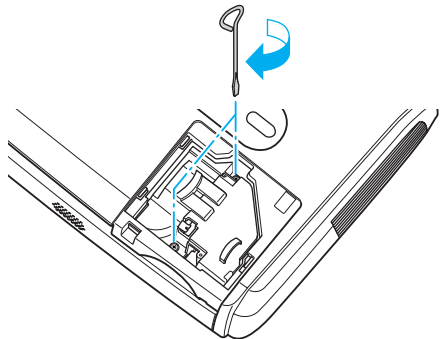

6 Install the lamp cover.

Slide on the lamp cover and tighten its screw.

Resetting the Lamp Operating Time

The projector has a built-in counter which keeps track of the lamp operating time. When the cumulative operating time reaches a certain point, it causes the replacement warning message to be displayed. The counter needs to be reset after the lamp has been replaced with a new one. You can do this using the configuration menu.



Do not reset the lamp operating time except after the lamp has been replaced, otherwise the lamp replacement period will not be indicated correctly.

- 1** Connect the power cable and turn on the projector.
- 2** Select "Reset" from the configuration menu, and then select "Reset Lamp Hours".

Check the buttons you can use, and the operations they perform, in the guide at the bottom of the screen.

Using the remote control

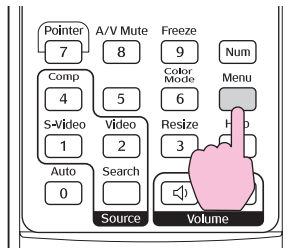

Using the control panel

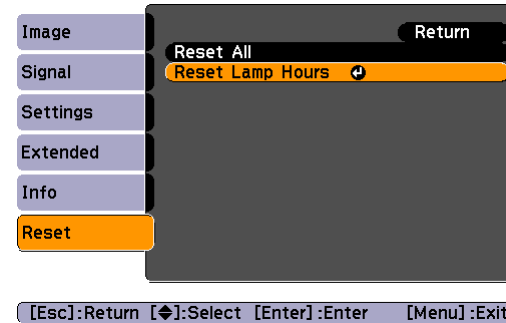
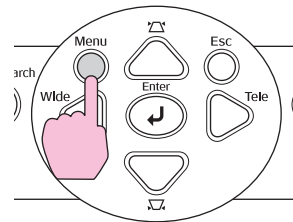

- 3** When "Execute?" appears, select "Yes".
The lamp operating time will then be reset.

Replacing the Air Filter

If the air filter is broken or if a warning message reappears after it has been cleaned, it should be replaced.

The air filter can be replaced even if the projector is installed on a ceiling.

1 Turn off the projector's power, wait until it beeps twice, and disconnect the power cable.

2 Remove the air filter.

Put your finger into the recess of the air filter and slide it out to remove it.

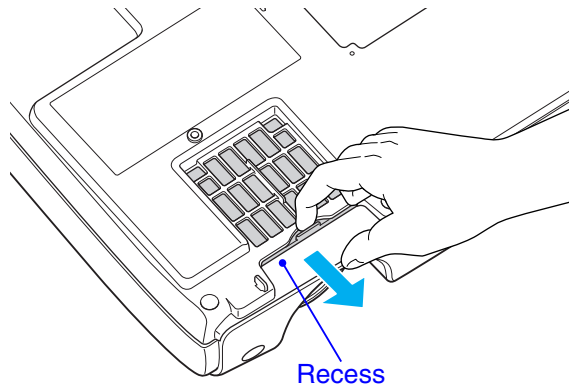

3 Install the new air filter.

Slide in the new air filter and press until it clicks into place.

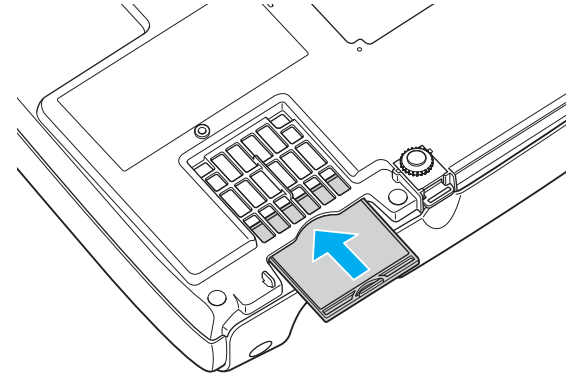

Dispose of used air filters properly in accordance with your local regulations.

Air filter frame: Polycarbonate, ABS plastic

Filter: Polyurethane foam

Troubleshooting

Using the Help Menu

If a problem occurs with the projector, you can use the Help function to assist you in solving the problem. It uses a series of menus in a question and answer format. If the Help function does not provide a solution to the problem, see [“Problem Solving” on page 47.](#)

1 Display the Help menu.

Using the remote control

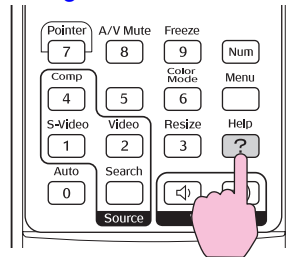

Using the control panel

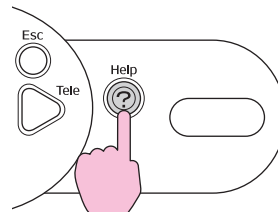

2 Select a menu item.

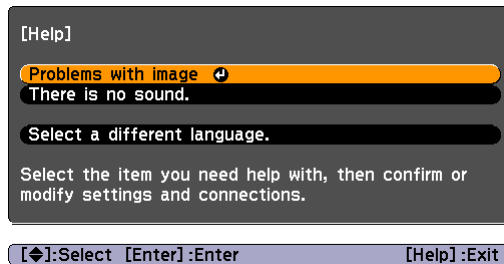

Using the remote control

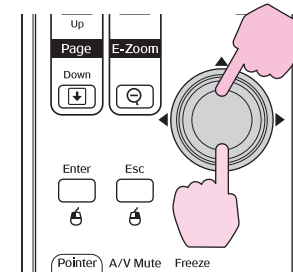

Using the control panel

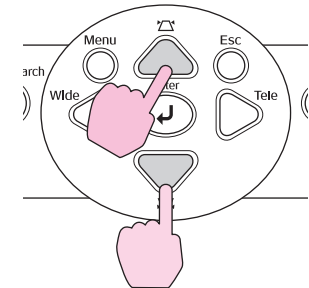

3 Confirm the selection.

Using the remote control

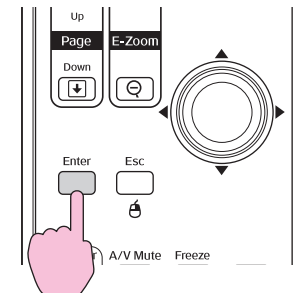

Using the control panel

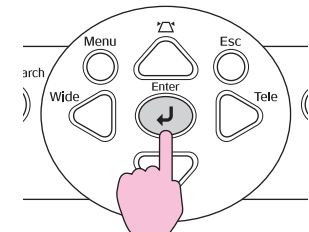

- 4 Repeat the operations in steps 2 and 3 to proceed through the menu to more detailed items.

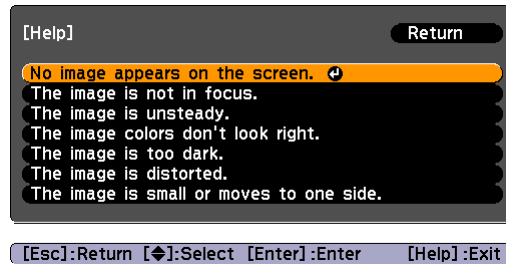

- 5 Press the [Help] button to exit the help menu.

Problem Solving

If you are having a problem with the projector, first check the projector's indicators and refer to "Reading the Indicators" below.

If the indicators do not show clearly what the problem might be, see ["When the Indicators Provide No Help" on page 50.](#)

Reading the Indicators

The projector is provided with the following three indicators which indicate the operating status of the projector.

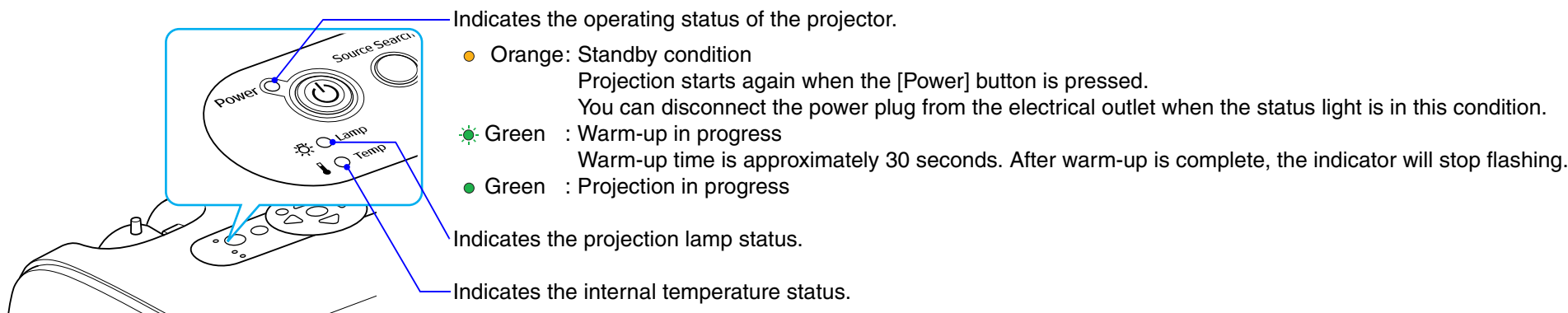















The following tables show what the indicators mean and how to remedy problems that they indicate.





If all indicators are switched off, check that the power cable is connected correctly and that power is being supplied normally.



Power indicator lights red

Status	Cause	Remedy or Status
Power ● Red ● Red ● Red	Internal error	Stop using the projector, disconnect the power cable from the electrical outlet, and contact Epson (see page 57).

Status	Cause	Remedy or Status
Power  Red     Red	Fan related error/ Sensor error	Stop using the projector, disconnect the power cable from the electrical outlet, and contact Epson (see page 57).
Power  Red     Red	High temperature error (overheating)	The lamp will turn off automatically and projection will stop. Wait for about 5 minutes until the projector switches to standby mode, then do the following: <ul style="list-style-type: none"> • Make sure the air filter and air exhaust vent are clear, and the projector is not positioned against a wall. • If the air filters are blocked, clean or replace them. See page 44. Press the [Power] button to turn the power back on. If this does not solve the problem and the projector continues to overheat or the indicators continue to show a problem when the power is turned on, stop using the projector, disconnect the power cable from the wall outlet, and contact Epson (see page 57).
Power  Red   Red  	Lamp problem Lamp timer failure Lamp cover is open	Take out the lamp and check if it is broken. See page 41 . If the lamp is not broken, put it back in and then turn the power on. If the lamp still does not turn on, replace it with a new lamp. If this does not solve the problem, stop using the projector and disconnect the power cable from the electrical outlet. Then contact Epson (see page 57). If the lamp is broken replace it with a new lamp, or contact Epson for further advice (see page 57). If replacing the lamp yourself, be careful to avoid pieces of broken glass. (Projection cannot be carried out until the lamp is replaced.) Check that the lamp and the lamp cover are securely installed. If the lamp or lamp cover is not securely installed, the lamp will not switch on. When using above an altitude of about 1,500m, make sure you set the "High Altitude Mode" to "On".

Lamp or Temp indicator flashes orange

Status	Cause	Remedy or Status
Power  Red     Orange	High temperature warning	(This is not an abnormality, but if the temperature rises too high again, projection will stop automatically.) Check that the air filter and air exhaust vent are clear and that they are not up against a surface such as a wall. If the air filter is clogged, clean or replace it. See page 44 .

Status	Cause	Remedy or Status
Power ●   Orange  ○	Lamp replacement notification	Replace the lamp with a new one. See page 41 . If you continue to use the lamp after it has passed the replacement period, the possibility that the lamp may break will increase. Replace the lamp with a new one as soon as possible. The Power indicator status will vary depending on the projector status at the time.



- If the projector is not operating properly even though the indicators are all showing normal, refer to "When the Indicators Provide No Help" on the following page.
- If an indicator is showing a status which does not appear in the previous tables, contact Epson (see [page 57](#)).

When the Indicators Provide No Help

If any of the following problems occur and the indicators do not offer a solution, refer to the pages given for each problem.

Problems relating to images

- No images appear [page 51](#)

Projection does not start, the projection area is completely black, the projection area is completely blue, and so on.

- Projection stops automatically [page 51](#)
- The message "Not Supported." is displayed [page 51](#)
- The message "No Signal." is displayed [page 52](#)
- Images are fuzzy or out of focus [page 52](#)
- Interference or distortion appear in images [page 53](#)

Problems such as interference, distortion or black & white checked patterns appear.

- Image is cut off or too small [page 53](#)

Only part of the image is displayed.

- Image colors are not right [page 54](#)

The whole image appears purplish or greenish, images are black & white, colors appear dull, and so on. (Computer monitors and LCD screens have different color reproduction performance, so that the colors projected by the projector and the colors appearing on the monitor may not necessarily match, but this is not a sign of a problem.)

- Images appear dark [page 54](#)
- Nothing appears on the external monitor [page 54](#)

Problems when projection starts

- Power does not turn on [page 55](#)

Other problems

- No sound can be heard or the sound is faint [page 55](#)
- The remote control does not work [page 56](#)

■ Problems relating to images

■ No images appear

Check	Remedy
Was the [Power] button pressed?	Press the [Power] button to turn the power on.
Are the indicators switched off?	The power cable is not connected correctly or power is not being supplied normally. Connect the projector's power cable correctly. See the <i>Quick Setup</i> sheet. Check that your power supply socket is working.
Is A/V Mute mode active?	Press the [A/V Mute] button on the remote control to cancel the mute. See page 19 .
Have the configuration menu settings been made correctly?	Reset all of the settings. See page 38 .
Is the projected image completely black?	Some input images, such as screen savers, may be completely black.
Are the image signal format settings correct?	If a composite video or S-video source is connected to the projector, use the "Video Signal" menu command to select the signal format. See page 33 .
Is the lens cover still closed?	Open the lens cover.

■ Projection stops automatically

Check	Remedy
Is "Sleep Mode" set to "On"?	If you do not want sleep mode to be used, change the "Sleep Mode" setting to "Off". See page 36 .

■ The message "Not Supported." is displayed

Check	Remedy
Are the image signal format settings correct?	If a composite video or S-video source is connected to the projector, use the "Video Signal" menu command to select the signal format. See page 33 .
If you're projecting from a computer, does the mode match the frequency and resolution of the image signals?	Refer to the documentation provided with your computer for details on changing the resolution and frequency of the image signals being output from the computer. See " List of Supported Monitor Displays " on page 63 .

■ The message "No Signal." is displayed

Check	Remedy
Are the cables connected correctly?	Check that all of the cables required for projection are securely connected. See the <i>Quick Setup</i> sheet.
Has the correct video input port been selected?	Press the [Computer1], [S-Video] or [Video] button on the remote control or the [Source Search] button on the remote control or the projector's control panel to change the image.
Is the power for the computer or video source turned on?	Turn the power on for the devices.
If you're projecting from laptop, are the image signals being output to the projector?	<p>If the image signals are only being output to the laptop's monitor, you need to change the output to an external destination as well as the laptop's own monitor. For some laptop models, when the image signals are output externally, they no longer appear on the LCD monitor.</p> <p>See your computer documentation, under a title such as "External Output" or "Connecting an External Monitor"</p> <p>If the connection is made while the power is already turned on, the function [Fn] key that switches the computer's video signal to external output may not work. Turn the power for the projector and the computer off and then back on again. See the <i>Quick Setup</i> sheet.</p>

■ Images are fuzzy or out of focus

Check	Remedy
Has the focus been adjusted correctly?	Turn the focus ring on the projector to adjust the focus.
Is the projector at the correct distance?	Check the recommended projection distance. See page 59 .
Is the keystone adjustment value too large?	Decrease the projection angle to reduce the amount of keystone correction. See the <i>Quick Setup</i> sheet.
Is the zoom adjustment value too small?	Enlarge the zoom adjustment value. See the <i>Quick Setup</i> sheet.
Has condensation formed on the lens?	If the projector is suddenly taken from a cold environment to a warm environment or if sudden ambient temperature changes occur, condensation may form on the surface of the lens, and this may cause the images to appear fuzzy. Set the projector up in the room approximately one hour before it is to be used. If condensation forms on the lens, turn the power off and wait for the condensation to disappear.

■ Interference or distortion appear in images

Check	Remedy
Are the image signal format settings correct?	If a composite video or S-video source is connected to the projector, use the "Video Signal" menu command to select the signal format. See page 33 .
Are the cables connected correctly?	Check that all of the cables required for projection are securely connected. See the <i>Quick Setup</i> sheet.
Is an extension cable being used?	If an extension cable is used, electrical interference may affect the signals.
For computer images, has the correct resolution been selected?	Set the computer so that the signals that are output are compatible with this projector. See " List of Supported Monitor Displays " on page 63 .
For computer images, have the Sync. and Tracking settings been adjusted correctly?	Press the [Auto] button on the remote control or the [Enter] button on the projector's control panel to carry out automatic adjustment. If the images have not been adjusted correctly after using automatic adjustment, you can make the adjustments using the "Sync" and "Tracking" functions. See page 12 .

■ Image is cut off or too small

Check	Remedy
Has the aspect ratio been set correctly?	Press the [Resize] button on the remote control. See page 20 .
Is the image still being enlarged by the E-Zoom function?	Press the [Esc] button on the remote control to cancel the E-Zoom function. See page 21 .
Has the "Position" setting been adjusted correctly?	If analog RGB images from a computer or RGB video images are being projected, press the [Auto] button on the remote control or the [Enter] button on the projector's control panel to carry out automatic adjustment. If the images have not been correctly adjusted after using the automatic setup function, adjust the setting manually using the "Position" menu command. If signals other than analog RGB images from a computer or RGB video images are being input, adjust the setting manually using the "Position" menu command. See page 16 .
Has the computer been set for dual display?	If dual display has been activated in the Display Properties of the computer's Control Panel, the projector will only project about half of the image on the computer screen. To display the whole of the image on the computer screen, turn off the dual display setting. See your computer video driver documentation.
For computer images, has the correct resolution been selected?	Set the computer so that the signals that are output are compatible with this projector. See " List of Supported Monitor Displays " on page 63 .

■ Image colors are not right

Check	Remedy
Do the input signal settings match the signals from the connected device?	If a composite video or S-video source is connected to the projector, use the "Video Signal" menu command to select the video signal format. See "List of Supported Monitor Displays" on page 63 .
Has the image brightness been adjusted correctly?	Use the "Brightness" menu command to adjust the brightness. See page 32 .
Are the cables connected correctly?	Check that all of the cables required for projection are securely connected. See the <i>Quick Setup</i> sheet.
Has the image contrast been adjusted correctly?	Use the "Contrast" menu command to adjust the contrast. See page 32 .
Has the color been adjusted correctly?	Use the "Color Adjustment" menu command to adjust the color. See page 32 .
Have the color saturation and tint been adjusted correctly?	Use the "Color Saturation" and "Tint" menu commands to adjust the color and tint. See page 32 .

■ Images appear dark

Check	Remedy
Have the image brightness and luminance been adjusted correctly?	Use the "Brightness" and "Brightness Control" menu commands to adjust the brightness and luminance. See page 32 .
Has the image contrast been adjusted correctly?	Use the "Contrast" menu command to adjust the contrast. See page 32 .
Is the lamp due for replacement?	When the lamp is nearly due for replacement, the images will become darker and the color quality will become poorer. When this happens, the lamp should be replaced with a new one. See page 41 .

■ Nothing appears on the external monitor

Check	Remedy
Are images from a port other than the Computer port being projected?	The only images that can be displayed on an external monitor are those from the Computer port. You cannot output video equipment images to an external monitor. See page 30 .

■ Problems when projection starts

■ Power does not turn on

Check	Remedy
Have you pressed the [Power] button?	Press the [Power] button to turn the power on.
Are all of the indicators switched off?	The power cable is not connected correctly or power is not being supplied. Connect the power cable to the projector correctly. See the <i>Quick Setup</i> sheet. Check the circuit breaker to see if power is being supplied.
Do the indicators turn off and on when the power cable is touched?	There is probably a poor contact in the power cable, or the power cable may be defective. Reinsert the power cable. If this does not solve the problem, stop using the projector, disconnect the power cable from the wall outlet and contact Epson (see page 57).

■ Other problems

■ No sound can be heard or the sound is faint

Check	Remedy
Is the audio source connected correctly?	Check that the cable is connected to the Audio port.
Has the volume been adjusted to the minimum setting?	Adjust the volume so that sound can be heard. See page 17 .
Is A/V Mute mode active?	Press the [A/V Mute] button on the remote control to cancel the A/V mute function. See page 19 .
Is the lens cover still closed?	Open the lens cover.

■ The remote control does not work

Check	Remedy
Is the remote control light-emitting area pointing towards the front or back of the projector, or toward the screen?	Point the remote control towards the projector or the screen. The operating angle for the remote control is approximately $\pm 30^\circ$ horizontally and approximately $\pm 15^\circ$ vertically.
Is the remote control too far from the projector?	The operating range for the remote control is approximately 6 meters (20 feet).
Is direct sunlight or strong light from fluorescent lamps shining onto the projector's light-receiving area?	Set the projector up in a location where strong light will not shine onto the light-receiving area.
Are the batteries dead, or have the batteries been inserted correctly?	Insert new batteries, making sure that they are inserted correctly. See page 40 .
Has a remote control button been pressed for more than 30 seconds?	If any of the buttons on the remote control are pressed down for more than 30 seconds, the remote control stops sending signals (remote control's sleep mode). This prevents the batteries from being consumed due to something being placed on top of the remote control. When the button is released, normal remote control operation will resume.

Where To Get Help

Epson provides these technical support services:

Internet Support

Visit Epson's [support website](#) for solutions to common problems. You can download drivers and documentation, get FAQs and troubleshooting advice, or e-mail Epson with your questions.

Visit [Presenters Online](#) to access tips, templates, and training for developing successful presentations.

Speak to a Support Representative

To use the Epson PrivateLine Support service, call (800) 637-7661 and enter the PIN on the included Epson PrivateLine Support card. This is the fastest way of speaking to a live representative, and it's free. This service is available 6 AM to 6 PM, Pacific Time, Monday through Friday, for the duration of your warranty period.

You may also speak with a projector support specialist by dialing one of these numbers:

- ▶ U.S.: **(562) 276-4394**, 6 AM to 6 PM, Pacific Time, Monday through Friday.
- ▶ Canada: **(905) 709-3839**, 6 AM to 6 PM, Pacific Time, Monday through Friday.

Toll or long distance charges may apply.

Before you call for support, please have the following information ready:

- ▶ Product name (Epson PowerLite S4)
- ▶ Product serial number (located on the bottom of the projector)
- ▶ Proof of purchase (such as a store receipt) and date of purchase
- ▶ Computer or video configuration
- ▶ Description of the problem

Purchase Supplies and Accessories

You can purchase screens, carrying cases, or other accessories from an Epson authorized reseller. To find the nearest reseller, call 800-GO-EPSON (800-463-7766). Or you can purchase online at www.epsonstore.com (U.S. sales) or www.epson.ca (Canadian sales).

Appendix

Optional Accessories and Consumables

You can purchase screens, carrying cases, or other accessories from an Epson authorized reseller. For product information and to find the nearest authorized reseller, please call 800-GO-EPSON (800-463-7766) or browse our catalog of products at www.epson.com, select the product you are interested in, and click "Where to Buy." To purchase online, please visit the Epson Store at www.epsonstore.com (U.S. sales only). In Canada, please call 800-463-7766 for a reseller referral. This list of optional accessories is current as of January 2005. Details of accessories are subject to change without notice.

Part Number	Part Name
V13H010L36	Replacement lamp
V13H134A08	Air filter set (2)
ELPSC06	50" Portable screen (4:3 aspect ratio)
ELPSC07	60" Portable pop-up screen (4:3 aspect ratio)
ELPSC08	80" Portable pop-up screen (4:3 aspect ratio)
ELPSC09	83.6" Hanging pull-down screen (4:3 aspect ratio)
ELPMBUNI	Ceiling mount
ELPMBFCP	False ceiling plate
ELPMBSEC	Ceiling mount secure cable kit
ELPMBAPL	Suspension adapter
ELPMBACC	Adjustable Ceiling Channel
ELPSV01	S-Video cable
ELPKC19	Component video cable (9.8 feet/3 m) for mini D-Sub 15-pin/RCA×3
ELPDA01	Distribution amplifier
ELPKS35-S	Samsonite wheeled softcase
ELPKS43	Samsonite soft shoulder case for projector and notebook
ELPKS54	ATA molded hardshell case
V12H162020	ELPDC05 High resolution document imager
ELPSL01	Kensington security lock

Screen Size and Projection Distance

See the following table to choose the best position for your projected image. The values are only a guide.

4:3 Screen Size		Units: cm (in.)		Units: cm (ft.)		Units: cm (in.)	
		Projection Distance A		Offset B			
		Minimum (Zoom Adjustment Wide)	Maximum (Zoom Adjustment Tele)	Minimum (Zoom Adjustment Wide)	Maximum (Zoom Adjustment Tele)	Minimum (Zoom Adjustment Wide)	Maximum (Zoom Adjustment Tele)
30"	61 × 46 (24 × 18)	87 to 119 (2.9 to 3.9)		4 to -2 (1.7 to -0.9)			
40"	81 × 61 (32 × 24)	117 to 159 (3.8 to 5.2)		6 to -3 (2.3 to -1.1)			
50"	100 × 76 (39 × 30)	147 to 200 (4.8 to 6.6)		7 to -4 (2.8 to -1.4)			
60"	120 × 90 (47 × 35)	177 to 240 (5.8 to 7.9)		9 to -4 (3.4 to -1.7)			
80"	160 × 120 (63 × 47)	237 to 321 (7.8 to 10.5)		12 to -6 (4.5 to -2.3)			
100"	200 × 150 (79 × 59)	297 to 402 (9.7 to 13.2)		14 to -7 (5.7 to -2.9)			
120"	240 × 180 (94 × 71)	357 to 483 (11.7 to 15.9)		17 to -9 (6.8 to -3.4)			
150"	300 × 230 (118 × 91)	447 to 605 (14.7 to 19.8)		22 to -11 (8.5 to -4.3)			
200"	410 × 300 (161 × 118)	597 to 807 (19.6 to 26.5)		29 to -15 (11.3 to -5.7)			
300"	610 × 460 (240 × 181)	897 to 1212 (29.4 to 39.8)		43 to -22 (17.0 to -8.6)			

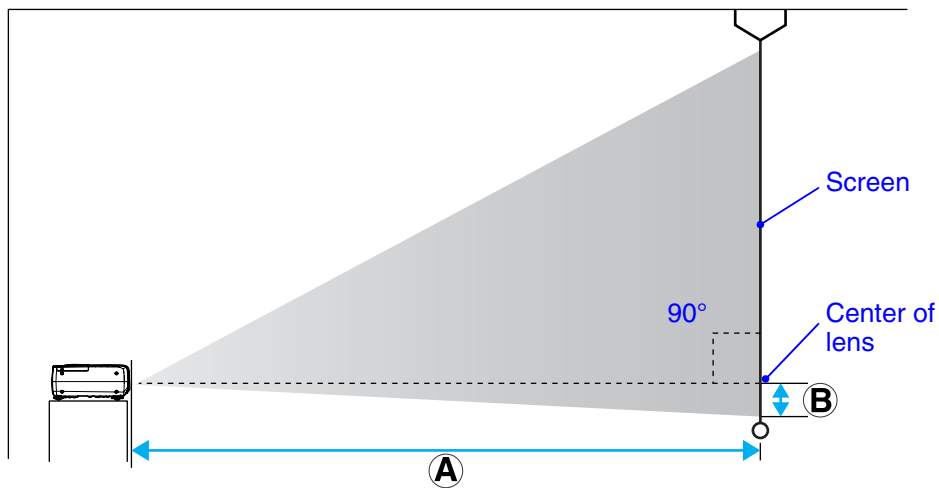

Glossary

The following is an explanation of some of the terms used in this guide which may be unfamiliar or which are not explained in the text of this guide itself. Further information can be obtained by referring to other commercially available publications.

Aspect ratio	The ratio between an image's length and its height. HDTV images have an aspect ratio of 16:9 and appear elongated. The aspect ratio for standard images is 4:3.
Color Temp.	The temperature of an object that is emitting light. If the color temperature is high, the colors take on a bluish tinge. If the color temperature is lower, the colors take on a reddish tinge.
Component video	Video signals which have the video brightness signals and color signals separated, in order to provide better image quality. In high-definition TV (HDTV), it refers to images which consist of three independent signals: Y (luminance signal), and Pb and Pr (color difference signals).
Composite video	Video signals which have the video brightness signals and color signals mixed together. The type of signals commonly used by household video equipment (NTSC, PAL and SECAM formats). The carrier signal Y (luminance signal) and chroma (color) signal which are contained in the color bar are overlapped to form a single signal.
Contrast	The relative brightness of the light and dark areas of an image can be increased or decreased in order to make text and graphics stand out more clearly, or to make them appear softer.
Dolby Digital	A sound format developed by Dolby Laboratories. Normal stereo is a 2-channel format which uses two speakers. Dolby Digital is a 6-channel (5.1-channel) system which adds to this a center speaker, two rear speakers, and a sub-woofer.
HDTV	An abbreviation for High-Definition Television. It refers to high-definition systems which satisfy the following conditions. Vertical resolution of 750p or 1125i or greater (p = progressive, i =interlaced) Screen aspect ratio of 16:9 Dolby Digital audio reception and playback (or output)
Interlaced	A method of image scanning whereby the image data is divided into fine horizontal lines which are displayed in sequence starting from left to right and then from the top to the bottom of the screen. The even-numbered lines and odd-numbered lines are displayed alternately.
Progressive	A method of image scanning whereby the image data from a single image is scanned sequentially from top to bottom to create a single image.
Refresh rate	The light-emitting element of a display maintains the same luminosity and color for an extremely short time. Because of this, the image must be scanned many times per second in order to refresh the light-emitting element. The number of refresh operations per second is called the "refresh rate", and is expressed in hertz (Hz).
SDTV	An abbreviation for Standard Definition Television. It refers to standard television systems which do not satisfy the conditions for High-Definition Television.
Security lock	A commercially available cable that can be attached to the projector to prevent theft. This projector is compatible with the Microsaver Security System manufactured by Kensington.
Squeeze mode	In this mode, wide-screen images in 16:9 mode are compressed in the horizontal direction so that they are stored on the recording medium as 4:3 images. When these images are played back by the projector in squeeze mode, they are restored to their original 16:9 format.
sRGB	An international standard for color intervals that was formulated so that colors which are reproduced by video equipment can be handled easily by computer operating systems (OS) and the Internet. If the connected source has an sRGB mode, set both the projector and the connected signal source to sRGB.

SVGA	A type of video signal with a resolution of 800 (horizontal) × 600 (vertical) dots which is used by IBM PC/AT-compatible computers.
S-Video	A video signal which has the luminance component and color component separated in order to provide better image quality. It refers to images which consist of two independent signals: Y (luminance signal), and C (color signal).
SXGA	A type of video signal with a resolution of 1280 (horizontal) × 1024 (vertical) dots which is used by IBM PC/AT-compatible computers.
Sync (synchronization)	The signals output from computers and RGB video equipment have a specific frequency. If the projector frequency does not match this frequency, the resulting images will not be of a good quality. The process of matching the phases of these signals (the relative position of the crests and troughs in the signal) is called "synchronization". If the signals are not synchronized, problems such as flickering, blurriness and horizontal interference can occur.
Tracking	The signals output from computers and RGB video equipment have a specific frequency. If the projector frequency does not match this frequency, the resulting images will not be of a good quality. The process of matching the frequency of these signals (the number of crests in the signal) is called "tracking". If tracking is not carried out correctly, wide vertical stripes will appear in the projected images.
USB	An abbreviation for Universal Serial Bus. USB is an interface for connecting personal computers to peripheral devices which only support relatively low data transmission speeds.
VGA	A type of video signal with a resolution of 640 (horizontal) × 480 (vertical) dots which is used by IBM PC/AT-compatible computers.
XGA	A type of video signal with a resolution of 1024 (horizontal) × 768 (vertical) dots which is used by IBM PC/AT-compatible computers.

List of ESC/VP21 Commands

Command List

When a power on command is sent to the projector, the power will turn on and the projector will change to warm-up mode. When the power has turned on, a colon ":" (3Ah) will be returned.

When the projector executes a command, it returns a ":" and waits for the next command to be sent.

If command processing terminates with an error, the projector outputs an error message and then returns the ":" code.

	Item	Command
Power ON/OFF	On	PWR ON
	Off	PWR OFF
Signal selection	Computer (Auto)	SOURCE 1F
	Computer1	SOURCE 11
	Component Video	SOURCE 14
	Video	SOURCE 41
	S-Video	SOURCE 42
A/V Mute ON/OFF	On	MUTE ON
	Off	MUTE OFF
A/V Mute Selection	Black	MSEL 00
	Blue	MSEL 01
	User's Logo	MSEL 02

* When issuing any of the above commands, tack a Carriage Return (CR) code (0Dh) on to the end.

Cable Layouts

■ USB connection

Connector shape: USB (type B)

<At the projector>

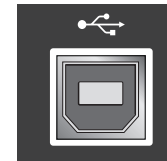

(type B)

<At the computer>

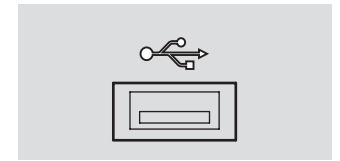

List of Supported Monitor Displays

The projection of some signals not listed in the table may still be possible. However, some functions may not be supported.

Computer/RGB Video

Signal	Refresh rate † (Hz)	Source Resolution (dots)	Projected Resolution* ² (dots)
VGA	60	640×480	800×600
VGAEGA		640×350	800×438
VESA	60/72/75/85,iMac* ¹	640×480	800×600
SVGA	56/60/72/75/85,iMac* ¹	800×600	800×600
XGA	60/70/75/85,iMac* ¹	1024×768	800×600
SXGA	70/75/85	1152×864	800×600
SXGA	60/75/85	1280×960	800×600
SXGA	60/75/85	1280×1024	750×600
MAC13"		640×480	800×600
MAC16"		832×624	800×600
MAC19"		1024×768	800×600
MAC19"	60	1024×768	800×600
MAC21"		1152×870	794×600
SDTV(625i)	50	720×576	800×600
SDTV(525i)	60	720×480	800×600
SDTV(525p)	60	640×480	800×600
HDTV(750p)	60	1280×720	800×450
HDTV(1125i)	60	1920×1080	800×450

*1: Connection is not possible if the equipment does not have a VGA output port.

*2: The value when zoom is set to maximum.

Component Video/RGB Video

Signal	Refresh rate † (Hz)	Resolution (dots)* ²	
		Aspect ratio 4:3	Aspect ratio 16:9
SDTV(525i) (D1)	60	800×600	800×450
SDTV (625i)	50	800×600	800×450
SDTV (525p) (D2)	60	800×600	800×450
HDTV(750p) 16:9 (D4)	60	800×600	800×450
HDTV (1125i) 16:9 (D3)	60	800×600	800×450

Composite Video/S-Video

Signal	Refresh rate † (Hz)	Resolution (dots)* ²	
		Aspect ratio 4:3	Aspect ratio 16:9
TV (NTSC)	60	800×600	800×450
TV (PAL, SECAM)	50	800×600	800×450

Specifications

Dimensions	15.3 (W) × 6.5 (H) × 13.9 (D) inches 327 (W) × 87 (H) × 247 (D) mm (not including feet)		
Display method	Polysilicon TFT active matrix		
Resolution	SVGA 480,000 pixels (800 (W) × 600 (H) dots) × 3		
Contrast ratio	500:1		
Brightness	1800 ANSI lumens (high brightness) 1500 ANSI lumens (low brightness)		
Focus adjustment	Manual		
Zoom adjustment	Electronic (approx. 1:1.35)		
Lamp	UHE lamp, 170 W		
Lamp life	2000 hours (high brightness) 3000 hours (low brightness)		
Speaker	1W monaural		
Power supply	100/240VAC 50/60Hz 2.2/1.0A		
Power consumption	Operating: 250W (100 to 120V area) 240W (220 to 240V area) Standby: 5W (100 to 120V area) 6W (220 to 240V area)		
Operating altitude	0 to 2,286 m (0 to 7,500 ft)		
Operating temperature	+5 to +35°C (41 to 95°F) (No condensation)		
Storage temperature	-10 to +60°C (14 to 140°F) (No condensation)		
Weight	Approx. 2.6 kg (5.7 lb)		
Fan noise	36 db (high brightness) 30 db (low brightness)		
Connectors	Computer	1	Mini D-Sub 15-pin (female) Blue
	S-Video	1	Mini DIN 4-pin
	Video	1	RCA pin jack
	Audio Input	1	RCA pin jack×2 (L,R)
	USB*	1	USB connector (B series)
	Monitor Out	1	Mini D-Sub 15-pin (female) Black

* The USB interface complies with the USB 1.1 standard. The USB connector is not guaranteed to operate correctly with all USB-compatible devices.



Lamp life results vary depending on mode selected, environmental conditions, and usage. Lamp brightness decreases over time. Turn off this product when not in use to prolong the life of the projector.



Pixelworks DNX™ ICs are used in this Projector.

Angle of tilt

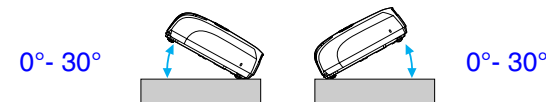

If you use the projector when it is tilted more than 30°, it could fall or be damaged.

Safety

USA

UL60950-1

Canada

CSA C22.2 No.60950-1

EU

The Low Voltage Directive
(73/23/EEC)

IEC/EN60950-1

EMC

USA

FCC Part 15B Class B (DoC)

Canada

ICES-003 Class B

European Community

EMC Directive
(89/336/EEC)

EN55022, Class B

EN55024

IEC/EN61000-3-2

IEC/EN61000-3-3

Australia/New Zealand

AS/NZS CISPR 22:2002 Class B

Dimensions

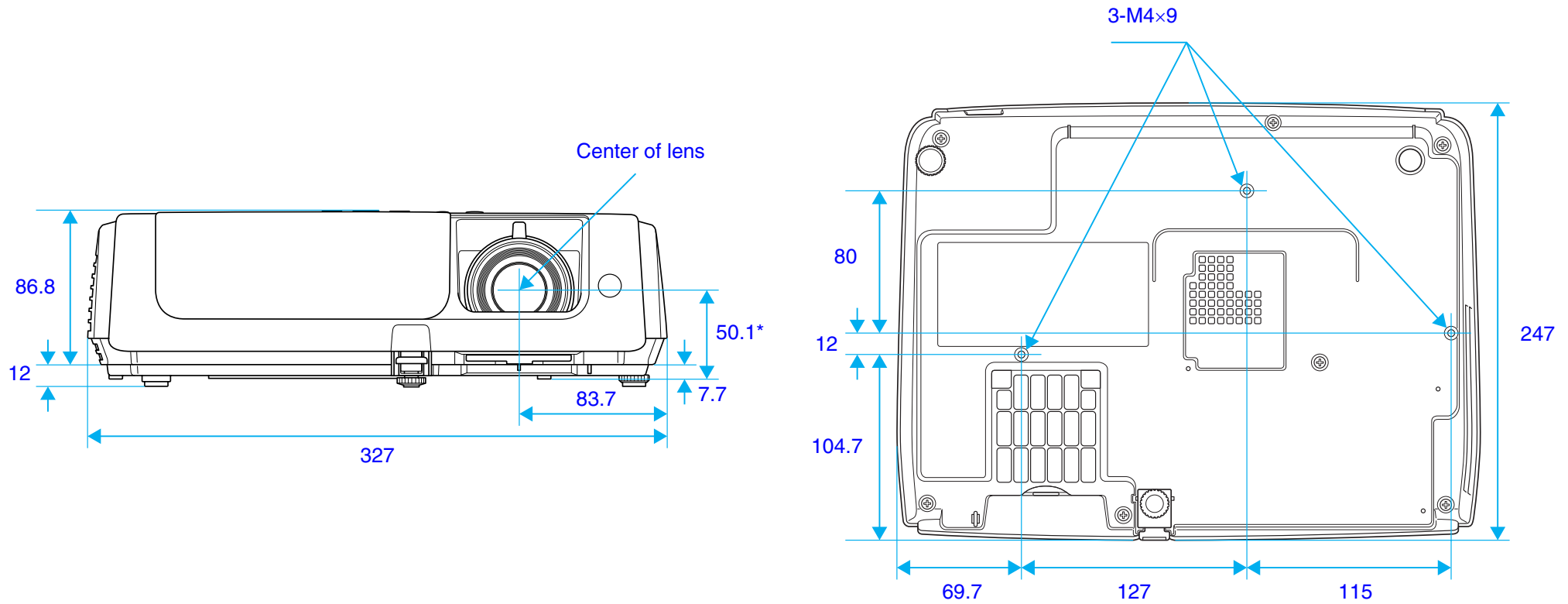

*Distance from center of lens to suspension bracket fixing point

Units: mm

Declaration of Conformity

DECLARATION of CONFORMITY

According to 47CFR, Part 2 and 15
Class B Personal Computers and Peripherals; and/or
CPU Boards and Power Supplies used with Class B
Personal Computers

We :EPSON AMERICA, INC.
Located at :3840 Kilroy Airport Way
MS: 3-13
Long Beach, CA 90806
Tel :562-290-5254

Declare under sole responsibility that the product identified herein, complies with 47CFR Part 2 and 15 of the FCC rules as a Class B digital device. Each product marketed, is identical to the representative unit tested and found to be compliant with the standards. Records maintained continue to reflect the equipment being produced can be expected to be within the variation accepted, due to quantity production and testing on a statistical basis as required by 47CFR 2.909. Operation is subject to the following two conditions: (1) this device may not cause harmful interference, and (2) this device must accept any interference received, including interference that may cause undesired operation.

Trade Name :EPSON
Type of Product :Projector
Model :EMP-S4

FCC Compliance Statement

This equipment has been tested and found to comply with the limits for a Class B digital device, pursuant to Part 15 of the FCC Rules. These limits are designed to provide reasonable protection against harmful interference in a residential installation. This equipment generates, uses, and can radiate radio frequency energy and, if not installed and used in accordance with the instructions, may cause harmful interference to radio or television reception. However, there is no guarantee that interference will not occur in a particular installation. If this equipment does cause interference to radio and television reception, which can be determined by turning the equipment off and on, the user is encouraged to try to correct the interference by one or more of the following measures.

- Reorient or relocate the receiving antenna.
- Increase the separation between the equipment and receiver.
- Connect the equipment into an outlet on a circuit different from that to which the receiver is connected.
- Consult the dealer or an experienced radio/TV technician for help.

WARNING

The connection of a non-shielded equipment interface cable to this equipment will invalidate the FCC Certification or Declaration of this device and may cause interference levels which exceed the limits established by the FCC for this equipment. It is the responsibility of the user to obtain and use a shielded equipment interface cable with this device. If this equipment has more than one interface connector, do not leave cables connected to unused interfaces. Changes or modifications not expressly approved by the manufacturer could void the user's authority to operate the equipment.

Important Safety Instructions

Please read the following important information about your projector.



- *Never look into the projector lens when the lamp is switched on as the bright light can damage your eyes. Never let children look into the lens when it is on.*
- *Never open any covers on the projector except the lamp cover. Dangerous electrical voltages inside the projector can cause severe injury. Except as specifically directed in the User's Guide supplied, do not attempt to service this product yourself. Refer all servicing to qualified service personnel.*
- *Keep the plastic bags for the projector, accessories and optional parts out of the reach of children. Children covering their heads with bags may result in death by suffocation. Be particularly careful around small children.*
- *When you replace the lamp, never touch the new bulb with your bare hands. The invisible residue left by the oil on your hands may be shorten the bulb life. Use a cloth or gloves to handle the new bulb.*

Follow these safety instructions when setting up and using the projector:

- ▶ Do not place the projector on an unstable cart, stand, or table.
- ▶ Do not stand on the projector or place heavy objects on it.
- ▶ Do not use the projector near water or sources of heat.
- ▶ Use attachments only as recommended.
- ▶ Use the type of power source indicated on the projector. If you are not sure of the power available, consult your dealer or local electricity company.
- ▶ Place the projector near a wall outlet where the plug can be easily unplugged.
- ▶ If the projector has a three-prong plug, insert the projector's three-pin grounding-type plug into a properly grounded outlet. If you have a two-prong outlet, contact an electrician to replace it.
- ▶ Take the following precautions when handling the plug. Failure to comply with these precautions could result in sparks or fire or electric shock.
 - ▶ Do not insert the plug into an outlet with dust present.
 - ▶ Insert the plug firmly into the outlet.
 - ▶ Do not overload wall outlets, extension cables or power strips. This can cause fire or electric shock.
 - ▶ Do not place the projector where the cable can be stepped on. It may result in fraying or damage to the plug.
 - ▶ Do not handle the plug with wet hands.
- ▶ Unplug the projector from the wall outlet before cleaning. Use a damp cloth for cleaning. Do not use liquid or aerosol cleaners.
- ▶ Do not block the slots and opening in the projector case. They provide ventilation and prevent the projector from overheating. Do not place the projector on a sofa, rug or other soft surface, or in a closed-in cabinet unless proper ventilation is provided.
- ▶ Never push objects of any kind through cabinet slots. Never spill liquid of any kind into the projector.
- ▶ Unplug the projector when it will not be used for extended periods.
- ▶ Do not place the projector and remote control on top of heat producing equipment or in a heated place, such as a car.
- ▶ Unplug the projector from the wall outlet and refer servicing to qualified service personnel under the following conditions:
 - ▶ When the power cable or plug is damaged or frayed
 - ▶ If liquid has been spilled into the projector, or it has been exposed to rain or water
 - ▶ If it does not operate normally when you follow the operating instructions, or if it exhibits a distinct change in performance, indicating a need for service
 - ▶ If it has been dropped or the housing has been damaged
- ▶ The internal projector components consist of many glass parts such as the lens and projection lamp.

- ▶ The lamp is fragile, and can easily break. If the lamp breaks, handle the projector with extreme care to avoid injury from broken glass, and contact Epson for repairs (see [page 57](#)). Particular care should be taken when the projector is installed to a ceiling, as small pieces of glass may fall down when the lamp cover is removed. Be very careful not to allow such pieces of glass to get into the eyes or mouth.
 - ▶ Material or paper may get stuck against the air filter underneath the projector while it is in use. Remove anything from underneath the projector that might get stuck against the air filter in this way.
 - ▶ Never try to remove the lamp immediately after use. Doing so will result in serious burns. Before removing the lamp, turn off the power supply and wait the time specified in the *User's Guide* to allow the lamp to cool completely.
 - ▶ A mercury lamp with high internal pressure is used as the projector's light source. Mercury lamps may make a loud noise when they break. Handle the lamp with extreme care while observing the following. If the following points are not observed, injury or poisoning may result.
 - ▶ Do not damage the lamp or subject it to any impacts.
 - ▶ Do not use the lamp after the lamp replacement period has elapsed. Once the lamp replacement period has elapsed, the possibility of the lamp breaking becomes greater. When the lamp replacement message appears, replace the lamp with a new one as soon as possible.
 - ▶ The gases inside mercury lamps contain mercury vapor. If the lamp breaks, immediately ventilate the room to prevent the gases that are released when the lamp breaks from being inhaled or coming into contact with the eyes or mouth.
 - ▶ Do not bring your face close to the projector while it is in use, in order to prevent the gases that are released when the lamp breaks from being inhaled or coming into contact with the eyes or mouth.
 - ▶ If the lamp breaks and needs to be replaced with a new lamp, contact Epson for information on replacement (see [page 57](#)). If the lamp breaks, pieces of broken glass may get scattered around inside the projector.
 - ▶ Particular care should be taken when the projector is installed to a ceiling, as small pieces of glass may fall down when the lamp cover is removed. If cleaning the projector or replacing the lamp yourself, be very careful not to allow such pieces of glass to get into the eyes or mouth. In addition, consult your local regulations regarding proper disposal and do not place in the trash.
 - ▶ If the lamp breaks and gas from the lamp or fragments of broken glass are inhaled or get into the eyes or mouth, or if any other ill effects are noticed, immediately seek medical advice.
 - ▶  This product includes a lamp component that contains mercury (Hg). Please consult your state and local regulations regarding disposal or recycling. Do not put in the trash.
 - ▶ If there is an electrical storm, do not touch the power plug, otherwise you may receive an electric shock.
 - ▶ If using a remote control that takes batteries, keep these batteries out of the reach of children. Batteries are choking hazards and can be very dangerous if swallowed.
 - ▶ If the batteries are swallowed, seek medical assistance immediately.
 - ▶ When replacing batteries, take the following precautions.
 - ▶ Replace the batteries as soon as they run out.
 - ▶ If the batteries leak, wipe away battery fluid with a soft cloth. If fluid gets on your hands, wash immediately.
 - ▶ Do not expose batteries to heat or flame.
 - ▶ Dispose of used batteries according to your local regulations.
 - ▶ Remove the batteries if you won't be using the projector for a long period of time.
- WARNING:** The cords included with this product contain chemicals, including lead, known to the State of California to cause birth defects or other reproductive harm. **Wash hands after handling.** (posted in accordance with Proposition 65 in Cal. Health & Safety Code § 25249.5 et seq)