

**Epson® PowerLite® Cinema 200+
Home Theater Projector**

User's Guide

Copyright Notice

All rights reserved. No part of this publication may be reproduced, stored in a retrieval system, or transmitted in any form or by any means, electronic, mechanical, photocopying, recording, or otherwise, without the prior written permission of Seiko Epson Corporation. The information contained herein is designed only for use with this Epson product. Epson is not responsible for any use of this information as applied to other products.

Neither Seiko Epson Corporation nor its affiliates shall be liable to the purchaser of this product or third parties for damages, losses, costs, or expenses incurred by purchaser or third parties as a result of: accident, misuse, or abuse of this product or unauthorized modifications, repairs, or alterations to this product, or (excluding the U.S.) failure to strictly comply with Seiko Epson Corporation's operating and maintenance instructions.

Seiko Epson Corporation shall not be liable for any damages or problems arising from the use of any options or any consumable products other than those designated as Original Epson Products or Epson Approved Products by Seiko Epson Corporation.

Epson is a registered trademark and the 3LCD logo is a trademark of Seiko Epson Corporation.

PrivateLine and PowerLite are registered trademarks, and Epson Extra Care, Epson Connection and Epson Store are service marks of Epson America, Inc.

Pixelworks, Digital Natural Expression, and DNX are trademarks of Pixelworks, Inc.

General Notice: Other product names used herein are for identification purposes only and may be trademarks of their respective owners. Epson disclaims any and all rights in those marks.

Contents

Introduction	7
Registration and Warranty	7
Projector Parts	8
Projector Controls	9
Optional Accessories	10
Using This Manual	10
Getting More Information	10
Setting Up the Projector	11
Choosing a Location	11
Connecting the Cables	13
Other Connections	14
Basic Operation	17
Turning On the Projector	17
Turning Off the Projector	18
Selecting the Image Source	18
Choosing the Aspect Ratio	19
Choosing the Color Mode	20
Displaying and Adjusting the Image	20
Focusing and Zooming the Image	21
Selecting the Input Signal Setting	21
Inverting and Mirroring the Image	22
Positioning the Image	22
Performing Keystone Correction	23
Locking the Projector	24

Making Adjustments	25
Using the Menu System	25
Changing How the Menu Displays	26
Adjusting the Image Quality	27
Brightness and Contrast Settings	27
Sharpness and Picture Quality Settings	28
Color Settings	29
Adjustments for Computer Images	30
Saving and Resetting Menu Selections	31
Creating Memory Settings	31
Resetting the Projector	32
Adjusting the Image Size	33
Setting Screen Display Options	34
Selecting Other Projector Options	34
Using Cinema Color Editor	37
Setting Up Your Computer	37
System Requirements	37
Installing the Software	38
Connecting to the Computer	39
Using Cinema Color Editor	40
Performing Remote Control Operations	42
Adjusting the Picture Quality	43
Adjusting the Color	44
Saving and Recalling Picture Settings	45
Managing Your Settings	47

Maintenance	49
Cleaning the Lens	49
Cleaning the Projector Case	49
Changing the Remote Control's Batteries	50
Cleaning and Replacing the Air Filter	51
Replacing the Lamp	52
Resetting the Lamp Usage Timer	53
Storing the Projector	54
Transporting the Projector	54
Problem Solving	55
What To Do When the Lights Flash	55
Checking the Projector Status	56
Solving Picture Problems	57
Solving Remote Control Problems	60
Where To Get Help	61
Specifications	63
General	63
Lamp	63
Remote Control	63
Dimensions	64
Electrical	64
Environmental	64
Safety	64
Compatible Video Formats	65
Aspect Ratio Settings	66

Notices	69
Important Safety Information	69
Remote Control Information	70
FCC Compliance Statement	71
Declaration of Conformity	72
Epson America, Inc. Limited Warranty	72
Index	75

Introduction

The Epson® PowerLite® Cinema 200+ projector lets you enjoy theater-quality images in the relaxing environment of your own home. Designed especially for home cinema use, it offers these outstanding features:

- 1280 × 720 resolution, 1000:1 contrast ratio, and up to 1500 lumens for incredibly rich, sharp images
- Pixelworks™ Digital Natural Expression™ (DNX™) technology to make fast-moving images appear clear and lifelike
- True 16:9 wide-format projection
- Flexible setup configurations, including front or rear projection and ceiling-mounted, with a screen trigger port to automatically raise and lower your projection screen
- Vertical and horizontal lens shift to position the image without distortion
- Adjustable color modes to quickly optimize viewing for different lighting environments and Cinema Color Editor software for making fine custom color adjustments
- Electronic zoom and focus for precise image adjustment
- Parental control using the projector's child lock

Registration and Warranty

The Epson PowerLite Cinema 200+ comes with a basic two-year carry-in warranty. For details, see page 72.

In addition, for customers who register their projector, Epson offers free Epson Extra CareSM Home Service. In the unlikely event of an equipment failure, you won't have to wait for your unit to be repaired. Instead, Epson will ship you a replacement unit anywhere in the United States or Canada, usually via overnight delivery. See your *Extra Care Home Service* brochure for details.

To register, simply fill out the registration card that came with your projector and mail it to Epson. Or you can register online at <http://www.epson.com/webreg>. Registering also lets you receive special updates on new accessories, products, and service.

Projector Parts

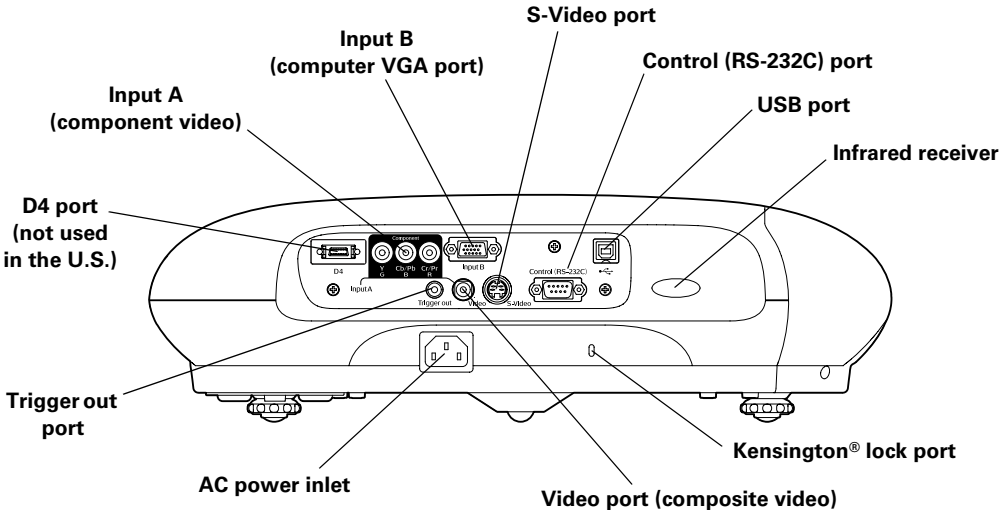
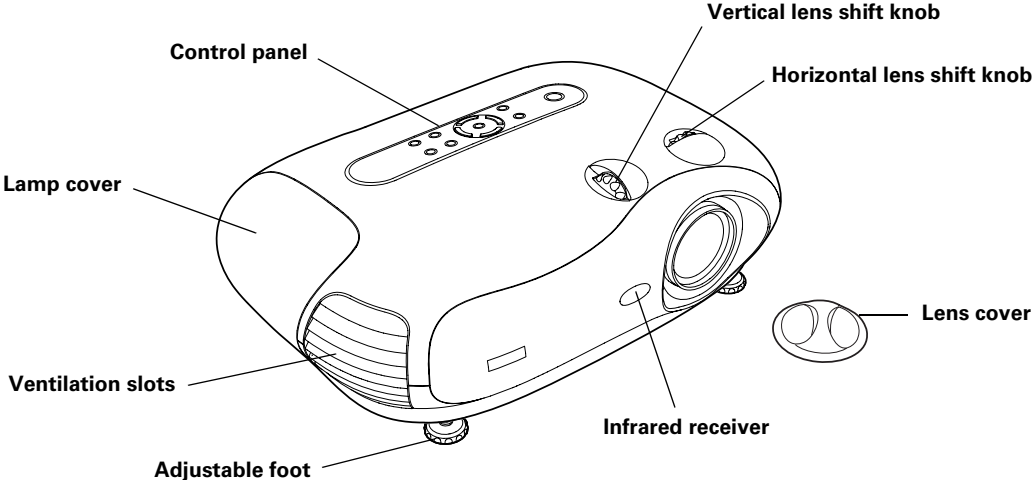

Projector Controls

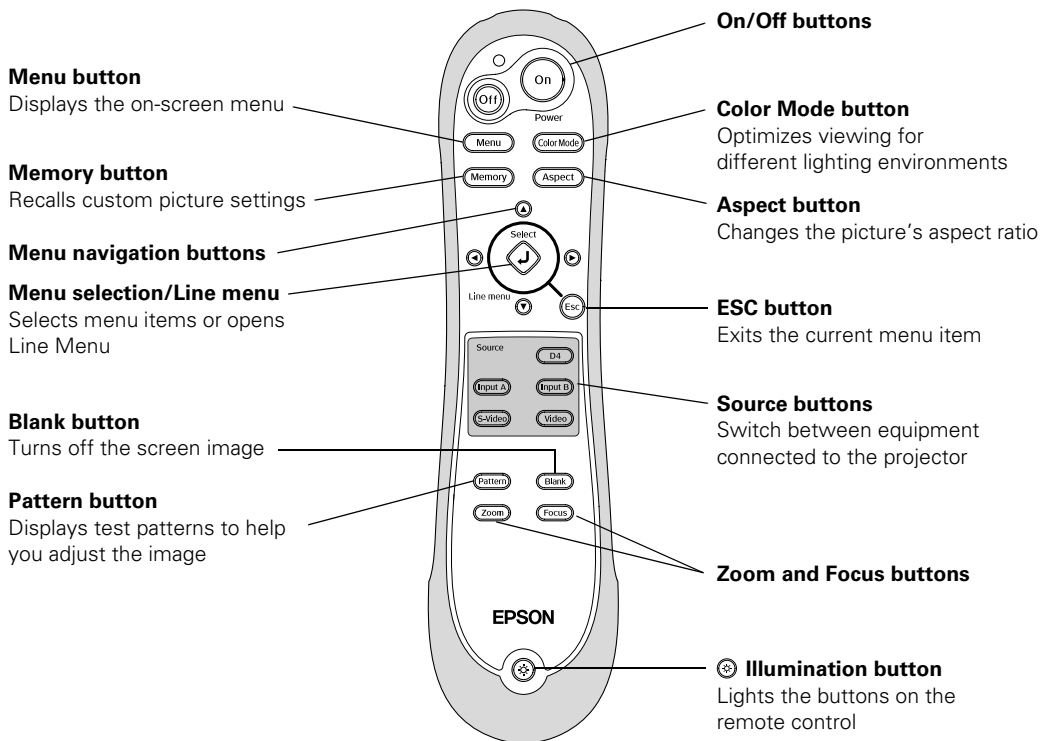
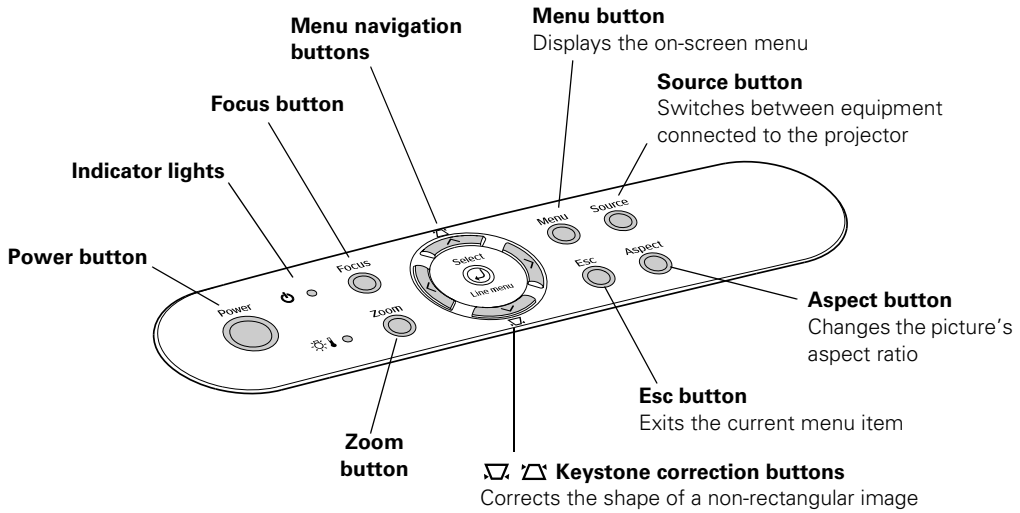

Optional Accessories

Epson provides the following optional accessories for the projector:

Product	Part number
Replacement lamp (ELPLP28)	V13H010L28
Air filter replacement (ELPAF04)	V13H134A04
Ceiling mount	ELPHB01
Kensington security lock	ELPSL01
S-Video cable	ELPSV01

You can purchase many of these accessories from your dealer, by calling Epson at (800) 873-7766, or by visiting the Epson StoreSM at www.epsonstore.com (U.S. sales only). In Canada, please call (800) 463-7766 for dealer referral.

Using This Manual

This book contains all the information you need to use the projector, in addition to basic setup and maintenance instructions, troubleshooting tips, important safety instructions, specifications, and warranty information.

Please follow these guidelines as you read through the manual:

Warnings: Must be followed carefully to avoid bodily injury.

Cautions: Must be observed to avoid damage to your equipment.

Notes: Contain important information about your projector.

Tips: Contain helpful projection tips.

Getting More Information

Need additional help? Take advantage of Epson's automated support services 24 hours a day at <http://support.epson.com>. Use this site to download FAQs or product information and e-mail your questions to Epson support.

If you need more help, you can use the Epson PrivateLine[®] Support service. Call (800) 637-7661 and enter the PIN on the PrivateLine support card that came with your projector.

Setting Up the Projector

Follow the instructions in this section to choose a location for the projector, connect the cables, and display and adjust the image.

Choosing a Location

You can install the projector for various viewing setups, as shown below.

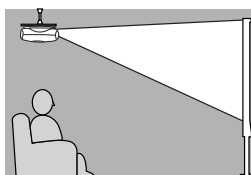

Front/Ceiling

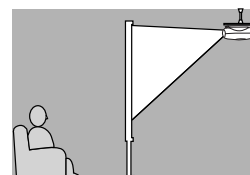

Rear/Ceiling

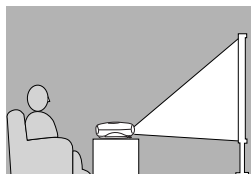

Front

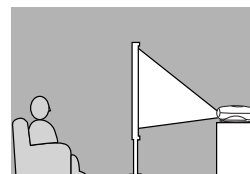

Rear

If you install the projector in a rear or overhead position, you'll need to flip and/or mirror the image by selecting the correct Projection option (see page 22). For overhead projection, you'll also need to install the optional ceiling mount bracket (see page 10 for ordering information).

For all setups, it's best to place the projector at a height where its lens is between the top and bottom of the screen. That way, you can keep the projector level and use the vertical lens shift knob to position the image. This produces the best-looking picture.

If you place the projector above or below screen level, you'll have to tilt it up or down to aim the image at the screen; this distorts the shape of the image, but you can correct its shape using the projector's Keystone function (see page 23).

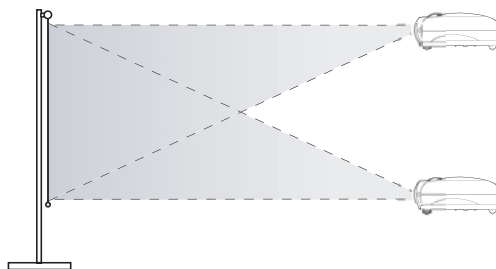

If you place the projector off to the side, aim it straight ahead (rather than at the center of the screen), then use the horizontal lens shift knob to center the image. Do not place the projector farther to the left or right than the edge of the screen, or you will not be able to project a square (or rectangular) image.

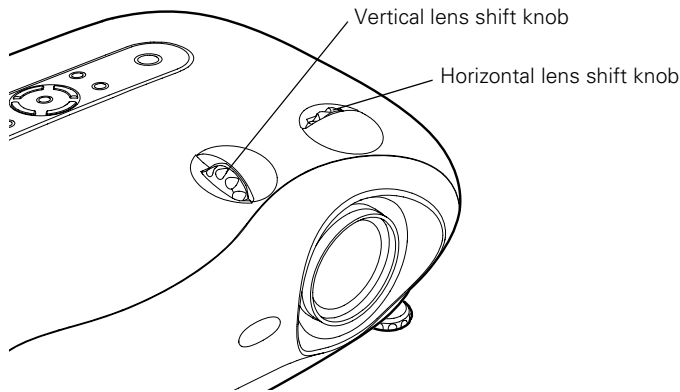

The maximum size of the image is determined by the distance from the projector's lens to the screen. Depending on how you use the Zoom and other settings, the actual size may be smaller. Use this table as a rough guide for projector placement:

Projection distance	Maximum image size (16:9)
2.9 feet	30 in. diagonal (26 × 14 in.)
3.9 feet	40 in. diagonal (34 × 19 in.)
5.9 feet	60 in. diagonal (52 × 29 in.)
7.9 feet	80 in. diagonal (69 × 39 in.)
9.9 feet	100 in. diagonal (87 × 49 in.)
19.9 feet	200 in. diagonal (174 × 98 in.)
29.9 feet	300 in. diagonal (261 × 147 in.)









Also keep these considerations in mind:

- Make sure there is plenty of space for ventilation around and under the projector. Do not set the projector on top of loose materials that could block the vents underneath.
- Make sure the projector is within 10 feet of a grounded electrical outlet or extension cord.

Connecting the Cables

You can connect the projector to any type of video equipment, such as a VCR, DVD player, HDTV tuner, cable or satellite box, video game console, camcorder, or digital camera. You can also connect it to a desktop or laptop PC or Apple® Macintosh system.

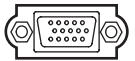
You can connect up to four pieces of equipment at the same time, as shown in this table:

Port name	Video equipment connection	Computer connection
Video 	Use a standard RCA video cable: 	—
S-Video 	Use a standard S-Video cable: 	—
Input A (Component) 	Use a standard component video cable (with RCA-style connectors):  Select YCbCr, YPbPr, or RGB-Video as the Input Signal setting (see page 21).	—
Input B 	—	Use a standard VGA computer cable: 

Note: For details on compatible video formats, see page 65.

Connect your video or computer equipment to these ports:

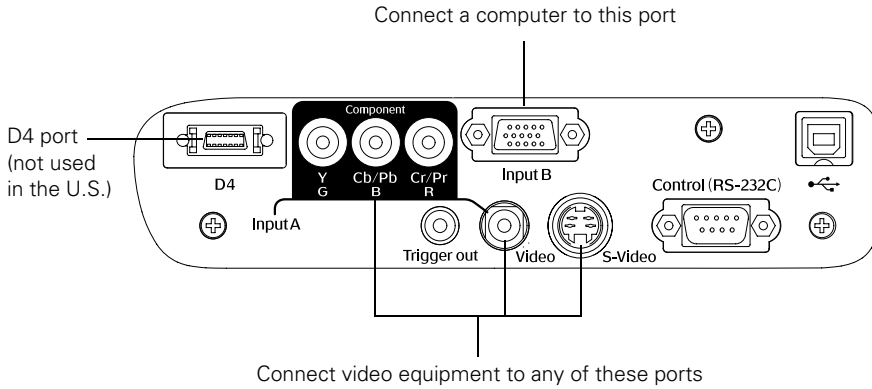

If you connect to the Input A port, be sure to select the correct Input Signal setting for your equipment, or the image may not display properly (see page 21).

Other Connections

■ Power cable

Plug the power cable into the projector and a grounded electrical outlet. The  power light on the projector's control panel turns orange when the projector is receiving power and is in standby mode.

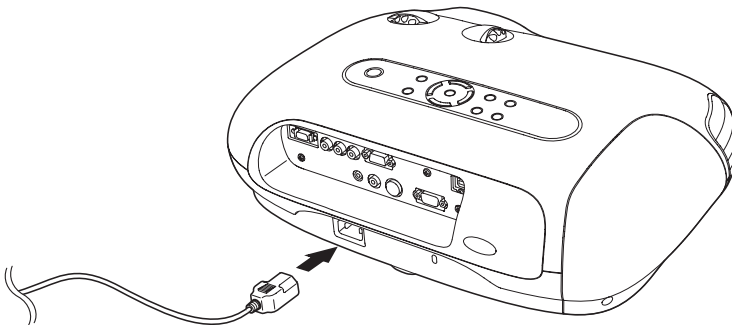

■ Control (RS-232C) and USB ports

Connect a computer to one of these ports to use the Cinema Color Editor software. See page 39 for details.

■ Trigger out port

This port outputs a 12-volt DC signal when the projector is turned on. This lets a central control system monitor whether the projector is on or off. It can also be used to raise or lower your projection screen automatically when the projector is in use.

Connect to it using a 3.5-mm mini jack cable, as shown.

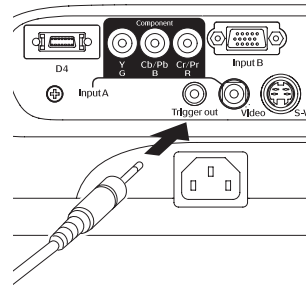

Basic Operation

Make sure the projector is set up as described on page 11, then follow the instructions below to turn it on and display an image.

Turning On the Projector

1. Remove the lens cap.

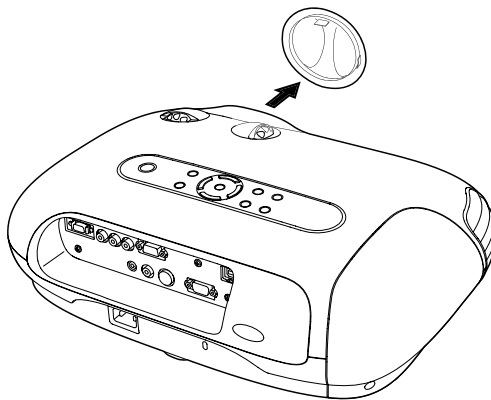

2. Press the **On** button on the remote control or press the **Power** button on the projector.

The projector takes about 30 seconds to warm up and display an image. If you don't see a picture, you may need to change the image source as described on the next page.

Note: If this is your first time using the remote control, make sure batteries are installed as described on page 50.

To keep children from turning on the projector, you can use the projector's Child Lock (see page 24).

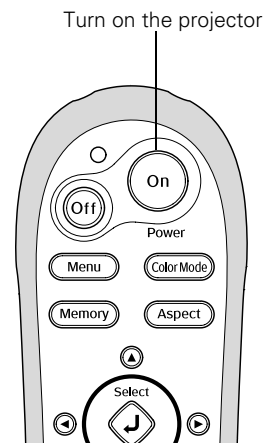

Turning Off the Projector

To turn off the projector, press the **Off** button on the remote control or press the **Power** button on the projector twice.

Let the projector cool while the  power light flashes red (about 30 seconds). Once the light stops flashing and stays on, it's safe to unplug the projector.

Caution: Turn the projector off when not in use. Continuous 24-hour-a-day use may reduce its overall life. Never unplug the projector without pressing the **Off** or **Power** button and letting it cool, or you could damage the projector and reduce lamp life.

Selecting the Image Source

The **Source** buttons let you switch between images output from different pieces of equipment connected to the projector (such as a DVD player, cable or satellite box, or video game console).

If you don't see the image you want, press the **Source** button that corresponds to the port to which your video source is connected.

For example:

To select the image source connected to the Video port . . .

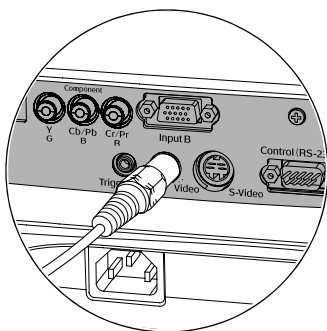

. . . press the **Video** button

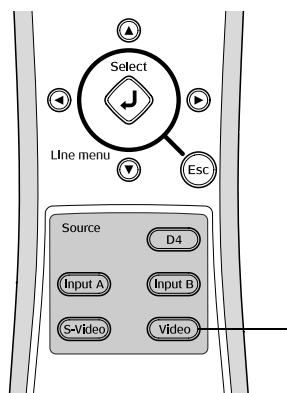

Note: If you're projecting in a darkened room, press the  button (located near the bottom of the remote control). This lights up all the keys.

To temporarily turn off the image and darken the screen (without turning off the projector), press the **Blank** button. Press the **Blank** button again to return to normal viewing.

Choosing the Aspect Ratio

Composite and S-Video signals are sized automatically to fit on your screen when Auto is selected as the Aspect setting. If you're viewing a component video signal, you may need to change the size of the image (or aspect ratio) by pressing the **Aspect** button on the remote control.

- If your video source is connected to the projector's Video or S-Video port, select **Auto** to automatically display your image in the correct size.
- If the **Auto** option is unavailable (when the source is connected to the Input A or B port), you'll most likely want to choose one of these settings:

Normal for standard TV broadcasts, computer images, or images having a 4:3 aspect ratio.

Zoom for images recorded in 16:9 (wide-screen) format.

4:3 image using Normal setting



16:9 image using Zoom setting



On occasion, you may wish to select one of these options:

- **Squeeze** if DVDs or video recordings are made in a compressed (or anamorphic) 16:9 format, sometimes called "Squeeze Mode."
- **Through** if your image is smaller than 1280×720 pixels and you want to display it at its original pixel size without resizing it to fit on the screen.
- **Squeeze Through** if your image is recorded in Squeeze Mode, is smaller than 1280×720 pixels, and you want to display it at its original pixel size.

Note: If you display a 4:3 image using the Zoom setting, the edges of the image will be cut off. You can use the Zoom Caption option to resize and reposition the image (see page 33).

For details on how the projector resizes the picture when you choose an Aspect setting, see page 66.

Choosing the Color Mode

You can change the Color Mode to automatically adjust the brightness, contrast, and color, letting you quickly optimize the projected image for various lighting environments. You can also select a different color mode for each input source, which is useful if you view different types of images from different sources. (For example, you might set the S-Video source to **Living Room** if that source is usually used for watching movies, and set the Video source to **Dynamic** for playing video games.)

Select the image source you want to adjust, then press the **Color Mode** button on the remote control. Choose from these settings:

- **Dynamic** for projecting in bright rooms; images retain their natural color.
- **Living Room** for projecting in rooms with subdued lighting; images retain their natural color. (Enables the Black and White Image Enhancer feature.)
- **Natural** for projecting in darkened rooms; increases contrast and makes flesh tones appear more natural.
- **Theatre** for projecting movies with dark scenes.
- **sRGB** for projecting computer images that conform to the sRGB color standard.

Note: You can fine-tune the color and other image quality settings using the projector's menu system (see page 27) or the Cinema Color Editor software (see page 37). You can also create your own customized groups of settings (see page 31).

Displaying and Adjusting the Image

Make sure your video or computer equipment is turned on, then turn on the projector as described on page 17. If necessary, select the correct source to display the image (see page 18).

Note: If you turn on the connected equipment before starting the projector, the projector automatically detects and displays the image. If you turn on the projector first, or have multiple pieces of connected equipment, you may have to select the source manually.

If an image does not appear, check the troubleshooting tips on page 57.

Focusing and Zooming the Image

To adjust the sharpness or size of the image:

Note: Before starting, you may want to display a test pattern to facilitate adjustment. Press the **Pattern** button on the remote control, then select **Cross-hatching**.

1. Press the **Focus** or **Zoom** button on the projector or remote control. You see this screen:
2. Use the ◀▶ arrow buttons to adjust the image sharpness or size.

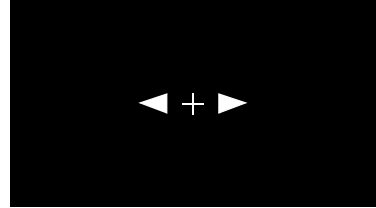

Note: If you use the remote control, you can stand close to the screen while focusing the image. This lets you adjust the picture more precisely.

3. Press **ESC** when done.

Selecting the Input Signal Setting

If you're using the projector's Input A port, select the correct setting for the type of video equipment you've connected to it:

1. Press the **Menu** button on the remote control.
2. Use the menu navigation buttons to open the **Setting** menu, then open the **Input Signal** menu and select **Input A**.
3. Choose from these options:
 - **YCbCr** for a video player that outputs an NTSC signal.
 - **YPbPr** for a video player that outputs an HDTV signal.
 - **RGB-Video** for a video player that outputs an RGB video signal.

Note: Check the label next to the port on your video equipment, if you're unsure of which setting to use.

Inverting and Mirroring the Image

If the image is displayed upside-down or backward, change the Projection option:

1. Press the **Menu** button on the remote control.
2. Use the menu navigation buttons to open the **Setting** menu, then open the **Screen** menu and select **Projection**.
3. Choose from these options:
 - **Front** if the projector is located in front of the screen (for example, on a table).
 - **Front/Ceiling** if the projector is located in front of the screen and mounted overhead.
 - **Rear** if the projector is located behind the screen.
 - **Rear/Ceiling** if the projector is located behind the screen and mounted overhead.

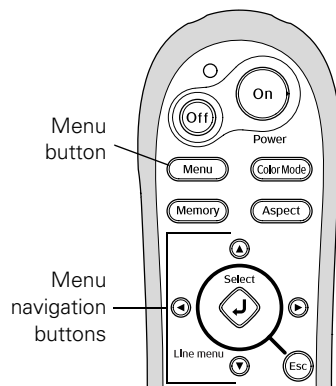

Positioning the Image



If the image is not centered on the screen, use the horizontal and vertical lens shift knobs to adjust its position.

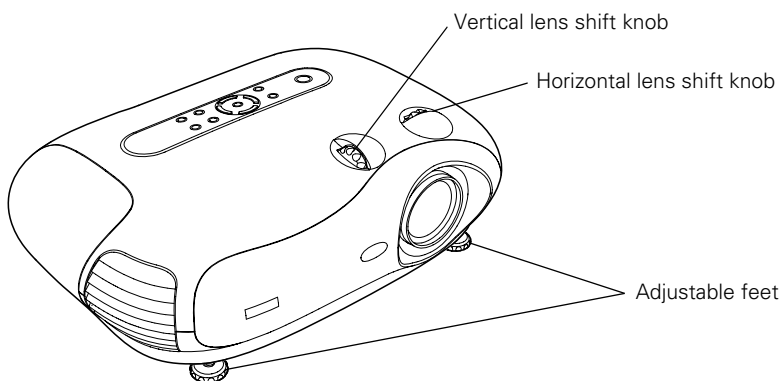

Note: You can display a test pattern to make adjustment easier. Press the **Pattern** button on the remote control, then select **Cross-hatching**.



If you still need to raise the height of the image after using the vertical lens shift knob, lift the front of the projector and rotate the adjustable feet until the image is positioned correctly. You can also use the feet to correct the angle of the image if it's tilted.

Performing Keystone Correction

If the projected image looks like  or , use the Keystone function to correct its shape.

Note: If the image is shaped like  or , the projector has been placed off to the side of the screen and angled toward it. Face the projector straight ahead (instead of at the center of the screen), then use the horizontal lens shift knob to center the image.

To perform keystone correction:

1. Press the **Menu** button on the remote control.
2. Use the menu navigation buttons to open the **Setting** menu, then open the **Screen** menu and select **Keystone**.
3. Use the ◀▶ arrow buttons to adjust the shape of the image.
4. Press the **Menu** button when done.

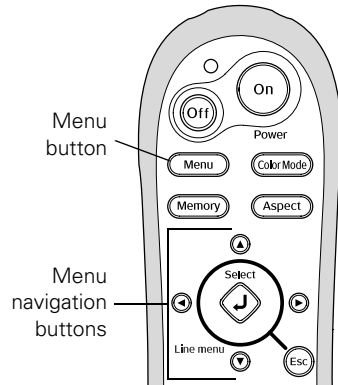

Locking the Projector

The projector includes various Lock settings to prevent the image from being accidentally changed once it's adjusted, and to keep children from turning on the projector without adult supervision.

To access the Lock settings, follow these steps:

1. Press the **Menu** button on the remote control.
2. Use the menu navigation buttons to open the **Setting** menu, then open the **Operation** menu and select **Lock Setting**.
3. Choose from these options:
 - **Focus Lock** to prevent the focus from being changed.
 - **Zoom Lock** to prevent the picture size from being changed.
 - **Child Lock** to make it more difficult to turn on the projector from the control panel (but does not affect operation of the remote control).

To turn on the projector, either use the remote control, or press and hold the projector's **Power** button for at least 3 seconds.

- **Key Lock** to disable all the buttons on the projector's control panel.

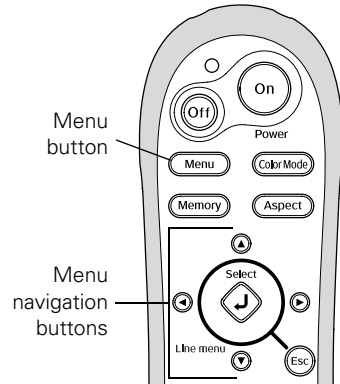

Making Adjustments

You can use the projector's on-screen menus to adjust the image quality, such as the brightness, contrast, sharpness, and color. You can also change how the menu display, select sleep mode settings, and control other projector features.

Using the Menu System

You can access the menu system either from the remote control or the projector's control panel to adjust any of the settings described in this chapter. You can also change the menu language and control how the menu display (see page 26).

1. Press the **Menu** button on the projector or remote control.

You see a screen similar to this one (the actual screen depends on the equipment you've connected):

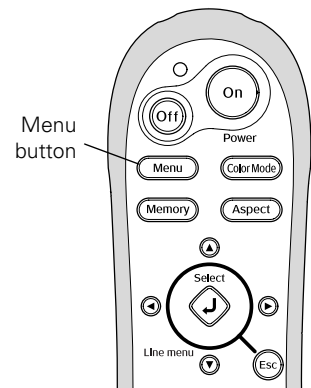
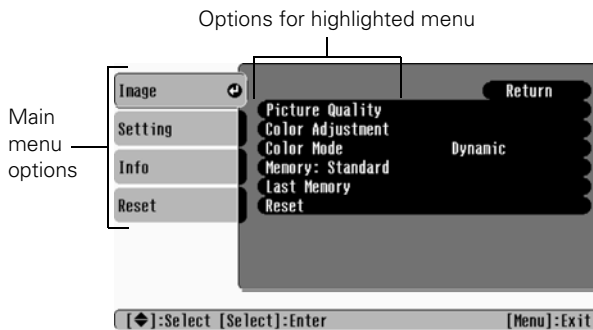

Note: If no equipment is connected to the projector, some options may not be available.

2. Use the arrow buttons to highlight the desired menu, then press **↵** to select it.
3. Use the arrow buttons to select a menu option.
4. Use the arrow buttons to change settings as needed. (You may have to press **↵** to confirm your choice.)
5. Press the **Esc** button to return to the previous menu or press the **Menu** button to exit.

Changing How the Menu Displays

Use these options to control how the menu displays on the screen.

■ Language

Setting → Language

Select from nine languages to use in the menu system.

■ Menu Position

Setting → On-Screen Display → Menu Position

Use the arrow buttons to choose a position on the screen for displaying the menu.

■ Navigation Bar

Setting → On-Screen Display → Navigation Bar

Select whether to display the navigation bar, which tells you which buttons to push.

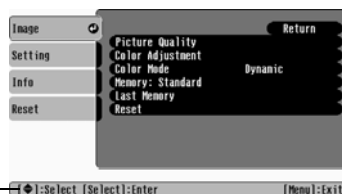

■ Menu Color

Setting → On-Screen Display → Menu Color

Select a color scheme for the menu displays.

Adjusting the Image Quality

Before fine-tuning the image using these adjustments, make sure you have already selected the best Color Mode for your picture and viewing environment, as described on page 20. The Color Mode adjusts various settings to approximately correct levels, simplifying your adjustment of the picture.

Most image quality settings are saved independently for each input source (Video, S-Video, Input A, Input B). After you finish adjusting the settings for one input source, be sure to switch to each additional input source you'll be using and make any necessary adjustments.

Brightness and Contrast Settings

The Brightness setting controls how much light is produced by the projector lamp. The other settings listed below control how the projector interprets the light and dark areas of the picture.

Adjust the Brightness first, then fine-tune the image with the other settings, as described.

■ Brightness

Image → Picture Quality → Brightness

Adjust the brightness so it's suitable for your viewing conditions. For example, if you're projecting in a brightly lit room or onto an especially large screen, you may need to increase the brightness. Decrease the brightness for dark rooms or small screens; this also reduces power consumption and fan noise, and helps to prolong the life of the lamp.

■ Setup Level

Setting → Advanced → Setup Level

For compatibility with most video equipment sold in the United States, set this option to 7.5%. This adjusts the threshold at which dark areas of the image are rendered black. Check your video equipment's specifications to be sure of the correct setting.

■ Input Level/Contrast

Image → Picture Quality → Input Adjustment → Input Level/Contrast

Adjust the Input Level to set the overall brightness of the image. Then adjust the contrast, as needed.

■ White Level/Black Level

Image → Picture Quality → Input Adjustment → White Level/Black Level

Adjust the White Level so that details in the brightest parts of the image are not washed out. Then adjust the Black Level so that shadow-level details are still visible in the darkest parts of the image.

Sharpness and Picture Quality Settings

If the image looks fuzzy, or it contains noise or flickering, you can use these settings to correct it.

■ Sharpness

Image → Picture Quality → Sharpness

Use this function to make lines and edges appear more distinct in the image.

■ Progressive

Setting → Advanced → Progressive

Leave this setting off when viewing images containing a lot of movement, such as videos and DVDs. If you notice horizontal lines or flickering when viewing still images (such as computer graphics or digital camera photos) or when pausing videos, turn the setting on.

■ Noise Reduction

Setting → Advanced → Noise Reduction

Leave this setting off unless you're viewing images from a weak signal with a lot of noise. Turning the setting on suppresses interference and makes images appear softer (available only if the image source is set to Video or S-Video).

Color Settings

If the image colors don't look correct, you can adjust them using these settings. Use the first three settings described below to make the most visible changes. If you only need to make slight adjustments, you can fine-tune the picture with the last two settings.

Note: You can also make color adjustments by attaching a PC or laptop to the projector and using the Cinema Color Editor software. See page 37.

■ Color Intensity

Image → Picture Quality → Color Intensity

Use this setting to adjust the color saturation of the image. (This setting is not available for computer images.)

■ Tint

Image → Picture Quality → Tint

Use this setting to shift the color balance between magenta and green. (This setting is not available for computer images.)

■ Color Temp.

Image → Color Adjustment → Color Temp. → Color Temp.

Use this setting to shift the color balance between red and blue.

Note: You can also access the Color Temp. setting by pressing the  button on the remote control to open an on-screen "line menu."

■ Flesh Tone

Image → Color Adjustment → Color Temp. → Flesh Tone

Use this setting to make fine adjustments to the magenta or green tint in the image, also useful for correcting black-and-white image tints.

Note: You can also access the Flesh Tone setting by pressing the  button on the remote control to open an on-screen "line menu."

■ RGB

Image → Color Adjustment → RGB

Use the RGB settings to fine-tune the color of the image. You can adjust the offset, gamma, and gain for each signal color (red, green, and blue). Use **Offset** to adjust darker shades, **Gamma** for intermediate shades, and **Gain** for the lightest shades.

Adjustments for Computer Images

In addition to the settings described above, you can adjust the Tracking and Sync settings for analog RGB computer images. Normally, these settings are adjusted automatically by the projector. If you notice that the image is blurry or contains dark vertical bands, you may need to adjust the settings yourself.

■ Auto Setup

Image → Auto Setup

Leave this setting on so that the projector automatically adjusts the tracking, sync, and position of the image.

■ Tracking

Image → Picture Quality → Tracking

Adjust the tracking to eliminate vertical bands. This is easiest to adjust when the image contains a lot of fine detail (such as black text on a white background).

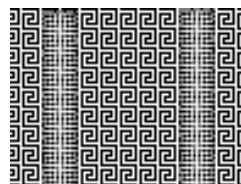

■ Sync.

Image → Picture Quality → Sync.

Adjust the synchronization to eliminate blurriness. For best results, make sure the tracking is properly adjusted first.

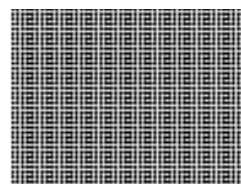

Saving and Resetting Menu Selections

Once you've adjusted the picture settings, you can save them as a group using the Memory feature. This lets you easily recall them and switch from one group of settings to another. You can save up to six groups of settings.

If necessary, you can use the projector's reset options to restore its factory-default (original) settings. You can clear all the settings or just the settings in a specific menu.

Creating Memory Settings

After adjusting the picture to your liking, you can save your settings as a group in the projector's memory. This stores all the image quality settings described on pages 27 through 30, plus the Aspect and Color Mode settings (pages 19 and 20).

1. Press the **Menu** button on the remote control.
2. Open the **Image** menu, then select **Memory: Standard**.
3. Select the memory name you want to use, then press the **Enter** button. Your settings are saved.

Note: Saved settings are indicated by a green highlight next to the memory name. If you select a name that is already in use, the existing contents will be erased and the new settings saved in their place. You can use Cinema Color Editor to customize the names of the settings (see page 47).

Once you have created one or more memory settings, you can easily recall them:

1. Press the **Memory** button on the remote control.
2. If you've used Cinema Color Editor to create advanced memory settings, choose **Standard** or **Advance** to select the type of setting you want to use.
3. Use the arrow buttons to select the desired setting, then press the **Enter** button.

Note: Select **Last Memory** if you want to return to the last standard memory setting that was used (available only if you've created advanced memory settings using Cinema Color Editor).

After a moment, the image appears on the screen using your selected setting.

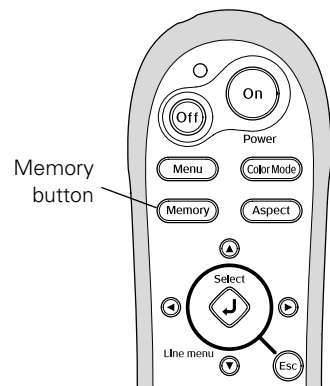

Resetting the Projector

If the image quality isn't what you expect, one or more settings may be adjusted improperly. If necessary, you can restore the projector to its factory-default (original) settings.

To restore the settings in a specific menu (such as the Image or Setting menu), open that menu, select **Reset**, and confirm as needed. The example below shows how to reset the Image menu:

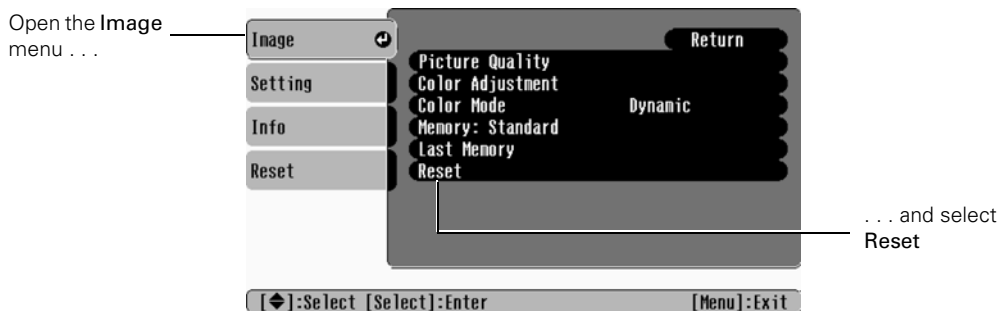

You can also reset the lamp usage timer, clear the memory settings, or restore all the projector settings to their original values. Follow these steps:

1. Press the **Menu** button on the remote control.
2. Open the **Reset** menu.
3. Do one of the following:
 - Select **Lamp-Hours Reset** to clear the lamp usage timer and reset it to zero (see page 53 for more information).
 - Select **Memory Reset** to clear any memory settings you created, as described on page 31.
 - Select **All Reset** to return almost all projector menus to their original settings.

Note: **All Reset** does not reset the lamp timer, menu language, Input Signal, and memory settings.

Adjusting the Image Size

Before adjusting any of these settings, make sure you have already selected an appropriate aspect ratio for the type of picture you're viewing (see page 19).

■ Output Scaling

Setting → Advanced → Output Scaling

For standard video formats, this setting lets you see the edges of the image that are not normally visible in the picture. Select **Larger** to view component video and RGB video at 100% size and composite video and S-Video formats at 95%. (**Normal** displays images at 92% size.)

For analog-RGB computer signals, select **Smaller** to display a slightly smaller image if you see interference at the top or bottom of the screen. (**Normal** displays images at 100%.)

■ Position

Setting → Screen → Position

Use the arrow buttons to fine-tune the position of the image on the screen.

■ Zoom Caption

Setting → Screen → Zoom Caption

Lets you adjust the shape and position of the image so that subtitles are visible (available only if the aspect ratio has been set to **Zoom**). Use **Vertical Size** to adjust the proportions of the image and **Zoom Position** to move the image up or down.

Setting Screen Display Options

■ Message

Setting → On-Screen Display → Message

Turn this setting off if you want to prevent on-screen messages from appearing (such as the no-signal message, or the text that appears when you switch between image sources or color modes).

■ Background Color

Setting → On-Screen Display → Background Color

Changes the screen that's used when the projector is not receiving a signal or when you press the **Blank** button to temporarily stop projection. Select **Blue**, instead of **Black**, or **Logo** (to display the EPSON logo on a black background).

■ Startup Screen

Setting → On-Screen Display → Startup Screen

Turn this setting off if you want to prevent the EPSON logo from appearing while the projector is warming up.

Selecting Other Projector Options

■ Keystone

Setting → Screen → Zoom Caption

Adjusts the shape of the image, if the left and right sides are not parallel after tilting the projector up or down (see page 23).

■ Projection

Setting → Screen → Projection

Mirrors and/or inverts the image for front, rear, or overhead projection.

■ Input Signal

Setting → Input Signal

Adjust these settings for the type of equipment connected to the projector:

Video Signal: Leave this setting on **Auto** so the projector can automatically interpret the picture (only affects images displayed through the Video or S-Video port).

Input A: Change this setting to match the type of equipment connected to the Input A port. If necessary, check the label on your equipment to match the setting.

D4: Change this setting to match the type of equipment connected to the D4 port (not used in the U.S.).

■ COM Port

Setting → Operation → COM Port

Select the type of port you've used to connect your PC or laptop for running the Cinema Color Editor software. Choose **USB** or **RS-232C**.

■ Trigger Out

Setting → Operation → Trigger Out

Turn on this setting if you want the **Trigger out** port to output a 12-volt signal while the projector is operating. You can use this to raise or lower your projection screen automatically. See page 15 for more information.

■ Sleep Mode

Setting → Operation → Sleep Mode

Sleep mode shuts the projector off automatically after 30 minutes when there is no video signal. Turn off this setting if you don't want the projector to enter sleep mode. Leave the setting on to conserve power and extend the life of the lamp.

■ Lock Setting

Setting → Operation → Lock Setting

Lets you lock the projector's focus and zoom settings. Also lets you lock the buttons on the projector's control panel or set a child lock that makes it more difficult to turn on the projector. See page 24 for details.

Using Cinema Color Editor

You can use the Cinema Color Editor software that came with your projector to adjust each color in the picture individually. You can also use the software in place of your remote control, letting you switch image sources, adjust the picture's aspect ratio, or change image quality settings right from your computer.

Setting Up Your Computer

Before using Cinema Color Editor, follow the instructions in this section to install the software and connect the projector to your computer.

System Requirements

You can install Cinema Color Editor on any Windows® or Macintosh system that meets these minimum requirements:

Windows	Macintosh
Microsoft® Windows NT® 4.0, 98SE, Me, 2000, or XP	Macintosh OS 8.6 through 9.x, OS X 10.1.5 or later
Pentium® MMX™ 166 MHz or better	Power Macintosh G3 300 MHz or better
10MB RAM	7MB RAM
2MB hard disk space	5MB hard disk space
XGA (1024 × 768) or better display adapter and monitor	

Installing the Software

Before you begin, make sure that the projector is not connected to your computer. Then follow these steps to install the software:

1. Insert the Cinema Color Editor CD-ROM in your computer.
2. Turn off any anti-virus software that may be running, then click **Continue**.
3. Read the license agreement and click **Agree**.

You see this screen:

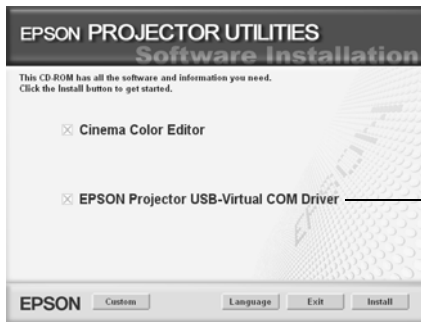

Not shown for Macintosh

4. Click **Install** and follow the on-screen instructions to perform the installation.

Caution: If you will be using a USB cable to connect to your computer, be sure to let the USB driver install as part of the installation sequence.

5. At the last screen, click **Exit**.
6. Restart your computer if prompted (Macintosh only).



Connecting to the Computer

Before you begin, make sure you have already installed all the software from the CD-ROM. Then follow these steps to connect the projector to your computer:

1. Connect the projector to your computer using either a USB cable (included with your projector) or an RS-232C (serial) cable.

Note: You can use any standard (commercially available) USB or serial cable.

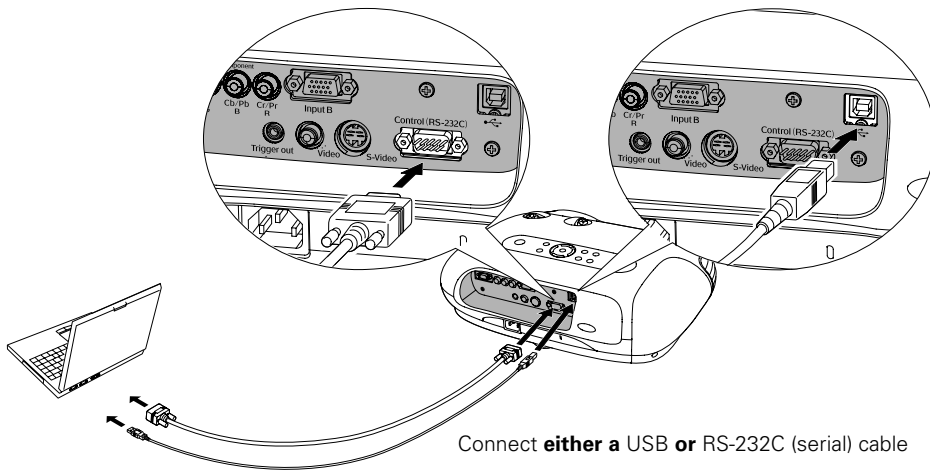

2. Turn on the projector.
3. Make sure the projector's COM Port setting is correct for the type of cable you're using (see page 35). Select either **USB** (if you're using a USB cable) or **RS-232C** (for a serial cable).
4. **Windows:** If you see a Found New Hardware or Add New Hardware screen, follow the instructions on the screen to finish installing the EPSON USB driver.

Caution: Make sure you have already installed all the software from the CD-ROM. If not, click **Cancel** and follow the instructions on page 38 first.

If you see a screen saying that the software has not passed Windows Logo testing, click **Continue anyway**.

Using Cinema Color Editor

To start Cinema Color Editor, follow these steps:

1. Make sure the projector is connected and turned on, as described on page 39.
2. **Windows:** Click **Start**, **Programs**, **EPSON Projector**, and double-click **Cinema Color Editor**.

Macintosh: From the **Applications** folder on your hard drive, open the **CCEditor** folder and double-click **Cinema Color Editor**.

You see this screen:

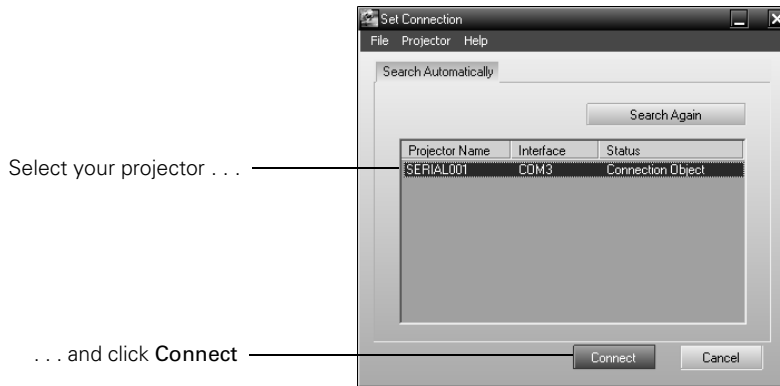

3. Select the name of the projector you want to adjust, then click **Connect**. You see this screen:

Now you can control the projector and adjust its settings as described on the following pages.

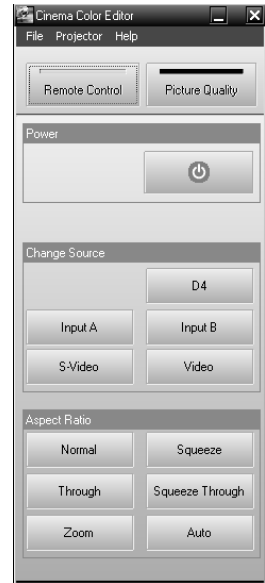

Performing Remote Control Operations

You can use Cinema Color Editor to change the image source, adjust the aspect ratio, or turn the power off—just as you would from the remote control.

1. Click the Remote Control button.

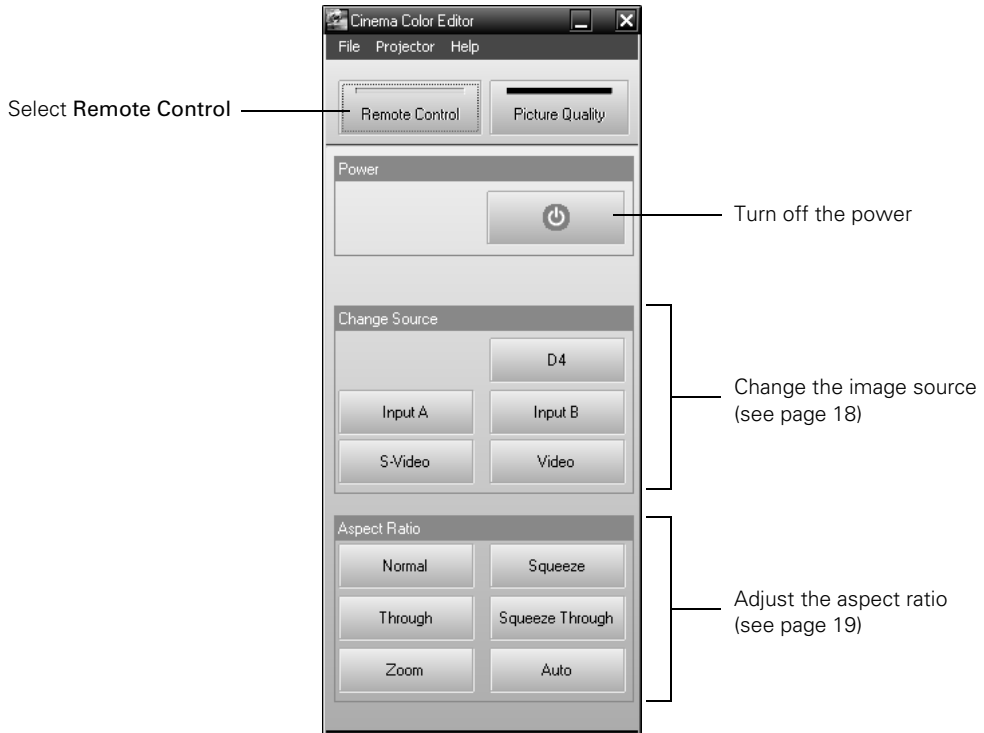

2. Click the buttons as necessary for the operations shown above.

Adjusting the Picture Quality

You can use Cinema Color Editor in place of the projector's menu system to adjust the image quality.

1. Click the Picture Quality button.

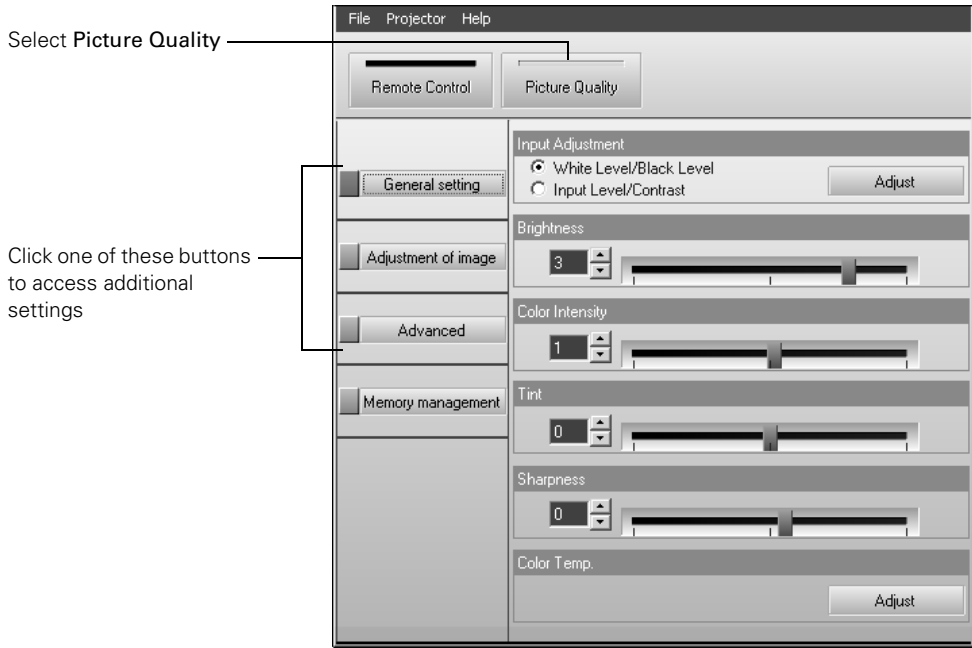

2. Click one of the buttons shown above to access additional settings. See the referenced page number below for details on using each setting:

Button	Available adjustments	Page reference
General setting	Input Adjustment Brightness Color Intensity Tint Sharpness Color Temp. and Flesh Tone	pages 27 and 28 page 27 page 29 page 29 page 28 page 29
Adjustment of image	Color Mode Color Adjustment	page 20 page 44
Advanced	Progressive Output Scaling Setup Level	page 28 page 33 page 27

Adjusting the Color

You can use the Cinema Color Editor to fine-tune the color of the image. If you select RGB as the color mode, you can adjust the offset, gamma, and gain for each signal color (red, green, and blue). If you select RGBCMY, you can adjust the hue and saturation for each of the six colors.

1. Click the Picture Quality button, then click Adjustment of image.

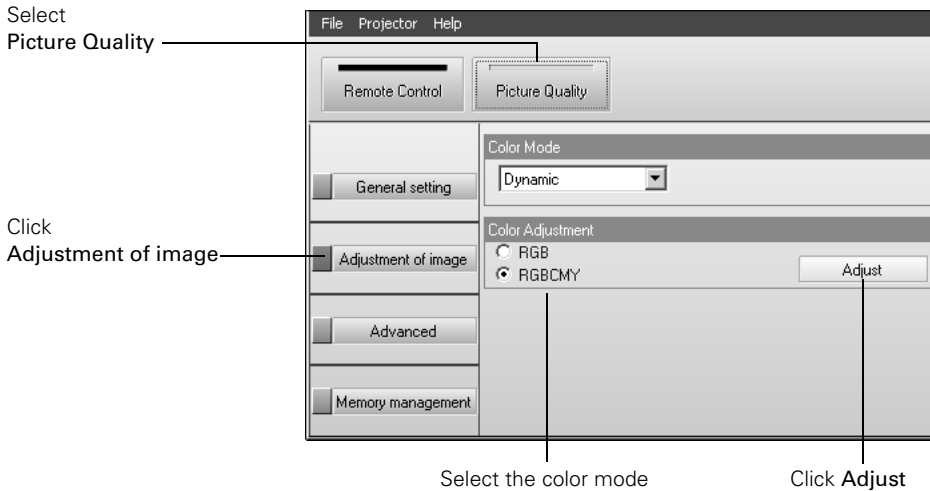

2. Select one of the following color modes, then click **Adjust**.

- **RGB:** Lets you adjust the offset, gamma, and gain for each signal color. Use **Offset** to adjust darker shades, **Gamma** for intermediate shades, and **Gain** for the lightest shades.
- **RGBCMY:** Lets you adjust the hue and saturation for each of six colors, as shown on the color palette below. After moving a slider bar, click **Apply**.

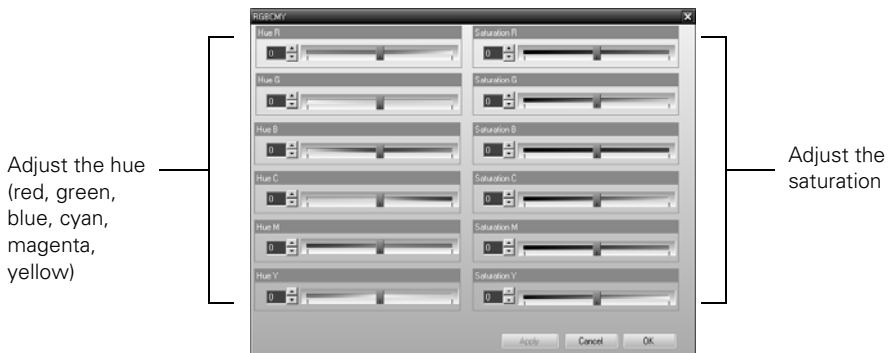

Saving and Recalling Picture Settings

Once you've adjusted the picture using Cinema Color Editor, you can save your settings in the projector's memory. Then you can use the remote control (or Cinema Color Editor) to easily recall them for future use.

To save your settings on the projector:

1. Select **Picture Quality**, then click **Memory management** and choose **Register**.

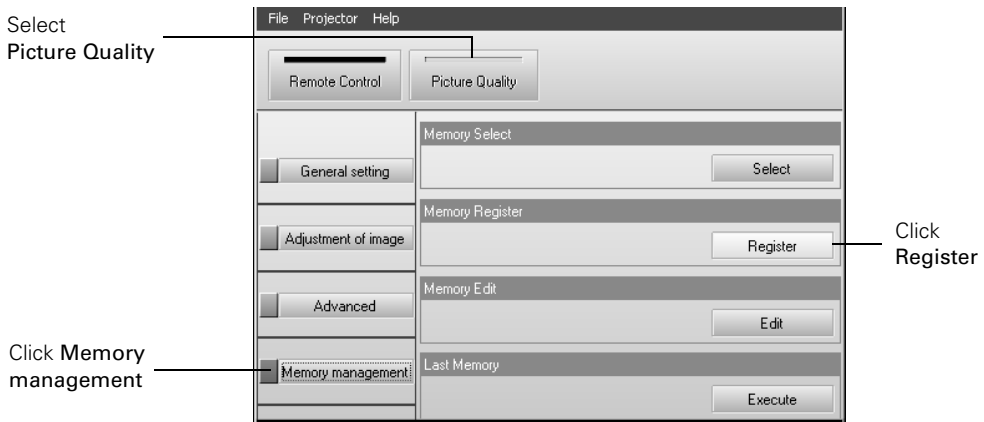

2. On the next screen, click the **Advance** tab to save your settings if you've made changes to the picture using the RGBCMY adjustments. Otherwise, click **Standard**.

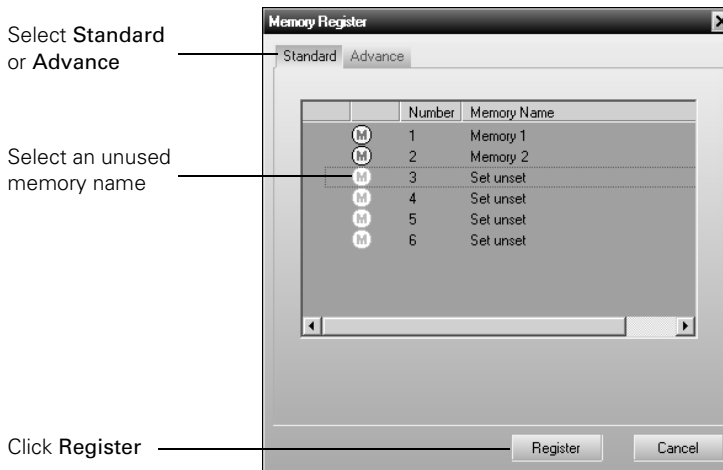

3. Select an unused memory name, then click **Register**. Your current settings are saved to the projector's memory.

To use a memory setting you've saved on the projector:

Access the projector's memory settings either from the remote control (see page 31) or by using Cinema Color Editor as follows:

1. Select **Picture Quality**, then click **Memory management** and choose **Select**.

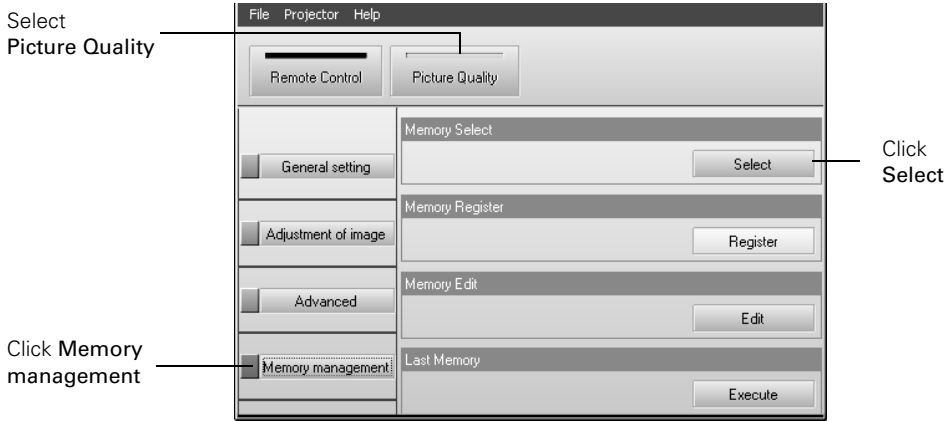

2. Click the tab where the setting you want to use is stored (**Standard** or **Advance**).

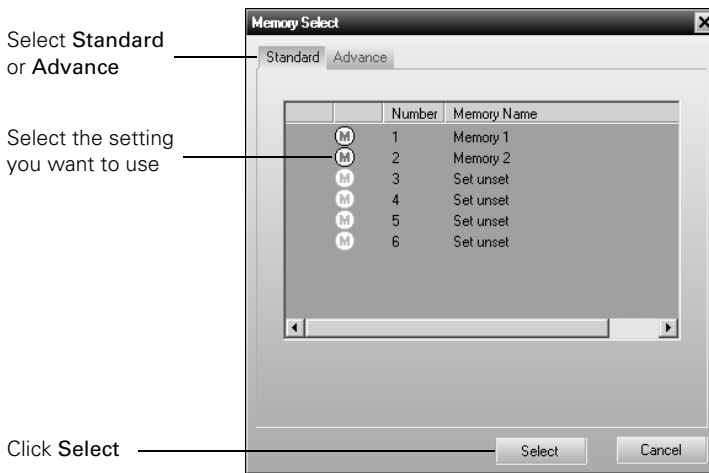

3. Select the desired memory setting, then click **Select**. After a moment, your image appears on the screen using the selected settings.

Managing Your Settings

In addition to your projector's twelve memory settings (six standard and six advanced), you can store any number of settings on your computer's hard drive. You can also use Cinema Color Editor to rename or delete memory settings stored on your projector.

To save or recall settings on your computer:

In Cinema Color Editor, open the **File** menu, then choose one of the following:

- **Save setting** to store the current Cinema Color Editor settings on your computer's hard drive.
- **Set from file** to adjust the picture from settings previously saved on your hard drive.

Note: You can also transfer settings directly between the projector's memory and your computer's hard drive using the **File Read** and **Save In File** buttons (shown in the figure below).

To rename a memory setting stored on the projector:

1. Select **Picture Quality**, then click **Memory management** and choose **Edit**.
2. Click the tab where your setting is stored (**Standard** or **Advance**), select the setting whose name you want to change, then click **Memory Name Change**.

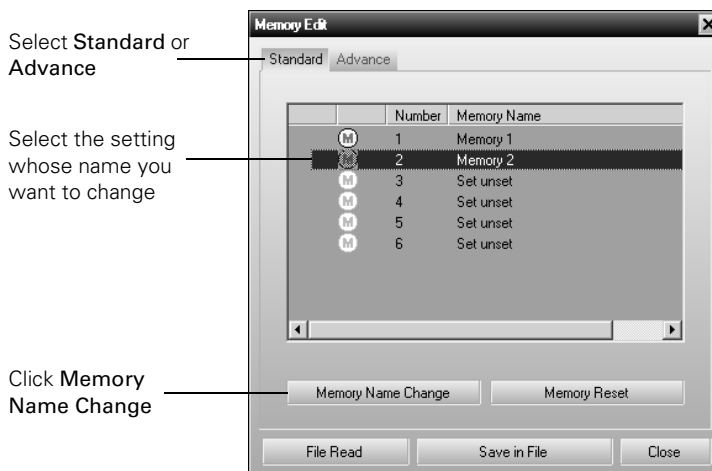

3. Type a name up to 12 characters long, then click **OK**.

To clear a memory setting stored on the projector:

1. Select **Picture Quality**, then click **Memory management** and choose **Edit**.
2. Select the setting you want to delete, then click **Memory Reset** and confirm the deletion.

Maintenance

Your projector needs little maintenance. All you need to do on a regular basis is keep the lens clean. You also need to clean the air filter periodically to prevent overheating.

Warning: Before you clean any part of the projector, turn it off and unplug the power cord. Never open any cover on the projector, except the lamp and filter covers. Dangerous electrical voltages in the projector can injure you severely. Do not try to service this product yourself, except as specifically explained in this *User's Guide*.

The only parts you should replace are the lamp and air filter. If another part needs replacing, contact your dealer or a qualified servicer.

Cleaning the Lens

Clean the lens whenever you notice dirt or dust on the surface.

Use a canister of compressed air to remove dust.

To remove dirt or smears, use lens-cleaning paper. If necessary, moisten a soft cloth with lens cleaner and gently wipe the lens surface.

Caution: Never rub the lens with abrasive materials.

Cleaning the Projector Case

Before you clean the case, turn off the projector and unplug the power cord.

To remove dirt or dust, wipe the case with a soft, dry, lint-free cloth.

To remove stubborn dirt or stains, moisten a soft cloth with water and a neutral detergent. Then wipe the case.

Caution: Never use wax, alcohol, benzene, thinner, or other chemical detergents. These can damage the case.

Changing the Remote Control's Batteries

The remote control uses two AA batteries. If you suspect they are weak, take the remote control to a darkened room and press the  illumination button. If the buttons on the remote control do not glow red, replace the batteries as described below.

Warning: Keep batteries away from children. If a battery is swallowed, contact your doctor immediately.

1. Release the tab and lift open the cover.

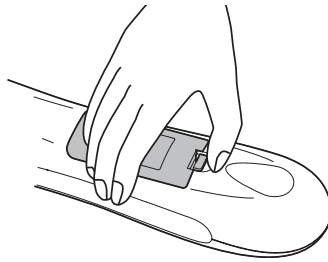

2. Remove the old batteries and insert new AA batteries as shown.

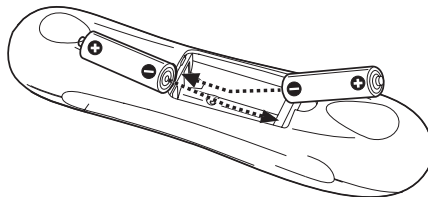

3. Replace the cover.

Cleaning and Replacing the Air Filter

Clean the air filter on the bottom of the projector after every 100 hours of use. If it's not cleaned periodically, it can become clogged with dust, preventing proper ventilation. This can cause overheating and damage the projector.

1. Turn off the projector and wait for the  power light to stop flashing.
2. Unplug the power cord and disconnect any cables.
3. Turn the projector over. Use a small vacuum cleaner designed for computers and other office equipment to clean the filter, as shown. If you don't have one, gently clean the filter using a very soft brush (such as a clean artist's paintbrush).

If the dirt is difficult to remove or the filter is broken, replace it. To purchase a filter, contact your dealer or call Epson at (800) 463-7766 to find an Epson authorized reseller or visit <http://www.epsonstore.com> (U.S. sales only). Request part number V13H134A04. In Canada, call (800) 463-7766 for dealer referral.

4. If you need to replace the filter, release the tab and lift the cover up.
5. Remove the old filter and replace it with a new one.

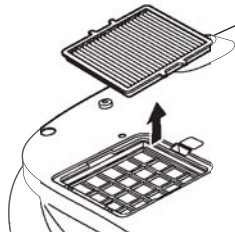
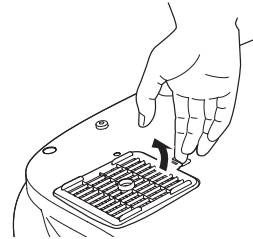
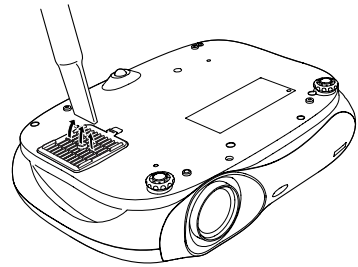

6. To replace the cover, insert the tabs and press down until the cover clicks into place.

Replacing the Lamp

The projection lamp lasts for up to 3000 hours (in low brightness mode) or 1700 hours (in high brightness mode). You can use the Info menu to check how long it's been in use (see page 56). It's time to replace the lamp when:

- The projected image gets darker or starts to deteriorate.
- The projector's warning light flashes red at half-second intervals.
- The message **Replace the lamp** appears on the screen when you start projecting.

Note: Lamp life results will vary depending on mode selected, environmental conditions, and usage.

To purchase a replacement lamp, contact your dealer or call Epson at (800) 463-7766 to find an Epson authorized reseller or visit <http://www.epsonstore.com> (U.S. sales only). Request part number V13H010L28. In Canada, call (800) 463-7766 for dealer referral.

Be sure to read the "Important Safety Information" on page 69 before replacing the lamp.

Warning: Let the lamp cool fully before replacing it. In the unlikely event that the lamp has broken, small glass fragments may be present and should be removed carefully to avoid injury.

The lamp component contains mercury. Please consult your state and local regulations regarding proper disposal or recycling, and do not place in the trash.

Caution: Never touch the lamp with your bare hands; the invisible residue left by the oil on your hands may shorten the lamp life. Use a cloth or glove to handle the new lamp.

Follow these steps to replace the lamp:

1. Turn off the projector and wait for the  power light to stop flashing.
2. Unplug the power cord and any cables.
3. If the projector has been on, let it cool for about an hour.
4. Loosen the two screws securing the lamp cover (they don't come all the way out), and then remove the cover.

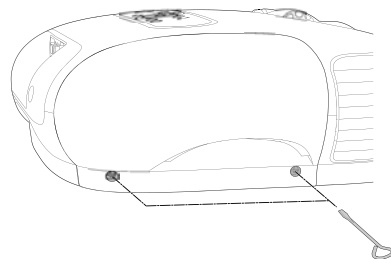
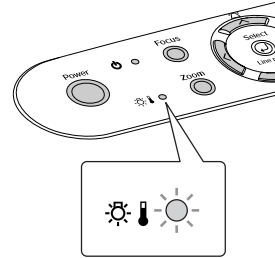

5. Loosen the two screws securing the lamp.

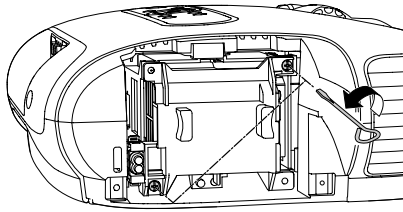

6. Grasp the lamp as shown and pull it straight out.

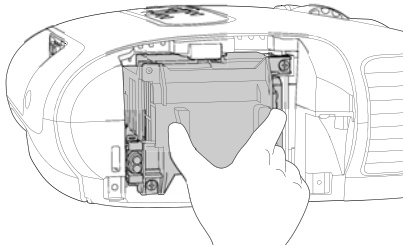

7. Gently insert the new lamp and tighten its screws.

Caution: Don't touch the glass portion of the lamp assembly. Touching the glass could result in premature lamp failure.

8. Replace the cover and tighten its screws. (The projector won't work if the lamp cover is open or loose.)
9. Reset the lamp usage timer, as described in the next section.

Resetting the Lamp Usage Timer

After replacing the lamp, follow these steps to reset the lamp usage timer:

1. Press the **Menu** button on the projector or remote control.
2. Use the menu navigation buttons to open the **Reset** menu, then select **Lamp-Hours Reset**.
3. When you see a confirmation prompt, highlight **Yes** and press the **↵** button.
4. When you're finished, press the **Menu** button to exit.

The lamp usage timer doesn't register until you've used the lamp for at least 10 hours.

Storing the Projector

If you need to store the projector for an extended time, do the following:

1. Make sure the temperature and humidity of the storage area are within the recommended range for the projector (14 to 140 °F [-10 to 60 °C] and 10 to 90% relative humidity).
2. Attach the lens cover and retract the feet.
3. Remove the batteries from the remote control.
4. Pack the projector in its original packaging or equivalent.

Transporting the Projector

Note: Epson shall not be liable for any damages incurred during transportation.

The projector contains many glass and precision parts. If you need to transport it, follow these guidelines to prevent damage:

- When shipping the projector for repairs, use the original packaging material if possible. If you do not have the original packaging, use equivalent materials. Be sure the carrier is capable of transporting fragile equipment and is aware that the projector is fragile.
- When you are hand-carrying the projector, grip the recessed handles on the sides.

Problem Solving

This section explains how to interpret the projector's status lights, solve problems with the picture and remote control, and contact technical support.

What To Do When the Lights Flash

The lights on top of the projector indicate the projector's status and let you know when a problem occurs.

If the projector isn't working correctly, first turn it off, let it cool, and unplug it. Then plug the power cord back in and turn on the projector. If this doesn't solve the problem, check the status lights on top of the projector.

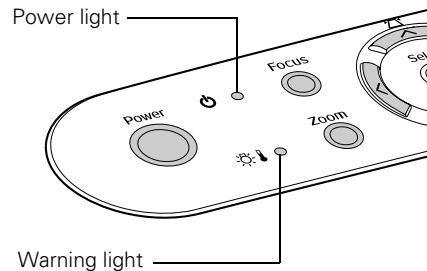

The power light is orange.

The projector is in standby mode. Unplug it or press the **Power** button to turn it on.

The power light is flashing green.

The projector is warming up. Wait for the picture to appear.

The power light is flashing orange and you can't turn on the projector.

The lamp is cooling down. Wait until the light stops flashing, then press the **Power** button.

The power light does not come on.

Make sure the power cord is connected securely both at the power outlet and the projector.

The  warning light is flashing orange.

High-speed cooling is in progress. If the projector gets too hot again, projection stops automatically. Make sure there is plenty of space around and under the projector for ventilation. Clean or replace the air filter if necessary (see page 51).

The  warning light is red.

The projector is too hot, which turns off the lamp automatically. Let it cool for five minutes, then turn it back on. Make sure there is plenty of space around and under the projector for ventilation. Also, clean or replace the filter if necessary (see page 51).

The  warning light is flashing red at one-second intervals.

- The lamp cover may be loose or off. Make sure it's securely fastened (see page 52).
- There is an internal problem. Turn off the projector and, when the  power light stops flashing, unplug it. Contact your dealer.

The  warning light is flashing red at half-second intervals.

The lamp needs to be replaced (see page 52).

Checking the Projector Status

You can use the Info menu to view information about the current display settings and how long the projection lamp has been in use. To access the Info menu:

1. Press the **Menu** button on the projector or remote control.
2. Use the menu navigation buttons to open the Info menu. The following information appears:
 - Lamp Hours
 - Source
 - Input Signal
 - Resolution
 - Video Signal
 - Refresh Rate
 - Sync Info



Note: The information displayed depends on the currently selected image source. The Lamp Hours shows 0H until you've used the lamp for at least 10 hours.

Solving Picture Problems

You cannot turn on the projector.

- Make sure the power cord is connected, then wait a moment for the  power light to turn orange before pressing the **Power** button.
- If you've set the **Key Lock**, the control panel buttons are disabled; you must use the remote control to turn on the projector (see page 24).
- If you've set the **Child Lock**, use the remote control or press and hold the **Power** button on the projector for at least 3 seconds to turn it on (see page 24).

No picture appears on the screen or you see the message No Signal displayed.

- Press the **Source** button on the projector or one of the **Source** buttons on the remote control to select the correct input source. Allow a few seconds for the projector to sync up after pressing the button.
- Press the **Blank** button on the remote control to make sure the picture hasn't been turned off temporarily.
- Check that the  power light is green, not flashing, and the lens cover is off.
- The projector may be in standby (or sleep) mode. If the  power light is orange, press the **Power** button to turn the projector back on.
- Make sure your video equipment is turned on.
- Make sure your cables are connected correctly (see page 13).

You're using a computer and no picture appears on the screen.

If you're using a PC:

- Press the function key that lets you display on an external monitor. It's often labeled with an icon such as , but it may also be labeled **CRT/LCD**. You may have to hold down the **Fn** key while pressing it. Check your laptop's manual or online help.

On most systems, the  key lets you toggle between the LCD screen and the projector, or display on both at the same time. Allow a few seconds for the projector to sync up after pressing it.

- If the function key doesn't let you display simultaneously on both screens, you might need to use the **Display** utility in the **Control Panel** to make sure that both the LCD screen and external monitor port are enabled. From the **Control Panel**, open the **Display**

utility. In the Display Properties dialog box, click the **Settings** tab, then click **Advanced**. The method for adjusting the setting varies from computer to computer; you may need to click a **Monitor** tab, then make sure the external Monitor port is set as your primary display or enabled. See your computer manual or online help for details.

If you're using a Macintosh with OS X:

1. Select **System Preferences** from the Apple menu and click **Displays**.
2. Click **Detect Displays**.
3. To display the entire desktop on both your projector screen and LCD screen, click the **Arrange** tab. (If you don't see this tab, make sure it isn't hidden by another window.)
4. Click **Mirror Displays** in the lower corner of the screen. One of the monitor icons automatically moves on top of the other.

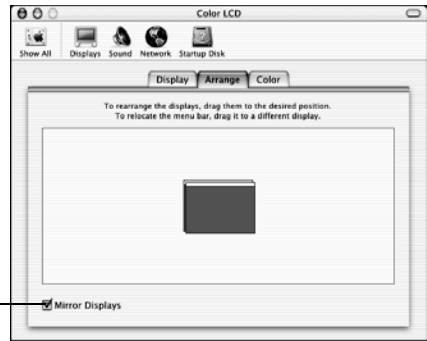

Click here

If you're using a Macintosh with OS 9.x or earlier:

1. From the Apple menu, select **Control Panels**, then click **Monitors and Sound**.
2. Click the **Arrange** icon, and then drag one monitor icon on top of the other.

If the **Arrange** option isn't available, you may need to select one of the Simulscan resolutions. Click the **Monitor** icon and then select a Simulscan resolution from the **Resolution** box. (Allow a few seconds for the projector to sync up.)

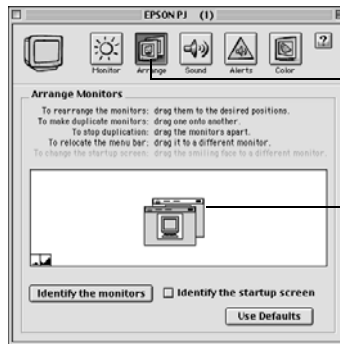

Click here

Drag one monitor icon on top of the other







The picture is upside-down or reversed.

Change the **Projection** setting in the menu system (see page 34).

Only part of the picture is displayed, or the picture is distorted.

- Press the **Aspect** button to select a different aspect ratio (see page 19).
- If the **Aspect** is set to **Zoom**, you may need to use the **Zoom Caption** option to see the top or bottom section of the screen (so that subtitles are visible). See page 33.
- Check the **Output Scaling** to make sure it's adjusted correctly (see page 33).
- Use the **Position** setting to reposition the image on the screen (see page 33).
- If you've connected a computer and you see only half the image, make sure the computer's **Dual Display** setting is turned off.

The picture isn't rectangular.

- If the image looks like  or , the projector has been placed off to one side of the screen and angled toward it. Face the projector straight ahead (instead of at the center of the screen), then use the horizontal lens shift knob to center the image (see page 22).
- If the image looks like  or , use the remote control to access the **Keystone** function to correct its shape (see page 23). Or press the  and  buttons on the projector's control panel.

Note: You won't have to use the Keystone function, as long as you place the projector level (not angled up or down) at a height between the top and bottom of the screen, and use the vertical lens shift knob to position the image. This produces the best-looking picture.

The picture contains static or noise.

- Make sure the **Input Signal** is set correctly for your connected video equipment (see page 35).
- If you're viewing still images and you notice flickering or horizontal lines, turn on the **Progressive** setting (see page 28).
- Make sure your cables are securely connected at both ends.
- If you're using an extension cable, you may pick up interference unless you use a signal amplifier. Or try turning on **Noise Reduction** (see page 28).
- If you're displaying the same image on your computer and projector screen, try turning off your laptop's LCD display.

The picture is blurry.

- Make sure the **Input Signal** is set correctly for your video equipment (see page 35).
- There may be dirt on the lens. Clean the lens as described on page 49.
- Adjust the focus (see page 21).
- Make sure the lens is not fogged by condensation. If you've just moved the projector from a cold environment, wait a couple of minutes before using it.
- Adjust the **Sharpness** setting (see page 28).
- If you're projecting from a computer, you may need to adjust the **Tracking and Sync** settings (see page 30).

The colors on the screen don't look right.

- Make sure the **Input Signal** is set correctly for your connected video equipment (see page 35).
- Press the **Color Mode** button on the remote control to select a different color mode.
- Check the brightness and contrast settings described on page 27.
- Fine-tune the colors with the settings listed on page 29. You can also use **Cinema Color Editor** to adjust each color individually (see page 37).
- If the picture looks dark, you may need to replace the lamp. Check the lamp usage timer to see how long the lamp has been in use (see page 56). Replace the lamp if it's close to 1700 hours.

Solving Remote Control Problems

The projector doesn't respond to remote control commands.

- Make sure you're within about 30 feet of the projector, and the remote control is not angled away from the projector by more than 30° in any direction.
- You may need to replace the remote control's batteries (see page 50).
- Dim the room lights and turn off any fluorescent lights. Make sure the projector is not in direct sunlight.
- Turn off nearby equipment that emits infrared energy, such as a radiant room heater.

Where To Get Help

Epson provides technical assistance 24 hours a day at <http://support.epson.com>. Here you can access troubleshooting information, download product documentation, and receive technical advice through e-mail.

To use the Epson PrivateLine Support service, call (800) 637-7661 and enter the PIN on the Epson PrivateLine Support card that came with your projector. This is the fastest way of speaking to a live representative, and it's free. This service is available 6 AM to 6 PM, Pacific Time, Monday through Friday, for the duration of your warranty period.

You may also speak with a projector support specialist by dialing one of these numbers:

- U.S.: (562) 276-4394, 6 AM to 6 PM, Pacific Time, Monday through Friday
- Canada: (905) 709-3839, 6 AM to 6 PM, Pacific Time, Monday through Friday

Toll or long distance charges may apply.

Before you call, please have the following information ready:

- Product name (Epson PowerLite Cinema 200+)
- Product serial number (located on the bottom of the projector)
- Computer configuration, if you're connected to a computer
- Description of the problem

You can purchase screens, carrying cases, or other accessories from an Epson authorized reseller. For product information or to find the nearest authorized reseller, please call 800-GO-EPSON (800-463-7766). Or browse our catalog of products at www.epson.com, select the product you are interested in, and click "Where to Buy." To purchase online, please visit the Epson Store at www.epsonstore.com (U.S. sales only). In Canada, please call (800) 463-7766 for dealer referral.

Specifications

General

Type of display	Poly-silicon TFT active matrix
Size of LCD panels	0.7 inch (18 mm) wide
Lens	F=2.1 to 2.8, f=21.4 to 31.7 mm
Resolution (native format)	1280 × 720 pixels, 720p
Brightness	1500 ANSI lumens maximum (Dynamic/Living Room color mode)
Color reproduction	24 bit, 16.8 million colors
Contrast ratio	1000:1
Image size	30 to 300 inches (0.76 to 7.6 m)
Projection distance	2.9 to 37 feet (0.9 to 11.3 m)
Zoom ratio	1:1.5
Aspect ratio	16:9
Noise level	37 dB (Dynamic/Living Room color mode) 28 dB (Natural/Theatre/sRGB color mode)
Keystone correction	Vertical: -15 to +15°

Lamp

Type	UHE (Ultra High Efficiency)
Power consumption	200 W
Lamp life	Approx. 1700 hours (Dynamic/Living Room color mode) Approx. 3000 hours (Natural/Theatre/sRGB color mode)
Part number	V13H010L28

Remote Control

Range	Approx. 30 feet (10 m)
Batteries	AA × 2

Dimensions

Height	4.5 inches (114 mm)
Width	17.3 inches (440 mm)
Depth	12.6 inches (320 mm)
Weight	11.8 lb. (5.3 kg)

Electrical

Rated frequency	50/60 Hz AC
Power supply	100 to 120 VAC, 3.0 A 200 to 240 VAC, 1.4 A
Power consumption	Operating: 270 W max. Standby: 0.3 W

Environmental

Temperature	Operating: 41 to 95 °F (5 to 35 °C) Storage: 14 to 140 °F (-10 to 60 °C)
Humidity	Operating: 20 to 80% RH, non-condensing Storage: 10 to 90% RH, non-condensing

Safety

United States	FCC 47CFR Part 15B Class B (DoC) UL1950 Rev. 3
Canada	ICES-003 Class B CSA C22.2 No. 950-95 (cUL)
CE Marking	Directive 89/336/EEC EN 55022, EN 55024

Compatible Video Formats

The projector supports analog video in NTSC, PAL, and SECAM formats, and it automatically adjusts to the incoming signal. It can receive these formats as composite video, S-Video, or component video—which it accepts through the Video, S-Video, and Input A (Component) ports, respectively.

The projector also supports digital video (SDTV, HDTV) and various monitor display formats. The projector's Input A port accepts SDTV and HDTV in either component video or RGB video format; the Input B port accepts computer monitor signals (analog RGB).

Digital video formats

Format	Signal name	Resolution	Aspect ratio
SDTV	480i	640 × 480	4:3
	480p	640 × 480	4:3
	575i	768 × 576	4:3
	575p	768 × 576	4:3
	625i	768 × 576	4:3
	625p	768 × 576	4:3
HDTV	720p	1280 × 720	16:9
	1080i	1920 × 1080	16:9

If you're projecting from a computer, set the computer's video card at a refresh rate (vertical frequency) that's compatible with one of the monitor formats listed below. The frequencies of some computers may not allow images to display correctly.

Computer monitor formats

Format	Resolution	Refresh rate (Hz)
VGA	640 × 480	60
VESA	640 × 480	72, 75, 85
SVGA	800 × 600	60, 72, 75, 85, iMac
XGA	1024 × 768	43, 60, 70, 75, 85, iMac
SXGA	1280 × 1024	60
MAC13"	640 × 480	67
MAC16"	832 × 624	75
MAC19"	1024 × 768	75
MAC21"	1152 × 870	75

Aspect Ratio Settings

Images can be automatically resized to display at the projector's native resolution (1280 × 720) when the Aspect setting is set to Auto. If necessary, you can select a different Aspect setting to optimize the image (see page 19). The resolution at which the image displays for a given setting depends on the currently active picture source, as listed below.

Analog TV

Format	Aspect setting				
	Normal	Zoom	Squeeze	Through	Squeeze Through
NTSC	960 × 720	1280 × 720	1280 × 720	596 × 446	794 × 446
PAL or SECAM	960 × 720	960 × 720	960 × 720	708 × 528	944 × 528

Digital component video

Format	Signal name	Aspect setting				
		Normal	Zoom	Squeeze	Through	Squeeze Through
SDTV	480i	960 × 720	1280 × 720	1280 × 720	596 × 446	794 × 446
	480p	960 × 720	1280 × 720	1280 × 720	596 × 446	794 × 446
	575i	960 × 720	1280 × 720	1280 × 720	708 × 528	944 × 528
	575p	960 × 720	1280 × 720	1280 × 720	708 × 528	944 × 528
	625i	960 × 720	1280 × 720	1280 × 720	708 × 528	944 × 528
	625p	960 × 720	1280 × 720	1280 × 720	708 × 528	944 × 528
HDTV	720p	1280 × 720	—	—	1176 × 664	—
	1080i	1280 × 720	—	—	—	—

Digital RGB video

Format	Signal name	Aspect setting				
		Normal	Zoom	Squeeze	Through	Squeeze Through
SDTV	480i	960 × 720	1280 × 720	1280 × 720	640 × 480	853 × 480
	480p	960 × 720	1280 × 720	1280 × 720	640 × 480	853 × 480
	575i	960 × 720	1280 × 720	1280 × 720	768 × 576	1024 × 576
	575p	960 × 720	1280 × 720	1280 × 720	768 × 576	1024 × 576
	625i	960 × 720	1280 × 720	1280 × 720	768 × 576	1024 × 576
	625p	960 × 720	1280 × 720	1280 × 720	768 × 576	1024 × 576
HDTV	720p	1280 × 720	—	—	1280 × 720	—
	1080i	1280 × 720	—	—	—	—

Computer monitor formats (analog RGB)

Format	Aspect setting				
	Normal	Zoom	Squeeze	Through	Squeeze Through
VGA	960 × 720	1280 × 720	1280 × 720	640 × 480	853 × 480
VESA	960 × 720	1280 × 720	1280 × 720	640 × 480	853 × 480
SVGA	960 × 720	1280 × 720	1280 × 720	800 × 600	1066 × 600
XGA	960 × 720	1280 × 720	1280 × 720	—	—
SXGA	960 × 720	1280 × 720	1280 × 720	—	—
MAC13"	960 × 720	1280 × 720	1280 × 720	640 × 480	853 × 480
MAC16"	960 × 720	1280 × 720	1280 × 720	832 × 624	1109 × 624
MAC19"	960 × 720	1280 × 720	1280 × 720	—	—
MAC21"	954 × 720	1280 × 720	1280 × 720	—	—



Pixelworks DNX™ ICs are used in this projector.

Notices

Important Safety Information

Follow these safety instructions when setting up and using the projector:

- Never look into the projector lens when the lamp is turned on; the bright light can damage your eyes. Never let children look into the lens when it is on.
- Never open any cover on the projector, except the lamp and filter covers. Dangerous electrical voltages inside the projector can severely injure you.
- Except as specifically explained in this *User's Guide*, do not attempt to service this product yourself. Refer all servicing to qualified service personnel.
- The projector and its accessories come packaged in plastic bags. Keep plastic bags away from small children to avoid any risk of suffocation.
- Don't place the projector on an unstable cart, stand, or table. Also, don't use the projector near water or sources of heat.
- Use the type of power source indicated on the projector. If you're not sure of the power available, consult your dealer or power company.
- Place the projector near a wall outlet where the plug can be easily unplugged.
- Don't insert the plug into an outlet with dust present, and insert the plug firmly into the outlet. Failure to do so could result in sparks or fire.
- Don't overload wall outlets, extension cords, or integral convenience receptacles. This can cause fire or electric shock.
- Don't block the slots and openings in the projector case. They provide ventilation and prevent the projector from overheating. Don't operate the projector on a sofa, rug, or other soft surface, or in a closed-in cabinet unless proper ventilation is provided.
- Never push objects through the cabinet slots or spill liquid into the projector.
- Unplug the projector from the wall outlet and refer servicing to qualified service personnel under the following conditions: when the power cord or plug is damaged or frayed; if liquid has been spilled into the projector, or if it has been exposed to rain or water; if it doesn't operate normally when you follow the operating instructions, or if it exhibits a distinct change in performance, indicating a need for service; if it has been dropped or the housing has been damaged.
- Don't place the projector where the cord can be walked on. This may result in fraying or damage to the plug.
- Unplug the projector from the wall outlet before cleaning. Use a damp cloth for cleaning. Do not use liquid or aerosol cleaners.

- This product includes a lamp component that contains mercury (Hg). Please consult your state and local regulations regarding proper disposal or recycling, and do not place in the trash.
- Unplug the projector during lightning storms or when not in use for extended periods.
- Don't place the projector or remote control on top of heat-producing equipment.
- If you use the projector in a country other than where you purchased it, use the correct power cord for that country.
- Don't stand on the projector or place heavy objects on it.
- Don't use the projector outside of the required temperature range of 41 to 95 °F (5 to 35 °C). Doing so may cause an unstable display and could lead to projector damage.
- Don't store the projector outside of the required temperature range of 14 to 140 °F (-10 to 60 °C) or in direct sunlight for long periods of time. Doing so may cause damage to the case.

WARNING: This product contains chemicals, including lead, known to the State of California to cause birth defects or other reproductive harm. *Wash hands after handling.* (provided in accordance with Proposition 65 in Cal. Health & Safety Code § 25249.5 et seq)

Remote Control Information

You can operate the projector by remote control via a line-of-sight infrared (IR) receiver at the front and rear of the projector. The projector may not respond to remote control commands under the following conditions:

- There is an object between the remote control and the IR receiver on the projector.
- Ambient light is too bright.
- Certain types of fluorescent lighting are used.
- Other equipment that emits infrared energy, such as a radiant room heater, is in the room.

If you experience problems, try the following:

- The remote control's batteries may be low on power; replace them.
- Dim the ambient lighting and/or turn off any fluorescent lights.
- Close any window coverings and/or move the projector out of direct sunlight.
- Turn off other equipment that emits infrared energy.

FCC Compliance Statement

For United States Users

This equipment has been tested and found to comply with the limits for a Class B digital device, pursuant to Part 15 of the FCC Rules. These limits are designed to provide reasonable protection against harmful interference in a residential installation. This equipment generates, uses, and can radiate radio frequency energy and, if not installed and used in accordance with the instructions, may cause harmful interference to radio or television reception. However, there is no guarantee that interference will not occur in a particular installation. If this equipment does cause interference to radio and television reception, which can be determined by turning the equipment off and on, the user is encouraged to try to correct the interference by one or more of the following measures:

- Reorient or relocate the receiving antenna.
- Increase the separation between the equipment and receiver.
- Connect the equipment into an outlet on a circuit different from that to which the receiver is connected.
- Consult the dealer or an experienced radio/TV technician for help.

WARNING

The connection of a non-shielded equipment interface cable to this equipment will invalidate the FCC Certification of this device and may cause interference levels which exceed the limits established by the FCC for this equipment. It is the responsibility of the user to obtain and use a shielded equipment interface cable with this device. If this equipment has more than one interface connector, do not leave cables connected to unused interfaces. Changes or modifications not expressly approved by the manufacturer could void the user's authority to operate the equipment.

For Canadian Users

This Class B digital apparatus meets all requirements of the Canadian Interference-Causing Equipment Regulations.

Declaration of Conformity

According to 47CFR, Part 2 and 15 for Class B Personal Computers and Peripherals; and/or CPU Boards and Power Supplies used with Class B Personal Computers:

We: EPSON AMERICA, INC.
Located at: 3840 Kilroy Airport Way
MS 3-13
Long Beach, CA 90806-2469
Telephone: (562) 290-5254

Declare under sole responsibility that the product identified herein, complies with 47CFR Part 2 and 15 of the FCC rules as a Class B digital device. Each product marketed is identical to the representative unit tested and found to be compliant with the standards. Records maintained continue to reflect the equipment being produced can be expected to be within the variation accepted, due to quantity production and testing on a statistical basis as required by 47CFR §2.909. Operation is subject to the following two conditions: (1) this device may not cause harmful interference, and (2) this device must accept any interference received, including interference that may cause undesired operation.

Trade Name: EPSON
Type of Product: Projector
Model: EMP-TW200H
Marketing Name: PowerLite Cinema 200+

Epson America, Inc. Limited Warranty

Basic Two-Year Warranty and 90-Day Lamp Warranty

What Is Covered: Epson America, Inc. (“Epson”) warrants to the original retail purchaser of the Epson product enclosed with this limited warranty statement that the product, if purchased new and operated in the United States or Canada, conforms to the manufacturer’s specifications and will be free from defects in workmanship and materials for a period of two (2) years from the date of original purchase (except that the warranty period is 90 days for projector lamps). For warranty service, you must provide proof of the date of original purchase.

What Epson Will Do To Correct Problems: If you elect carry-in warranty service, please bring the product securely packaged in its original container or an equivalent, along with proof of the date of original purchase, to your Epson Dealer or Epson Customer Care Center. Epson will, at its option, repair or replace on an exchange basis the defective unit, without charge for parts or labor. When warranty service involves the exchange of the product or of a part, the item replaced becomes Epson property. The exchanged product or part may be new or previously refurbished to the Epson standard of quality, and at Epson’s option, the replacement may be another model of like kind and quality. Epson’s liability for replacement of the covered product will not exceed the original retail selling price of the covered

product. Exchange or replacement products or parts assume the remaining warranty period of the product covered by this limited warranty. However, each replacement lamp carries the limited 90-day warranty stated above.

What This Warranty Does Not Cover: This warranty does not apply to refurbished or reconditioned products. This warranty covers only normal consumer use in the United States and Canada. 24-hour-per-day use causes unusual strain and is not considered normal use. This warranty does not cover consumables (e.g., fuses), other than lamps. This warranty is not transferable. Epson is not responsible for warranty service should the Epson label or logo or the rating label or serial number be removed or should the product fail to be properly maintained or fail to function properly as a result of misuse, abuse, improper installation, neglect, improper shipping, damage caused by disasters such as fire, flood, and lightning, improper electrical current, software problems, interaction with non-Epson products, or service other than by an Epson Authorized Servicer. Postage, insurance, or shipping costs incurred in presenting your Epson product for carry-in warranty service are your responsibility. If a claimed defect cannot be identified or reproduced in service, you will be held responsible for costs incurred.

Notices

THE WARRANTY AND REMEDY PROVIDED ABOVE ARE EXCLUSIVE AND IN LIEU OF ALL OTHER EXPRESS OR IMPLIED WARRANTIES INCLUDING, BUT NOT LIMITED TO, THE IMPLIED WARRANTIES OF MERCHANTABILITY OR FITNESS FOR A PARTICULAR PURPOSE. SOME LAWS DO NOT ALLOW THE EXCLUSION OF IMPLIED WARRANTIES. IF THESE LAWS APPLY, THEN ALL EXPRESS AND IMPLIED WARRANTIES ARE LIMITED TO THE WARRANTY PERIOD IDENTIFIED ABOVE. UNLESS STATED HEREIN, ANY STATEMENTS OR REPRESENTATIONS MADE BY ANY OTHER PERSON OR FIRM ARE VOID. IN THE EVENT THE REMEDIES ABOVE FAIL, EPSON'S ENTIRE LIABILITY SHALL BE LIMITED TO A REFUND OF THE PRICE PAID FOR THE EPSON PRODUCT COVERED BY THIS LIMITED WARRANTY. EXCEPT AS PROVIDED IN THIS WRITTEN WARRANTY, NEITHER EPSON AMERICA, INC. NOR ITS AFFILIATES SHALL BE LIABLE FOR ANY LOSS, INCONVENIENCE, OR DAMAGE, INCLUDING DIRECT, SPECIAL, INCIDENTAL, OR CONSEQUENTIAL DAMAGES, RESULTING FROM THE USE OR INABILITY TO USE THE EPSON PRODUCT, WHETHER RESULTING FROM BREACH OF WARRANTY OR ANY OTHER LEGAL THEORY.

In Canada, warranties include both warranties and conditions. Some jurisdictions do not allow limitations on how long an implied warranty lasts and some jurisdictions do not allow the exclusion or limitation of incidental or consequential damages, so the above limitations and exclusions may not apply to you. This warranty gives you specific legal rights, and you may also have other rights, which vary from jurisdiction to jurisdiction. To locate the Authorized Epson Servicer nearest you, call the Epson ConnectionSM at (800) 637-7661 + PIN or (562) 276-4394 in the U.S. and (905) 709-3839 in Canada or write to: Epson America, Inc., P.O. Box 93012, Long Beach, CA 90809-3012.

Index

A

- Accessories, 10, 61
- Adjustment pattern, 21
- Air filter
 - cleaning and replacing, 51
 - ordering, 10
- Anti-theft device, 8, 10
- Aspect button, 9, 19, 59
- Aspect ratio, selecting, 19, 66 to 67

B

- Background Color setting, 34
- Batteries, changing, 50
- Blank button, 9, 18
- Blurry picture, 60
- Brightness
 - setting, 27
 - specification, 63

C

- Cables, connecting, 13 to 15
- Child lock, 24
- Cinema Color Editor
 - setting up, 37 to 39
 - using, 40 to 47
- Cleaning
 - air filter, 51
 - lens and projector case, 49
- Color
 - adjusting, 29, 43 to 44
 - problems, 60
- Color Mode, 9, 20, 60
- Color Temp setting, 29
- COM Port setting, 35
- Computer, displaying an image, 57 to 58

- Contrast ratio, 63
- Contrast setting, 27
- Control panel, projector, 9

D

- Declaration of Conformity, 72
- Documentation, 10

E

- Electrical requirements, 64
- Epson
 - accessories, 10, 61
 - Home Service, 7
 - PrivateLine Support, 61
 - technical support, 10, 61
 - warranty, 7

F

- FCC Compliance Statement, 71
- Feet, adjustable, 22
- Filter, *see* Air filter
- Flesh Tone setting, 29
- Flickering, 28, 59
- Focus adjustment, 21

G

- Gain, color, 29
- Gamma, 29

H

- Help, 61
- Home Service, 7

I

- Image
 - adjusting, 20 to 23, 27 to 30, 43 to 44
 - changing aspect ratio, 19, 66 to 67
 - positioning, 22, 33
 - resizing, 19, 33
 - selecting source, 18
 - upside-down or backwards, 22
- Image problems, 57 to 60
- Info menu, 56
- Input Signal setting, 21, 35
- Interference, signal, 28, 59
- Interlaced mode setting, 28

K

- Kensington anti-theft device, 8, 10
- Keystone buttons, 9
- Keystone correction, 11, 23, 59

L

- Lamp
 - checking usage timer, 56
 - life, 63
 - ordering, 10, 52
 - replacing, 52 to 53
 - resetting usage timer, 53
 - safety instructions, 69 to 70
 - specifications, 63
- Language setting, 26
- Lens shift knobs, 22
- Lens, cleaning, 49
- Lights, projector, 55 to 56
- Lock
 - Kensington, 8, 10
 - settings, 24

M

- Memory button, 9, 31
- Memory settings
 - creating, 31, 45
 - deleting, 32, 47
 - renaming, 47
 - using, 31, 46
- Menu button, 9, 25
- Menus
 - available settings, 26 to 35
 - customizing, 26
 - using, 25
- Message setting, 34
- Moving projector, 54

N

- No image, 57 to 58
- Noise reduction, 28

O

- Offset, 29
- Output scaling, 33

P

- Pattern, adjustment, 21
- Picture problems, 57 to 60
- Pixelworks, 7, 67
- Positioning image, 22
- Positioning projector, 11 to 12
- Problems
 - picture, 57 to 60
 - remote control, 60, 70
- Progressive mode setting, 28
- Projection distance, 12, 63

Projector
 checking status, 56
 cleaning, 49
 control panel, 9
 dimensions, 64
 feet, 22
 lights, 55 to 56
 locking, 8, 10, 24
 menus, 26 to 35
 parts, 8
 positioning, 11 to 12
 resetting menu options, 32
 storing, 54
 transporting, 54
 turning on and off, 17 to 18, 57

R

Registration, 7
Remote control
 buttons, 9
 changing batteries, 50
 lighting up buttons, 18
 problems, 60, 70
Replacing lamp, 52 to 53
Resetting
 lamp usage timer, 32, 53
 memory settings, 32, 47
 projector settings, 32
Resolution
 compatible formats, 65
 projector, 63
RGB settings, 29, 44
RGBCMY settings, 44
RS-232C (serial) cable, 35, 39

S

Safety approvals, 64
Safety instructions, 69 to 70
Serial cable, 35, 39
Setup level, 27
Sharpness, 28
Sleep mode, 35

Source buttons, 9
Source, selecting image, 18
Specifications
 compatible video formats, 65
 electrical, 64
 environmental, 64
 general, 63
 lamp, 63
 remote control, 63
Squeeze mode, 19
Startup screen, selecting, 34
Static, 59
Storing projector, 54
Support, *see* Technical support
Sync (Synchronization) setting, 30

T

Technical support, 10, 61
Through setting, 19
Tint, 29
Tracking, 30
Transporting projector, 54
Trigger Out setting, 35
Trigger port, 15
Turning on and off projector, 17 to 18, 57

U

USB cable, 35, 39

V

Video, compatible formats, 65

W

Warranty, 7
Where to Get Help, 61

Z

Zoom adjustment, 21

Zoom Caption setting, 19, 33

Zoom setting, 19

