

**EPSON® PowerLite® 8300i
Multimedia Projector**

User's Guide

Important Safety Information

WARNING: Never look into the projector lens when the lamp is turned on; the bright light can damage your eyes. Never let children look into the lens when it is on. Never open any cover on the projector, except the lamp and filter covers. Dangerous electrical voltages inside the projector can severely injure you. Except as specifically explained in this *User's Guide*, do not attempt to service this product yourself. Refer all servicing to qualified service personnel.

WARNING: The projector and its accessories come packaged in plastic bags. Keep plastic bags away from small children to avoid any risk of suffocation.

Caution: When you replace the lamp, never touch the new lamp with your bare hands; the invisible residue left by the oil on your hands may shorten the lamp life. Use a cloth or glove to handle the new lamp.

Copyright Notice

All rights reserved. No part of this publication may be reproduced, stored in a retrieval system, or transmitted in any form or by any means, electronic, mechanical, photocopying, recording, or otherwise, without the prior written permission of SEIKO EPSON CORPORATION. The information contained herein is designed only for use with this EPSON product. EPSON is not responsible for any use of this information as applied to other products.

Neither SEIKO EPSON CORPORATION nor its affiliates shall be liable to the purchaser of this product or third parties for damages, losses, costs, or expenses incurred by purchaser or third parties as a result of: accident, misuse, or abuse of this product or unauthorized modifications, repairs, or alterations to this product, or (excluding the U.S.) failure to strictly comply with SEIKO EPSON CORPORATION's operating and maintenance instructions.

SEIKO EPSON CORPORATION shall not be liable for any damages or problems arising from the use of any options or any consumable products other than those designated as Original EPSON Products or EPSON Approved Products by SEIKO EPSON CORPORATION.

EPSON is a registered trademark, and EasyMP and Quick Corner are trademarks of SEIKO EPSON CORPORATION.

EPSON Connection, EPSON Store, and Extra Care, are service marks; EasyManagement and SizeWise are trademarks; and PrivateLine, Presenters Club, and PowerLite are registered trademarks of Epson America, Inc.

General Notice: Other product names used herein are for identification purposes only and may be trademarks of their respective owners. EPSON disclaims any and all rights in those marks.

C

Contents

<i>Welcome</i>	7
Using Your Documentation	8
Getting More Information	8
Registration and Warranty	9
Unpacking the Projector	10
Additional Components	11
Optional Accessories	12

1

<i>Setting Up the Projector</i>	13
Positioning the Projector	14
Connecting to Video Equipment	16
Connecting a Composite Video Source	17
Connecting an S-video Source	18
Connecting a Component Video Source	19
Connecting an RGB Video Source	20
Connecting to a Computer	22
Connecting to the Computer 1 or 2 Port	23
Connecting to the BNC Port	24
Connecting to the DVI Port	25
Using the Macintosh Desktop Adapter	26
Connecting the Cable for Remote Mouse Control	27
Connecting an External Monitor	28
Playing Sound Through the Projector	29
Connecting Audio Equipment to the Projector	29
Connecting External Speakers	30

2

<i>Displaying and Adjusting the Image</i>	31
Projecting the Image.	32
Turning on the Projector	32
Selecting the Image Source.	34
Troubleshooting Display Problems.	35
You Can't Project an Image	35
The Projector and Laptop	
Don't Display the Same Image	35
Adjusting the Image	38
Focusing and Zooming Your Image.	38
Adjusting the Height of Your Image	39
Adjusting the Image Shape.	40
Correcting Computer Images.	42
Shutting Down the Projector	43

3

<i>Giving Your Presentation</i>	45
Activating and Using the Remote Control	46
Using the Navigation Buttons	47
Controlling Multiple Projectors.	48
Replacing the Batteries	50
Controlling the Picture and Sound.	51
Switching Between Picture Sources	51
Previewing Picture Sources	52
Turning Off the Picture and Sound	53
Stopping Action.	53
Zooming Your Image.	53
Displaying a Picture-in-Picture Video	54
Adjusting the Brightness	55
Controlling the Volume.	55
Highlighting Your Presentation	56
Using the Pointer Tool	56
Customizing the Pointer Tools	57
Operating Your Computer with the Remote Control	58
Creating Your Own Startup Screen	59
Capturing the Image	59
Choosing When to Display the Image	60

4	<i>Fine-tuning the Projector</i>	61
	Using the Menu System	62
	Restoring the Default Settings	63
	Adjusting the Image Quality.....	64
	Adjusting Computer Images.....	65
	Adjusting the Image Size, Shape, and Position	67
	Adjusting the Color	68
	Adjusting the Sound.....	69
	Customizing Projector Features	70
	Image Setup Options	70
	Communication Setup Options.....	71
	Miscellaneous Setup Options.....	72

5	<i>Managing the Projector from a Remote Computer</i>	73
	Installing the EasyManagement Software	74
	System Requirements	74
	Installing the Software	74
	Connecting and Configuring the Projector.....	76
	Using EMP Monitor	78
	Opening and Closing EMP Monitor	78
	Registering a Projector	78
	Monitoring Your Projectors.....	80
	Controlling Your Projectors.....	82
	Configuring the Monitoring Interval	83
	Using EMP NetworkManager	84
	Selecting the Projectors to Monitor	84
	Creating the E-Mail Settings	86
	Understanding the Notification Messages	88

6	<i>Maintaining the Projector</i>	89
	Cleaning the Lens.....	90
	Cleaning the Projector Case	90

Cleaning and Replacing the Filters	91
Cleaning the Lamp Filter	91
Cleaning the Air Intake Filters	92
Replacing the Lamp	94
Resetting the Lamp Timer	96
Transporting the Projector	97

7

<i>Solving Problems</i>	99
Checking the Projector Status.	100
What To Do When the Lights Flash	100
Viewing the ‘About’ Menu Screen	103
Solving Problems with the Image or Sound	104
Solving Problems with the Remote Control	109
Where To Get Help	110
Telephone Support Services	110

<i>Appendix A: Projector Installation</i>	111
Placement and Mounting Guidelines	111
Image Size and Projection Distance	112
Image Size Calculations (For All Lenses)	113
Converting Between Diagonal Size and Width or Height.	115
Converting Between 16:9 and 4:3 Image Sizes.	115
Installing the Rear Cable Cover	116
Installing Multiple Projectors	116

<i>Appendix B: Technical Specifications</i>	117
---	-----

<i>Appendix C: Notices</i>	123
Important Safety Instructions	123
Remote Control Information	125
Declaration of Conformity	126
FCC Compliance Statement.	127
Warranty	128

<i>Index</i>	131
------------------------	-----

W *Welcome*

The EPSON® PowerLite® 8300i is a theater-grade projector that offers up to 5200 ANSI lumens of brightness. Images are displayed at a resolution of 1024 × 768 pixels, and the 1.4-inch LCD provides an unprecedented 1200:1 contrast ratio (1500:1 in low-brightness mode) for incredibly rich images. From auditoriums to conference rooms, your full-color presentations will be vivid and clear even in bright indoor environments.

Your projector includes these outstanding features:

- **Connectivity**

Your EPSON PowerLite projector can be connected to four computer sources and five video sources (up to a total of six sources at the same time). You can include an independent sound channel for each of the six sources. A preview feature lets you see all the sources at a glance, so you can easily switch between them.

- **Complete control**

Use the remote control to take charge of your presentation. Freeze the action, zoom in on part of the picture, or display a picture-in-picture video. Use the remote as a pointer, or to draw on the screen. You can even use it in place of your computer's mouse to control your computer and change slides in PowerPoint.®

- **EasyManagement**

With the projector's EasyManagement™ system, you can use a Windows® PC to remotely monitor and control the projector.

- **EasyMP.net™ (optional; see page 12)**

The optional EasyMP.net offers you a premium network solution: web browsing, remote desktop client access, projection over an 802.11b wireless network, and storage of Microsoft® PowerPoint slideshows on a memory card for computer-free presentations.

Using Your Documentation

This book contains all the information you need to set up and use your projector. Please follow these guidelines as you read through it:

- Warnings must be followed carefully to avoid bodily injury.
- Cautions must be observed to avoid damage to your equipment.
- Notes contain important information about your projector.

Getting More Information

Need tips on giving presentations? Quick steps for setting up your projector? Here's where you can look for help:

- **presentersonline.com**
Includes a library of articles covering presentation tips, tricks, and technology. The site provides templates, clip art and sound clips, as well as Presenters Services to use on the road. Even more resources and services are available if you register to join the Presenters Club®—and it's free.
- **Quick Setup sheet**
Gives you basic instructions on connecting to a laptop.
- **Start Here kit**
Includes this *User's Guide*, your *Quick Setup* sheet, warranty brochures, and EPSON PrivateLine® Support card. Keep the folder with your projector at all times.
- **Built-in help system**
Provides assistance for common problems. Available from the Help button on the projector or the remote control.
- **support.epson.com**
Download FAQs and e-mail your questions to EPSON support.

need help?

If you still need help after checking this User's Guide and the sources listed here, you can use the EPSON PrivateLine Support service to get help fast. Call (800) 637-7661 and enter the PIN on the card in your Start Here kit. Or take advantage of EPSON's automated support services 24 hours a day. See page 110 for more information.

Registration and Warranty

Your projector comes with a basic carry-in warranty as well as an international warranty that let you project with confidence anywhere in the world. For details, see page 128 and the warranty brochure included in your *Start Here* kit.

In addition, for customers who register their projector, EPSON offers free Extra CareSM Road Service. In the unlikely event of an equipment failure, you won't have to wait for your unit to be repaired. Instead, EPSON will ship you a replacement unit anywhere in the United States or Canada, usually via overnight delivery. See the brochure in your *Start Here* kit for details.

To register, simply fill out the registration card included in your *Start Here* kit and mail it to EPSON. Or you can register online at <http://epsonwebreg.info2.net/>. Registering also lets you receive special updates on new accessories, products, and service.

Unpacking the Projector

After unpacking the projector, make sure you have all the parts shown below:

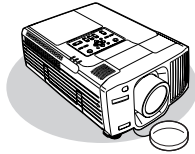

Projector*

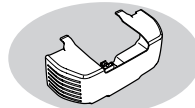

Rear cable cover



Projector software
CD-ROM



Remote control

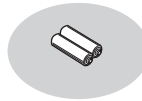

AA batteries

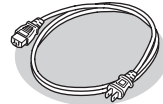

Power cord

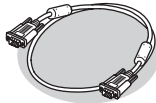

Computer VGA cable



Audio (stereo
mini-jack) cable

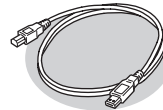

USB cable

* Remove plastic film from projector's control panel.

Save all packaging in case you need to ship the projector. Always use the original packaging (or the equivalent) when you need to send the projector to another location.

Additional Components

The projector comes with the cables you need for most computer or laptop setups. Depending on how you plan to use the projector, you may need additional components:

- To connect to a video player, you may need one of these cables:
 - RCA video cable
 - S-video cable
 - BNC cable

These cables are usually included with your video player; check the appropriate section in Chapter 1 to make sure of the kind of cable you need. You may be able to purchase it from EPSON (see page 12) or from your video dealer.

- To receive stereo sound from a video player, you'll need a dual-RCA cable, available from most electronics dealers.
- To connect a computer to the projector's Digital Video Interface (DVI) port, you'll need a DVI-D dual-link digital video cable, available from EPSON (see page 12); an optional DVI to DFP cable is also available.
- Some older PowerBooks and Macintosh desktop models may need a video-out cable (provided by Apple®) or the Macintosh adapter set shown on page 26 (available from EPSON; see page 12). Older iMac systems may need a special adapter to provide a VGA output port; see your computer dealer.

Optional Accessories

To enhance your use of the projector, EPSON provides the following optional accessories:

Product	Product no.
Replacement lamp and air filter	V13H010L23
Air filter set	V13H134A02
EasyMP.net network option board	V12H114P01
Mounting hardware: Ceiling mount Suspension adapter False ceiling plate	ELPMB41 ELPMBAPL ELPMBFCP
Projection screens: 50-inch portable screen 60-inch portable pop-up screen 80-inch portable pop-up screen	ELPSC06 ELPSC07 ELPSC08
Lenses: Rear-projection wide lens Wide zoom lens Standard zoom lens Middle throw zoom lens (2.42 to 3.67:1) Middle throw zoom lens (3.57 to 5.45:1) Long throw zoom lens	V12H004R02 V12H004W02 V12H004S02 V12H004M01 V12H004M02 V12H004L04
Cables: Component video cable (3RCA-VGA) S-video cable DVI to DVI cable, 10 ft DVI to DFP cable, 10 ft	ELPKC19 ELPSV01 ELPKC20 ELPKC21
Macintosh adapter set (monitor and desktop adapter)	ELPAP01
Remote control cable set	ELPKC28
Distribution amplifier	ELPDA01
ATA shipping case	ELPKS47
Kensington® security lock	ELPSL01
High resolution document imager High resolution document camera	ELPDC02 V12H064020

You can purchase these accessories from your dealer, by calling EPSON at (800) 873-7766, or by visiting the EPSON StoreSM at www.epsonstore.com (U.S. sales only). In Canada, please call (800) 463-7766 for dealer referral.

1 *Setting Up the Projector*

This chapter gives you basic information on setting up the projector: where to position it and how to connect it to a video source (such as a VCR or DVD player) or to a laptop or desktop computer.

Follow the instructions in this chapter on:

- Positioning the projector
- Connecting to video equipment
- Connecting to a computer
- Connecting an external monitor
- Playing sound through the projector
- Using the remote control as a wireless mouse

Positioning the Projector

note

You can mount the projector on the ceiling, or place it behind a translucent screen for rear projection. See page 111 for details.

If you're setting up the projector yourself and it isn't already installed in the theater or conference room you're using, you'll probably want to place it on a table in front of the screen, as shown.

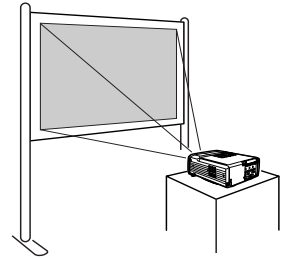

This lets you stand in the front of the room, face the audience, and remain close enough to the equipment to be able to control it. Try to leave as much space as possible between the projector and the screen to get a good-size image.

If you're using the standard lens, refer to the figure below to help you determine placement. (For detailed guidelines on placing the projector with any lens, see page 112.) Note that image size increases with distance, but can vary depending on how you've adjusted the optical zoom and other settings.

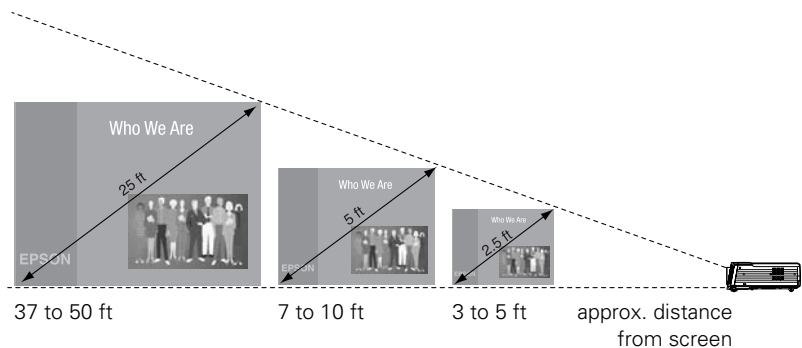

Also keep these considerations in mind:

- Place the projector on a sturdy, level surface.
- Make sure there is plenty of space for ventilation around and under the projector. Do not set the projector on top of loose papers that could block the vents under the projector.
- Make sure the projector is within 10 feet of a grounded electrical outlet or extension cord.

Ideally, you should place the projector directly in front of the center of the screen, facing it toward the screen squarely. If the projector isn't positioned this way, the image will be "keystone" shaped, instead of square or rectangular. If this happens, you can use the projector's Quick Corner™ function to readjust the shape (see page 40).

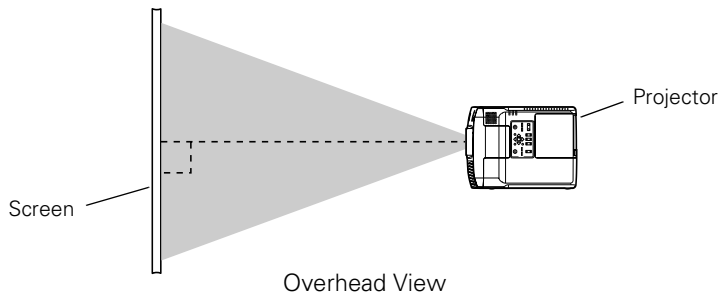

You can place the projector anywhere between the bottom and top of the screen, and then use the Lens Shift to raise or lower the image (see page 39).

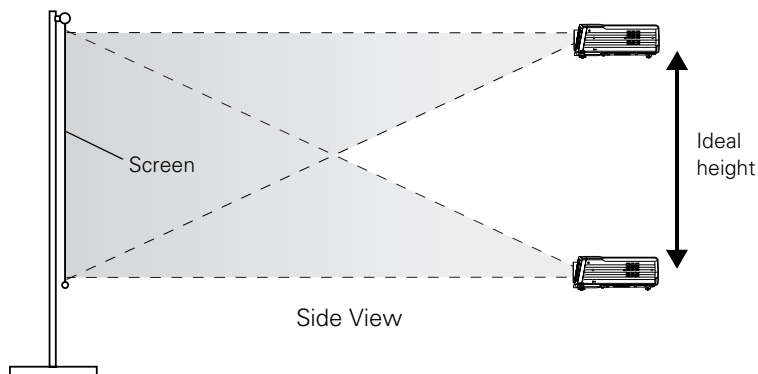

If you place the projector below screen level, you'll have to tilt it up by extending its feet. This causes the image to lose its square shape, but you can correct the distortion by pressing the Keystone button as described on page 40.

note

After positioning the projector, you may want to connect a Kensington MicroSaver® anti-theft device to the lock port on the projector's left side. You can purchase this from EPSON; see "Optional Accessories" on page 12.

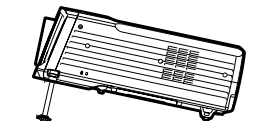

Connecting to Video Equipment

You can connect up to five video sources to the projector at the same time. Before starting, look at your video equipment to determine its available video-output connections:

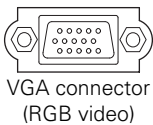
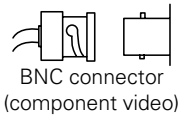
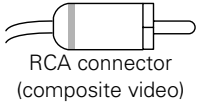

- If your video player has a yellow RCA video output connector, see “Connecting a Composite Video Source” on page 17.
- If your video player has an S-video connector, see “Connecting an S-video Source” on page 18.
- If your video player has a component video port (three connectors labeled either Y/Cb/Cr or Y/Pb/Pr), see “Connecting a Component Video Source” on page 19.
- If your video player has an RGB video port (either a single connector for a VGA monitor cable, or three connectors labeled R/G/B), see “Connecting an RGB Video Source” on page 20.

Note that connecting a cable for RGB video provides the highest quality of video transfer; component video is the next-best system, followed by S-video and finally composite video (using an RCA cable).

After connecting any video cables, you may also want to:

- connect a monitor to the projector so you can view your presentation close-up as well as on-screen; see page 28
- connect an audio cable to play sound through the projector; see page 29

Connecting a Composite Video Source

1. Locate an RCA video cable (one is usually provided with your video equipment).
2. Connect the cable to the yellow video output connector on your player and the yellow **Video** connector on the projector:

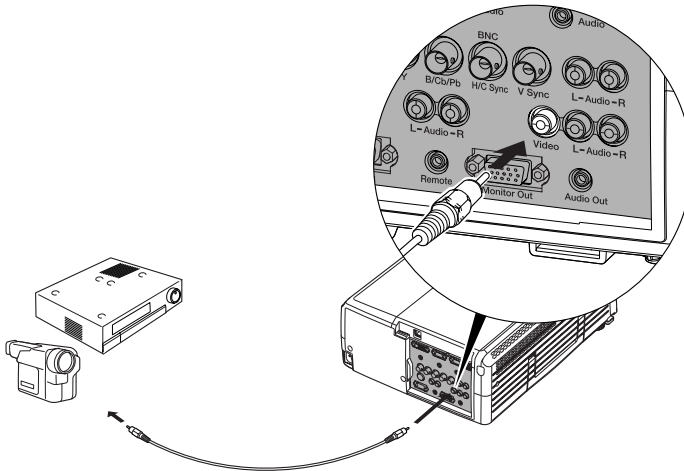

3. If you want to play sound through the projector, see page 29 for instructions on connecting an audio cable.
4. If you don't need to make any other connections, see Chapter 2 for instructions on turning on the projector and adjusting the image. Once the projector is turned on, be sure to select **Video** as the source to see your image (see page 34).

Connecting an S-video Source

1. Locate an S-video cable (one is usually provided with your video equipment, or you can purchase it from EPSON; see page 12).
2. Connect the cable to the S-video connector on your player and the **S-Video** connector on the projector:

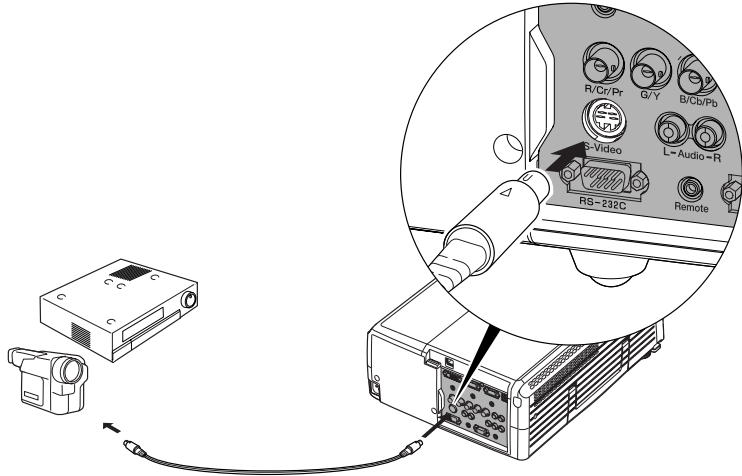

3. If you want to play sound through the projector, see page 29 for instructions on connecting an audio cable.
4. If you don't need to make any other connections, see Chapter 2 for instructions on turning on the projector and adjusting the image. Once the projector is turned on, be sure to select **S-Video** as the source to see your image (see page 34).

Connecting a Component Video Source

1. Locate a component video cable (one may be included with your video equipment).

Look at the connectors at one end of the cable. If they are bayonet-style (BNC) connectors, continue on to the next step. If they are RCA connectors, you'll need to attach commercially available BNC adapters to plug the cable into your projector.

2. Connect the cable (with the adapters) to your player and the BNC connectors on the projector. Match the Y/Cb/Cr (or Y/Pb/Pr) connectors on your player to the corresponding connectors on the projector.

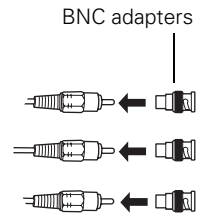
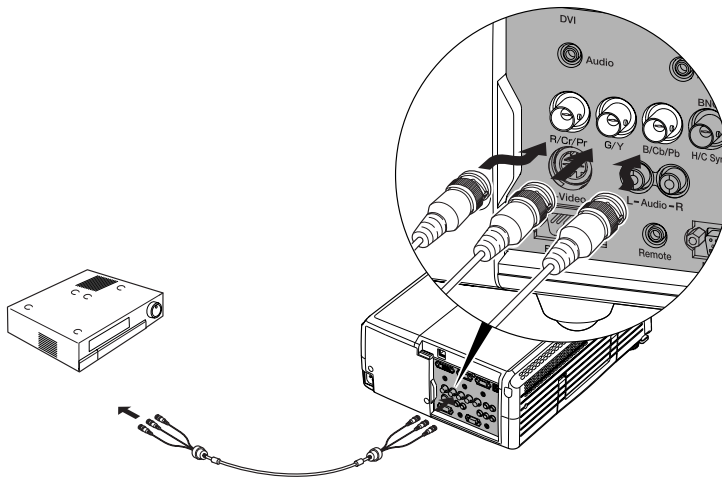

3. If you want to play sound through the projector, see page 29 for instructions on connecting an audio cable.
4. If you don't need to make any other connections, see Chapter 2 for instructions on turning on the projector and adjusting the image. Once the projector is turned on, be sure to do the following:
 - Enter the projector's Setting menu, then change the BNC Input setting to YCbCr or YPbPr, as needed (see page 70).
 - After exiting the menu system, select BNC as the source to see your image (see page 34).

Connecting an RGB Video Source

Follow these instructions to connect the projector to a video player that has an RGB video output port. Depending on the type of connector on your player, you'll need to use the appropriate cable:

- If your player has a single VGA connector, see below.
- If your player has three connectors labeled R/G/B, see “Connecting Using a BNC Cable” on page 21.

Connecting Using a VGA Computer Cable

1. Locate the VGA computer cable provided with the projector.
2. Connect the cable to the video port on your player and the Computer 1 or Computer 2 port on the projector.

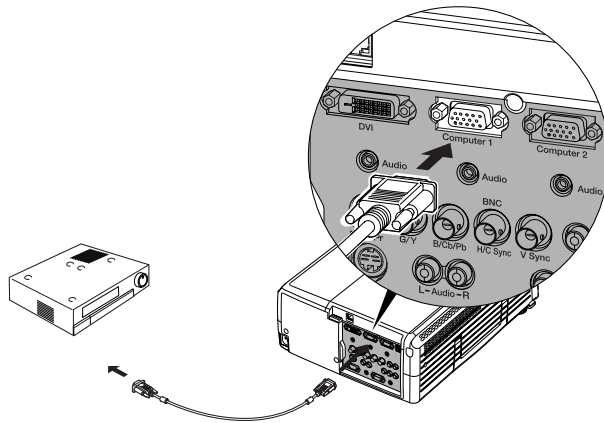

3. If you want to play sound through the projector, see page 29 for instructions on connecting an audio cable.
4. If you don't need to make any other connections, see Chapter 2 for instructions on turning on the projector and adjusting the image. Once the projector is turned on, be sure to:
 - Enter the projector's Setting menu, then change the Computer1 Input (or Computer2 Input) setting to RGB-Video (see page 70).
 - After exiting the menu system, select Computer 1 (or Computer 2) as the source to see your image (see page 34).

Connecting Using a BNC Cable

1. Locate a BNC video cable (one may be included with your video equipment).
2. Connect the cable to your player and the corresponding R/G/B connectors on the projector.

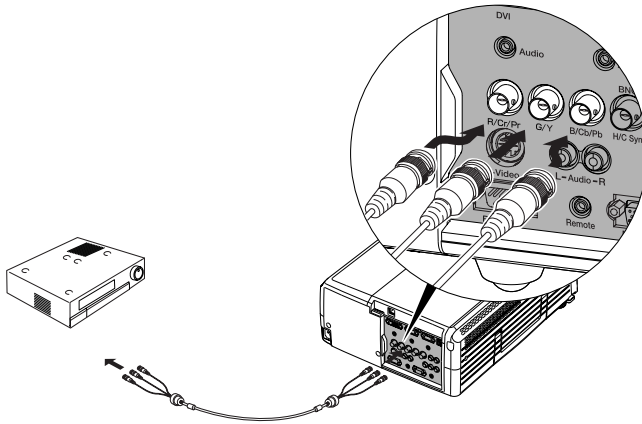

3. If you want to play sound through the projector, see page 29 for instructions on connecting an audio cable.
4. If you don't need to make any other connections, see Chapter 2 for instructions on turning on the projector and adjusting the image. Once the projector is turned on, be sure to:
 - Enter the projector's Setting menu, then change the BNC Input setting to **RGB-Video** (see page 70).
 - After exiting the menu system, select **BNC** as the source to see your image (see page 34).

Connecting to a Computer

note

The projector accepts a wide range of resolutions and video formats. For best results, set your computer to output video at the projector's native display resolution (1024 × 768). See page 120 for instructions.

You can connect the PowerLite projector to any computer that has a standard VGA, BNC, or DVI-D (or DFP) dual-link monitor port, including desktop models, PC notebook and laptop computers, Macintosh PowerBooks and iBooks, and hand-held devices. (Some proprietary video ports may require a special adapter.) You can connect up to four computers at the same time:

- To connect to the Computer 1 or Computer 2 port (standard VGA cable connection), see page 23.
- To connect using the BNC port, see page 24.
- To connect using the DVI (Digital Video Interface) port, see page 25.

After connecting any video cables, you may also want to:

- connect a USB cable so you can use the remote control as a mouse; see page 27
- connect a monitor to the projector so you can view your presentation close-up as well as on-screen (not necessary if you're using a laptop); see page 28
- connect an audio cable to play computer audio; see page 29

Connecting to the Computer 1 or 2 Port

Follow these instructions to connect to one or both of the projector's Computer ports:

1. Locate the computer VGA computer cable that came with the projector.
2. Connect one end of the cable to the projector's **Computer 1** or **Computer 2** port.

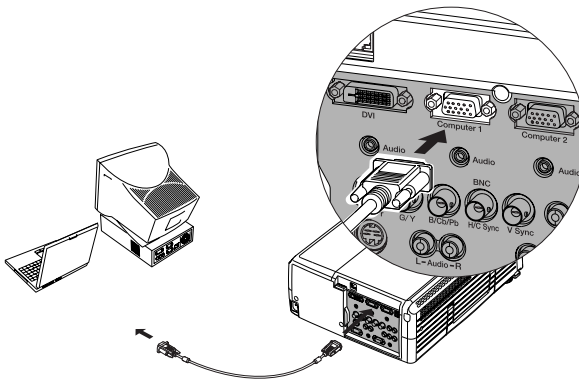

3. Connect the other end to your computer's video-out or monitor port.
4. Optionally, you can connect an external monitor (see page 28), play sound through the projector (see page 29), or connect a USB cable to use the remote control as a mouse (see page 27).
5. If you don't need to make any other connections, see Chapter 2 for instructions on turning on the projector and adjusting the image. Once the projector is turned on, be sure to:
 - Enter the projector's Setting menu, then make sure the Computer1 Input (or Computer 2 Input) is set to Analog-RGB (this is the default setting; see page 70).
 - After exiting the menu system, select **Computer 1** (or **Computer 2**) as the source to see your image (see page 34).

note

If you're using a PowerBook or an older Macintosh and you can't connect the cable to your computer, you may need to use the Macintosh desktop adapter as shown on page 26 (available from EPSON; see page 12).

Connecting to the BNC Port



note

The connectors on your cable may be labelled, or they may be color-coded (black for H/C Sync and gray for V Sync).

1. Depending on your computer's connection, obtain the correct type of BNC cable (these cables are commercially available):
 - If your computer has a VGA port, use a VGA-5BNC cable.
 - If your computer provides video output through BNC connectors, use a 5BNC-5BNC cable.
2. Connect the cable to the projector's BNC port as shown. Connect the red, green, and blue connectors to the corresponding R, G, and B ports on the projector. Then plug the remaining two connectors into the corresponding H/C Sync and V Sync ports.

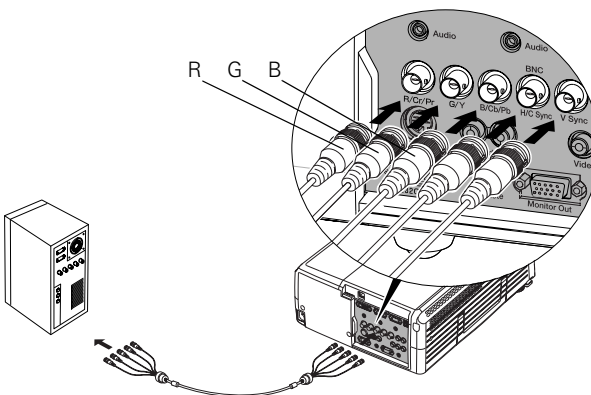

3. Connect the other end to your computer's video-out or monitor port.
4. Optionally, you can connect an external monitor (see page 28), play sound through the projector (see page 29), or connect a USB cable to use the remote control as a mouse (see page 27).
5. If you don't need to make any other connections, see Chapter 2 for instructions on turning on the projector and adjusting the image. Once the projector is turned on, be sure to:
 - Enter the projector's Setting menu, then make sure the BNC Input is set to **Analog-RGB** (this is the default setting; see page 70).
 - After exiting the menu system, select **BNC** as the source to see your image (see page 34).

Connecting to the DVI Port

1. Obtain a DVI-D dual-link digital video cable (this cable is commercially available). Note that various types of DVI cables are offered on the market, so it's important to select the correct one (see page 12).
2. Connect the cable to the projector's DVI port as shown.

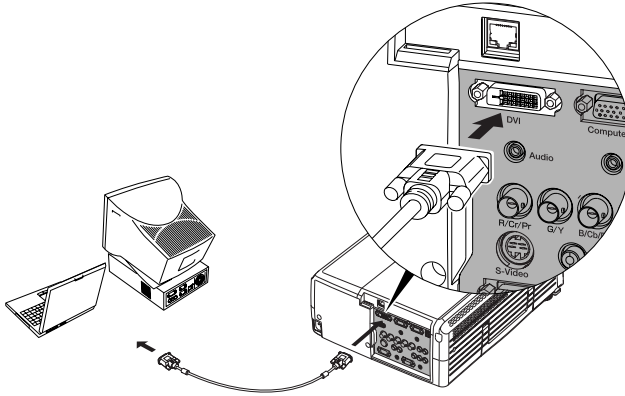

3. Connect the other end to your computer's DVI port.
4. Optionally, you can connect an external monitor (see page 28), play sound through the projector (see page 29), or connect a USB cable to use the remote control as a mouse (see page 27).
5. If you don't need to make any other connections, see Chapter 2 for instructions on turning on the projector and adjusting the image. Once the projector is turned on, be sure to select DVI as the source to see your image (see page 34).

note

An optional DVI to DFP cable is available from EPSON; see page 12.

Using the Macintosh Desktop Adapter

If you have an older desktop Macintosh or PowerBook, the VGA cable may not fit when you try to connect it. If so, you'll need to use a Macintosh desktop adapter to connect the VGA cable to your computer (available from EPSON; see page 12).

1. To use the adapter, remove its cover as shown and set its DIP switches according to the resolution you want to use, such as 16-inch mode. See your Macintosh documentation for instructions.
2. Replace the cover and connect the adapter to the VGA cable. Then plug the cable (with the adapter) into the video port on your Macintosh.
3. Tighten the screws on the connectors.

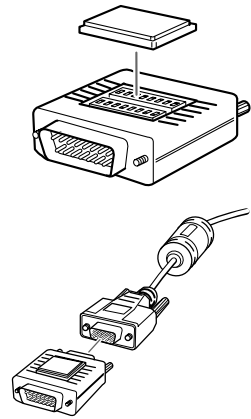

Connecting the Cable for Remote Mouse Control

If you've connected a computer as described in this chapter, you can use the projector's remote control as a wireless mouse. This lets you control your computer and click through slideshow-style presentations, such as PowerPoint, from up to 30 feet away.

To use the wireless mouse function, your system must have a USB port and one of these operating systems:

Windows	Macintosh
Windows 98, 2000, Me, and XP	Macintosh OS 8.6 to 9.2, OS X

1. Locate the USB cable that came with your projector.
2. Connect the square end of the cable to the projector's  USB port.

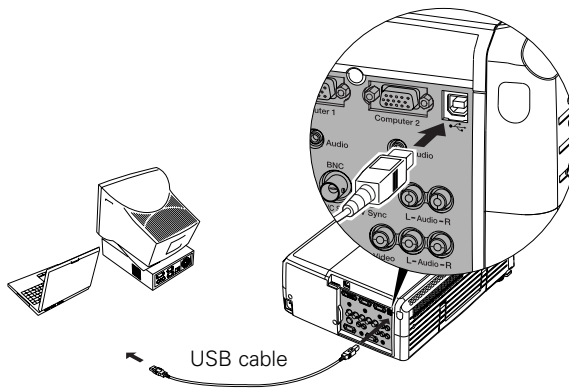

3. Connect the flat end of the cable to an available USB port on your laptop or desktop computer.
4. If necessary, configure your computer to work with an external USB mouse.

note

For details on using the remote control in place of your computer's mouse, see page 58.

Use to move cursor

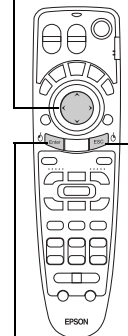

Left-click Right-click

Connecting an External Monitor

note

The monitor can display images from any connected computer or video source.

Some LCD monitors may not be able to display the image correctly. If you have trouble displaying the image, connect a multiscan monitor. If you're projecting computer images, make sure the computer's refresh rate is set to 65 Hz or greater.

If you want to monitor your presentation close-up (on a monitor placed beside the projector) as well as on the screen, you can connect an external monitor. You can use it to check on your presentation or switch between picture sources even if you've pressed the **A/V Mute** button to turn off projection on the screen.

To attach an external monitor, connect it to the projector's **Monitor Out** port, as shown:

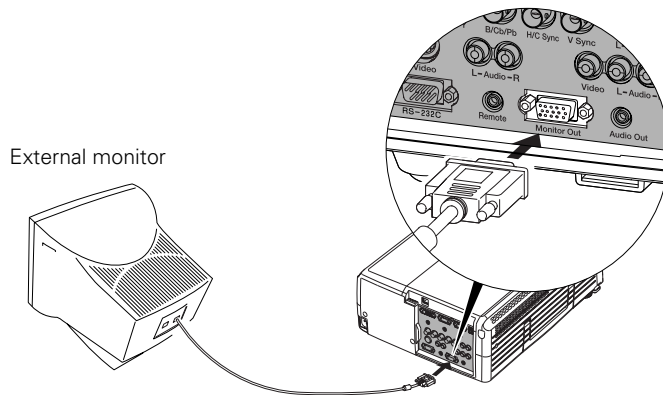

Follow these guidelines to view images on the monitor:

- The monitor displays the currently selected video source. Press the **Preview** button if you want to display all the active sources at the same time (see page 52).
- To be able to view (or preview) images on the monitor after pressing **A/V Mute**, first make sure the necessary setting is enabled. Enter the projector's Setting menu, then set the **A/V Mute** option to **Black** (if it's set to **Blue** or **Logo**, you won't be able to view images from a connected source after pressing **A/V Mute**); see page 60.
- You can also view images on the monitor while the projector is in standby mode (plugged in but not turned on), if the **Standby Mode** setting has been set to **Network ON** (see page 71).

Playing Sound Through the Projector

You can play sound through the projector's speaker system, or you can attach an external speaker system. (Attaching speakers to the projector instead of directly to the audio source lets you use the projector's remote control to adjust the sound.)

Connecting Audio Equipment to the Projector

To play sound through the projector, follow these steps:

1. Locate the appropriate audio cable (a stereo mini-jack cable for connecting computer audio is included with the projector). Which cable you use depends on how your equipment is connected:
 - If you have a computer connected to the Computer 1, Computer 2, or DVI port, use the stereo mini-jack cable.
 - If you have video equipment connected to the Video, BNC, or S-Video port, use an RCA stereo cable.
2. Connect the audio cable to the jack(s) corresponding to the connected video source.

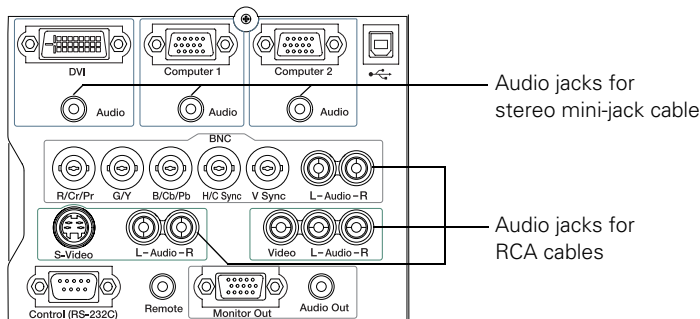

3. Connect the other end of the cable to the audio-output connector(s) on your computer or video equipment.

note

If your computer is connected to the BNC port, you'll need to use an adapter to connect the audio cable.

note

For details on adjusting the sound, see page 55.

Connecting External Speakers

To connect speakers to the projector, follow these steps:

1. Obtain the appropriate cable to connect your speakers.

Speaker systems come with a variety of jacks. Depending on your system, you may be able to use a stereo mini-jack cable (such as the one included with the projector), or you may have to purchase a special cable or use an adapter to connect to your speakers.

2. Connect the stereo mini-jack end of the audio cable to the **Audio Out** port on the projector.

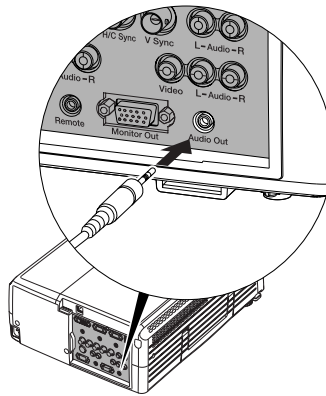

3. Connect the other end of the cable to your speaker system. You may need to use an adapter to make the connection.

The projector's internal speaker system is disabled while sound is output to the external speakers.

2

Displaying and Adjusting the Image

Whether you're presenting from a computer or video equipment, or with the optional EasyMP.net, you need to follow some basic steps to display your image on the screen.

Follow the guidelines in this chapter to:

- Turn on the projector and select the image source
- Adjust the image
- Shut down the projector

Projecting the Image

Make sure your projector and other equipment are set up as described in Chapter 1. Then follow the instructions below to start the projector and display an image.

Turning on the Projector

If you turn on your connected computer or video equipment before starting the projector, the projector automatically detects and displays the image source. If you turn on the projector first, or have multiple pieces of connected equipment, you may have to select the image source manually (see page 34).

note

To shut down the projector, see page 43. Shutting down the projector correctly prevents premature lamp failure and possible damage from overheating.

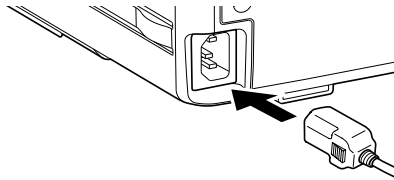

Follow these steps to turn on the projector:

1. Remove the lens cap.
2. Plug in the projector, as shown below.



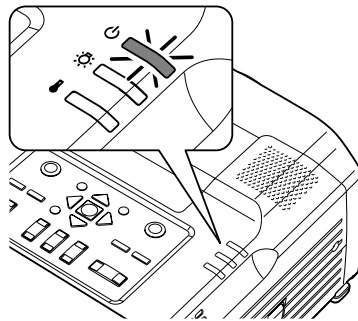

The  power light stops flashing and remains orange.

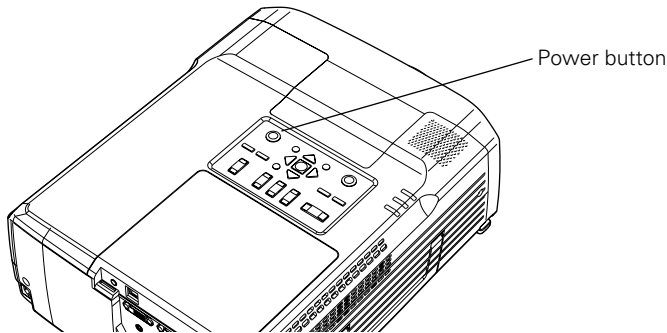
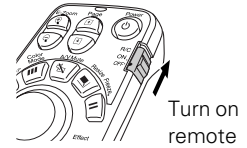

3. Press the red  Power button on top of the projector—or press the  Power button on the remote control.

(If this is your first time using the remote control, make sure the batteries are installed and the power switch on the side of the remote is turned on; see page 46.)



The  power light flashes green as the projector warms up, and an image begins to appear after about 30 seconds. When the  power light stops flashing and remains green (in about a minute) the projector is ready for use.

4. If you've connected a Windows-based computer to the projector, you may see a New Hardware Wizard saying your computer has found a plug-and-play monitor; if so, click **Cancel**.

warning

Never look into the lens when the lamp is on. This can damage your eyes, and is especially dangerous for children.

Selecting the Image Source

note

To focus and adjust the image, see page 38. If a projected image fails to appear, see page 35 for help.

Selecting the image source lets you switch between images input from different pieces of equipment connected to the projector (such as a computer or DVD player), or turn on EasyMP.net if that option has been installed.

If you don't see the image you want, select it using the **Source** buttons either on the projector or the remote control.

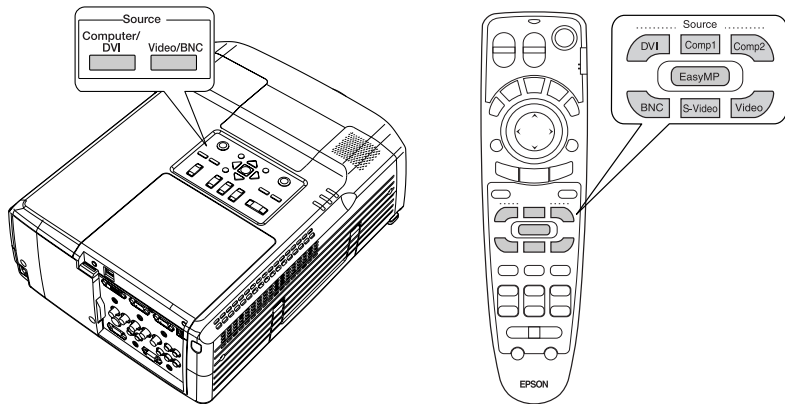

The **Source** buttons work as follows:

- The projector has two **Source** buttons. Use the **Computer/DVI** button to switch between equipment connected to the Computer 1, Computer 2, and DVI ports (or to select EasyMP.net, if that option has been installed).

Use the **Video/BNC** button to switch between equipment connected to the Video, S-Video, and BNC ports.

- The remote control has seven **Source** buttons. Use them to switch between equipment connected to the port identified on each button.

Note that the Computer 1, Computer 2, and BNC ports can be set up to use different input signals (for example, Analog RGB or RGB Video)—so if you have equipment connected to one of these ports, it's important to make sure the correct signal is selected to match the equipment you're using. You can select the input signal settings using the projector's menu system; see page 70.

note

You can also preview all sources on one screen to help you select the desired source (see page 52).

Troubleshooting Display Problems

Follow these guidelines if you're having trouble displaying an image.

You Can't Project an Image

If you see a blank screen or a blue screen with the **No Signal** message, try the following:

- Make sure the cables are connected correctly, as described in Chapter 1.
- Make sure the power light is green and not flashing and the lens cover is off.
- If you've connected more than one computer and/or video source, you may need to press one of the **Source** buttons on the projector's control panel or the remote control to select the correct source. (Allow a few seconds for the projector to sync up after pressing the button.)
- If you're using a PC laptop, press the function key on your keyboard that lets you display on an external monitor. It may be labeled **CRT/LCD** or have an icon such as . You may have to hold down the **Fn** key while pressing it. Allow a few seconds for the projector to sync up after changing the setting.

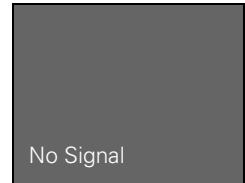

The Projector and Laptop Don't Display the Same Image

If you're projecting from a laptop, and you don't see the same image on the projection screen and on your computer screen, follow these guidelines.

If you're using a PC laptop:

- On most systems, there's a function key that lets you toggle between the LCD screen and the projector, or display on both at the same time. It may be labeled **CRT/LCD** or with an icon such as . You may have to hold down the **Fn** key while pressing it. Allow a few seconds for the projector to sync up after changing the setting.

- If the function key doesn't permit you to display simultaneously on both screens, you should check your monitor settings to make sure both the LCD screen and the external monitor port are enabled.

From the Control Panel, open the **Display** utility. In the Display Properties dialog box, click the **Settings** tab, then click **Advanced**. The method for adjusting the settings varies by brand; you may need to click a **Monitor** tab, then make sure the external Monitor port is set as your primary display and/or enabled. See your computer's documentation or online help for details.

If you're using Macintosh OS X:

You may need to set up your system to display on the projector screen as well as the LCD screen. Follow these steps:

1. From the Apple menu, select **System Preferences**, then select **Displays**.
2. Make sure the **VGA Display** or **Color LCD** dialog box is selected.
3. Click the **Arrange** (or **Arrangement**) tab.

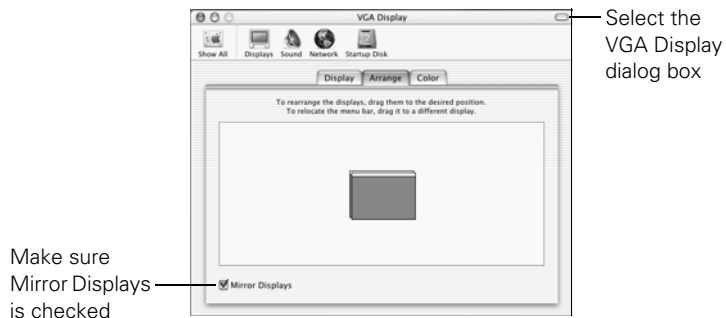

4. Make sure the **Mirror Displays** checkbox is selected.

If you're using OS 8.6 to 9.x:

You may need to set up your system to display on the projector screen as well as the LCD screen. Follow these steps:

1. From the Apple menu, select **Control Panels**, then click **Monitors** or **Monitors and Sound**.
2. Click the **Arrange** icon.

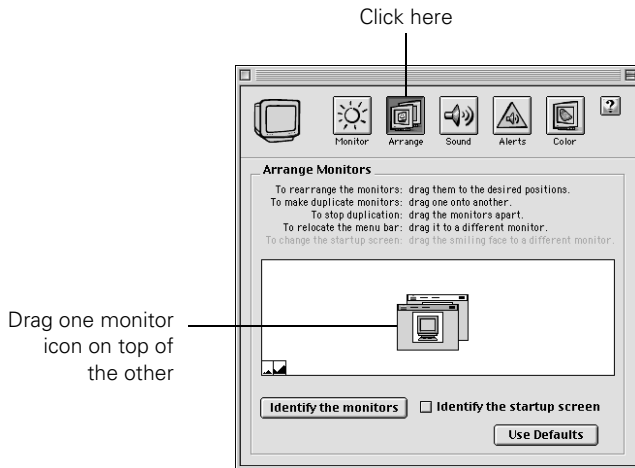

3. Drag one monitor icon on top of the other.

If the **Arrange** option isn't available, you may need to select one of the **Simulscan** resolution settings:

1. Click the **Monitor** icon.

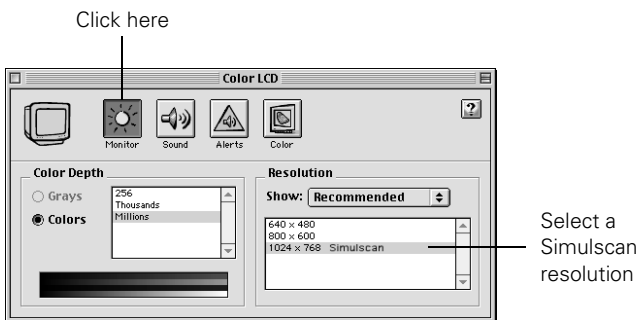

2. Select a **Simulscan** resolution as shown. (Allow a few seconds for the projector to sync up after making the selection.)

Adjusting the Image

Once you see your image, you need to make certain adjustments:

- To focus or zoom your image, see below.
- If the image is too high or too low, you can reposition it. See page 39.
- If the image isn't square, see page 40.
- If a computer image displays incorrectly, see page 42.

If you want to fine-tune the image and/or sound, see Chapter 4.

Focusing and Zooming Your Image

Use the Focus buttons on the remote control (or on the projector) to sharpen the image.

Use the Zoom buttons to reduce or enlarge the image.

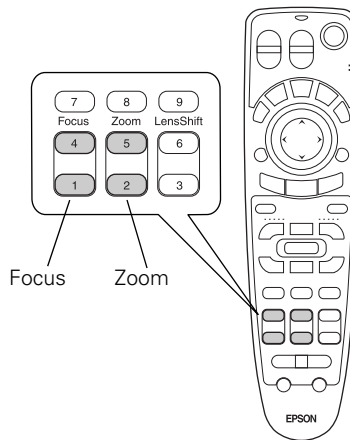

If the image still isn't large enough, you may need to move the projector farther away from the screen. You can also use the E-Zoom buttons on the remote control to zoom in on a portion of the image. See page 53 for instructions.

note

The Focus and Zoom buttons won't work when the wide-angle rear projection lens is installed.

Adjusting the Height of Your Image

If the image is too low on the screen, you can raise it using the Lens Shift. This is the best method for adjusting the height of the image. If you need to raise the image further, you can tilt the projector upward by extending the feet.

Using the Lens Shift

To raise or lower the image, use the Lens Shift buttons on the remote control (or on the projector).

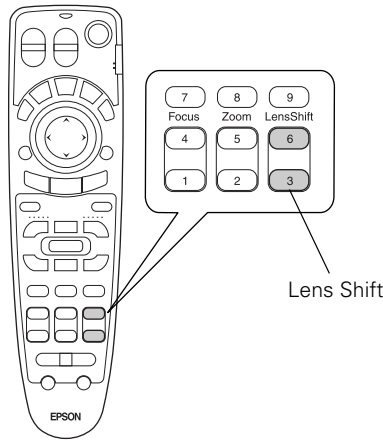

note

The Lens Shift buttons won't work when the wide-angle rear projection lens is installed.

Raising the Projector's Feet

If you need to raise the image further, you can incline the projector:

1. Stand behind the projector. Press the foot release buttons on each side and lift the front of the projector.

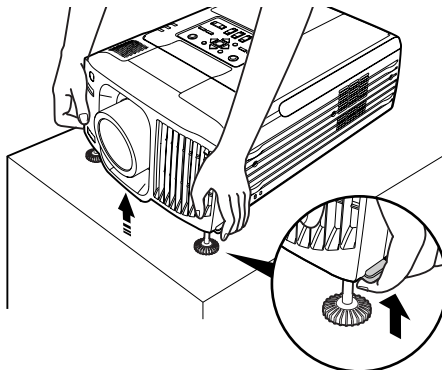

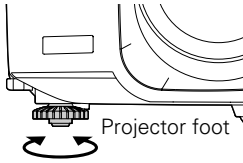

2. Once the image is positioned where you want it, release the buttons to lock the feet in position.
3. If necessary, you can level the picture or fine-tune the height by turning the projector feet.

Raising the projector causes the image to distort or “keystone,” but you can manually correct the shape as described in the next section.

Adjusting the Image Shape

In most cases, you can maintain a square or rectangular image by placing the projector directly in front of the center of the screen and using the Lens Shift (instead of tilting the projector upward) to adjust the image height.

If this isn't possible, use one of these methods to correct the image shape:

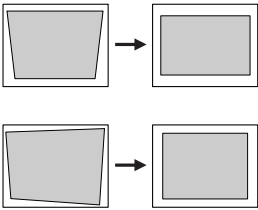

- If the image tapers inward on the right and left sides only, use Keystone correction as described below.
- If the image looks uneven on all sides, you can adjust its shape using Quick Corner (see page 41).

You cannot use both Keystone correction and Quick Corner at the same time.

Using Keystone Correction

To adjust your image when the right and left sides are uneven, do one of the following:

- Use the **Keystone** buttons on the projector's control panel to adjust the image shape.

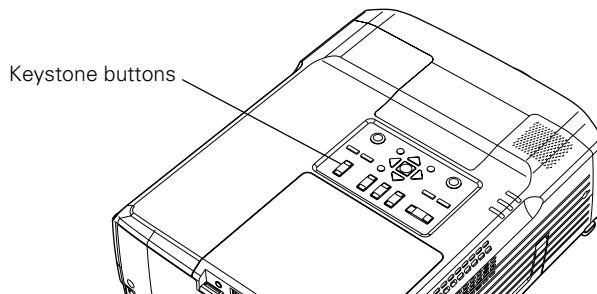

note

The image will be slightly shorter after adjusting. If it's important to maintain the correct aspect ratio, use the menu system to perform Keystone correction, then adjust the Height setting as needed (see page 41).

- Or press the **Menu** button on the remote control, select the **Setting** menu, and press **Enter**. From the Setting menu, select **Keystone** and press **Enter**. Then select **V-Keystone** and press **Enter**. Adjust the setting as needed.

When corrected, the image will be slightly shorter. If necessary, you can stretch the image to its proper size using the **Height** setting.

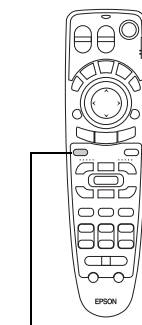

Menu button

Using Quick Corner

Use Quick Corner to correct the image shape when it's uneven on all sides.

1. Press the **Menu** button on the remote control (or on the projector's control panel).
2. Select the **Setting** menu and press **Enter**.
3. From the Setting menu, select **Keystone** and press **Enter**.
4. Select **Quick Corner** and press **Enter**.

You see this screen:

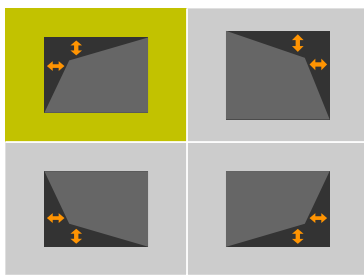

5. Press the **Enter** button to select the corner you want to adjust.
6. Use the  pointer button on the remote control (or the arrow buttons on the projector) to adjust the shape.
7. Repeat steps 5 and 6 as needed to adjust any remaining corners.
8. When done, press **ESC** to exit the menu system.

note

For more information on using the menu system, see page 62.

Correcting Computer Images

If you've connected a computer and the image doesn't look right, or it doesn't fit properly on the screen, press the **Auto** button on the remote control (or the ↵ **Auto/Enter** button on the projector's control panel). This automatically resets the projector's tracking, sync, resolution, and position settings.

note

*You must be projecting an image for this button to have any effect. The **Auto** button works only with computer images.*

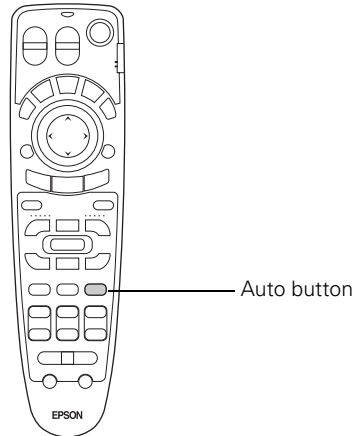

Shutting Down the Projector

When you've finished using the projector, follow the recommended procedure to shut it down. This extends the life of the lamp and protects the projector from possible overheating.

1. If you've connected a computer or laptop, shut it down first; otherwise you may not be able to see your computer's display to shut it down properly.
2. To turn off the projector, press the red **Power** button on the projector or remote control.

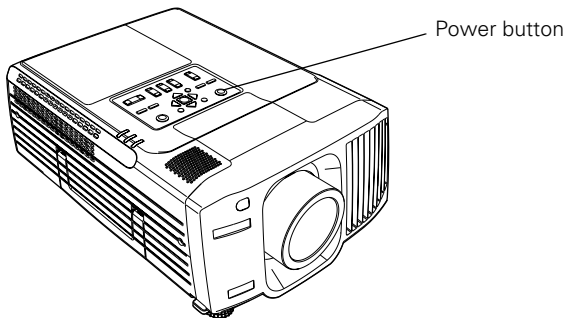

You see a confirmation message. (If you don't want to turn it off, press any other button.)

3. Press the **Power** button again. The power light flashes orange for about a minute as the projector cools down. After the projector has cooled, the orange light stays on and the exhaust fan shuts off.

If you want to turn the projector on again, wait until the orange light stops flashing. Then press the **Power** button.

4. Turn off and disconnect any equipment plugged into the projector.
5. If you extended the feet, press the side buttons to retract them.
6. Replace the lens cap and unplug the power cord.

note

*When the projector has not received any input signals for 30 minutes, it automatically turns off the projector lamp and enters "sleep mode." This conserves electricity, cools the projector, and extends the life of the lamp. If you want to start projecting again, press the **Power** button. If you are done using the projector, unplug the power cord. To turn off sleep mode, see page 72. If Standby Mode has been set to Network ON (see page 71), the lamp will turn off but the projector will not go into full sleep mode.*

Power OFF?

Yes : Press  button
No : Press any other button

caution

To avoid damaging the projector or lamp, never unplug the power cord when the power light is green or flashing orange.

3

Giving Your Presentation

The projector includes a number of tools to enhance your presentation. All of them can be accessed using the remote control, which lets you operate the projector from anywhere in the room—up to 30 feet away.

note

For information and resources to help you give the most professional presentation, be sure to visit presentersonline.com.

You can use the remote control to adjust the picture and sound (page 51), or as a pointer or drawing tool to highlight your presentation (page 56). You can also use it as a wireless mouse when projecting from a computer (page 58); this lets you easily change slides, for example, when giving presentations in PowerPoint.

To further enhance your presentation, you can create a customized screen to display a picture or company logo (page 59), and then use it as the startup screen or the screen you see when you press the A/V Mute button.

This chapter covers:

- Activating and using the remote control
- Controlling the picture and sound
- Highlighting your presentation
- Operating your computer with the remote control
- Creating your own startup screen

Activating and Using the Remote Control

The remote control has an on/off switch on its side, as shown. Before using the remote, make sure batteries are installed as described on page 50, then push up on the on/off switch to turn it on.

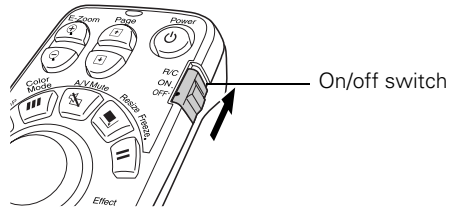

note

If the  pointer button is pressed longer than 10 seconds, the remote control stops operating to conserve power. Releasing the button resumes normal operation.

Turn off the remote control before transporting or storing it; this prevents the batteries from discharging if something presses against one of the buttons.

Here are some additional tips:

- Point the remote control either at the front or back of the projector, or at the screen.
- Stand within about 30 feet of the projector. If you want to operate the projector from a greater distance, a remote control cable set is available (see page 12).
- When presenting in a darkened room, press the  light button to make the buttons on the remote light up temporarily.
- Avoid using the remote under bright fluorescent lamps or in direct sunlight, or the projector may not respond properly.

Using the Navigation Buttons

The remote control has various buttons that let you navigate the projector's help and menu systems; they also let you use the drawing tools to highlight your presentation. If you've connected a computer, the buttons can be used in place of your computer's mouse, letting you walk about freely while controlling your presentation.

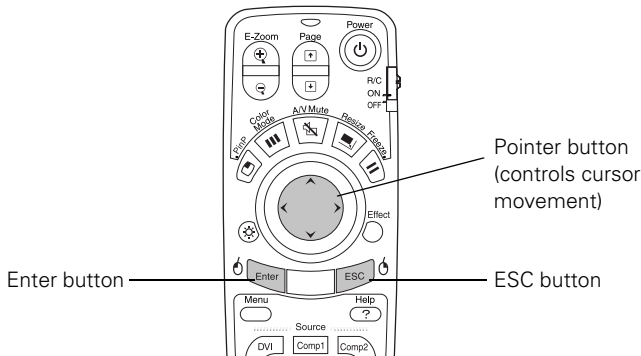

For details on using the buttons to control specific features, see the following sections:

- to highlight your presentation, see page 56
- to use the remote control in place of your computer's mouse, see page 58
- to navigate the projector's menu system, see page 62

note

If you've installed the *EasyMP.net* option, you can also use these buttons to control the *EasyMP* features.

note

The projector has equivalent buttons that you can use on its control panel:

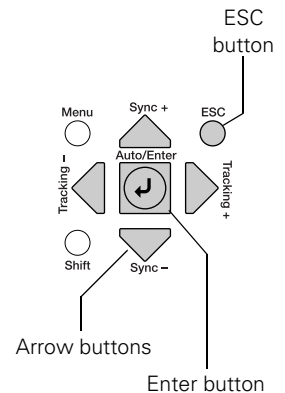

Controlling Multiple Projectors

If you're using more than one projector, you can control all the projectors—or just selected ones—by using the projector ID system. To operate a projector, you have to set the remote control's ID to match that of the projector. Or you can control all of the projectors simultaneously by setting the remote control's ID to zero.

Setting the Projector ID

The projector's default ID is 1. If you need to change it, follow these steps:

1. Press the **Menu** button on the remote control.
You see the projector's menu screen.
2. Enter the **Advanced2** menu and highlight **Projector ID**.

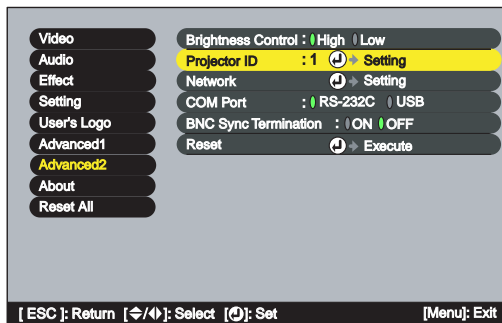

3. Press the right or left side of the  pointer button to increase or decrease the ID value.
4. Press **Enter** to set the value.
5. When done, press **ESC** to exit the menu system.

Setting the Remote Control ID

The remote control's default ID is zero. If you need to change it, follow these steps:

1. Press the ID button on the remote control. You see it light up.

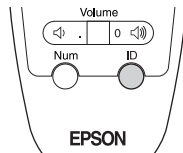

2. Press one of the numbered buttons on the remote control to select the desired ID (0 through 9). Select zero to control all projectors, or select a number to match the ID of the projector(s) you want to operate.

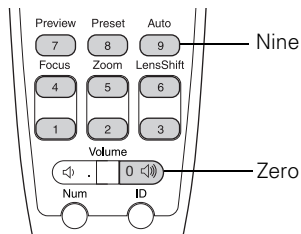

The ID button's light shuts off and the new ID is registered.

If you would like to check the remote control's current ID, do the following:

1. Press the ID button twice in succession. After a moment, the button flashes.
2. Count the number of flashes; this number corresponds to the remote control's ID.

Replacing the Batteries

If the projector stops responding to the remote control, check the following:

- Make sure the remote control's on/off switch (shown on page 46) is in the ON position.
- Press the ☼ light button and check to see if the buttons on the remote control light up. (If you're in a bright room, you may not be able to see them light.)

caution

When replacing batteries, take the following precautions:

- *Replace the batteries as soon as they run out. If the batteries leak, wipe away battery fluid with a soft cloth. If fluid gets on your hands, wash immediately.*
- *Do not expose batteries to heat or flame.*
- *Dispose of used batteries according to local regulations.*
- *Remove the batteries if you won't be using the projector for a long period of time.*

If the buttons do not light up, replace the batteries as described below:

1. Turn the remote control over.
2. Slide the battery compartment cover open.
3. Install two AA batteries, inserting the flat (negative) ends in first.
4. Slide the cover back in place.

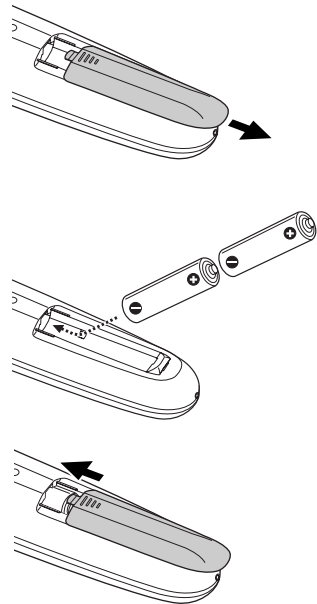

Previewing Picture Sources

You can use the Preview function to help you select the image source.

1. Press **Preview** on the remote control.

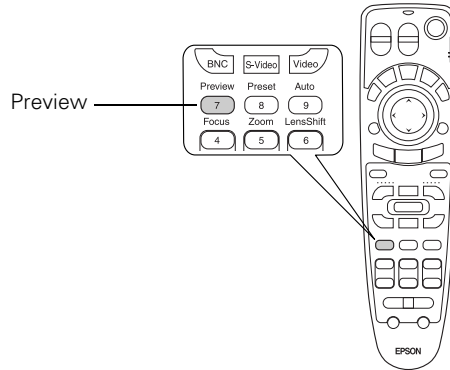

note

Movies are displayed as still images on the preview screen.

You see the currently selected source displayed in the main window, as shown. All other sources (including the currently selected source) are displayed in smaller preview windows on the right side and at the bottom. If no equipment is connected to a port, or if there is no incoming signal, the preview window for that source appears blank.

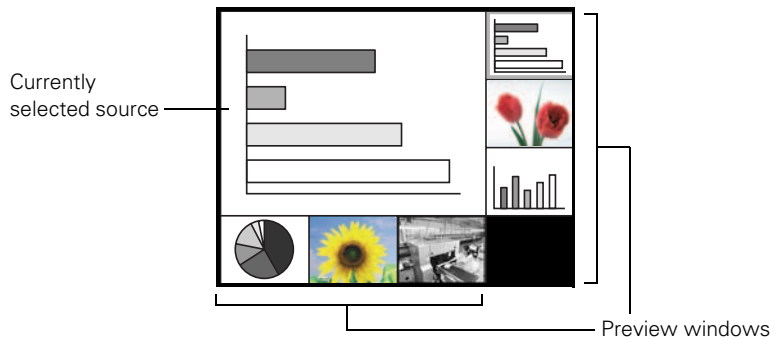

note

*A red highlight surrounds the preview window for the currently selected source. You can use the  pointer button on the remote control to highlight a different source, and then press **Enter** to display it.*

2. Press one of the **Source** buttons on the remote control to switch to the desired source. Or press **ESC** to exit the preview screen without switching sources.

Turning Off the Picture and Sound

You can use the **A/V Mute** button on the remote control to turn off the image and sound and darken your screen. (If you've connected an external monitor to the projector, it will continue displaying.) This feature is useful if you want to temporarily redirect your audience's attention without the distraction of a bright screen.

- To turn off the picture, press the **A/V Mute** button. The screen goes dark.
- To turn the image back on, press the button again.

You can also have an image, such as a company logo, display on the screen whenever you press the **A/V Mute** button (see page 59).

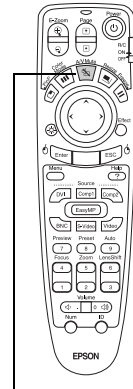

A/V Mute button

Stopping Action

You can use the remote control to stop the action in your video or computer image.

- Press the **Freeze** button to stop the action and keep the current image on the screen. The sound continues.
- Press the **Freeze** button again to restart it.

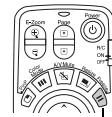

Freeze button

Zooming Your Image

You can zoom in on a portion of the image using the **E-Zoom** buttons on the remote control.

1. Press the **E-Zoom** \oplus button on the remote control.
You see a crosshair indicating the center of the zoom-in area.
2. Use the \odot pointer button to position the crosshair.
3. Continue pressing the **E-Zoom** \oplus button to enlarge the selected area up to 4 \times .
4. While the image is enlarged, you can:
 - Use the \odot pointer button to pan about.
 - Press the **E-Zoom** \ominus button to zoom out.
5. When done, press the **ESC** button to return to the original size.

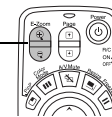

E-Zoom buttons

note

Depending on your equipment's ports, you may be able to connect either a computer or video player to the BNC, Computer 1, and/or Computer 2 port. See Chapter 1.

note

Select Composite if your P-in-P video equipment is connected to the Video port.

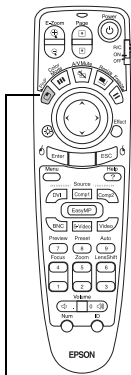

P in P button

Displaying a Picture-in-Picture Video

If you're displaying an image from equipment connected to the DVI, Computer 1, Computer 2, or BNC port, you can open up a smaller picture-in-picture (P-in-P) window on the screen. This window can display video from either the Video or S-Video port.

Setting Up the P-in-P Image

Before starting, make sure the computer or video equipment for your main image is connected to the DVI, Computer 1 or 2, or BNC port, and the video equipment for the P-in-P window is connected to the Video or S-Video port. Then select the corresponding video setting:

1. Press the **Menu** button on the remote control, and enter the **Setting** menu.
2. Highlight **P in P**, use the pointer button to select either **Composite** or **S-Video**, then press **Enter**.
3. Press **ESC** to exit the menu system.

Displaying the P-in-P Image

Make sure your main image source is displayed, then follow these steps to display and use the Picture-in-Picture window:

1. Press the **P in P** button on the remote control.
2. Use the  pointer button to reposition the video window; use the **E-Zoom** buttons to reduce or enlarge it.
3. Once the window is located and sized the way you want it, press the **Enter** button; your video continues playing on the screen.

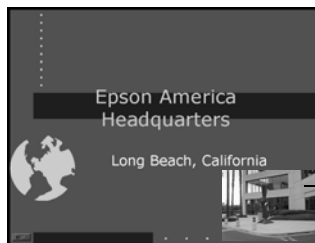



Video window



4. When you're finished viewing the Picture-in-Picture, press the **P in P** or pointer button again. The window disappears.

Adjusting the Brightness

If you're presenting in a small room, you may find the brightness of the projector to be too intense. You can adjust it to a more comfortable level using the projector's menu system:

1. Press the **Menu** button on the remote control.
2. To adjust the brightness to a lower, preset level, use the  pointer button to highlight the **Advanced2** menu. Press **Enter**, select **Brightness Control**, and then choose **High** or **Low**.
3. Press the **ESC** button when done making the setting.
4. To fine-tune the brightness, use the  pointer button to highlight the **Video** menu. Press **Enter**, select **Brightness**, then adjust the brightness level as desired.
5. Press **ESC** when done to exit the menu system.

Controlling the Volume

To change the volume, press the  or  side of the Volume button.

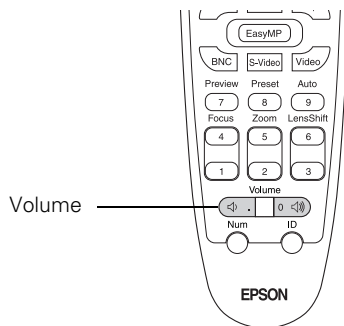

note

To temporarily shut off the sound (and picture), press the AV Mute button.

If necessary, you can adjust the tone using the projector's menu system. See page 69.

Highlighting Your Presentation



You can display a pointer to call out something on the screen, or draw straight or curved lines to emphasize particular points. There are three preset pointer tools you can choose from, and each one can be customized for a different look.

Using the Pointer Tool

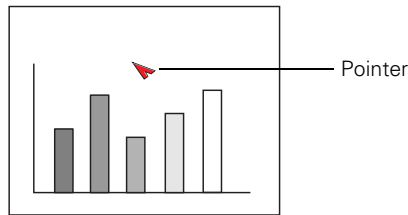
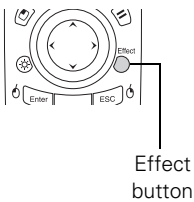
1. To activate the pointer tool, press the **Effect** button on the remote control. A pointer appears on the screen.



If you prefer to use a different style of pointer, continue pressing the **Enter** button to select the desired style. Three preset options are available, but you customize the look of each one (see page 57).

2. Use the  pointer button on the remote control to position the pointer on the screen.
3. To draw a straight line, place the pointer where you want the line to begin and press **Enter**. Move the pointer to where you want the line to end, and press **Enter** again.
4. To draw a curved line, place the pointer at the start of the line, then press and hold the **Enter** button until it lights. Then use the  pointer button to move the pointer and draw on the screen. Press **ESC** when done.
5. If you want to draw additional lines, repeat steps 3 and 4.
6. When done drawing, press **ESC** to clear the screen.

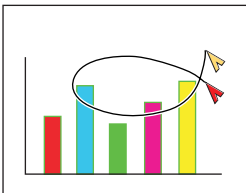

Customizing the Pointer Tools

You can customize the shape and size of each of the three pointer tools, select the color and width of the line made with each pointer, and set how fast you can move the pointer across the screen.

1. Press the **Menu** button on the remote control, highlight the **Effect** menu, and press **Enter**.

You see this screen:

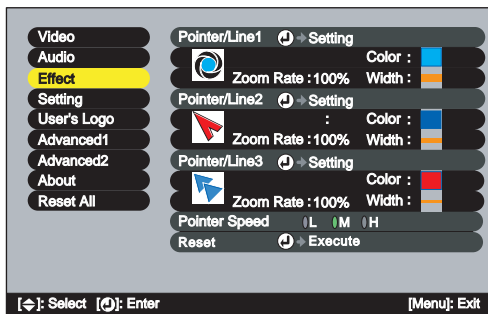

2. For each of the three Pointer/Line icons, you can change the following settings:

- **Shape**

Lets you select one of the following pointer shapes:



- **Zoom Rate**

Changes the size of the pointer

- **Color**

Changes the color of the line you can draw using the pointer

- **Width**

Changes the line width

3. You can also change the **Pointer Speed** setting to adjust how fast the pointer tool moves across the screen.
4. When done, press **ESC** to exit from the menu system.

Operating Your Computer with the Remote Control

If you've connected a computer as described in Chapter 1, you can use the remote control in place of your computer's mouse. This gives you more flexibility when delivering PowerPoint and other slideshow-style presentations, since you won't have to stand next to the computer to change slides.

note

To drag-and-drop, hold down the **Enter** button for about one second until it lights. Then use the  pointer button to drag the object. When it's positioned where you want it, press **Enter** to release it.

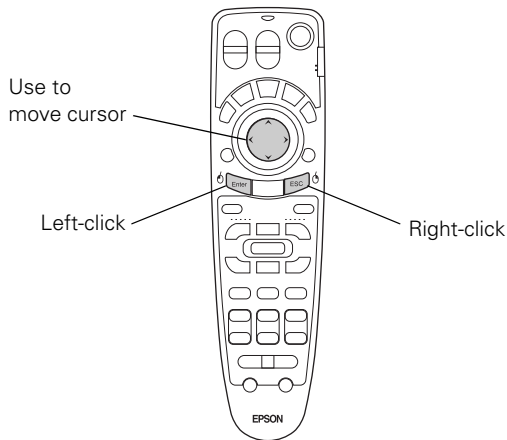

To use the remote control this way, you have to connect a USB cable between your computer and the projector (see page 27).

While projecting a PowerPoint presentation, this setup also lets you use the **Page** buttons to move through your slideshow.

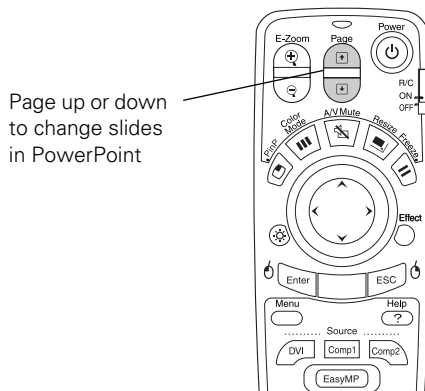

Creating Your Own Startup Screen

You can transfer any image from your computer or video source to the projector, and then use it as your startup screen. You can also use it as the screen to be displayed when the projector is not receiving a signal or when you press the A/V Mute button. The image can be a company logo, slogan, photograph, or any other image you want to use.

Capturing the Image

Start by displaying the image you want to use. It can be an image from either a computer or video source such as a DVD player or digital camera. Then follow these steps to capture the image and transfer it to the projector:

1. Press the **Menu** button on the remote control, highlight the **User's Logo** menu, and press **Enter**.

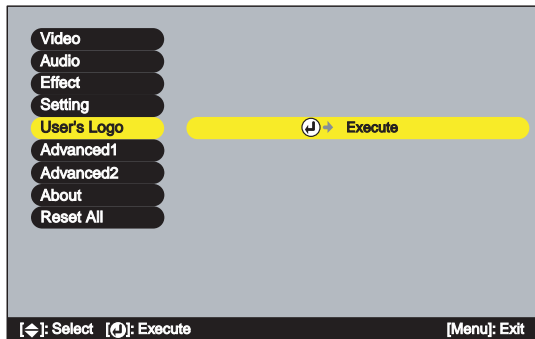

2. When you see the screen shown at right, select **Yes** and press **Enter**. A selection box displays over the image.
3. Use the  pointer button to select the area of the image you want to use. Then press **Enter**.
4. When you see the message “Select this image?” highlight **Yes** and press **Enter**.



note

You can also turn off the message you see when there is no signal, or when you change picture sources or color modes (see page 72).

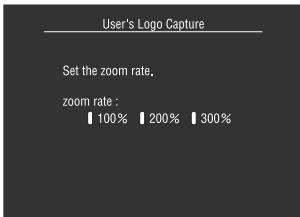

5. Use the arrow buttons to select a zoom rate (display size), and then press **Enter**.
6. When the message “Save image as user’s logo?” appears, select **Yes** and press **Enter**. Confirm as needed.

Saving the logo may take a few moments. Do not use your projector or video source (computer, DVD player, etc.) while the logo is being saved.

7. When you see the message “Completed,” press **ESC** to return to the menu screen.

Choosing When to Display the Image

After your image is saved, you can set it up as the startup screen, or the screen you see when there’s no signal or when you press the **A/V Mute** button (see page 53).

1. Press the **Menu** button to display the menu screen (if not already displayed).
2. To display your image as the startup screen, highlight the **Advanced 1** menu, then press **Enter**. Select **Startup Screen**, highlight **ON**, then press **Enter**.

To display your image on the No-Signal or A/V Mute screen, continue with the following steps.

3. Highlight the **Setting** menu, then press **Enter**.
4. Select the screen(s) on which you want your image to appear:
 - Highlight **No-Signal Msg.** if you want to display your image (instead of a blank screen) when there is no video signal incoming from the currently selected source.
 - Highlight **A/V Mute** if you want your image to appear when you press the **A/V Mute** button.
5. Select **Logo**, then press **Enter**. This sets your image as the screen to be displayed. (Or select **Blue** if you prefer to display a blue screen instead.)
6. When you’re finished, press **ESC** to exit.

note

*To be able to preview images on an external monitor after pressing A/V Mute (see page 28), select **Black** as the A/V Mute screen color.*

4

Fine-tuning the Projector

You can use the projector's on-screen menus to adjust the image, sound, and other features. This chapter covers the following information:

- Using the menu system
- Adjusting the image quality
- Adjusting the image size, shape, and position
- Adjust the color
- Adjusting the sound
- Customizing projector features

Using the Menu System

You can use the remote control (or the projector's control panel) to access the menus and change settings. Follow these steps:

1. To display the menu screen, press the **Menu** button.

You see a menu screen similar to the one shown below (the settings may differ from those shown here, depending on the selected input source):

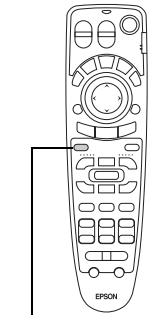

Menu button

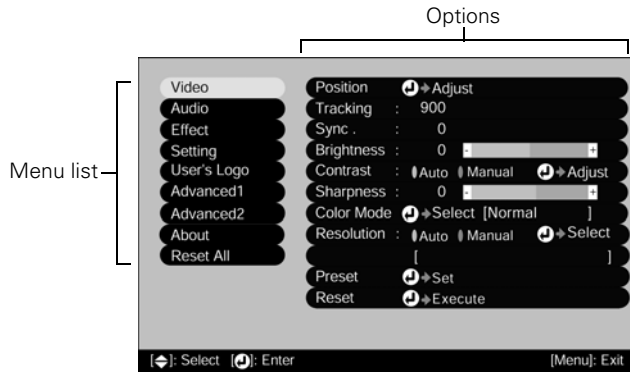



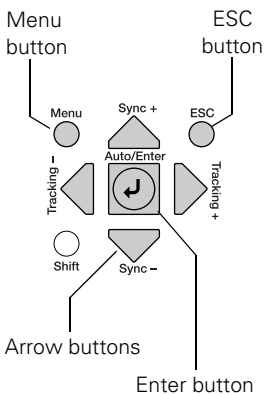

note

You can also use the buttons on the projector to access the menu system:



The menus are listed on the left, and the options available for the highlighted menu are shown on the right.

2. Use the  pointer button on the remote control (or the arrow buttons on the projector) to scroll through the menu list. When you've highlighted the desired menu, press the **Enter** button to select it.
3. Once you've selected the menu, use the  pointer button to scroll through the list of options. (Some of the options may be grayed out or unavailable, depending on the selected source.)

4. After highlighting the option you want to adjust, use the  pointer button to change the setting. In some cases, you may have to press the **Enter** button to see a sub-screen for changing the setting.
 - Press the left or right side of the  pointer button to adjust a slider bar.
 - To select from two or more settings, use the  pointer button to highlight the desired setting, then press **Enter**.
5. After changing the settings, press the **ESC** button to save your changes and return to the previous menu (or press it repeatedly to exit the menu system).



You can also press the **Menu** button to exit.

Restoring the Default Settings

You can use the menu system's **Reset** options to restore the factory-default settings for:

- all the settings listed in a specific menu
- all the settings in all menus

To restore the settings in a specific menu, enter the menu whose settings you want to change, select **Reset**, and confirm as needed. (The example below shows how to reset the **Video** menu.)

note

*The **Reset All** option does not reset the **Input signal**, **User's Logo**, **Language**, **Projector ID**, **Network**, and **Lamp** settings.*

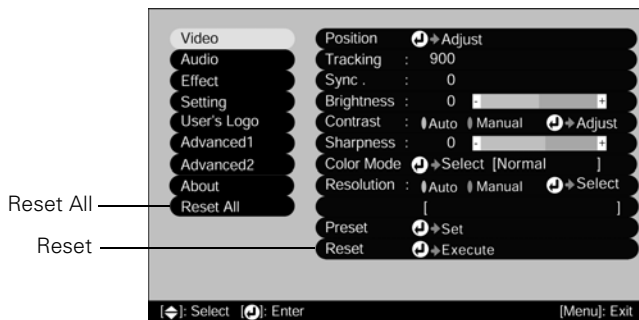

To restore all the projector settings to their factory-default values, select **Reset All**.

Adjusting the Image Quality

You can use the Video menu to adjust the brightness, sharpness, and contrast. If you're projecting from a computer (but not through the DVI port), there are additional adjustments you can make (see page 65).

1. Press the **Menu** button on the remote control, then enter the **Video** menu.

You see the Video menu screen (the actual settings may vary, depending on the selected input source).

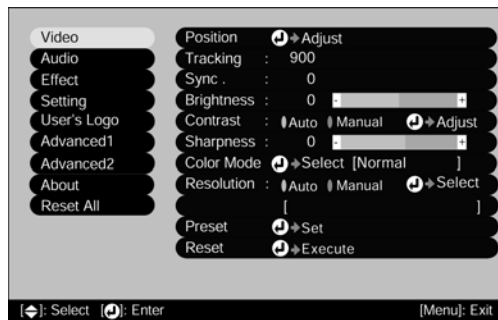

2. Use the  pointer button to highlight the desired option, then adjust it as needed:

- **Brightness**
Lightens or darkens the overall image.
- **Contrast**
Adjusts the difference between light and dark areas. If you're projecting from a computer, select **Auto** to let the projector adjust the contrast automatically; or select **Manual** and then press **Enter** to adjust the setting yourself.
- **Sharpness**
Adjusts the sharpness of the image.

note

The **Brightness** setting changes the opacity of the projector's LCD panels. You can also adjust the brightness of the lamp itself. Select **Brightness Control** in the **Advanced2** menu, then choose **High** or **Low** (the default setting is **High**). Selecting the low brightness setting extends the life of the lamp (see page 94).

Adjusting Computer Images

When you're projecting an analog RGB computer image, there are several additional settings you can use to adjust the image.

■ Auto button

If your computer image doesn't look correct, press the **Auto** button on the remote control (or the **↵ Auto/Enter** button on the projector). This automatically resets the projector's tracking, sync, resolution, and position settings.

If further adjustment is needed, you can change these settings manually as described below.

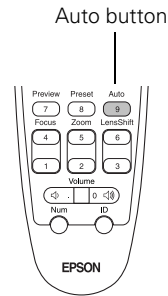

note

These settings do not pertain to digital RGB images transmitted through the DVI port.

■ Tracking and Sync (in the Video menu)

If your image contains a lot of fine detail (such as text), you may notice one or more vertical stripes or bands, or some of the details may look heavy or blurred. You can adjust the **Tracking** and **Sync** settings manually:

1. Fill the screen with an image containing fine detail when making these adjustments. For example, in Windows you can select a pattern to appear as your desktop background. If this option isn't available, try projecting black text on a white background.
2. Press the **Menu** button on the remote control, then enter the **Video** menu.
3. Adjust the **Tracking** to eliminate vertical stripes by pressing the left or right side of the  pointer button.

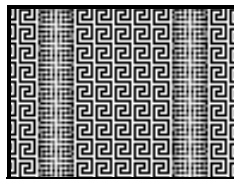

- Adjust the **Sync** setting to reduce blurriness by pressing the left or right side of the  pointer button. (Be sure to adjust the tracking first for best results.)

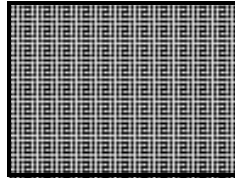

- **Resolution (in the Video menu)**

If your image is distorted (compressed, stretched, partially cut off, or doesn't completely fill the display area), the projector's resolution setting may not match that of your computer. Select **Auto** to let the projector adjust the resolution automatically; or select **Manual** and then press **Enter** to adjust the setting yourself.

- **Position (in the Video menu)**

If the image is slightly cut off on one or more sides, it may not be centered exactly. You can use this setting to center it.

- **Preset (in the Video menu)**

Once you've fine-tuned the settings in the Video menu for the computer you're using, you can save them as a group, using one of the ten **Preset** settings:

- From the Video menu, select **Preset** and press **Enter**.
- Select a number (1 to 10).
- Press **Enter**, then select **Yes** to overwrite.
- Press **ESC** to exit the menu system.

The next time you use the same computer, simply press the **Preset** button on the remote control to recall your saved settings. (Press the **Preset** button repeatedly to select the number corresponding to the **Preset** setting you want to use.)

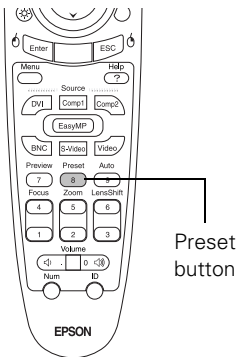

Adjusting the Image Size, Shape, and Position

Whether you're projecting from a computer or video player, you can use these settings to adjust the size, shape, and position of the image.

■ Resize button

Adjusts how an image fits into the display area.

For computer images, resizing is normally unnecessary, since the projector automatically resizes the image to make the best use of the display area. If you press the **Resize** button on the remote control, the projector displays the image at the output resolution of the computer (which make the image larger or smaller, depending on its resolution). If the resolution of the image is the same as the projector's (1024 × 768), pressing **Resize** has no effect.

For video images, pressing **resize** switches the aspect ratio between 4:3 and 16:9. This lets you play certain digital video images or movies recorded on certain DVDs in 16:9 widescreen format.

■ Keystone (in the Setting menu)

Squares up the shape of the image after the projector has been tilted upward or angled to one side (see page 40). If you notice lines or edges looking jagged after adjusting the shape, decrease the Sharpness setting (see page 64).

■ Position (in the Video menu)

If the image is slightly cut off on one or more sides, it may not be centered exactly. You can use this setting to center it.

note

If your computer image is stretched, compressed, or doesn't fit correctly on the screen, you should try adjusting the Resolution setting first (see page 66).

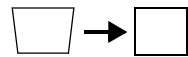

Adjusting the Color

The projector provides several ways for you to adjust the color:

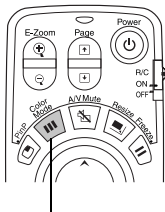

Color Mode button

- **Color Mode button (also in the Video menu)**
Lets you quickly adjust the color and brightness for various environments. Use either the remote control or the **Color Mode** setting in the Video menu. Select **sRGB** for standard computer displays (the default when projecting from a computer with analog video), or select one of the other color settings. You can save a different setting for each computer and/or video source.
- **Color (in the Video menu)**
Adjusts the color intensity, from black-and-white to full color (not available for adjusting computer images).
- **Tint (in the Video menu)**
Adjusts the balance of magenta to green (not available for adjusting computer images).
- **Color Adjustment (in the Advanced1 menu)**
Adjusts the color temperature. Select **Color Temp.** to set a temperature between 5000 and 10000 °K. Or select **RGB** to adjust individual red, green, and blue values, as shown. (Not available if **sRGB** is selected as the Color Mode setting.)
- **Black Level (in the Advanced1 menu)**
Adjusts the brightness of dark shades without affecting the brightness of light shades.
- **White Level (in the Advanced1 menu)**
Adjusts the brightness of light shades without affecting the brightness of dark shades.

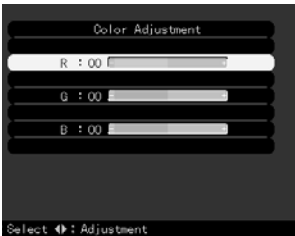



Adjusting the Sound

You can use the Audio menu to adjust the sound volume or treble/bass balance.

1. Press the **Menu** button on the remote control, then enter the **Audio** menu.

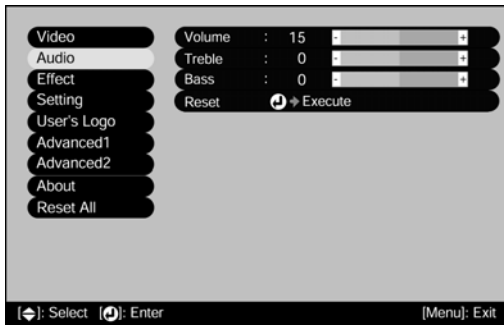
You see the Audio menu screen:



2. Use the  pointer button to highlight the desired option, then adjust it as needed:
 - Volume
 - Treble
 - Bass

note

You can also adjust the volume using the remote control.

Customizing Projector Features

You can use the menu system to change the video signal input at certain ports, turn on or off sleep mode, adjust the network settings, change the language, and customize several other features.

Image Setup Options

Use these settings to change how the projector processes incoming video signals. Several of these settings should normally be left at the factory default setting (except for the Computer1, Computer2, and BNC Input settings).

- **Computer1 Input (in the Setting menu)**
Select the setting for the type of equipment you've connected to the Computer 1 port:

Analog-RGB: For a computer connection

RGB-Video: For a video player that outputs an RGB video signal
- **Computer2 Input (in the Setting menu)**
Select the setting for the type of equipment you've connected to the Computer 2 port, as described above.
- **BNC Input (in the Setting menu)**
Select the setting for the type of equipment you've connected to the BNC port:

Analog-RGB: For a computer connection

RGB-Video: For a video player that outputs an RGB video signal

YCbCr: For a video player that outputs an NTSC signal

YPbPr: For a video player that outputs an HDTV signal
- **Video Signal (in the Video menu)**
Leave this setting at **Auto** unless you are using a 60-hertz PAL system (select **PAL60**). You can change this setting only if you're displaying an image through the Video or S-Video port.
- **Progressive (in the Advanced1 menu)**
This setting converts interlaced to progressive signals. Leave the setting on **Film/Auto** to automatically detect video recorded at

24 frames per second (fps) and convert it to 60 fps for a more natural appearance; or select **Video** to prevent frame conversion. Selecting **OFF** projects interlaced signals without converting them to progressive, which improves the look of images that contain a lot of movement.

- **BNC Sync Termination (in the Advanced2 menu)**
This setting should normally be left **OFF** (for TTL input). If an analog (75-ohm) terminator is required, as for a switcher, change the setting to **ON**.

Communication Setup Options

These options let you set up the projector so it can be monitored and controlled from a remote computer (see Chapter 5).

- **Standby Mode (in the Advanced1 menu)**
Select **Network ON** to enable the projector to be monitored and controlled over a network, as described in Chapter 5, when it's in standby mode (plugged in but not turned on).

This setting also lets you view images on an external monitor during standby, if the monitor has been connected to the projector's Monitor Out port (see page 28). The projector does not go into full sleep mode (see page 43) when this setting is in effect.

- **Network (in the Advanced2 menu)**
Used for managing the projector over a network (see Chapter 5). If the network assigns addresses automatically, turn on **DHCP**. Otherwise, turn off **DHCP** and enter the projector's **IP Address**, **Subnet Mask**, and **Gateway Address**, if applicable.

If you want to monitor the projector using a network management utility, select **SNMP** and enter at least one trap IP address.

- **COM Port (in the Advanced2 menu)**
Used for communicating with a computer running EMP Link21L utility software. Select **RS-232C** or **USB**, depending on the port

note

When this setting is on, you cannot view or change the projector's network settings.

note

Press the Num button on the remote control to use the number keypad.

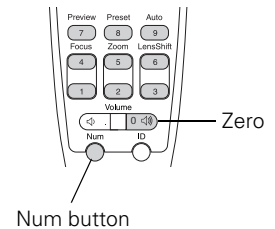

that is being used for communication with the computer. Turn off the projector and then turn it back on for the new setting to take effect.

Miscellaneous Setup Options

- **No-Signal Msg. (in the Setting menu)**
Selects a screen color or image to display when the projector is not receiving a signal. The logo setting displays an image that you previously transferred to the projector (see page 59).
- **Prompt (in the Setting menu)**
Turns off the identifying text that appears briefly when you switch picture sources or change color modes. (It's best to leave this on.)
- **Sleep mode (in the Setting menu)**
When sleep mode is on, the projector turns off the lamp if it has not received any input signals for 30 minutes. Turn sleep mode off if you want the lamp to remain on all the time (this is the default setting).
- **Rear Proj. (in the Advanced1 menu)**
Turn on to project from behind onto a transparent screen.
- **Ceiling (in the Advanced1 menu)**
Turn on when the projector is mounted upside-down from the ceiling.
- **Language (in the Advanced1 menu)**
Select from nine languages to be used for the projector menus.

5

Managing the Projector from a Remote Computer

note

You may also be able to monitor your projector(s) through a network management utility, such as HP OpenView.™ You'll need to install a plug-in for your system provided by EPSON, then enter a trap IP address using the SNMP option in the projector's menu system (see page 77).

Your projector's EasyManagement software lets you monitor and control your projector(s) from a remote computer. (The topics covered in this chapter are intended for use by network administrators.)

- Use EMP Monitor to see your projectors' status, switch image sources, and control basic settings.
- Use EMP NetworkManager to receive e-mail notifications alerting you to possible problems.

To use the EasyManagement software, first install it as described on page 74. Then connect and configure each projector you want to monitor, so it can be recognized on your network (see page 76).

This chapter covers the following:

- Installing the EasyManagement software
- Configuring the projector to your network
- Using EMP Monitor
- Using EMP NetworkManager

Installing the EasyManagement Software

The projector software CD-ROM includes the software you need to use the projector's EMP Monitor and EMP Network Manager.

System Requirements

Before you install the software, make sure your computer meets these requirements:

- Microsoft® Windows 98 SE, 2000, NT 4.0 (service pack 6a or later), Me, or XP
- IBM® compatible with at least a Pentium® MMX 166 MHz processor (Pentium II 233 MHz or better recommended)
- At least 256MB of RAM
- At least 7MB of free hard disk space
- XGA (1024 × 768) or better display adapter and monitor

note

The software cannot be installed on Macintosh systems.

Installing the Software

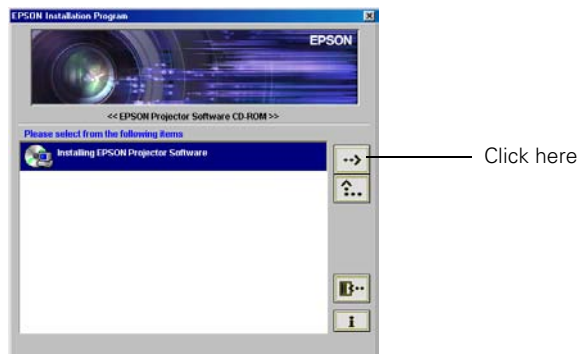

Follow these steps to install the software:

1. Insert the projector software CD-ROM in your computer's CD-ROM drive. You see this screen:



2. Click the  button to advance to the next screen.



3. If you want to receive e-mail notifications when projector problems occur, make sure the option to install **EMP Network Manager** is highlighted, then click the  button. Follow the instructions on the screen to finish installing it.
 4. If you want to be able to manage the projector remotely from this computer, select the option for **EMP Monitor** and install it the same way.
 5. When done installing the software, click the  button to exit.
- Once installed, you can access these programs from your computer's Start menu.

note

If you need to uninstall the software, use the Add/Remove Programs utility in the Windows Control Panel.

Connecting and Configuring the Projector

Before using the EMP software to manage your projector(s), you have to connect each projector you want to monitor to your network and configure it with an appropriate IP address.

1. Connect the projector to your network using a commercially available 100baseTX or 10baseT network cable.

Connect the cable to the ethernet port on the projector as shown.

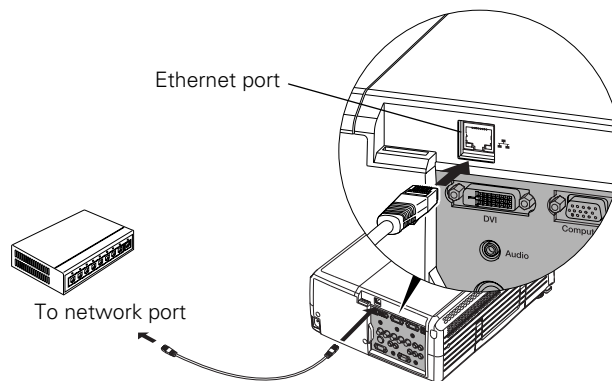

note

Make sure the Standby Mode setting in the Advanced1 menu is off, or you won't be able to view or change the projector's network settings.

2. Turn on the projector (see page 32).
3. Press the Menu button on the remote control and select **Network** from the **Advanced2** menu.

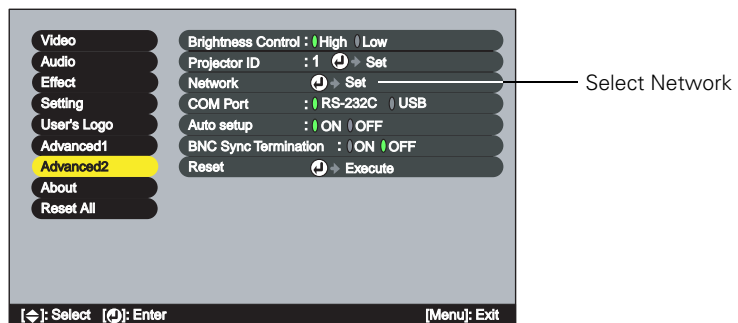

4. If your network assigns addresses automatically, turn on DHCP.

- If your network does not assign addresses automatically, turn off DHCP and enter the projector's IP Address, Subnet Mask, and Gateway Address, as needed.

- To enter numbers using the remote control, press the Num button until it lights, then use the number keypad shown below.

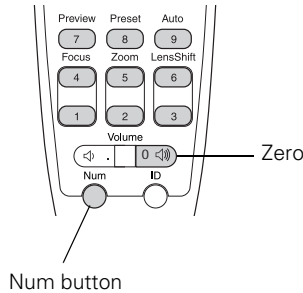

- To change the network addresses from the projector's control panel, press the right and left arrow buttons to select the part of the address you want to enter, then use the up and down arrow buttons to increase or decrease the numeric value.

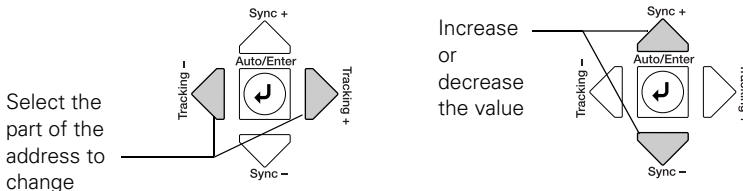

When you finish changing an address in the network menu, press the Enter button (on the remote control) or the **Auto/Enter** button (on the projector). This stores the value.

- When done making all necessary changes, press ESC to exit the menu system.

note

If you're a network administrator, you can use the SNMP option to enter a trap IP address. This lets you monitor the projector using a network management utility.

Using EMP Monitor

EMP Monitor lets you manage up to 64 projectors from a remote computer. This lets you easily turn the projectors on or off (together or individually), switch image sources, and check on their status.

Before using EMP Monitor, make sure you've installed the software as described on page 74. The computer you're using to monitor the projector should already be connected to your network.

Opening and Closing EMP Monitor

To open the program, select EMP Monitor from the Start menu.

If you've added the program to the Startup programs folder (see page 83), then it may already be open. If so, click the icon in the system tray on the lower-right corner of your screen to display the EMP Monitor window:



Click here to open monitor window

To close EMP Monitor, right-click the program icon shown above, then select Exit.

Registering a Projector

Before you can monitor a projector, you have to register it. Follow these steps:

1. Open EMP Monitor as described above. You see this screen:

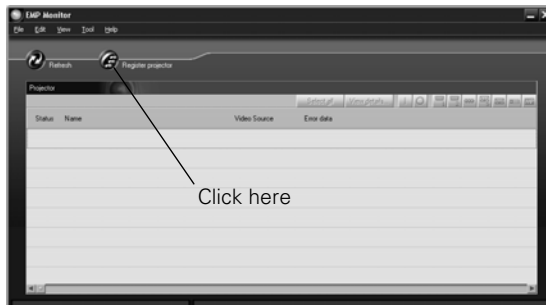

Click here

2. Click Register projector as shown.

You see this screen:



3. Click Auto detect to locate projectors currently operating on the network. Or click Manual registration and enter the projector's name and network address.

Any projectors found on the network are listed as shown below:

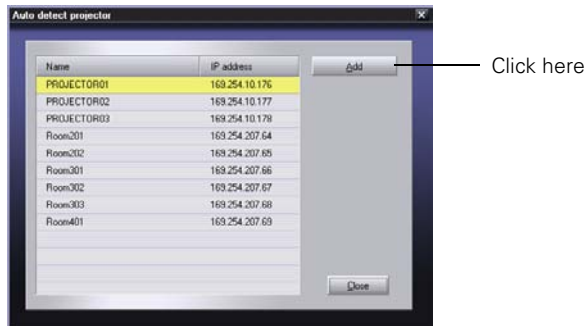

4. Select the projectors you want to add by clicking their name. Then click Add, and on the next screen click Close.

note

If the name of a projector does not appear, you can give it a name or change its existing one in EMP NetworkManager (see page 87).

note

To delete a projector from the list, click Register projector, highlight the projector name, and click Delete.

You see your registered projectors listed on the main EMP Monitor screen:



note

To monitor a projector when it's in standby mode (plugged in but not turned on), you must select Network ON as the Standby Mode setting in the projector's menu system (see page 71).

Monitoring Your Projectors





The EMP Monitor screen lets you monitor your projectors using the Status, Video Source, and Error icons shown below. This lets you see which projectors are currently being used, from which source (or port) they are projecting an image, and if a problem occurs.



For detailed status information, select the projector in question and click View details.







The following table explains the meaning of the status icons:

Status icons

 (green)	Projecting; no problems
 (dark)	Turned off; no problems
 (green)	Projecting; problems detected
 (dark)	Turned off; problems detected
	Network error (for example, not connected to network, or power cable disconnected). You may also see this error if Standby Mode is turned off (see page 71).







The following table explains the meaning of the video source icons:

Video source icons

	Computer 1
	Computer 2
	BNC
	S-Video
	Video
	DVI

The following table explains the meaning of the error icons (see page 101 for recommended solutions to problems):

Error icons

	Lamp replacement notification (the lamp is nearing the end of its life; see page 94)
	High-speed cooling in progress (the projector is getting too hot but continues to operate)
	Overheating (projection turned off automatically)
	Lamp out or lamp cover open
	Fan error
	Sensor error
	Internal problem

Controlling Your Projectors

The control buttons in the upper-right let you turn on and off the projectors and select video sources. (Hold the mouse pointer over a button to see a description of its meaning.) Make sure you've selected the projector(s) you want to operate (with the mouse pointer) before clicking one of the buttons.

note

To turn on a projector when it's in standby mode (plugged in but not projecting), you must have selected Network ON as the Standby Mode setting in the projector's menu system (see page 71).

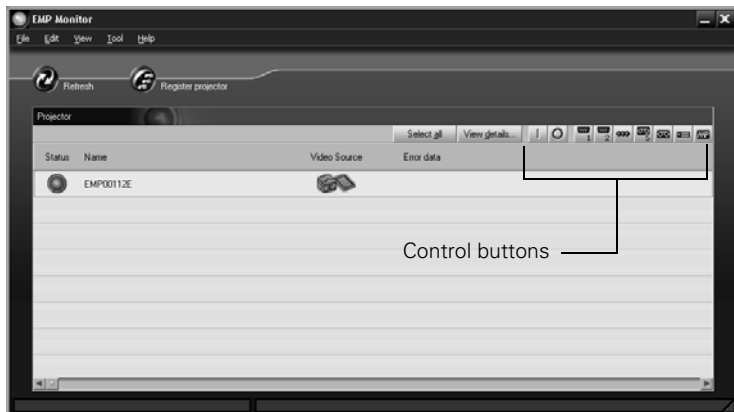

Configuring the Monitoring Interval

If you need to have the most current status information about your projectors, click the **Refresh** button in the EMP Monitor screen.

You can also select how often EMP Monitor checks the projector status:

1. From the Tool menu, select **Configuration**.

You see this screen.

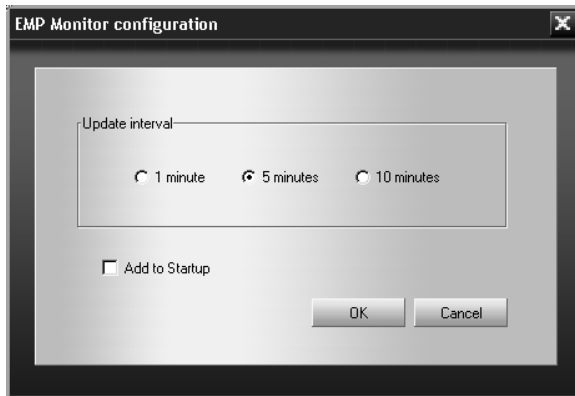

note

If you want the program to run whenever you start your computer, click Add to Startup.

2. Select the desired update interval and click **OK**.

Using EMP NetworkManager

You can use EMP NetworkManager to send out messages by e-mail, notifying you when a problem occurs with a projector. Before running EMP NetworkManager, make sure you've installed the software as described on page 74. Then follow the steps below to create e-mail settings for each projector you want to monitor.

Selecting the Projectors to Monitor

1. To open the program, select EMP NetworkManager from the Start menu.

You see this screen:



2. If you'd like to monitor the projectors you've already registered using EMP Monitor, click Import.

Your imported projectors are displayed as icons as shown:

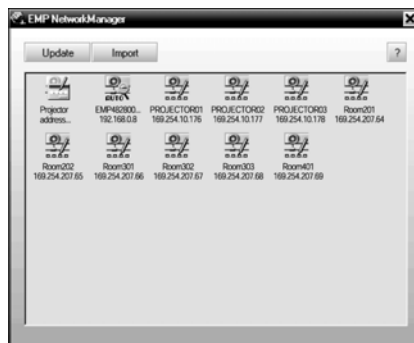

3. If you'd like to register a projector manually and you know its IP address, click the **Projector address selection** icon.

You see this screen:

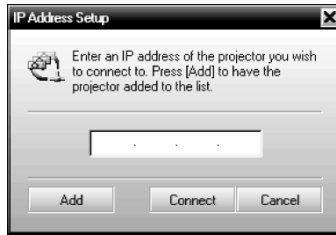

4. Enter the projector's IP address and click **Add**. The projector's icon is added to the EMP NetworkManager screen.

Setting a Password

You can set a password to restrict access to each projector from EMP NetworkManager:

1. Right-click the icon of the projector whose password you want to set, then select **Change Password**.



2. Enter a password up to 14 characters in length.

Creating the E-Mail Settings

1. If EMP NetworkManager is not already running, open it from the Start menu.

You see your registered projectors displayed as shown:

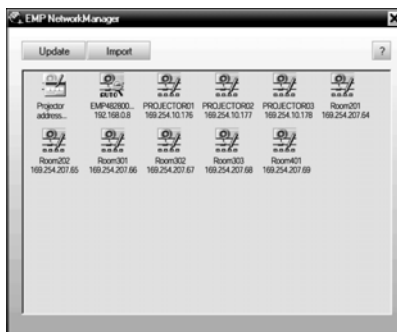

2. Double-click the icon for the projector whose e-mail settings you want to create. Enter your password, if you created one (see page 85).
3. EMP NetworkManager connects to the projector, and you see this screen:

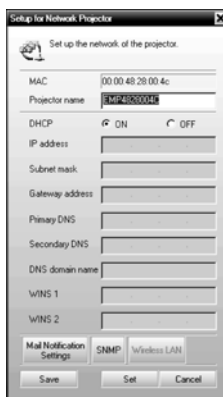

4. Verify that the network settings are correct.
 - Make any desired changes to the projector's network address configuration (turning off DHCP enables the manual settings).

note

The projector must be plugged in (projecting or in standby mode) for you to be able to connect to it.

*To access a projector in standby mode, you must select **Network ON** as the **Standby Mode** setting in the projector's menu system (see page 71).*

- You can give the projector a name—up to 15 characters long—using alphanumeric characters only, including the hyphen (-).

Naming the projector helps you identify it in EMP Monitor and EMP NetworkManager. This is especially useful if you're managing more than a few projectors.

5. Click **Mail Notification Settings**.

You see this screen:



6. Select **ON** for the Mail Notification setting.
7. Enter the IP address and port number of the SMTP server used for sending e-mail. (The port's default setting is 25, but you can enter any number from 1 to 65535.)
8. Enter up to three e-mail addresses where you want the event notification messages to be sent.
9. Click the **Setting a Notification Event** button next to each address, then select the conditions under which you want a message to be sent.
10. Click **OK**, then on the next screen click **Set**. Confirm as needed.
11. When you see the test message window, you can send a message with the heading "TEST MAIL" to the addresses you have entered. The projector's name and IP address are included in the body of the message.
12. When done making all your projector settings, close the EMP NetworkManager. (It does not have to be open for messages to be sent or received.)

note

A no-signal message is reported when no image signals are being input to a projector. If the projector will not normally be displaying an image, do not select 'no signal' as a condition for which you want a message to be sent.

Understanding the Notification Messages

If a projector experiences a problem, it sends an e-mail message to each of the addresses you provided using EMP NetworkManager. The message includes the heading “EPSON Projector” in the subject line.

The body of the message contains:

- the name of the projector
- the projector’s IP address
- a description of the problem

The problem descriptions are similar to the errors reported by EMP Monitor (see page 82).

If a plus (+) sign appears before the description, it indicates that a problem has occurred. A minus (–) sign appears when the problem goes away or is resolved.

note

If a projector develops a critical problem, it may not be possible for it to report the error.

6

Maintaining the Projector

Your projector needs little maintenance. All you have to do on a regular basis is keep the lens clean. Any dirt or smears on the lens may show up on your projected image.

You also need to periodically clean the air filter on the side of the projector. A clogged air filter can block ventilation needed to cool the projector.

The only parts you should replace are the lamp and air filters (when you order a new lamp, replacement filters come with it). If any other part needs replacing, contact your dealer or a qualified servicer.

This chapter covers the following:

- Cleaning the lens
- Cleaning the projector case
- Cleaning and replacing the air filters
- Replacing the lamp
- Transporting the projector

warning

Before you clean any part of the projector, turn it off and unplug the power cord.

Never open any cover on the projector, except the lamp and filter covers. Dangerous electrical voltages in the projector can injure you severely. Do not try to service this product yourself, except as specifically explained in this User's Guide. Refer all other servicing to qualified service personnel.

Cleaning the Lens

Clean the lens whenever you notice dirt or dust on the surface.

- Use a canister of compressed air to remove dust.
- To remove dirt or smears on the lens, use lens-cleaning tissue. If necessary, moisten a soft cloth with lens cleaner and gently wipe the lens surface.

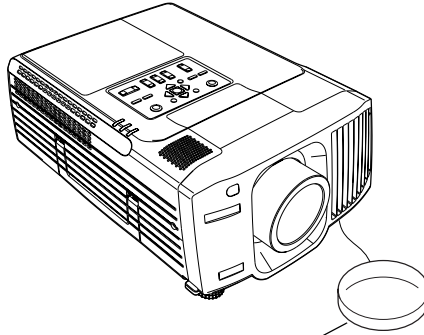

Remove the cap before cleaning

Cleaning the Projector Case

Before you clean the case, first turn off the projector and unplug the power cord.

- To remove dirt or dust, wipe the case with a soft, dry, lint-free cloth.
- To remove stubborn dirt or stains, moisten a soft cloth with water and a neutral detergent. Then wipe the case.
- Do not use wax, alcohol, benzene, thinner, or other chemical detergents. These can damage the case.

Cleaning and Replacing the Filters

The projector has several filters that should be cleaned periodically to remove trapped dust. If the filters become clogged, the projector can overheat and damage can result. Clean the filters approximately every three months, or after every 100 hours of use; clean them more often if you use the projector in a dusty environment.

Cleaning the Lamp Filter

To clean the lamp filter, follow these steps:

1. Remove the lamp as described on page 94.
2. Hold the shutter open and use a vacuum cleaner (a small one designed for computers and office equipment) to remove any dust from the wire mesh filters inside.

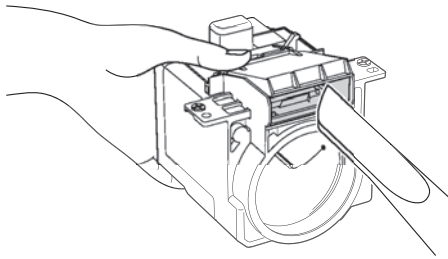

3. Insert the lamp back into the projector, tighten its screws, and replace the lamp cover.

caution

Avoid touching the glass portion of the lamp. Oils transferred from your hands can cause the lamp to overheat and fail prematurely.

Cleaning the Air Intake Filters

To clean the air intake filters, follow these steps:

1. Turn off the projector and unplug the power cord.
2. Use a computer vacuum to clean the filters. If you don't have one, gently clean the filters with a soft brush, such as an artist's paintbrush.

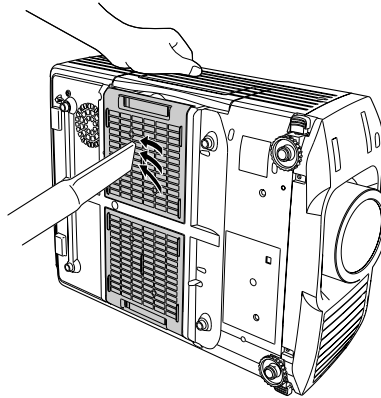

note

When you get a replacement lamp for your projector, new air filters are included. You should replace the filters when you replace the lamp.

3. If the dirt is difficult to remove or a filter is broken, replace the filters as described in the next section. Contact your dealer or call EPSON at (800) 873-7766 in the United States to obtain new ones. In Canada, please call (800) 463-7766 for dealer referral.

Replacing the Filters

1. Turn the projector over (unless it's ceiling-mounted).
2. Remove the filters by sliding them out to the sides.

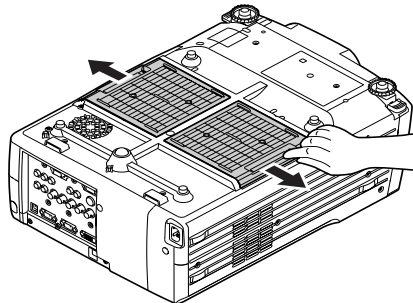

3. Remove each filter from its holder by releasing the two tabs, as shown.

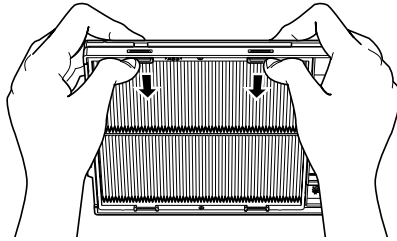

4. Install new filters in the holders, aligning the tabs with the slots on each side.

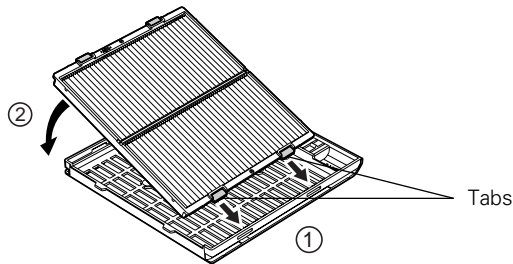



5. Slide the assembled filters back into the projector.

Replacing the Lamp

The projection lamp typically lasts from 2000 to 3000 hours, depending on the Brightness Control setting used (see page 64). Selecting the low brightness setting helps extend the lamp's life.

It is time to replace the lamp when:

- The projected image gets darker or starts to deteriorate.
- The message **LAMP REPLACE** appears on the screen and the lamp warning light  flashes orange.
- The lamp warning light  flashes red (the lamp is burnt out).

Contact your dealer or call EPSON at (800) 873-7766 in the United States for a replacement lamp. Request part number V13H010L23. In Canada, please call (800) 463-7766 for dealer referral.

Follow these steps to replace the lamp:

1. Turn off the projector.
2. When the power light stops flashing, unplug the power cord.
3. Let the projector cool for at least half an hour (if it has been on). The lamp is extremely hot immediately after use.
4. If the projector is mounted on the ceiling, remove the rear cover.

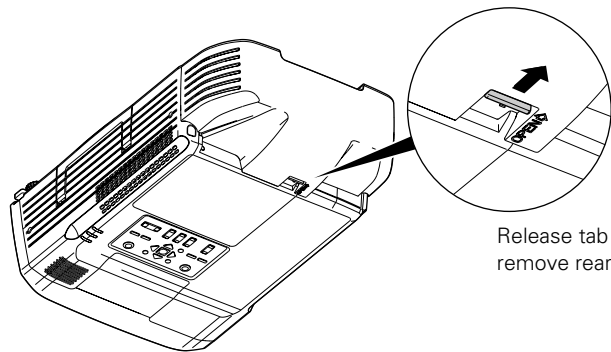

Release tab to
remove rear cover

note

You can check how long the lamp has been in use (see page 96).

Lamp life results will vary depending on environmental conditions and usage. Turn the projector off when not in use. Continuous 24-hour-a-day use may reduce the overall life of this product.

warning

Let the lamp cool fully before replacing it.

In the unlikely event that the lamp has broken, small glass fragments may be present and should be removed carefully to avoid injury.

- Loosen the lamp cover screws (you don't need to take them out all the way). Then remove the cover.

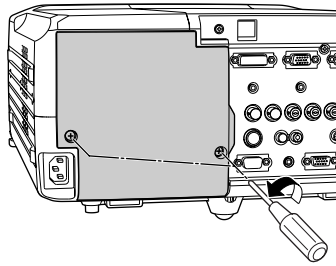

- Loosen the three screws holding the lamp in place (you can't remove them).

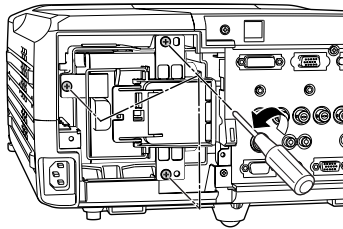

- Grasp the wire handle as shown and pull the lamp straight out.

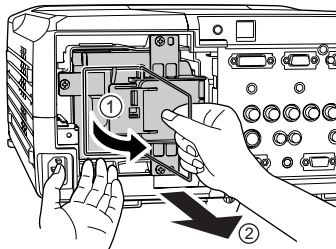

- Gently insert the new lamp.
- Once the lamp is fully inserted, tighten its screws and replace the cover. (The projector won't come on if the lamp cover is loose.)
- Reset the lamp timer as described in the next section.

caution

Avoid touching the glass portion of the new lamp. Oils transferred from your hands can cause the lamp to overheat and fail prematurely.

note

(Hg) *The lamp(s) in this product contain mercury. Please consult your state and local regulations regarding disposal or recycling. Do not put in the trash.*

When you get a replacement lamp for your projector, new air filters are included. This is a good time to install them (see page 92).

Resetting the Lamp Timer

After you replace the lamp, you need to reset the lamp timer using the projector's menu.

1. Press the **Menu** button on the remote control (or on the projector's control panel). You see the main menu.
2. Use the  pointer button on the remote control (or the arrow buttons on the projector) to highlight **About**, then press **Enter**.

You see this screen:

note

The lamp usage timer shows 0H until you've used the lamp for at least 10 hours.

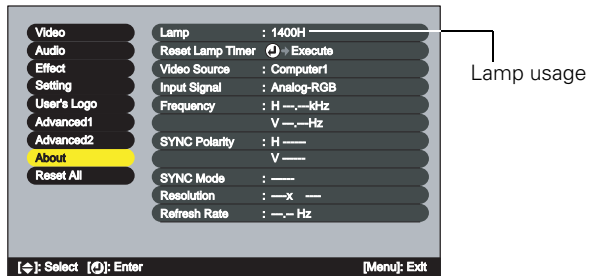

3. Select **Reset Lamp Timer**, then press **Enter**. You see this prompt:

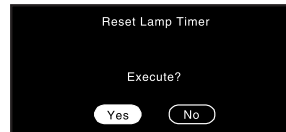

4. Select **Yes**, then press **Enter**.
5. When you're finished, press **ESC** or **Menu** to exit.

Transporting the Projector

The projector is heavy and contains many glass and precision parts. Follow these guidelines to prevent injury or damage:

- When hand-carrying the projector, you should use the handle to lift it only a short distance (for example, to set it on a table). To move the projector over longer distances, place it on a rolling cart or use a dolly.

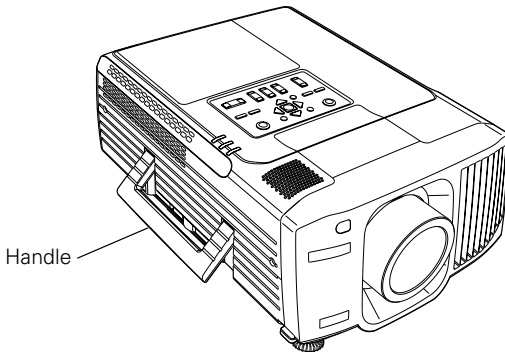

- When shipping the projector for repairs, use the original packaging material if possible. If you do not have the original packaging, use equivalent materials, placing plenty of cushioning around the projector.
- When transporting the projector a long distance, first place it in a hard-shell shipping case, and then pack it in a firm box, placing cushioning around the case. (An optional shipping case is available from EPSON; see page 12.)
- It's a good idea to turn off the remote control before packing it in a carrying case. This prevents the batteries from discharging if something presses against one of the buttons.

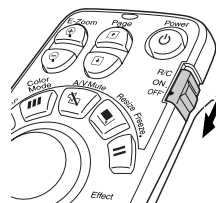

warning

The projector is heavy (24 lbs.). Use care when handling it to prevent physical strain or injury.

note

EPSON shall not be liable for any damages incurred during transportation.

7

Solving Problems

This chapter helps you solve problems with your projector, and tells you how to contact technical support for problems you can't solve yourself.

note

You can also get on-screen help by pressing the blue ? Help button on the projector or remote control. Follow the instructions on the screen.

If the projector is not working correctly, first look at its status lights and check for possible solutions on page 100. If you're having a problem with the image or sound, see page 104; for the remote control, see page 109.

This chapter covers the following:

- Checking the projector's status lights
- Solving problems with the image or sound
- Solving problems with the remote control
- Contacting technical support

Checking the Projector Status

If you're having a problem with the projector, check the following:

- Check the lights on the top of the projector (as described below). The lights can often tell you about the nature of the problem.
- You can also view the About menu screen (page 103). This gives you information about the lamp life and currently selected input signal.

What To Do When the Lights Flash

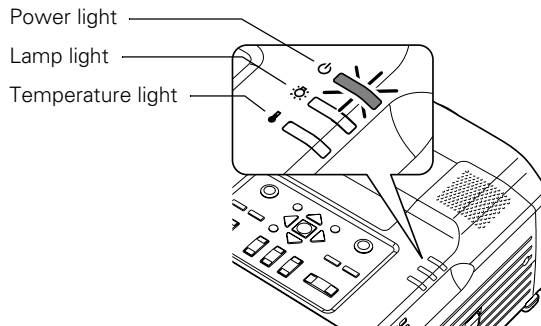

The lights on top of the projector indicate the projector's status and let you know when a problem occurs.







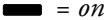

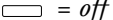



























































If the projector seems to be indicating a problem, locate the pattern of lights in the table on the next page, then follow the recommended solutions.

Use this table to interpret the projector's status lights, then follow the instructions provided:

Status lights

 = *on*  = *flashing*  = *off*

Light	Description and solution
     	<p>If no lights are on, make sure the power cord is connected securely both at the power outlet and the projector. If you have just replaced the lamp, make sure the cover is securely fastened.</p>
<p>Orange</p>      	<p>When the power light is orange, the projector is in sleep mode. Press the Power button to turn it on.</p>
<p>Green</p>      	<p>When the power light is flashing green, the projector is warming up. Wait for the image to appear.</p>
<p>Green</p>      	<p>When the power light is green, the projector is operating normally.</p>
<p>Orange</p>      	<p>When the power light is flashing orange, the projector is cooling down. Do not unplug it until the light stops flashing and remains orange. If you want to turn it back on, wait until the light stops flashing.</p>
<p>Red</p>     <p>Orange</p>  	<p>When the power and temperature lights are flashing, the projector is getting too hot, but you can continue running it in this condition.</p> <p>Verify that the air filter is not clogged. Clean or replace it as described on page 91.</p> <p>Make sure the room temperature is not above 95 °F (35 °C) and there is plenty of space around and under the projector for ventilation.</p>

Light	Description and solution
<p>   Red     Red </p>	<p>When the power and temperature lights are red, the projector has overheated, which turns off the lamp automatically. Wait about 5 minutes for the projector to cool, then unplug the power cord.</p> <p>Verify that the air filter is not clogged. Clean or replace it as described on page 91.</p> <p>Make sure the room temperature is not above 95 °F (35 °C) and there is plenty of space around and under the projector for ventilation. Then plug the power cord back in and press the Power button.</p> <p>If the projector continues to overheat, contact EPSON for help (see page 110).</p> <p>Warning: Except as specifically explained in this <i>User's Guide</i>, do not attempt to service this product yourself.</p>
<p>   Red     Red </p>	<p>When the power light is red and the temperature light is flashing red, there is a problem with the fan or temperature sensor. Unplug the power cord and contact EPSON for help (see page 110).</p>
<p>   Green   Orange   </p>	<p>When the power light is green and the lamp light is flashing orange, the lamp is near the end of its life. To ensure continued operation, you should replace it as soon as possible (see page 94).</p>
<p>   Red   Red   </p>	<p>When the power light is red and the lamp light is flashing red, the lamp has burned out. Replace it as described on page 94.</p> <p>If these lights come on after replacing the lamp, make sure the lamp is fully inserted and the lamp cover is attached.</p>
<p>   Red   Red   Red </p>	<p>If all three lights are red, the projector has an internal problem. Unplug the power cord and contact EPSON for help (see page 110).</p>

Viewing the 'About' Menu Screen

Use the About menu to view information on the display settings of your computer and the number of hours the lamp has been used.

To access the About menu:

1. Press the **Menu** button. You see the projector's main menu screen.
2. Highlight the **About** menu and press **Enter**.

You see the lamp usage hours and various input signal settings on the right:

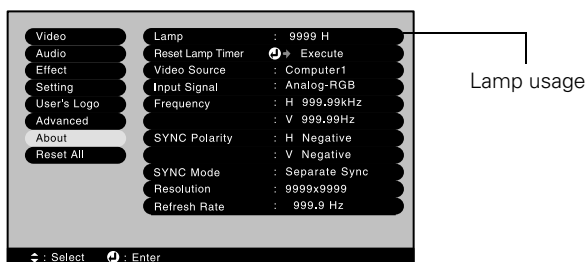

note



The information displayed depends on the input signal currently selected.

The lamp typically lasts from 2000 to 3000 hours, depending on the selected Brightness Control setting (see page 64). If the number shown is close to that, make sure you have a spare lamp handy. (The lamp usage timer shows 0 H until you've used the lamp for at least 10 hours.)

If you've installed a new lamp, be sure to reset the lamp timer (see page 96).



Solving Problems with the Image or Sound

You cannot turn on the projector.

- If you're trying to turn on the projector using the remote control, the remote control may be switched off (there's an on/off switch on its side) or low on battery power. Try pressing the  Power button on the projector instead.
- Make sure the power cord is properly connected, then wait for the  power light to turn orange before pressing the  Power button.

The  power light flashes green for about a minute as the projector warms up, and then it remains green during normal operation. (If the lights display a different pattern, see page 100.)

The projector is powered on, but not projecting an image.

- Press the **A/V Mute** button on the remote control to make sure the picture has not been turned off temporarily.
- The projector may be in sleep mode. If the  power light is orange, press the  Power button to turn on the projector.
- The attached computer may be in sleep mode or displaying a black screen saver. Try pressing a key on the computer.
- If you just replaced the lamp, make sure the lamp is fully inserted and the cover securely reattached, or the projector won't come on.
- If you just turned off the projector, it may still be cooling down. Wait until the power light stops flashing and remains orange; then press the  Power button to turn the projector back on.

You see the message No Signal displayed.

- Make sure the cables are connected correctly, as described in Chapter 1.
- If you've connected a video player, make sure it's turned on and playing.
- If you've connected a laptop computer, make sure it's set to display on an external monitor (see page 35).
- You may need to select the image source (the projector port to which your equipment is connected). To switch sources, press the corresponding **Source** button on the projector or remote control (see page 34). Allow a few seconds for the projector to sync up after pressing the button.

You've connected a laptop, but the projector and laptop don't display the same image.

- You have to enable your laptop to display both on its LCD screen and through its external monitor port (see page 35).

You see the message Not Supported displayed.

- Make sure the correct **Video Signal** is selected in the Video menu (see page 70). It should normally be set to **Auto**.
- Make sure your computer's resolution doesn't exceed UXGA (1600 × 1200), and the frequency is supported by the projector. If necessary, change your computer's resolution to a compatible setting (see page 120).

The image is stretched, compressed, cut off, or doesn't fit on the screen.

- Press the **Resize** button on the remote control to make sure the projector is displaying at the correct resolution or aspect ratio.
- If you've connected equipment to the Computer 1, Computer 2, or BNC port, the wrong input signal setting may be selected. Select the correct setting, depending on the type of computer or video player you've connected (see page 70).
- If you're projecting from a computer, press the **Auto** button (on the remote control) or the **↵ Auto/Enter** button (on the projector). This automatically resets the projector's tracking, sync, resolution, and position settings. (To adjust these settings yourself, see page 65.)
- If you're projecting from a computer, the computer may have been set for dual display. This causes the projector to display only half the image (the right or left side). Access your computer's display settings (as you would to adjust other display properties—see page 35), then turn off dual display. See your computer's manual or online help for details.
- You may have to adjust the **Position** setting if the image is slightly off-center (see page 67).

The image isn't square, but tapered on the sides.

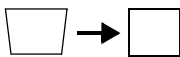

- If you've tilted up the projector by extending the legs, the image will be broader at the top. Try retracting the legs (so that the projector lies flat) and then use the **Lens Shift** button to adjust the height of the image (see page 39).

If you need to extend the legs, you can still square up the image with the **Keystone** button (see page 40).

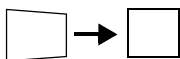

- If the projector is angled toward the screen from the left or right, the image will be broader on one side. Center the projector in the middle of the screen, facing the screen squarely.

If you can't place the projector this way, correct the shape using the **Quick Square** feature in the projector's menu system (see page 41).

The image contains static, noise, or distortion.

- If you're using a video player, make sure the correct **Video Signal** is selected in the Video menu (see page 70).
- If you're using a computer, press the **Auto** button (on the remote control) or the ↵ **Auto/Enter** button (on the projector). This automatically resets the tracking, sync, position, and resolution.
- If you're using a computer cable longer than 6 feet (2 meters), or an extension cable, the image quality may be reduced.
- Keep your computer and video cables away from the power cord as much as possible to prevent interference.
- The video signal may be split between the computer and the projector. If you notice a decline in the projected image quality when the image is displayed simultaneously on your laptop and through the projector, turn off the laptop's LCD display.

The image is blurry.

- There may be dirt or smears on the lens. Clean the lens as described on page 90.
- Adjust the focus using the **Focus** button.
- Make sure the lens is not fogged by condensation. You may need to wait before using the projector after moving it from a cold environment to a warm environment.
- If you're projecting from a computer, press the **Auto** button (on the remote control) or the ↵ **Auto/Enter** button (on the projector). This adjusts the tracking, sync, position, and resolution settings.
- Adjust the **Sharpness** setting on the Video menu (see page 64). When you change video settings, you should be able to see the effect on the screen immediately.



note

Because of the different technologies used, your projected image may not exactly match the colors on your laptop or computer monitor.

The colors of the image are not right.

- If you've connected equipment to the Computer 1, Computer 2, or BNC port, make sure the correct **Input** setting is selected in the **Setting** menu (see page 70). Selecting the wrong setting can cause images to appear green or purple.
- Press the **Color Mode** button on the remote control; you can use the preset options to adjust the projector's brightness and color for various lighting environments.
- You can further adjust the color using various settings in the projector's menu system (see page 68).
- Check your computer display settings to correct the color balance.
- As the lamp nears the end of its life, the image may become darker and the color start to deteriorate. Check the lamp timer to see how long the lamp has been in use (see page 103), and replace the lamp if necessary (see page 94).

There is no sound.

- Make sure the **A/V Mute** button is not enabled.
- Use the **Volume** button to raise the sound-level.
- Make sure the sound cables are connected properly (see page 29). For computer audio, the cable should be connected to the computer's  headphone jack or  audio out jack.
- For computer audio, make sure the volume control on your computer is not turned all the way down or muted. On a PC, you may be able to check this by clicking the volume control in your Windows System Tray (in the lower-right corner of the screen).

Solving Problems with the Remote Control

The projector doesn't respond to remote control commands.

- Make sure the remote control is turned on using the switch on its side (see page 46).
- Make sure the remote control ID matches the ID of the projector you want to operate (see page 48). If you don't know the projector ID, set the remote control ID to zero; this lets it work with any projector.
- If you've held down the  pointer button for more than 10 seconds, the remote control may have gone into sleep mode. Releasing the button restores normal operation.
- The remote control's batteries may not be installed correctly or may be low on power. To change the batteries, see page 50.
- Make sure you are within 30 feet (9 meters) of the projector, and within range of the projector's front or back sensor (approximately 30° to left or right and 15° above or below).
- Dim the room lights and turn off any fluorescents. Make sure the projector is not in direct sunlight. Strong lighting, especially fluorescent lights, may affect the projector's infrared receivers.
- Turn off any nearby equipment that emits infrared energy, such as a radiant room heater.

You've connected a computer and you can't control the mouse pointer with the remote control.

Make sure the cable is securely connected to both your computer's USB port and the projector's USB port (see page 27).

Where To Get Help

EPSON provides technical assistance through electronic support services 24 hours a day, as listed in the following table.

Service	Access
World Wide Web	From the Internet, you can reach EPSON's product support page at http://support.epson.com . After selecting your product, you can access troubleshooting information, download product documentation, and receive technical advice through e-mail.
Presenters Online	Access tips, templates, and training for developing successful presentations at http://www.presentersonline.com

Telephone Support Services

To use the EPSON PrivateLine Support service, call (800) 637-7661 and enter the PIN on the EPSON PrivateLine Support card included in your *Start Here* kit. This is the fastest way of speaking to a live representative, and it's free. This service is available 6 AM to 6 PM, Pacific Time, Monday through Friday, for the duration of your warranty period.

You may also speak with a projector support specialist by dialing one of these numbers:

- U.S.: (562) 276-4394, 6 AM to 6 PM, Pacific Time, Monday through Friday
- Canada: (905) 709-3839, 6 AM to 6 PM, Pacific Time, Monday through Friday

Toll or long distance charges may apply.

Before you call, please have the following information ready:

- Product name (EPSON PowerLite 8300i)
- Product serial number (located on the bottom of the projector)
- Computer configuration
- Description of the problem

You can purchase screens, carrying cases, or other accessories from EPSON at (800) 873-7766 or by visiting the EPSON Store at www.epsonstore.com (U.S. sales only). In Canada, please call (800) 463-7766 for dealer referral.

A

Appendix A: Projector Installation

This appendix provides guidelines on installing the projector in a permanent location, such as a theater or conference room.

Placement and Mounting Guidelines

The projector can be installed for four different viewing setups: front projection, ceiling mounting, rear projection onto a semi-transparent screen, or rear/ceiling projection, as shown:

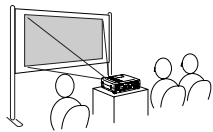

Front projection

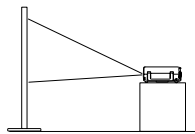

Ceiling mounting

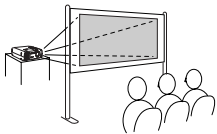

Rear projection

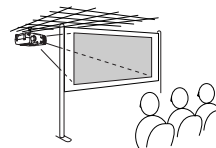
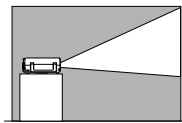

Rear/ceiling projection

To project from overhead, you'll need the optional ceiling mounting hardware; see page 12 for ordering information. You'll also need to select **Ceiling** in the projector's Advanced1 menu to flip the image upside-down. To project from the rear, select **Rear Proj** (see page 72).

If the projector is positioned at screen-height (anywhere between the bottom and the top of the screen), you can use the **Len Shift** function to adjust the position of the image on-screen (see page 39). Using the

note

See page 14 for more information on projector placement.

note

If you've installed the wide-angle rear projection lens, you won't be able to use the projector's Focus, Zoom, or Lens Shift functions. You must position the projector itself to obtain the desired image height, size, and focus (but Keystone correction can still be used).

Lens Shift is better than angling the projector up or down to position the image, since it won't produce keystone distortion, which must be eliminated electronically.

If you mount the projector on the ceiling above screen level, you'll have to tilt it down to center the image on the screen. This causes the image to lose its square shape, but you can correct the distortion by using the **Keystone** function in the projector's menu system (see page 67) or by pressing the **Keystone** button on the projector's control panel.

Image Size and Projection Distance

For standard lens usage, refer to the table below to help you determine projector placement if you know the size of image you want to display. (For information about using other lenses, see page 113.)

Image size (4:3 aspect ratio)*		Projection distance**
Diagonal	Width x height	
30 inches	24 x 18.1 inches (61 x 46 cm)	3.4 to 4.8 feet (104 to 146 cm)
40 inches	31.9 x 24 inches (81 x 61 cm)	4.7 to 6.5 feet (142 to 197 cm)
50 inches	39.4 x 30 inches (100 x 76 cm)	5.9 to 8.2 feet (180 to 249 cm)
60 inches	47.2 x 35.4 inches (120 x 90 cm)	7.1 to 9.9 feet (217 to 301 cm)
80 inches	63 x 47.2 inches (160 x 120 cm)	9.6 to 13.3 feet (293 to 404 cm)
100 inches	78.7 x 59.1 inches (200 x 150 cm)	12.1 to 16.7 feet (369 to 508 cm)
200 inches	161.4 x 118.1 inches (410 x 300 cm)	24.5 to 33.6 feet (747 to 1025 cm)
300 inches	240.2 x 181.1 inches (610 x 460 cm)	36.9 to 50.6 feet (1126 to 1543 cm)
400 inches	318.9 x 240.2 inches (810 x 610 cm)	49.4 to 67.6 feet (1505 to 2060 cm)
500 inches	393.7 x 299.2 inches (1000 x 760 cm)	61.8 to 84.6 feet (1883 to 2578 cm)
600 inches	474.4 x 358.3 inches (1200 x 910 cm)	74.2 to 101.5 feet (2262 to 3095 cm)

* The projector's native aspect ratio is 4:3. When you display a 16:9-sized image, the image height is reduced. See page 115.

** Projection distance refers to the horizontal distance from the lens to the screen. The image size will differ if you tilt the projector up or down at the screen or use the projector's Keystone function.

Image Size Calculations (For All Lenses)

Use the formulas in this section to estimate the required screen size and placement of the projector, depending on the type of lens with which your projector is equipped. For all lenses except Rear Projection Wide, the image size can be adjusted with the Zoom function, as indicated by the minimum and maximum calculations.

Standard Lens (V12H004S02)

Image size: 22 to 600 inches (0.56 to 15.24 m)

Projection distance (focal range): 41 to 1218 inches (1.04 to 30.94 m)

- To find the image size when you know the projection distance:
Maximum diagonal size = $(0.6709 \times \text{projection distance}) + 2.6$
Minimum diagonal size = $(0.4908 \times \text{projection distance}) + 1.8$
- To find the projection distance when you know the image size:
Maximum projection distance = $(2.037 \times \text{diagonal size}) - 3.8$
Minimum projection distance = $(1.490 \times \text{diagonal size}) - 3.8$

Rear Projection Wide Lens (V12H004R02)

Image size: 55 to 120 inches (1.40 to 3.05 m)

Projection distance (focal range): 37 to 84 inches (0.94 to 2.13 m)

- To find the image size when you know the projection distance:
Diagonal size = $(1.399 \times \text{projection distance}) + 3.6$
- To find the projection distance when you know the image size:
Projection distance = $(0.7148 \times \text{diagonal size}) - 2.6$

Wide Zoom Lens (V12H004W02)

Image size: 40 to 600 inches (1.02 to 15.24 m)

Projection distance (focal range): 40 to 896 inches (1.02 to 22.76 m)

- To find the image size when you know the projection distance:
Maximum diagonal size = $(0.9454 \times \text{projection distance}) + 2.5$
Minimum diagonal size = $(0.6671 \times \text{projection distance}) + 1.7$
- To find the projection distance when you know the image size:
Maximum projection distance = $(1.4990 \times \text{diagonal size}) - 2.5$
Minimum projection distance = $(1.0578 \times \text{diagonal size}) - 2.7$

note

All variables are in inches. The image size refers to the diagonal dimension of a 4:3 image. If you need to determine the diagonal of an image from its width or height, or work with 16:9-sized images, see page 115.

Middle Throw Zoom Lens (V12H004M01)

Image size: 60 to 600 inches (1.52 to 15.24 m)

Projection distance (focal range): 114 to 1791 in. (2.90 to 45.49 m)

- To find the image size when you know the projection distance:
Maximum diagonal size = $(0.5055 \times \text{projection distance}) + 2.7$
Minimum diagonal size = $(0.3340 \times \text{projection distance}) + 1.8$
- To find the projection distance when you know the image size:
Maximum projection distance = $(2.9941 \times \text{diagonal size}) - 5.3$
Minimum projection distance = $(1.9782 \times \text{diagonal size}) - 5.3$

Middle Throw Zoom Lens (V12H004M02)

Image size: 60 to 600 inches (1.52 to 15.24 m)

Projection distance (focal range): 170 to 2640 in. (4.32 to 67.06 m)

- To find the image size when you know the projection distance:
Maximum diagonal size = $(0.3428 \times \text{projection distance}) + 2.0$
Minimum diagonal size = $(0.2267 \times \text{projection distance}) + 1.3$
- To find the projection distance when you know the image size:
Maximum projection distance = $(4.4107 \times \text{diagonal size}) - 5.8$
Minimum projection distance = $(2.9169 \times \text{diagonal size}) - 5.7$

Long Throw Zoom Lens (V12H004L04)

Image size: 60 to 600 inches (1.52 to 15.24 m)

Projection distance (focal range): 258 to 3408 in. (6.55 to 86.56 m)

- To find the image size when you know the projection distance:
Maximum diagonal size = $(0.2380 \times \text{projection distance}) - 1.3$
Minimum diagonal size = $(0.1763 \times \text{projection distance}) - 0.9$
- To find the projection distance when you know the image size:
Maximum projection distance = $(5.6720 \times \text{diagonal size}) + 5.3$
Minimum projection distance = $(4.2009 \times \text{diagonal size}) + 5.6$

Converting Between Diagonal Size and Width or Height

The calculations on the previous pages use the diagonal length of an image to indicate its size.

- Use these formulas if you want to find out the diagonal size of a 4:3 image from its width or height:
Diagonal size = $5/4 \times$ width
Diagonal size = $5/3 \times$ height
- Use these formulas if you want to find out the width or height of a 4:3 image from its diagonal size:
Width = $4/5 \times$ diagonal size
Height = $3/5 \times$ diagonal size

Converting Between 16:9 and 4:3 Image Sizes

The image size calculations on the previous pages assume that you're projecting a 4:3-sized image. If you want to project a 16:9 (widescreen) image, you'll first need to determine the corresponding size of a 4:3 image before using the calculations.

Since the projector's native aspect ratio is 4:3, the image height is reduced when you project a 16:9 image:

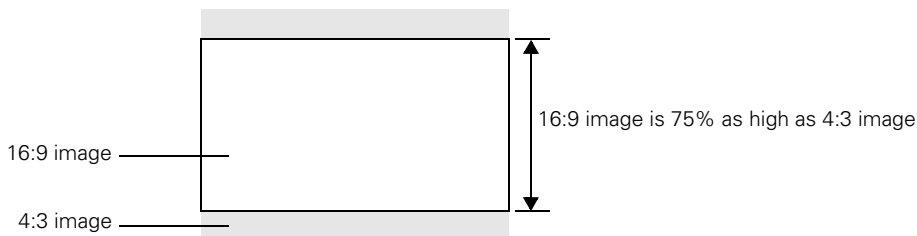

If you know the height of the 16:9 image you want to project, multiply it by $20/9$ to determine the diagonal of the corresponding 4:3 image. Then use the image size calculations to determine the projection distance.

If you've already used the projection distance to calculate the diagonal of a 4:3 image, multiply it by $9/20$ to determine the height of the corresponding 16:9 image.

Installing the Rear Cable Cover

If you're mounting the projector on the ceiling, install the rear cable cover to enhance the appearance of the system. To install the cover, insert its tabs into the slots as shown, then push the cover against the projector until it locks into place.

To remove the cover (when replacing the lamp and connecting or disconnecting cables), release the locking tab on the bottom of the cover as shown:

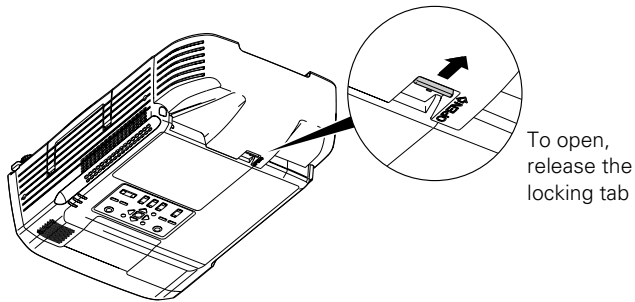
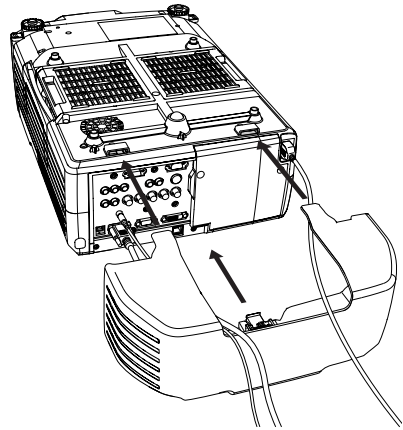

Installing Multiple Projectors

note

A remote control cable set is available that lets you operate the projector from extended distances (see page 12).

If multiple projectors are installed in one room, you can assign to each projector a separate ID number. This lets the presenter use the remote control to operate each projector independently (see page 48).

If you have multiple projectors installed at your place of business and want to be able to monitor and control them over a network, see “Managing the Projector from a Remote Computer” on page 73.

B

Appendix B: Technical Specifications

General

Type of display	Poly-silicon TFT active matrix
Size of LCD panels	Diagonal: 1.4 inches (35.6 mm)
Lens	F=1.7 to 2.2, f=53 to 72 mm
Resolution (native format)	1024 × 768 pixels (XGA)
Color reproduction	24 bit, 16.8 million colors
Brightness	Approx. 5200 ANSI lumens (high brightness setting); 3000 ANSI lumens (low brightness setting)
Contrast ratio	1200:1 (high brightness) 1500:1 (low brightness)
Image size	22 to 600 inches (0.56 to 15.24 meters), using the standard lens
Projection distance	3.4 to 101.5 feet (1.04 to 30.94 meters), using the standard lens
Projection methods	Front, rear, upside-down (ceiling mount)
Internal sound system	7 W monaural
Optical aspect ratio	4:3 (horizontal:vertical); supports 16:9 and 5:4
Zoom ratio	1:1.35
Noise level	34 dB
Keystone correction	Vertical ± 45° Horizontal ± 40°

Projection Lamp

Type	UHE (Ultra High Efficiency)
Power consumption	320 W
Lamp life	Approx. 3000 hours (low brightness); 2000 hours (high brightness)
Part number	V13H010L23

Remote Control

Range	about 30 feet (10 meters)
Battery	AA × 2

Mouse Compatibility

Supports USB

Dimensions

Height	7.6 inches (193 mm) including feet
Width	13.8 inches (350 mm)
Depth	19.3 inches (490 mm)
Weight	24.7 lb (11.2 kg)

Electrical

Rated frequency	50/60 Hz AC
Power supply	100 to 120 VAC 200 to 240 VAC
Power consumption	Operating: 480 W Standby (on network): 60 W Full sleep mode: 1.5 W

Environmental

Temperature	Operating: 41 to 104°F (5 to 40°C) Storage: 14 to 140 °F (-10 to 60 °C)
Humidity	Operating: 20 to 80% RH, non-condensing Storage: 10 to 90% RH, non-condensing
Operating altitude	0 to 10,000 ft (0 to 3,048 m)

Safety

United States	FCC 47CFR Part 15B Class B (DoC) UL1950 Rev. 3
Canada	ICES-003 Class B CSA C22.2 No. 950-95 (cUL)
CE Marking	Directive 73/23/EEC Directive 89/336/EEC EN 55022, EN 55024

Computer Video Port Pin Assignments

The Computer1 and Computer 2 ports are female video RGB, 15-pin micro-D-style connector. Here are their pin assignments:

Pin no.	Computer port	Pin no.	Computer port
1	Red video	9	Reserved
2	Green video	10	Synchronous GND
3	Blue video	11	GND
4	GND	12	SDA
5	GND	13	Horizontal sync / composite sync
6	Red GND	14	Vertical sync
7	Green GND	15	SCL
8	Blue GND		

Compatible Video Formats

You can use any of the following video sources: VCR, DVD player, camcorder, digital camera, gaming console, or laser disc player. The projector supports composite video, S-video, component video, and RGB video, and it automatically senses the video format (HDTV, NTSC, PAL, or SECAM).

The projector supports these international video standards:

Mode	Refresh Rate (Hz)
NTSC	60
NTSC 4:3	60
PAL	50
M-PAL	60
N-PAL	50
PAL—60	60
SECAM	50
HDTV (750p)	60
HDTV (750p)	50
HDTV (1125i)	60
HDTV (1125i)	50
SDTV (525P)	60
SDTV (625p)	50
TV (525i)	60
TV (625i)	50

Compatible Computer Display Formats

You can connect the projector to a wide range of computers, including PCs and laptops, Apple Macintosh®, Power Macintosh® series (including G3 and G4 systems), PowerBook® computers, many iMac® and iBook® series systems, and high-end workstations such as the Sun® SPARCstation.™

Although images are displayed at the projector's native resolution of 1024 × 768 pixels, EPSON's patented SizeWise™ chip supports computer display formats ranging from VGA through UXGA.

To project images output from a computer, the computer's external monitor signal must be set at a refresh rate (vertical frequency) that's compatible with the projector; see the following table for compatible

formats. For best results, the computer's resolution should be set to match the projector's native resolution (1024 × 768). If this resolution isn't available, select one of the other compatible formats:

■ **Windows:**

Right-click the desktop, select **Properties**, click the **Settings** tab, and select a compatible resolution. (For a laptop displaying through an external monitor port, you'll need to click the **Advanced** button on the Settings tab, then adjust the resolution of the external monitor.)

■ **Macintosh OS 9.x:**

On the Apple menu, choose **Control Panels**, then click **Monitors** or **Monitors and Sound**. Click the **Monitor** tab and select a compatible resolution for your external monitor.

■ **Macintosh OS X:**

From the Apple menu, select **System Preferences**, then click **Displays**. Make sure the **VGA Display** or **Color LCD** dialog box is selected, then click the **Display** tab and select a compatible resolution.

You may need to modify existing presentation files if you created them for a different resolution. See your software documentation for details.

The projector supports these monitor display formats:

Mode	Refresh Rate (Hz)	Resolution
VGAEGA	70	640 × 350
VGA—60	60	640 × 480
VESA—72	72	640 × 480
VESA—75	75	640 × 480
VESA—85	85	640 × 480
VGA—120	120	640 × 480
SVGA—56	56	800 × 600
SVGA—60	60	800 × 600
SVGA—72	72	800 × 600
SVGA—75	75	800 × 600
SVGA—85	85	800 × 600
SVGA—120	120	800 × 600

Mode	Refresh Rate (Hz)	Resolution
XGA—43i	43	1024 × 768
XGA—60	60	1024 × 768
XGA—70	70	1024 × 768
XGA—75	75	1024 × 768
XGA—85	85	1024 × 768
XGA—120	120	1024 × 768
SXGA1—70	70	1152 × 864
SXGA1—75	75	1152 × 864
SXGA1—85	85	1152 × 864
SXGA1—100	100	1152 × 864
SXGA2—60	60	1280 × 960
SXGA2—75	75	1280 × 960
SXGA2—85	85	1280 × 960
SXGA3—43i	43	1280 × 1024
SXGA3—60	60	1280 × 1024
SXGA3—75	75	1280 × 1024
SXGA3—85	85	1280 × 1024
SXGA+60	60	1400 × 1050
SXGA+75	75	1400 × 1050
SXGA+85	85	1400 × 1050
UXGA—48i	96	1600 × 1200
UXGA—60	60	1600 × 1200
UXGA—65	65	1600 × 1200
UXGA—70	70	1600 × 1200
UXGA—75	75	1600 × 1200
UXGA—80	80	1600 × 1200
UXGA—85	85	1600 × 1200
iMAC VGA	117	640 × 480
iMAC SVGA	95	800 × 600
iMAC XGA	75	1024 × 768
MAC13	67	640 × 480
MAC16	75	832 × 624
MAC19—60	59	1024 × 768
MAC19	75	1024 × 768
MAC21	75	1152 × 870

C

Appendix C: Notices

This appendix includes safety instructions and other important information about your EPSON PowerLite projector.

Important Safety Instructions

Follow these safety instructions when setting up and using the projector:

- Do not place the projector on an unstable cart, stand, or table.
- Do not use the projector near water or sources of heat.
- Use the type of power source indicated on the projector. If you are not sure of the power available, consult your dealer or power company.
- Place the projector near a wall outlet where the plug can be easily unplugged.

Placez l'appareil près d'une prise de courant où la fiche peut être débranchée facilement.

- Insert the projector's three-wire grounding-type plug into a properly grounded outlet. If you have a two-prong outlet, contact an electrician to replace it. Do not hold the plug with wet hands.
- Take the following precautions for the plug. Failure to comply with these precautions could result in sparks or fire: Do not insert the plug into an outlet with dust present. Insert the plug firmly into the outlet.
- Do not overload wall outlets, extension cords, or integral convenience receptacles. This can cause fire or electric shock.
- Do not place the projector where the cord can be walked on. This may result in fraying or damage to the plug.
- Unplug the projector from the wall outlet before cleaning. Use a damp cloth for cleaning. Do not use liquid or aerosol cleaners.
- Do not block the slots and openings in the projector case. They provide ventilation and prevent the projector from overheating. Do not operate the projector on a sofa, rug, or other soft surface, or in a closed-in cabinet unless proper ventilation is provided.

- Never push objects of any kind through the cabinet slots. Never spill liquid of any kind into the projector.
- Except as specifically explained in this *User's Guide*, do not attempt to service this product yourself. Refer all servicing to qualified personnel. Opening or removing covers may expose you to dangerous voltages and other hazards.
- Unplug the projector from the wall outlet and refer servicing to qualified service personnel under the following conditions: When the power cord or plug is damaged or frayed. If liquid has been spilled into the projector, or if it has been exposed to rain or water. If it does not operate normally when you follow the operating instructions, or if it exhibits a distinct change in performance, indicating a need for service. If it has been dropped or the housing has been damaged.
- (Hg) The lamp(s) in this product contain mercury. Please consult your state and local regulations regarding disposal or recycling. Do not put in the trash.
- Unplug the projector during lightning storms or when it will not be used for extended periods.
- Do not place the projector and/or remote control on top of heat-producing equipment or in a hot location.
- If you use the projector in a country other than where you purchased it, use the correct power cord for that country.
- Do not stand on the projector or place heavy objects on it.
- Do not use the projector outside of the required temperature range of 41 to 104°F (5 to 40 °C). Doing so may cause an unstable display and could lead to projector damage.
- Do not store the projector outside of the required temperature range of 14 to 140 °F (-10 to 60 °C) or in direct sunlight for long periods of time. Doing so may cause damage to the case.

Remote Control Information

You can operate the projector by remote control via a line-of-sight infrared (IR) receiver at the front and rear of the projector. The projector may not respond to remote control commands under the following conditions:

- There is an object between the remote control IR emitter and the IR receiver on the projector.
- Ambient light is too bright.
- Certain types of fluorescent lighting are used.
- A strong light source shines into the IR receiver.
- Other equipment that emits infrared energy, such as a radiant room heater, is in the room.

These conditions commonly cause problems for most infrared-controlled equipment. Try the following:

- The remote control's batteries may be low on power; replace them.
- Dim the ambient lighting and/or turn off any fluorescent lights.
- Close any window coverings and/or move the projector out of direct sunlight.
- Turn off other equipment that emits infrared energy.

Declaration of Conformity

According to 47CFR, Part 2 and 15, Class B Personal Computers and Peripherals; and/or CPU Boards and Power Supplies used with Class B Personal Computers

We: EPSON AMERICA, INC.
Located at: 3840 Kilroy Airport Way
MS: 3-13
Long Beach, CA 90806-2469
Telephone: (562) 290-5254

Declare under sole responsibility that the product identified herein, complies with 47CFR Part 2 and 15 of the FCC rules as a Class B digital device. Each product marketed, is identical to the representative unit tested and found to be compliant with the standards. Records maintained continue to reflect the equipment being produced can be expected to be within the variation accepted, due to quantity production and testing on a statistical basis as required by 47CFR §2.909. Operation is subject to the following two conditions: (1) this device may not cause harmful interference, and (2) this device must accept any interference received, including interference that may cause undesired operation.

Trade Name: EPSON
Type of Product: Projector
Model: EMP-8300
Marketing Name: PowerLite 8300i

FCC Compliance Statement

For United States Users

This equipment has been tested and found to comply with the limits for a Class B digital device, pursuant to Part 15 of the FCC Rules. These limits are designed to provide reasonable protection against harmful interference in a residential installation. This equipment generates, uses, and can radiate radio frequency energy and, if not installed and used in accordance with the instructions, may cause harmful interference to radio or television reception. However, there is no guarantee that interference will not occur in a particular installation. If this equipment does cause interference to radio and television reception, which can be determined by turning the equipment off and on, the user is encouraged to try to correct the interference by one or more of the following measures:

- Reorient or relocate the receiving antenna.
- Increase the separation between the equipment and receiver.
- Connect the equipment into an outlet on a circuit different from that to which the receiver is connected.
- Consult the dealer or an experienced radio/TV technician for help.

WARNING

The connection of a non-shielded equipment interface cable to this equipment will invalidate the FCC Certification of this device and may cause interference levels which exceed the limits established by the FCC for this equipment. It is the responsibility of the user to obtain and use a shielded equipment interface cable with this device. If this equipment has more than one interface connector, do not leave cables connected to unused interfaces. Changes or modifications not expressly approved by the manufacturer could void the user's authority to operate the equipment.

For Canadian Users

This Class B digital apparatus meets all requirements of the Canadian Interference-Causing Equipment Regulations.

Cet appareil numérique de la classe B respecte toutes les exigences du Règlement sur le matériel brouilleur du Canada.

Warranty

Epson America, Inc. Limited Warranty

Basic Two-Year Warranty and 90-Day Lamp Warranty

What Is Covered: Epson America, Inc. (“EPSON”) warrants to the original retail purchaser of the EPSON product enclosed with this limited warranty statement that the product, if purchased new and used in the United States or Canada, conforms to the manufacturer’s specifications and will be free from defects in workmanship and materials for a period of two (2) years from the date of original purchase (except that the warranty period is 90 days for projector lamps). For warranty service, you must provide proof of the date of original purchase.

What EPSON Will Do To Correct Problems: If you elect carry-in warranty service, please bring the product securely packaged in its original container or an equivalent, along with proof of the date of original purchase, to your EPSON Dealer or EPSON Customer Care Center. EPSON will, at its option, repair or replace on an exchange basis the defective unit, without charge for parts or labor. When warranty service involves the exchange of the product or of a part, the item replaced becomes EPSON property. The exchanged product or part may be new or previously refurbished to the EPSON standard of quality, and at EPSON’s option, the replacement may be another model of like kind and quality. EPSON’s liability for replacement of the covered product will not exceed the original retail selling price of the covered product. Exchange or replacement products or parts assume the remaining warranty period of the product covered by this limited warranty. However, each replacement lamp carries the limited 90-day warranty stated above.

What This Warranty Does Not Cover: This warranty does not apply to refurbished or reconditioned products. This warranty covers only normal consumer use in the United States and Canada. 24-hour-per-day use causes unusual strain and is not considered normal use. This warranty does not cover consumables (e.g., fuses), other than lamps. This warranty is not transferable. EPSON is not responsible for warranty service should the EPSON label or logo or the rating label or serial number be removed or should the product fail to be properly maintained or fail to function properly as a result of misuse, abuse, improper installation, neglect, improper shipping, damage caused by disasters such as fire, flood, and lightning, improper electrical current, software problems, interaction with non-EPSON products, or service other than by an EPSON Authorized Servicer. Postage, insurance, or shipping costs incurred in presenting your EPSON product for

carry-in warranty service are your responsibility. If a claimed defect cannot be identified or reproduced in service, you will be held responsible for costs incurred.

THE WARRANTY AND REMEDY PROVIDED ABOVE ARE EXCLUSIVE AND IN LIEU OF ALL OTHER EXPRESS OR IMPLIED WARRANTIES INCLUDING, BUT NOT LIMITED TO, THE IMPLIED WARRANTIES OF MERCHANTABILITY OR FITNESS FOR A PARTICULAR PURPOSE. SOME LAWS DO NOT ALLOW THE EXCLUSION OF IMPLIED WARRANTIES. IF THESE LAWS APPLY, THEN ALL EXPRESS AND IMPLIED WARRANTIES ARE LIMITED TO THE WARRANTY PERIOD IDENTIFIED ABOVE. UNLESS STATED HEREIN, ANY STATEMENTS OR REPRESENTATIONS MADE BY ANY OTHER PERSON OR FIRM ARE VOID. IN THE EVENT THE REMEDIES ABOVE FAIL, EPSON'S ENTIRE LIABILITY SHALL BE LIMITED TO A REFUND OF THE PRICE PAID FOR THE EPSON PRODUCT COVERED BY THIS LIMITED WARRANTY. EXCEPT AS PROVIDED IN THIS WRITTEN WARRANTY, NEITHER EPSON AMERICA, INC. NOR ITS AFFILIATES SHALL BE LIABLE FOR ANY LOSS, INCONVENIENCE, OR DAMAGE, INCLUDING DIRECT, SPECIAL, INCIDENTAL, OR CONSEQUENTIAL DAMAGES, RESULTING FROM THE USE OR INABILITY TO USE THE EPSON PRODUCT, WHETHER RESULTING FROM BREACH OF WARRANTY OR ANY OTHER LEGAL THEORY.

In Canada, warranties include both warranties and conditions.

Some jurisdictions do not allow limitations on how long an implied warranty lasts and some jurisdictions do not allow the exclusion or limitation of incidental or consequential damages, so the above limitations and exclusions may not apply to you.

This warranty gives you specific legal rights, and you may also have other rights, which vary from jurisdiction to jurisdiction.

To locate the Authorized EPSON Servicer nearest you, call the EPSON ConnectionSM at (800) 637-7661 + PIN or (562) 276-4394 in the U.S. and (905) 709-3839 in Canada or write to: Epson America, Inc., P.O. Box 93012, Long Beach, CA 90809-3012.

Index

A

- A/V Mute, 59 to 60
- A/V Mute button, 53
- About menu, 96, 103
- Accessories, 12, 110
- Air filters, cleaning and replacing, 91 to 93
- Anti-theft device, 12, 15
- Aspect ratio, 117
- Audio
 - adjusting tone, 69
 - adjusting volume, 55, 69
 - problems, troubleshooting, 108
 - turning off (using A/V Mute), 53

B

- Bass, adjusting, 69
- Battery, installing, 50
- Blank screen, 35
- Blurry image, 107
- Brightness, 7, 117
- Brightness setting, 55, 64

C

- Cables
 - A/V, 10 to 12, 16
 - audio, 10 to 12, 29
 - computer, 10 to 12, 22 to 27
 - mouse, 27
 - USB, 10, 27
 - video, 10 to 12, 16
- Capturing image, 59 to 60
- Ceiling mount, 12, 111 to 116
- Cleaning
 - air filters, 91 to 93
 - lens, 90
 - projector, 90
- Color
 - problems, 108
 - settings, 68

- Communication setup options, 71
- Component video
 - cable, 16
 - selecting input signal, 19, 70
- Composite (RCA) video cable, 16
- Computer connector pin assignments, 119
- Computers supported, 120
- Connecting projector
 - to audio source, 29
 - to computer, 22 to 27
 - to external monitor, 28
 - to speakers, 30
 - to video equipment, 16 to 21
- Connector pin assignments, 119
- Contrast setting, 64

D

- Declaration of Conformity, 126
- Default settings, restoring, 63
- Desktop adapter, Macintosh, 26
- Different image on laptop and screen, 35 to 37
- Distance from projector to screen, 14,
112 to 115, 117
- Drawing on the screen, 56 to 57
- DVI cable, 12, 25

E

- EasyManagement
 - installing software, 74 to 75
 - monitoring projector, 7, 73 to 88
- EasyMP.net option, 7, 34, 51
- Electrical specifications, 118
- E-mail notification, 84 to 88
- EMP Monitor
 - changing monitoring interval, 83
 - installing software, 74 to 75
 - using, 78 to 83
- EMP NetworkManager
 - installing software, 74 to 75
 - using, 84 to 88

Environmental specifications, 119

EPSON

accessories, 12, 110

PrivateLine Support, 8, 110

technical support, 8, 110

External monitor, connecting, 28, 71

E-Zoom button, 53

F

FCC compliance statement, 127

Filters, *see* Air filters

Focusing, 38

Foot release button, 39

Freeze button, 53

H

Height of image, adjusting, 39 to 40

Help, 8, 110

Highlighting presentation, 56 to 57

HP OpenView, 73

I

iMac, connecting to, 11

Image

adjusting, 38 to 42, 64 to 68

capturing and saving in projector, 59 to 60

correcting shape, 40 to 41, 67, 106

fitting on screen, 42, 67, 106

focusing, 38

height, adjusting, 39 to 40

positioning, 39 to 40

previewing picture sources, 52

problems with, troubleshooting, 35 to 37,

104 to 108

raising, 39 to 40

selecting source, 34, 51 to 52

setup options, 70

shape, correcting, 40 to 41, 67, 106

size and projection distance, 14,

112 to 115, 117

turning off (using A/V Mute), 53

zooming, 38, 53

Input signal, selecting, 34, 51 to 52, 70

Installing

projector, 111 to 116

software, 74 to 75

K

Kensington anti-theft device, 12, 15

Keystone correction, 40 to 41, 67, 106, 117

L

Lamp

filter, 91

number of hours used, 94, 96, 103

replacing, 94 to 96

status light, 94, 100 to 102

Lamp timer, resetting, 96

Laptop computer, displaying on, 35 to 37

Lens

cleaning, 90

options, 12

specifications, 112 to 115, 117

Lens shift, 39

Lights, status, 100 to 102

Logo, saving on projector, 59 to 60

M

Macintosh desktop adapter, 26

Manuals, 8

Menus

About, 96, 103

Audio, 69

changing settings, 62 to 63

User's Logo, 59 to 60

using, 62 to 63

Video, 64 to 66

Monitor, connecting, 28

Monitoring projector

EMP Monitor, 78 to 83

EMP NetworkManager, 84 to 88

HP OpenView, 73

Mouse, using remote control as, 27, 58

Multiple projectors, controlling, 48

N

- Navigation buttons, 47
- Network settings, 71, 76 to 77
- New Hardware Wizard, 33
- No-Signal Msg setting, 60, 72

O

- Options for projector, 11 to 12

P

- Picture source, selecting, 34, 51 to 52
- Picture, *see* Image
- Picture-in-Picture function, 54
- Pin assignments, connector, 119
- Pointer tool, 56 to 57
- Positioning
 - image, 39 to 40
 - projector, 14 to 15
- Power
 - button, 33
 - specifications, 118
 - status light, 100 to 102
- PowerPoint files, viewing with remote control, 7, 27, 58
- Presentations
 - computer, 22 to 27
 - video, 16 to 27
- Presenters Online, 8, 110
- Preview function, 52
- PrivateLine Support, 8, 110
- Problems
 - color, 108
 - image, 35 to 37, 104 to 108
 - remote control, 109
 - sound, 108
- Projection lamp, *see* Lamp
- Projector
 - cleaning, 90
 - connections, *see* Connecting projector
 - customizing features, 70 to 72
 - distance from screen, 14, 112 to 115, 117
 - feet, adjusting height with, 39
 - installing, 111 to 116

Projector (*continued*)

- lamp specifications, 118
 - monitoring remotely, 73 to 88
 - options, 12
 - positioning, 14 to 15, 111 to 116
 - resolution, 7, 117, 120 to 122
 - shipping case, 12, 97
 - specifications, 117 to 119
 - transporting, 97
 - troubleshooting, 99 to 108
 - turning off, 43
 - turning on, 32 to 33
 - unpacking, 10
 - viewing information about, 103
- Projector ID, 48
 - Prompt setting, 72

Q

- Quick Corner, 41

R

- Raising image, 39 to 40
- Rear-screen projection, 111
- Registration, 9
- Remote control
 - as wireless mouse, 27, 58
 - controlling multiple projectors, 48
 - ID, 49
 - information, 125
 - navigation buttons, 47
 - problems, 109, 125
 - replacing battery, 50
 - running slideshow with, 27, 58
 - specifications, 118
 - troubleshooting, 109
 - using, 45 to 58
- Replacing lamp, 94 to 96
- Resetting
 - lamp timer, 96
 - menu options, 63
- Resetting menu options, 63
- Resolution, 7, 117, 120 to 122
- Restoring default settings, 63

S

- Safety
 - instructions, 123 to 124
 - specifications, 119
- Screen
 - blank, 35
 - distance from projector, 14, 112 to 115
 - options, 12
- Screen image
 - See* Image
- Setup options, 70 to 72
- Shipping case, 12, 97
- Sleep mode, 43, 72, 118
- SNMP (Simple Network Management Protocol), 73
- Software installation, 74 to 75
- Sound
 - adjusting, 55, 69
 - troubleshooting, 108
- Source, selecting, 34, 51 to 52
- Speaker, specifications, 117
- Speakers, connecting, 30
- Specifications
 - brightness, 7, 117
 - dimensions, 118
 - electrical, 118
 - environmental, 119
 - general, 117
 - Lens, 112 to 115
 - lens, 117
 - remote control, 118
 - resolution, 7, 117, 120 to 122
 - safety, 119
- Standby mode, 28, 43, 71, 80, 82
- Startup screen, creating, 59 to 60
- Status lights, 100 to 102
- Stopping action, 53
- Support, *see* Technical support
- S-video cable, 11, 16, 18
- Switching picture source, 34, 51 to 52
- Synchronization, adjusting, 66
- System requirements, 74

T

- Technical support, 8, 110
- Temperature
 - requirements, 119
 - status light, 100 to 102
- Tone, adjusting, 69
- Tracking, adjusting, 65
- Transporting projector, 97
- Treble, adjusting, 69
- Troubleshooting
 - blank screen, 35
 - cut-off image, 42, 67, 106
 - different images on laptop and screen, 35
 - image and sound problems, 35 to 37, 104 to 108
 - projector problems, 99 to 108
 - remote control problems, 109
 - tapered image, 40 to 41
- Turning off picture (using A/V Mute), 53
- Turning off projector, 43

U

- Unpacking projector, 10
- USB cable, 10, 27
- User's Logo menu, 59 to 60

V

- Video
 - cables, 10 to 12, 16
 - display settings, viewing, 103
 - formats, supported, 120 to 122
 - menu, 64 to 66
 - selecting source, 34, 51 to 52
- Video port pin assignments, 119
- Volume, adjusting, 55, 69

W

- Warning lights, 100 to 102
- Warranty, 9, 128 to 129
- Wireless mouse, 27, 58

Z

Zoom ratio, 117

Zooming image, 38, 53

Projector

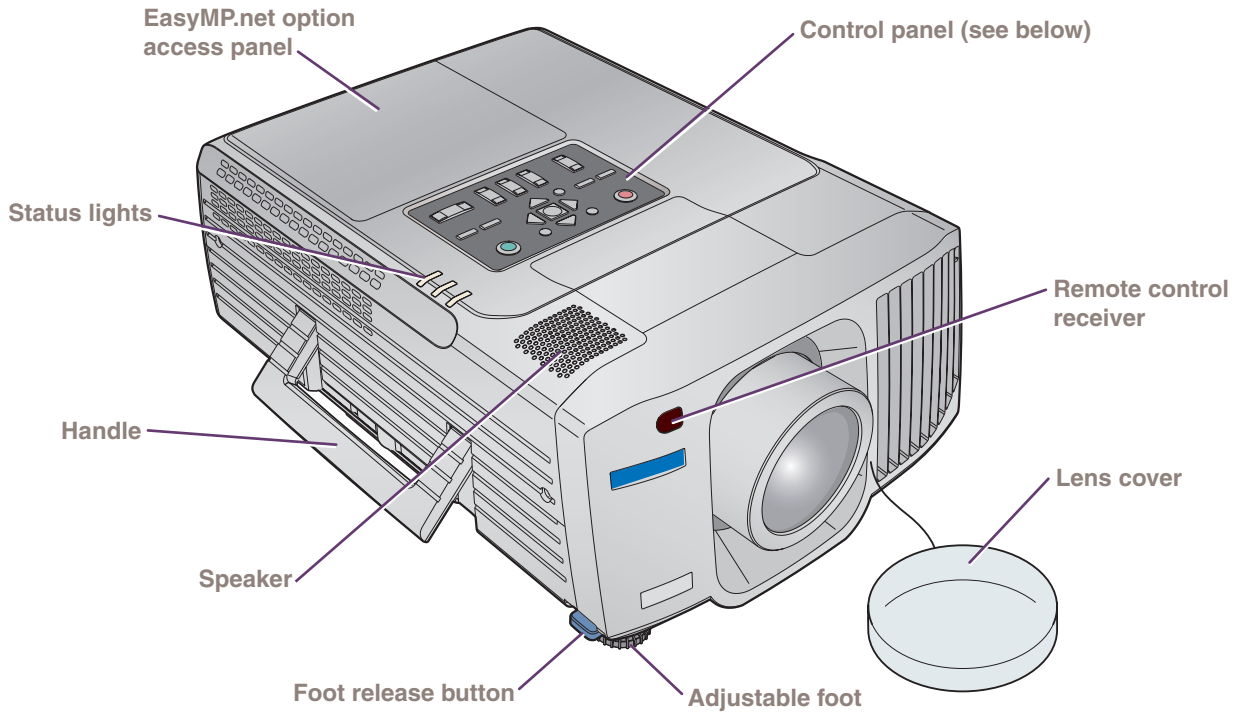

Control Panel

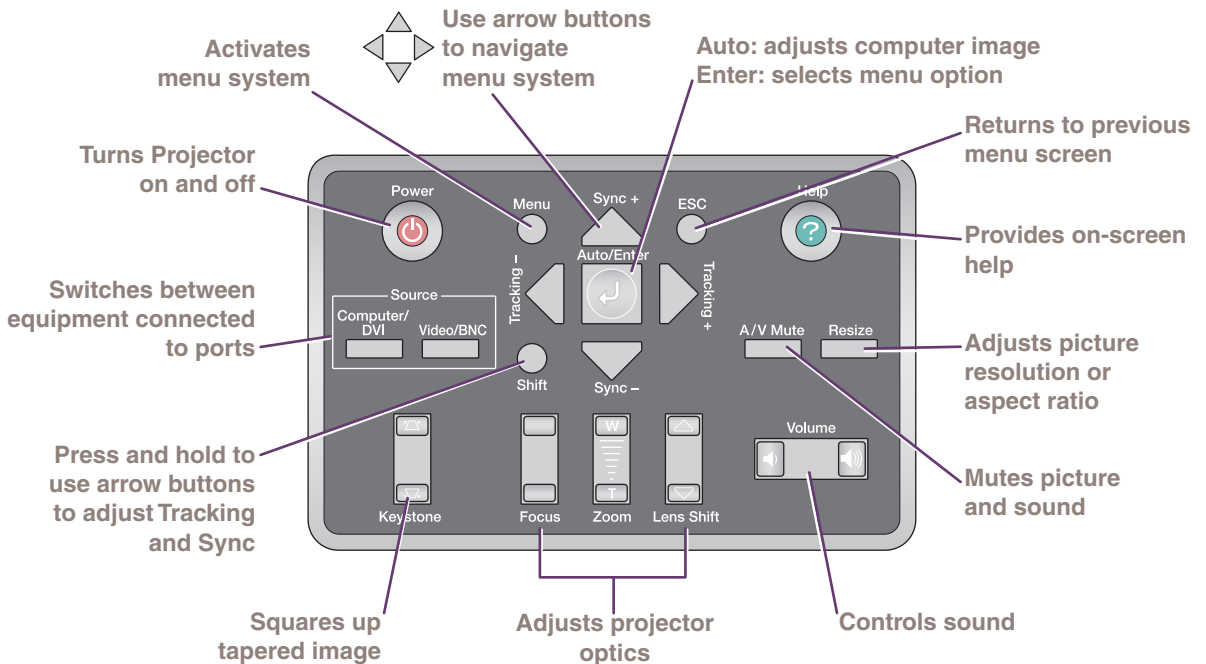

Remote Control

