

**PowerLite®
84+/85+/824+/825+/826W+
Multimedia Projector**

User's Guide

Important Safety Information

WARNING: Never look into the projector lens when the lamp is turned on; the bright light can damage your eyes. Never let children look into the lens when it is on. Never open any cover on the projector, except the lamp and filter covers. Dangerous electrical voltages inside the projector can severely injure you. Except as specifically explained in this *User's Guide*, do not attempt to service this product yourself. Refer all servicing to qualified service personnel.

WARNING: The projector and its accessories come packaged in plastic bags. Keep plastic bags away from small children to avoid any risk of suffocation.

Caution: When you replace the lamp, never touch the new lamp with your bare hands; the invisible residue left by the oil on your hands may shorten the lamp life. Use a cloth or glove to handle the new lamp.

Copyright Notice

All rights reserved. No part of this publication may be reproduced, stored in a retrieval system, or transmitted in any form or by any means, electronic, mechanical, photocopying, recording, or otherwise, without the prior written permission of Seiko Epson Corporation. The information contained herein is designed only for use with this Epson product. Epson is not responsible for any use of this information as applied to other products.

Neither Seiko Epson Corporation nor its affiliates shall be liable to the purchaser of this product or third parties for damages, losses, costs, or expenses incurred by purchaser or third parties as a result of: accident, misuse, or abuse of this product or unauthorized modifications, repairs, or alterations to this product, or (excluding the U.S.) failure to strictly comply with Seiko Epson Corporation's operating and maintenance instructions.

Seiko Epson Corporation shall not be liable for any damages or problems arising from the use of any options or any consumable products other than those designated as Original Epson Products or Epson Approved Products by Seiko Epson Corporation.

Trademarks

Epson, EasyMP, and Instant Off are registered trademarks, and Epson Exceed Your Vision is a registered logomark of Seiko Epson Corporation.

PowerLite and PrivateLine are registered trademarks, Duet and SizeWise are trademarks, and Extra Care is a service mark of Epson America, Inc.

Pixelworks, DNX, and the DNX logo are trademarks of Pixelworks, Inc.

General Notice: Other product names used herein are for identification purposes only and may be trademarks of their respective owners. Epson disclaims any and all rights in those marks.

This information is subject to change without notice.

C

Contents

<i>Welcome</i>	7
Using Your Documentation	8
Getting More Information	9
Registration and Warranty	9
Unpacking the Projector	10
Projector Parts	11
Additional Components	12
Optional Accessories	13

1 <i>Displaying and Adjusting the Image</i>	15
Positioning the Projector	16
Turning the Projector On and Off	22
Turning On the Projector	23
Using the Direct Power On Function	24
Shutting Down the Projector	25
Selecting the Image Source	25
Adjusting the Image	26
Adjusting the Height of Your Image	27
Focusing and Zooming Your Image	27
Adjusting the Image Shape	28
Correcting Computer Images	30

2	<i>Using the Remote Control</i>	31
	Using the Remote Control.....	32
	Replacing the Batteries.....	32
	Controlling the Picture and Sound.....	33
	Switching Between Picture Sources.....	33
	Turning Off the Picture and Sound.....	34
	Stopping Action.....	34
	Zooming Part of Your Image.....	35
	Controlling the Volume.....	35
	Adjusting the Aspect Ratio.....	36
	Adjusting the Color Mode.....	38
	Displaying Patterns.....	39
	Assigning a Pattern to the User Button.....	39
	Creating Your Own Pattern.....	40
	Operating Your Computer with the Remote Control.....	41
	Highlighting Your Presentation.....	42
	Using the Pointer Tool.....	42
	Customizing the Pointer Tool.....	42
	Presenting a Slideshow.....	43
	Starting a Slideshow.....	44
	Selecting Slideshow Display Options.....	46

3	<i>Connecting to Computers, USB Devices, and Other Equipment</i>	47
	Connecting to a Computer.....	48
	Connecting to the VGA Port.....	49
	Connecting to the USB Port.....	50
	Connecting the USB Cable for Remote Mouse Control.....	51
	Connecting an External Monitor.....	53
	Connecting to Video Equipment.....	54
	Connecting a Composite Video Source.....	54
	Connecting an S-Video Source.....	55
	Connecting a Component Video Source.....	56
	Connecting an RGB Video Source.....	57
	Connecting to a Digital Camera, Document Camera, or Other Device.....	58

Playing Sound Through the Projector	59
Playing Computer Audio	59
Playing Sound from Video Equipment	60
Connecting a Microphone	60
Connecting External Speakers	61

4 <i>Using the Projector on a Network</i>	63
Connecting to a Wired Network	64
Installing the Optional Wireless 802.11a/b/g Module	67
Using Quick Wireless Connection	68
Configuring Basic Settings	69
Configuring the Connection	71
Using Ad Hoc Mode	71
Using Access Point Mode	78
Using Wireless Security Options	88
Enabling WEP Encryption	89
Enabling WPA Security	91
Enabling Data Encryption from EasyMP Network Projection	92
Using the EasyMP Network Projection Software	93
Removing the Wireless 802.11a/b/g Module	93
Using Projector E-mail Alerts	94
Using SNMP to Monitor the Projector	96
Using a Browser to Control the Projector	97
Using Web Remote Control	99

5 <i>Fine-Tuning the Projector</i>	101
Using the Menu System	102
Restoring the Default Settings	103
Adjusting the Image	104
Adjusting Signal Settings	106
Customizing Projector Features	108
Using the Projector Security Features	110
Enabling Password Protection	111
Creating Your Own Startup Screen	114
Disabling the Projector's Buttons	115
Customizing Power and Operation	116

6	<i>Maintaining the Projector</i>	119
	Cleaning the Lens.....	120
	Cleaning the Projector Case.....	120
	Cleaning the Air Filter and Vent.....	121
	Replacing the Lamp and Air Filter.....	122
	Replacing the Lamp.....	122
	Replacing the Air Filter.....	126
	Resetting the Lamp Timer.....	128
	Transporting the Projector.....	129

7	<i>Solving Problems</i>	131
	Using On-Screen Help.....	132
	Checking Projector Status.....	132
	What To Do When the Lights Flash.....	133
	Viewing Lamp Usage and Other Information.....	135
	Solving Projector Operation Problems.....	135
	Solving Problems with the Image or Sound.....	136
	Solving Network Problems.....	145
	Solving Problems with the Remote Control.....	148
	Where to Get Help.....	149
	Speak to a Support Representative.....	149

A	<i>Projector Installation</i>	151
----------	-------------------------------------	-----

B	<i>Technical Specifications</i>	153
----------	---------------------------------------	-----

C	<i>Notices</i>	159
	Important Safety Instructions.....	159
	FCC Compliance Statement.....	163
	Software Notices (for PowerLite 85+/825+/826W+).....	164

	<i>Index</i>	193
--	--------------------	-----

W Welcome

The PowerLite® 84+/85+/824+/825+/826W+ is an easy-to-use projector that weighs less than 7 pounds. From classrooms to boardrooms, your full-color presentations and videos will be bright and vibrant even in ordinary indoor lighting. You can connect the projector to a wide range of computers and video sources. With the PowerLite 85+/824+/825+/826W+, you can project from a USB storage device. With the PowerLite 85+/825+/826W+, you can project over your wired network or, with the optional Wireless 802.11a/b/g Module, you can project over an 802.11g, 802.11b, or 802.11a wireless network.

Easy setup, control, and security:

- 8.5-second startup time and Instant Off® feature for fast setup and shut down
- Automatic digital keystone correction
- Closed captioning
- 1.6x optical zoom lens for flexible placement and positioning
- USB projection for quick and easy connection
- 10 Watt speaker and microphone input
- Security features including password, user's logo, security slot (for a Kensington MicroSaver® theft deterrent device), security bar (for a theft deterrent wire lock) and the ability to lock the projector buttons
- A/V Mute slide to temporarily turn off the image and sound, ideal for breaks or when you want to redirect your audience's attention
- Project up to four different images from one computer (85+/825+/826W+ only)

- Project only the PowerPoint® slide images while viewing handout notes and controls on the computer screen (85+/825+/826W+ only)
- Project from a thumb drive or other USB storage device (85+/824+/825+/826W+ only)
- A Message Broadcasting plug-in (85+/825+/826W+ only) that allows you to project timely alerts and messages to all networked projectors (to download both the plug-in and its instructions, visit Epson's support website at www.epson.com/support and select your product)

Using Your Documentation

This electronic *User's Guide* provides detailed instructions on using your projector.

In addition, your projector CD-ROM may include the *EasyMP Network Projection Operation Guide* (85+/825+/826W+ only) and the *EasyMP Monitor Operation Guide* (84+/85+/825+/826W+ only). Refer to *EasyMP Network Projection Operation Guide* for detailed instructions on giving presentations over a network. Refer to the *EasyMP Monitor Operation Guide* for detailed instructions on monitoring the projector from a remote location. To set up your projector for the first time on a network, see page 63 of this *User's Guide*.

Please follow these guidelines as you read through this manual:

- Warnings must be followed carefully to avoid bodily injury.
- Cautions must be observed to avoid damage to your equipment.
- Notes contain important information about your projector.
- Tips contain additional projection hints.

Getting More Information

Need troubleshooting tips? Quick steps for setting up your projector? Here's where you can look for help:

- ***Quick Setup* sheet**
Gives you the instructions you need to get your projector up and running.
- **Built-in help system**
Provides assistance for common problems. Available from the ? Help button on the projector or the remote control. See page 132 for details.
- **epson.com/support**
Download FAQs and e-mail your questions to Epson support.
- **PrivateLine support**
If you still need help after checking this *User's Guide* and the sources listed above, you can use the Epson PrivateLine® Support service to get help fast. Call (800) 637-7661 and enter the PIN on the PrivateLine card. Or take advantage of Epson's automated support services 24 hours a day. See page 149 for more information.

Registration and Warranty

Your projector comes with a warranty that lets you project with confidence. For details, see the warranty statement included with your projector.

In addition, Epson offers free Extra CareSM Road Service. In the unlikely event of an equipment failure, you won't have to wait for your unit to be repaired. Instead, Epson will ship you a replacement unit anywhere in the United States or Canada. See the brochure included with your projector for details.

Register online using your projector CD or at <http://www.epson.com/webreg>. Registering also lets you receive special updates on new accessories, products, and services.

Unpacking the Projector

After unpacking the projector, make sure you have all the parts shown below:

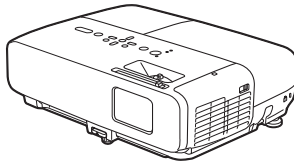

Projector

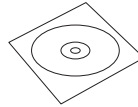

PDF manual and registration CD-ROM

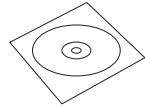

Projector software CD-ROM
(84+/85+/825+/826W+ only)



Remote control and 2 AA batteries

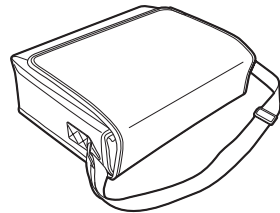

Carrying case



Security sticker

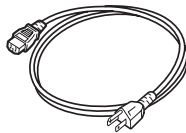

Power cord

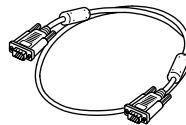

VGA computer cable

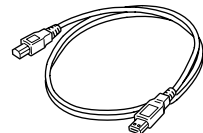

USB cable

Save all packaging in case you need to ship the projector. Always use the original packaging (or the equivalent) when you need to send the projector to another location. If you are moving the projector by hand, use the carrying case. See page 129 for transportation instructions.

Projector Parts

Front

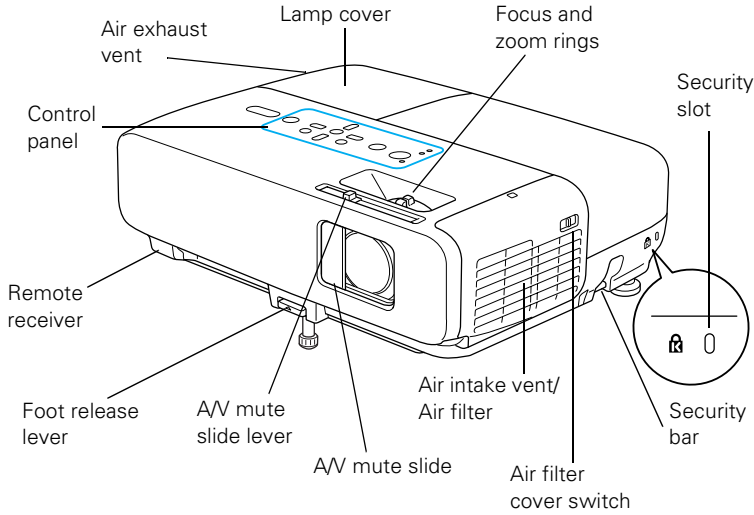

Back

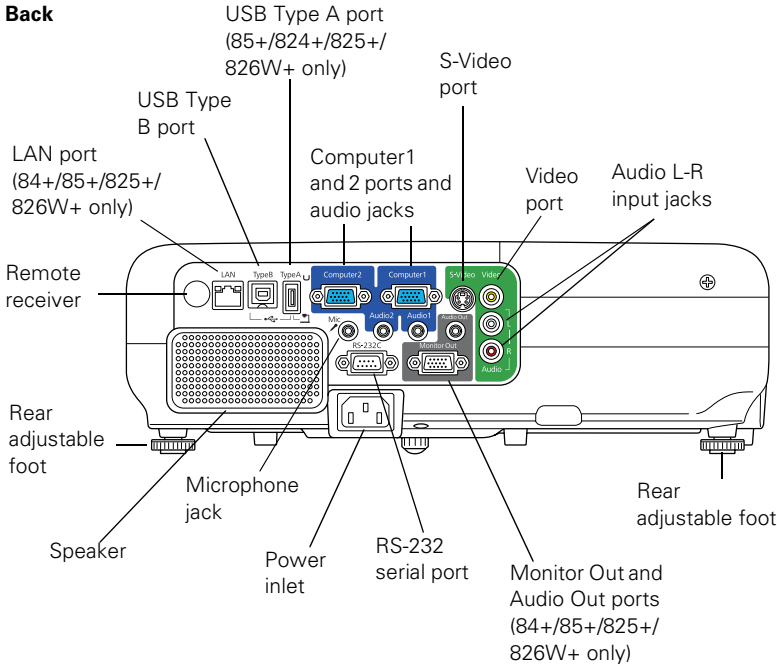

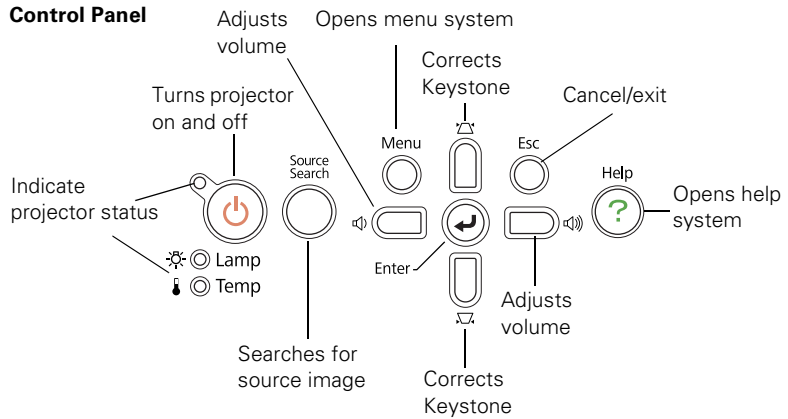

Additional Components

Depending on how you plan to use the projector, you may need additional components:

- To receive an S-video signal, you'll need an S-video cable. One may be provided with your video equipment, or you can purchase one from Epson; see the list on page 13.
- To receive a component video signal from a DVD player or other video device, you'll need an component-to-VGA video cable. You can purchase one from Epson; see the list on page 13.
- To play sound through your projector you will need an audio cable. One may be provided with your equipment, or you can purchase one from an electronics store.

Optional Accessories

To enhance your use of the projector, Epson provides the following optional accessories:

Product	Part number
Genuine Epson projector lamp	V13H010L50
Air filter replacement set (2 filters)	V13H134A22
DC-10s document camera	ELPDC10S
DC-06 document camera	V12H321001
Wireless 802.11a/b/g Module (PowerLite 85+/825+/826W+ only)	V12H306P11
Quick Wireless Connection USB key (ELPAP05) (PowerLite 85+/825+/826W+ only)	V12H005M05
Wheeled soft carrying case	ELPKS62
Soft shoulder carrying case	ELPKS61
Molded hard shell wheeled carrying case	ELPKS58
SwissGear® backpack	ELPKS63
Universal projector ceiling mount	ELPMBPJF
Advanced projector ceiling mount	ELPMBPRG
High security projector ceiling mount	ELPMBATA
Adjustable suspended ceiling channel kit	ELPMBP01
Suspended false ceiling plate kit	ELPMBP02
Structural round ceiling plate	ELPMBP03
Adjustable extension column, 8 to 11 inches	ELPMB01
Kensington® MicroSaver® security lock	ELPSL01
Duet™ portable projector screen	ELPSC80
50-inch portable screen (4:3 aspect ratio)	ELPSC06
80-inch portable pop-up screen (4:3 aspect ratio)	ELPSC08
Component-to-VGA video cable	ELPKC19
S-Video cable	ELPSV01
Distribution amplifier	ELPDA01
AP-60 Projector Sound Solution	V12H329020

You can purchase screens, carrying cases, or other accessories from an Epson authorized reseller. To find the nearest reseller, call 800-GO-EPSON (800-463-7766). Or you can purchase online at www.epsonstore.com (U.S. sales) or www.epson.ca (Canadian sales).

1 *Displaying and Adjusting the Image*

Whether you're presenting from a computer or video equipment, you need to follow some basic steps to display your image on the screen.

Follow the guidelines in this chapter for:

- Positioning the projector
- Turning the projector on and off
- Selecting the image source
- Adjusting the image

note

You can mount the projector on the ceiling, or place it behind a translucent screen for rear projection. See page 151 for details.

Positioning the Projector

If the projector isn't already installed in the room you're using, you'll probably want to place it on a table in front of the screen. This lets you stand in the front of the room, face the audience, and remain close enough to the equipment to be able to control it. Try to leave as much space as possible between the projector and the screen to get a good-size image.

Use the illustrations and tables below to help you determine placement. Image size increases with distance, but can vary depending on how you position the zoom ring and whether you've adjusted the image with other settings.

You can also use the [Image Size Calculator](#) on the Epson website.

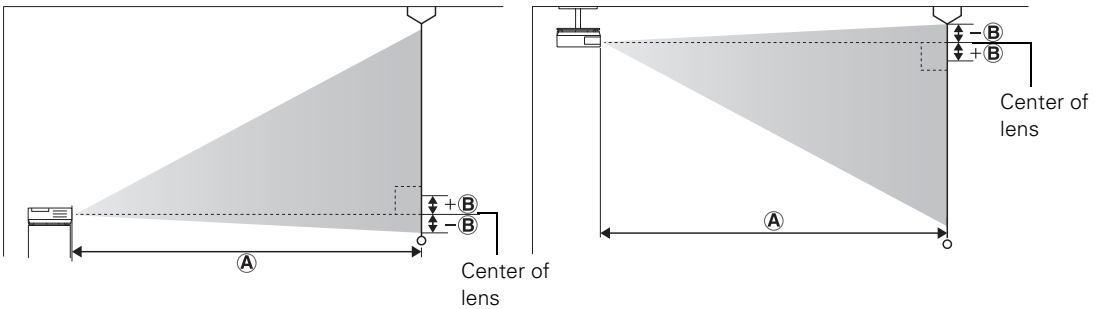

PowerLite 84+/85+/824+/825+ (4:3 images)

Screen size	Projection distance (A) Wide to Tele	Offset (B)
30 inches	33 to 54 inches (83 to 136 cm)	-1.8 inches (-5 cm)
40 inches	44 to 72 inches (111 to 182 cm)	-2.5 inches (-6 cm)
50 inches	55 to 90 inches (140 to 229 cm)	-3.1 inches (-8 cm)
60 inches	66 to 108 inches (169 to 275 cm)	-3.7 inches (-9 cm)
80 inches	89 to 145 inches (226 to 368 cm)	-4.9 inches (-13 cm)

Screen size	Projection distance (A) Wide to Tele	Offset (B)
100 inches	111 to 181 inches (283 to 460 cm)	-6.2 inches (-16 cm)
150 inches	168 to 272 inches (426 to 692 cm)	-9.2 inches (-23 cm)
200 inches	224 to 363 inches (568 to 923 cm)	-12.3 inches (-31 cm)
250 inches	280 to 455 inches (711 to 1155 cm)	-15.4 inches (-39 cm)
300 inches	336 to 546 inches (854 to 1386 cm)	-18.5 inches (-47 cm)

PowerLite 84+/85+/824+/825+ (16:9 images)

Screen size	Projection distance (A) Wide to Tele	Offset (B)
28 inches	33 to 55 inches (84 to 138 cm)	0.4 inches (1 cm)
30 inches	36 to 58 inches (91 to 149 cm)	0.4 inches (1 cm)
40 inches	48 to 78 inches (122 to 199 cm)	0.6 inches (1 cm)
50 inches	60 to 98 inches (153 to 249 cm)	0.7 inches (2 cm)
60 inches	72 to 118 inches (184 to 300 cm)	0.9 inches (2 cm)
80 inches	97 to 158 inches (246 to 401 cm)	1.2 inches (3 cm)
100 inches	121 to 197 inches (308 to 502 cm)	1.5 inches (4 cm)

Screen size	Projection distance (A) Wide to Tele	Offset (B)
150 inches	183 to 297 inches (464 to 754 cm)	2.2 inches (6 cm)
200 inches	244 to 396 inches (619 to 1006 cm)	2.9 inches (7 cm)
250 inches	305 to 495 inches (775 to 1258 cm)	3.7 inches (9 cm)
275 inches	336 to 545 inches (853 to 1384 cm)	4 inches (10 cm)

PowerLite 84+/85+/824+/825+ (16:10 images)

Screen size	Projection distance (A) Wide to Tele	Offset (B)
29 inches	33 to 55 inches (85 to 140 cm)	-0.4 inches (-1 cm)
40 inches	47 to 76 inches (118 to 193 cm)	-0.5 inches (-1 cm)
50 inches	58 to 95 inches (149 to 243 cm)	-0.6 inches (-2 cm)
60 inches	70 to 115 inches (179 to 292 cm)	-0.7 inches (-2 cm)
70 inches	82 to 134 inches (209 to 341 cm)	-0.9 inches (-2 cm)
80 inches	94 to 153 inches (239 to 390 cm)	-1 inches (-2 cm)
100 inches	118 to 192 inches (300 to 488 cm)	-1.2 inches (-3 cm)
150 inches	178 to 289 inches (451 to 733 cm)	-1.8 inches (-5 cm)
200 inches	237 to 385 inches (603 to 979 cm)	-2.5 inches (-6 cm)
250 inches	297 to 482 inches (754 to 1224 cm)	-3.1 inches (-8 cm)
280 inches	333 to 540 inches (845 to 1371 cm)	-3.4 inches (-9 cm)

PowerLite 826W+ (16:10 images)

Screen size	Projection distance (A) Wide to Tele	Offset (B)
30 inches	35 to 57 inches (88 to 144 cm)	-0.4 inches (-1 cm)
40 inches	47 to 76 inches (118 to 193 cm)	-0.5 inches (-1 cm)
50 inches	58 to 95 inches (149 to 243 cm)	-0.6 inches (-2 cm)
60 inches	70 to 115 inches (179 to 292 cm)	-0.7 inches (-2 cm)
80 inches	94 to 153 inches (239 to 390 cm)	-1 inches (-2 cm)
100 inches	118 to 192 inches (300 to 488 cm)	-1.2 inches (-3 cm)
150 inches	178 to 289 inches (451 to 733 cm)	-1.8 inches (-5 cm)
200 inches	237 to 385 inches (603 to 979 cm)	-2.5 inches (-6 cm)
250 inches	297 to 482 inches (754 to 1224 cm)	-3.1 inches (-8 cm)
280 inches	333 to 540 inches (845 to 1371 cm)	-3.4 inches (-9 cm)

PowerLite 826W+ (4:3 images)

Screen size	Projection distance (A) Wide to Tele	Offset (B)
25 inches	33 to 54 inches (83 to 136 cm)	-0.3 inches (-1 cm)
30 inches	39 to 65 inches (100 to 164 cm)	-0.4 inches (-1 cm)
40 inches	53 to 86 inches (134 to 219 cm)	-0.6 inches (-1 cm)
50 inches	66 to 108 inches (169 to 275 cm)	-0.7 inches (-2 cm)

Screen size	Projection distance (A) Wide to Tele	Offset (B)
60 inches	80 to 130 inches (203 to 331 cm)	-0.8 inches (-2 cm)
80 inches	107 to 174 inches (271 to 442 cm)	-1.1 inches (-3 cm)
100 inches	134 to 218 inches (340 to 553 cm)	-1.4 inches (-4 cm)
120 inches	161 to 261 inches (408 to 664 cm)	-1.7 inches (-4 cm)
150 inches	201 to 327 inches (511 to 831 cm)	-2.1 inches (-5 cm)
200 inches	269 to 436 inches (682 to 1108 cm)	-2.8 inches (-7 cm)
250 inches	336 to 546 inches (854 to 1386 cm)	-3.5 inches (-9 cm)

PowerLite 826W+ (16:9 images)

Screen size	Projection distance (A) Wide to Tele	Offset (B)
28 inches	33 to 55 inches (84 to 138 cm)	0.4 inches (1 cm)
30 inches	36 to 58 inches (91 to 149 cm)	0.4 inches (1 cm)
40 inches	48 to 78 inches (122 to 199 cm)	0.6 inches (1 cm)
50 inches	60 to 98 inches (153 to 249 cm)	0.7 inches (2 cm)
60 inches	72 to 118 inches (184 to 300 cm)	0.9 inches (2 cm)
80 inches	97 to 158 inches (246 to 401 cm)	1.2 inches (3 cm)
100 inches	121 to 197 inches (308 to 502 cm)	1.5 inches (4 cm)

Screen size	Projection distance (A) Wide to Tele	Offset (B)
150 inches	183 to 297 inches (464 to 754 cm)	2.2 inches (6 cm)
200 inches	244 to 396 inches (619 to 1006 cm)	2.9 inches (7 cm)
250 inches	305 to 495 inches (775 to 1258 cm)	3.7 inches (9 cm)
275 inches	853 to 1384 inches (83 to 136 cm)	4 inches (10 cm)

note

After positioning the projector, you may want to connect a Kensington MicroSaver® anti-theft device to the lock port on the projector. You can purchase this from Epson; see page 13.

Also keep these considerations in mind:

- Place the projector on a sturdy, level surface.
- Make sure there is plenty of space for ventilation around and under the projector.
- Make sure the projector is within 9 feet (2.7 meters) (PowerLite 84+/85+/825+/826W+) or 5 feet (1.5 meters) (PowerLite 824+) of a grounded electrical outlet or extension cord.

Ideally, you should place the projector directly in front of the center of the screen, facing it toward the screen squarely. The base of the lens should be at about the level of the bottom of the screen.

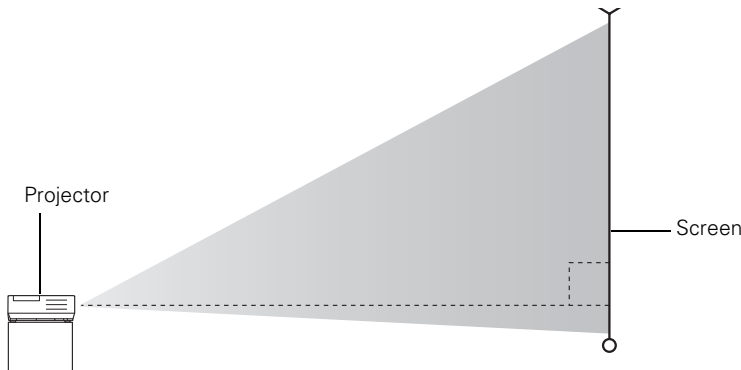

If you place the projector below screen level, you'll have to tilt it up by extending the front adjustable foot. This causes the image to become "keystone" shaped, but you can correct the distortion by pressing the buttons on the projector. See page 28 for detailed information about correcting the image shape.

For instructions on installing the projector in a permanent location, such as a theater or conference room, see page 151.

Turning the Projector On and Off

Make sure your projector and any computer or video equipment are connected as described on page 47. Turn on your connected equipment before starting the projector so it can automatically detect and display the image source. If you turn on the projector first, or have multiple pieces of connected equipment, you may have to select the image source manually (see page 25).

Turning On the Projector

Follow these steps to turn on the projector:

1. Open the A/V Mute slide (lens cover).

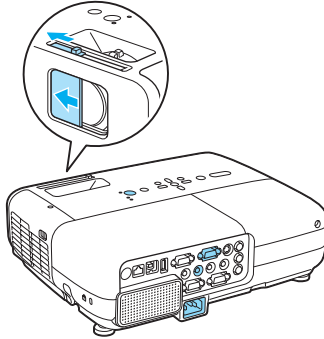

2. Plug one end of the power cable into the projector, and the other end into an electrical outlet.

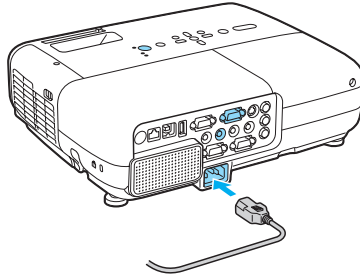

The  power light turns orange.

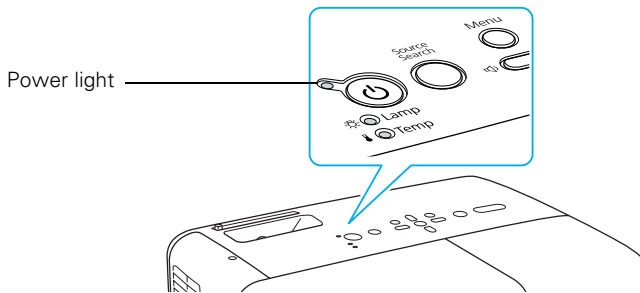

note

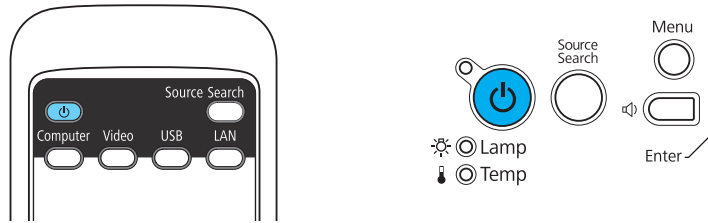

You can set the projector to automatically turn off the lamp and enter “sleep mode” when it has not received any signals or the A/V Mute slide remains closed for a period of time. This conserves electricity, cools the projector, and extends the life of the lamp. To enable sleep mode, see page 117.

3. Press the  power button on the remote control or on top of the projector.



warning

Never look into the lens when the lamp is on. This can damage your eyes, and is especially dangerous for children and pets.

The projector beeps once and the  power light flashes green as the projector warms up, then an image begins to appear. When the  power light stops flashing and remains green, the projector is ready for use.

4. If you are prompted to enter a password, see page 111.

Using the Direct Power On Function

The Direct Power On function enables faster setup. The projector will start up automatically when you plug it in; you won't have to press the  power button.

Follow these steps to enable Direct Power On:

1. Press the **Menu** button on the remote control and select the **Extended** menu.
2. Choose **Operation** and press **Enter**.
3. Choose **Direct Power On** and press **Enter**.

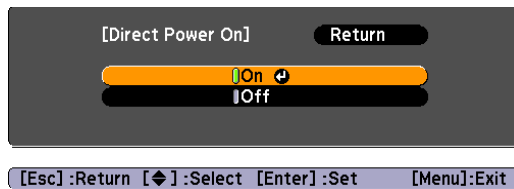

4. Highlight **On** and press **Enter**.
5. Press **Esc** or **Menu** to exit. The setting will take effect the next time you plug in the projector.

Shutting Down the Projector

This projector incorporates Instant Off technology. To turn the projector off, you can press its  power button as described below, or turn off a power switch that supplies power to the projector. You don't have to wait for the projector to cool off first.



1. To turn off the projector, press the  power button on the remote control or projector.

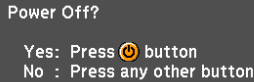

You see a confirmation message.

(If you don't want to turn it off, press any other button.)



Power Off?
Yes: Press  button
No : Press any other button

2. Press the  power button again. When the  power light stops flashing and you hear two beeps, unplug the power cord.

If you want to turn the projector on again, make sure the orange  power light is not flashing, then press the  power button.

3. If you extended the adjustable front foot, press up on the foot release lever to retract it.
4. Close the A/V Mute slide.

Selecting the Image Source

Selecting the image source lets you switch between images input from different pieces of connected equipment (such as a computer or DVD player).

If you don't see the image you want, press the **Source Search** button on the remote control or projector until you see the image you want to project.

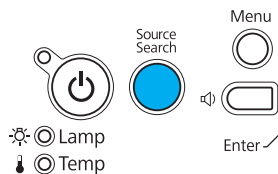
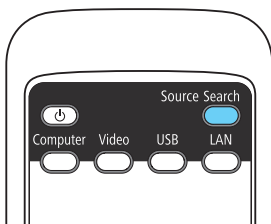

note

Lamp life results will vary depending on mode selected, environmental conditions, and usage.

Turn off this product when not in use to prolong the life of the projector.

note

To focus and adjust the image, see page 26. If a projected image fails to appear, see page 136 for help.

You can also use the **Computer**, **Video**, and **USB** buttons on the remote control to switch between devices connected to the ports identified on each button, or select **LAN** to project through your network (the **LAN** button does not work with the PowerLite 84+ or 824+). See page 33 for more information.

Adjusting the Image

Once you see your image, you need to make certain adjustments:

- If the image is too high or too low, you can reposition it. See page 27.
- To focus or zoom your image, see page 27.
- If the image isn't square, see page 28.
- If a computer image displays incorrectly, see page 30.
- If you need to fine-tune the image and/or sound, see page 101.

Adjusting the Height of Your Image

If the image is too low on the screen, you can use the front adjustable foot to raise it.

1. Stand behind the projector. Press the foot release lever up and lift the front of the projector.

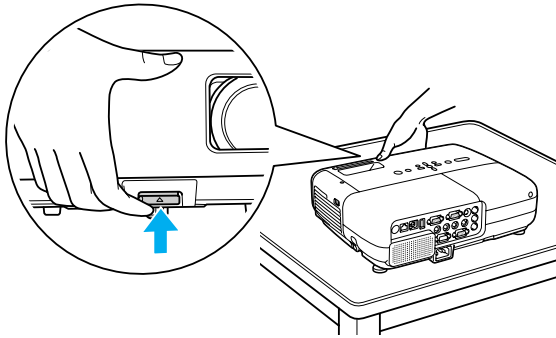

2. Once the image is positioned where you want it, release the lever to lock the foot in position.
3. If necessary, you can fine-tune the height or level of the image by turning the projector's adjustable rear feet.

Raising the projector causes the image to distort or “keystone,” but you can correct the shape as described on page 28.

Focusing and Zooming Your Image

Turn the focus ring on the projector to sharpen the image.

Turn the zoom ring on the projector to reduce or enlarge the image.



Focus

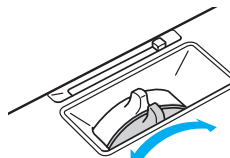

Zoom

If the image still isn't large enough, you may need to move the projector farther away from the screen. You can also use the **E-Zoom** buttons on the remote control to zoom in on a portion of the image. See page 35 for instructions.

Adjusting the Image Shape

In most cases, you can maintain a square or rectangular image by placing the projector directly in front of the center of the screen with the base of the lens level with the bottom of the screen.

Even if the projector is slightly tilted (within a range of 30° up or down), the projector has an automatic keystone correction function that detects and corrects vertical keystone distortion.

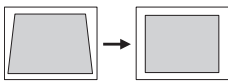
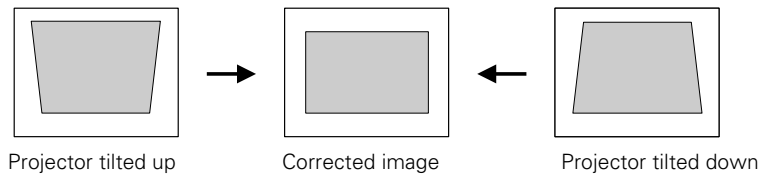

Keystone correction

It takes about one second after projection starts for the image to be corrected. During this time, a vertical keystone correction gauge appears on the screen.

If your image is still distorted, you can correct it using the Keystone buttons on the projector's control panel or the projector's Setting menu.

Using Keystone Correction

To adjust your image when it is wider on the top or bottom, do the following:

- Press one of the two keystone correction buttons on the projector's control panel, as shown below. Continue pressing the button until you are satisfied with the shape of the image.

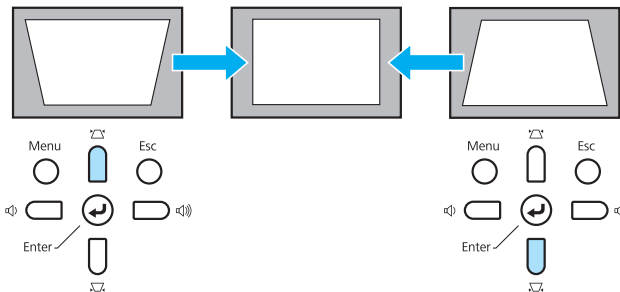

tip

You can display a test pattern to help align the image (see page 109).

- Or press the Menu button on the remote control or projector, select the Settings menu, and press Enter.

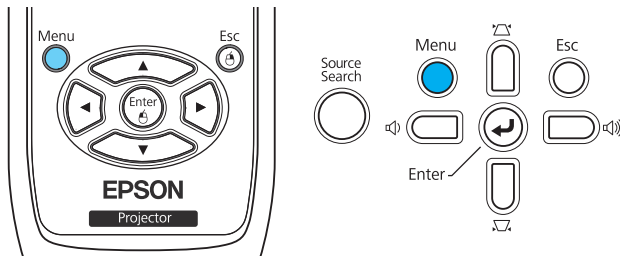

From the Settings menu, select **Keystone** and press **Enter**. Use the  pointer buttons on the remote control to adjust the keystone setting as needed.

If the image quality declines (for example, lines or edges look jagged), reduce the sharpness setting. See page 105.

Correcting Computer Images

note

The Auto button works only with computer images projected through the VGA port.

If you're connected to a computer and the image doesn't look right, press the **Auto** button on the remote control or the **Enter** button on the projector. This automatically resets the projector's tracking, sync, resolution, and position settings.

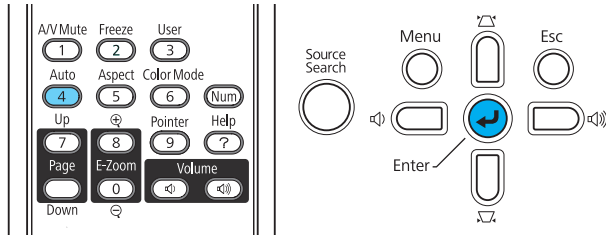

If the **Auto** button doesn't correct the problem, you may need to adjust the tracking or sync using the projector's Signal menu. See page 106 for more information.

2 *Using the Remote Control*

The projector includes a number of tools to enhance your presentation. All of them can be accessed using the remote control, which lets you operate the projector from anywhere in the room—up to 20 feet away.

You can use the remote control to adjust the picture and sound (page 33) or to adjust the color mode for various environments (page 38). You can also use it as a wireless mouse when projecting from a computer (page 41) or as a pointer to highlight your presentation (page 42).

This chapter covers:

- Using the remote control
- Controlling the picture and sound
- Operating your computer with the remote control
- Highlighting your presentation

note

If a button is pressed longer than 30 seconds, the remote control stops operating to conserve power. When you release the button, normal operation resumes.

caution

When replacing batteries, take the following precautions:

- Replace the batteries as soon as they run out. If the batteries leak, wipe away battery fluid with a soft cloth. If fluid gets on your hands, wash immediately.
 - Do not expose batteries to heat or flame.
 - Dispose of used batteries according to local regulations.
 - Remove the batteries if you won't be using the projector for a long period of time.
-

Using the Remote Control

Follow these tips for using the remote control:

- Point the remote control at the projector.
- Stand within 20 feet of the projector.
- Avoid using the remote under bright fluorescent lamps or in direct sunlight, or the projector may not respond properly.

Replacing the Batteries

Replace the batteries as described below:

1. Turn the remote control over.
2. Press the tab on the battery cover to open it.
3. Install two AA batteries, inserting the + and – ends as shown.
4. Close the cover, pressing it down until it snaps into place.

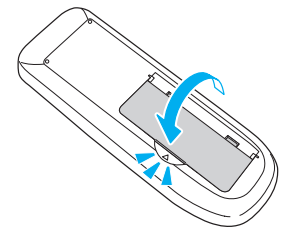
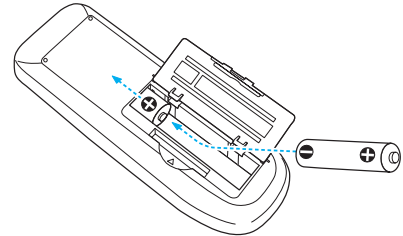
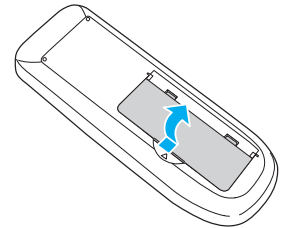

Controlling the Picture and Sound

You can use the remote control to preview and select your picture sources, temporarily turn off the picture and sound, freeze the action, zoom in on the picture, and adjust the volume.

Switching Between Picture Sources

If your projector is connected to more than one computer and/or video source, you can switch between the different sources:

- The easiest way to select your source is to press the **Source Search** button on the remote control or projector repeatedly until you see the image you want on the screen.

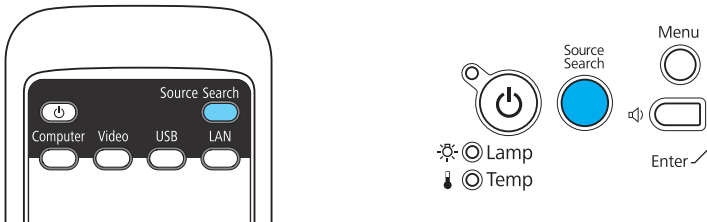

- On the remote control, there are four buttons you can use to switch between equipment connected to the port identified on each button:

Press the **Computer** button to toggle between the Computer1 and Computer2 ports, press the **Video** button to toggle between the Video and S-Video ports, and press the **USB** button to toggle between the USB ports. (The PowerLite 84+ only has one USB port.)

Or press the **LAN** button to project through your network. (The LAN button does not work with the PowerLite 84+ or 824+.)

After you select a source, the screen goes dark for a moment before the image appears.

Turning Off the Picture and Sound

You can use the **A/V Mute** button on the remote control to turn off the image and sound. This does the same thing as the A/V Mute slide (shown on page 23) and is useful if you want to temporarily redirect your audience's attention.

- To turn off the picture and sound, press the **A/V Mute** button. The screen turns black.
- To turn the image and sound back on, press the button again.

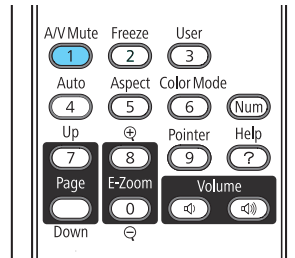

You can have the screen turn blue when you press the **A/V Mute** button. You can also have an image, such as a company logo, display on the screen (see page 114).

Stopping Action

You can use the remote control to stop the action in your video or computer image.

- To stop the action and keep the current image on the screen, press the **Freeze** button. The sound continues.
- To restart it, press the **Freeze** button again.

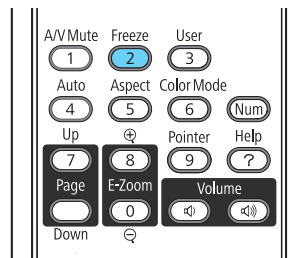





note

This function pauses the image, but not the sound. Also, because the source continues to transmit signals, you won't resume the action from the point you stopped it.



Zooming Part of Your Image

You can zoom in on a portion of the image using the E-Zoom buttons on the remote control.

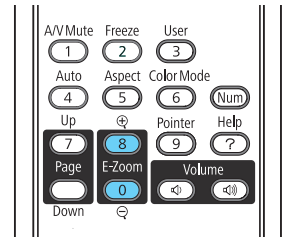
1. Press the E-Zoom  button on the remote control.
You see a crosshair indicating the center of the zoom-in area.
2. Use the  pointer buttons to position the crosshair.
3. Continue pressing the E-Zoom  button to enlarge the selected area up to 4× magnification.
4. While the image is enlarged, you can:
 - Use the  pointer buttons to move around the screen.
 - Press the E-Zoom  button to zoom out.
5. When done, press the ESC button to return the image to its original size.



Controlling the Volume

To change the volume, press the  or  button on the remote control or projector.

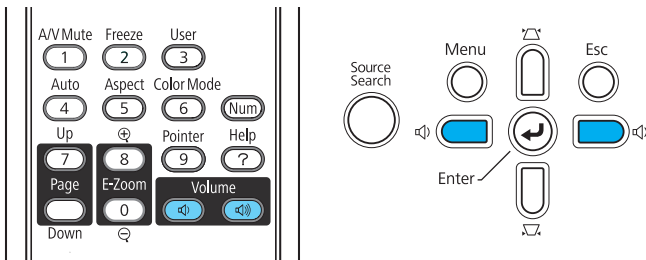

note

To temporarily shut off the sound and picture, press the A/V Mute button or close the A/V Mute slide.

You can also adjust the volume using the projector's menu system. See page 108.

Adjusting the Aspect Ratio

You can use the **Aspect** button on the remote control to adjust how an image fits into the display area. Each time you press the button, the projector changes to the next setting.

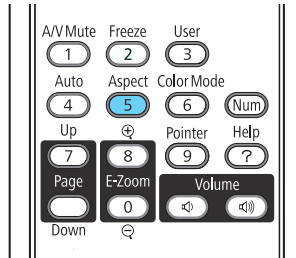

When Connected to Video Equipment

If you're projecting from video equipment such as a DVD player, set the projector's **Aspect** setting to match that of the player. For example, if the video player is set to output images at a 16:9 aspect ratio, set the projector's **Aspect** setting to 16:9 so they match. If the player outputs images at a 4:3 aspect ratio, select 4:3 (PowerLite 84+/85+/824+/825+) or Normal (PowerLite 826W+).

PowerLite 84+/85+/824+/825+

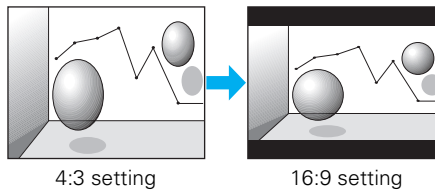

PowerLite 826W+

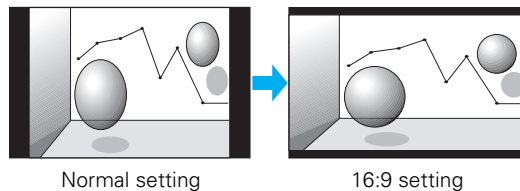

Note that the projector's native aspect ratio is narrower than 16:9. Therefore, widescreen movies and HDTV broadcasts will display with black bars at the top and bottom when 16:9 is selected as the **Aspect** setting. For the PowerLite 826W+, you can select **Full** to stretch the image vertically to fill the whole projection area.

When Connected to a Computer

For computer images, **Normal** is usually the best setting to select. This displays the image at the largest possible size without stretching it. For computers with wide-panel WXGA displays, the PowerLite 826W+ displays the image at WXGA resolution, making full use of the display area; likewise, the PowerLite 84+/85+/824+/825+ displays XGA images to their best advantage.

Depending on your computer display and projector model, you may see black bars at the edges. In that case, try selecting **16:9**. The PowerLite 826W+ also lets you select:

- **Full** to stretch the image to fill the whole projection area
- **Zoom** to fit the image in one dimension only, with the other dimension cut off
- **Native** to display the image without stretching or scaling it

If the resolution of the image is the same as the projector's, changing the **Aspect** setting has no effect. Also, if you're projecting through your computer's USB port, you can't change the projector's aspect ratio; instead, change your computer's resolution to match that of the projector.

note

If part of the image remains cut off, check the projector's Resolution setting (see page 106). Select Normal or Wide, depending on the size of your computer's display panel.

Adjusting the Color Mode

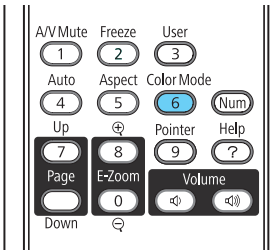

You can use the **Color Mode** button on the remote control to adjust the color, brightness, and other aspects of your image. This lets you quickly adjust the image for various uses.

Press the button repeatedly to select from the following settings:

Dynamic: For increased brightness and contrast when playing video games or watching TV in a bright room. If you notice video delays during high-speed gaming, turn off the **Progressive** setting (see page 107).

Presentation: For computer presentations in a bright room with color graphics.

Whiteboard: For computer presentations in a bright room with black-and-white text and graphics.

Theatre: For watching movies in a dark room.

Photo: For vivid, high-contrast still images in a bright room.

Sports: For vivid TV images projected in a bright room (component video, S-Video, or composite video only).

sRGB: For matching the color palette of standard sRGB computer displays

Blackboard: For projecting accurate colors on a green chalkboard (adjusts the white point).

Displaying Patterns

You can display a test pattern or one of the following 4 patterns for use on a whiteboard or chalkboard:



Pattern 1



Pattern 2



Pattern 3



Pattern 4

1. Press the **Menu** button on the remote control, then select the Settings menu and press **Enter**.
2. Highlight **Pattern** and press **Enter**.
3. Highlight **Pattern Type** and select one of the patterns shown above, or choose **Test Pattern**. If you want to create your own pattern, choose **User Pattern**. See page 40 for more information.
4. Press **Enter** to select the pattern you want, then press **Esc**.
5. Choose **Pattern Display** to display the pattern.
6. Press **Esc** when you're finished displaying the pattern.

Assigning a Pattern to the User Button

You can assign any of the available patterns to the **User** button on the remote control, and then display it by simply pressing the **User** button.

1. In the Settings menu, select the **Pattern Type** as described above.
2. Highlight **User Button** and press **Enter**.
3. Highlight **Pattern Display** and press **Enter**.
4. Press **Menu** to exit.

Creating Your Own Pattern

You can transfer any image from your computer or video source to the projector and then use it as a pattern. If you assign it to the **User** button as described on page 39, you can display it any time you want by simply pressing the **User** button on the remote control.

Start by displaying the image you want to use from a computer or other source. Then follow these steps to capture the image and transfer it to the projector:

note

When you choose an image for the user pattern, it erases any previously used image.



1. In the Settings menu, highlight **Pattern** and press **Enter**.
2. Select **User Pattern** and press **Enter**.
3. When you see a message asking if you want to use the current image as the pattern, select **Yes** and press **Enter**.
4. Press **Enter** again.
5. When you see a confirmation message, select **Yes** and press **Enter**. Saving the image may take a few moments. Do not use your projector, remote control, or video source while the logo is being saved.
6. When you see a message that saving is complete, press **Menu** to exit.

Operating Your Computer with the Remote Control

If you connect a computer to the projector with a USB cable, as described on page 51, then select **Wireless Mouse** for the USB Type B setting in the Extended menu (see page 118), you can use the remote control in place of your computer's mouse. This gives you more flexibility when delivering slideshow-style presentations, since you won't have to stand next to the computer to change slides.

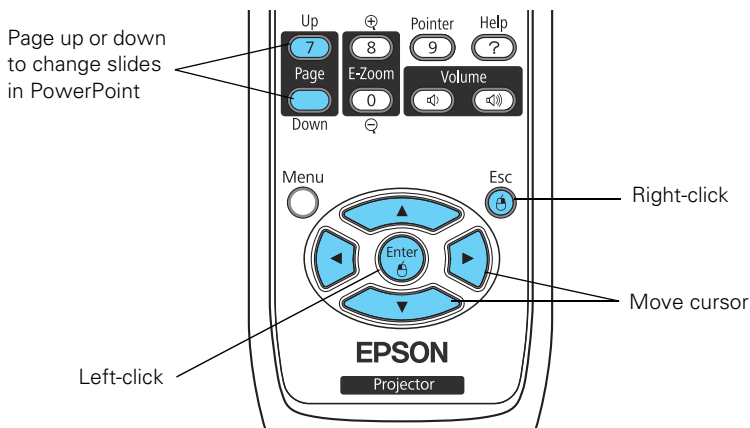
- Use the **Page Up** and **Down** buttons to move through a slideshow.



- Use the  pointer buttons to move the cursor on the screen.
- Press the **Enter** button once to left-click, or press it twice to double-click. Press the **Esc** button to right-click.
- To drag-and-drop, hold down the **Enter** button. Then use the  pointer buttons to drag the object. When it's where you want it, release the **Enter** button.

Highlighting Your Presentation

You can display a pointer to call out important information on the screen. If you want to customize the pointer tool, you can choose from three alternative shapes.

Using the Pointer Tool

1. To activate the pointer tool, press the **Pointer** button on the remote control. A pointer appears on the screen.

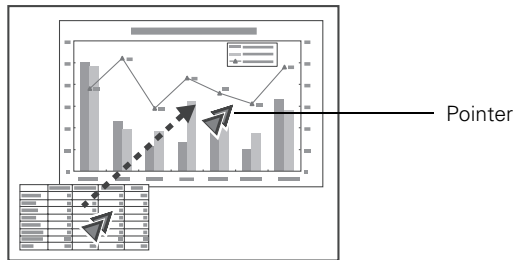
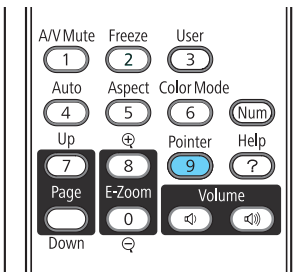

If you prefer to use a different style of pointer, see the instructions in the next section.

2. Use the  pointer buttons on the remote control to position the pointer on the screen.
3. When you're done using the pointer, press the **Pointer** or **Esc** button to clear the screen.

Customizing the Pointer Tool

You can change the appearance of the pointer by choosing from three alternative shapes.



1. Press the **Menu** button on the remote control, highlight the **Settings** menu, highlight **Pointer Shape**, and press **Enter**. You can select one of the pointer shapes shown at the left.
2. Select the shape you want and press **Enter**.
3. Highlight **Return** and press **Enter**.
4. Press **Menu** to exit from the menu system.

Presenting a Slideshow

You can use your projector's Slideshow feature whenever you connect a USB device that contains image files having a .JPG filename extension (not available on the PowerLite 84+). This lets you quickly and easily display individual images, or start a slideshow of all the images in a folder. You can control your slideshow using the projector remote control.

For an instant PowerPoint presentation, convert your PowerPoint slides to individual .JPG files (save as *.jpg) and store them in a folder. Copy that folder to a USB flash memory drive (thumb drive), or other USB device. Then connect the device to the projector and begin your presentation.

You can switch the display from the device displaying the slideshow to another source using the **Source Search** button or one of the specific source buttons on the remote control. To return to the Slideshow source, press **Source Search** and select **USB**, or simply press the **USB** button.

note

You can project .JPG files in resolutions up to 4608 × 3072.

If a .JPG file is highly compressed, your projector may not be able to display it correctly. The projector can't display progressive or CMYK .JPG files.

You cannot project movie files using the Slideshow feature.

Your projector may not be able to display files from a USB storage device that uses security functions.

Starting a Slideshow

1. Connect a USB device to the projector's USB TypeA port (see page 58).
2. If you are connected to another image source, press the **USB** button on the remote control to go to the Slideshow program.

If you are not connected to another image source, the Slideshow program appears automatically.



note

To rotate a displayed image, press the **▲** or **▼** button on the remote control until it is displayed correctly.

note

To display a slideshow from a folder that is not open, highlight the folder and press the **Esc** button on the remote control. Then select **Slideshow** from the menu that appears and press **Enter**.

To begin a slideshow from a particular image, use the arrow buttons to highlight that image, press **Enter**, then press **Enter** again.

If necessary, press the arrow buttons on the remote control to highlight the device you want to present from, then press the **Enter** button.

3. If you need to select a subfolder on your device, press the arrow buttons to highlight the folder and press **Enter**.
4. To display an individual image, press the arrow buttons to highlight it and press **Enter**. To display additional image files, press the **◀** or **▶** arrow button.
5. To display a slideshow of all the images in the current folder, use the arrow buttons to highlight **Slideshow** on the bottom of the Slideshow screen and press **Enter**. The images display sequentially one time through. At the end, you see the folder display again.

Select the following as necessary to control your display or slideshow:

- To move back up a folder level, highlight **Back to Top** at the top of the Slideshow screen and press **Enter**.
- To select a different device, highlight **Select drive** in the upper right corner of the screen, press **Enter**, and select the device.
- If all the images in a folder do not fit on the Slideshow screen, highlight **Next page** at the bottom of the screen and press **Enter** to display the next screen full of images. Select **Previous page** at the top of the screen to select the previous screen.
- To exit the slideshow, press **Esc**, select **Exit**, and press **Enter**.

Selecting Slideshow Display Options

To select slideshow options for images in the current folder, follow these steps:

1. Highlight **Option** at the bottom left corner of the slideshow screen and press **Enter**. You see this screen:

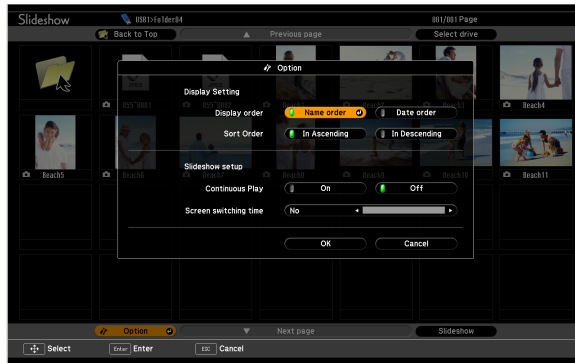

2. Highlight the options you want to use, and press **Enter**.

Option	Available settings
Display order	Name order displays files in name order Date order displays files in date order
Sort order	In Ascending sorts the files first to last In Descending sorts the files last to first
Continuous play	On displays a slideshow continuously Off displays a slideshow one time through
Screen switching time	No does not switch file display automatically 1Sec. to 60Sec. displays files for the selected time and switches them automatically

3. When you are finished, highlight **OK** at the bottom of the screen and press **Enter**. (Highlight **Cancel** and press **Enter** to cancel your changes.)

3

Connecting to Computers, USB Devices, and Other Equipment

This chapter tells you how to connect the projector to a notebook or desktop computer, video equipment (such as a VCR, DVD player, or video camera), and/or a microphone. With the PowerLite 85+/824+/825+/826W+, you can also connect the projector to a USB storage device, digital camera, or document camera. With the PowerLite 84+/85+/825+/826W+, you can also connect the projector to external speakers.

Follow the instructions in this chapter on:

- Connecting to a computer
- Connecting video equipment
- Connecting to a document camera, digital camera, or other device
- Playing sound through the projector

Connecting to a Computer

note

Don't try to force a connector to fit a port with a different shape or number of pins. You may damage the port or connector.

The illustrations in this chapter show the PowerLite 85+/825+/826W+. If you are using the PowerLite 84+/824+, the interfaces are slightly different, but the procedures are the same.

You can connect the projector to any computer that has a standard VGA output (monitor) port, including desktop models, PC notebook computers, MacBook®, PowerBook®, and iBook® systems, and hand-held devices.

You can also connect to the USB port on a Windows® or Macintosh® computer.

- To connect to your computer's VGA port, see page 49.
- To connect using your computer's  USB port, see page 50.
- To control your presentation using the remote control as a “wireless mouse,” see page 51.

Connecting to the VGA Port

You can connect to your computer using the VGA computer cable that came with the projector (the monitor port on your computer must be a mini D-sub 15-pin port).

1. Connect one end of the VGA computer cable to the projector's blue **Computer1** or **Computer2** port, and the other end to your computer's monitor port.

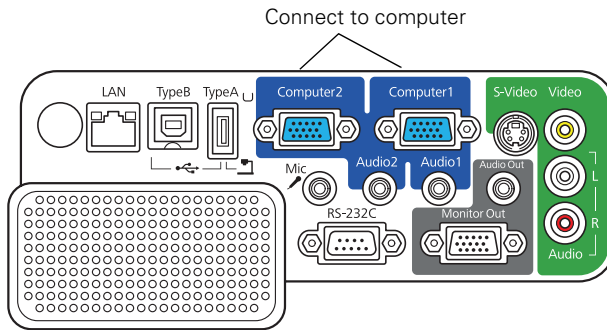

2. You can connect an optional stereo mini-jack audio cable to play sound through the projector (see page 59), or connect the USB cable to use the remote control as a mouse (see page 51).
3. When you've finished making any connections, see page 23 for instructions on turning on the projector and adjusting the image.

Once the projector is turned on, select the image source: press the **Source Search** button on the remote control or the projector's control panel.

note

Make sure the Input Signal setting in the Signal menu is set to Auto or RGB (see page 107).

Connecting to the USB Port

note

The USB display feature is not available for Windows 98 or Windows Me. To use this feature, your computer must allow you to install software from the projector. You may need Administrator rights.

When you are finished projecting via USB with Mac OS X, click the USB Display dock icon, select Disconnect (not Exit), and then remove the USB cable. With Windows, you can simply remove the USB cable (you don't need to use the Safely Remove Hardware feature).

You can connect a Windows 7, Windows Vista®, Windows XP, Windows 2000 (SP4), or Macintosh computer (with Mac OS® X 10.5.1-10.6) to the projector's TypeB (square) USB port and project your computer's display.

The first time you connect your computer to the projector's USB port, software from the projector installs on your computer.

1. Follow the instructions beginning on page 23 to turn on the projector and adjust the image.
2. Make sure the USB Type B setting in the projector's Extended menu is set to USB Display (see page 118).
3. Turn on your computer.
4. Locate the USB cable that came with your projector.
5. Connect the square end of the cable to the projector's TypeB (square) USB port.

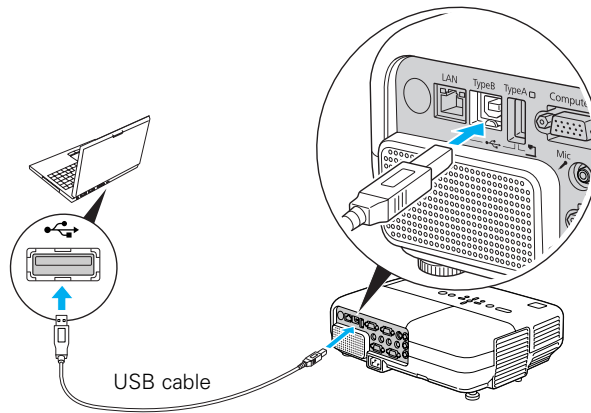

6. Connect the flat end of the cable to any available USB port on your notebook or desktop computer.

7. Do one of the following:

Windows: Messages appear as the projector is recognized and the software installation begins. Follow the instructions on your computer screen to install the Epson USB Display software. If you see a “Digital Signature Warning,” select **Continue**. You will only need to install the software the first time you connect.

Mac OS X: Double-click the **USB Display Installer** icon that appears on your computer screen (if the icon does not automatically appear, double-click **EPSON_PJ_UD** and then **USB Display Installer**). Follow the instructions on your computer screen to install the Epson USB Display Software. You will only need to install the software the first time you connect.

8. After the software has installed, press the **USB** button on the remote control. **USB Display** appears briefly in the upper right corner of the image and you see your computer’s desktop displayed by the projector.

note

Next time you connect via USB, you won’t have to wait for the software to install.

Connecting the USB Cable for Remote Mouse Control

If you’ve connected a computer as described in this chapter using the **Computer1** or **Computer2** port, you can use the projector’s remote control as a wireless mouse. This lets you control your computer and click through slideshow-style presentations, such as PowerPoint®, from up to 20 feet away (see page 41 for more information).

The wireless mouse function is supported on systems with a USB port running Windows or Mac OS.

1. Set the **USB Type B** setting in the projector’s Extended menu to **Wireless Mouse** (see page 118).
2. Locate the USB cable that came with your projector.

3. Connect the square end of the cable to the projector's Type B (square)  USB port.

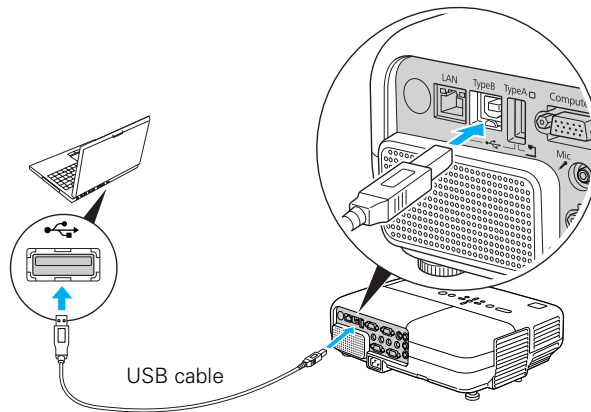

4. Connect the flat end of the cable to any available USB port on your notebook or desktop computer.
5. Press the **Computer** button on the remote control to select your computer as the source. (The wireless mouse function doesn't work when other sources are selected.)
6. If necessary, configure your computer to work with a USB mouse. See your computer documentation for details.

note

If you're using Mac OS X and you see a Keyboard Setup Assistant window, click Continue and then close the next screen.

Connecting an External Monitor

If you want to see your presentation close-up as well as on the projection screen, you can connect an external monitor to the projector (PowerLite 84+/85+/825+/826W+ only).

This lets you view images on your computer monitor while the projector is in standby mode (plugged in but not turned on). You can also check your presentation or switch between picture sources even if you've pressed the *A/V Mute* button on the remote control to turn off projection on the screen.

Connect the monitor's cable to the projector's **Monitor Out** port as shown.

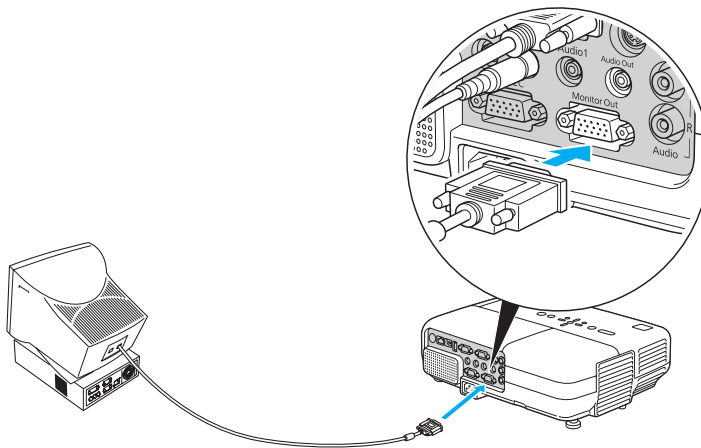

note

To use an external monitor, your computer must be connected to the Computer1 port. Additionally, you cannot use an external monitor if your signal is component video.

Connecting to Video Equipment

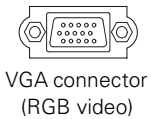
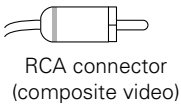

You can connect several video sources to the projector at the same time. Before starting, look at your video equipment to determine its available video output connections:

- If your video player has a yellow RCA-style video output connector, see “Connecting a Composite Video Source” below.
- If your video player has an S-video connector, see “Connecting an S-Video Source” on page 55.
- If your video player has a component video port (three connectors labeled either Y/Cb/Cr or Y/Pb/Pr), see “Connecting a Component Video Source” on page 56.
- If your video player has an RGB video port (either a single connector for a VGA-style monitor cable or three connectors labeled R/G/B), see “Connecting an RGB Video Source” on page 57.

After connecting video cables, you may also want to connect an audio cable to play sound through the projector; see page 59.

Connecting a Composite Video Source

1. Locate an RCA-style video cable (one is usually provided with your video equipment or you can purchase one from an electronics dealer).
2. Connect the cable to the yellow video output connector on your player and the yellow **Video** connector on the projector:

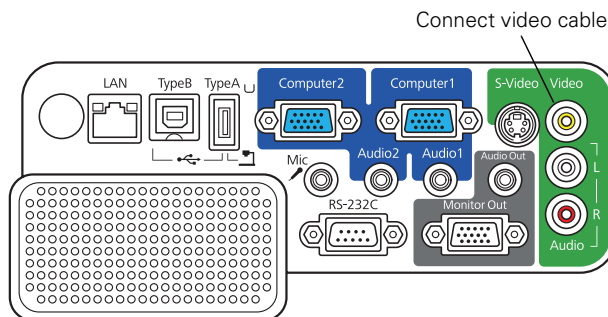

3. If you want to play sound through the projector, see page 59 for instructions on connecting audio cables.
4. If you don't need to make any other connections, see page 22 for instructions on turning on the projector and adjusting the image.

Once the projector is turned on, select the image source: press the **Source Search** button on the remote control or the projector's control panel.

Connecting an S-Video Source

1. Locate an S-Video cable (one is usually provided with your video equipment or you can purchase one from Epson; see page 13).
2. Connect the cable to the S-Video connector on your player and the **S-Video** connector on the projector:

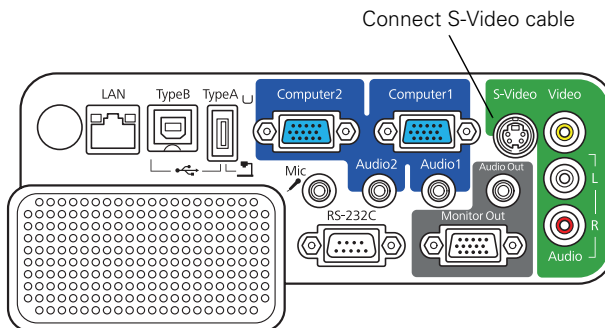

3. If you want to play sound through the projector, see page 59 for instructions on connecting audio cables.
4. If you don't need to make any other connections, see page 22 for instructions on turning on the projector and adjusting the image.

Once the projector is turned on, select the image source: press the **Source Search** button on the remote control or the projector's control panel.

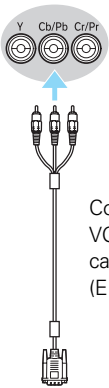

Component-to-VGA video cable (ELPKC19)

Connecting a Component Video Source

You will need a component-to-VGA video cable, or a component video cable and adapter, for this connection. You can order the component-to-VGA video cable (ELPKC19) from Epson; see page 13 for more information.

1. Connect the VGA-end of the cable to the blue **Computer1** or **Computer2** connector on the projector.

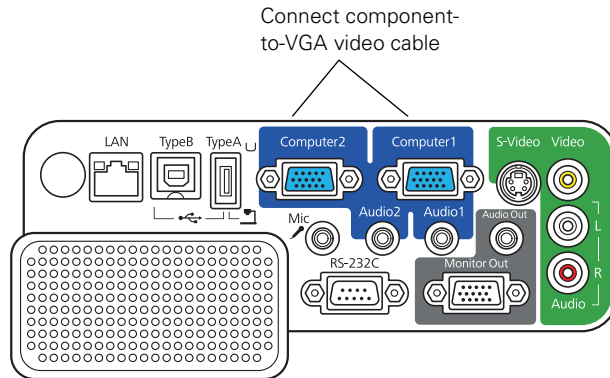

2. Insert the three component ends of the component-to-VGA video cable into the color-coded output ports on your video source, usually labelled Y, Pb, Pr or Y, Cb, Cr.
3. If you want to play sound through the projector, see page 59 for instructions on connecting audio cables.
4. If you don't need to make any other connections, see page 22 for instructions on turning on the projector and adjusting the image.

Once the projector is turned on, press the **Source Search** button on the remote control or the projector's control panel and select **Computer1** or **Computer2** as the image source.

note

Make sure the Input Signal setting in the Signal menu is set to Auto or Component Video (see page 107).

Connecting an RGB Video Source

1. Locate the VGA computer cable provided with the projector.
2. Connect the cable to the video port on your player and the Computer1 or Computer 2 port on the projector.

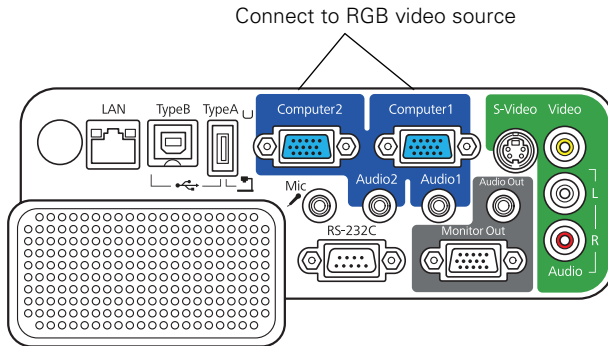

3. If you want to play sound through the projector, see page 59 for instructions on connecting audio cables.
4. If you don't need to make any other connections, see page 22 for instructions on turning on the projector and adjusting the image.

Once the projector is turned on, press the **Source Search** button on the remote control or the projector's control panel and select **Computer1** or **Computer2** as the image source.

note

Make sure the Input Signal setting in the Signal menu is set to Auto or RGB Video (see page 107).

Connecting to a Digital Camera, Document Camera, or Other Device

note

Use a cable less than 10 feet long and connect the camera directly to the projector. Your projector may not function correctly if you use a longer cable or connect your camera to a USB hub.

If you connect a USB hard drive, make sure you use the AC adapter to power the hard drive.

USB storage devices must be formatted FAT 16/32, and images must have a .jpg file extension and must not exceed 4608 × 3072.

You can connect a digital camera, document camera, USB flash memory drive (thumb drive), or other device (PowerLite 85+/824+/825+/826W+ only). Use the USB cable specified for your device.

You can use the projector's Slideshow feature (see page 43 for details) to present JPEG images.

1. Connect the flat end of the USB cable to the Type A USB port on the projector, as shown. You can connect a thumb drive directly to the Type A USB port.

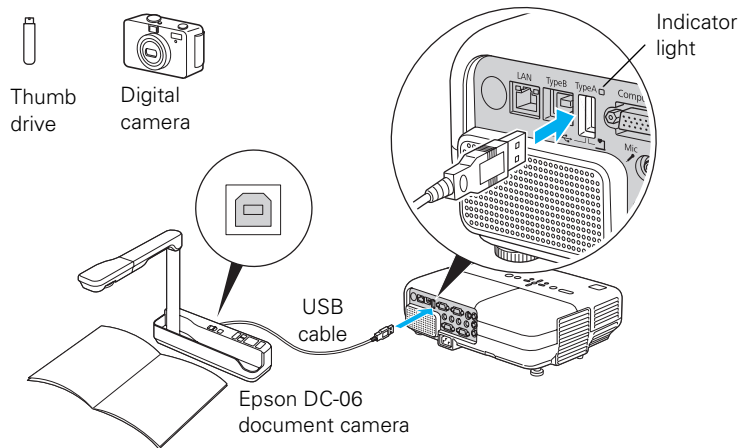

2. Connect the other end of the cable to your digital camera, document camera, or other device.

The indicator light turns orange and then green when a USB device is connected.



3. Press the **USB** button on the remote control or the **Source Search** button on the projector's control panel.

If you connect a digital camera or USB storage device, you can use the  pointer and **Enter** buttons on the remote control to move through your images.

4. When you are finished projecting from the USB device, turn off the device if necessary, then disconnect the USB cable.

Playing Sound Through the Projector

You can play sound through the projector's speaker system. Or, with the PowerLite 84+/85+/825+/826W+, you can attach an external speaker system. You can also connect a microphone and output the sound through the projector.



You can use the  or  **Volume** buttons on the projector or the remote control to adjust the volume.

Playing Computer Audio

For laptop and most desktop computers, use a 3.5 mm stereo mini-jack cable, which you can purchase from a computer or electronics store.

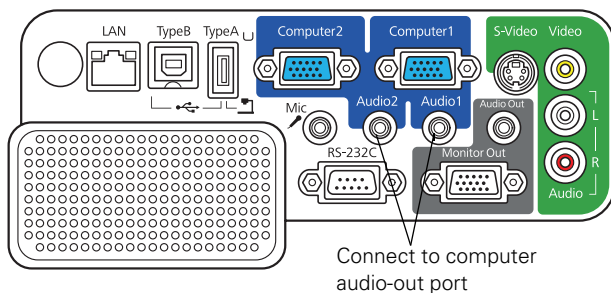
1. Connect one end of the cable to the **Audio1** or **Audio2** jack on the projector.



2. Connect the other end to your laptop's  headphone jack or  audio-out jack, or your computer's speaker or audio-out port.

Playing Sound from Video Equipment

For video equipment, use an RCA-style audio cable, which you can purchase from an electronics store.

note

If you are using the component-to-VGA video cable, you will need to connect an audio adapter to use the Audio1 or Audio2 jack.

1. Connect the red and white plugs on one end of the cable to the L and R Audio jacks on the projector.

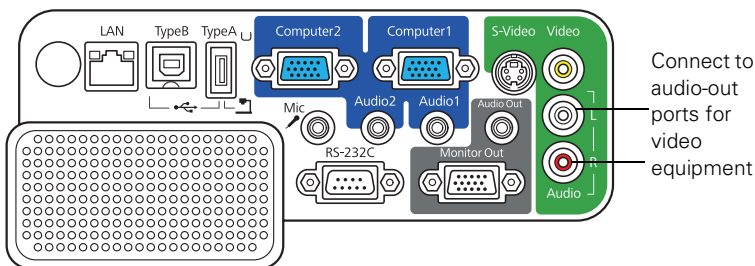

2. Connect the red and white plugs on the other end to the corresponding color-coded audio output jacks on your video source.

Connecting a Microphone

You can connect a dynamic or condenser microphone to the projector's Mic port, using a 3.5 mm mini-jack cable as shown below.

note

If you are using a condenser microphone, make sure the Plug-in Power setting in the Extended menu is set to On. See page 116 for more information.

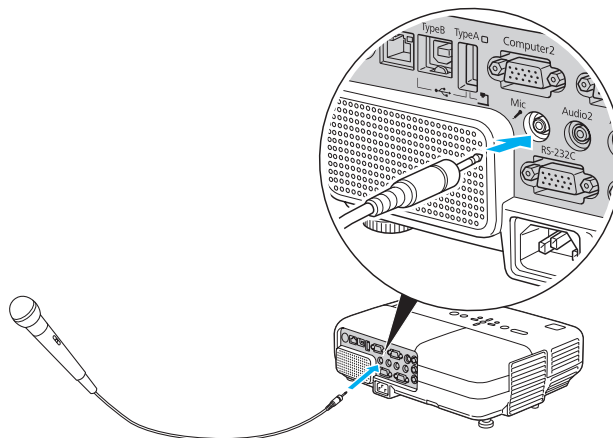

Use the Mic Input Level option on the Settings menu to adjust the volume. See page 109 for more information.

Connecting External Speakers

You can output sound from the projector to external speakers with a built-in amplifier (PowerLite 84+/85+/825+/826W+ only).

1. Locate the appropriate cable to connect your speakers.

Depending on your speakers, you may be able to use a standard audio cable with a stereo mini-jack connector on one end and pin jacks on the other end. For some speakers, you may need a special cable or adapter.

2. Connect the stereo mini-jack end of the audio cable to the **Audio Out** port on the projector.

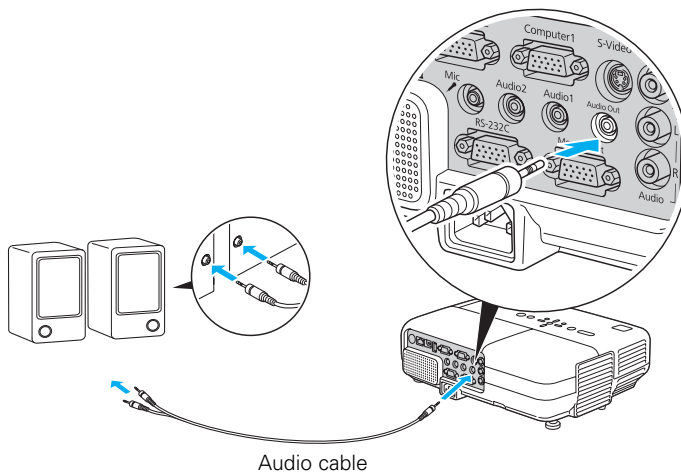

3. Connect the other end of the cable to your speakers.

The projector's internal speaker system is disabled while sound is output to external speakers.

4

Using the Projector on a Network

If you're using the PowerLite 85+/825+/826W+, you can use Quick Wireless Connection or EasyMP® Network Projection to project images shown on your computer screen—including text, graphics, and video—directly to your audience. See the *EasyMP Network Projection Operation Guide* for information on features and use.

With the PowerLite 84+/85+/825+/826W+, you can use EasyMP Monitor (available for Windows only) to monitor and control your projector through the network. For information on installing and using EasyMP Monitor, see the *EasyMP Monitor Operation Guide*.

You'll find instructions in this chapter on:

- Connecting the projector to a wired LAN
- Installing the optional wireless LAN module
- Using Quick Wireless Connection
- Configuring projector and network settings
- Using wireless security options
- Removing the optional wireless LAN module
- Sending e-mail alerts and monitoring the projector
- Using a browser to control the projector

For wireless connection, make sure you've installed the optional Wireless 802.11 a/b/g Module, as described on page 67. Then follow the steps in this chapter to use Quick Wireless Connection (Windows only) or configure your projector and network. See the *EasyMP Network Projection Operation Guide* for instructions on installing the

EasyMP Network Projection software. The *EasyMP Network Projection Operation Guide* also contains instructions on using the software to project over the network.

Connecting to a Wired Network

With a shielded, Category-5 Ethernet cable, you can connect the projector to your network and configure it with an IP address.

note

This illustration shows the PowerLite 84+. If you are using the PowerLite 85+/825+/826W+, the interfaces are slightly different, but the procedures are the same.

1. Connect the projector to your network using a commercially available 100BaseTX or 10BaseT network cable. Connect the cable to the LAN port on the projector as shown.

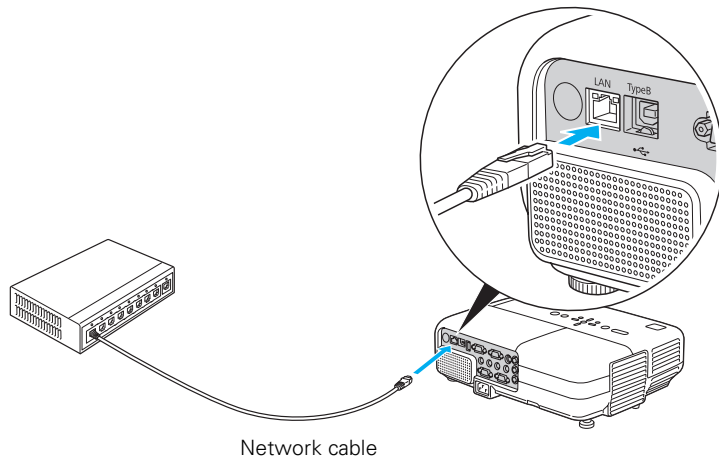

2. Connect the other end to your Ethernet hub or router.
3. Point the remote control at the projector and press the  power button.

4. Press the Menu button on the remote control, select the Network menu, then press Enter.

PowerLite 85+/825+/826W+

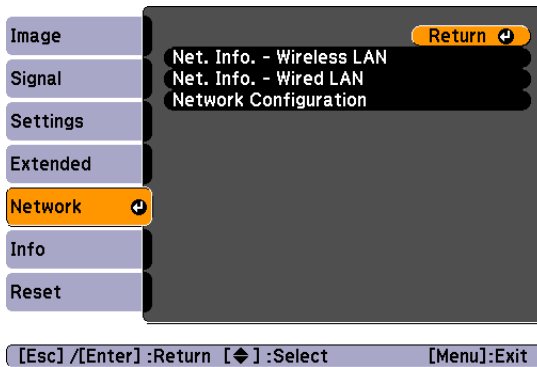

PowerLite 84+

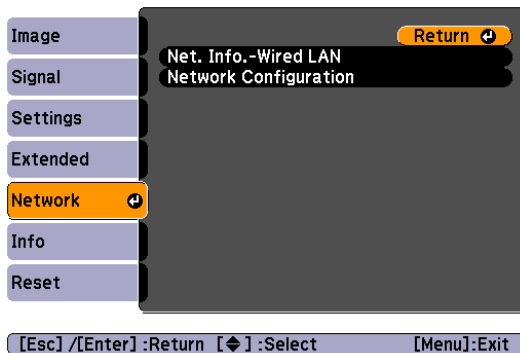

5. Choose Network Configuration and press Enter.
6. Select the Wired LAN menu and press Enter.

7. Choose **IP Settings** and press **Enter**. You see a screen like the following:

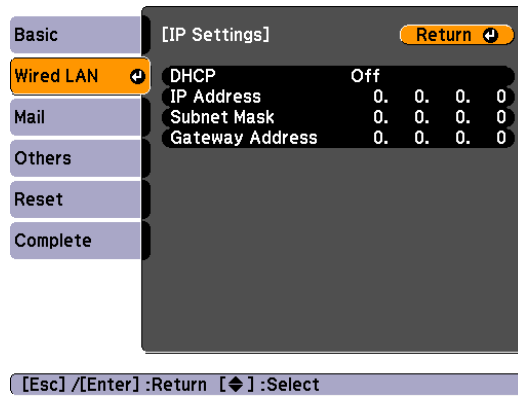

8. Do one of the following:
 - If your network assigns addresses automatically, turn on the DHCP setting.
 - If your network does not assign addresses automatically, turn off DHCP and enter the projector's IP Address, Subnet Mask, and Gateway Address, as needed.

To enter numbers, use the  buttons on the remote control to highlight the number you want to input, then press the **Enter** button. When you're finished entering an address in the network menu, highlight **Return**, then press the **Enter** button.

9. To prevent the IP address from appearing on the standby screen, set the IP Address Display setting to **Off**.
10. When you're done making these settings, highlight the **Return** button at the top of the screen, then press **Enter**. Choose **Complete** and press **Enter**, then choose **Yes** and press **Enter** to save your settings.

Press **Menu** to exit the menu system.

Installing the Optional Wireless 802.11a/b/g Module

Make sure you have the optional Wireless 802.11a/b/g Module (PowerLite 85+/825+/826W+ only). Turn off the projector and disconnect the power cord before you install the module.

1. Open the air filter cover by sliding the switch and pulling down the cover.

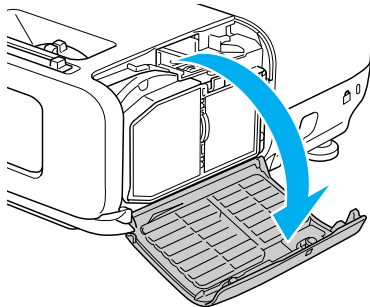
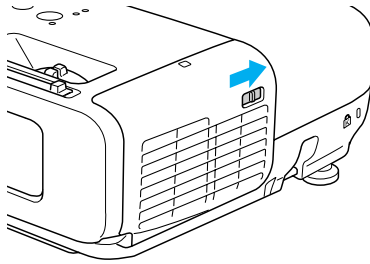

2. Insert the Wireless 802.11a/b/g Module as shown.

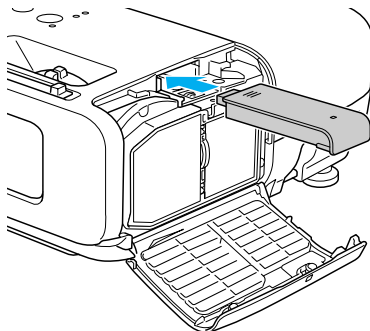

3. Fasten the module using the screw that came with it.

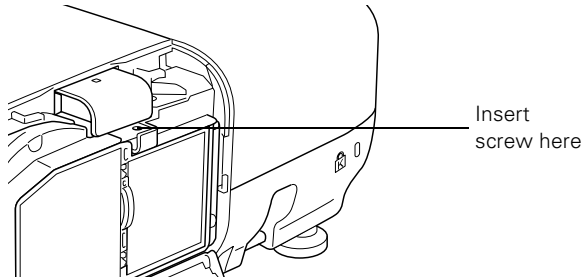

4. Close the air filter cover.

If you have the optional USB key, you can use Quick Wireless connection as described in the next section. Or, you can configure your connection manually as described on page 69.

Using Quick Wireless Connection

Using the optional USB key, you can quickly connect the projector to a Windows computer wirelessly without any configuration (PowerLite 85+/825+/826W+ only).

note

Do not attempt to write to the USB key or use it as a flash memory drive.

First, make sure you have installed the wireless module as described on page 67 and turned on the projector.

1. Connect the USB key to the projector's  TypeA (flat) USB port.
2. When you see a projected message that the network information update is complete, remove the USB key.
3. Connect the USB key to a USB port on your computer or notebook.

In Windows Vista, if you see the AutoPlay window, select **Run LaunchQW.exe**. When you see the User Account Control screen, click **Allow**.

4. Follow the instructions on the screen to install the Quick Wireless Connection driver.

If you see a Windows Firewall message, click **Yes** to disable the firewall.

After a few minutes, your computer image will be displayed through the projector. If not, try restarting your computer.

5. When you're done with your presentation, remove the USB key. You may need to restart your computer to reactivate your wireless interface.

note

The Quick Wireless Connection utility will disable any other wireless sessions and adapter programs. Make sure you leave the USB key in your computer for your entire Quick Wireless Connection session.

Configuring Basic Settings

You can give your projector a unique name, enable a projector keyword, or create a password for controlling the projector over the Web.

1. Press the **Menu** button, then choose **Network** and press **Enter**.
2. Choose **Network Configuration** and press **Enter**.
3. Choose **Basic** and press **Enter**. You see a screen like the following:

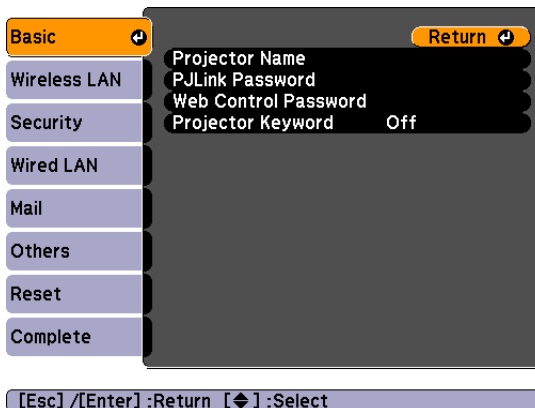

4. Make sure the projector has a unique name, so you can identify it on your network.

If you need to rename it, highlight the **Projector name** text box then press **Enter**.

5. Use the  buttons on the remote control to select individual letters; then press **Enter** to input a character. To add a blank space or to navigate backward and forward through the input text, highlight the arrows and press **Enter**. To toggle symbol settings or capital letters, highlight the option and press **Enter**. When you're done, highlight **Finish** and press **Enter**.

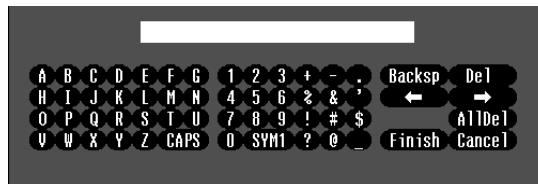

6. If you want to create a password for using PJLink to control the projector, highlight **PJLink Password**, press **Enter**, and enter a password of up to 8 alphanumeric characters. When you're done, highlight **Finish** and press **Enter**.
7. If you want to create a password for remote access to the projector, highlight **Web Control Password**, press **Enter**, and enter a password of up to 8 alphanumeric characters. When you're done, highlight **Finish** and press **Enter**.
8. If you want to set up a security keyword so that only people who are in the same room as the projector can access it, set the **Projector keyword** option to **On** (PowerLite 85+/825+/826W+ only). Then when you want to connect to the projector, it displays a randomized four-digit number or “keyword” on the screen. If you're using EasyMP Network Projection, you can enter the keyword on your computer to connect (see the *EasyMP Network Projection Operation Guide* for details).
9. When you're done making these settings, highlight the **Return** button at the top of the screen, then press **Enter**. Choose **Complete** and press **Enter**, then choose **Yes** and press **Enter** to save your settings.

Configuring the Connection

You can use EasyMP Network Projection to connect to the projector and send images wirelessly in two modes: Ad Hoc mode or Access Point mode (PowerLite 85+/825+/826W+ only).

- **Ad Hoc mode** (computer-to-computer mode) lets you connect just one computer to the projector at a time; it's easy to set up, and the only equipment you need is a computer with a wireless (802.11g, 802.11b, or 802.11a) network card or adapter, or a Macintosh with an AirPort® or AirPort Extreme card. When you connect with this mode, any connection to other wireless networks is broken; you can connect to the projector only.
- **Access Point mode** (infrastructure mode) lets multiple computers access the projector at the same time and easily trade off control over the projector. To use Access Point mode, you need a wireless (802.11g, 802.11b, or 802.11a) access point or an AirPort Extreme (or AirPort) base station, and one or more computers with wireless network cards or adapters.

Follow the instructions below for the mode you want to use.

Using Ad Hoc Mode

To use Ad Hoc (computer-to-computer) mode, adjust your projector and wireless card or adapter settings as described in this section.

Configuring the Projector

1. Press the **Menu** button, then choose **Network** and press **Enter**.
2. Choose **Network Configuration** and press **Enter**.

note



Make sure you've installed the EasyMP Network Projection software as described in the EasyMP Network Projection Operation Guide.

To connect to the projector over a wireless network, your computer must be running Windows 7, Vista, XP, or 2000 (SP4). Your Mac must be running Mac OS X 10.3 to 10.6.

Access Point mode (infrastructure mode) is required to achieve transfer speeds up to 54MB/sec on an 802.11g network. Ad Hoc mode (computer-to-computer mode) limits network connections to 11MB/sec. This is a standard specification of 802.11g networking.

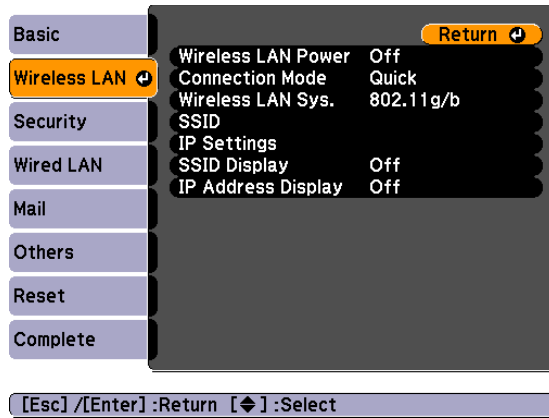
- Choose **Wireless LAN** and press **Enter**. You see this screen:



- Make sure **On** is selected for the **Wireless LAN Power** setting.
- Make sure **Quick** is selected for the **Connection mode**. If not, use the  buttons on the remote control to highlight **Quick**, then press **Enter** to select it.
- If your network is using **802.11a**, use the  buttons on the remote control to highlight **802.11a**, then press **Enter** to select it.
- If your network card supports an **SSID** or **ESSID** name (see page 76), highlight the **SSID** text box, press **Enter**, and enter a name:

Use the  buttons to select individual letters; then press **Enter** to input a character. To add a blank space or to navigate backward and forward through the input text, highlight the arrows and press **Enter**. To toggle symbol settings or capital letters, highlight the option and press **Enter**. When you're done, highlight **Finish** and press **Enter**.

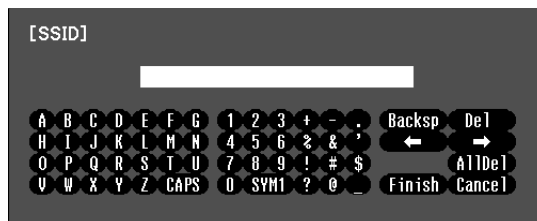

Note that the SSID is case-sensitive (if you enter the name in uppercase on the projector, you must type it the same way on the computer connecting to the projector).

8. If you want to prevent the SSID from being displayed on the standby screen, set the **SSID Display** option to **Off**.
9. To prevent the IP address from appearing on the standby screen, set the **IP Address Display** setting to **Off**.
10. When you're done making these settings, highlight the **Return** button at the top of the screen, then press **Enter**. Choose **Complete** and press **Enter**, then choose **Yes** and press **Enter** to save your settings.

Now you're ready to set up your computer to project wirelessly. Go to "Configuring the Network Settings for Windows" on page 74, or "Setting Up Your Mac for Ad Hoc Mode" on page 76.

Configuring the Network Settings for Windows

Before connecting to the projector, you need to make sure the settings for your notebook's or PC's network card match the settings you entered for the projector.

note

On some Windows systems, you can right-click My Network Places or Network Neighborhood on the desktop and select Properties.

Settings may vary, depending on your wireless network adapter. See the documentation for your adapter for more information.

1. Access your wireless network Properties window. For example, in Windows XP you would click **Start > Control Panel > Network and Internet Connections**. Then click the **Network Connections** icon. You see a screen similar to this:

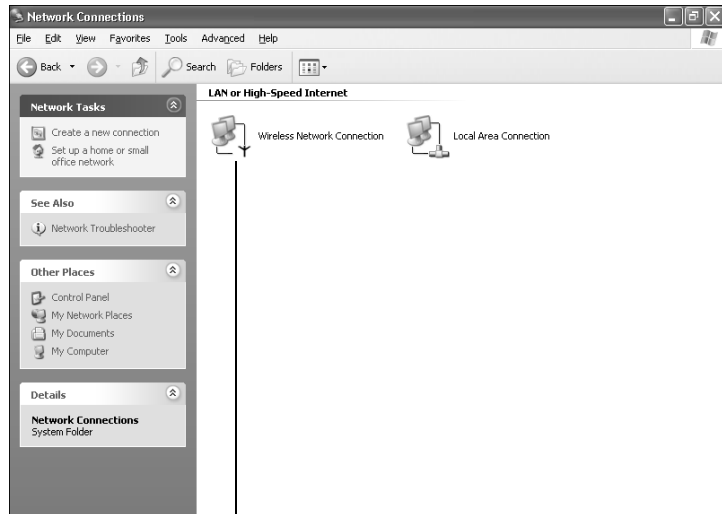

Right-click and select Properties

2. Right-click the **Wireless Network Connection** icon and select **Properties**. You see a screen similar to this:

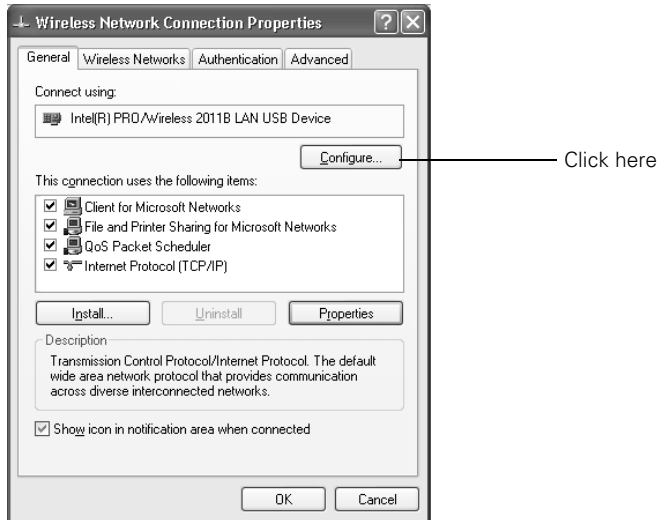

note

When you connect in Ad Hoc mode, your computer is disconnected from any other wireless networks. If you need to remain connected to your wireless network, use Access Point mode, as described on page 78. Also, make sure you reconnect to your original wireless network when you are done using the projector.

3. Click the **Configure** button.
4. Click the **Advanced** tab. You see a screen similar to this:

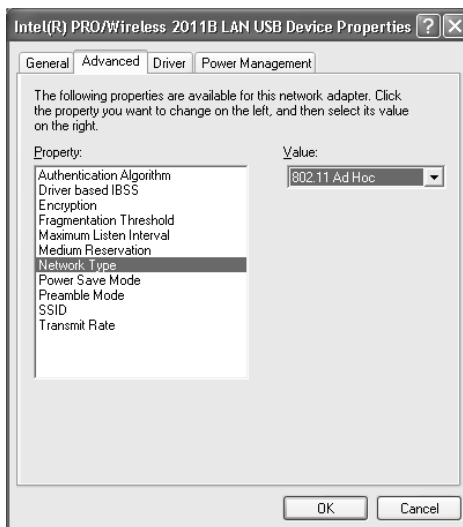

5. Check your wireless card or adapter device settings. (Depending on the type of card or adapter you're using, some of the settings may be different than those listed here.)
 - Set the Network Type to **802.11 Ad Hoc**.
 - Set the SSID to match the name you assigned to the projector's SSID.
 - Make sure Encryption is **Disabled**.
6. Click the **General** tab and make sure that your wireless card or adapter is enabled.
7. When you're done, click **OK** to close the Properties dialog box.

Now you're ready to connect to the projector. See the *EasyMP Network Projection Operation Guide* for details.

Setting Up Your Mac for Ad Hoc Mode

Your AirPort software is automatically configured to allow your Mac to detect both computer-to-computer (Ad Hoc) and Access Point networks.

Typically, you only need to select your projector's SSID from the AirPort status menu on the Mac menu bar. If you're having problems detecting the projector, follow these steps:

1. From the Apple pull-down menu, select **System Preferences**.
2. Click the **Network** icon. You see the Network settings window.

3. Make sure Location is set to **Automatic**.

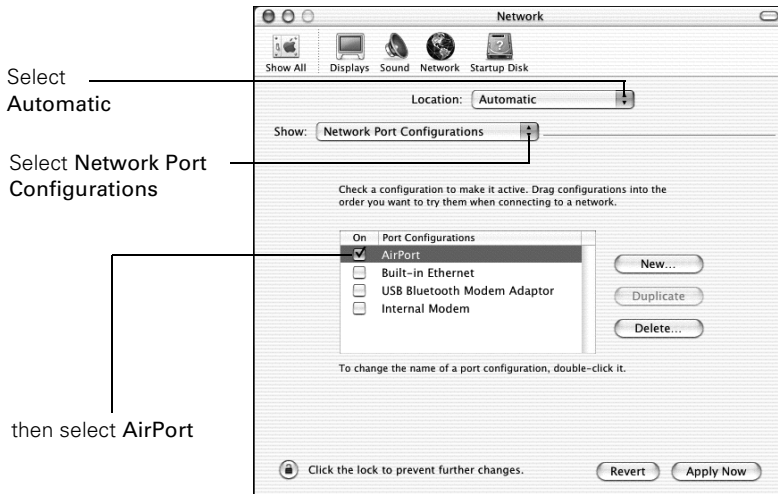

4. Select **Network Port Configurations** in the Show pull-down menu.
5. Under Port Configurations, select **AirPort**.
6. Click **Apply Now**. Then close the window.
7. Click the AirPort icon on the menu bar at the top of the Mac desktop. You see the AirPort status menu:

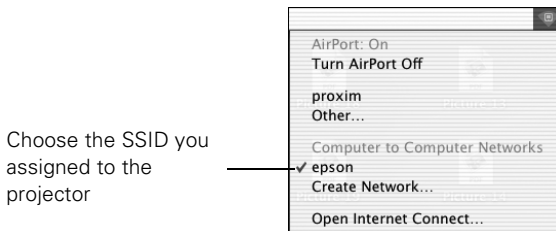

8. Check to make sure AirPort is turned on.
9. Select your projector's SSID.

note

If you don't need the other network port configurations, disable them by deselecting their checkboxes.

When you connect in Ad Hoc mode, your computer is disconnected from any other wireless networks. If you need to remain connected to your wireless network, use Access Point mode, as described on page 78. Also, make sure you reconnect to your original wireless network when you are done using the projector.

The Network settings window you see may be slightly different depending on your version of Mac OS X, but the procedures are the same.



Using Access Point Mode

To use Access Point (infrastructure) mode, first adjust your projector and wireless access point or AirPort base station settings as described in this section.

Configuring the Projector

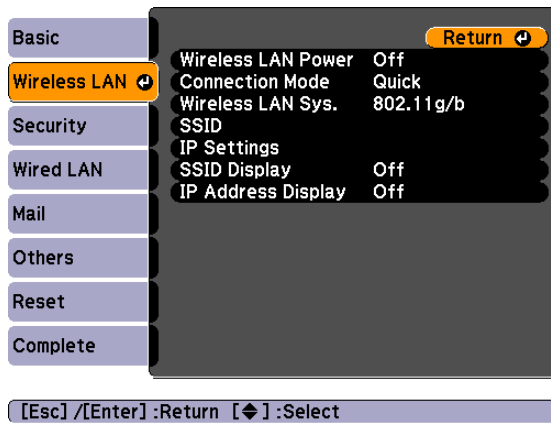
1. Press the **Menu** button, then choose **Network** and press **Enter**.
2. Choose **Network Configuration** and press **Enter**.
3. Choose **Wireless LAN** and press **Enter**. You see this screen:



4. Make sure **On** is selected for the **Wireless LAN Power** setting.
5. Make sure **Advanced** is selected for the **Connection mode**. If not, use the  buttons on the remote control to highlight **Advanced**, then press **Enter** to select it.
6. If your network is using 802.11a, use the  buttons on the remote control to highlight **802.11a**, then press **Enter** to select it.
7. To enable your computer to find the projector on the network, you need to enter the SSID name of your access point or the name of your AirPort network in the **SSID** text box. (The name of your AirPort network may be different from that of your AirPort base station; select your base station in the AirPort Admin utility and click **Configure** to check the name of your network.)

Highlight the **SSID** text box, press **Enter**, and enter a name:

Use the  buttons to select individual letters; then press **Enter** to input a character. To add a blank space or to navigate backward and forward through the input text, highlight the arrows and press **Enter**. To toggle symbol settings or capital letters, highlight the option and press **Enter**. When you're done, highlight **Finish** and press **Enter**.

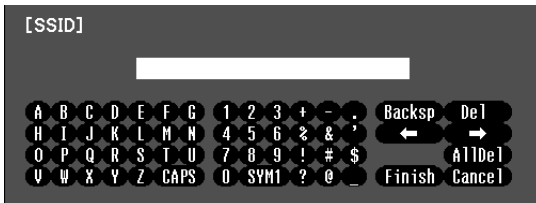

Note that the SSID is case-sensitive (if you enter the name in uppercase on the projector, you must type it the same way on the computer connecting to the projector).

8. Choose **IP Settings** and press **Enter**. If your access point assigns IP addresses automatically, turn on the **DHCP** setting. Otherwise, turn off **DHCP** and enter the following information:
 - **IP address:** Enter the IP address you want to assign to the projector. It must be formatted like other addresses on the network. The last 3 digits should be unique.
 - **Subnet mask:** For example: 255.255.255.000, but this depends on how your network is set up.
 - **Gateway address:** Enter the IP address that was assigned to the access point or AirPort base station when it was set up.
9. If you want to prevent the SSID from being displayed on the standby screen, set the **SSID Display** option to **Off**.

note

For specific details about your network, please consult your network administrator.

*If you don't know your gateway or access point address, see page 85. If you're using AirPort, start the AirPort Admin utility, select your base station and click **Configure**. Then click the **Network** tab to see your base station's IP address.*

10. To prevent the IP address from appearing on the standby screen, set the **IP Address Display** setting to **Off**.
11. When you're done making these settings, highlight the **Return** button at the top of the screen, then press **Enter**. Choose **Complete** and press **Enter**, then choose **Yes** and press **Enter** to save your settings.

Now you're ready to set up your computer for wireless projecting. Go to "Configuring the Network Settings for Windows" below, or go to "Setting Up Your Mac for Access Point Mode" on page 86. If you want to enable security options for your network, see page 88 to set up the option that your network uses on the projector.

Configuring the Network Settings for Windows

Before connecting to the projector, you need to make sure the settings for your computer's wireless card or adapter match the settings you entered for the projector.

1. Access your wireless network Properties window. For example, in Windows XP you would click **Start > Control Panel > Network and Internet Connections**. Then click the **Network Connections** icon. You see a screen similar to this:

note

On some Windows systems, you can right-click My Network Places or Network Neighborhood on the desktop and select Properties.

Settings may vary, depending on your wireless network adapter. See the documentation for your adapter for more information.

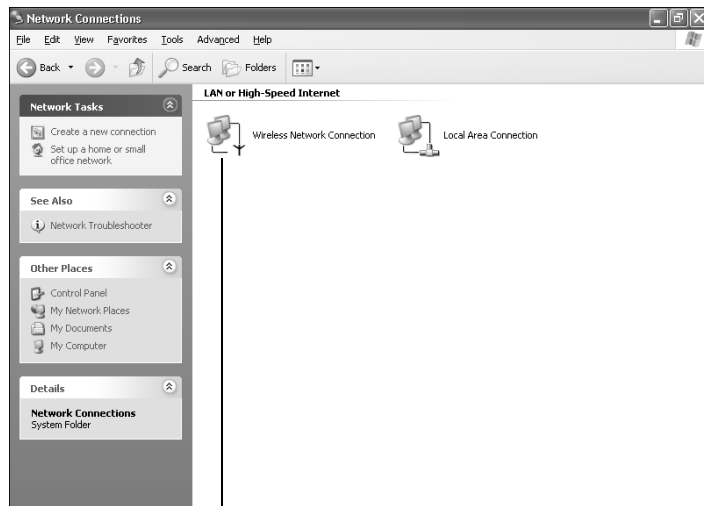

Right-click and select Properties

2. Right-click the **Wireless Network Connection** icon and select **Properties**.

You see a screen similar to this:

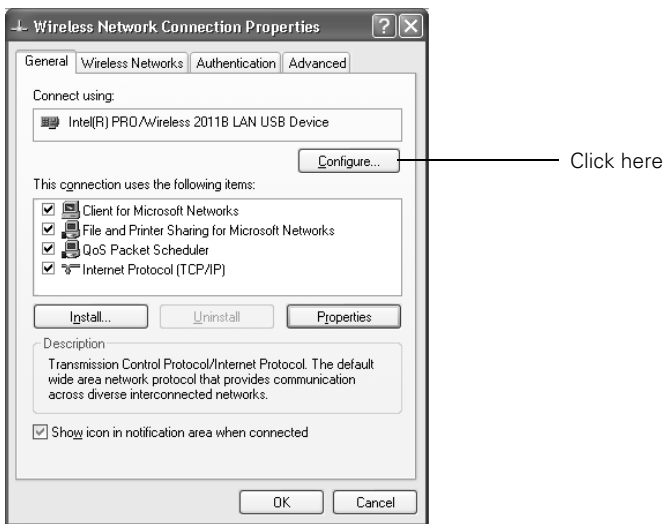

3. Click the **Configure** button.
4. Click the **Advanced** tab. You see a screen like this:

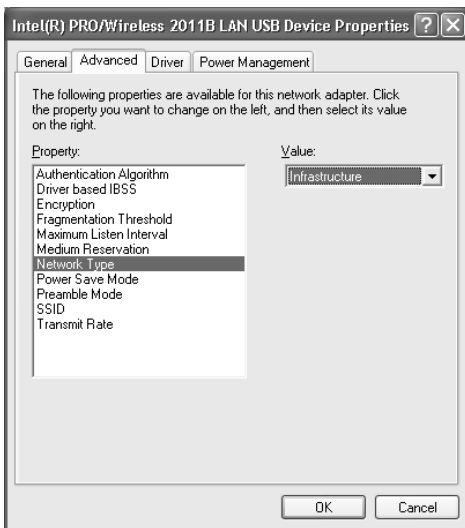

5. Check your wireless card's or adapter's device settings.
(Depending on the type of card or adapter you're using, some of the settings may be different than those listed here.)
 - Set the Network Type to **Infrastructure**.
 - Set the SSID to match the name assigned to the access point (which should also be the projector's SSID).
 - Make sure Encryption is **Disabled** if you have not set up encryption on the projector.
6. Click the **General** tab and make sure that your wireless card or adapter is enabled.
7. When you're done, click **OK** to close the wireless properties dialog box.
8. Right-click the **Wireless Network Connection** icon again and select **Properties**. You see this screen:

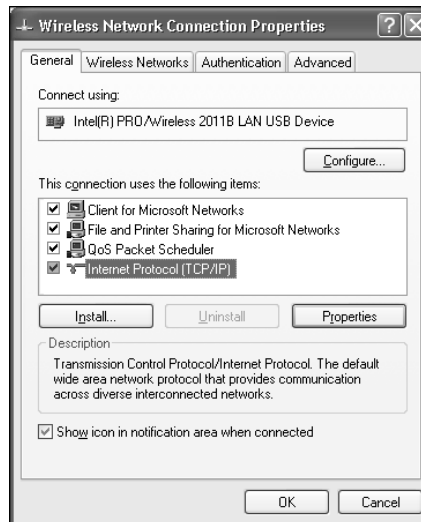

9. Select Internet Protocol and click the Properties button. You see this screen:

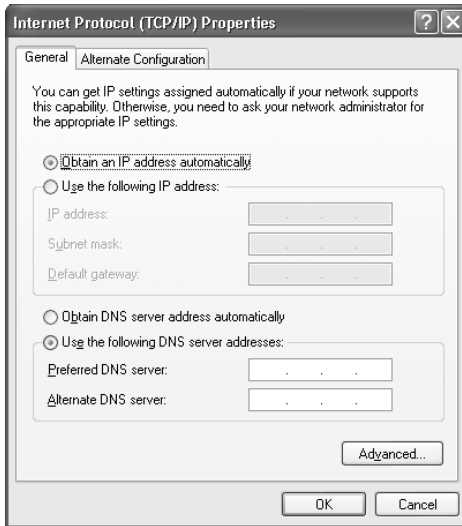

10. If your access point uses DHCP, select **Obtain an IP address automatically**. Otherwise select **Use the following IP address** and enter the required information:

- **IP address:** Type in the IP address you want to assign to the computer. It must be formatted like other addresses on the network. The last section must be unique.
- **Subnet mask:** For example: 255.255.255.000, but this depends on how your network is set up.
- **Default gateway:** Enter the IP address that was assigned to the access point when it was set up.
- **Preferred DNS server/Alternate DNS server:** Enter the IP address of the DNS server(s) for your network.

11. When you're done, click OK.

note

For specific details about your network, please consult your network administrator.

note

If you don't know your gateway or access point address, see page 85.

12. Click the **Wireless Networks** tab.

(If you don't see this tab, you may need to enable your wireless card or adapter by clicking **Configure** to access the device settings; then follow any instructions on the screen to enable the device.) You see a screen like this:

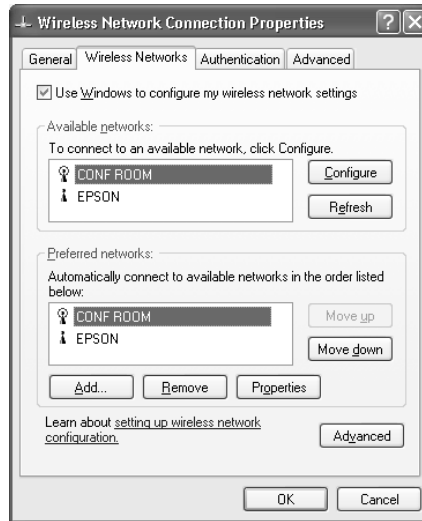

13. Verify that you've enabled your computer's connection to the access point. It should be listed with the small  icon next to it, indicating a connection.

If it's not listed, click **Configure** and type the name of your access point.

14. When you're done making settings, click **OK** to close the dialog box.

Now you're ready to connect to the projector. See the *EasyMP Network Projection Operation Guide* for details.

Checking the Gateway IP Address on Windows

If you're entering IP addresses manually and need to find out the gateway IP address (the IP address of your access point), make sure the wireless connection to the access point is currently active, as described in the previous section. Then follow these steps:

1. Access your wireless network Properties window. For example, in Windows XP you would click **Start > Control Panel > Network and Internet Connections**. Then click the **Network Connections** icon. You see a screen similar to this:

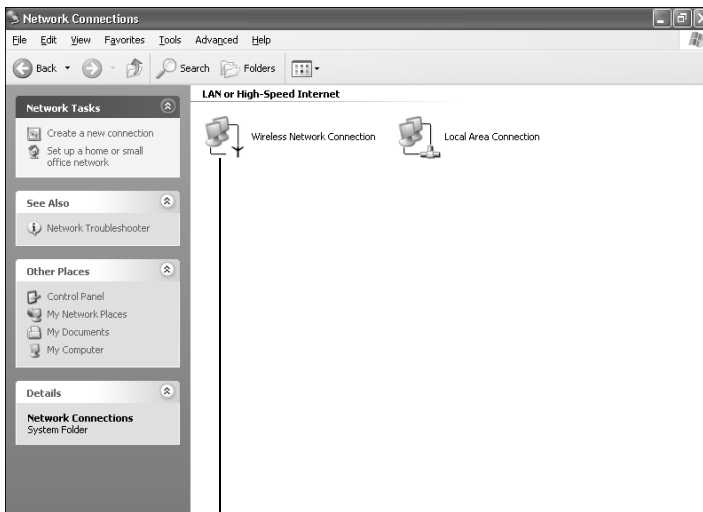

Right-click and select Status

2. Right-click the **Wireless Network Connection** icon and select **Status**.

note

If you cannot identify the gateway address using this Windows utility, use the administrator's utility software that came with your access point.

3. Click the **Support** tab. The gateway's IP address is listed as shown:

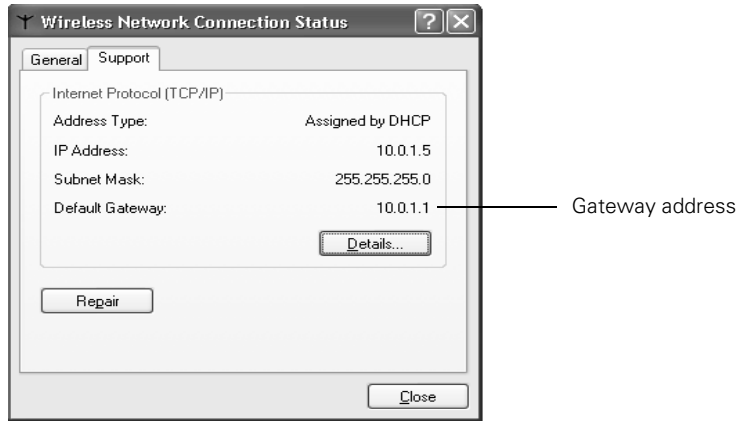

Setting Up Your Mac for Access Point Mode

Your AirPort software is automatically configured to allow your Mac to detect Access Point networks.

Typically, you only need to select your AirPort network name from the AirPort status menu on the Mac menu bar. If you're having problems connecting to the projector, follow these steps:

1. From the Apple pull-down menu, select **System Preferences**.
2. Click the **Network** icon. You see the Network settings window.

3. Make sure Location is set to **Automatic**.

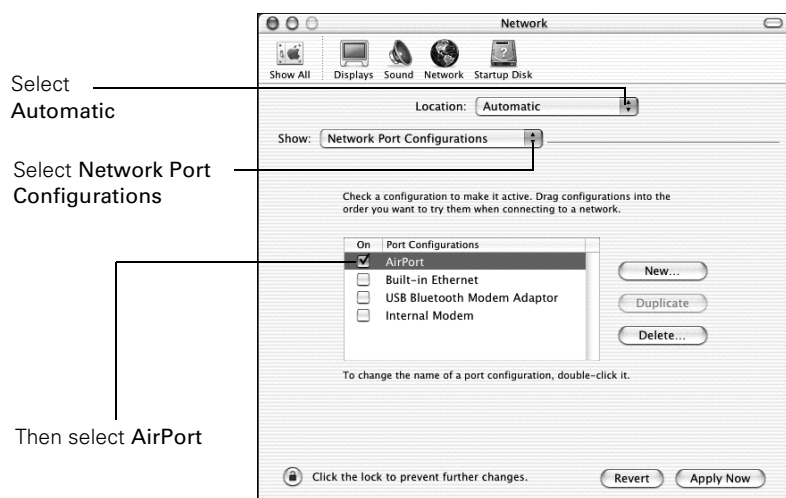

4. Select **Network Port Configurations** in the Show pull-down menu.
5. Under Port Configurations, select **AirPort**.
6. Click **Apply Now**. Then close the window.
7. Start the AirPort Admin utility. Select your base station, then click **Configure**.
8. On the AirPort tab, make sure your AirPort network name matches your projector's SSID. If not, enter the projector's SSID in the AirPort Network text box and click **Update**.
9. If you turned DHCP on in your projector's advanced menu, click the Network tab and make sure the **Distribute IP addresses** checkbox is selected. If you need to select it, click **Update**.

note

If you don't need the other network ports, disable them by deselecting their checkboxes. If more than one network port is enabled, the projector software warns you to turn off AirPort when you first connect the projector. Disregard this message.

Your AirPort network and base station names may be different. To check or change your AirPort network name, start the AirPort Admin utility, select your base station, and click **Configure**. Click **Show All Settings**, then make any changes you want on the AirPort tab.

If you're connecting to your projector in static IP mode, deselect the **Distribute IP addresses** checkbox. Make sure your projector's gateway address is identical to the base station's IP address, and the first three segments of the projector's IP address are identical to the first three segments of the base station's IP address.

The Network settings window you see may be slightly different depending on your version of Mac OS X, but the procedures are the same.

10. Click the AirPort icon on the menu bar at the top of the Macintosh desktop. You see the AirPort status menu:

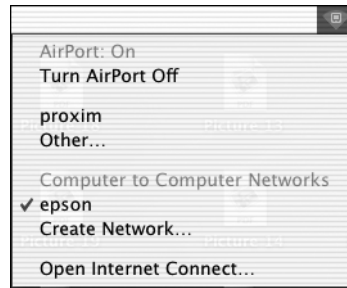

11. Check to make sure AirPort is turned on.
12. Select the name of your AirPort network.

note

The authentication and firewall features are only effective when the access point for the connection destination supports the same functions.

Using Wireless Security Options

The projector includes WEP and WPA data encryption security options which you can enable for network projection (PowerLite 85+/825+/826W+ only).

Make sure the settings you select match the ones used by your network; follow the directions from your network administrator.

See the following sections to enable security options on your projector:

- “Enabling WEP Encryption” on page 89
- “Enabling WPA Security” on page 91

You also need to enable security settings from EasyMP Network Projection (see page 92).

Enabling WEP Encryption

1. Press **Menu** on the projector remote. Highlight **Network** and then press **Enter**.
2. Choose **Network Configuration** and press **Enter**.
3. Highlight **Security**, then press **Enter**. You see the following screen:

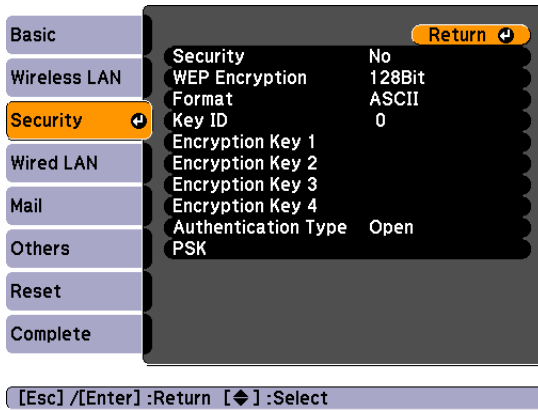

4. Press **Enter** to select **Security**, then select **WEP** and press **Enter**.
5. For the WEP encryption setting, select **128Bit** or **64Bit** and press **Enter**.
6. For **Format**, highlight **ASCII** to enable text input or **HEX** to enable hexadecimal input, then press **Enter**.

note

Text input for WEP encryption varies with different access points; check with your network administrator. Try ASCII first. If that doesn't work, try Text2 and then Text3.

7. If you chose **64Bit**, choose **Encryption key 1, 2, 3, or 4**.

Highlight the **Encryption key** text box that corresponds to the Key ID you selected, then press **Enter**. Use the  buttons to select individual letters; then press **Enter** to input a character. To add a blank space or to navigate backward and forward through the input text, highlight the arrows and press **Enter**. To toggle symbol settings or capital letters, highlight the option and press **Enter**. When you're done, highlight **Finish** and press **Enter**.

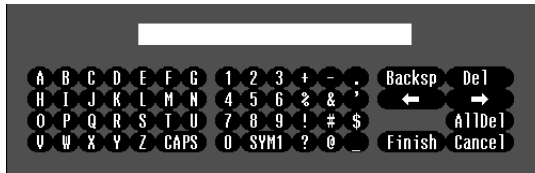

8. Check with your network administrator for directions on entering a key for your network, and follow these general guidelines:
 - For 128 bit WEP encryption with hexadecimal input, enter 26 characters, from 0 to 9 and from A to F.
 - For 64 bit WEP encryption with hexadecimal input, enter 10 characters, from 0 to 9 and from A to F.
 - For 128 bit WEP encryption with ASCII or text input, enter 13 alphanumeric characters.
 - For 64 bit WEP encryption with ASCII or text input, enter 5 alphanumeric characters.
9. For **Authentication Type**, highlight **Open** for open system authentication or **Shared** for shared key authentication.
10. When you're done making these settings, highlight the **Return** button at the top of the screen, then press **Enter**. Choose **Complete** and press **Enter**, then choose **Yes** and press **Enter** to save your settings.

Enabling WPA Security

1. Press Menu. Highlight Network and then press Enter.
2. Choose Network Configuration and press Enter.
3. Highlight Security, then press Enter. You see the following screen:

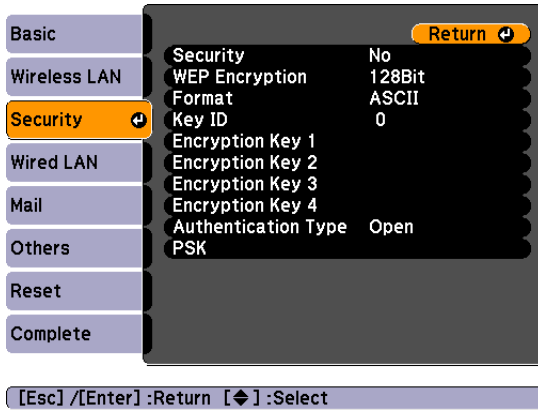

4. Press Enter to show the menu, then choose one of the following and press Enter.
 - WPA-PSK (TKIP)
 - WPA-PSK (AES)
 - WPA2-PSK (TKIP)
 - WPA2-PSK (AES)
5. Press Esc to return to the previous screen.

note

If the password is longer than 32 characters, enter it by accessing the projector from a web browser. This lets you enter up to 63 characters. See page 97 for details.

6. Highlight the **PSK** (pre-shared key) text box and press **Enter**. Use the  buttons to select individual letters; then press **Enter** to input a character. To add a blank space or to navigate backward and forward through the input text, highlight the arrows and press **Enter**. To toggle symbol settings or capital letters, highlight the option and press **Enter**. When you're done, highlight **Finish** and press **Enter**.

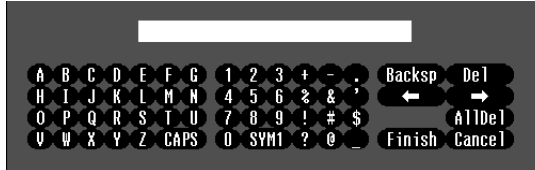

7. When you're done making these settings, highlight the **Return** button at the top of the screen, then press **Enter**. Choose **Complete** and press **Enter**, then choose **Yes** and press **Enter** to save your settings.

Enabling Data Encryption from EasyMP Network Projection

When using the EasyMP Network Projection software, follow these steps to enable data encryption.

1. Click **Set options** on the main screen.
2. Click the **General settings** tab.
3. Select the **Encrypt communications** checkbox.
4. Click **OK**.

For more information, see the *EasyMP Network Projection Operation Guide*.

Using the EasyMP Network Projection Software

Once you've set up your projector and computer for network projection, see the *EasyMP Network Projection Operation Guide* for instructions on the following EasyMP features (PowerLite 85+/825+/826W+ only):

- Starting EasyMP Network Projection
- Projecting over the network (content over IP)
- Multi-screen projection
- Using Presentation mode
- Connecting to a projector on a different subnet

Removing the Wireless 802.11a/b/g Module

Follow these steps to remove the module from your projector (PowerLite 85+/825+/826W+ only).

1. If you're running EasyMP Network Projection, click **Disconnect** on the control bar.



2. Check the access light to make sure it isn't flashing.

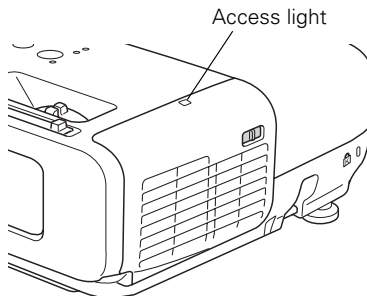

caution

Never remove the module while its indicator light is green or when projecting wirelessly. You may damage the module.

3. Turn off the projector and unplug it.
4. Open the air filter cover by sliding the switch and pulling down the cover.

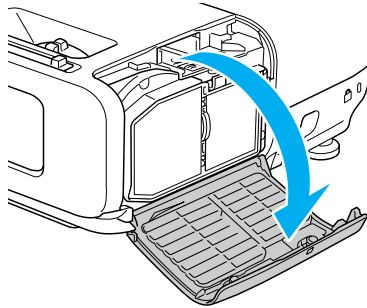
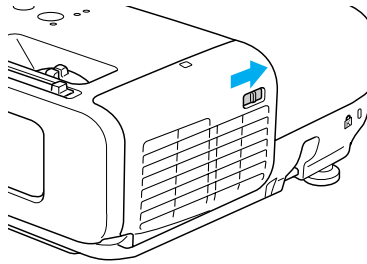

5. Unscrew the module, then pull it out.
6. Close the air filter cover.

Using Projector E-mail Alerts

When this feature is enabled, the projector sends you an e-mail alert if it has any problems.

1. Press the **Menu** button on the remote control, select the **Network** menu, then press **Enter**.
2. Choose **Network Configuration** and press **Enter**.

3. Choose **Mail**, then press **Enter**. You see a screen like the following:

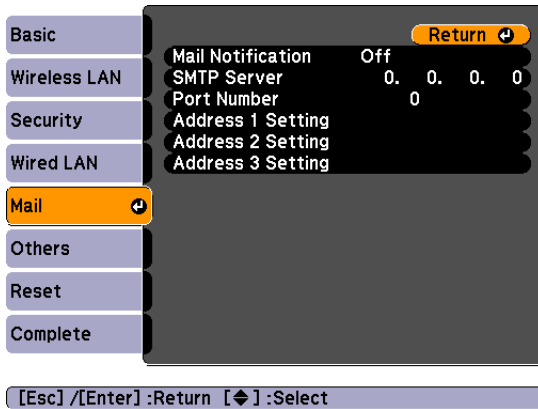

4. For the Mail Notification setting, select **On** to receive email notifications, then press **Enter**.
5. Enter the IP address for the SMTP server for the projector.

You can enter a number from 0 to 255 in each field of the address. However, the following IP addresses cannot be used: 127.x.x.x, 224.0.0.0 to 255.255.255.255 (where x is a number from 0 to 255).

6. Enter the SMTP server's port number. The default value is 25. You can enter a numeric value from 1 to 65535.
7. Choose one of the **Address** fields, then enter the e-mail address and the contents of the message that you will receive when a problem or warning occurs. You can register up to three addresses. You can enter up to 32 alphanumeric characters for the e-mail address.

note

If a critical problem develops with a projector which causes it to suddenly stop working, it may not be possible for the projector to send a message.

If Standby Mode is set to Communication On in the Extended menu, the projector can still be monitored even if the projector is in standby mode (when the power is off).

When the selected problem or warning occurs, an e-mail message is sent to the specified notification addresses. The subject line of the e-mail is **EPSON Projector**.

The e-mail includes the following information:

- Line 1: The name of the projector where the problem has occurred
- Line 2: The IP address of the projector where the problem has occurred
- Line 3: Details of the problem

Using SNMP to Monitor the Projector

note

If you're a network administrator, you can use the SNMP option to enter a trap IP address. This lets you receive trap alerts for the projectors you're monitoring.

Network administrators can use SNMP (Simple Network Management Protocol) to monitor projectors.

1. Press the **Menu** button on the remote control, select the **Network** menu, then press **Enter**.
2. Choose **Network Configuration** and press **Enter**.
3. Choose **Others**, then press **Enter**. You see a screen like the following:

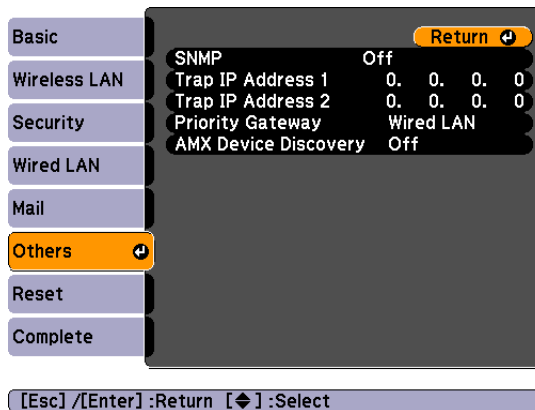

4. Turn on the SNMP setting.

5. Enter up to two IP addresses for notification.

You can enter a number from 0 to 255 in each field of the address. However, the following IP addresses cannot be used: 127.x.x.x, 224.0.0.0 to 255.255.255.255 (where x is a number from 0 to 255).

6. For **Priority Gateway**, select **Wired** or **Wireless** (PowerLite 85+/825+/826W+ only).
7. If your network environment uses an AMX controller, select **On** to allow the projector to be detected by AMX Device Discovery.

Using a Browser to Control the Projector

You can use a standard web browser to monitor and control the projector through the network.

1. Make sure that the projector is set up for your network, as described on page 64. (Standby Mode in the Extended menu should be set to **Communication On** to monitor the projector in standby mode.) When using a browser to access the projector, you cannot connect through a proxy server.
2. Open your web browser and enter the IP address of the projector you want to monitor in the browser window.

If you're not sure what the address of the projector is, turn the projector on and select **Net. Info.-Wired LAN** or **Net. Info.-Wireless LAN** (PowerLite 85+/825+/826W+ only) from the Network menu to display the IP address of the projector. Do not enter leading zeroes.

3. Press **Enter**, or, if you set a Web control password in the projector's Network menu, enter your user name and password, then press **Enter**.
4. Select one of the menu options listed on the screen, then change any of the settings as needed. These settings correspond to those found in the projector's menu system.

You cannot change the following settings using a web browser:

- **Pointer Shape, Test Pattern, or User Button** in the Settings menu
- **User's Logo, High Altitude Mode, Lens Cover Timer and Language** in the Extended menu
- **Reset All and Reset Lamp Hours** in the Reset menu

You can only change the following settings using a web browser:

- **SNMP Community Name**
- **EasyMP Monitor password**

Using Web Remote Control

When you access the projector through your browser, you can display a “virtual remote control” on your computer screen. This lets you change sources and perform many of the same functions as you can with the physical remote control.

From the Projector Control menu, select **Web Remote**. You see the following screen:

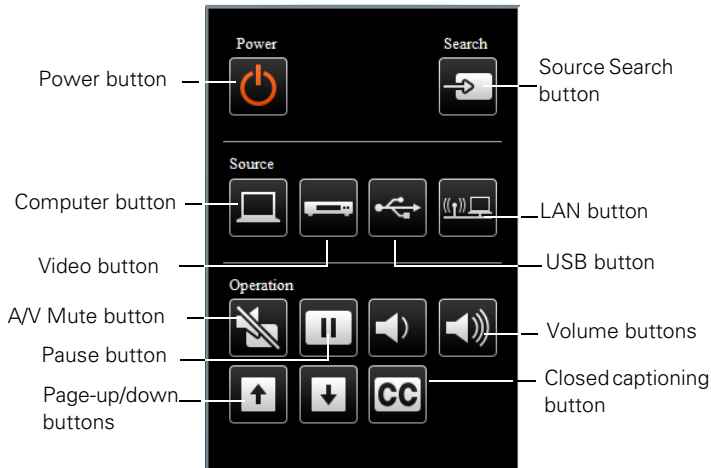

- The **Power** button turns the projector on and off.
- The **Search** button searches for signal sources (see page 25).
- The **Computer** button selects a computer signal (connected to the **Computer1** or **Computer2** port).
- The **Video** button selects a video signal (connected to the **Video** or **S-Video** port).
- The **LAN** button selects a network signal or wireless signal (using the optional wireless unit). The **LAN** button does not work with the PowerLite 84+/824+.
- The **USB** button selects USB computer display (see page 50) or a signal from equipment connected to the USB (**TypeA**) port (PowerLite 85+/824+/825+/826W+ only), such as a document camera (see page 58).

- The Pause button stops the image (see page 34).
- A/V Mute button temporarily turns off the picture and sound (see page 34).
- The Page Up/Down buttons control PowerPoint slides (requires USB cable) See page 41.
- The Volume buttons raise or lower the volume.
- The CC (Closed Captioning) button lets you display closed captioning for content that provides it.

5 *Fine-Tuning the Projector*

You can use the projector's on-screen menus to adjust the image, sound, and other features. This chapter covers the following information:

- Using the menu system
- Adjusting the image
- Adjusting signal settings
- Customizing projector features
- Using the projector security features
- Customizing power and operation

Using the Menu System

You can use the remote control or the projector's control panel to access the menus and change settings. Follow these steps:

1. To display the menu screen, press the **Menu** button on the remote control or on the projector.

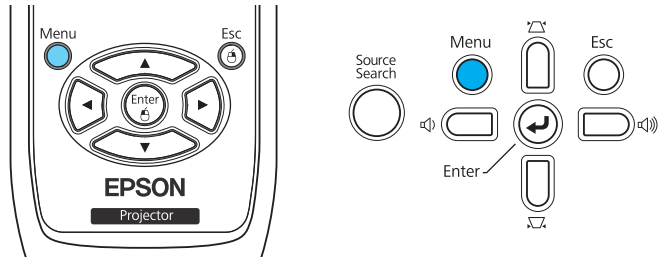

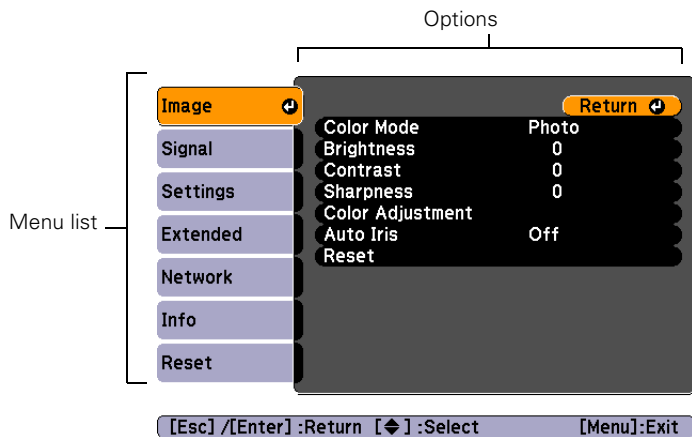

You see a menu screen similar to the one below:



The menus are listed on the left and the options available for the highlighted menu are shown on the right.

2. Use the  pointer buttons on the remote control (or the navigational buttons on the projector) to scroll through the menu list. When you've highlighted the desired menu, press the **Enter** button to select it.

- Once you've selected the menu, use the  pointer buttons to scroll through the list of options. (Some of the options may be grayed out or unavailable, depending on the selected source.)
- After highlighting the option you want to adjust, use the  pointer buttons to change the setting. In some cases, you may have to press the **Enter** button to view a sub-screen for changing the setting.
 - Press the left or right arrow button to adjust a slider bar, then press **Enter**.
 - To select from two or more settings, use the  pointer buttons to highlight the desired setting, and then press **Enter**.
- After changing the settings, press the **Esc** button to save your changes and return to the previous menu (or press it repeatedly to exit the menu system).

You can also press the **Menu** button to exit.



Restoring the Default Settings

You can use the menu system's **Reset** options to restore the factory-default settings for all the settings listed in a specific menu, or all the settings in all menus.

To restore the settings in a specific menu, enter the menu whose settings you want to change, select **Reset**, and confirm as needed. (The example below shows how to reset the **Image** menu.)

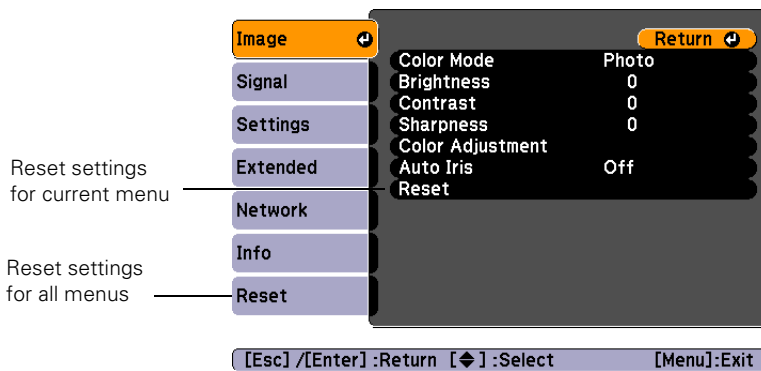

note

When you select *Reset All* in the *Reset* menu, it does not reset the *Input Signal*, *User's Logo*, *Lamp Hours*, *Language*, or *User Button* settings. Additionally, no items in the *Network* menu are reset.

To restore all the projector settings to their factory-default values, select the **Reset** menu, highlight **Reset All**, and press **Enter**.

Adjusting the Image

You can use the **Image** menu to adjust the brightness, sharpness, color, tint, and contrast.

1. Press the **Menu** button on the projector or remote control, select the **Image** menu, and press **Enter**. You see an **Image** menu screen similar to the one below:

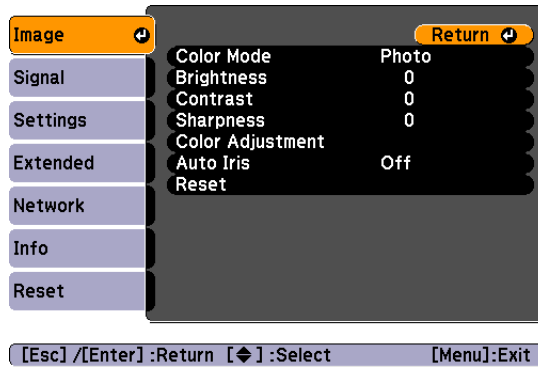

2. Use the  pointer buttons to highlight the desired option, then adjust it as needed:

- **Color Mode**

Lets you quickly adjust the color and brightness for various uses. You can save a different setting for each source. See page 38 for details on each setting.

You can also change the color mode by pressing the **Color Mode** button on the remote control.

- **Brightness**

Lightens or darkens the overall image.

- **Contrast**

Adjusts the difference between light and dark areas.

note

The *Brightness* setting changes the opacity of the projector's LCD panels. You can also use the *Power Consumption* setting to change the lamp's brightness (see page 108).

- **Color Saturation (component video, composite video, and S-Video signals only)**
Adjusts the color depth of the image.
- **Tint (component video, composite video, and S-Video signals only)**
Adjusts the balance of green to magenta in the image (available only for component video or NTSC signals).
- **Sharpness**
Adjusts the sharpness of the image.
- **Color Adjustment**
Adjusts the color values. Select **Abs. Color Temp.** to adjust the overall value from 5000 and 10000 °K. Or, select **Red, Green, Blue** to adjust the saturation values for each color. (Not available if **sRGB** is selected as the Color Mode setting.)
- **Auto Iris**
Automatically adjusts the brightness according to the nature of the image. Improves the depth and detail of dark scenes. (Only available when **Dynamic** or **Theatre** is selected as the Color Mode setting.)

Adjusting Signal Settings

note

You can also use the remote control's **Auto** button to automatically reset the projector's tracking, sync, resolution, and position settings. See page 30 for details.

Although the projector normally detects and optimizes the input signal automatically, you can use the Signal menu to make manual adjustments. In addition to changing the position of the projected image, you can correct tracking and sync for computer images, or change the aspect ratio to widescreen format for video images.

1. Press the **Menu** button, select the **Signal** menu, and press **Enter**.

You see a screen similar to one of those below. (The settings will be different depending on the source you are projecting from.)

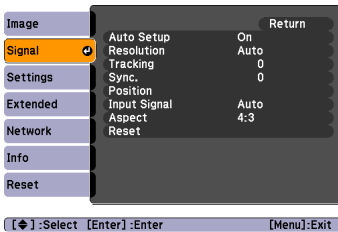

Computer image

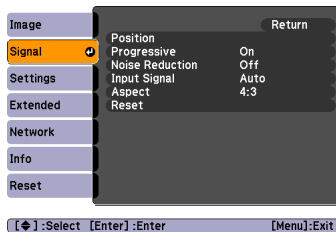

Component video

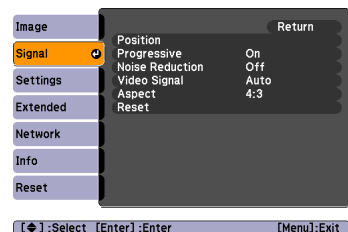

Composite video/S-Video

2. Use the  pointer buttons to highlight the desired option, then adjust it as needed:

- **Auto Setup**

Leave this setting on to automatically optimize the image when **Computer** is selected as the source. Turn it off if you want to save adjustments you have made to the video settings.

- **Resolution**

When set to **Auto**, the resolution (size) of a computer image is automatically detected so it can be scaled to fit in the projection area. If the image doesn't display properly after you adjust the aspect ratio setting (see page 36), select **Wide** to project from a computer with a wide-panel display, or **Normal** for a computer with a 4:3 or 5:4 display.

- **Tracking**

Adjust this value to eliminate vertical stripes in the image.

- **Sync**

Adjust this value if the image appears blurry or flickers.

tip

Before adjusting tracking or sync, fill the screen with an image containing fine detail, such as black text on a white background.

- **Position**

If the image is slightly cut off on one or more sides, it may not be centered exactly. Select this setting and use the  pointer buttons to center it.

- **Progressive**

Turn this setting on for moving images, or select **Off** for still images. If you notice video delays during high-speed gaming, turn this setting off.

- **Noise Reduction**

Smooths out rough images. You may need to experiment to select the best setting for your image. Select **Off** when viewing low-noise image sources, such as DVDs.

- **Input Signal**

If the colors don't look right on the **Auto** setting, select the setting for the type of equipment you've connected to the **Computer1** or **Computer2** port:

RGB: For a computer connection.

Component: For a video player that outputs a component video signal.

- **Video Signal**

Leave this setting at **Auto** unless you are using a 60-Hz PAL system (then select **PAL60**).

- **Aspect**

Choose an aspect ratio setting that allows the image to fit best in the display area. See page 36 for details.

Customizing Projector Features

You can use the Settings menu to lock the buttons on the projector, adjust audio volume, and customize several other features.

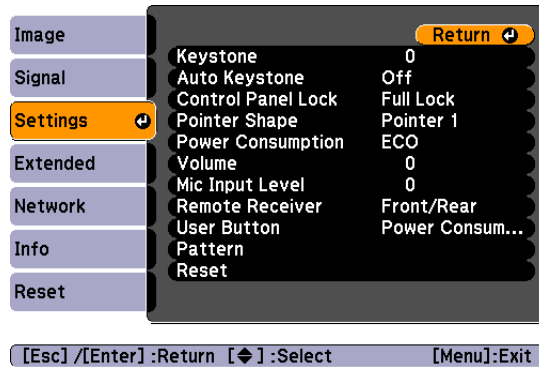

- **Keystone**
Squares up the shape of the image after the projector has been tilted upward. If you notice lines or edges looking jagged after adjusting the shape, decrease the Sharpness setting (see page 104).
- **Auto Keystone**
Automatically compensates for keystone distortion when the projector is tilted upward. This feature is available only when the projector is set for front projection (it is enabled by default).
- **Control Panel Lock**
Lets you disable the buttons on the projector. See page 115 for more information.
- **Pointer Shape**
Lets you choose from three alternative pointer shapes. See page 42 for more information.
- **Power Consumption**
Lets you select from two levels of brightness. The ECO setting reduces power consumption and noise, and extends the lamp's operating life.
- **Volume**
Raises or lowers the volume of the projector's speaker for each type of signal.

note

You can also adjust the volume using the remote control.

- **Mic Input Level**

Adjusts the microphone volume.

- **Remote Receiver**

Deactivates the projector's front and/or back sensors that detect signals from the remote control. Use this setting to prevent use of the remote control or to stop interference from bright fluorescent lights. Restart the projector for this setting to take effect.

- **User Button**

Lets you create a shortcut to one of the following menu items: **Power Consumption**, **Info**, **Progressive**, **Closed Caption**, **Test Pattern**, **Resolution**, **Mic Input Level**, or **Pattern Display**. When you press the **User** button on the remote control, the assigned menu item is displayed.

- **Pattern**

Lets you select one of the following:

Pattern Display to display one of the available patterns.

Pattern Type to select from the following 4 patterns, or select a user-defined pattern:



Pattern 1



Pattern 2



Pattern 3



Pattern 4

User Pattern to capture a customized pattern. See page 40 for more information.

Test Pattern to display a pattern that you can use for adjusting the projector without connecting it. You can adjust the zoom, focus, and keystone correction. To cancel the test pattern, press the **Esc** button on the remote control.

Using the Projector Security Features

To prevent unauthorized use of the projector, you can do the following:

- Assign a password; this can be disabled for a set period if you want to loan the projector to someone.
- Create an identifying user logo that is displayed at startup and/or when the **A/V Mute** button is pressed. Unauthorized users cannot turn it off or change it. This feature is intended to discourage theft and provides a way to identify the projector should it be stolen. See page 114.
- Disable the projector's buttons; this is useful, for example, if you're projecting in a classroom and you want to ensure that no one touches the projector's buttons while you're using the remote control. See page 115.
- Lock the network configuration settings. See page 112.

Enabling Password Protection

To prevent unauthorized use, you can assign the projector a password. If you do, a screen will appear requesting the password whenever the projector is plugged in and turned on. If an incorrect password is entered three times in succession, the projector's operation is locked and the power cord must be disconnected and reinserted to redisplay the password screen. If an incorrect password is entered thirty times in succession, the user must contact Epson to have the projector serviced.

The default setting for the Password Protect function is **Off**. Follow these steps to turn password protection on:

1. Press the **Freeze** button on the remote control for about five seconds. You see this screen:

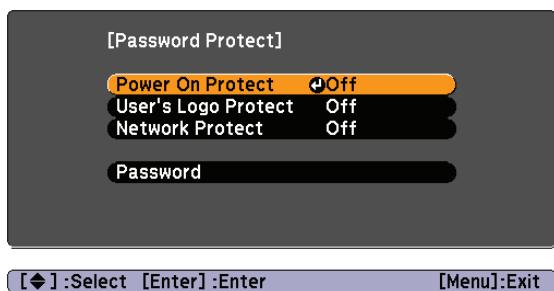

2. Use the  pointer buttons to select **Power On Protect**, then press **Enter**. Select **On** and press **Enter**.
3. Press **Esc**.
4. Select **Password** and press **Enter**.
5. When you see a message asking if you want to change the password, select **Yes** and press **Enter**.
6. Hold down the **Num** button on the remote control and use the numeric keypad to enter a four digit password. (The default setting is 0000.)
7. When you see a confirmation message, reenter the password. Then press the **Menu** button to exit the screen.

note

It's a good idea to write down your password.

If you leave the projector plugged in, the Password Protect Release screen will not appear. You only need a password if you unplug and reconnect the power cable.

caution

If you lose the remote control, you will not be able to enter the password. Keep the remote control in a safe place at all times.

8. To enable your screen logo, select **User's Logo Protect** and press **Enter**. Select **On** and press **Enter**.

When this feature is on, the logo appears whenever you turn on the projector (if the **Startup Screen** is enabled in the Extended menu; see page 114). It also appears when you press the **A/V Mute** button (if you selected the **Logo** for the **A/V Mute** setting under **Display** in the Extended menu). None of the User's Logo features in the Extended menu can be changed when the User's Logo Protect function is enabled.

9. To enable network setting protection, select **Network Protect** and press **Enter**. Select **On** and press **Enter**.

When this feature is on, none of the network settings on the menu can be changed.

Starting the Projector with a Password

When the password function is enabled, you see this screen when you plug in and turn on the projector:

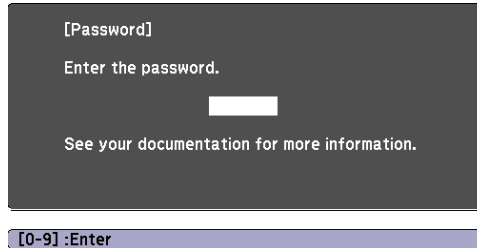

Hold down the **Num** button on the remote control and use the numeric keypad to enter the four digit password.

The password screen closes, the numeric keypad is automatically deactivated, and projection begins.

If the password is not correct, you see a message prompting you to re-enter the password. If you enter an incorrect password three times in succession, you see the message **The projector's operation will be locked. Request code xxxxx.** Write down the request code. The message displays for approximately 5 minutes, and then the projector switches to standby mode. Once the projector is in standby mode, disconnect the projector's power cord from the electrical outlet, reconnect it, and turn the projector back on.

When you see the Password Protect Release screen again, you can try to enter the correct password.

If you enter an incorrect password 30 times in succession, the projector remains locked and you must contact Epson to have the projector serviced.

If you have forgotten the password, contact Epson with the request code number that appears in the Password Protect Release screen for assistance. See "Where to Get Help" on page 149.

note

Once you capture an image, it automatically replaces the Epson startup screen.

Although you can change the startup screen, you cannot restore the original one.

Creating Your Own Startup Screen

You can transfer any image from your computer or video source to the projector and then use it as your startup screen. You can also use it as the screen displayed when the projector is not receiving a signal or when you press the A/V Mute button. The image can be a company logo, slogan, photograph, or any other image you want to use.

Capturing the Image

Start by displaying the image you want to use from either a computer or video source, such as a DVD player. With the PowerLite 85+/824+/825+/826W+, you can also use an image from a USB device. Then follow these steps to capture the image and transfer it to the projector:

1. Press the Menu button on the remote control, highlight the Extended menu, and press Enter.

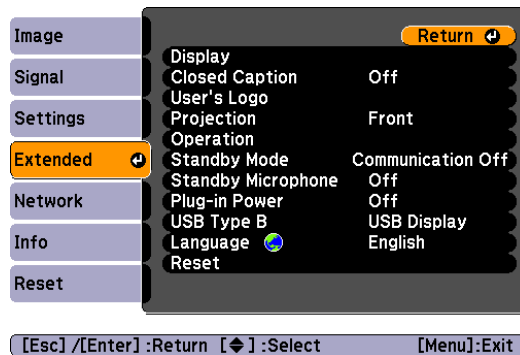

2. Highlight User's Logo and press Enter.
3. When you see a message asking Choose this image as the User's Logo?, select Yes and press Enter. A selection box displays over the image.
4. Use the  pointer buttons to select the area of the image you want to use. Then press Enter.
5. When you see the message Select this Image?, highlight Yes and press Enter.

6. Use the arrow buttons to select a zoom factor (display size) and press **Enter**.
7. When the message **Save this image as the User's Logo?** appears, select **Yes** and press **Enter**. Saving the logo may take a few moments. Do not use your projector, remote control, or video source while the logo is being saved.
8. When you see the message **Completed**, press **Menu** to exit.

Choosing When to Display the Image

After your image is saved, it is automatically set as the startup screen. You can also set it to display as the screen you see when there's no signal or when you press the **A/V Mute** button (see page 34).

1. Press the **Menu** button, highlight the **Extended** menu, and press **Enter**.
2. Select **Display** and press **Enter**.
3. Highlight **Display Background** (for when there is no signal) or **A/V Mute**, then press **Enter**.
4. Select **Logo** and press **Enter**.
5. When you're finished, press **Menu** to exit.

Disabling the Projector's Buttons

You can lock all the projector's control panel buttons, or all buttons except the **⏻** power button. The projector can still be operated using the remote control.

1. Press the **Menu** button, highlight the **Settings** menu, and press **Enter**.
2. Select **Control Panel Lock** and press the **Enter** button.
3. Select **Full Lock** (to lock all projector buttons) or **Partial Lock** (to lock all buttons except the **⏻** power button) and press **Enter**.
4. Select **Yes** and press **Enter** to confirm the setting.

note

You can also use this menu to turn off the startup screen, disable message display, or change the background color.

note

*To unlock the projector, press the **Enter** button on the projector's control panel for 7 seconds.*

Customizing Power and Operation

You can use the Extended menu to customize the way the projector displays images, enable quick startup, turn sleep mode on or off, and customize other projector operations.

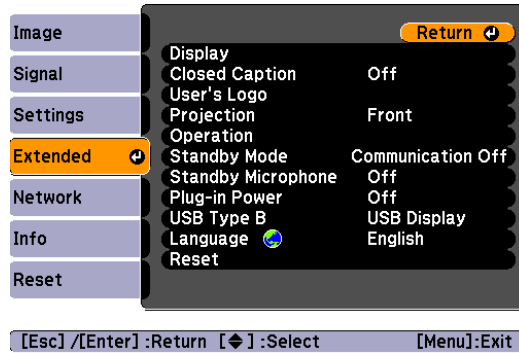

- **Display**
Use this setting to turn off the display of messages, change the background color, enable logo display, or turn off the startup screen display.
- **Closed Caption**
Lets you display closed captioning for content that provides it.
- **User's Logo**
Create a custom startup screen, as described on page 114.
- **Projection**
Select **Front** (to project from the front of a screen and right side up), **Front/Ceiling** (when the projector is mounted upside-down from the ceiling), **Rear** (to project from behind onto a transparent screen), or **Rear/Ceiling** (to project from behind onto a transparent screen when the projector is mounted upside-down from the ceiling).

note

If you hold down the A/V Mute button on the remote for about 5 seconds, you switch between Front and Front/Ceiling or Rear and Rear/Ceiling.

■ Operation

Use this menu to enable the following functions:

Direct Power On to have the projector start when the power cable is connected (without pressing the  power button).

Sleep Mode to have the projector turn off automatically if it is idle (and no signal is received) for the amount of time you select as the **Sleep Mode Timer** (1 to 30 minutes).

Lens Cover Timer to have the projector turn off automatically after 30 minutes when the A/V Mute slide is closed.

High Altitude Mode to increase cooling at high altitudes. Enable this setting when you are using the projector above 4900 ft (1500 m).

■ Standby Mode

Select **Communication On** to enable the following features, even when the projector is in standby mode (the power light is orange):

- monitoring of the projector over a network (PowerLite 84+/85+/825+/826W+ only)
- audio output from a connected microphone (you must also set the Standby Microphone setting as described below)
- video output to a connected external monitor (see page 53 for more information) (PowerLite 84+/85+/825+/826W+ only)

■ Standby Microphone

When the Standby Mode is set to **Communication On**, you can set Standby Microphone to **On**. This allows you to use a microphone connected to the projector even in standby mode, when Power On Protect is off.

■ Plug-in Power

Select **On** when you are connecting a condenser microphone.

note

If Direct Power On is enabled, the power cable is connected, and a power outage occurs, the projector will start when the power is restored.

Do not use the projector at altitudes above 7500 ft (2,286 m).

- **USB Type B**
Select **USB Display** to project your computer's display through the projector's USB Type B port (see page 50). Choose **Wireless Mouse** to use the remote control as a wireless mouse when your computer is connected to the **Computer1** or **Computer2** port; see page 51.
- **Language**
Select the language to be used for the projector menus.

6

Maintaining the Projector

Your projector needs little maintenance. All you have to do is keep the lens clean. You may also need to clean the air filter and vent. A clogged air filter or vent can block ventilation needed to cool the projector.

warning

Before you clean any part of the projector, turn it off and unplug the power cord.

Never open any cover on the projector, except the lamp cover. Dangerous electrical voltages in the projector can injure you severely. Do not try to service this product yourself, except as specifically explained in this User's Guide. Refer all other servicing to qualified service personnel.

The only parts you should replace are the lamp and air filter. If any other part needs replacing, contact your dealer or a qualified servicer.

This chapter covers the following:

- Cleaning the lens
- Cleaning the projector case
- Cleaning the air filter and vent
- Replacing the lamp and air filter
- Transporting the projector

Cleaning the Lens

Clean the lens whenever you notice dirt or dust on the surface.

To remove dirt or smears on the lens, use lens-cleaning tissue. If necessary, moisten a soft cloth with lens cleaner and gently wipe the lens.

Cleaning the Projector Case

Before you clean the case, turn off the projector and unplug the power cord.

- To remove dirt or dust, wipe the case with a soft, dry, lint-free cloth.
- To remove stubborn dirt or stains, moisten a soft cloth with water and a neutral detergent. Then wipe the case.

caution

Do not use wax, alcohol, benzene, paint thinner, or other chemical detergents. These can damage the case.

Never spray a liquid of any kind directly on the projector or its lens. Always apply it to a cloth first.

Using a spray that contains a flammable gas to clean the lens can result in a fire due to the high temperature of the projector lamp.

Cleaning the Air Filter and Vent

Your projector includes an air filter to ensure the best performance. If dust collects on the air filter or vent, clean them as described below. Dust clogs prevent proper ventilation and can cause overheating and damage the projector.

If you see the following message, clean the air filter immediately.

The projector is overheating. Make sure nothing is blocking the air vent, and clean or replace the air filter.

1. Turn off the projector. When the  power light stops flashing and you hear two beeps, unplug the power cord.
2. To clean the intake vent and filter, use a small vacuum cleaner designed for computers and other office equipment. If you don't have one, gently clean the vent with a soft brush (such as an artist's paintbrush).

You can remove the air filter to clean both sides. For instructions, see page 126.

The exhaust vent is on the other side of the projector

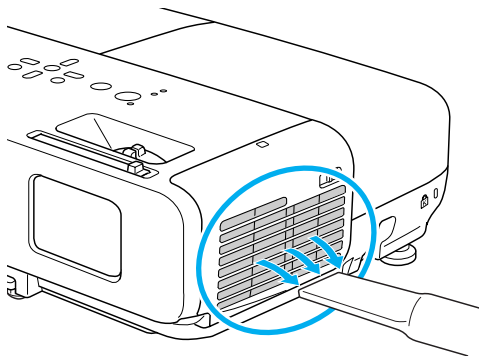

3. If the dirt is difficult to remove or the filter is damaged, or if the message appears again after cleaning, replace the filter as described on page 126. To purchase a new filter, contact your dealer, call Epson at 800-GO-EPSON (800-463-7766), or purchase online at www.epsonstore.com (U.S. sales) or www.epson.ca (Canadian sales).

note

To order replacement air filters, request part number V13H134A22. See page 13 for ordering information.

note

When you replace the lamp for your projector, you should also replace the filter.

To check how long the lamp has been in use, see page 135.

Turn off this product when not in use to prolong the life of the projector.

warning

Let the lamp cool fully before replacing it.



In the unlikely event that the lamp has broken, small glass fragments may be present and should be removed carefully to avoid injury.

If the lamp is used after the replacement period has passed, the possibility that the lamp may break increases. When a lamp replacement message appears, replace the lamp with a new one as soon as possible, even if it is still working.

Replacing the Lamp and Air Filter

The life span of the projection lamp is about 5000 hours if **Power Consumption** in the Setting menu is set to **Normal** (default), and 6000 hours if **Power Consumption** is set to **ECO**.

It is time to replace the lamp when:

- The projected image gets darker or starts to deteriorate.
- The message **Replace the lamp** appears on the screen when the lamp comes on and the lamp warning light  flashes orange. To maintain projector brightness and image quality, replace the lamp as soon as possible.
- The lamp warning light  flashes red (the lamp is burnt out).

Contact your dealer, call Epson at 800-GO-EPSON (800-463-7766), or purchase online at www.epsonstore.com (U.S. sales) or www.epson.ca (Canadian sales). Request part number V13H010L50 for the genuine Epson projector lamp.

Replacing the Lamp

1. Turn off the projector.
2. When the  power light stops flashing and you hear two beeps, unplug the power cord.
3. Let the projector cool for at least an hour (if it has been on). The lamp is extremely hot immediately after use.

4. Loosen the lamp cover screw (you can't remove it). Then slide the lamp cover and lift it off of the projector.

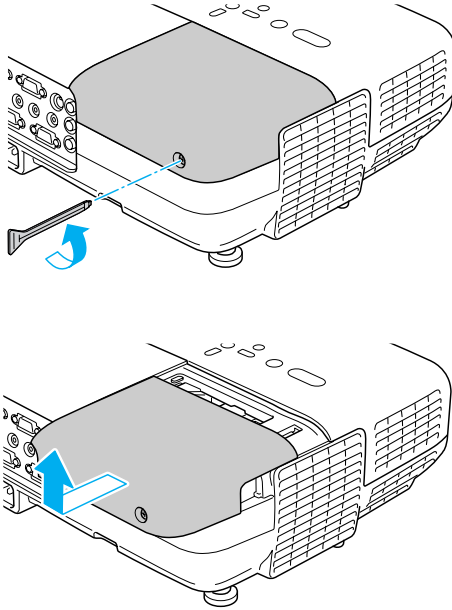

5. Loosen the two screws holding the lamp in place (you can't remove them).

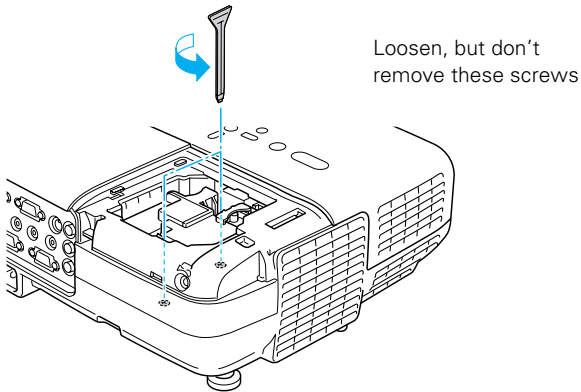

note

 *The lamp(s) in this product contain mercury. Please consult your state and local regulations regarding disposal or recycling. Do not put in the trash.*

6. Hold the lamp as shown and pull it straight out.

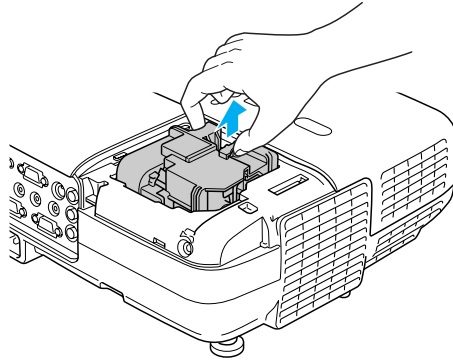

7. Gently insert the new lamp. (If it doesn't fit easily, make sure it is facing the right way.)
8. Push down the side marked **PUSH** until it snaps in.

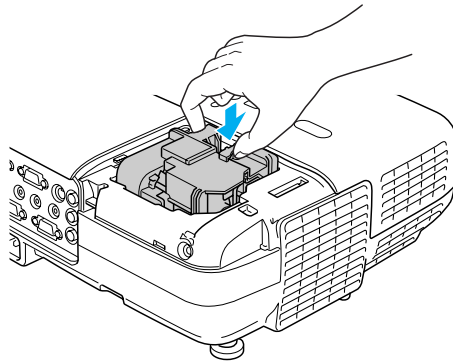

9. Once the lamp is fully inserted, tighten its screws.

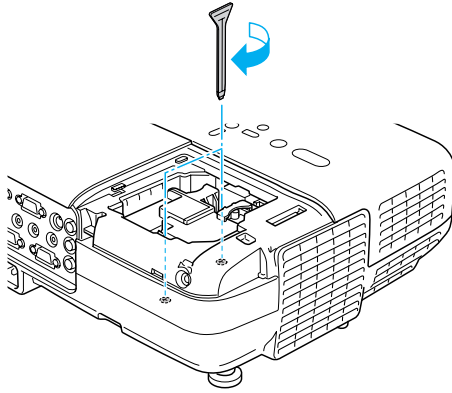

10. Replace the lamp cover, then tighten its screw.

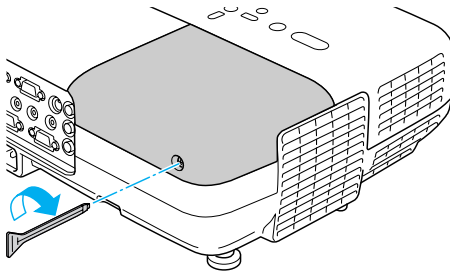

11. Reset the lamp timer as described page 128.

Replacing the Air Filter

If the filter is difficult to clean or damaged, or if the overheating message appears after cleaning, you need to replace the filter. To obtain a new filter, contact your dealer, call Epson at 800-GO-EPSON (800-463-7766), or purchase online at www.epsonstore.com (U.S. sales) or www.epson.ca (Canadian sales).

1. Turn off the projector.
2. When the  power light stops flashing and you hear two beeps, unplug the power cord.
3. Open the air filter cover by sliding the switch and pulling down the cover.

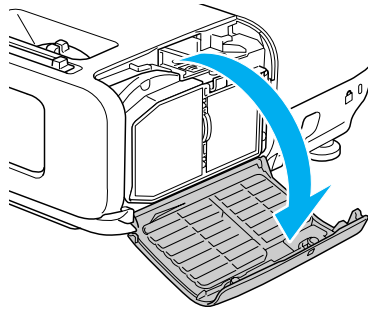
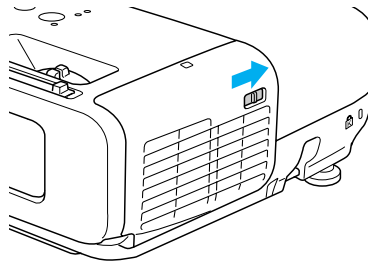

4. Grasp the tab and pull the filter straight out.

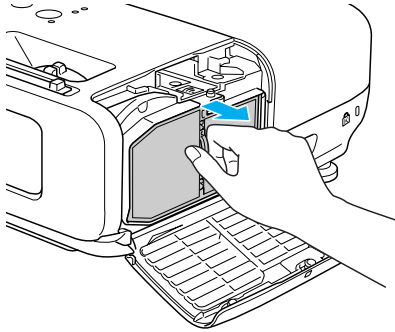

5. Press in the new air filter until it clicks in place.

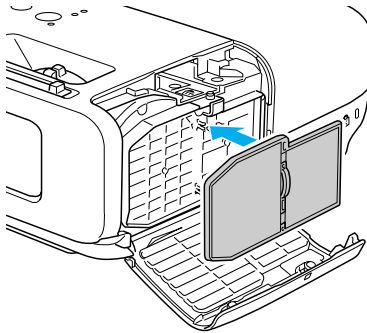

6. Close the air filter cover.

note

The air filter contains polycarbonate, ABS resin, and polyurethane foam. Dispose of used air filters properly in accordance with your local regulations.

Resetting the Lamp Timer

After you replace the lamp, you need to reset the lamp timer using the projector's menus.

1. Press the **Menu** button on the remote control or on the projector's control panel. You see the main menu.
2. Use the  buttons on the remote control (or the navigational buttons on the projector) to highlight **Reset**, then press **Enter**.

You see this screen:

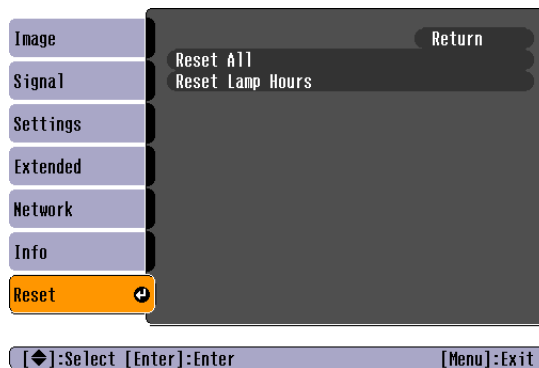

3. Select **Reset Lamp Hours** and press **Enter**.
4. When you see the prompt, select **Yes** and press **Enter**.
5. When you're finished, press **Esc** or **Menu** to exit the Menu system.

Transporting the Projector

The projector contains many glass and precision parts. Follow these guidelines to prevent damage:

- Close the A/V Mute slide (lens cover) to protect the lens.
- When shipping the projector for repairs, use the original packaging material if possible. If you do not have the original packaging, use equivalent materials, placing plenty of cushioning around the projector.
- When transporting the projector a long distance, first place it in a hard-shell shipping case, then pack it in a firm box with cushioning around the case. (An optional case is available from Epson; see page 13.)

note

Epson shall not be liable for any damages incurred during transportation.

7

Solving Problems

This chapter helps you solve problems with your projector, and tells you how to contact technical support for problems you can't solve yourself. The following information is included:

- Using the projector's on-screen help system
- What to do when the projector's status lights flash
- Solving projector operation problems
- Solving problems with the image or sound
- Solving network problems
- Solving problems with the remote control
- Contacting technical support

Using On-Screen Help

If the image doesn't look right or your audio isn't working, you can get help by pressing the ? Help button on top of the projector or on the remote control.

1. Press the ? Help button on the remote control or on the projector.

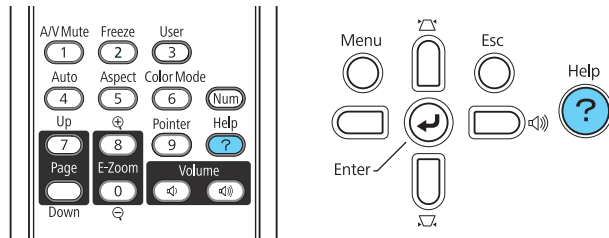

You see the Help Menu.

2. Use the  pointer button on the remote control or the navigational buttons on the projector to highlight menu items.
3. Press the Enter button on the remote control or on the projector to select the menu item.
4. To exit the help system, press the ? Help button.

If none of the suggestions solve your problem, see additional solutions to problems in the following sections.

Checking Projector Status

If your projector isn't working correctly, first turn it off, wait for it to cool (the projector beeps twice and the  power light stops flashing orange), and unplug it. Then plug the power cord back in and turn on the projector. If this doesn't solve the problem, check the lights on top of the projector.





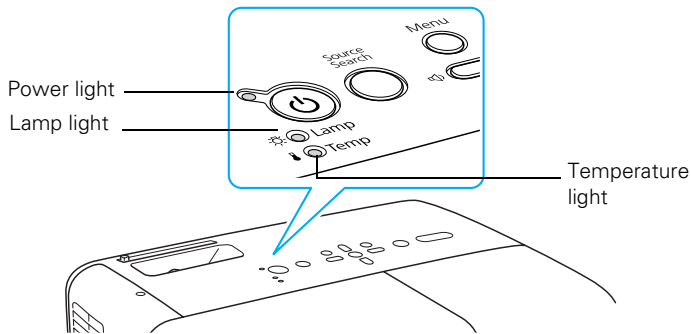





What To Do When the Lights Flash

The lights on top of the projector indicate the projector's status.









Refer to the following table for a complete description of the projector's status lights:

Status lights

Light	Status	Description
	Orange	The projector is in sleep or standby mode. You can unplug it or you can press the  power button to turn it on.
	Flashing green	The projector is warming up. Wait for the image to appear.
	Green	The projector is operating normally.
	Flashing orange	The projector is cooling down or preparing network monitoring. You can't turn it back on (and you should not unplug it) until the light stops flashing and remains orange.
	Red or flashing red	There is a problem with the projector. Check the other two lights and the information in the rest of this table to diagnose the problem.
 	Flashing red	Power is cut off because of an internal problem. Unplug the power cord and contact Epson for help, as described on page 149.
  	Flashing red	The auto iris or ballast is malfunctioning. Unplug the power cord and contact Epson for help, as described on page 149.

Status lights (continued)

Light	Status	Description
	Flashing red	There is a problem with the fan or temperature sensor. Stop using the projector, disconnect the power cable, and contact Epson as described on page 149.
	Flashing orange	Rapid cooling is in progress. Although this is not an abnormal condition, projection will stop automatically if the temperature rises higher. Make sure there is plenty of space around the projector for ventilation, and that the air filter and vents are clear. If you're using the projector above 4900 feet (1500 m), turn on High Altitude Mode ; see page 117.
	Red	<p>The projector is overheating, which turns the lamp off automatically. Wait until the cooling fan stops, then unplug the power cord. Plug the power cord back in and press the  power button. Make sure the room temperature is not above 95 °F (35 °C), and there is plenty of space around the projector for ventilation. If you're using the projector above 4900 feet (1500 m), turn on High Altitude Mode; see page 117.</p> <p>The air filter or vent may be clogged. Clean them or replace the air filter as described on page 121.</p> <p>If the projector continues to overheat after you clean or replace the air filter, contact Epson for help as described on page 149.</p> <p>Warning: Except as specifically explained in this <i>User's Guide</i>, do not attempt to service this product yourself.</p>
	Flashing orange	It's time to replace the lamp. See page 122 for instructions. If you continue to use the lamp after the replacement warning, there is an increased possibility that the lamp may break.
	Flashing red	<p>The lamp may be burnt out. First make sure the lamp cover is securely installed. If that's not the problem, let the lamp cool, remove the lamp, and check if it is cracked. If it is cracked, replace it as described on page 122. If it not cracked, reinstall the lamp and try using it again.</p> <p>The air filter or vent may be clogged. Clean them or replace the air filter as described on page 121.</p> <p>If these steps do not resolve the problem, contact Epson as described on page 149.</p>

Viewing Lamp Usage and Other Information

Use the Info menu to view information about the display settings of your computer and the number of hours the lamp has been used.

Press the **Menu** button and highlight the **Info** menu.

You see the lamp usage hours and various input signal settings on the right.





The life span of the lamp is about 5000 hours if the **Power Consumption** setting in the Settings menu is set to **Normal** (default), and 6000 hours if the **Power Consumption** setting is set to **ECO**. Make sure you have a spare lamp handy if the usage hours on this menu are close to the life span of your lamp.

note

The information displayed depends on the input signal currently selected.

Solving Projector Operation Problems

The power doesn't turn on.

- If the projector doesn't turn on when you press the  power button, make sure the power cable is connected to the projector and plugged into a working electrical outlet.
- The power cable may be defective. Disconnect the cable from the outlet and contact Epson as described on page 149.
- Check to see if the A/V Mute slide is closed.
- Check the status lights (see page 133).
- Try using the  power button on both the projector's control panel and the remote control. If only the control panel  power button doesn't work, the Control Panel Lock setting may be set to **Full Lock** (see page 115). If only the remote control  power button doesn't work, the projector's remote control sensors may have been deactivated by the Remote Receiver setting (see page 109).

The buttons on the projector don't work.





If the control panel buttons have been locked, try using the remote control instead. See page 115 for information about locking the control panel.

You hear the projector's fan after the power has been turned off.

If Standby Mode is set to Communication On, the fan continues to operate after the projector has cooled down. See page 117 for more information about this setting.

Solving Problems with the Image or Sound

No image appears on the screen.

- Check that the  power light is green, not flashing.
- The projector may be in standby or sleep mode. If the  power light is orange, press the  power button to turn the projector on.
- If the power was switched off and then on again, the projector may be cooling down. Wait until the  power light stops flashing and remains orange; then press the  power button again.
- Press the **A/V Mute** button on the remote control to make sure the picture has not been turned off temporarily.
- Open the A/V Mute slide, if it is closed.
- The attached computer may be in sleep mode or displaying a black screen saver. Try pressing a key on the computer.
- If you are projecting from a DVD player or other video source, make sure you turn it on and press its **Play** button.

- If you're projecting through your computer's USB port, make sure the **USB Type B** setting in the Extended menu is set to **USB Display** (see page 118). The USB display feature is not available for Windows 98 or Me.

With Windows, you may need to install the USB display drivers manually by clicking **My Computer** or **Computer**, then **EPSON_PJ_UD**, then **EMP_UDSE.EXE**. If nothing is projected after the USB display drivers are installed, click **All Programs**, **EPSON Projector**, **EPSON USB Display**, then **EPSON USB Display Vx.x** on your computer.

With Mac OS X, click the **USB Display** icon in the Dock. If there is no USB Display icon in the Dock, open the **USB Display** folder in the Applications folder and run **USB Display**.

- If you see a black screen and you are connected through your computer's USB port (or through your network with your PowerLite 85+/825+/826W+), the application may be using DirectX drawing features, which are not supported.

You've connected a computer and see a blue screen with the message No Signal displayed.

- Make sure the cables are connected correctly and securely, as described on page 48.
- If you've connected more than one computer and/or video source, you may need to press the **Source Search** button on the remote control or projector or one of the source buttons on the remote control to select the correct source. Pressing the **Computer** button on the remote control will toggle between Computer1 and Computer2 inputs. Allow a few seconds for the projector to sync up after pressing the button.

If you're using a PC notebook:

- Press the function key on your keyboard that lets you display on an external monitor. It may have an icon such as , or it may be labeled **CRT/LCD**. You may have to hold down the **Fn** key

while pressing it. Allow a few seconds for the projector to sync up after changing the setting. Check your notebook's manual or online help for details.

On most systems, the  key lets you toggle between the LCD screen and the projector, or display on both at the same time.

- Depending on your computer's video card, you might need to use the Display utility in the Control Panel to make sure that both the LCD screen and external monitor port are enabled. See your computer's documentation or online help for details.

If you're using Mac OS X:

1. Open **System Preferences**.
2. Click **Display** or **Displays**.
3. Click **Detect Displays**.
4. Do one of the following:

Mac OS X 10.6.x users: Click **Show displays** in menu bar.

Other Mac OS X users: Make sure the **VGA Display** or **Color LCD** dialog box is selected, click the **Arrangement** or **Arrange** tab, then make sure the **Mirror Displays** checkbox is selected.

The message Not Supported is displayed.

- Depending on the source you're projecting from, make sure the correct **Input Signal** or **Video Signal** is selected in the **Signal** menu (see page 107).
- Make sure your computer's resolution doesn't exceed **UXGA** (1600 × 1200) and the frequency or refresh rate is supported by the projector (see page 157). If necessary, change your computer's resolution setting.

The Projector and Notebook Don't Display the Same Image

If you're projecting from a notebook, and you can't see your image on the projection screen and on your computer at the same time, follow these guidelines.

If you're using a PC notebook:

- On most systems, there's a function key that lets you toggle between the LCD screen and the projector, or display on both at the same time. It may be labeled CRT/LCD or have an icon such as . You may have to hold down the Fn key while pressing it. Allow a few seconds for the projector to sync up after changing the setting.
- If the function key doesn't permit you to display simultaneously on both screens, you should check your monitor settings to make sure both the LCD screen and the external monitor port are enabled.

From the Control Panel, open the **Display** utility, select the **Settings** option, then select the **Advanced** option (in Windows Vista, right-click on the desktop, select **Personalize**, select **Display Settings**, then select **Advanced Settings**). The method for adjusting the settings varies by brand; you may need to click a **Monitor** tab, then make sure the external Monitor port is set as your primary display and/or enabled. See your computer's documentation or online help for details.

If you're using Mac OS X:

You may need to set up your system to display on the projector screen as well as the LCD screen. Make sure your projector is connected and follow these steps:

1. Open **System Preferences**.
2. Click **Display** or **Displays**.

3. Click **Detect Displays**.
4. Do one of the following:



Mac OS X 10.6.x users: Click **Show displays** in menu bar.

Other Mac OS X users: Make sure the **VGA Display** or **Color LCD** dialog box is selected, click the **Arrangement** or **Arrange** tab, then make sure the **Mirror Displays** checkbox is selected.

Only part of the image is displayed.

- Press the **Aspect** button on the remote control to select a different setting (see page 36).
- If projecting from a computer, press the **Auto** button on the remote control. Also make sure the image **Position** setting is correct in the **Signal** menu (see page 107).
- Check the projector's **Resolution** setting (see page 106). Select **Normal** or **Wide**, depending on the size of your computer's display panel.
- Make sure your computer is not set to display an extended desktop or dual display.
- Press the **Esc** button on the remote control to cancel the **E-Zoom** function.
- Make sure your computer's resolution setting is correct. Ideally, it should be 1280 × 800 to match the projector's native resolution for the PowerLite 826W+, or 1024 × 768 for the PowerLite 84+/85+/824+/825+. If this option isn't available, select one of the other compatible video formats listed on page 157.
- You also may need to modify existing presentation files if you created them for a different resolution. See your software documentation for specific information.

The image isn't square, but keystone-shaped.

- If the top or bottom of the image is broader, press the  or  button on the projector until the image is square.
- If the projector is angled toward the screen from the left or right, the image will be broader on one side. Center the projector in front of the middle of the screen, facing the screen squarely.
- Enable the Auto Keystone feature to automatically fix the shape. See page 108.

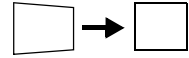
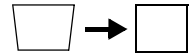

The image contains static or noise.

- If you're using a computer cable longer than 6 feet, or an extension cable, the image quality may be reduced. Use a distribution amplifier for longer distances; you can purchase one from Epson (see page 13).
- Keep your computer and video cables away from the power cord as much as possible to prevent interference.
- The video signal may be split between the computer and the projector. If you notice a decline in the projected image quality when the image is displayed simultaneously on your notebook computer and the projector, turn off the notebook's LCD display.
- Depending on the source you're projecting from, make sure the correct **Input Signal** or **Video Signal** is selected in the Signal menu (see page 107).
- If still images are jittery when you are projecting from a video source, turn on the **Progressive** setting in the Signal menu (see page 107).
- Select **Noise Reduction** in the Signal menu, then try selecting **NR1** or **NR2**.

- Make sure your computer's resolution setting is correct. Ideally, it should be 1280 × 800 to match the projector's native resolution for the PowerLite 826W+, or 1024 × 768 for the PowerLite 84+/85+/824+/825+. If this option isn't available, select one of the other compatible video formats listed on page 157.
- If you are projecting from a computer, press the Auto button on the remote control. If that doesn't work, you can adjust the Tracking and Sync settings in the Signal menu (see page 106).

The image is blurry.

- There may be dirt or smears on the lens. Clean the lens as described on page 120.
- Adjust the focus using the focus ring (see page 27).
- Make sure the lens is not fogged by condensation. You may need to wait before using the projector after moving it from a cold environment to a warm environment.
- Make sure the projector is facing the screen squarely, to eliminate the need for keystone correction.
- Adjust the **Sharpness** setting on the Image menu (see page 105). When you change video settings, you should be able to see the effect on the screen immediately. If you're projecting from a computer, you may also need to adjust the tracking and sync as described in the next section. If you don't like the new settings, you can always select **Reset** to return to the factory default settings.
- Make sure the projector is within the recommended distance range (see page 16).

You see vertical bands or the image still looks blurry after trying the solutions in the previous section.

- If you're projecting from a computer and displaying an image that contains a lot of fine detail, you may notice vertical bands or some of the characters may look heavy or blurred. Press the **Auto** button on the remote control to reset the projector's tracking and sync settings.
- If further adjustment is needed, you can fine-tune the **Tracking** and **Sync** settings manually using the **Signal** menu, as described on page 106.
 1. Fill the screen with an image containing fine detail, such as black text on a white background.
 2. Adjust the **Tracking** to eliminate vertical bands.

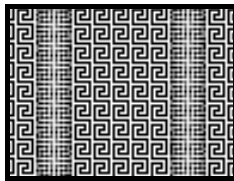

3. Adjust the **Sync** setting to increase the image sharpness.

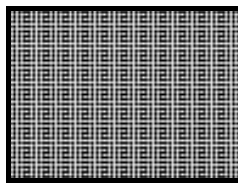

The image is too light or dark, or colors are incorrect.

- Press the **Color Mode** button to select a different color mode (see page 38).
- Try adjusting the brightness and color settings in the **Image** menu (see page 104).
- Try changing the **Power Consumption** in the **Settings** menu (see page 108).
- Check your computer display settings to correct the color balance.

note

Because of the different technologies used, your projected image may not exactly match the colors on your notebook or computer monitor.

- The projector's lamp may need to be replaced. See page 122 for instructions.
- In the Image menu, select **Reset** to change the color settings back to their defaults.
- Make sure the cables are connected correctly and securely (see page 47).

The mouse pointer flickers when you are projecting through the USB cable connection.



Select All Programs > EPSON Projector > EPSON USB Display > EPSON USB Display Vx.x., then clear the Transfer layered window checkbox.

Moving images are not displayed

If you're using a notebook computer or a computer with a built-in LCD screen and its signal is being output to both the LCD and the projector, you may need to change the computer's settings to that the signal only outputs to the projector. See your computer's documentation or online help for details.

There is no sound, or the sound is not loud enough.

- Press the  button on the projector or remote control to increase the volume.
- Make sure **A/V Mute** is not enabled. (The **A/V Mute** button on the remote control may have been pressed.)
- Try adjusting the **Volume** setting in the Settings menu (see page 108).
- If you're using a DVD player or VCR or other video source, make sure the volume is not turned all the way down or muted. Also, make sure the cables are connected correctly, as described on page 59.
- Make sure you are using a "no resistance" audio cable.

- Make sure the audio cable is connected correctly and securely at both ends (see page 59). For computer audio, connect the cable to your computer's  headphone jack or  audio out jack. If you need to disconnect or reconnect the cable, lower the volume first.
- Make sure the volume control on your computer is not turned all the way down or muted. In Windows, you may be able to use the volume control in your Windows system tray (lower right corner of the screen). On a Mac, you may be able to adjust the volume from your menu bar (top right corner of the screen) or via the volume control function keys.
- If you are using a microphone connected to the projector's **Mic** port, make sure the cable is connected correctly and securely and the **Mic Input Level** option on the Settings menu is adjusted correctly. See page 109 for more information. If you need to disconnect or reconnect the cable, lower the volume first.
- If you are using a condenser microphone, set the **Plug-in Power** setting to **On** in the Extended menu.

Solving Network Problems

You can't display an image using Quick Wireless Connection. (PowerLite 85+/825+/826W+ only)

You may need to restart your computer to connect.

You can't connect to the projector using EasyMP Network Projection. (PowerLite 85+/825+/826W+ only)

- Make sure the network cable is connected, as described on page 64.
- If you are using the optional wireless LAN module, make sure it is installed correctly in the projector, as shown on page 67.
- Restart your computer.
- Make sure your projector and computer are configured correctly; see page 71 (Ad Hoc mode) or page 78 (Access Point mode).

- If you are using the optional wireless LAN module, make sure that you have sufficient wireless signal strength (above 50 percent). On a Mac, check the AirPort icon on the Mac menu bar. In Windows, see the documentation for your computer's wireless card or adapter for details.
- Make sure you aren't projecting one of the EasyMP Network Projection configuration screens. (You should see a message that the projector is ready to connect.) If you have to exit a configuration screen, restart EasyMP Network Projection.
- If the projector is configured for Access Point mode and you're using DHCP, allow time for your projector to appear. It takes the server a little while to pick up the IP address.
- If you've changed any settings for your projector or network, or restarted your computer, allow a minute or two for the connection to appear. If you're using AirPort, try turning AirPort off and then on again.
- Make sure that you're trying to connect to the right network. In Windows, verify that you've enabled your computer's connection to the access point (see page 84) or that your wireless card or adapter is enabled and its SSID is set to match the projector's SSID (see page 76). On a Mac, click the AirPort icon at the top of your Mac desktop to make sure AirPort is turned on and the projector's SSID or your AirPort network is selected.
- If you have an access point or AirPort base station and you're not using DHCP, check your projector's IP address on the Access Point mode advanced settings screen. The first three segments of the IP address should be identical to the first three segments of the IP address of your access point or base station. The last segment of the projector's IP address should be close, but not identical, to the last segment of the IP address of the access point or base station.
- If you're not using DHCP, check your projector's Gateway address on the projector's Access Point mode advanced settings screen. It should be identical to the IP address for your access point or AirPort base station.

- If you're using a projector keyword, it changes each time you turn the projector off and then on again. Check the projector's keyword on the LAN standby screen and enter it at the prompt.
- If you're using AirPort, check the configuration of your network. Start the AirPort Admin utility, select your base station, click **Configure** and click **Show All Settings**. Click the **Network** tab. If you set up your projector to connect in DHCP mode, turn on **Distribute IP Addresses** and **Share a Single IP Address**.
- If you're using AirPort and DHCP is turned off on your projector's Access Point mode advanced settings screen, make sure **Distribute IP Addresses** is off.
- If you're using Access Point mode and you're connecting to the wrong network, you may be experiencing signal interference from another network. Try resetting your access point or base station, then restart EasyMP Network Projection.
- If you're using AirPort, the projector's SSID should match the AirPort network name, not the name of the AirPort base station. To check the network name, start the AirPort Admin utility, select your base station, and click **Configure**. Then click **Show All Settings**. The network name appears on the AirPort tab.
- If you're prompted for a password when you connect, enter the WEP encryption key (if you're using WEP encryption).

You are not receiving mail when a projector problem occurs.

- Make sure the Mail settings are correct in the Network menu. For details, see page 94.
- To receive mail notification when the projector is in standby mode, you need to set **Standby Mode** to **Communication On** in the Extended menu. See page 117.
- Make sure the network cable or Wireless 802.11a/b/g Module (PowerLite 85+/825+/826W+ only) is securely and correctly connected.
- Make sure power is being supplied to the projector.

Solving Problems with the Remote Control

The projector doesn't respond to remote control commands.

- The remote control's batteries may not be installed correctly or may be low on power. To change the batteries, see page 32.
- Make sure you are within about 20 feet (6 meters) of the projector and within range of the projector's front or back sensor (approximately 30° to the left or right and 30° above or below).
- Dim the room lights and turn off any fluorescent lights. Make sure the projector is not in direct sunlight. Strong lighting, especially fluorescent lights, may affect the projector's infrared receivers. Also, turn off any nearby equipment that emits infrared energy, such as a radiant room heater. To avoid interference, you can also turn off the projector's front or back sensor with the **Remote Receiver** setting (see page 109), but this may limit where you can use the remote control.
- Make sure the projector's sensors have not been turned off with the **Remote Receiver** setting (see page 109).
- If any buttons are held for longer than 30 seconds, the remote enters sleep mode. Release any button that is held to wake the remote.
- If you're using the remote control as a wireless mouse, make sure the **USB Type B** setting in the Extended menu is set to **Wireless Mouse** (see page 118).

Where to Get Help

In the U.S. and Canada, see the sections below.

In Latin America, see the information on your *Guía de instalación* or *Guia de instalação* sheet.

Internet Support

Visit Epson's support website at www.epson.com/support and select your product for solutions to common problems. You can download utilities and documentation, get FAQs and troubleshooting advice, or e-mail Epson with your questions.

Speak to a Support Representative

To use the Epson PrivateLine Support service, call (800) 637-7661 and enter the PIN on the included Epson PrivateLine Support card. This is the fastest way of speaking to a live representative, and it's free. This service is available 6 AM to 6 PM, Pacific Time, Monday through Friday, for the duration of your warranty period.

You may also speak with a projector support specialist by dialing one of these numbers:

- U.S.: (562) 276-4394, 6 AM to 6 PM, Pacific Time, Monday through Friday.
- Canada: (905) 709-3839, 6 AM to 6 PM, Pacific Time, Monday through Friday.

Days and hours of support are subject to change without notice. Toll or long distance charges may apply.

Before you call for support, please have the following information ready:

- Product name (PowerLite 84+/85+/825+/826W+)
- Product serial number (located on the projector)
- Proof of purchase (such as a store receipt) and date of purchase
- Computer or video configuration
- Description of the problem

Purchase Supplies and Accessories

You can purchase screens, carrying cases, or other accessories from an Epson authorized reseller. To find the nearest reseller, call 800-GO-EPSON (800-463-7766). Or you can purchase online at www.epsonstore.com (U.S. sales) or www.epson.ca (Canadian sales).

A *Projector Installation*

This appendix provides guidelines on installing the projector in a permanent location, such as a classroom or conference room.

The projector can be installed for four different viewing setups: front projection, ceiling projection, rear projection onto a semi-transparent screen, or rear/ceiling projection, as shown:

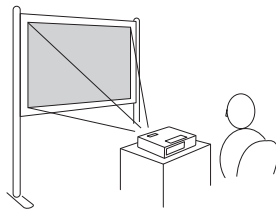

Front projection

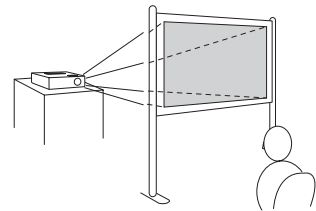

Rear projection

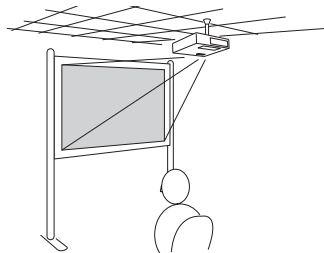

Front/ceiling projection

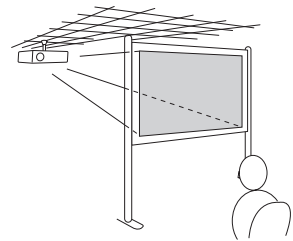

Rear/ceiling projection

To project from overhead, you'll need the optional ceiling mounting hardware; see page 13 for ordering information. You'll also need to select **Front/Ceiling** or **Rear/Ceiling** as the Projection option in the projector's Extended menu to flip the image upside-down. To project from the rear, onto a semi-transparent screen, select **Rear** or **Rear/Ceiling** (see page 116).

If you're mounting the projector on the ceiling and you place it above screen level, you'll have to tilt the projector down to position the image on the screen. This causes the image to lose its square shape. You can correct the distortion using the **Keystone** function in the projector's menu system (see page 108).

If you place the projector so that the base of the lens is level with the bottom of the screen, the image should be square and you won't have to adjust it. If you place the lens lower than the bottom of the screen, you'll have to tilt the projector upward (which will cause the image to lose its square shape, as described above) if you want to fill the whole screen with the image.

The following illustrations provide measurements you can use when installing the projector:

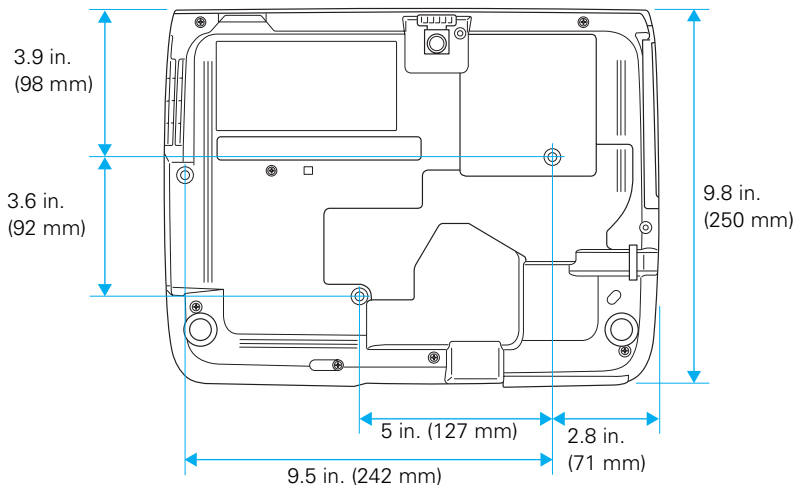
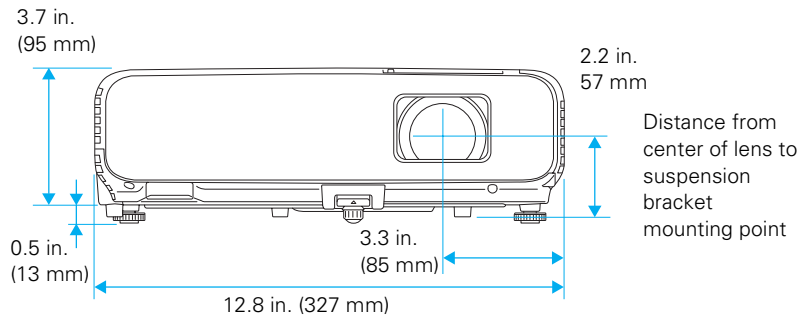

B *Technical Specifications*

General

Type of display	Epson poly-silicon TFT active matrix
Resolution (native format)	
84+, 85+, 824+, 825+	1024 × 768 pixels (XGA)
826W+	1280 × 800 pixels (WXGA)
Color reproduction	16.8 million colors
Light output	White light output

	Normal Power Consumption Mode (ISO 21118) (lumens)	ECO Power Consumption Mode (lumens)
84+/85+	2600	2080
824+/825+	3000	2400
826W+	2500	2000

Color light output

	Normal Power Consumption Mode (lumens)
84+/85+	2600
824+/825+	3000
826W+	2500

Contrast ratio	2000:1 with auto iris
----------------	-----------------------

Image size	28 to 300 inches (84+/85+/824+/825+) 25 to 280 inches (826W+)
Projection distance	2.7 to 45.5 feet (0.83 to 13.86 meters)
Projection methods	Front, rear, upside-down (ceiling mount)
Internal sound system	10 W monaural
Optical aspect ratio	
84+, 85+, 824+, 825+	4:3 (horizontal:vertical)
826W+	16:10 (horizontal:vertical)
Zoom ratio	1:1.62
Noise level	28 dB in ECO Power Consumption mode, 35 dB in Normal Power Consumption mode
Keystone correction	Automatic (manual adjustment capability ±30° vertical keystone correction)
Mouse compatibility	Supports USB (type B)

note

Lamp life will vary depending upon mode selected, environmental conditions, and usage. Brightness decreases over time.

Turn off this product when not in use to prolong the life of the projector.

Projection Lamp

Type	UHE (Ultra High Efficiency)
Power consumption	200 W
Lamp life	Approx. 5000 hours (Normal Power Consumption mode) Approx. 6000 hours (ECO Power Consumption mode)
Part number	V13H010L50

Remote Control

Range	20 feet (6 meters)
Batteries	Two AA

Dimensions

Height	3.7 inches (95 mm), feet retracted
Width	12.9 inches (327 mm)
Depth	9.8 inches (250 mm)
Weight	6.9 lb (3.1 kg)

Electrical

Rated frequency	50/60 Hz AC
Power supply	100 to 120 VAC, 3.3 A 220 to 240 VAC, 1.5 A
Power consumption	Operating: 100 to 120 VAC 289 W (Normal Power Consumption mode) 238W (ECO Power Consumption mode) 220 to 240 VAC 275 W (Normal Power Consumption mode) 228W (ECO Power Consumption mode) Standby: 100 to 120 VAC, 0.4 W (Communication off) 9.4 W (Communication on) 220 to 240 VAC, 0.7 W (Communication off) 9.5 W (Communication on)

Environmental

Temperature	Operating: 41 to 95 °F (5 to 35 °C) Storage: 14 to 140 °F (-10 to 60 °C)
Humidity (non-condensing)	Operating: 20 to 80% RH Storage: 10 to 90% RH
Operating altitude	0 to 7,500 ft (0 to 2,286 m)

Safety

United States	FCC 47CFR Part 15B Class B (DoC) UL60950-1 Second Edition (cTUVUS Mark)
Canada	ICES-003 Class B CSA C22.2 No. 60950-1-07 (cTUVUS Mark)



Pixelworks™ DNX™ ICs are used in this projector.

Compatible Video Formats

The projector supports NTSC, PAL, and SECAM international video standards, as well as the monitor display formats listed below.

To project images output from a computer, the computer's video card must be set at a refresh rate (vertical frequency) that's compatible with the projector. Some images are automatically resized using Epson's SizeWise™ technology to display in the projector's "native" format (XGA or WXGA). The frequencies of some computers may not allow images to display correctly; see your computer's documentation for details.

Mode	Refresh Rate (Hz)	Resolution
VGA—60	60	640 × 480
VESA—72	72	640 × 480
VESA—75	75	640 × 480
VESA—85	85	640 × 480
SVGA—56	56	800 × 600
SVGA—60	60	800 × 600
SVGA—72	72	800 × 600
SVGA—75	75	800 × 600
SVGA—85	85	800 × 600
XGA—60	60	1024 × 768
XGA—70	70	1024 × 768
XGA—75	75	1024 × 768
XGA—85	85	1024 × 768
WXGA—60-1	60	1280 × 768
WXGA—60-2	60	1360 × 768
WXGA—60	60	1280 × 800
WXGA—75	75	1280 × 800
WXGA—85	85	1280 × 800
WXGA+—60	60	1440 × 900
WXGA+—75	75	1440 × 900
WXGA+—85	85	1440 × 900
WSXGA+—60*	60	1680 × 1050
SXGA1—70	70	1152 × 864
SXGA1—75	75	1152 × 864
SXGA1—85	85	1152 × 864

Mode	Refresh Rate (Hz)	Resolution
SXGA2—60	60	1280 × 960
SXGA2—75	75	1280 × 960
SXGA2—85	85	1280 × 960
SXGA+60	60	1400 × 1050
SXGA+75	75	1400 × 1050
SXGA3—60	60	1280 × 1024
SXGA3—75	75	1280 × 1024
SXGA3—85	85	1280 × 1024
UXGA—60	60	1600 × 1200
MAC13	67	640 × 480
MAC16	75	832 × 624
MAC19	75	1024 × 768
MAC19-60	59	1024 × 768
MAC21	75	1152 × 870
NTSC	60	720 × 480
NTSC 4.43	60	720 × 480
PAL	50	720 × 576
M-PAL	60	720 × 576
N-PAL	50	720 × 576
PAL60	60	720 × 576
SECAM	50	720 × 576
HDTV (720p)	60	1280 × 720
HDTV (720p)	50	1280 × 720
HDTV (1080i)	60	1920 × 1080
HDTV (1080i)	50	1920 × 1080
TV480i	60	720 × 480
TV576i	50	720 × 576
SDTV (480p)	60	720 × 480
SDTV (576p)	50	720 × 576

* Available only when you are using the PowerLite 826W+ and the resolution is set to Wide.

C

Notices

This appendix includes safety instructions and other important information about your projector.

Important Safety Instructions

Follow these safety instructions when setting up and using the projector:

- Do not look into the lens when the projector is on. The bright light can damage your eyes, and is especially dangerous for children and pets.
- Do not place the projector on an unstable cart, stand, or table.
- Do not operate the projector on its side, or while tilted to one side. Do not tilt the projector more than 30° forward or back.
- If the projector is mounted on a ceiling, it should be installed by qualified technicians using mounting hardware designed for use with this projector.
- If you use a ceiling mount and apply adhesives to the mount to prevent the screws from loosening, or if you use lubricants or oils on the projector, the projector case may crack and the projector may fall from its ceiling mount. This could cause serious injury to anyone under the mount and could damage the projector. When installing or adjusting a ceiling mount, do not use adhesives to prevent the screws from loosening and do not use oils or lubricants.
- Do not stand on the projector or place heavy objects on it.
- Do not use the projector where it may be exposed to rain, water, or excessive humidity.
- Unplug the projector from the wall outlet before cleaning. Use a dry cloth (or, for stubborn dirt or stains, a moist cloth that has been wrung dry) for cleaning. Do not use liquid or aerosol cleaners, or solvents such as alcohol, thinner, or benzine.
- Never spill liquid of any kind into the projector. Do not place any containers of liquid on top of the projector.

- Do not use the projector where there is excessive humidity or dust, near cooking or heating appliances, or in places where it may come into contact with steam or smoke.
- Never insert or drop objects of any kind through the projector's vents or openings. Do not leave metal, flammable, or foreign objects nearby.
- Do not use or store the projector or remote control in a hot location, such as near a heater, in direct sunlight, or in a closed vehicle.
- Do not block the slots and openings in the projector case. They provide ventilation and prevent the projector from overheating. If you are setting up the projector near a wall, leave at least 7.9 inches (20 cm) of space between the wall and the air exhaust vent.
- Do not operate the projector in a closed-in cabinet unless proper ventilation is provided.
- If you are using two or more projectors side-by-side, leave at least 2 feet (60 cm) of space between the projectors to allow for proper ventilation.
- You may need to clean the air filter and vent. A clogged air filter or vent can block ventilation needed to cool the projector.
- Do not store the projector outdoors for an extended length of time.
- Do not use the projector outside the required temperature range of 41 to 95 °F (5 to 35 °C). Doing so may cause an unstable display and could lead to projector damage.
- Do not store the projector outside the required temperature range of 14 to 140 °F (-10 to 60 °C) or in direct sunlight for long periods of time. Doing so may cause damage to the case.
- Do not touch the plug during an electrical storm. Otherwise, you may receive an electric shock.
- Unplug the projector when it will not be used for extended periods.
- Unplug the projector from the wall outlet and refer servicing to qualified service personnel under the following conditions: If it does not operate normally when you follow the operating instructions, or exhibits a distinct change in performance; If smoke, strange odors, or strange noises come from the projector; If the power cord or plug is damaged or frayed; If liquid or foreign objects get inside the projector, or if it has been exposed to rain or water; If it has been dropped or the housing has been damaged.
- Except as specifically explained in this *User's Guide*, do not attempt to service this product yourself. Refer all servicing to qualified personnel. Opening or removing covers may expose you to dangerous voltages and other hazards.

- Never open any covers on the projector except as specifically explained in this *User's Guide*. Never attempt to disassemble or modify the projector (including consumables). Refer all repairs to qualified service personnel.
- Use the type of power source indicated on the projector. Use of a different power source may result in fire or electric shock. If you are not sure of the power available, consult your dealer or power company.
- If you use the projector in a country other than where you purchased it, use the correct power cord for that country.
- Take the following precautions when handling the plug: Do not hold the plug with wet hands. Do not insert the plug into a dusty outlet. Insert the plug firmly into the outlet. Do not pull the power cord when disconnecting the plug; always be sure to hold the plug when disconnecting it. Do not overload wall outlets, extension cords, or power strips. Failure to comply with these precautions could result in fire or electric shock.
- Do not place the projector where the cord can be walked on.
- (Hg) The lamp(s) in this product contain mercury. Please consult your state and local regulations regarding disposal or recycling. Do not put in the trash.
- Do not place anything that can become warped or damaged by heat near the exhaust vents. Do not bring your hands or face close to the vents while projection is in progress.
- Before you move the projector, make sure its power is turned off, the plug is disconnected from the outlet, and all cables are disconnected.
- Never try to remove the lamp immediately after use because it will be extremely hot. Before removing the lamp, turn off the power and wait at least an hour to allow the lamp to cool completely.
- Do not place the source of an open flame, such as a lit candle, on or near the projector.
- Do not modify the power cord. Do not place heavy objects on top of the power cord or bend, twist, or pull it excessively. Keep the power cord away from hot electrical appliances.
- If the lamp breaks, ventilate the room to prevent gases contained in the lamp from being inhaled or coming in contact with the eyes or mouth.
- If the projector is mounted overhead and the lamp breaks, be careful to prevent pieces of glass from falling into your eyes or mouth when you open the lamp cover.
- Do not disassemble or damage the lamp or subject it to any impacts.
- Do not bring your face close the projector while it is in use.

- Do not use sprays containing flammable gas to clean the lens or filter. Do not spray a liquid of any kind directly on the projector or its lens. Do not use the projector where there may be flammable, explosive, or corrosive gases present in the atmosphere.
- Insert batteries so that the polarities are correct. Do not use batteries of different types or mix old and new batteries. Do not use batteries other than those specified in this *User's Guide*.
- If the batteries leak, wipe away battery fluid with a soft cloth. If fluid gets on your hands, wash them immediately.
- Replace the batteries as soon as they run out. Dispose of used batteries according to local regulations.
- Remove the batteries if you will not be using the remote control for a long period of time.
- Do not expose batteries to heat or flame and do not put them in water.
- Keep batteries out of the reach of children. Batteries are choking hazards and are very dangerous if swallowed.
- Do not start the projector while the volume is too high.
- Do not use the projector where there may be low or high temperature extremes or sudden changes in temperature.
- Do not set up the projector where it may be subjected to vibrations or shocks, or near high-voltage electrical wires or sources of magnetic fields.

WARNING: The cords included with this product contain chemicals, including lead, known to the State of California to cause birth defects or other reproductive harm. *Wash hands after handling.* (This notice is provided in accordance with Proposition 65 in Cal. Health & Safety Code §25249.5 and following.)

FCC Compliance Statement

For United States Users

This equipment has been tested and found to comply with the limits for a Class B digital device, pursuant to Part 15 of the FCC Rules. These limits are designed to provide reasonable protection against harmful interference in a residential installation. This equipment generates, uses, and can radiate radio frequency energy and, if not installed and used in accordance with the instructions, may cause harmful interference to radio communications. However, there is no guarantee that interference will not occur in a particular installation. If this equipment does cause interference to radio or television reception, which can be determined by turning the equipment off and on, the user is encouraged to try to correct the interference by one or more of the following measures:

- Reorient or relocate the receiving antenna.
- Increase the separation between the equipment and receiver.
- Connect the equipment into an outlet on a circuit different from that to which the receiver is connected.
- Consult the dealer or an experienced radio/TV technician for help.

WARNING

The connection of a non-shielded equipment interface cable to this equipment will invalidate the FCC Certification of this device and may cause interference levels which exceed the limits established by the FCC for this equipment. It is the responsibility of the user to obtain and use a shielded equipment interface cable with this device. If this equipment has more than one interface connector, do not leave cables connected to unused interfaces. Changes or modifications not expressly approved by the manufacturer could void the user's authority to operate the equipment.

For Canadian Users

This Class B digital apparatus complies with Canadian ICES-003.

Cet appareil numérique de la classe B est conforme à la norme NMB-003 du Canada.

Software Notices (for PowerLite 85+/825+/826W+)

GNU GPL

This projector product includes the open source software programs which apply the GNU General Public License Version 2 or later version ("GPL Programs").

We provide the source code of the GPL Programs until five (5) years after the discontinuation of same model of this projector product.

If you desire to receive the source code of the GPL Programs, please contact the customer support of your region.

These GPL Programs are WITHOUT ANY WARRANTY; without even the implied warranty of MERCHANTABILITY AND FITNESS FOR A PARTICULAR PURPOSE. See the GNU General Public License for more details.

The list of GPL Programs is as follows and the names of author are described in the source code of the GPL Programs

The list of GPL Programs

busybox-1.7.2

libgcc1(gcc-4.2.3)

linux-2.6.20

patches

udhcp 0.9.8

uvc rev.219

wireless_tools 29

Pixelworks PWC950 SDK drivers

The GNU General Public License Version 2 is as follows. You also can see the GNU General Public License Version 2 at <http://www.gnu.org/licenses/>.

GNU GENERAL PUBLIC LICENSE

Version 2, June 1991

Copyright (C) 1989, 1991 Free Software Foundation, Inc., 51 Franklin Street, Fifth Floor, Boston, MA 02110-1301 USA Everyone is permitted to copy and distribute verbatim copies of this license document, but changing it is not allowed.

Preamble

The licenses for most software are designed to take away your freedom to share and change it. By contrast, the GNU General Public License is intended to guarantee your freedom to share and change free software—to make sure the software is free for all its users. This General Public License applies to most of the Free Software Foundation's software and to any other program whose authors commit to using it. (Some other Free Software Foundation software is covered by the GNU Lesser General Public License instead.) You can apply it to your programs, too.

When we speak of free software, we are referring to freedom, not price. Our General Public Licenses are designed to make sure that you have the freedom to distribute copies of free software (and charge for this service if you wish), that you receive source code or can get it if you want it, that you can change the software or use pieces of it in new free programs; and that you know you can do these things.

To protect your rights, we need to make restrictions that forbid anyone to deny you these rights or to ask you to surrender the rights. These restrictions translate to certain responsibilities for you if you distribute copies of the software, or if you modify it.

For example, if you distribute copies of such a program, whether gratis or for a fee, you must give the recipients all the rights that you have. You must make sure that they, too, receive or can get the source code. And you must show them these terms so they know their rights.

We protect your rights with two steps: (1) copyright the software, and (2) offer you this license which gives you legal permission to copy, distribute and/or modify the software.

Also, for each author's protection and ours, we want to make certain that everyone understands that there is no warranty for this free software. If the software is modified by someone else and passed on, we want its recipients to know that what they have is not the original, so that any problems introduced by others will not reflect on the original authors' reputations.

Finally, any free program is threatened constantly by software patents. We wish to avoid the danger that redistributors of a free program will individually obtain patent licenses, in effect making the program proprietary. To prevent this, we have made it clear that any patent must be licensed for everyone's free use or not licensed at all.

The precise terms and conditions for copying, distribution and modification follow.

GNU GENERAL PUBLIC LICENSE TERMS AND CONDITIONS FOR COPYING, DISTRIBUTION AND MODIFICATION

0. This License applies to any program or other work which contains a notice placed by the copyright holder saying it may be distributed under the terms of this General Public License. The "Program", below, refers to any such program or work, and a "work based on the Program" means either the Program or any derivative work under copyright law: that is to say, a work containing the Program or a portion of it, either verbatim or with modifications and/or translated into another language. (Hereinafter, translation is included without limitation in the term "modification".) Each licensee is addressed as "you".

Activities other than copying, distribution and modification are not covered by this License; they are outside its scope. The act of running the Program is not restricted, and the output from the Program is covered only if its contents constitute a work based on the Program (independent of having been made by running the Program). Whether that is true depends on what the Program does.

1. You may copy and distribute verbatim copies of the Program's source code as you receive it, in any medium, provided that you conspicuously and appropriately publish on each copy an appropriate copyright notice and disclaimer of warranty; keep intact all the notices that refer to this License and to the absence of any warranty; and give any other recipients of the Program a copy of this License along with the Program.

You may charge a fee for the physical act of transferring a copy, and you may at your option offer warranty protection in exchange for a fee.

2. You may modify your copy or copies of the Program or any portion of it, thus forming a work based on the Program, and copy and distribute such modifications or work under the terms of Section 1 above, provided that you also meet all of these conditions:
 - a) You must cause the modified files to carry prominent notices stating that you changed the files and the date of any change.
 - b) You must cause any work that you distribute or publish, that in whole or in part contains or is derived from the Program or any part thereof, to be licensed as a whole at no charge to all third parties under the terms of this License.
 - c) If the modified program normally reads commands interactively when run, you must cause it, when started running for such interactive use in the most ordinary way, to print or display an announcement including an appropriate copyright notice and a notice that there is no warranty (or else, saying that you provide a warranty) and that users may redistribute the program under these conditions, and telling the user how to view a copy of this License. (Exception: if the Program itself is interactive but does not normally print such an announcement, your work based on the Program is not required to print an announcement.)

These requirements apply to the modified work as a whole. If identifiable sections of that work are not derived from the Program, and can be reasonably considered independent and separate works in themselves, then this License, and its terms, do not apply to those sections when you distribute them as separate works. But when you distribute the same sections as part of a whole which is a work based on the Program, the distribution of the whole must be on the terms of this License, whose permissions for other licensees extend to the entire whole, and thus to each and every part regardless of who wrote it.

Thus, it is not the intent of this section to claim rights or contest your rights to work written entirely by you; rather, the intent is to exercise the right to control the distribution of derivative or collective works based on the Program.

In addition, mere aggregation of another work not based on the Program with the Program (or with a work based on the Program) on a volume of a storage or distribution medium does not bring the other work under the scope of this License.

3. You may copy and distribute the Program (or a work based on it, under Section 2) in object code or executable form under the terms of Sections 1 and 2 above provided that you also do one of the following:

- a) Accompany it with the complete corresponding machine-readable source code, which must be distributed under the terms of Sections 1 and 2 above on a medium customarily used for software interchange; or,
- b) Accompany it with a written offer, valid for at least three years, to give any third party, for a charge no more than your cost of physically performing source distribution, a complete machine-readable copy of the corresponding source code, to be distributed under the terms of Sections 1 and 2 above on a medium customarily used for software interchange; or,
- c) Accompany it with the information you received as to the offer to distribute corresponding source code. (This alternative is allowed only for noncommercial distribution and only if you received the program in object code or executable form with such an offer, in accord with Subsection b above.)

The source code for a work means the preferred form of the work for making modifications to it. For an executable work, complete source code means all the source code for all modules it contains, plus any associated interface definition files, plus the scripts used to control compilation and installation of the executable. However, as a special exception, the source code distributed need not include anything that is normally distributed (in either source or binary form) with the major components (compiler, kernel, and so on) of the operating system on which the executable runs, unless that component itself accompanies the executable.

If distribution of executable or object code is made by offering access to copy from a designated place, then offering equivalent access to copy the source code from the same place counts as distribution of the source code, even though third parties are not compelled to copy the source along with the object code.

- 4. You may not copy, modify, sublicense, or distribute the Program except as expressly provided under this License. Any attempt otherwise to copy, modify, sublicense or distribute the Program is void, and will automatically terminate your rights under this License. However, parties who have received copies, or rights, from you under this License will not have their licenses terminated so long as such parties remain in full compliance.
- 5. You are not required to accept this License, since you have not signed it. However, nothing else grants you permission to modify or distribute the Program or its derivative works. These actions are prohibited by law if you do not accept this License. Therefore, by modifying or distributing the Program (or any work based on the Program), you indicate your acceptance of this License to do so, and all its terms and conditions for copying, distributing or modifying the Program or works based on it.
- 6. Each time you redistribute the Program (or any work based on the Program), the recipient automatically receives a license from the original licensor to copy, distribute or modify the Program subject to these terms and conditions. You may not impose any further restrictions on the recipients' exercise of the rights granted herein. You are not responsible for enforcing compliance by third parties to this License.

7. If, as a consequence of a court judgment or allegation of patent infringement or for any other reason (not limited to patent issues), conditions are imposed on you (whether by court order, agreement or otherwise) that contradict the conditions of this License, they do not excuse you from the conditions of this License. If you cannot distribute so as to satisfy simultaneously your obligations under this License and any other pertinent obligations, then as a consequence you may not distribute the Program at all. For example, if a patent license would not permit royalty-free redistribution of the Program by all those who receive copies directly or indirectly through you, then the only way you could satisfy both it and this License would be to refrain entirely from distribution of the Program.

If any portion of this section is held invalid or unenforceable under any particular circumstance, the balance of the section is intended to apply and the section as a whole is intended to apply in other circumstances.

It is not the purpose of this section to induce you to infringe any patents or other property right claims or to contest validity of any such claims; this section has the sole purpose of protecting the integrity of the free software distribution system, which is implemented by public license practices. Many people have made generous contributions to the wide range of software distributed through that system in reliance on consistent application of that system; it is up to the author/donor to decide if he or she is willing to distribute software through any other system and a licensee cannot impose that choice.

This section is intended to make thoroughly clear what is believed to be a consequence of the rest of this License.

8. If the distribution and/or use of the Program is restricted in certain countries either by patents or by copyrighted interfaces, the original copyright holder who places the Program under this License may add an explicit geographical distribution limitation excluding those countries, so that distribution is permitted only in or among countries not thus excluded. In such case, this License incorporates the limitation as if written in the body of this License.
9. The Free Software Foundation may publish revised and/or new versions of the General Public License from time to time. Such new versions will be similar in spirit to the present version, but may differ in detail to address new problems or concerns.

Each version is given a distinguishing version number. If the Program specifies a version number of this License which applies to it and "any later version", you have the option of following the terms and conditions either of that version or of any later version published by the Free Software Foundation. If the Program does not specify a version number of this License, you may choose any version ever published by the Free Software Foundation.

10. If you wish to incorporate parts of the Program into other free programs whose distribution conditions are different, write to the author to ask for permission. For software which is copyrighted by the Free Software Foundation, write to the Free Software Foundation; we sometimes make exceptions for this. Our decision will be guided by the two goals of preserving the free status of all derivatives of our free software and of promoting the sharing and reuse of software generally.

NO WARRANTY

11. BECAUSE THE PROGRAM IS LICENSED FREE OF CHARGE, THERE IS NO WARRANTY FOR THE PROGRAM, TO THE EXTENT PERMITTED BY APPLICABLE LAW. EXCEPT WHEN OTHERWISE STATED IN WRITING THE COPYRIGHT HOLDERS AND/OR OTHER PARTIES PROVIDE THE PROGRAM "AS IS" WITHOUT WARRANTY OF ANY KIND, EITHER EXPRESSED OR IMPLIED, INCLUDING, BUT NOT LIMITED TO, THE IMPLIED WARRANTIES OF MERCHANTABILITY AND FITNESS FOR A PARTICULAR PURPOSE. THE ENTIRE RISK AS TO THE QUALITY AND PERFORMANCE OF THE PROGRAM IS WITH YOU. SHOULD THE PROGRAM PROVE DEFECTIVE, YOU ASSUME THE COST OF ALL NECESSARY SERVICING, REPAIR OR CORRECTION.
12. IN NO EVENT UNLESS REQUIRED BY APPLICABLE LAW OR AGREED TO IN WRITING WILL ANY COPYRIGHT HOLDER, OR ANY OTHER PARTY WHO MAY MODIFY AND/OR REDISTRIBUTE THE PROGRAM AS PERMITTED ABOVE, BE LIABLE TO YOU FOR DAMAGES, INCLUDING ANY GENERAL, SPECIAL, INCIDENTAL OR CONSEQUENTIAL DAMAGES ARISING OUT OF THE USE OR INABILITY TO USE THE PROGRAM (INCLUDING BUT NOT LIMITED TO LOSS OF DATA OR DATA BEING RENDERED INACCURATE OR LOSSES SUSTAINED BY YOU OR THIRD PARTIES OR A FAILURE OF THE PROGRAM TO OPERATE WITH ANY OTHER PROGRAMS), EVEN IF SUCH HOLDER OR OTHER PARTY HAS BEEN ADVISED OF THE POSSIBILITY OF SUCH DAMAGES.

END OF TERMS AND CONDITIONS

How to Apply These Terms to Your New Programs

If you develop a new program, and you want it to be of the greatest possible use to the public, the best way to achieve this is to make it free software which everyone can redistribute and change under these terms.

To do so, attach the following notices to the program. It is safest to attach them to the start of each source file to most effectively convey the exclusion of warranty; and each file should have at least the "copyright" line and a pointer to where the full notice is found.

```
<one line to give the program's name and a brief idea of what it does.>  
Copyright (C) <year> <name of author>
```

This program is free software; you can redistribute it and/or modify it under the terms of the GNU General Public License as published by the Free Software Foundation; either version 2 of the License, or (at your option) any later version.

This program is distributed in the hope that it will be useful, but WITHOUT ANY WARRANTY; without even the implied warranty of MERCHANTABILITY or FITNESS FOR A PARTICULAR PURPOSE. See the GNU General Public License for more details.

You should have received a copy of the GNU General Public License along with this program; if not, write to the Free Software Foundation, Inc., 51 Franklin Street, Fifth Floor, Boston, MA 02110-1301 USA.

Also add information on how to contact you by electronic and paper mail.

If the program is interactive, make it output a short notice like this when it starts in an interactive mode:

```
Gnomovision version 69, Copyright (C) year name of author Gnomovision comes
with ABSOLUTELY NO WARRANTY; for details type `show w'. This is free
software, and you are welcome to redistribute it under certain conditions; type
`show c' for details.
```

The hypothetical commands ``show w'` and ``show c'` should show the appropriate parts of the General Public License. Of course, the commands you use may be called something other than ``show w'` and ``show c'`; they could even be mouse-clicks or menu items—whatever suits your program.

You should also get your employer (if you work as a programmer) or your school, if any, to sign a "copyright disclaimer" for the program, if necessary. Here is a sample; alter the names:

```
Yoyodyne, Inc., hereby disclaims all copyright interest in the program
`Gnomovision' (which makes passes at compilers) written by James Hacker.

<signature of Ty Coon>, 1 April 1989
Ty Coon, President of Vice
```

This General Public License does not permit incorporating your program into proprietary programs. If your program is a subroutine library, you may consider it more useful to permit linking proprietary applications with the library. If this is what you want to do, use the GNU Lesser General Public License instead of this License.

GNU LGPL

This projector product includes the open source software programs which apply the GNU Lesser General Public License Version 2 or later version ("LGPL Programs").

We provide the source code of the LGPL Programs until five (5) years after the discontinuation of same model of this projector product.

If you desire to receive the source code of the LGPL Programs, please contact the customer support of your region.

These LGPL Programs are WITHOUT ANY WARRANTY; without even the implied warranty of MERCHANTABILITY AND FITNESS FOR A PARTICULAR PURPOSE. See the GNU General Public License for more details.

The list of LGPL Programs is as follows and the names of author are described in the source code of the LGPL Programs.

LGPL Programs

uClibc-0.9.29

SDL-1.2.13

The GNU Lesser General Public License Version 2 is as follows. You also can see the GNU Lesser General Public License Version 2 at <http://www.gnu.org/licenses/>.

GNU LESSER GENERAL PUBLIC LICENSE

Version 2.1, February 1999

Copyright (C) 1991, 1999 Free Software Foundation, Inc. 51 Franklin Street, Fifth Floor, Boston, MA 02110-1301 USA Everyone is permitted to copy and distribute verbatim copies of this license document, but changing it is not allowed.

[This is the first released version of the Lesser GPL. It also counts as the successor of the GNU Library Public License, version 2, hence the version number 2.1.]

Preamble

The licenses for most software are designed to take away your freedom to share and change it. By contrast, the GNU General Public Licenses are intended to guarantee your freedom to share and change free software—to make sure the software is free for all its users.

This license, the Lesser General Public License, applies to some specially designated software packages—typically libraries—of the Free Software Foundation and other authors who decide to use it. You can use it too, but we suggest you first think carefully about whether this license or the ordinary General Public License is the better strategy to use in any particular case, based on the explanations below.

When we speak of free software, we are referring to freedom of use, not price. Our General Public Licenses are designed to make sure that you have the freedom to distribute copies of free software (and charge for this service if you wish); that you receive source code or can get it if you want it; that you can change the software and use pieces of it in new free programs; and that you are informed that you can do these things.

To protect your rights, we need to make restrictions that forbid distributors to deny you these rights or to ask you to surrender these rights. These restrictions translate to certain responsibilities for you if you distribute copies of the library or if you modify it.

For example, if you distribute copies of the library, whether gratis or for a fee, you must give the recipients all the rights that we gave you. You must make sure that they, too, receive or can get the source code. If you link other code with the library, you must provide complete object files to the recipients, so that they can relink them with the library after making changes to the library and recompiling it. And you must show them these terms so they know their rights.

We protect your rights with a two-step method: (1) we copyright the library, and (2) we offer you this license, which gives you legal permission to copy, distribute and/or modify the library.

To protect each distributor, we want to make it very clear that there is no warranty for the free library. Also, if the library is modified by someone else and passed on, the recipients should know that what they have is not the original version, so that the original author's reputation will not be affected by problems that might be introduced by others.

Finally, software patents pose a constant threat to the existence of any free program. We wish to make sure that a company cannot effectively restrict the users of a free program by obtaining a restrictive license from a patent holder. Therefore, we insist that any patent license obtained for a version of the library must be consistent with the full freedom of use specified in this license.

Most GNU software, including some libraries, is covered by the ordinary GNU General Public License. This license, the GNU Lesser General Public License, applies to certain designated libraries, and is quite different from the ordinary General Public License. We use this license for certain libraries in order to permit linking those libraries into non-free programs.

When a program is linked with a library, whether statically or using a shared library, the combination of the two is legally speaking a combined work, a derivative of the original library. The ordinary General Public License therefore permits such linking only if the entire combination fits its criteria of freedom. The Lesser General Public License permits more lax criteria for linking other code with the library.

We call this license the "Lesser" General Public License because it does Less to protect the user's freedom than the ordinary General Public License. It also provides other free software developers Less of an advantage over competing non-free programs. These disadvantages are the reason we use the ordinary General Public License for many libraries. However, the Lesser license provides advantages in certain special circumstances.

For example, on rare occasions, there may be a special need to encourage the widest possible use of a certain library, so that it becomes a de-facto standard. To achieve this, non-free programs must be allowed to use the library. A more frequent case is that a free library does the same job as widely used non-free libraries. In this case, there is little to gain by limiting the free library to free software only, so we use the Lesser General Public License.

In other cases, permission to use a particular library in non-free programs enables a greater number of people to use a large body of free software. For example, permission to use the GNU C Library in non-free programs enables many more people to use the whole GNU operating system, as well as its variant, the GNU/Linux operating system.

Although the Lesser General Public License is Less protective of the users' freedom, it does ensure that the user of a program that is linked with the Library has the freedom and the wherewithal to run that program using a modified version of the Library.

The precise terms and conditions for copying, distribution and modification follow. Pay close attention to the difference between a "work based on the library" and a "work that uses the library". The former contains code derived from the library, whereas the latter must be combined with the library in order to run.

GNU LESSER GENERAL PUBLIC LICENSE TERMS AND CONDITIONS FOR COPYING, DISTRIBUTION AND MODIFICATION

0. This License Agreement applies to any software library or other program which contains a notice placed by the copyright holder or other authorized party saying it may be distributed under the terms of this Lesser General Public License (also called "this License"). Each licensee is addressed as "you".

A "library" means a collection of software functions and/or data prepared so as to be conveniently linked with application programs (which use some of those functions and data) to form executables.

The "Library", below, refers to any such software library or work which has been distributed under these terms. A "work based on the Library" means either the Library or any derivative work under copyright law: that is to say, a work containing the Library or a portion of it, either verbatim or with modifications and/or translated straightforwardly into another language. (Hereinafter, translation is included without limitation in the term "modification".)

"Source code" for a work means the preferred form of the work for making modifications to it. For a library, complete source code means all the source code for all modules it contains, plus any associated interface definition files, plus the scripts used to control compilation and installation of the library.

Activities other than copying, distribution and modification are not covered by this License; they are outside its scope. The act of running a program using the Library is not restricted, and output from such a program is covered only if its contents constitute a work based on the Library (independent of the use of the Library in a tool for writing it). Whether that is true depends on what the Library does and what the program that uses the Library does.

1. You may copy and distribute verbatim copies of the Library's complete source code as you receive it, in any medium, provided that you conspicuously and appropriately publish on each copy an appropriate copyright notice and disclaimer of warranty; keep intact all the notices that refer to this License and to the absence of any warranty; and distribute a copy of this License along with the Library.

You may charge a fee for the physical act of transferring a copy, and you may at your option offer warranty protection in exchange for a fee.

2. You may modify your copy or copies of the Library or any portion of it, thus forming a work based on the Library, and copy and distribute such modifications or work under the terms of Section 1 above, provided that you also meet all of these conditions:
 - a) The modified work must itself be a software library.
 - b) You must cause the files modified to carry prominent notices stating that you changed the files and the date of any change.
 - c) You must cause the whole of the work to be licensed at no charge to all third parties under the terms of this License.
 - d) If a facility in the modified Library refers to a function or a table of data to be supplied by an application program that uses the facility, other than as an argument passed when the facility is invoked, then you must make a good faith effort to ensure that, in the event an application does not supply such function or table, the facility still operates, and performs whatever part of its purpose remains meaningful.

(For example, a function in a library to compute square roots has a purpose that is entirely well-defined independent of the application. Therefore, Subsection 2d requires that any application-supplied function or table used by this function must be optional: if the application does not supply it, the square root function must still compute square roots.)

These requirements apply to the modified work as a whole. If identifiable sections of that work are not derived from the Library, and can be reasonably considered independent and separate works in themselves, then this License, and its terms, do not apply to those sections when you distribute them as separate works. But when you distribute the same sections as part of a whole which is a work based on the Library, the distribution of the whole must be on the terms of this License, whose permissions for other licensees extend to the entire whole, and thus to each and every part regardless of who wrote it.

Thus, it is not the intent of this section to claim rights or contest your rights to work written entirely by you; rather, the intent is to exercise the right to control the distribution of derivative or collective works based on the Library.

In addition, mere aggregation of another work not based on the Library with the Library (or with a work based on the Library) on a volume of a storage or distribution medium does not bring the other work under the scope of this License.

3. You may opt to apply the terms of the ordinary GNU General Public License instead of this License to a given copy of the Library. To do this, you must alter all the notices that refer to this License, so that they refer to the ordinary GNU General Public License, version 2, instead of to this License. (If a newer version than version 2 of the ordinary GNU General Public License has appeared, then you can specify that version instead if you wish.) Do not make any other change in these notices.

Once this change is made in a given copy, it is irreversible for that copy, so the ordinary GNU General Public License applies to all subsequent copies and derivative works made from that copy.

This option is useful when you wish to copy part of the code of the Library into a program that is not a library.

4. You may copy and distribute the Library (or a portion or derivative of it, under Section 2) in object code or executable form under the terms of Sections 1 and 2 above provided that you accompany it with the complete corresponding machine-readable source code, which must be distributed under the terms of Sections 1 and 2 above on a medium customarily used for software interchange.

If distribution of object code is made by offering access to copy from a designated place, then offering equivalent access to copy the source code from the same place satisfies the requirement to distribute the source code, even though third parties are not compelled to copy the source along with the object code.

5. A program that contains no derivative of any portion of the Library, but is designed to work with the Library by being compiled or linked with it, is called a "work that uses the Library". Such a work, in isolation, is not a derivative work of the Library, and therefore falls outside the scope of this License.

However, linking a "work that uses the Library" with the Library creates an executable that is a derivative of the Library (because it contains portions of the Library), rather than a "work that uses the library". The executable is therefore covered by this License. Section 6 states terms for distribution of such executables.

When a "work that uses the Library" uses material from a header file that is part of the Library, the object code for the work may be a derivative work of the Library even though the source code is not. Whether this is true is especially significant if the work can be linked without the Library, or if the work is itself a library. The threshold for this to be true is not precisely defined by law.

If such an object file uses only numerical parameters, data structure layouts and accessors, and small macros and small inline functions (ten lines or less in length), then the use of the object file is unrestricted, regardless of whether it is legally a derivative work. (Executables containing this object code plus portions of the Library will still fall under Section 6.)

Otherwise, if the work is a derivative of the Library, you may distribute the object code for the work under the terms of Section 6. Any executables containing that work also fall under Section 6, whether or not they are linked directly with the Library itself.

6. As an exception to the Sections above, you may also combine or link a "work that uses the Library" with the Library to produce a work containing portions of the Library, and distribute that work under terms of your choice, provided that the terms permit modification of the work for the customer's own use and reverse engineering for debugging such modifications.

You must give prominent notice with each copy of the work that the Library is used in it and that the Library and its use are covered by this License. You must supply a copy of this License. If the work during execution displays copyright notices, you must include the copyright notice for the Library among them, as well as a reference directing the user to the copy of this License. Also, you must do one of these things:

- a) Accompany the work with the complete corresponding machine-readable source code for the Library including whatever changes were used in the work (which must be distributed under Sections 1 and 2 above); and, if the work is an executable linked with the Library, with the complete machine-readable "work that uses the Library", as object code and/or source code, so that the user can modify the Library and then relink to produce a modified executable containing the modified Library. (It is understood that the user who changes the contents of definitions files in the Library will not necessarily be able to recompile the application to use the modified definitions.)
- b) Use a suitable shared library mechanism for linking with the Library. A suitable mechanism is one that (1) uses at run time a copy of the library already present on the user's computer system, rather than copying library functions into the executable, and (2) will operate properly with a modified version of the library, if the user installs one, as long as the modified version is interface-compatible with the version that the work was made with.
- c) Accompany the work with a written offer, valid for at least three years, to give the same user the materials specified in Subsection 6a, above, for a charge no more than the cost of performing this distribution.
- d) If distribution of the work is made by offering access to copy from a designated place, offer equivalent access to copy the above specified materials from the same place.
- e) Verify that the user has already received a copy of these materials or that you have already sent this user a copy.

For an executable, the required form of the "work that uses the Library" must include any data and utility programs needed for reproducing the executable from it. However, as a special exception, the materials to be distributed need not include anything that is normally distributed (in either source or binary form) with the major components (compiler, kernel, and so on) of the operating system on which the executable runs, unless that component itself accompanies the executable.

It may happen that this requirement contradicts the license restrictions of other proprietary libraries that do not normally accompany the operating system. Such a contradiction means you cannot use both them and the Library together in an executable that you distribute.

7. You may place library facilities that are a work based on the Library side-by-side in a single library together with other library facilities not covered by this License, and distribute such a combined library, provided that the separate distribution of the work based on the Library and of the other library facilities is otherwise permitted, and provided that you do these two things:
 - a) Accompany the combined library with a copy of the same work based on the Library, uncombined with any other library facilities. This must be distributed under the terms of the Sections above.
 - b) Give prominent notice with the combined library of the fact that part of it is a work based on the Library, and explaining where to find the accompanying uncombined form of the same work.
8. You may not copy, modify, sublicense, link with, or distribute the Library except as expressly provided under this License. Any attempt otherwise to copy, modify, sublicense, link with, or distribute the Library is void, and will automatically terminate your rights under this License. However, parties who have received copies, or rights, from you under this License will not have their licenses terminated so long as such parties remain in full compliance.
9. You are not required to accept this License, since you have not signed it. However, nothing else grants you permission to modify or distribute the Library or its derivative works. These actions are prohibited by law if you do not accept this License. Therefore, by modifying or distributing the Library (or any work based on the Library), you indicate your acceptance of this License to do so, and all its terms and conditions for copying, distributing or modifying the Library or works based on it.
10. Each time you redistribute the Library (or any work based on the Library), the recipient automatically receives a license from the original licensor to copy, distribute, link with or modify the Library subject to these terms and conditions. You may not impose any further restrictions on the recipients' exercise of the rights granted herein. You are not responsible for enforcing compliance by third parties with this License.
11. If, as a consequence of a court judgment or allegation of patent infringement or for any other reason (not limited to patent issues), conditions are imposed on you (whether by court order, agreement or otherwise) that contradict the conditions of this License, they do not excuse you from the conditions of this License. If you cannot distribute so as to satisfy simultaneously your obligations under this License and any other pertinent obligations, then as a consequence you may not distribute the Library at all. For example, if a patent license would not permit royalty-free redistribution of the Library by all those who receive copies directly or indirectly through you, then the only way you could satisfy both it and this License would be to refrain entirely from distribution of the Library.

If any portion of this section is held invalid or unenforceable under any particular circumstance, the balance of the section is intended to apply, and the section as a whole is intended to apply in other circumstances.

It is not the purpose of this section to induce you to infringe any patents or other property right claims or to contest validity of any such claims; this section has the sole purpose of protecting the integrity of the free software distribution system which is implemented by public license practices. Many people have made generous contributions to the wide range of software distributed through that system in reliance on consistent application of that system; it is up to the author/donor to decide if he or she is willing to distribute software through any other system and a licensee cannot impose that choice.

This section is intended to make thoroughly clear what is believed to be a consequence of the rest of this License.

12. If the distribution and/or use of the Library is restricted in certain countries either by patents or by copyrighted interfaces, the original copyright holder who places the Library under this License may add an explicit geographical distribution limitation excluding those countries, so that distribution is permitted only in or among countries not thus excluded. In such case, this License incorporates the limitation as if written in the body of this License.
13. The Free Software Foundation may publish revised and/or new versions of the Lesser General Public License from time to time. Such new versions will be similar in spirit to the present version, but may differ in detail to address new problems or concerns.

Each version is given a distinguishing version number. If the Library specifies a version number of this License which applies to it and "any later version", you have the option of following the terms and conditions either of that version or of any later version published by the Free Software Foundation. If the Library does not specify a license version number, you may choose any version ever published by the Free Software Foundation.

14. If you wish to incorporate parts of the Library into other free programs whose distribution conditions are incompatible with these, write to the author to ask for permission. For software which is copyrighted by the Free Software Foundation, write to the Free Software Foundation; we sometimes make exceptions for this. Our decision will be guided by the two goals of preserving the free status of all derivatives of our free software and of promoting the sharing and reuse of software generally.

NO WARRANTY

15. BECAUSE THE LIBRARY IS LICENSED FREE OF CHARGE, THERE IS NO WARRANTY FOR THE LIBRARY, TO THE EXTENT PERMITTED BY APPLICABLE LAW. EXCEPT WHEN OTHERWISE STATED IN WRITING THE COPYRIGHT HOLDERS AND/OR OTHER PARTIES PROVIDE THE LIBRARY "AS IS" WITHOUT WARRANTY OF ANY KIND, EITHER EXPRESSED OR IMPLIED, INCLUDING, BUT NOT LIMITED TO, THE IMPLIED WARRANTIES OF MERCHANTABILITY AND FITNESS FOR A PARTICULAR PURPOSE. THE ENTIRE RISK AS TO THE QUALITY AND PERFORMANCE OF THE LIBRARY IS WITH YOU. SHOULD THE LIBRARY PROVE DEFECTIVE, YOU ASSUME THE COST OF ALL NECESSARY SERVICING, REPAIR OR CORRECTION.
16. IN NO EVENT UNLESS REQUIRED BY APPLICABLE LAW OR AGREED TO IN WRITING WILL ANY COPYRIGHT HOLDER, OR ANY OTHER PARTY WHO MAY MODIFY AND/OR REDISTRIBUTE THE LIBRARY AS PERMITTED ABOVE, BE LIABLE TO YOU FOR DAMAGES, INCLUDING ANY GENERAL, SPECIAL, INCIDENTAL OR CONSEQUENTIAL DAMAGES ARISING OUT OF THE USE OR INABILITY TO USE THE LIBRARY (INCLUDING BUT NOT LIMITED TO LOSS OF DATA OR DATA BEING RENDERED INACCURATE OR LOSSES SUSTAINED BY YOU OR THIRD PARTIES OR A FAILURE OF THE LIBRARY TO OPERATE WITH ANY OTHER SOFTWARE), EVEN IF SUCH HOLDER OR OTHER PARTY HAS BEEN ADVISED OF THE POSSIBILITY OF SUCH DAMAGES.

END OF TERMS AND CONDITIONS

How to Apply These Terms to Your New Libraries

If you develop a new library, and you want it to be of the greatest possible use to the public, we recommend making it free software that everyone can redistribute and change. You can do so by permitting redistribution under these terms (or, alternatively, under the terms of the ordinary General Public License).

To apply these terms, attach the following notices to the library. It is safest to attach them to the start of each source file to most effectively convey the exclusion of warranty; and each file should have at least the "copyright" line and a pointer to where the full notice is found.

<one line to give the library's name and a brief idea of what it does.>
Copyright (C) <year> <name of author>

This library is free software; you can redistribute it and/or modify it under the terms of the GNU Lesser General Public License as published by the Free Software Foundation; either version 2.1 of the License, or (at your option) any later version.

This library is distributed in the hope that it will be useful, but WITHOUT ANY WARRANTY; without even the implied warranty of MERCHANTABILITY or FITNESS FOR A PARTICULAR PURPOSE. See the GNU Lesser General Public License for more details.

You should have received a copy of the GNU Lesser General Public License along with this library; if not, write to the Free Software Foundation, Inc., 51 Franklin Street, Fifth Floor, Boston, MA 02110-1301 USA

Also add information on how to contact you by electronic and paper mail.

You should also get your employer (if you work as a programmer) or your school, if any, to sign a "copyright disclaimer" for the library, if necessary. Here is a sample; alter the names:

Yoyodyne, Inc., hereby disclaims all copyright interest in the library `Frob' (a library for tweaking knobs) written by James Random Hacker.

<signature of Ty Coon>, 1 April 1990

Ty Coon, President of Vice

That's all there is to it!

BSD License (Berkeley Software Distribution License)

This projector product includes the open source software program "University of California, Berkeley License (Berkeley Software Distribution License)" which applies the terms and conditions provided by owner of the copyright to the "BSD License".

The "BSD License" are WITHOUT ANY WARRANTY; without even the implied warranty of MERCHANTABILITY AND FITNESS FOR A PARTICULAR PURPOSE.

List of BSD License programs

busybox_1.7.2

License terms of conditions of each program which are provided by owner of the copyright to the "BSD License" are as follows.

Copyright (c) The Regents of the University of California. All rights reserved.

This code is derived from software contributed to Berkeley by Kenneth Almquist.

Redistribution and use in source and binary forms, with or without modification, are permitted provided that the following conditions are met:

1. Redistributions of source code must retain the above copyright notice, this list of conditions and the following disclaimer.
2. Redistributions in binary form must reproduce the above copyright notice, this list of conditions and the following disclaimer in the documentation and/or other materials provided with the distribution.
3. Neither the name of the University nor the names of its contributors may be used to endorse or promote products derived from this software without specific prior written permission.

THIS SOFTWARE IS PROVIDED BY THE REGENTS AND CONTRIBUTORS "AS IS" AND ANY EXPRESS OR IMPLIED WARRANTIES, INCLUDING, BUT NOT LIMITED TO, THE IMPLIED WARRANTIES OF MERCHANTABILITY AND FITNESS FOR A PARTICULAR PURPOSE ARE DISCLAIMED. IN NO EVENT SHALL THE REGENTS OR CONTRIBUTORS BE LIABLE FOR ANY DIRECT, INDIRECT, INCIDENTAL, SPECIAL, EXEMPLARY, OR CONSEQUENTIAL DAMAGES (INCLUDING, BUT NOT LIMITED TO, PROCUREMENT OF SUBSTITUTE GOODS OR SERVICES; LOSS OF USE, DATA, OR PROFITS; OR BUSINESS INTERRUPTION) HOWEVER CAUSED AND ON ANY THEORY OF LIABILITY, WHETHER IN CONTRACT, STRICT LIABILITY, OR TORT (INCLUDING NEGLIGENCE OR OTHERWISE) ARISING IN ANY WAY OUT OF THE USE OF THIS SOFTWARE, EVEN IF ADVISED OF THE POSSIBILITY OF SUCH DAMAGE.

libjpeg

This projector product includes the open source software program "libjpeg" which applies the terms and conditions provided by owner of the copyright to the "libjpeg".

The "libjpeg" are WITHOUT ANY WARRANTY; without even the implied warranty of MERCHANTABILITY AND FITNESS FOR A PARTICULAR PURPOSE.

List of libjpeg programs

libjpeg-6b

License terms of conditions of each program which are provided by owner of the copyright to the "libjpeg" are as follows.

Copyright (C) 1994-1997, Thomas G. Lane. This file is part of the Independent JPEG Group's software. For conditions of distribution and use, see the accompanying README file.

This distribution contains the sixth public release of the Independent JPEG Group's free JPEG software. You are welcome to redistribute this software and to use it for any purpose, subject to the conditions under LEGAL ISSUES, below.

LEGAL ISSUES

=====

In plain English:

1. We don't promise that this software works. (But if you find any bugs, please let us know!)
2. You can use this software for whatever you want. You don't have to pay us.
3. You may not pretend that you wrote this software. If you use it in a program, you must acknowledge somewhere in your documentation that you've used the IJG code.

In legalese:

The authors make NO WARRANTY or representation, either express or implied, with respect to this software, its quality, accuracy, merchantability, or fitness for a particular purpose. This software is provided "AS IS", and you, its user, assume the entire risk as to its quality and accuracy.

This software is copyright (C) 1991-1998, Thomas G. Lane. All Rights Reserved except as specified below.

Permission is hereby granted to use, copy, modify, and distribute this software (or portions thereof) for any purpose, without fee, subject to these conditions:

- (1) If any part of the source code for this software is distributed, then this README file must be included, with this copyright and no-warranty notice unaltered; and any additions, deletions, or changes to the original files must be clearly indicated in accompanying documentation.
- (2) If only executable code is distributed, then the accompanying documentation must state that "this software is based in part on the work of the Independent JPEG Group".
- (3) Permission for use of this software is granted only if the user accepts full responsibility for any undesirable consequences; the authors accept NO LIABILITY for damages of any kind.

These conditions apply to any software derived from or based on the IJG code, not just to the unmodified library. If you use our work, you ought to acknowledge us.

Permission is NOT granted for the use of any IJG author's name or company name in advertising or publicity relating to this software or products derived from it. This software may be referred to only as "the Independent JPEG Group's software".

We specifically permit and encourage the use of this software as the basis of commercial products, provided that all warranty or liability claims are assumed by the product vendor.

ansi2knr.c is included in this distribution by permission of L. Peter Deutsch, sole proprietor of its copyright holder, Aladdin Enterprises of Menlo Park, CA. ansi2knr.c is NOT covered by the above copyright and conditions, but instead by the usual distribution terms of the Free Software Foundation; principally, that you must include source code if you redistribute it. (See the file ansi2knr.c for full details.) However, since ansi2knr.c is not needed as part of any program generated from the IJG code, this does not limit you more than the foregoing paragraphs do.

The Unix configuration script "configure" was produced with GNU Autoconf. It is copyright by the Free Software Foundation but is freely distributable. The same holds for its supporting scripts (config.guess, config.sub, ltconfig, ltmain.sh). Another support script, install-sh, is copyright by M.I.T. but is also freely distributable.

It appears that the arithmetic coding option of the JPEG spec is covered by patents owned by IBM, AT&T, and Mitsubishi. Hence arithmetic coding cannot legally be used without obtaining one or more licenses. For this reason, support for arithmetic coding has been removed from the free JPEG software. (Since arithmetic coding provides only a marginal gain over the unpatented Huffman mode, it is unlikely that very many implementations will support it.) So far as we are aware, there are no patent restrictions on the remaining code.

The IJG distribution formerly included code to read and write GIF files. To avoid entanglement with the Unisys LZW patent, GIF reading support has been removed altogether, and the GIF writer has been simplified to produce "uncompressed GIFs". This technique does not use the LZW algorithm; the resulting GIF files are larger than usual, but are readable by all standard GIF decoders.

We are required to state that

"The Graphics Interchange Format(c) is the Copyright property of CompuServe Incorporated. GIF(sm) is a Service Mark property of CompuServe Incorporated."

libpng

This projector product includes the open source software program "libpng" which applies the terms and conditions provided by owner of the copyright to the "libpng".

The "libpng" are WITHOUT ANY WARRANTY; without even the implied warranty of MERCHANTABILITY AND FITNESS FOR A PARTICULAR PURPOSE.

List of libpng programs

libpng-1.2.7

License terms of conditions of each program which are provided by owner of the copyright to the "libpng" are as follows.

For conditions of distribution and use, see copyright notice in png.h Copyright (c) 1998-2004 Glenn Randers-Pehrson (Version 0.96 Copyright (c) 1996, 1997 Andreas Dilger) (Version 0.88 Copyright (c) 1995, 1996 Guy Eric Schalnat, Group 42, Inc.)

This copy of the libpng notices is provided for your convenience. In case of any discrepancy between this copy and the notices in the file png.h that is included in the libpng distribution, the latter shall prevail.

COPYRIGHT NOTICE, DISCLAIMER, and LICENSE:

If you modify libpng you may insert additional notices immediately following this sentence.

libpng version 1.2.6, September 12, 2004, is Copyright (c) 2004 Glenn Randers-Pehrson, and is distributed according to the same disclaimer and license as libpng-1.2.5 with the following individual added to the list of Contributing Authors

Cosmin Truta

libpng versions 1.0.7, July 1, 2000, through 1.2.5 - October 3, 2002, are Copyright (c) 2000-2002 Glenn Randers-Pehrson, and are distributed according to the same disclaimer and license as libpng-1.0.6 with the following individuals added to the list of Contributing Authors

Simon-Pierre Cadieux

Eric S. Raymond

Gilles Vollant

and with the following additions to the disclaimer:

There is no warranty against interference with your enjoyment of the library or against infringement. There is no warranty that our efforts or the library will fulfill any of your particular purposes or needs. This library is provided with all faults, and the entire risk of satisfactory quality, performance, accuracy, and effort is with the user.

libpng versions 0.97, January 1998, through 1.0.6, March 20, 2000, are Copyright (c) 1998, 1999 Glenn Randers-Pehrson, and are distributed according to the same disclaimer and license as libpng-0.96, with the following individuals added to the list of Contributing Authors:

Tom Lane
Glenn Randers-Pehrson
Willem van Schaik

libpng versions 0.89, June 1996, through 0.96, May 1997, are Copyright (c) 1996, 1997 Andreas Dilger Distributed according to the same disclaimer and license as libpng-0.88, with the following individuals added to the list of Contributing Authors:

John Bowler
Kevin BraceySam Bushell
Sam Bushell
Magnus Holmgren
Greg Roelofs
Tom Tanner

libpng versions 0.5, May 1995, through 0.88, January 1996, are Copyright (c) 1995, 1996 Guy Eric Schalnat, Group 42, Inc.

For the purposes of this copyright and license, "Contributing Authors" is defined as the following set of individuals:

Andreas Dilger
Dave Martindale
Guy Eric Schalnat
Paul Schmidt
Tim Wegner

The PNG Reference Library is supplied "AS IS". The Contributing Authors and Group 42, Inc. disclaim all warranties, expressed or implied, including, without limitation, the warranties of merchantability and of fitness for any purpose. The Contributing Authors and Group 42, Inc. assume no liability for direct, indirect, incidental, special, exemplary, or consequential damages, which may result from the use of the PNG Reference Library, even if advised of the possibility of such damage.

Permission is hereby granted to use, copy, modify, and distribute this source code, or portions hereof, for any purpose, without fee, subject to the following restrictions:

1. The origin of this source code must not be misrepresented.
2. Altered versions must be plainly marked as such and must not be misrepresented as being the original source.
3. This Copyright notice may not be removed or altered from any source or altered source distribution.

The Contributing Authors and Group 42, Inc. specifically permit, without fee, and encourage the use of this source code as a component to supporting the PNG file format in commercial products. If you use this source code in a product, acknowledgment is not required but would be appreciated.

A "png_get_copyright" function is available, for convenient use in "about" boxes and the like:

```
printf("%s",png_get_copyright(NULL));
```

Also, the PNG logo (in PNG format, of course) is supplied in the files "pngbar.png" and "pngbar.jpg (88x31) and "pngnow.png" (98x31).

Libpng is OSI Certified Open Source Software. OSI Certified Open Source is a certification mark of the Open Source Initiative.

Glenn Randers-Pehrson
glennrp@users.sourceforge.net
September 12, 2004

zlib

This projector product includes the open source software program "zlib" which applies the terms and conditions provided by owner of the copyright to the "zlib".

The "zlib" are WITHOUT ANY WARRANTY; without even the implied warranty of MERCHANTABILITY AND FITNESS FOR A PARTICULAR PURPOSE.

List of zlib programs

zlib-1.1.4

License terms of conditions of each program which are provided by owner of the copyright to the "zlib" are as follows.

Copyright notice:

(C) 1995-1998 Jean-loup Gailly and Mark Adler

This software is provided 'as-is', without any express or implied warranty. In no event will the authors be held liable for any damages arising from the use of this software.

Permission is granted to anyone to use this software for any purpose, including commercial applications, and to alter it and redistribute it freely, subject to the following restrictions:

1. The origin of this software must not be misrepresented; you must not claim that you wrote the original software. If you use this software in a product, an acknowledgment in the product documentation would be appreciated but is not required.
2. Altered source versions must be plainly marked as such, and must not be misrepresented as being the original software.
3. This notice may not be removed or altered from any source distribution.

Jean-loup Gailly
jloup@gzip.org

Mark Adler
madler@alumni.caltech.edu

If you use the zlib library in a product, we would appreciate *not* receiving lengthy legal documents to sign. The sources are provided for free but without warranty of any kind. The library has been entirely written by Jean-loup Gailly and Mark Adler; it does not include third-party code.

If you redistribute modified sources, we would appreciate that you include in the file ChangeLog history information documenting your changes.

libmd5-rfc

This projector product includes the open source software program "libmd5-rfc" which applies the terms and conditions provided by owner of the copyright to the "libmd5-rfc".

The "libmd5-rfc" are WITHOUT ANY WARRANTY; without even the implied warranty of MERCHANTABILITY AND FITNESS FOR A PARTICULAR PURPOSE.

List of libmd5-rfc programs

libmd5-rfc

License terms of conditions of each program which are provided by owner of the copyright to the "libmd5-rfc" are as follows.

Copyright (C) 1999, 2002 Aladdin Enterprises. All rights reserved.

This software is provided 'as-is', without any express or implied warranty. In no event will the authors be held liable for any damages arising from the use of this software.

Permission is granted to anyone to use this software for any purpose, including commercial applications, and to alter it and redistribute it freely, subject to the following restrictions:

1. The origin of this software must not be misrepresented; you must not claim that you wrote the original software. If you use this software in a product, an acknowledgment in the product documentation would be appreciated but is not required.
2. Altered source versions must be plainly marked as such, and must not be misrepresented as being the original software.
3. This notice may not be removed or altered from any source distribution.

L. Peter Deutsch ghost@aladdin.com

Independent implementation of MD5 (RFC 1321).

This code implements the MD5 Algorithm defined in RFC 1321, whose text is available at

<http://www.ietf.org/rfc/rfc1321.txt>

The code is derived from the text of the RFC, including the test suite (section A.5) but excluding the rest of Appendix A. It does not include any code or documentation that is identified in the RFC as being copyrighted.

The original and principal author of md5.h is L. Peter Deutsch <ghost@aladdin.com>. Other authors are noted in the change history that follows (in reverse chronological order):

- 2002-04-13 lpd Removed support for non-ANSI compilers; removed references to Ghostscript; clarified derivation from RFC 1321; now handles byte order either statically or dynamically.
- 1999-11-04 lpd Edited comments slightly for automatic TOC extraction.
- 1999-10-18 lpd Fixed typo in header comment (ansi2knr rather than md5); added conditionalization for C++ compilation from Martin Purschke <purschke@bnl.gov>.
- 1999-05-03 lpd Original version.

ncurses

This projector product includes the open source software program "ncurses" which applies the terms and conditions provided by owner of the copyright to the "ncurses".

The "ncurses" are WITHOUT ANY WARRANTY; without even the implied warranty of MERCHANTABILITY AND FITNESS FOR A PARTICULAR PURPOSE.

List of ncurses programs

ncurses-5.6

License terms of conditions of each program which are provided by owner of the copyright to the "ncurses" are as follows.

Copyright (c) 1998-2002,2003 Free Software Foundation, Inc.

Permission is hereby granted, free of charge, to any person obtaining a copy of this software and associated documentation files (the "Software"), to deal in the Software without restriction, including without limitation the rights to use, copy, modify, merge, publish, distribute, distribute with modifications, sublicense, and/or sell copies of the Software, and to permit persons to whom the Software is furnished to do so, subject to the following conditions:

The above copyright notice and this permission notice shall be included in all copies or substantial portions of the Software.

THE SOFTWARE IS PROVIDED "AS IS", WITHOUT WARRANTY OF ANY KIND, EXPRESS OR IMPLIED, INCLUDING BUT NOT LIMITED TO THE WARRANTIES OF MERCHANTABILITY, FITNESS FOR A PARTICULAR PURPOSE AND NONINFRINGEMENT. IN NO EVENT SHALL THE ABOVE COPYRIGHT HOLDERS BE LIABLE FOR ANY CLAIM, DAMAGES OR OTHER LIABILITY, WHETHER IN AN ACTION OF CONTRACT, TORT OR OTHERWISE, ARISING FROM, OUT OF OR IN CONNECTION WITH THE SOFTWARE OR THE USE OR OTHER DEALINGS IN THE SOFTWARE.

Except as contained in this notice, the name(s) of the above copyright holders shall not be used in advertising or otherwise to promote the sale, use or other dealings in this Software without prior written authorization.

mDNSResponder

This projector product includes the open source software program "mDNSResponder" which applies the following license terms "Apache License Version 2.0, January 2004".

List of "mDNSResponder"

mDNSResponder-107.6 (only mDNSResponderPosix is used)

License terms "Apache License Version 2.0, January 2004" are as follows.

Apache License

Version 2.0, January 2004

<http://www.apache.org/licenses/>

TERMS AND CONDITIONS FOR USE, REPRODUCTION, AND DISTRIBUTION

1. Definitions.

"License" shall mean the terms and conditions for use, reproduction, and distribution as defined by Sections 1 through 9 of this document.

"Licensor" shall mean the copyright owner or entity authorized by the copyright owner that is granting the License.

"Legal Entity" shall mean the union of the acting entity and all other entities that control, are controlled by, or are under common control with that entity. For the purposes of this definition, "control" means (i) the power, direct or indirect, to cause the direction or management of such entity, whether by contract or otherwise, or (ii) ownership of fifty percent (50%) or more of the outstanding shares, or (iii) beneficial ownership of such entity.

"You" (or "Your") shall mean an individual or Legal Entity exercising permissions granted by this License.

"Source" form shall mean the preferred form for making modifications, including but not limited to software source code, documentation source, and configuration files.

"Object" form shall mean any form resulting from mechanical transformation or translation of a Source form, including but not limited to compiled object code, generated documentation, and conversions to other media types.

"Work" shall mean the work of authorship, whether in Source or Object form, made available under the License, as indicated by a copyright notice that is included in or attached to the work (an example is provided in the Appendix below).

"Derivative Works" shall mean any work, whether in Source or Object form, that is based on (or derived from) the Work and for which the editorial revisions, annotations, elaborations, or other modifications represent, as a whole, an original work of authorship. For the purposes of this License, Derivative Works shall not include works that remain separable from, or merely link (or bind by name) to the interfaces of, the Work and Derivative Works thereof.

"Contribution" shall mean any work of authorship, including the original version of the Work and any modifications or additions to that Work or Derivative Works thereof, that is intentionally submitted to Licensor for inclusion in the Work by the copyright owner or by an individual or Legal Entity authorized to submit on behalf of the copyright owner. For the purposes of this definition, "submitted" means any form of electronic, verbal, or written communication sent to the Licensor or its representatives, including but not limited to communication on electronic mailing lists, source code control systems, and issue tracking systems that are managed by, or on behalf of, the Licensor for the purpose of discussing and improving the Work, but excluding communication that is conspicuously marked or otherwise designated in writing by the copyright owner as "Not a Contribution."

"Contributor" shall mean Licensor and any individual or Legal Entity on behalf of whom a Contribution has been received by Licensor and subsequently incorporated within the Work.

2. **Grant of Copyright License.** Subject to the terms and conditions of this License, each Contributor hereby grants to You a perpetual, worldwide, non-exclusive, no-charge, royalty-free, irrevocable copyright license to reproduce, prepare Derivative Works of, publicly display, publicly perform, sublicense, and distribute the Work and such Derivative Works in Source or Object form.
3. **Grant of Patent License.** Subject to the terms and conditions of this License, each Contributor hereby grants to You a perpetual, worldwide, non-exclusive, no-charge, royalty-free, irrevocable (except as stated in this section) patent license to make, have made, use, offer to sell, sell, import, and otherwise transfer the Work, where such license applies only to those patent claims licensable by such Contributor that are necessarily infringed by their Contribution(s) alone or by combination of their Contribution(s) with the Work to which such Contribution(s) was submitted. If You institute patent litigation against any entity (including a cross-claim or counterclaim in a lawsuit) alleging that the Work or a Contribution incorporated within the Work constitutes direct or contributory patent infringement, then any patent licenses granted to You under this License for that Work shall terminate as of the date such litigation is filed.
4. **Redistribution.** You may reproduce and distribute copies of the Work or Derivative Works thereof in any medium, with or without modifications, and in Source or Object form, provided that You meet the following conditions:
 - (a) You must give any other recipients of the Work or Derivative Works a copy of this License; and
 - (b) You must cause any modified files to carry prominent notices stating that You changed the files; and
 - (c) You must retain, in the Source form of any Derivative Works that You distribute, all copyright, patent, trademark, and attribution notices from the Source form of the Work, excluding those notices that do not pertain to any part of the Derivative Works; and

- (d) If the Work includes a "NOTICE" text file as part of its distribution, then any Derivative Works that You distribute must include a readable copy of the attribution notices contained within such NOTICE file, excluding those notices that do not pertain to any part of the Derivative Works, in at least one of the following places: within a NOTICE text file distributed as part of the Derivative Works; within the Source form or documentation, if provided along with the Derivative Works; or, within a display generated by the Derivative Works, if and wherever such third-party notices normally appear. The contents of the NOTICE file are for informational purposes only and do not modify the License. You may add Your own attribution notices within Derivative Works that You distribute, alongside or as an addendum to the NOTICE text from the Work, provided that such additional attribution notices cannot be construed as modifying the License.

You may add Your own copyright statement to Your modifications and may provide additional or different license terms and conditions for use, reproduction, or distribution of Your modifications, or for any such Derivative Works as a whole, provided Your use, reproduction, and distribution of the Work otherwise complies with the conditions stated in this License.

5. Submission of Contributions. Unless You explicitly state otherwise, any Contribution intentionally submitted for inclusion in the Work by You to the Licensor shall be under the terms and conditions of this License, without any additional terms or conditions.

Notwithstanding the above, nothing herein shall supersede or modify the terms of any separate license agreement you may have executed with Licensor regarding such Contributions.

6. Trademarks. This License does not grant permission to use the trade names, trademarks, service marks, or product names of the Licensor, except as required for reasonable and customary use in describing the origin of the Work and reproducing the content of the NOTICE file.
7. Disclaimer of Warranty. Unless required by applicable law or agreed to in writing, Licensor provides the Work (and each Contributor provides its Contributions) on an "AS IS" BASIS, WITHOUT WARRANTIES OR CONDITIONS OF ANY KIND, either express or implied, including, without limitation, any warranties or conditions of TITLE, NON-INFRINGEMENT, MERCHANTABILITY, or FITNESS FOR A PARTICULAR PURPOSE. You are solely responsible for determining the appropriateness of using or redistributing the Work and assume any risks associated with Your exercise of permissions under this License.
8. Limitation of Liability. In no event and under no legal theory, whether in tort (including negligence), contract, or otherwise, unless required by applicable law (such as deliberate and grossly negligent acts) or agreed to in writing, shall any Contributor be liable to You for damages, including any direct, indirect, special, incidental, or consequential damages of any character arising as a result of this License or out of the use or inability to use the Work (including but not limited to damages for loss of goodwill, work stoppage, computer failure or malfunction, or any and all other commercial damages or losses), even if such Contributor has been advised of the possibility of such damages.

9. Accepting Warranty or Additional Liability. While redistributing the Work or Derivative Works thereof, You may choose to offer, and charge a fee for, acceptance of support, warranty, indemnity, or other liability obligations and/or rights consistent with this License. However, in accepting such obligations, You may act only on Your own behalf and on Your sole responsibility, not on behalf of any other Contributor, and only if You agree to indemnify, defend, and hold each Contributor harmless for any liability incurred by, or claims asserted against, such Contributor by reason of your accepting any such warranty or additional liability.

END OF TERMS AND CONDITIONS

APPENDIX: How to apply the Apache License to your work.

To apply the Apache License to your work, attach the following boilerplate notice, with the fields enclosed by brackets "[]" replaced with your own identifying information. (Don't include the brackets!) The text should be enclosed in the appropriate comment syntax for the file format. We also recommend that a file or class name and description of purpose be included on the same "printed page" as the copyright notice for easier identification within third-party archives.

Copyright [yyyy][name of copyright owner]

Licensed under the Apache License, Version 2.0 (the "License");

you may not use this file except in compliance with the License.

You may obtain a copy of the License at

<http://www.apache.org/licenses/LICENSE-2.0>

Unless required by applicable law or agreed to in writing, software distributed under the License is distributed on an "AS IS" BASIS, WITHOUT WARRANTIES OR CONDITIONS OF ANY KIND, either express or implied.

See the License for the specific language governing permissions and limitations under the License.

Index

A

- A/V Mute, 34, 115, 136
- Access Point mode, 78 to 88
- Access point, checking IP address of, 85 to 86
- Accessories, 13
- Ad Hoc mode, 71 to 77
- Adapter, audio, 60
- Air filter
 - cleaning, 121
 - ordering, 13
 - replacing, 126 to 127
- AirPort, configuring for wireless, 76 to 77, 86 to 88
- Altitude, 117, 156
- Anti-theft device, 13, 21
- Aspect ratio, 36 to 37, 154
- Aspect setting, 36 to 37, 107
- Audio
 - adapter, 60
 - connecting equipment, 59 to 61
 - controlling volume, 35
 - problems, troubleshooting, 144 to 145
 - turning off (using A/V Mute), 34
- Auto button, 30
- Auto Iris setting, 105
- Auto Keystone setting, 108
- Auto Setup setting, 106

B

- Bands, vertical, 143
- Blackboard color mode, 38
- Blackboard, projecting on, 38
- Blank screen, 136 to 138
- Blurry image, 142
- Brightness, 153
- Brightness setting, 104
- Browser control, 97

C

- Cables
 - Component-to-VGA, 13, 56
 - Ethernet, 64
 - illustrations, 10
 - mouse, 51
 - ordering, 13
 - S-video, 13, 55
 - USB, 10, 50, 51
- Capturing image, 114 to 115
- Carrying case, 10, 13, 129
- Ceiling mount, 13, 151 to 152
- Cleaning
 - air filter, 121
 - lens, 120
 - projector case, 120
- Closed captioning, 116
- Color
 - correcting, 38
 - mode, 38, 104
 - problems, 143
 - saturation, 105
 - settings, 104 to 105
 - temperature, 105
- Color Adjustment setting, 105
- Color Mode setting, 38, 104
- Component video cable, 13, 54, 56
- Composite (RCA) video cable, 54 to 55
- Computer
 - connecting, 48 to 52
 - correcting images, 30
 - selecting source, 25 to 26
- Connecting projector
 - ports, 11
 - to a computer, 48 to 52
 - to a digital camera, 58 to 59
 - to a document camera, 58 to 59
 - to a USB device, 58 to 59
 - to audio equipment, 59 to 61
 - to video equipment, 54 to 57

Contrast setting, 104
Control Panel Lock setting, 108, 115

D

Data encryption, 92
Default settings, restoring, 103
DHCP, 79, 83, 87, 146, 147
Digital camera, connecting, 58 to 59
Direct Power On, 24, 117
Distance from projector to screen, 16, 154
Document camera
 connecting, 58 to 59
 ordering, 13
Documentation, 8 to 9
DVD player, connecting, 54 to 57
Dynamic color mode, 38

E

EasyMP Monitor, 63
EasyMP Network Projection
 configuring projector for, 78 to 92
 creating password for, 70
 network projection, 63 to 93
 problems, 145 to 147
Electrical specifications, 155
E-mail alerts, 94 to 96
Encryption, 76, 82, 89 to 90, 92
Environmental specifications, 156
Epson
 accessories, 13
 PrivateLine Support, 9
 technical support, 9, 149 to 150
Ethernet cable, 64 to 66
Extended menu, 116 to 118
External monitor, connecting, 53
E-Zoom button, 35

F

FCC compliance statement, 163
Filter, *see* Air filter
Focusing image, 27
Freeze button, 34

G

Gateway address, checking, 85

H

HDTV images, video formats, 158
Height of image, adjusting, 27
Help system, using, 132
Help, Epson, 9, 149 to 150
High altitude, 117

I

Image
 adjusting, 26 to 30, 104 to 105
 blurry, 142
 capturing and saving in projector,
 114 to 115
 correcting shape, 28 to 29, 108, 141
 fitting on screen, 106, 140
 height, adjusting, 27
 positioning, 107
 problems with, 136 to 144
 projecting on chalkboard, 38
 raising, 27
 selecting source, 25 to 26, 33, 55 to 57
 size and projection distance, 16, 154
 turning off (using A/V Mute), 34
 zooming, 27, 35
Image menu, 104 to 105
Info menu, 135
Infrastructure mode, *see* Access Point mode
Input Signal setting, 107
Input signal, selecting, 25 to 26, 33, 55 to 57
Installing projector, 151 to 152
Instant Off, 25

K

Kensington anti-theft device, 13, 21
Keystone correction, 28 to 29, 108, 141, 154
Keyword, 70

L

Lamp

- number of hours used, 135
- ordering, 13
- replacing, 122 to 128
- specifications, 154
- status light, 133

Lamp timer, resetting, 128

LAN button, 26, 33

Language setting, 118

Laptop computer

- connecting, 49 to 51
- display problems, 136 to 140
- selecting source, 25 to 26, 33

Lens cover timer, 117

Lens, cleaning, 120

Lights, status, 133

Logo, saving on projector, 114 to 115

M

Mac

- configuring for wireless, 76 to 77, 86 to 88
- display problems, 138
- resolution setting, 140

Manuals, 8 to 9

Menus

- changing settings, 102 to 103
- default settings, restoring, 103 to 104
- Extended, 116 to 118
- Image, 104 to 105
- Info, 135
- Network, 65, 69
- Settings, 108 to 109
- Signal, 106 to 107

Message Broadcasting, 8

Mic Input Level setting, 109

Microphone, connecting, 60

Monitor, connecting, 53

Monitoring projector

- EasyMP Monitor, 63
- e-mail notifications, 94 to 96
- SNMP, 96 to 97
- using browser, 97

Mouse

- compatibility, 154
- connecting cable for remote, 51 to 52
- using remote control as, 41

N

Network

- managing projector remotely, 94 to 100
- problems, 145 to 147
- security, 88 to 92
- settings, 64 to 97
- wired, 64 to 66
- wireless, 67 to 93

No Signal message, 137 to 138

Noise level, 154

Not Supported message, 138

Notebook computer, *see* Laptop computer

Numeric keypad, using, 111

O

Optical aspect ratio, 154

Options for projector, 13

P

Password

- default, 111
- protection, 111 to 113
- remote access, 70
- request code, 113

Pattern

- capturing and saving in projector, 40
- displaying, 39

Photo color mode, 38

Picture source, selecting, 25 to 26, 33, 55 to 57

Picture, *see* Image

Pointer Shape setting, 108

Pointer tool, using, 42

Positioning
 image, 27
 projector, 16 to 22, 151 to 152

Power
 button, 24
 specifications, 155
 status light, 24, 133

PowerPoint, 43

Presentation color mode, 38

Presentations
 computer, 30, 48 to 52
 digital camera, 58 to 59
 document camera, 58 to 59
 room conditions, 16, 32
 USB device, 58 to 59
 using the pointer tool, 42
 video, 54 to 57
 wireless, 63 to 93

PrivateLine Support, 9

Problems
 color, 143
 connecting wirelessly, 145 to 147
 image, 136 to 144
 network, 145 to 147
 no signal, 137 to 138
 remote control, 148
 sound, 144 to 145
 using on-screen help, 132

Progressive format, 107

Projecting without screen, 38

Projection lamp, *see* Lamp

Projector
 carrying case, 10, 13, 129
 cleaning, 120
 disabling buttons, 115
 distance from screen, 16, 154
 installing, 151 to 152
 lamp specifications, 154
 monitoring remotely, 94 to 100
 options, 13
 parts, 11
 password protection, 111 to 113
 positioning, 16 to 22
 resolution, 153
 specifications, 153 to 156
 transporting, 129
 troubleshooting, 131 to 148
 turning off, 25
 turning on, 22 to 24
 unpacking, 10
 viewing information about, 135

Q

Quick Wireless Connection
 ordering key, 13
 troubleshooting, 145
 using, 68 to 69

R

Raising image, 27
Rear-screen projection, 116, 151 to 152
Registration, 9

- Remote control
 - A/V Mute button, 34
 - as wireless mouse, 41
 - battery used, 154
 - connecting cable for mouse, 51 to 52
 - correcting color, 38
 - E-Zoom button, 35
 - Freeze button, 34
 - numeric keypad, using, 111
 - pointer tool, using, 42
 - problems, 148
 - range, 154
 - replacing batteries, 32
 - specifications, 154
 - switching sources, 33
 - troubleshooting, 148
 - virtual over network, 99
- Removing wireless module, 93
- Replacing
 - air filter, 126 to 127
 - lamp, 122 to 128
- Request code, password, 113
- Resetting lamp timer, 128
- Resetting menu options, 103
- Resize image, 36 to 37
- Resolution, 138, 153
- Resolution setting, 106

S

- Safety
 - instructions, 2, 159 to 162
 - specifications, 156
- Saturation setting, 105
- Screen
 - blank, 136 to 138
 - distance from projector, 16, 154
 - ordering, 13
 - startup screen, creating, 114 to 115
- Screen image, *See* Image

- Security
 - attaching lock, 11
 - control panel lock, 115
 - Kensington lock, 13
 - network, 88 to 92
 - password protection, 111 to 113
 - startup screen, 114 to 115
- Settings menu, 108 to 109
- Sharpness setting, 105
- Signal menu, 106 to 107
- Sleep mode, 23, 117
- Slideshow
 - options, 46
 - running, 43 to 45
- SNMP, 96 to 97
- Sound, troubleshooting, 144 to 145
- Source
 - selecting, 25 to 26, 33
 - viewing, 135
- Speaker, specifications, 154
- Speakers, connecting, 61
- Specifications
 - brightness, 153
 - dimensions, 155
 - electrical, 155
 - environmental, 156
 - general, 153
 - lamp, 154
 - remote control, 154
 - resolution, 153
 - safety, 156
- Sports color mode, 38
- sRGB color mode, 38
- SSID, 73, 76, 82, 87, 146
- Startup screen, creating, 114 to 115
- Status lights, 133
- Support, *see* Technical support
- S-video cable, 13, 55
- Switching picture source, 25 to 26, 33
- Sync setting, 106
- Synchronization, adjusting, 30, 143

T

- Technical support, 9, 149 to 150
- Temperature
 - requirements, 156
 - status light, 133
- Temperature, color, 105
- Test pattern, displaying, 29, 109
- Theatre color mode, 38
- Tint setting, 105
- Tracking, adjusting, 30, 106, 143
- Transporting projector, 129
- Troubleshooting
 - blank screen, 136 to 138
 - cut-off image, 140
 - distorted image, 28 to 29
 - image and sound problems, 136 to 145
 - network problems, 145 to 147
 - no signal, 137 to 138
 - projector problems, 131 to 148
 - remote control problems, 148
 - wireless projection problems, 145 to 147
- Turning off picture (using A/V Mute), 34
- Turning on/off projector, 22 to 25

U

- Unpacking projector, 10
- USB
 - button, 51
 - cable, 10, 50, 51
 - display, 50 to 51
 - flash memory drive, 58 to 59
 - key, 68 to 69
 - setting, 118
- User button, 109
- User's Logo setting, 114 to 115

V

- VCR, connecting, 54 to 57
- Video
 - cables, 10, 13, 54
 - connecting video equipment, 54 to 57
 - display settings, viewing, 135
 - formats, supported, 157 to 158
 - selecting source, 25 to 26, 33, 55
- Video Signal setting, 107
- Volume, controlling, 35

W

- Warning lights, 133
- Warranty, 9
- Web browser control, 97
- Web Remote Control, 99
- WEP encryption, 89 to 90
- Whiteboard color mode, 38
- Windows
 - configuring for wireless, 74 to 76, 80 to 84
 - display problems, 138
 - resolution setting, 140
- Wired network, 64 to 66
- Wireless
 - module, 13, 67 to 68, 93
 - presentation, 63 to 93
 - problems, 145 to 147
 - Quick Wireless Connection, 68 to 69
 - security, 88 to 92
 - WEP encryption, 89 to 90
 - WPA security, 91 to 92
- Wireless mouse, 41, 51 to 52
- WPA security, 91 to 92

Z

- Zoom ratio, 154
- Zooming image, 27, 35

EPSON®
EXCEED YOUR VISION