

EPSON®

PowerLite® 5550C/7550C

User's Guide

Copyright Notice

All rights reserved. No part of this publication may be reproduced, stored in a retrieval system, or transmitted in any form or by any means, electronic, mechanical, photocopying, recording, or otherwise, without the prior written permission of SEIKO EPSON CORPORATION. No patent liability is assumed with respect to the use of the information contained herein. Neither is any liability assumed for damages resulting from the use of the information contained herein.

Neither SEIKO EPSON CORPORATION nor its affiliates shall be liable to the purchaser of this product or third parties for damages, losses, costs, or expenses incurred by purchaser or third parties as a result of: accident, misuse, or abuse of this product or unauthorized modifications, repairs, or alterations to this product, or (excluding the U.S.) failure to strictly comply with SEIKO EPSON CORPORATION's operating and maintenance instructions.

SEIKO EPSON CORPORATION shall not be liable against any damages or problems arising from the use of any options or any consumable products other than those designated as Original EPSON Products or EPSON Approved Products by SEIKO EPSON CORPORATION.

EPSON and PowerLite are registered trademarks of SEIKO EPSON CORPORATION.

SoundAdvice is a service mark and FaxAdvice is a trademark of Epson America, Inc.

General Notice: Other product names used herein are for identification purposes only and may be trademarks of their respective owners. EPSON disclaims any and all rights in those marks.

Important Information About Your Projector

Important Safety Information

Warning: *Never look into the projector lens when the lamp is turned on; the bright light can damage your eyes. Never let children look into the lens when it is on. Never open any cover on the projector, except the lamp and filter covers. Dangerous electrical voltages inside the projector can severely injure you. Except as specifically explained in this User's Guide, do not attempt to service this product yourself. Refer all servicing to qualified service personnel.*

Warning: *The projector and its accessories come packaged in plastic bags. Keep plastic bags away from small children to avoid any risk of suffocation.*

Caution: *When you replace the lamp, never touch the new lamp with your bare hands; the invisible residue left by the oil on your hands may shorten the lamp life. Use a cloth or glove to handle the new lamp.*

Remote Control Information

You can operate the projector by remote control via a line-of-sight infrared (IR) receiver at the front of the projector. The projector may not respond to remote control commands under the following conditions:

- p There is an object between the remote control IR emitter and the IR receiver on the projector.
- p Ambient light is too bright.
- p Certain types of fluorescent lighting are used.
- p A strong light source shines into the IR receiver.
- p Other equipment that emits infrared energy, such as a radiant room heater, is in the room.

These conditions commonly cause problems for most infrared-controlled equipment. Try the following solutions:

- p The remote control unit's batteries may be low on power; replace them.
- p Dim the ambient lighting and/or turn off any fluorescent lights.
- p Close any window coverings and/or move the projector out of direct sunlight.
- p Turn off other equipment that emits infrared energy.

If the remote control still does not work properly, remember you can always control your computer-based

presentation directly from the computer, even in an environment containing one of the conditions listed above.

FCC Compliance Statement For United States Users

This equipment has been tested and found to comply with the limits for a Class B digital device, pursuant to Part 15 of the FCC Rules. These limits are designed to provide reasonable protection against harmful interference in a residential installation. This equipment generates, uses, and can radiate radio frequency energy and, if not installed and used in accordance with the instructions, may cause harmful interference to radio or television reception. However, there is no guarantee that interference will not occur in a particular installation. If this equipment does cause interference to radio and television reception, which can be determined by turning the equipment off and on, the user is encouraged to try to correct the interference by one or more of the following measures.

- p Reorient or relocate the receiving antenna.
- p Increase the separation between the equipment and receiver.
- p Connect the equipment into an outlet on a circuit different from that to which the receiver is connected.
- p Consult the dealer or an experienced radio/TV technician for help.

WARNING

The connection of a non-shielded equipment interface cable to this equipment will invalidate the FCC Certification of this device and may cause interference levels which exceed the limits established by the FCC for this equipment. It is the responsibility of the user to obtain and use a shielded equipment interface cable with this device. If this equipment has more than one interface connector, do not leave cables connected to unused interfaces. Changes or modifications not expressly approved by the manufacturer could void the user's authority to operate the equipment.

For Canadian Users

This Class B digital apparatus meets all requirements of the Canadian Interference-Causing Equipment Regulations.

Cet appareil numérique de la classe B respecte toutes les exigences du Règlement sur le matériel brouilleur du Canada.

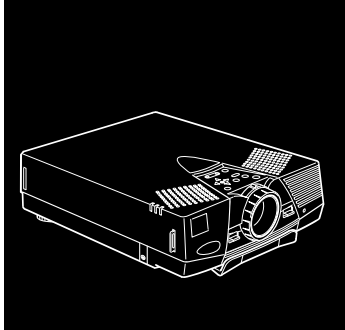

Contents

Introduction	1
Optional Accessories	3
About This Manual	4
Safety Instructions	5
Where to Get Help	7
Electronic Support Services	7
Automated Telephone Services	8
1 Setting Up the Projector	11
Unpacking the Projector	12
Additional Components	14
Attaching the Hand Strap	16
Installing the Remote Control Batteries	18
Where to Place the Projector	19
Connecting the Power Cord	21

Connecting to a Computer	21
Connecting to a PC Desktop Computer	23
Connecting to a PC Laptop Computer	26
Connecting to a Desktop Macintosh	29
Connecting to a PowerBook	35
Connecting to a Video Source Other Than a Computer	41
Connecting to an External Speaker or Public Address System	45
Turning the Equipment On and Off	46
Turning the Projector On and Off	46
Sleep Mode	48
2 Using the Projector	49
Positioning the Projector	51
Calculating Image Size and Projection Distance	52
Focusing and Positioning the Screen Image	54
Resizing the Projected Image	56
Controlling the Projector	57
Using the Remote Control	58
Using the Control Panel	63
Projector Status Lights	65
Power Light	65
Projector Lamp Light	66
Temperature Light	66
3 Adjusting Projector Settings	67
Accessing the Main Menu	69
Changing a Menu Setting	70
Adjusting Video Settings (Image Source = Computer)	72
Adjusting Video Settings (Image Source = Video)	74

Adjusting Audio Settings	75
Changing Basic Projector Settings	76
Creating and Assigning a User Logo	78
Creating the User Logo	78
Assigning the Logo to the AV/Mute Button	80
Modifying the Special Effects	81
Displaying Information About Your Projector	82
Resetting All Menu Options	83
4 Using ELP Link III	85
Unpacking the ELP Link III Kit	86
Connecting the ELP Link III Cables	87
Connecting to a PC Desktop or Laptop	88
Connecting to a Macintosh Desktop or PowerBook	92
Installing the ELP Link III Software	96
Installing the Software for Windows	96
Installing the Software on a Macintosh	97
Starting ELP Link III	98
Starting the Program from Windows	99
Starting the Program on a Macintosh	100
Changing the COM Port Assignment	101
Assigning Functions to the Effects Buttons	102
Modifying Functions	107
Defining and Using Key Macros	110
Saving and Recalling Effects Button Assignments	112
Assigning Functions to the Keyboard	114

Using the Projector Setting Dialog Box	116
Using the Quick Change Toolbar	118
Changing Projector Settings	118
Testing Projector Performance	124
Running ELP Link III Without the Projector	129
5 Maintenance	131
Cleaning the Lens	132
Cleaning the Projector Case	132
Cleaning the Air Filter	133
Replacing the Lamp	134
Transporting the Projector	137
6 Troubleshooting	139
Using the Online Help Menu	140
Problems with the Projector	141
Problems with the Remote Control	144
Problems with the Image or Sound	145
7 Technical Specifications	149
Glossary	155
Index	159

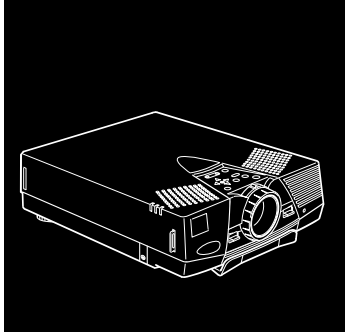

Introduction

The EPSON® PowerLite® projector is a compact, lightweight projector that lets you project full-color images and video onto a large screen for presentations. It supports IBM® compatible PCs and laptops, as well as Apple® Macintosh®, Power Macintosh,™ and PowerBook® computers.

Note: The projector also supports a wide range of video formats. See page 153 for details on supported computers and video formats.

In addition to its size and versatility, your projector offers the following advantages:

- p You can connect it simultaneously to two image sources: one PC or Apple Macintosh computer plus one video source, such as a VCR or camcorder.
- p You can connect the projector to an audio source for one or both image sources. The audio source can be the computer, video source, or another device such as a stereo.

-
- p It produces images that can be easily seen in rooms light enough to take notes. The PowerLite 5550C displays images in SVGA at a resolution of 800×600 pixels. The PowerLite 7550C displays images in XGA at a resolution of 1024×768 pixels.
 - p Its two speakers employ a built-in SRS 3D Sound System for rich, powerful audio output. You can also connect an external speaker when further amplification is required.
 - p You can select front, rear, or ceiling projection, according to the specific needs of your presentation.
 - p The projector's new patented SizeWize™ chip supports a variety of computer output resolutions. For example, the resize feature lets you display VGA or XGA images at the projector's SVGA resolution.
 - p You can control your projector through a hand-held remote control, which can also act as a wireless mouse to control the cursor on your computer screen during presentations.
 - p The optional ELP Link III software enables you to control the projector from a computer. In addition, it lets you assign functions both to your keyboard and to the remote control, and even program the keyboard and remote control with your own customized functions.
 - p The projector's sleep mode conserves electricity by automatically turning off the lamp after the projector has not been used for 30 minutes. The projector remains on, but the lamp is turned off, cooling the projector and extending the life of the lamp.

Optional Accessories

To enhance your use of the projector, EPSON provides the following optional accessories:

Accessory	Product code
Replacement lamp and filter	ELPLP07
Soft travel case for projector and laptop	ELPKS13
Hard travel case	ELPKS14
Computer cable	ELPKC02
ELP Link III kit for PC for Windows (includes ELP Link III software and cables)	ELPSW03
ELP Link III kit for Macintosh (includes ELP Link III software and cables)	ELPSW04
Mac adapter set	ELPAP01
Portable projection screen	ELPSC06

You can purchase these accessories from your dealer or by calling EPSON Accessories at **(800) 873-7766**; or visit our web site at www.epsonsupplies.com (U.S. sales only). In Canada, please call (800) 873-7766 for dealer referral.

About This Manual

This manual describes how to set up and use the EPSON PowerLite 5550C and PowerLite 7550C projectors. Except where noted, the instructions apply to both projectors.

Chapter 1, “Setting Up the Projector,” gives step-by-step instructions for connecting your projector to a computer, video, or audio source, and turning on the equipment.

Chapter 2, “Using the Projector,” gets you started with the basics: how to position and focus your projector, and how to use the buttons on the remote control and control panel.

Chapter 3, “Adjusting Projector Settings,” shows you how to use the projector’s built-in menus to change operational settings.

Chapter 4, “Using ELP Link III,” explains how to connect the ELP Link III cables and use the optional ELP Link III software.

Chapter 5, “Maintenance,” describes how to perform limited maintenance, such as replacing the lamp or cleaning the air filter.

Chapter 6, “Troubleshooting,” describes how to interpret your projector’s warning lights and what to do when you encounter specific problems.

Chapter 7, “Technical Specifications,” lists the projector’s technical specifications.

A Glossary and Index are provided at the end of the manual.

Safety Instructions

Always follow these safety instructions:

1. Place the projector on a flat, stable surface.
2. Don't use the projector near water or sources of heat. Don't place the projector or remote control on top of heat-producing equipment, and avoid places subject to shocks and vibrations, or high or rapidly changing temperatures and humidity.
3. Use attachments only as recommended.
4. Use the type of power source indicated on the projector. If you're not sure of the power available, consult your dealer or power company.
5. Place the projector near a wall outlet where you can easily unplug it.

Placez le projecteur près d'une prise de contact où la fiche peut être débranchée facilement.

6. Insert the projector's three-wire grounding-type plug into a properly grounded outlet. If you have a two-prong outlet, contact an electrician to replace it. Don't touch the plug with wet hands, as this can cause electric shock.
7. Always insert the plug firmly into the outlet. Also, avoid dusty outlets. Failure to follow these precautions could result in fire.
8. Don't overload wall outlets, extension cords, or integral convenience receptacles. This can cause fire or electric shock.

-
9. Don't place the projector where the cord can be walked on, which can result in fraying or damage to the plug.
 10. Unplug the projector from the wall outlet before cleaning. Use a damp cloth for cleaning. Don't use liquid or aerosol cleaners.
 11. Don't block the slots and openings in the projector case. They provide ventilation and prevent the projector from overheating. Don't operate the projector on a sofa, rug, or other soft surface, or in a closed-in cabinet unless proper ventilation is provided.
 12. Never push objects of any kind through cabinet slots. Never spill liquid of any kind into the projector.
 13. Except as specifically explained in this *User's Guide*, don't attempt to service the projector yourself. Refer all servicing to qualified service personnel. Opening or removing covers may expose you to dangerous voltages and other hazards.
 14. Unplug the projector during electrical storms, or when it will not be used for extended periods.
 15. Unplug the projector from the wall outlet and refer servicing to qualified service personnel under the following conditions:
 - p When the power cord or plug is damaged or frayed
 - p If liquid has been spilled into the projector, or if it has been exposed to rain or water
 - p If it doesn't operate normally when you follow the operating instructions, or if it exhibits a distinct change in performance
 - p If it has been dropped or the housing has been damaged

Where to Get Help

If you're having trouble setting up or using your projector, see the projector's Help menu or read Chapter 6, "Troubleshooting." If you can't resolve the problem, EPSON provides technical assistance through electronic support services and automated telephone services 24 hours a day, as listed in the following tables.

Electronic Support Services

Service	Access
World Wide Web	From the Internet, you can reach EPSON's Home Page at http://www.epson.com .
EPSON Internet FTP Site	If you have Internet FTP capability, use your Web browser (or other software for FTP downloading) to log onto ftp.epson.com with the user name anonymous and your e-mail address as the password.
EPSON Forum on CompuServe®	Members of CompuServe can type GO EPSON at the menu prompt to reach the Epson America Forum. For a free introductory CompuServe membership, call (800) 848-8199 and ask for representative #529.

Automated Telephone Services

Service	Access
EPSON SoundAdvice SM	For pre-recorded answers to commonly asked questions about EPSON products 24 hours a day, seven days a week, call (800) 922-8911 .
EPSON FaxAdvice TM	Access EPSON's technical information library by calling (800) 922-8911 . You must provide a return fax number to use this service.
EPSON Referral Service	For the location of your nearest Authorized EPSON Reseller or Customer Care Center, call (800) 922-8911 .

When support is required, follow the calling instructions on the back of the EPSON Private Line Technical Support card included with the projector. Technical support is also available in the U.S. by calling (310) 974-1202 between 6 AM and 6 PM, Pacific time, Monday through Friday. In Canada, call (905) 709-3839. Toll or long distance charges may apply.

Before you call, please have the following information ready:

- p Product name
- p Product serial number
- p Personal identification number (PIN) for EPSON Private Line Technical Support

p Computer configuration

p Description of the problem

You can purchase accessories from EPSON Accessories at **(800) 873-7766**; or visit our web site at www.epsonsupplies.com (U.S. sales only). In Canada, please call (800) 873-7766 for dealer referral.

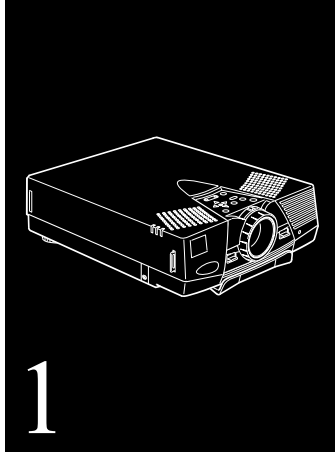

Setting Up the Projector

This chapter describes how to unpack the projector, connect it to other equipment, and turn it on.

Before it can project any images, the projector must be connected to a video source, such as a computer, VCR, camcorder, or DVD player. If you want, you can connect your projector to both a computer and a second video source. You can also do any of the following:

- p Connect the projector to an audio source for one or both video sources. The audio source can be the computer, a video device capable of producing audio (such as a VCR or camcorder), or another device such as a stereo.

- p Connect the mouse cable to use the remote control as a wireless mouse. Except for some laptops, this disables your computer's mouse. If you are also viewing the display on your monitor, the remote control's pointer controls the screen cursor.
- p Connect the projector to an external speaker or public address (PA) system to amplify the audio.

Unpacking the Projector

When you unpack the projector, make sure you have all these components:

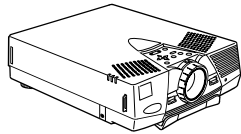

Projector

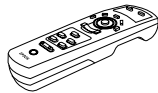

Remote control



2 AA batteries

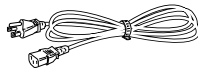

Power cord

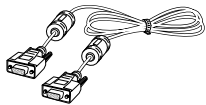

Projector video cable



Audio cable



Audio/video (A/V) cable

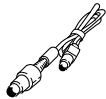

PS/2[®] mouse cable (for the PC)

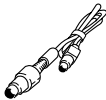

Mac mouse cable (for the Macintosh)

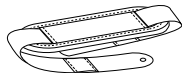

Hand strap (with 2 screws)

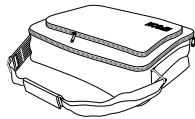

Soft carrying case

Macintosh adapter set:

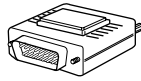

Macintosh desktop adapter

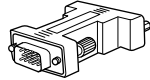

Macintosh monitor adapter

You will not need all these components.

Save all packaging in case you need to ship the projector in the future. Always transport the projector in its original packaging (or the equivalent) or use a carrying case if you are carrying the projector by hand. (See “Transporting the Projector” on page 137 for instructions.)

Additional Components

Depending on how you plan to use the projector, you may need these additional components:

- p For complete control of the projector from your computer or to program enhanced special effects on the remote control, you need the optional ELP Link III kit. You can purchase the kit from your dealer or by calling EPSON Accessories at **(800) 873-7766** (U.S. sales only).

-
- p To receive an S-Video signal, you will need an S-Video cable. (One is usually provided with your video device.) A separate cable is required for each video source.
 - p To connect the projector to a Macintosh PowerBook, you may need a video-out cable and an adapter. (The video-out cable is provided by—or can be purchased from—Apple Computer for all PowerBooks that have video-out capability and require the cable. If your PowerBook doesn't include one, see your Macintosh dealer. Additionally, some PowerBooks come with an adapter for a high-density, 15-pin, VGA connector.)
 - p To connect the projector to an external sound system, you need an RCA-to-3.5 mm stereo audio cable. You can obtain one from your computer dealer.
 - p To use the remote control when the projector is not in line-of-sight of the remote, you need an optional infrared repeater. For more information, call **(800) 843-5465** or visit this web address: **www.xantech.com**.
 - p To connect a serial mouse cable to your computer, you may require a special connector, cable, or other components. You can obtain these items from your computer dealer.
 - p To protect your projector, you can connect a Kensington MicroSaver[®] anti-theft device in the hole on the back of the projector. Contact your local computer dealer.

Attaching the Hand Strap

Follow the steps below to attach the hand strap to the projector with the two screws included with the strap.

1. Gently place the projector on its side, so you are looking at the bottom and the back of the projector is facing left.

Caution: Do not lift or hold the projector by its lens; this can damage the lens.

2. Locate the blue slider button on the bottom front of the projector and slide the button up until the front strap connector is fully extended.

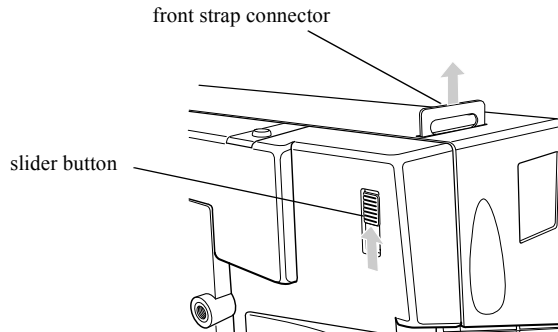

3. Place one end of the strap through the front strap connector and use a screwdriver to fasten one of the screws through the strap. Make sure the screw is securely fastened.

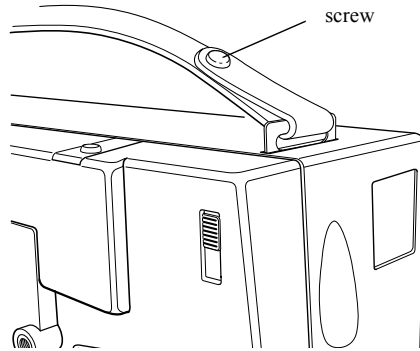

4. Place the other end of the strap through the rear strap connector and fasten it with the other screw. (There is no slider button for the rear strap connector.)

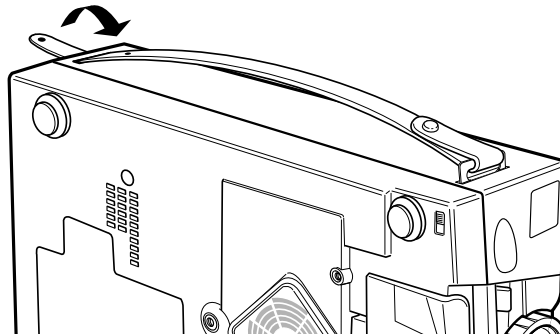

Installing the Remote Control Batteries

You can use the remote control as a wireless mouse instead of your computer's mouse to control your presentation. If you purchased the optional ELP Link III kit, you can assign different functions to the Effects buttons, and even program the buttons with your own customized functions. (See "Assigning Functions to the Effects Buttons" on page 102.) Follow these steps to install the batteries:

1. Slide off the battery compartment cover.

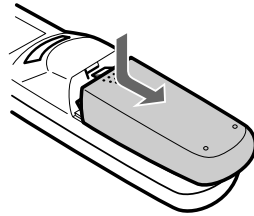

2. Insert the two AA batteries included with the projector. Make sure the polarity of the batteries is correct.

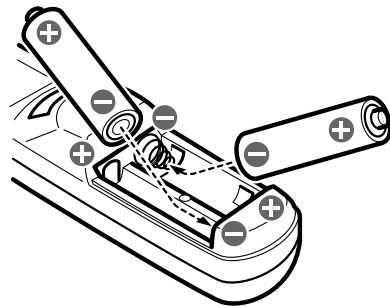

-
3. Replace the battery compartment cover.

When replacing batteries, take the following precautions:

- p Don't mix old and new batteries.
- p Replace batteries as soon as they run out. If the batteries leak, wipe away battery fluid with a soft cloth. If fluid gets on your hands, wash them immediately.
- p Remove the batteries if you plan not to use the projector for a long period of time.

Where to Place the Projector

Before you start connecting cables, decide where you want to place the projector and computer or video source. Follow these guidelines:

- p Place the projector on a sturdy, level surface within five feet of your computer or video source. Remember not to place the projector near sources of heat, or in a location where the cord is likely to be stepped on.
- p Because the distance between the projector and screen determines image size, position the projector the proper distance from the screen for the size image you want to project. Use the following table to determine the correct distance. (For more precise calculations, see page 52.)

Note: In addition to front projection, your projector supports rear and ceiling projection. To use rear or ceiling projection, you need to select the Ceiling or Rear Projection mode in the Setting menu. See “Changing Basic Projector Settings” on page 76 for more information.

Image size (diagonal)	Horizontal distance from projector to screen	
	Minimum	Maximum
300 inches (762 cm)	494 inches (12.6 m)	639 inches (16.3 m)
200 inches (508 cm)	328 inches (8.4 m)	423 inches (10.8 m)
100 inches (254 cm)	163 inches (4.2 m)	213 inches (5.4 m)
80 inches (203 cm)	129 inches (3.3 m)	170 inches (4.3 m)
60 inches (152 cm)	96 inches (2.5 m)	127 inches (3.2 m)
50 inches (127 cm)	80 inches (2.0 m)	105 inches (2.7 m)
40 inches (102 cm)	67 inches (1.7 m)	83 inches (2.1 m)
30 inches (76 cm)	47 inches (1.2 m)	58 inches (1.5 m)
25 inches (64 cm)	38 inches (1.0 m)	46 inches (1.2 m)
19 inches (48 cm)	None	38.0 inches (1.0 m)

Note: The projector must be between 3.3 and 53.5 feet (1.0 to 16.3 meters) from the screen.

Connecting the Power Cord

Connect the appropriate end of the power cord to the power inlet on the back of the projector, as shown below. Connect the other end to a grounded electrical outlet.

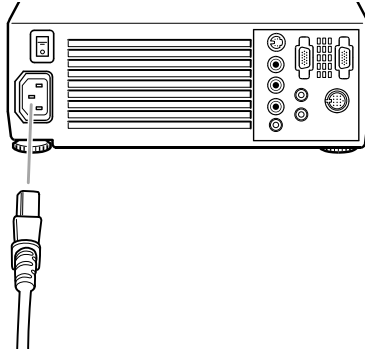

Connecting to a Computer

You can connect the projector to a computer capable of XGA, VGA, or SVGA output. The PowerLite 7550C is also capable of projecting SXGA images. (The projector resizes VGA and XGA images for the PowerLite 5550C and VGA, SVGA, and SXGA images for the 7550C.) The following types of computers are supported:

- p IBM compatible desktop or laptop PC
- p Apple Macintosh desktop computer, including Macintosh Quadra,[®] Macintosh Centris,[®] and Power Macintosh
- p Any Apple PowerBook with video-out capability

You can connect the projector to two video sources simultaneously (for example, a computer and a VCR), and you can connect a separate audio source for each video source.

If you will be using the optional ELP Link III software, you'll also need to connect the ELP Link III cables. See Chapter 4 for instructions after you finish connecting the projector to your computer.

***Note:** If you want to use the remote as a mouse and your computer doesn't have a PS/2 mouse connector, you must use the ELP Link III kit to connect the projector to a computer.*

The illustration below identifies all the interface ports on the back of the projector; you may want to refer to this as you connect your computer or other equipment to the projector.

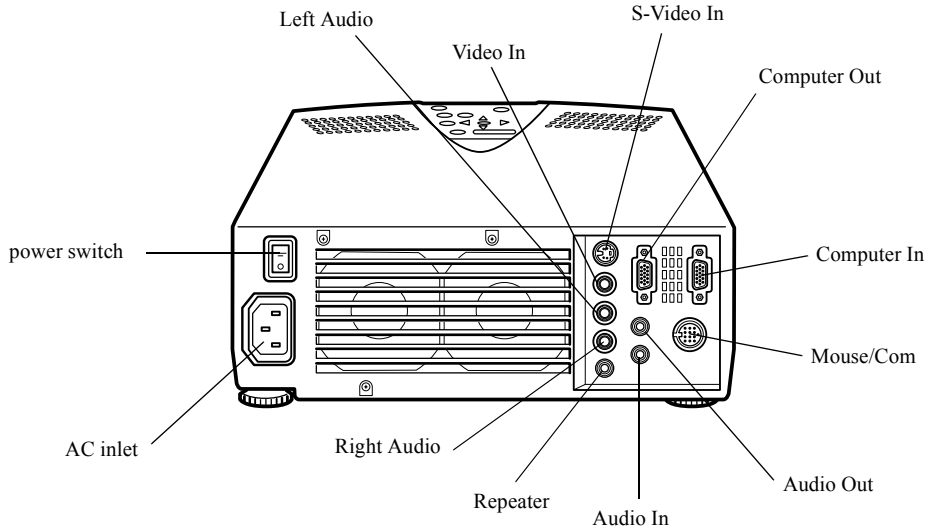

Connecting to a PC Desktop Computer

This section describes how to connect the projector to your PC desktop with the projector's video, audio, and mouse cables. (You must connect the video cable; the audio and mouse cables are optional.)

Connecting the projector's video cable

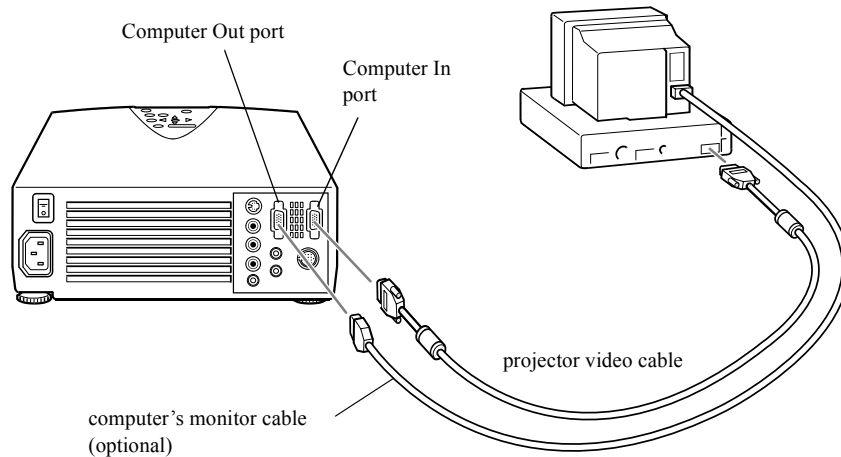

Note: *Computer configurations vary. See your computer manual for the location of the ports needed to connect your projector.*

1. Turn off the projector and computer, if they're on.
2. Connect either end of the projector's video cable to the Computer In port.
3. Disconnect the computer's monitor cable from the video port on the back of the computer.
4. Connect the other end of the projector's video cable to the computer's video port.

5. If you want to view the video on the computer monitor, connect the computer's monitor cable to the projector's Computer Out port. (This is especially useful when the projection screen is behind you.)
6. Tighten the screws on all connectors.

Connecting the projector's audio cable

1. If you will be using audio, connect one end of the audio cable that came with the projector to the Audio In jack on the projector.

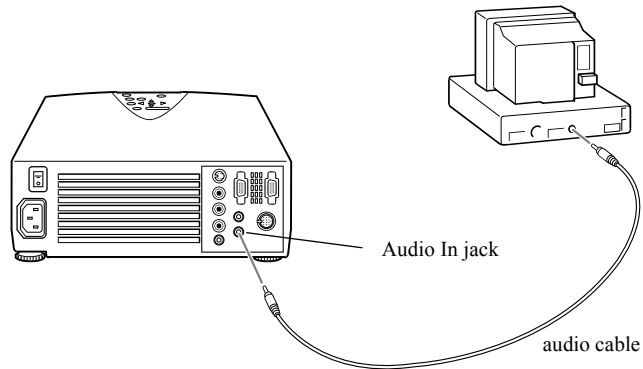

2. Connect the other end of the audio cable to the audio out port on a sound card in the computer.

Connecting the projector's mouse cable

Connect the projector's PS/2 mouse cable if you want to use the projector's remote control as a mouse pointer for the computer.

Note: If you'll be using the optional ELP Link III software, you need to connect the mouse cable included in the ELP Link III kit instead. See Chapter 4 for instructions.

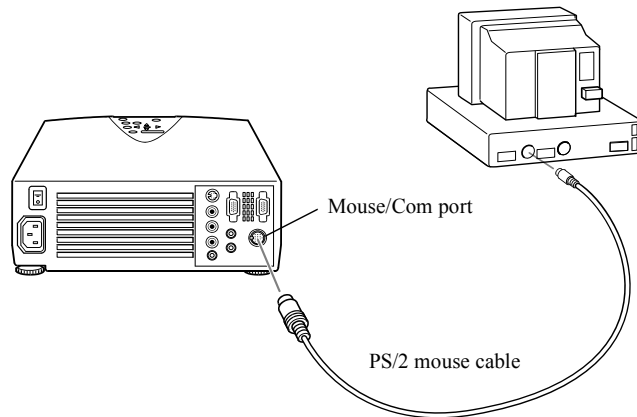

1. Disconnect the computer's PS/2 mouse cable from the mouse port on the back of your computer and replace it with the small end of the PS/2 mouse cable that came with the projector.
2. Connect the other end of the PS/2 mouse cable to the projector's Mouse/Com port.

Connecting to a PC Laptop Computer

This section describes how to connect the projector to your PC laptop with the projector's video, audio, and mouse cables. (You must connect the video cable; the audio and mouse cables are optional.)

Connecting the projector's video cable

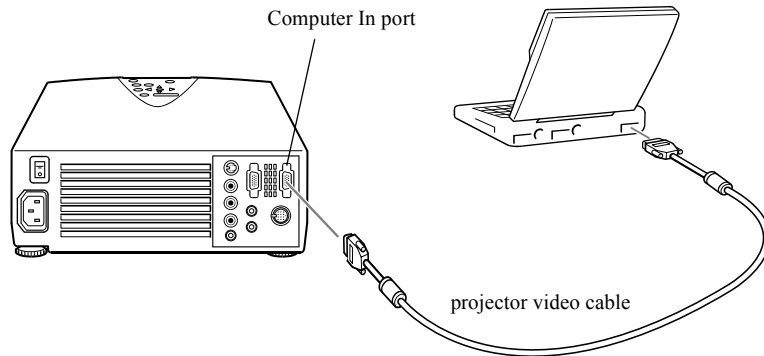

Note: Laptop configurations vary. See your computer manual for the location of ports needed to connect your projector.

1. Turn off the projector and computer, if they're on.
2. Connect either end of the projector's video cable to the Computer In port.
3. Connect the other end of the video cable to the laptop's video (monitor) port.

4. Tighten the screws on both connectors.
5. Check the documentation for your laptop for instructions on setting the display to appear on an external monitor (the projector screen) only or on both the LCD screen and the projector screen. If the projector's image is dim or not displayed correctly, try setting up the laptop to display for external monitor only.

Connecting the projector's audio cable

If you want to use audio, your laptop must have an Audio Out jack to connect the audio cable.

1. Connect one end of the audio cable that came with the projector to the Audio In jack on the projector.

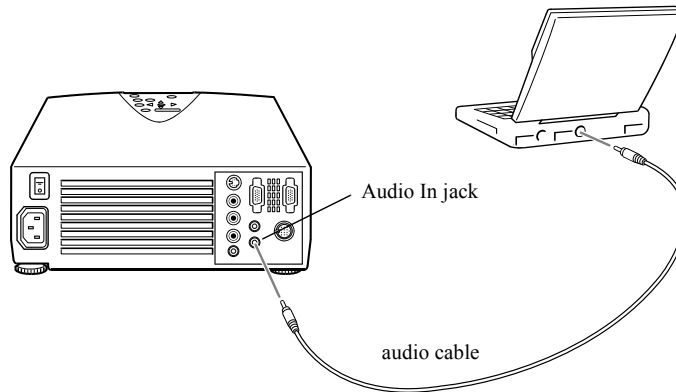

-
2. Connect the other end of the audio cable to the audio out port on your laptop.

Connecting the projector's mouse cable

Connect the projector's PS/2 mouse cable if you want to use the projector's remote control as a mouse pointer for your computer.

Note: If you'll be using the optional ELP Link III software, you need to connect the mouse cable included in the ELP Link III kit instead. See Chapter 4 for instructions.

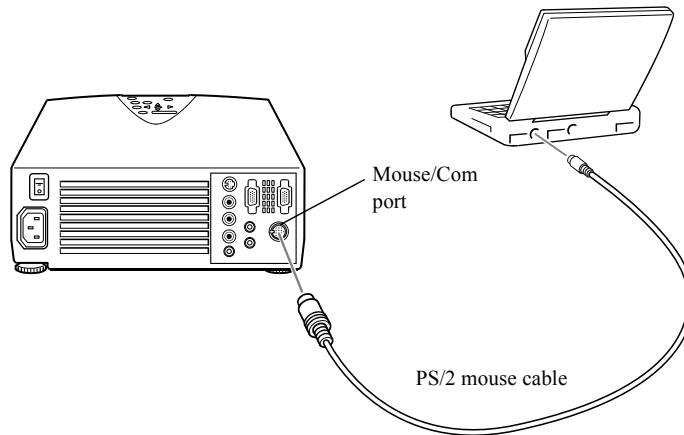

1. Connect the small end of the PS/2 mouse cable included with the projector to the laptop's mouse port.
2. Connect the other end of the PS/2 mouse cable to the projector's Mouse/Com port.

Connecting to a Desktop Macintosh

This section describes how to connect the projector to your desktop Macintosh with the projector's video, audio, and mouse cables. (You must connect the video cable; the audio and mouse cables are optional.) Make sure you also have ready the Macintosh desktop adapter and monitor adapter that came with the projector. (You'll need the monitor adapter only if you'll be displaying the image on your monitor screen as well.)

Connecting the projector's video cable

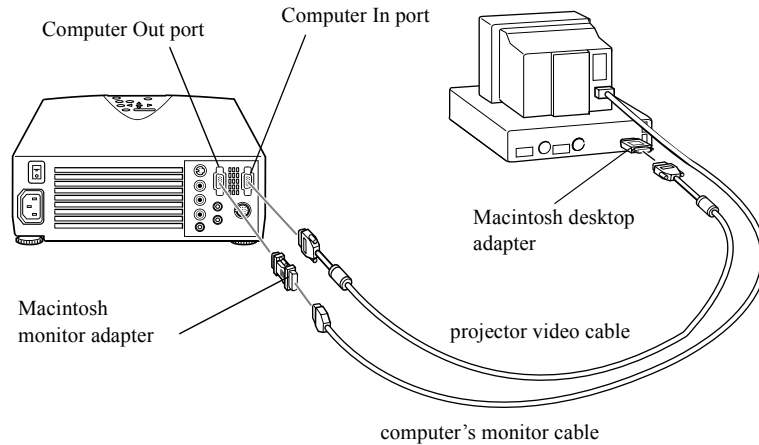

***Note:** Macintosh computer configurations vary. See your computer manual for the location of the ports needed to connect your projector.*

1. Turn off the projector and your Macintosh, if they're on.
2. Connect either end of the projector's video cable to the Computer In port.

3. Locate the Macintosh desktop adapter that came with your projector and remove the small cover, as shown below.

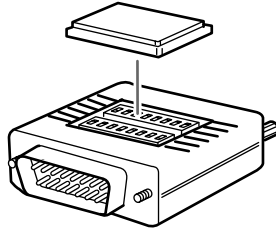

4. Set the DIP switches on the desktop adapter to select the resolutions you want to use (such as 16-inch mode). See your Macintosh documentation for instructions.
5. Connect the small terminal of the Macintosh desktop adapter to the other end of the projector's video cable (now attached to the projector's Computer In port).

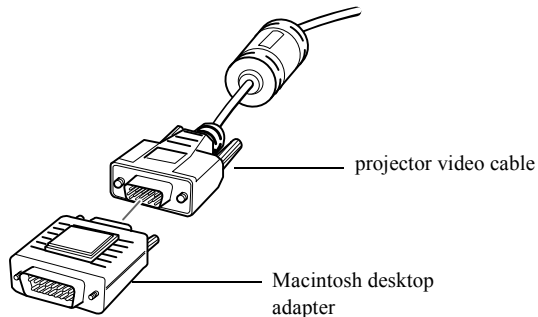

6. Disconnect the monitor cable from the video port on the back of your Macintosh.
7. Connect the projector's video cable (with the desktop adapter attached) to the video port on the back of your Macintosh.
8. If you want to view images on your computer's monitor, locate the Macintosh monitor adapter that came with your projector.
9. Attach the large end of the adapter to your computer's monitor cable, and attach the small end of the Macintosh monitor adapter to the projector's Computer Out port.

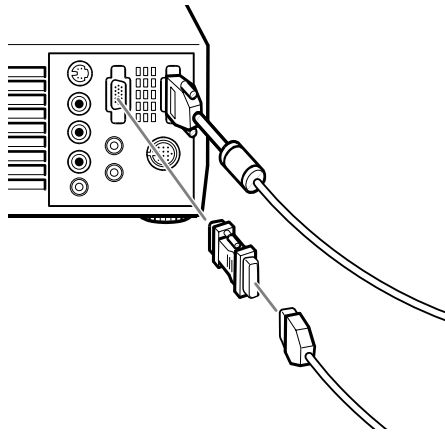

10. Tighten the screws on all the connectors.

Connecting the projector's audio cable

1. If you will be using audio, connect one end of the audio cable that came with the projector to the projector's Audio In jack.

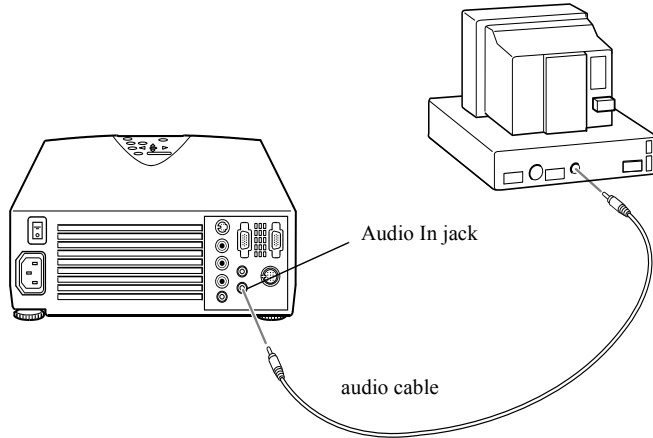

2. Connect the other end of the audio cable to the audio out port on your computer.

Connecting the projector's mouse cable

Connect the Macintosh mouse cable that came with your projector if you want to use the projector's remote control as a mouse pointer for your Macintosh.

Note: If you'll be using the optional ELP Link III software, you need to connect the Macintosh mouse cable included in the ELP Link III kit instead. See Chapter 4 for instructions.

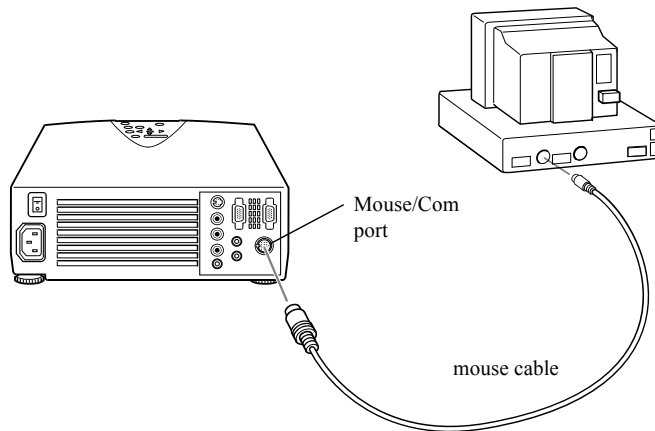

1. Disconnect your Macintosh's mouse cable.
2. Connect the small end of the mouse cable that came with your projector to the mouse port on your Macintosh.
3. Connect the other end of the projector's mouse cable to the Mouse/Com port on the projector.

Connecting to a PowerBook

This section describes how to connect the projector to your Macintosh PowerBook with the projector's video, audio, and mouse cables. (You must connect the video cable; the audio and mouse cables are optional.)

Note: When you've finished connecting the cables, you may need to choose Mirroring in the Display Control Panel to display the image on the PowerBook screen as well as the projector screen. See your Macintosh documentation for details. (This step is not necessary on some newer systems, which can detect a dual video signal.)

Connecting the projector's video cable

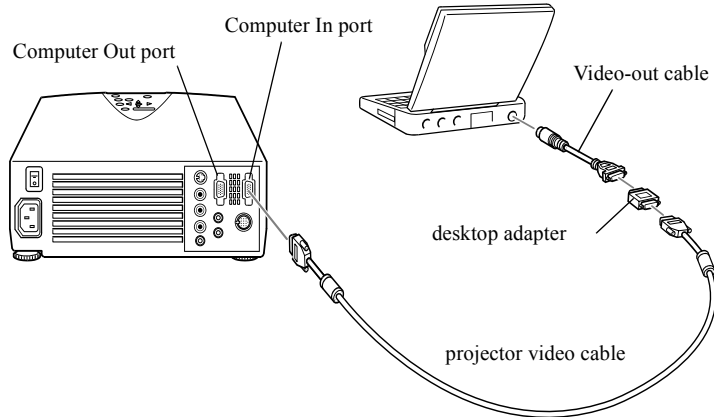

Note: Some new PowerBooks may let you connect the projector video cable directly to the computer without using a video-out cable. In addition, PowerBook configurations vary, so the location of your computer's ports may not match the illustration. See your computer manual for additional information on connecting a video cable.

1. Turn off the projector and your PowerBook, if they're on.
2. Connect either end of the projector's video cable to the projector's Computer In port.

3. Locate the Macintosh desktop adapter that came with your projector and remove the small cover, as shown below.

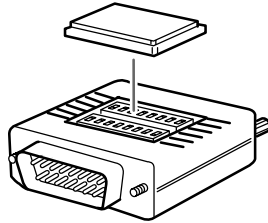

4. Set the DIP switches on the desktop adapter to select the resolutions you want to use. See your Macintosh documentation for instructions.
5. Connect the small terminal of the Macintosh desktop adapter to the other end of the video cable that came with your projector.

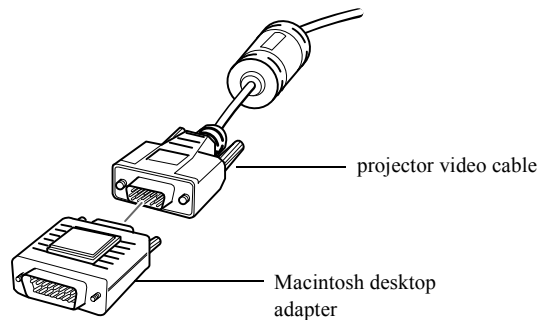

-
6. If your PowerBook requires a video-out cable, connect the smaller end to the video-out connector on the back of the PowerBook. Then connect the other end to the projector's video cable (with the Macintosh desktop adapter attached).

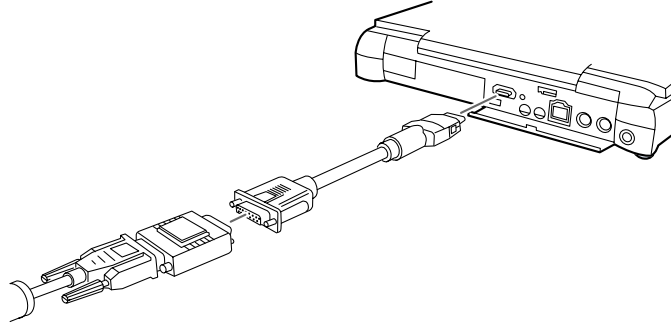

7. Tighten the screws on all the connectors.

Connecting the projector's audio cable

1. If you want to use audio, connect one end of the audio that came with the projector to the projector's Audio In jack.

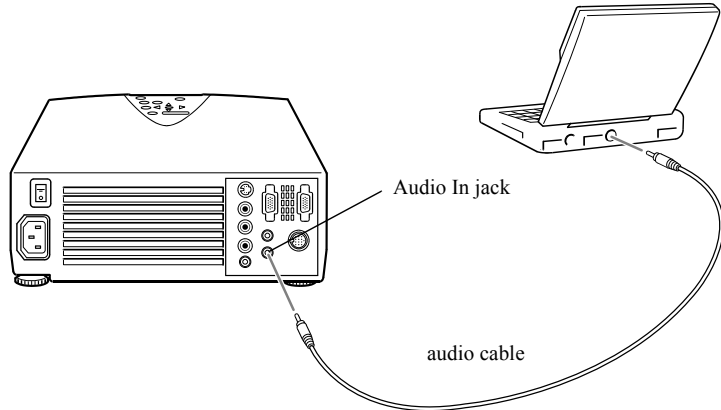

2. Connect the other end of the audio cable to the audio out port on your computer.

Connecting the projector's mouse cable

Connect the Macintosh mouse cable that came with your projector if you want to use the projector's remote control as a mouse pointer for your Macintosh.

Note: If you'll be using the optional ELP Link III software, you need to connect the Macintosh mouse cable included in the ELP Link III kit instead. See Chapter 4 for instructions.

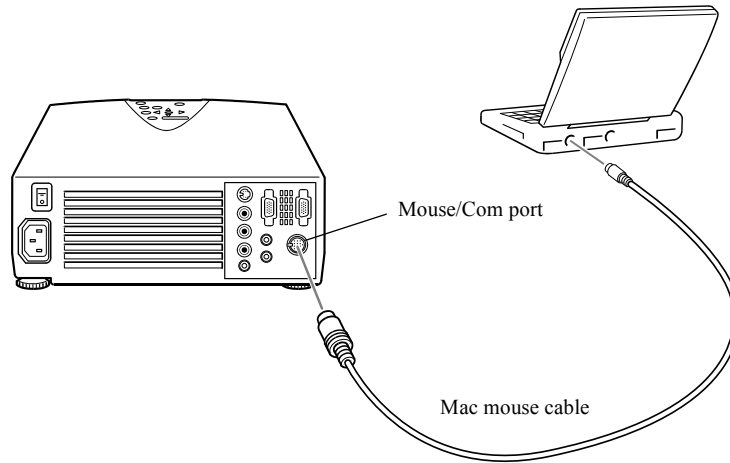

1. Connect the small end of the projector's Mac mouse cable to the mouse port on your PowerBook.
2. Connect the cable's other end to the projector's Mouse/Com port.

Connecting to a Video Source Other Than a Computer

In addition to your computer, you can connect a VCR, camcorder, DVD player, or any other compatible video source to your projector.

If you want, you can connect a single video source, such as a VCR. You don't have to connect a computer unless you want to use the optional ELP Link III software. You can also connect a computer plus a second video source simultaneously. If your video source has audio capability, it can also be an audio source.

The projector can receive composite video or S-Video:

- p If your video device has a one-pin RCA video jack, it's a composite video source. Use the audio/video (A/V) cable supplied with the projector to connect the projector to your video device.
- p If your video device has a four-pin video jack, it's an S-Video source. To connect the video device to your projector, use the S-Video cable supplied with your video device, or obtain an S-Video cable from your computer dealer.

Note: *The projector is not compatible with a cable TV-style F connector.*

If both a composite video and S-Video device are connected to the projector, the projector automatically selects S-Video as the default video source. To display composite video, disconnect the S-Video device.

The projector supports NTSC, PAL, PAL60, and SECAM video formats, and automatically detects and identifies the video format. However, if automatic selection is not possible for some reason, you can specify that a specific video format be detected (see page 74).

***Note:** If you change the Video Signal setting in the Setting menu to specify a particular video format, the projector will be able to detect only the format specified. To have the projector automatically detect any supported video format, reset the Video Signal setting to Auto.*

Follow these steps to connect a video device:

1. Turn off the projector and video device, if they're on.
2. Locate the appropriate video cable:
 - p If your video source has a large, round, four-prong S-Video connector, use the cable that came with your video device, or purchase an S-Video cable from your computer dealer.
 - p If your video source has a small, round, one-prong composite (RCA) video connector, use the audio/video (A/V) cable that came with the projector. (The A/V cable has three RCA plugs on either end of the cable.)

3. For S-Video, insert one end of an S-Video cable into the projector's S-Video In connector. Insert the other end into the S-Video Out jack on your video device.

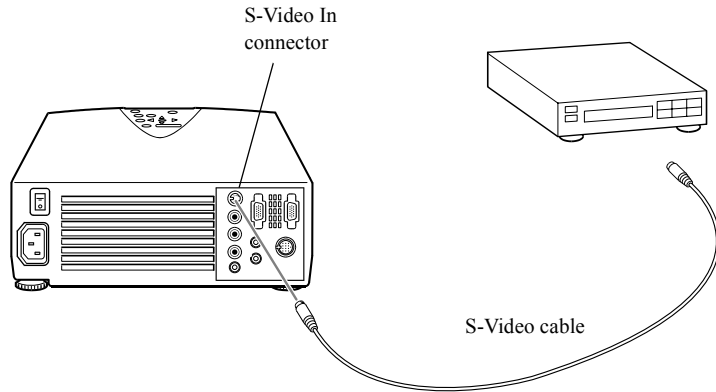

If you want to use your S-Video device as an audio source too, follow the instructions earlier in this chapter for connecting the projector's audio cable, except connect it to your S-Video device instead of your computer.

4. For composite video, connect the yellow RCA plug on one end of the audio/video cable to the projector's Video In port. Connect the other yellow RCA plug to the video-out jack on your video device.

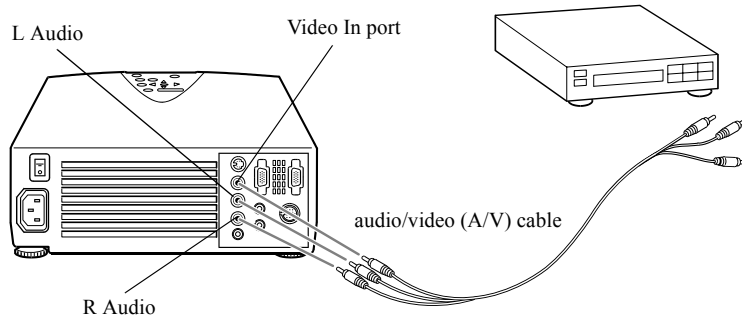

If you want to use your composite video device as an audio source too, connect the other plugs on the audio/video cable to the Audio jacks on the projector: insert the white plug into the L Audio jack and the red plug into the R Audio jack. Connect the plugs at the other end of the audio/video cable to the audio output jacks on your video device.

Connecting to an External Speaker or Public Address System

Although the projector's internal speakers are enough for most small- or medium-size rooms, you can connect the projector to an external speaker or public address (PA) system for large rooms or to gain maximum benefit from the projector's built-in 3D sound function.

To connect the projector to an external sound system, you need to get an RCA-to-3.5 mm stereo audio cable from your computer dealer.

1. Turn off the projector and speaker or PA system, if they're on.
2. Connect the cable's 3.5 mm stereo miniplug to the projector's Audio Out jack.

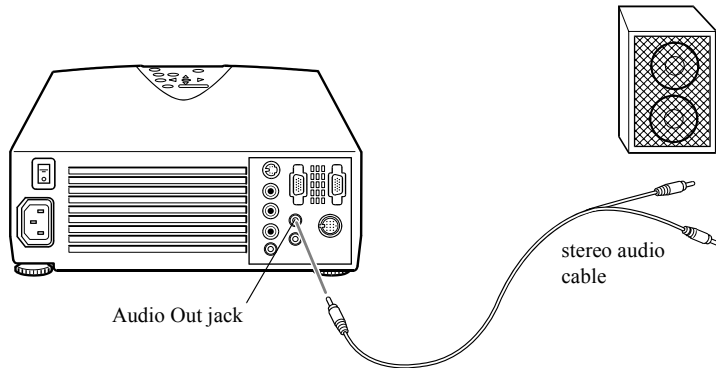

-
3. Connect the RCA plugs to the speaker or PA system. Insert the cable's red plug into the Audio R jack, and the white plug into the Audio L jack.

Turning the Equipment On and Off

It's best to turn on the projector and its attached equipment in the following order:

1. Video source (such as a VCR), if your video source is not your computer
2. Audio source (if different from the computer or video source)
3. External amplified speaker or PA system (if you've connected one)
4. Projector (see instructions below)
5. Computer

When you're ready to turn off the equipment, do so in the reverse order.

Turning the Projector On and Off

Before you turn on the projector, make sure it is plugged in and connected to your video source.

1. Remove the projector lens cap.
2. Turn on the main power switch located at the rear of the projector and wait until the power light turns orange.

3. Press the Power button on the remote control or the control panel on top of the projector. The power light flashes green as the projector warms up. When the projector is fully warmed up, this light remains green.

If computer or video equipment is attached, the computer or video signal is projected. Allow about 30 seconds for full illumination.

Warning: *Never look into the lens when the lamp is on. This can damage your eyes. It is especially important that children not look into the lens.*

When you want to stop projecting images, press the Power button again. The fan remains on and the power light flashes orange for about two minutes as the projector cools down.

Note: *Projecting an image for an extended time may cause an afterimage to appear on the screen.*

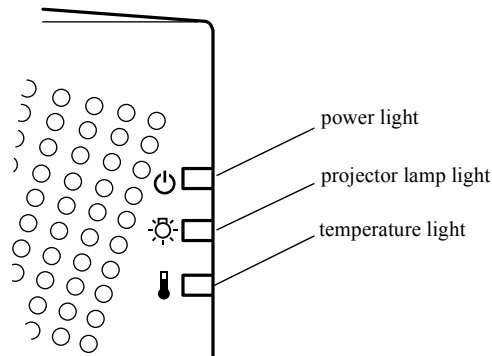

When the projector has cooled down, the power light stops flashing and remains orange.

To turn off the projector completely, wait until it cools down and the power light stops flashing. Then turn off the switch on the back of the projector.

***Note:** If you press the Power button to turn the projector back on while the power light is orange, there may be a delay before a projected image appears.*

Sleep Mode

Sleep mode conserves electricity by automatically turning off the lamp after the projector has not been used for 30 minutes. In sleep mode, the projector's power light turns a steady orange and only a minimum amount of the projector's circuitry remains on. This conserves electricity, cools the projector, and extends the life of the lamp.

When the projector is in sleep mode, press the Power button to resume projecting images, or press the power switch on the back of the projector to turn it off.

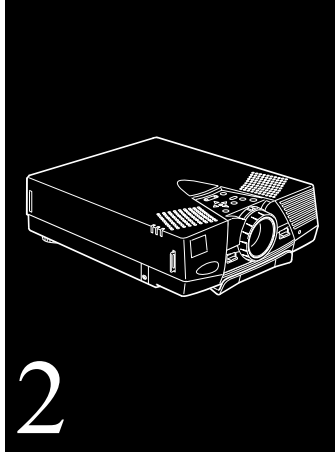

Using the Projector

This chapter provides instructions for the following:

- p Positioning the projector relative to the screen
- p Focusing and positioning the screen image
- p Using the remote control and control panel to control the projector
- p Monitoring the projector's operating status

The illustration below identifies the parts of your projector.

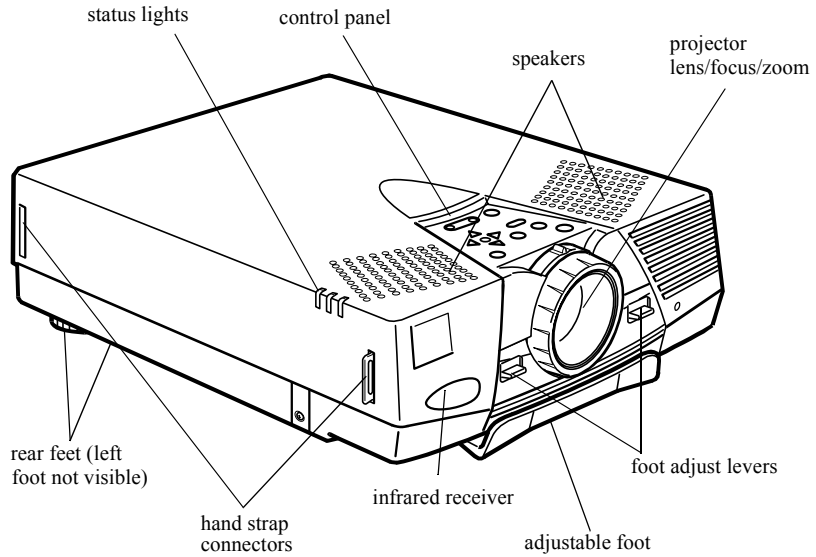

Positioning the Projector

Your projector supports front, rear, and ceiling projection, allowing you to choose the best method for displaying your images. If you use rear or ceiling projection, you need to select a special mode in the projector's Setting menu. See page 76 for more information.

To get the best results, it's important to position the projector at the proper height and distance relative to the screen.

When projecting from a table or desk, place the projector so the lens is aligned as closely as possible with the bottom of your screen:

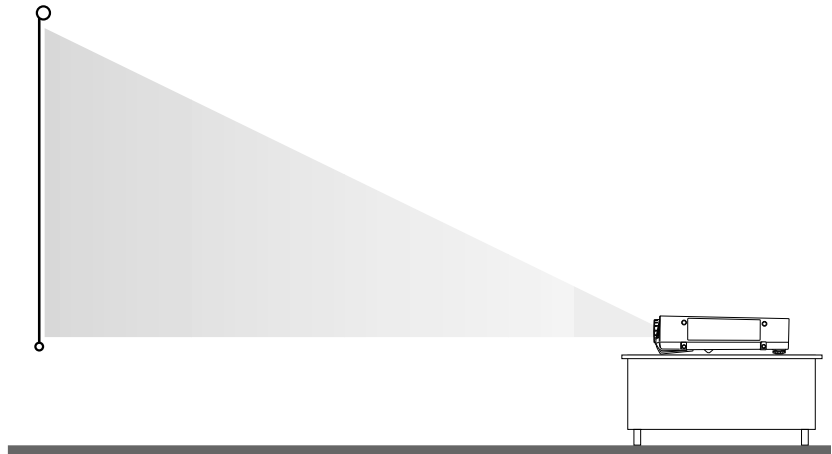

When projecting from the ceiling, align the lens as closely as possible with the top of your screen:



Calculating Image Size and Projection Distance

The distance between the projector and the screen determines the actual image size. To determine the exact distance required for a particular image size (or to determine the size of an image at a particular distance), use the formulas given below. (Remember that the size of the image can also be changed by rotating the zoom ring; see page 54 for more information.)

To determine the minimum and maximum diagonal size of an image when you know the projection distance:

p **Inches:**

$$\text{Maximum diagonal size} = (0.6038 \times \text{projection distance}) + 1.8898$$

$$\text{Minimum diagonal size} = (0.4631 \times \text{projection distance}) + 1.4000$$

p **Centimeters:**

$$\text{Maximum diagonal size} = (0.6038 \times \text{projection distance}) + 4.8001$$

$$\text{Minimum diagonal size} = (0.4631 \times \text{projection distance}) + 3.5560$$

To determine the projection distance when you know the diagonal size of the screen image:

p **Inches:**

$$\text{Maximum projection distance} = (2.1593 \times \text{diagonal size}) - 3.0229$$

$$\text{Minimum projection distance} = (1.6562 \times \text{diagonal size}) - 3.1291$$

p **Centimeters:**

$$\text{Maximum projection distance} = (2.1593 \times \text{diagonal size}) - 7.6782$$

$$\text{Minimum projection distance} = (1.6562 \times \text{diagonal size}) - 4.2068$$

For example, here are the measurements for three installations:

Image size (diagonal)	Horizontal distance from projector to screen	
	Minimum	Maximum
300 inches* (762 cm)	494 inches (12.6 m)	639 inches (16.3 m)
200 inches (508 cm)	328 inches (8.4 m)	423 inches (10.8 m)
100 inches (254 cm)	163 inches (4.2 m)	213 inches (5.4 m)

* For an image size of 300 inches, the projector may be up to 53.7 feet away from the screen, depending on the setting of the zoom ring.

Focusing and Positioning the Screen Image

When an image appears on screen, check that it is in focus and correctly positioned on the screen.

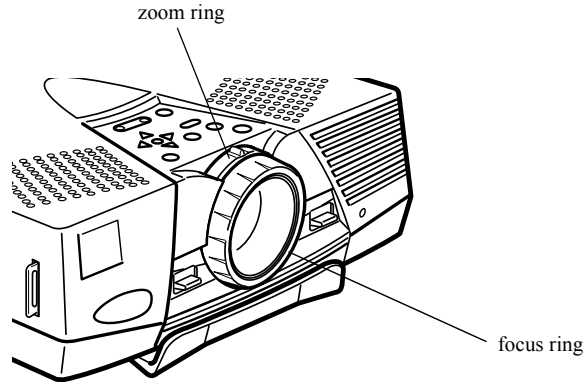

- p To focus the image, rotate the focus ring (the front ring on the lens).
- p To adjust the size of the image, rotate the zoom ring (the rear ring). Rotate the zoom ring clockwise (facing the projector) to make the screen image larger or counterclockwise to make it smaller.

If you need to raise or lower the image on the screen, extend or retract the foot at the bottom front of the projector as follows:

1. Stand behind the projector and support the front of it while you lift the blue foot adjust levers above the adjustable foot. This unlocks the foot so it can move up and down. Be careful not to drop the projector.

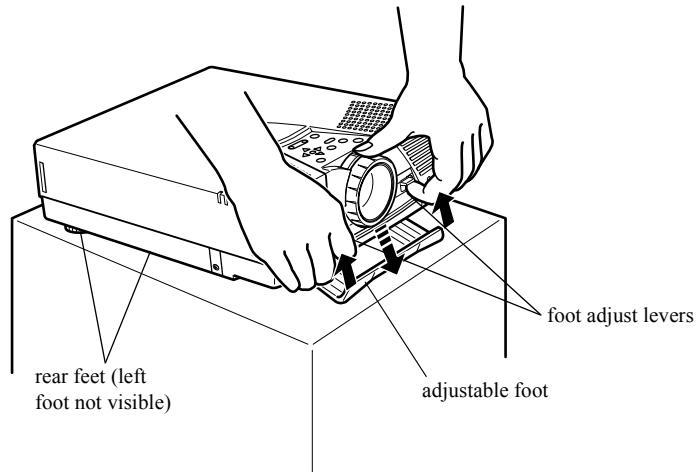

Caution: Don't hold or lift the projector by its lens. This can damage the lens.

2. While lifting the foot adjust levers, raise or lower the projector until the screen image is correctly positioned.

-
3. Release the levers to lock the foot in its new position. Make sure the foot is locked before letting go of the projector.
 4. If the projector is not on a level surface, level the projector by turning one of its rear feet to adjust its height.

Resizing the Projected Image

The Resize button lets you select the projection method for certain types of image signals input from a computer. Press the Resize button on the control panel or the remote control to select one of the following projection methods for your projector.

PowerLite 5550C:

- p With images less than SVGA size (800 × 600 pixels), you can either display the image in the center of the projection area or display it full size.
- p With images greater than SVGA size (up to 1024 × 768 pixels), you can project the entire image in a compressed format. If you keep pressing the Resize button, the projector will pan around areas of the image. The projector automatically reduces the image size to the projector's maximum resolution.

***Note:** The Resize button cannot be used with images at SVGA resolution.*

PowerLite 7550C:

- p With images less than XGA size (1024 × 768 pixels), you can either display the image in the center of the projection area or display it full size.

-
- p With images greater than XGA size, you can either project a portion of the image or project the entire image in a compressed format. If you keep pressing the Resize button, the projector will pan around areas of the image. The projector automatically reduces the image size to the projector's maximum resolution.

Note: The Resize button cannot be used with images at XGA resolution.

Controlling the Projector

You can use the remote control or the control panel on top of the projector to do the following:

- p Turn the power on or off
- p Display the help menu
- p Switch between input sources (video or computer)
- p Access the projector menus to adjust video, audio, and basic projector settings
- p Resize the projected image (see “Resizing the Projected Image” on page 56)
- p Adjust the volume
- p Temporarily display a blank screen and turn off sound (AV/Mute button)
- p Freeze the display (remote control only)
- p Display special effects assigned to the Effects buttons (remote control only)

Using the Remote Control

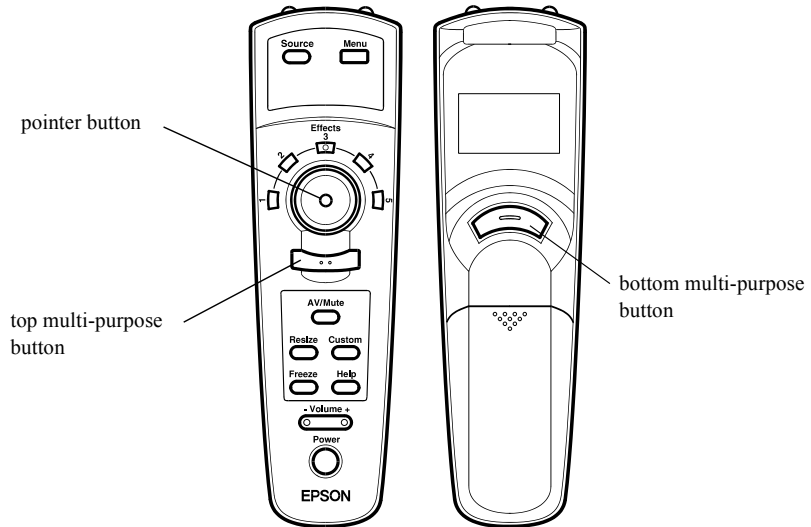

The remote control uses a line-of-sight infrared signal. To use the remote control, point it toward the infrared receiver located at the front of the projector (see page 50).

Note: To be able to use the remote control as a wireless mouse, make sure you've connected the mouse cable to the projector and your computer. (See Chapter 1 for instructions.)

You can use the remote control up to 32.8 feet (10 meters) from the projector. (This distance may be shorter if the remote control batteries are low.) You must also hold the remote control so that it is within $\pm 30^\circ$ left or right of, and $\pm 15^\circ$ higher or lower than, the infrared receiver.

***Note:** If the projector doesn't respond to remote commands, the room may be too light or a strong light source (such as direct sunlight) may be hitting the infrared receiver. The presence of a certain type of fluorescent light or equipment emitting infrared energy (such as a radiant room heater) can also interfere with transmission of remote commands.*

This table summarizes the functions on the remote control.

Button	Function
Source	Switches the input source between computer and video.
Menu	Displays or hides the active menu. When a submenu is displayed, returns to the main menu.
Effects buttons	Press each Effects button to use its assigned function. The function may be a factory default, or you can assign a new one with the optional ELP Link III software. See "Using the Effects buttons" on page 60 for default settings.
Pointer button	Lets you navigate the menus. Press left or right to select menu options. Can also be used as a mouse pointer in place of the computer's mouse pointer. (The projector must be connected to the computer with the mouse cable included with the projector, or with the ELP Link III mouse cable.)

Button	Function
Top multi-purpose button	Acts as a right mouse click. Press to open submenus.
Bottom multi-purpose button	Acts as a left mouse click. Press to open submenus.
AV/Mute	Turns the projector's audio and video output off and back on again—clears all special effects, and displays a black, blue, or user-defined logo screen.
Resize	Resizes the image on the screen to match the resolution of your computer display. See page 56 for details.
Custom	Lets you zoom the image using the top (zoom out) and bottom (zoom in) multi-purpose buttons.
Freeze	Keeps the current computer or video image on the screen until pressed again.
Help	Displays the Help menu. See “Using the Online Help Menu” on page 140 for details.
– Volume +	Adjusts the volume.
Power	Turns the projector lamp on or off.

Using the Effects buttons

The Effects buttons on the remote control allow you to enhance your presentation with special effects (for example, you can use highlighting or a box or line to emphasize different parts of the

screen). Each button is assigned a function in the factory. You can use the Effect menu to modify the appearance and behavior of these functions. (See “Modifying the Special Effects” on page 81.)

If you have the optional ELP Link III software, you can assign different functions to each button, or you can program buttons with your own functions. (See “Assigning Functions to the Effects Buttons” on page 102 for details.)

To cancel a function, press the bottom multi-purpose button twice. To repeat a function, move the pointer to a new location and repeat the process.

The following table summarizes the default assignments.

Button	Function	Description
1	Pointer	Displays the pointer as a three-dimensional arrow (or other user-defined shape) rather than a flat black arrow.
2	Box	Draws a box on the screen: Press the Effects button, then press the bottom multi-purpose button once to define the position of one corner. Use the pointer button to move the pointer. Then press the bottom multi-purpose button again to define the position of the opposite corner of the box.

Button	Function	Description
3	Line	Draws a straight line on the screen: Press the Effects button, then press the bottom multi-purpose button once to define the line position. To draw another line, move the pointer away from the line you just created and press the bottom multi-purpose button again to define the new line position.
4	Marker	Lets you highlight an area of the screen with a colored bar: Press the Effects button, then press the bottom multi-purpose button once to define the start position for the bar. Use the pointer button to select the end point of the bar. To draw another bar, move the pointer to the area you want to highlight and repeat the process. (This function can create horizontal and vertical bars only; it cannot draw diagonal lines.)
5	Clear	Clears the screen of all special effects.

Using the Control Panel

Although you must use the remote control to access custom features, such as functions assigned to the Effects buttons, you can use the control panel to perform most standard operations, such as selecting menu options, adjusting volume, or resizing the image on the screen.

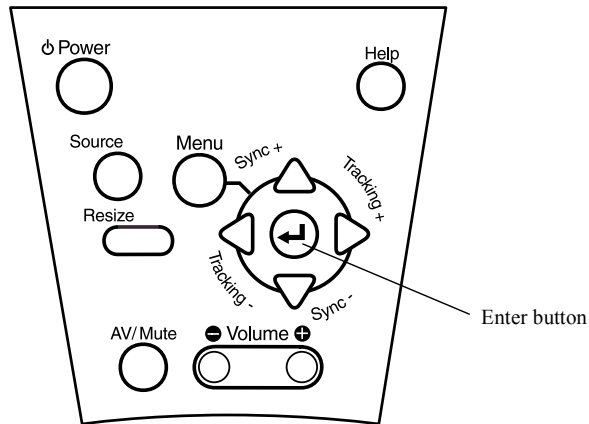

The following table summarizes the functions on the control panel.

Button	Function
Power	Turns the projector lamp on or off.
Source	Switches the input source between computer and video.
Menu	Displays or hides the active menu.
Up, down arrows (Sync+/Sync-)	Synchronize the computer's graphic signal to remove flicker. Also let you navigate menus.
Left, right arrows (tracking-/ tracking+)	Correct vertical fuzzy lines by matching the projector's internal clock to various computer graphic signals (tracking adjustment). Change menu settings.
Enter 	Selects a menu option.
Resize	Resizes the image on the screen to match the resolution of your computer display. See page 56 for details.
AV/Mute	Turns the projector's audio and video output off and back on again—clears all special effects, and displays a black, blue, or user-defined logo screen.
- Volume +	Adjusts the volume.
Help	Displays the Help menu. See "Using the Online Help Menu" on page 140 for details.

Projector Status Lights

The lights on top of the projector tell you about its operating status.

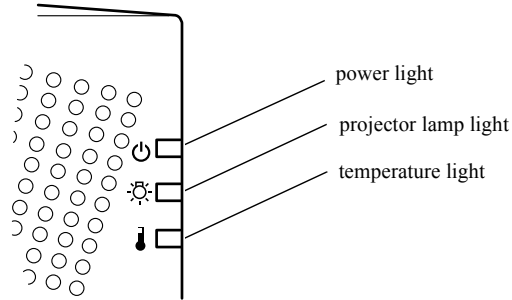

Caution: A red light warns you if a serious problem occurs. See Chapter 6, “Troubleshooting,” for what to do if a warning light comes on.

Power Light

Light status	Meaning
Steady orange	The projector is in sleep mode. (The projector is plugged in, but not projecting.)
Steady green	Power and projector lamp are on.
Flashing green	The projector is warming up. Allow about 30 seconds.
Flashing orange	The projector is cooling down.
Off	There is an internal projector problem, or the power to the projector has been cut off.

Projector Lamp Light

Light status	Meaning
Orange and red flashing alternately	The lamp needs to be replaced. See “Replacing the Lamp” on page 134 for instructions.
Steady red	Projector lamp has burned out. Replace it to project images. See “Replacing the Lamp” on page 134 for instructions.
Flashing red	There’s a problem with the projector lamp, lamp power supply, or lamp fuse, or a circuit malfunctioned in the projector.
Off	The lamp is functioning normally.

Temperature Light

Light status	Meaning
Flashing orange	Projector is too hot.
Steady red	Projector has turned off automatically because of overheating.
Flashing red	There’s a problem with the cooling fan or temperature sensor. Call a service representative.
Off	The projector is functioning normally.

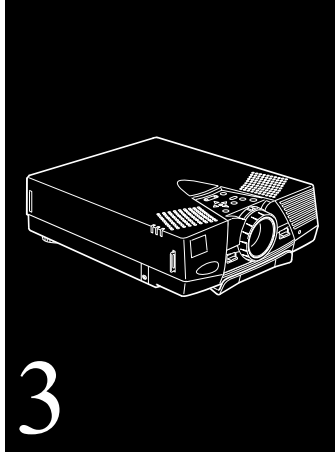

Adjusting Projector Settings

You can use the buttons on the remote control or the projector's control panel to access seven projector menus, which let you control the following settings:

- p The Video menu controls the look and quality of the projected image, whether the image source is a computer or another video source (for example, a VCR).
- p The Audio menu controls audio features, such as the volume level, tone setting, and stereo sound.
- p The Setting menu lets you adjust basic projector options.
- p The User's Logo menu lets you define a logo for the screen and assign it to the AV/Mute button.

-
- p The Effect menu lets you modify the appearance of the default special effects assigned to the Effects buttons on the remote control. (To assign different functions to the buttons, you need the optional ELP Link III software. See “Assigning Functions to the Effects Buttons” on page 102 for more information.)
 - p The About menu displays basic information about the projector, such as the number of hours the lamp has been used or the video signal being used.
 - p The Reset All menu returns the settings in all menus to their factory defaults.

***Note:** If you have the optional ELP Link III software, you can also adjust these settings from your computer. See “Changing Projector Settings” on page 118 for more information.*

Accessing the Main Menu

To display the Main menu, press the Menu button on the control panel or the remote control. The Main menu appears:



Press the Menu button again to hide the menu.

Changing a Menu Setting

To change a menu setting:

1. Press the Menu button on the control panel or remote control to display the Main menu.
2. Press the up or down arrows (control panel) or press up or down on the pointer button (remote) to scroll through the menu choices.

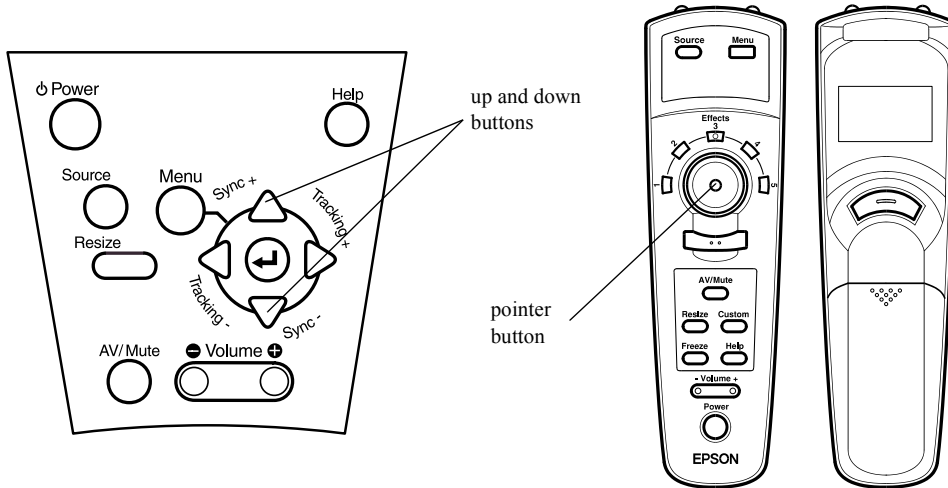

As you select a menu, a submenu of options appears to the right. The options available in some submenus vary, depending on whether the current image source is the computer or a video source.

3. Press either the Enter  button (control panel) or the top or bottom multi-purpose button (remote) to move to a submenu list.

The following screen display shows the options for the Video menu when the image source is the computer.

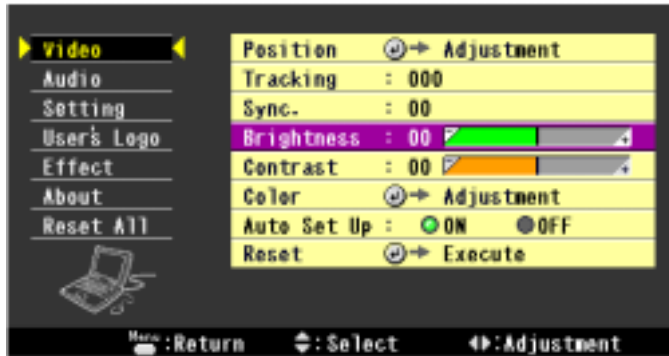





4. Press the up or down arrows (control panel) or press up or down on the pointer button (remote) to scroll through the submenu options.
5. Press either the left or right arrow buttons (control panel) or press right or left on the pointer button (remote) to change a setting on one of the submenus.
6. When you have finished changing settings, press the Menu button to go back to the Main menu (you may need to press it more than once). Your changes are saved automatically.

Adjusting Video Settings (Image Source = Computer)

You can adjust the projected image by using the Video menu. The following options are available when the image source is Computer.

***Note:** The computer must be connected and operating, and the image source on the projector must be set to Computer for you to access these menu options. To change the image source on the projector, press the Source button on the remote control or control panel.*

Menu item	Description
Position	Select this item by pressing the Enter  button (control panel) or the top or bottom multi-purpose button (remote) to enter screen position (H/V) adjustment mode. Then use the pointer button (remote) or up, down, left, and right buttons (control panel) to move the screen position in the corresponding direction. When you finish making adjustments, press the Menu button on the control panel or the remote to return to the Video menu.
Tracking	Matches the projector's internal clock to various computer graphic signals. Adjust this setting to remove vertical lines from the image.
Sync.	Synchronizes with the tracking signal sent from the computer. Adjust this setting to correct fuzziness or screen flicker.
Brightness	Lightens or darkens the overall image. Increase brightness to lighten an image, or decrease it to darken the image.
Contrast	Adjusts the difference between light and dark areas. Increase the contrast to make light areas lighter and dark areas darker. Decrease it to minimize the difference between light and dark areas.



Menu item	Description
Color	<p>Adjusts the color balance of the input source.</p> <p>Select this item by pressing the Enter  button (control panel) or press either multi-purpose button on the remote. The projector enters color adjustment mode. Use the pointer button (remote) or up and down buttons (control panel) to select a color.</p> <p>Next, use the pointer button (remote) or left and right buttons (control panel) to adjust the selected color. Increase the setting for more intense color, or lower the setting for less intense color.</p> <p>When you finish making adjustments, press the Menu button on the control panel or the remote to return to the Video menu.</p>
Auto Set Up	<p>When enabled, this feature allows the projector to sense the computer signal input and adjust it to the current projector settings. If the projector doesn't automatically recognize the video source, disable this option. Then adjust the tracking and sync settings. If this does not resolve the problem, try setting your computer's video to a different resolution or refresh rate.</p>
Reset	<p>Returns all menu items to their factory defaults.</p> <p>Select this item and then press the Enter  button (control panel) or either multi-purpose button (remote) to display the confirmation screen.</p> <p>Next, select Yes and then press the Enter  button (control panel) or a multi-purpose button (remote) to reset the menu.</p> <p>If you change your mind, select No and then press a multi-purpose button (remote) or the Enter  button (control panel) to clear the confirmation screen without changing any settings.</p>

Adjusting Video Settings (Image Source = Video)

You can adjust the projected image by using the Video menu. The following options are available when the image source is Video.

***Note:** The projector's image source must be set to Video, and the video source (such as a VCR or camcorder) must be connected and operating for you to access these menu options (for example, the projector must actually be projecting an image from a video tape, if you're using a VCR). To change the image source on the projector, press the Source button on either the remote control or control panel.*

Menu item	Description
Brightness	Lightens or darkens the overall image. Increase brightness to lighten an image, or decrease it to darken the image.
Contrast	Adjusts the difference between light and dark areas. Increase the contrast to make light areas lighter and dark areas darker. Decrease it to minimize the difference between light and dark areas.
Color	Adjusts color density. Increase the setting for darker and more opaque colors. Decrease it for lighter and less opaque colors.
Tint (NTSC only)	Adjusts the red-green color balance of the screen. Increase tint to add more green, or decrease it to add more red. This setting only works with NTSC video signals.
Sharpness	Adjusts the sharpness of the screen image.

Menu item	Description
Reset	<p>Returns all menu items to their factory defaults.</p> <p>Select this item and then press the Enter  button (control panel) or a multi-purpose button (remote) to display the confirmation screen. Next, select Yes and then press a multi-purpose button (remote) or the Enter  button (control panel) to reset the Video Menu.</p> <p>If you change your mind, select No and then press a multi-purpose button (remote) or the Enter  button (control panel) to clear the confirmation screen without changing any settings.</p>

Adjusting Audio Settings

You can use the Audio menu to adjust the settings shown in the following table.



Menu item	Description
Volume	Adjusts the volume level for the speakers and audio-out terminal.
Treble	Adjusts the treble tone of the speakers. Press the right arrow button (control panel) or press right on the pointer button (remote) to increase the treble tone. Press the left arrow button (control panel) or left on the pointer button (remote) to decrease the treble tone.
Bass	Adjusts the bass tone of the speakers. See Treble for details.
SRS SPACE	Adjusts stereo sound. Increasing the value widens the sound.

Menu item	Description
SRS CENTER	Adjusts stereo sound. Use this setting to balance the stereo sound.
Reset	<p>Returns all menu items to their factory defaults.</p> <p>Select this item and then press the Enter ↵ button (control panel) or a multi-purpose button (remote) to display the confirmation screen. Next, select Yes and then press a multi-purpose button (remote) or the Enter ↵ button (control panel) to reset the Video menu.</p> <p>If you change your mind, select No and then press a multi-purpose button (remote) or the Enter ↵ button (control panel) to clear the confirmation screen without changing any settings.</p>

Changing Basic Projector Settings

You can adjust basic projector settings by using the Setting menu.

Menu item	Description
Prompt	Temporarily displays a message on the projector screen to identify which source (computer or video) is providing the image. Select OFF if you don't want this prompt to appear.
Color Temperature	Adjusts the whiteness of the screen. Positive color temperature values provide a cold white; negative values provide a warmer white. Press the right arrow button (control panel) or press right on the pointer button (remote) to increase the color temperature value. Press the left arrow button (control panel) or left on the pointer button (remote) to decrease the color temperature value.

Menu item	Description
Ceiling	Flips the projected image so it looks correct when you're hanging the projector upside-down from the ceiling. Selecting ON turns this feature on, while OFF turns it off (for a normal image).
Rear Projection	Mirrors the projected image so it looks correct when you're projecting from behind onto a translucent screen. Selecting ON turns mirroring on, while OFF turns it off (for a normal image).
Blank (AV/Mute)	Specifies whether a black screen, a blue screen, or a user-defined logo displays when the screen is blanked. See page 78 and page 126 for more information about creating a user logo.
Video Signal	Specifies the input image signal mode. You can select from AUTO, NTSC, NTSC 4.43, PAL, PAL N, PAL M, PAL 60, and SECAM.
Language	Selects the menu language: Japanese, English, French, German, Italian, Spanish, or Portuguese.
Reset	<p>Returns all menu items to their factory defaults.</p> <p>Select this item and then press the Enter  button (control panel) or a multi-purpose button (remote) to display the confirmation screen. Next, select Yes and then press a multi-purpose button (remote) or the Enter  button (control panel) to reset the Setting menu.</p> <p>If you change your mind, select No and then press a multi-purpose button (remote) or the Enter  button (control panel) to clear the confirmation screen without changing any settings.</p>

Creating and Assigning a User Logo

You can use the User's Logo menu to define a logo for the screen and assign it to the AV/Mute button. Once you've assigned a logo, you can press the AV/Mute button on either the remote control or the control panel to display the logo.

Creating the User Logo

Follow these steps to create and store a logo:

1. Display the image (with the projector) you wish to use as a logo.
2. Press the Menu button to open the Main menu.
3. Select the User's Logo menu by pressing the down arrow button on the control panel or the pointer button on the remote control. Then press the Enter button to display the User's Logo Setting window.
4. The message, "Do you use the present image as a user logo?" appears on the screen. Choose Yes or No by pressing the left or right arrow buttons on the control panel or pressing left or right on the pointer on the remote control. Then press Enter.
5. A selection box appears over the image. To select the portion of the image you wish to use as the logo, use the arrow buttons on the control panel or the pointer button on the remote control. Once you've selected the desired area, press the Enter button.

-
6. The message “Do you use this image?” appears on the screen. Select Yes and press the Enter button. If you want to change the position, select No.
 7. Next, the Zoom rate setting window appears on the screen. Select a rate using the arrow buttons or pointer, then press the Enter button.
 8. The message “Do you save the user logo?” appears on the screen. Select Yes and press the Enter button. If you don’t want to save the logo, select No.

***Note:** Saving the logo may take a moment. Don’t use the projector or other sources (computer, video, speaker, etc.) while the logo is being saved.*

9. When the message “Saving the user logo is completed.” appears on the screen, press the Menu or Enter button to display the Main menu.

Assigning the Logo to the AV/Mute Button



Follow these steps to assign the logo to the AV/Mute button:

1. Press the Menu button to open the Main menu.
2. Select the Setting menu and press the Enter button.
3. Select the Blank (AV/Mute) option, then highlight Logo.
4. Press the Menu button to return to the Main menu.

Now you can press the AV/Mute button on the control panel or the remote control to display your logo. Press it again when you want to stop displaying the logo.

Modifying the Special Effects

The Effect menu lets you modify the appearance of special effects. You can also use it to change the cursor speed or reset the Effects buttons to their factory defaults.

Item	Description
Pointer	Changes the pointer's shape and size. (This is similar to the Cursor Change function in the ELP Link III software; see page 105 and page 109.)
Box	Specifies the color of the box outline.
Line	Specifies the line width and color.
Marker	Specifies the color and width of highlighting.
Clear	Clears the screen of special effects.
Cursor Speed	Sets the cursor (pointer) speed to Low, Middle, or High.
Reset	Returns all functions assigned to the Effects buttons to their factory defaults. Select this item and then press the Enter  button (control panel) or a multi-purpose button (remote) to display the confirmation screen. Next, select Yes and then press a multi-purpose button (remote) or the Enter  button (control panel) to reset the Effect menu. If you change your mind, select No and then press a multi-purpose button (remote) or the Enter  button (control panel) to clear the confirmation screen without changing any settings.

If you have the optional ELP Link III software, you can reconfigure the Effects buttons with different functions. See “Assigning Functions to the Effects Buttons” on page 102 for more information.

Displaying Information About Your Projector

The About menu displays information about your projector. You see the following when the image source is Computer:

Item	Description
Frequency	Displays the horizontal and vertical frequency of the computer.
Resolution	Displays the output resolution of the computer video output.
Refresh Rate	Displays the refresh rate of the computer video output.
Lamp	Displays the number of hours the current lamp has been used. The lamp light flashes orange and red when the projector lamp is near the end of its normal life. When this happens, replace the projector lamp with a new one as soon as possible.

You see the following when the image source is Video:

Item	Description
Video Signal	Displays the video signal.
Lamp	Displays the number of hours the current lamp has been used. The lamp light flashes orange and red when the projector lamp is near the end of its normal life. When this happens, replace the lamp with a new one as soon as possible.

Resetting All Menu Options

Selecting the Reset All menu option from the Main Menu resets the settings in all menus to their factory defaults. It does not change or delete any user logo you may have stored.

You will be prompted to confirm the reset action. Select Yes or No, then press the top or bottom multi-purpose button (remote) or the Enter button (control panel) to reset all the settings.

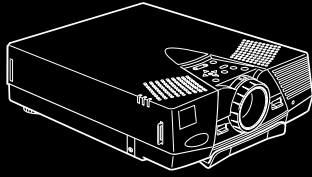

4

Using ELP Link III

The optional ELP Link III software gives you greater flexibility in using your projector. Its most important advantage is that it allows you to control the projector from a computer. However, it also lets you do the following:

- p Reconfigure the remote control's Effects buttons with a wider range of functions, and even program Effects buttons with your own functions
- p Assign functions to your keyboard so that you can enable special effects without using the remote control
- p Test projector performance
- p Adjust the images you project to show greater detail

***Note:** If your computer doesn't have a PS/2 mouse connector, you must use the ELP Link III kit to connect the projector to a computer.*

If you purchased the optional ELP Link III kit, you need to connect the special ELP Link III cables after you've finished connecting the projector's power cable, video cable, and audio cable (if needed), as described in Chapter 1.

This chapter covers:

- p Unpacking the ELP Link III kit
- p Connecting the ELP Link III cables
- p Installing the software
- p Using the software

Unpacking the ELP Link III Kit

When you unpack the ELP Link III kit, make sure you have all these components:

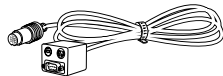

Main cable

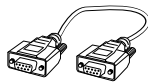

9-pin serial cable (PC set)

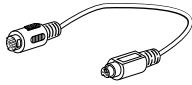

PS/2 mouse cable* (PC set)

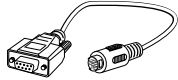

Serial mouse cable (PC set)

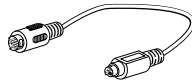

Mouse cable* (Mac set)

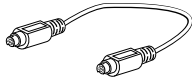

Serial cable (Mac set)



ELP Link III software on CD-ROM
(PC or Mac)

** These mouse cables are different from the cables included with your projector.*

Connecting the ELP Link III Cables

To use the ELP Link III software, you need to connect the ELP Link III main cable and the special ELP Link III serial cable. If you want to use the remote control as a mouse, you also need to connect the ELP Link III mouse cable.

You should already have connected the power cord, the projector's video cable, and any other cables required for the equipment you are using, as described in Chapter 1.

Note: To keep the illustrations in this section simple, the pictures show only how to connect the ELP Link III cables; they don't show the power, video, or other cables you already connected.

Connecting to a PC Desktop or Laptop

The following instructions explain how to connect the ELP Link III cables to your PC desktop or laptop computer. The steps are identical for both types of computers except where noted otherwise.

You must connect both the main cable and the 9-pin serial cable that came with the ELP Link III kit to use the ELP Link III software and the Effects buttons on the remote control. If you want to use your remote control as a computer mouse, you need to connect either the PS/2 or the serial mouse cable that came with the kit.

Before you start, make sure the projector and computer are turned off.

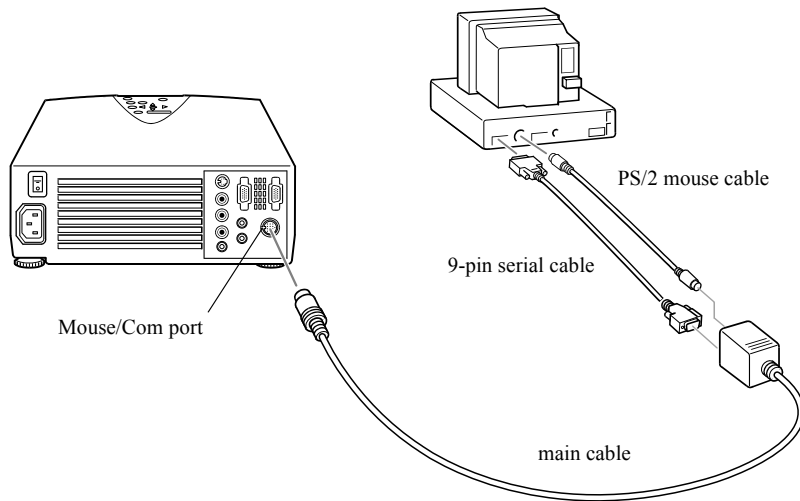

Note: *This illustration shows a desktop, but the steps are the same if you have a laptop.*

1. If you connected the PS/2 mouse cable that came with the projector—as described on page 26 (desktop) or page 30 (laptop)—disconnect it from the computer and the projector.

2. Connect the round end of the main cable to the projector's Mouse/Com port.

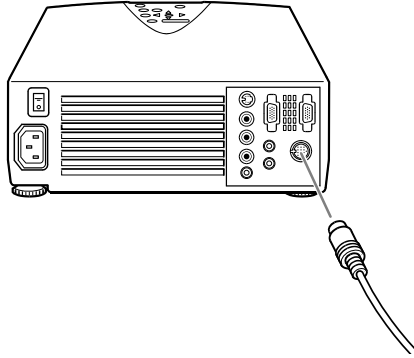

3. Connect one end of the PC serial cable to the PC SERIAL terminal on the square end of the main cable.

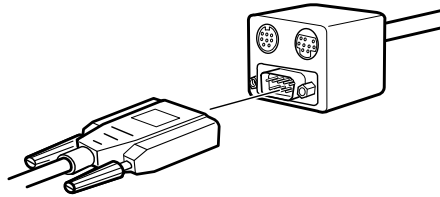

Note: You won't be able to use the ELP Link III software if your system has only one serial port that is being used to support a serial mouse.

-
4. Connect the other end of the PC serial cable to the serial port on the back of your computer.
 5. If you want to use the remote control as a mouse for your computer, connect the 9-pin end of the PS/2 mouse cable that came with your ELP Link III kit to the MOUSE terminal on the square end of the main cable.

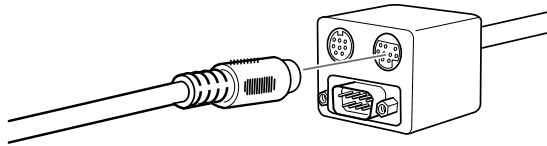

Note: If your computer uses a serial mouse, perform steps 5 and 6 using the serial mouse cable that came with your ELP Link III kit instead of the PS/2 mouse cable.

6. Connect the other end of the PS/2 mouse cable to your computer's mouse port.
7. Tighten the screws on all connectors.
8. If you have a laptop, configure it to work with an external mouse. You may have to set the display to appear on both the laptop's screen and the projector. Some laptops let you change this setting with the keyboard's function keys, or by using a setup utility provided by the computer manufacturer. Check your laptop's manual for instructions.
9. Go to page 96 to install the software.

Connecting to a Macintosh Desktop or PowerBook

The following instructions explain how to connect the ELP Link III cables to your Macintosh desktop or PowerBook. The steps are the same for both types of computers except where noted otherwise.

You must connect both the main cable and the Mac serial cable that came with the ELP Link III kit to use the ELP Link III software and the Effects buttons on the remote control. If you want to use your remote control as a computer mouse, you need to connect the Mac mouse cable that came with the kit.

Before you start, make sure the projector and computer are turned off.

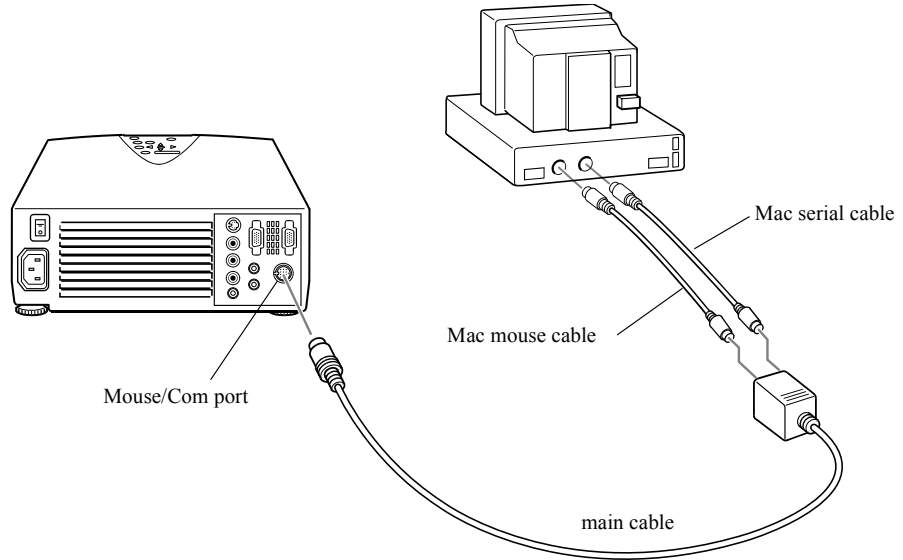

Note: This illustration shows a desktop, but the steps are the same if you have a PowerBook.

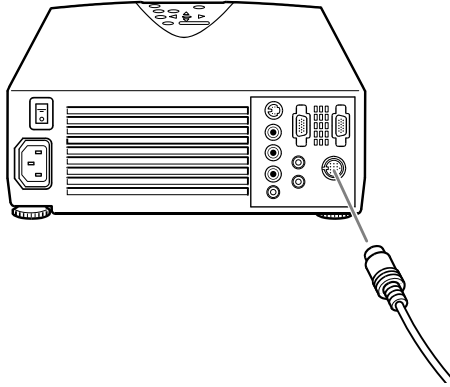

1. If you connected the Mac mouse cable that came with the projector—as described on page 36 (desktop) or page 42 (PowerBook)—disconnect it from your computer and the projector.

2. Connect the round end of the main cable to the projector's Mouse/Com port.

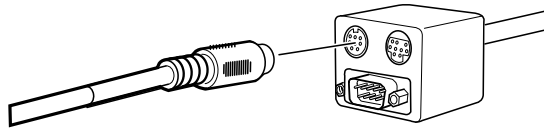

3. Connect one end of the Mac serial cable that came with the ELP Link III kit to the MAC SERIAL terminal on the square end of the main cable.



4. Connect the other end of the Mac serial cable to the  printer or  modem port on the back of your computer.

-
5. If you want to use the remote control as a mouse for your Macintosh, connect the 9-pin end of the Mac mouse cable that came with the ELP Link III kit to the MOUSE terminal on the square end of the main cable.

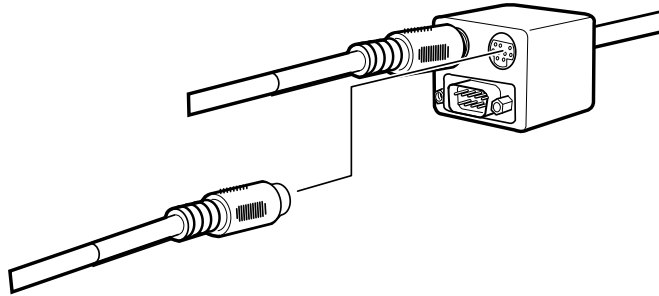

6. Connect the other end (labeled MAC MOUSE) of the Mac mouse cable that came with the ELP Link III kit to the mouse port on your computer.

***Note:** If you have a PowerBook, you may need to choose Mirroring in the Display Control Panel to display the image on the PowerBook screen as well as the projector screen. See your Macintosh documentation for details. (This step is not necessary on some newer systems, which can detect a dual video signal.)*

7. Go to page 97 to install the software.

Installing the ELP Link III Software

You can use the ELP Link III software on any Windows system, and on Macintosh OS System 7.x and OS System 8.x.

Installing the Software for Windows

1. Turn on your computer and start Windows.
2. Close any open Windows applications and turn off any screen savers.
3. Insert the Projector Software CD into your CD-ROM drive.
4. If you have Windows 95, 98, or NT, the installer program should start automatically. Go to step 5. If it doesn't, click Start, then Run and type E:\SETUP (substitute the correct drive letter for your CD-ROM drive if it is not E). Then click OK.

If you have Windows 3.x, open Program Manager and select Run from the File menu. In the Run dialog box, type E:\SETUP (substitute the correct drive letter for your CD-ROM drive if it is not E), then click OK.

5. When you see the ELP Link III welcome screen, select the language you want to use and click OK.
6. Select your projector model (ELP/EMP/PowerLite 5500 [or 7500] series) from the pull-down list and click Next.

-
7. The next screen asks if you want to install the ELP Link III User's Guide and Adobe® Acrobat® Reader. Select the User's Guide if you want to install it and Acrobat Reader if it is not already installed on your system. Then click Install.
 8. Follow the instructions on the screen to install the software. When the installation is complete, click Finish.

Installing the Software on a Macintosh

1. Insert the Projector Software CD into your CD-ROM drive.
2. Double-click the ELP Link icon if the program doesn't open automatically. Then double-click the Installer icon. You see a dialog box asking you to select a language to use.
3. Select a language and click OK.
4. Select your projector model (ELP/EMP/PowerLite 5500 [or 7500] series) from the pull-down list and click OK. You see the software license agreement.
5. Read the agreement and click Accept to continue. You see the Installer screen.
6. Select either Easy Install or Custom Install from the pull-down list at the top of the screen. The Easy installation automatically installs the ELP Link III software, the online ELP Link III User's Guide and Acrobat Reader (if it is not already installed on your system). If you select Custom Install, you then need to select which of the following items to install: ELP Link III V2.0, ELP Link III User's Guide, and Acrobat Reader.

Check the items you want to install; ELP Link III V2.0 must be installed, but the User's Guide and Acrobat Reader are optional.

7. Click Install to install the software on your hard disk.
8. When installation is complete, click Quit. If you are installing Acrobat Reader, you see the Acrobat Reader 3.0 Installer screen.
9. Click Continue. You see the software license agreement for Acrobat Reader 3.0.
10. If you don't want to install Acrobat Reader, click Decline. Otherwise, click Accept and follow the instructions on screen.
11. When installation is complete, restart your computer.

Starting ELP Link III

Before you start the ELP Link III program, make sure you've done the following:

- p Connected the necessary cables and installed the ELP Link III software
- p Turned on both the computer and projector
- p Disabled any screen savers

***Note:** You can also run the software without the projector, although you can't change projector settings or perform certain other tasks. See "Bringing out detail in your projected image" on page 128 for details.*

Starting the Program from Windows

If you have Windows 95, 98, or NT, click Start, point to Programs, ELPLink3, and then click the ELPLink3 program icon. The ELP Link III program icon appears minimized on the taskbar. Click the minimized icon.

If you have Windows 3.1x, double-click the ELPLink3 program group icon in the Program Manager. Then double-click the ELPLink3 icon.

The ELP Link III main dialog box appears:

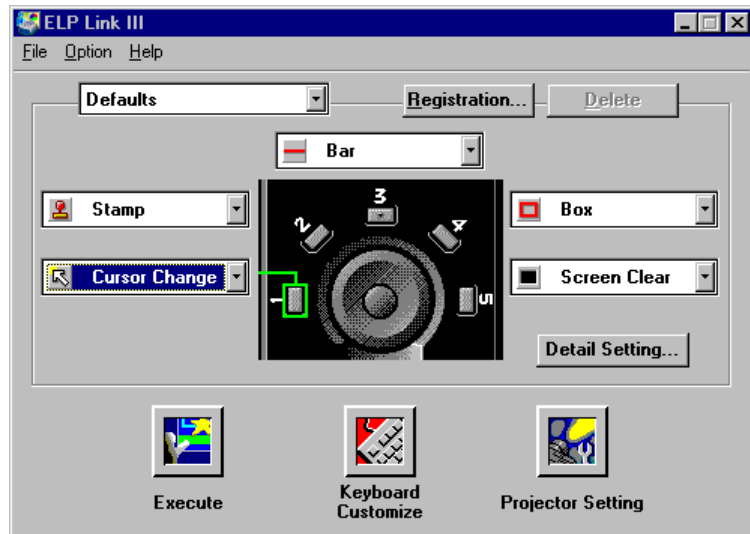



***Note:** If you see a prompt asking you to open the software or select a port, the projector may be disconnected or connected to an incorrect COM port. If you want to run the software without the projector connected, click Unconnected and Execute. If the projector is connected, click Select a port, and retry. Then select the COM port you're using on the next screen.*

Starting the Program on a Macintosh

1. Open the ELPLink3 folder.
2. Double-click the ELP Link 3 icon. ELP Link III starts and three menus—File, Option, and Help—appear at the top of the screen.

***Note:** If the projector is not connected to your Macintosh, or is connected to the wrong COM port, you see a message indicating that there is no response from the projector. If you want to run the software without the projector, click Unconnected and Execute. If the projector is connected, click Select a port, and retry, then select the COM port you're using on the next screen.*

3. If you're starting ELP Link III for the first time, select COM Port from the Option menu, then choose either the  printer or  modem port (whichever port you connected the serial cable to).
4. Select Property Setting from the Option menu. You see the ELP Link III main dialog box.

***Note:** Your Macintosh screens may look slightly different than the screens shown in this chapter.*

Changing the COM Port Assignment

If you didn't select the correct COM (communication) port when setting up the software, or if you've changed the COM port to which the projector is connected, you can change the COM port setting from the ELP Link III software.

1. Select Com Port from the Option menu.
2. Choose a COM port from the list that appears.

Assigning Functions to the Effects Buttons

You can use the ELP Link III software to assign different functions to the remote control's Effects buttons or program Effects buttons with your own customized functions. You can also save the assignments you make as a set, then recall that set at a later date when you want to use it for a different presentation.

You assign functions from the ELP Link III main dialog box.

select Defaults here to return all button assignments to their default values

select a function from this list box for Effects button 1

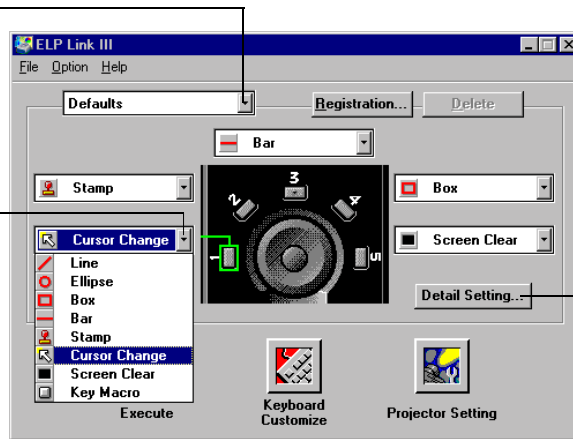

click here to modify a function or define a key macro

Note: For information about default assignments to the Effects buttons, see “Using the Effects buttons” on page 61. For information about defining key macros, see “Defining and Using Key Macros” on page 110.

You can return Effects button assignments to their default values at any time by selecting Defaults in the list box in the upper left corner of the ELP Link III main dialog box.

Follow these steps to change Effects button assignments:

1. Click the list box that corresponds to the button you want to change and select a new function from the list. (See the screen on the preceding page.)
2. Repeat step 1 for each button to which you want to assign a new function.
3. If you want to modify any of the functions, click Detail Setting and follow the instructions in “Modifying Functions” on page 107.
4. If you want to create more than one set of button assignments, go to “Saving and Recalling Effects Button Assignments” on page 112. Otherwise, continue with step 5.
5. Click the Execute button at the bottom of the ELP Link III main dialog box when you’ve made all your changes.

If you created only one set of Effects button assignments, these assignments will be active whenever you use the Effects buttons. If you created more than one set of assignments, the last set you created will be active until you select a different set.

Note: *You will not be able to use the Effects buttons if ELP Link III is active. Minimize or close the program first.*

The table below describes the available functions and how to use them.

Function	Description and usage
Line	<p>Draws a straight line on the screen.</p> <p>Press the Effects button assigned to this effect. Then press the bottom multi-purpose button once to define the line start position. Move the pointer using the remote pointer button. Then press the bottom multi-purpose button again to define the line end position. To draw another line, position the pointer where you want the line to start and press the bottom multi-purpose button again to define the new line start position.</p>
Ellipse	<p>Draws an ellipse (oval) on the screen.</p> <p>Press the Effects button assigned to this effect. Then press the bottom multi-purpose button once to define the start position of the ellipse. Move the pointer using the remote pointer button. Then press the bottom multi-purpose button again to define the end position of the ellipse. To draw another ellipse, position the pointer where you want the ellipse to start and press the bottom multi-purpose button again to define the start position for the new ellipse.</p>
Box	<p>Draws a box on the screen.</p> <p>Press the Effects button assigned to this effect. Then press the bottom multi-purpose button once to define the position of one corner of the box. Move the pointer using the remote pointer button. Then press the bottom multi-purpose button again to define the position of the opposite corner of the box. To draw another box, position the pointer where you want the box to start and press the bottom multi-purpose button again to define the start position for the new box.</p>

Function	Description and usage
Bar	<p>Creates a horizontal or vertical bar. You can use this function to highlight (or underline) a portion of the screen.</p> <p>Press the Effects button assigned to this effect. Move the bar using the remote pointer button. Press the bottom multi-purpose button to lock the bar in place. To draw another bar, move the pointer to the new bar location and press the bottom multi-purpose button again to lock the new bar in place.</p>
Stamp	<p>Leaves one or more copies of a pre-selected image on the screen.</p> <p>Press the Effects button assigned to this effect. Use the pointer button to place the stamp where you want it to appear. Then press the bottom multi-purpose button to lock the stamp in place. To display another stamp, move the pointer to the new stamp location and press the bottom multi-purpose button again to lock the new stamp in place.</p>
Cursor Change	<p>Changes the pointer shape from a flat arrow to a three-dimensional arrow or other shape.</p> <p>Press the assigned Effects button to display the new pointer shape.</p>
Screen Clear	<p>Clears all special effects from the screen.</p> <p>Press the assigned Effects button to clear the screen.</p>
Key Macro	<p>Pressing the assigned Effects button enters a key command that you've defined in the Detail Setting dialog box.</p> <p>You can assign different key macros to all five Effects buttons. You can also define a list of key macros that can all be assigned to the same Effects button, then cycle through the functions with each click of the button.</p> <p>See "Defining and Using Key Macros" on page 110 for more information.</p>

To cancel or end a function during a presentation, click the right mouse button (Windows), double-click your mouse (Macintosh) or press the top multi-purpose button (if you're using the remote control as a mouse).

Modifying Functions

Once you've assigned a function to an Effects button, you can specify detailed options for that function.

1. Click Detail Setting on the ELP Link III main dialog box. A dialog box similar to the following appears. (The options and tabs displayed depend on which functions are currently assigned to the Effects buttons.)

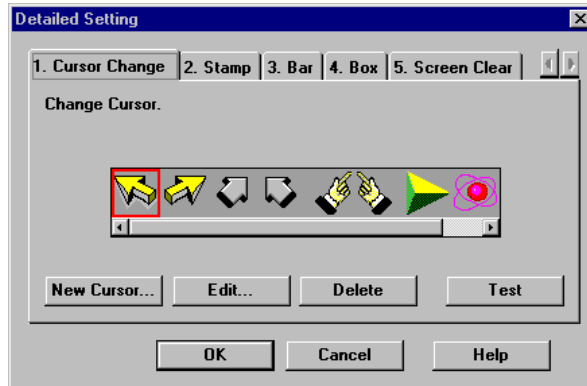

2. Click the tab for the function you want to adjust, then change any settings you wish.

3. To test each setting, click the Test button and use the effect as described in the table on the preceding pages.
4. To end the test, click the right mouse button (Windows) or double-click the mouse (Macintosh). If you're using the remote control as a mouse pointer, press the top multi-purpose button.
5. Click OK to save your changes and return to the ELP Link III main dialog box.

Your changes remain in effect until you enter new changes in the Detail Setting dialog box, so you can use the same style effect or the same key macros in different presentations.

The following table describes the options available for each function.

Function	Options	
Line	Width	Sets the line width, from 1 to 32 points.
	Grid	Specifies whether to have the line “snap” to the corners of a grid by entering the size of the sides of the box, in pixels (dots), up to 100.
	Color	Specifies a color for the line.
	Transparent	Makes the background text or image visible through the line.
Ellipse	Width	Sets the line width, from 1 to 32 points.
	Color	Specifies a color for the line.
	Transparent	Makes the background text or image visible through the ellipse.
	Fill	Fills the ellipse with color.

Function	Options	
Box	Width	Sets the line width, from 1 to 32 points.
	Color	Specifies a color for the line.
	Transparent	Makes the background text or image visible through the box.
	Fill	Fills the box with color.
	Make oval shape	Rounds the corners of the box.
Bar	Width	Sets the line width, from 1 to 300 points.
	Color	Specifies a color for the bar.
	Direction	Sets the direction of the bar horizontally or vertically.
	Transparent	Makes the background text or image visible through the bar.
Stamp	Selects a stamp. Click the stamp to be used, or click New Stamp to design your own stamp. You can also click Edit to make changes to the selected shape, or Delete to delete the selected shape.	
Cursor Change	Changes the pointer shape. Click the desired shape, or click New Cursor to design your own pointer. You can also click Edit to make changes to the selected shape, or Delete to delete the selected shape.	
Screen Clear	No options available.	
Key Macro	This tab lets you define up to 16 preset key commands (16 different custom functions) for the specified Effects button. See “Defining and Using Key Macros” below for step-by-step instructions.	

Defining and Using Key Macros

You can use key macros to assign your own customized functions to Effects buttons.

Follow these steps to define a key macro:

1. Select Key Macro as the function for an Effects button. (See “Assigning Functions to the Effects Buttons” on page 102 for details.)
2. Click Detail Setting on the ELP Link III main dialog box. You see the Detailed Setting dialog box:

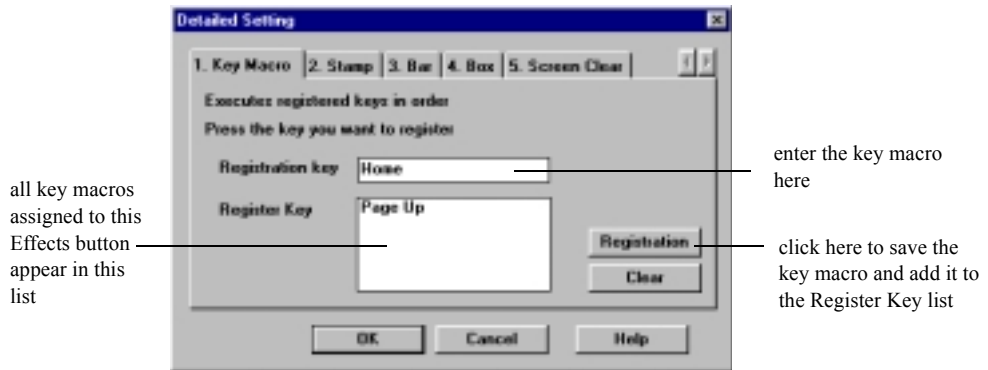

-
3. Position the cursor in the Registration key field and press a key to enter a key macro.

In addition to single keys, you can enter combination key macros, such as Ctrl + S. You can also enter key macros that help you navigate a presentation, such as Home, End, Page Up, and Page Down. If you enter the wrong key macro, just press the correct key(s) to overwrite it.

4. Click Registration to add the key macro to the Register Key field. You can register up to 16 key macros.

To clear all key macros in the Register Key field, click Clear.

5. Click OK to return to the ELP Link III main dialog box.

You can assign key macros to all five Effects buttons. If you assign several key macros to the same Effects button, click the button to cycle through the list. The Effects button executes each key macro in the order in which it appears in the Register Key field.

Saving and Recalling Effects Button Assignments

You can save more than one set of Effects button assignments if you want to use different functions with different presentations. You might also want to save more than one set if you want to use the same functions, but apply a different look to certain effects (for example, a different stamp or pointer).

click here to see the list
box of assignment
sets—select a set to use it
again, or select a set and
press Delete to delete it

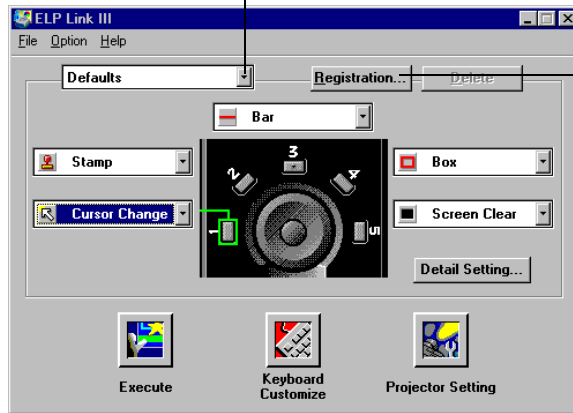

click here to
save a set of
button
assignments

Follow these steps to save a set of Effects button assignments:

1. Click Registration on the ELP Link III main dialog box.
2. When you see the Function Setting Register dialog box, type a name for the set and click OK.

If you create more than one set of Effects button assignments, the last set you created will be active until you select a different set.

***Note:** If you have multiple sets of Effects button assignments, make sure you register and name each new set. If you fail to register the set, it disappears as soon as you recall another set.*

To recall a set of button assignments, select its name from the list box in the upper left corner of the ELP Link III main dialog box. (You don't need to click Execute to activate the set.)

To delete a set of assignments from the list box, select its name and click Delete.

Assigning Functions to the Keyboard

You can also assign functions to keys or key combinations on your keyboard. Because these assignments remain in effect until you clear them, you can customize the keyboard of a computer that you frequently use with the projector. You can then use the keyboard instead of the Effects keys on the remote control.

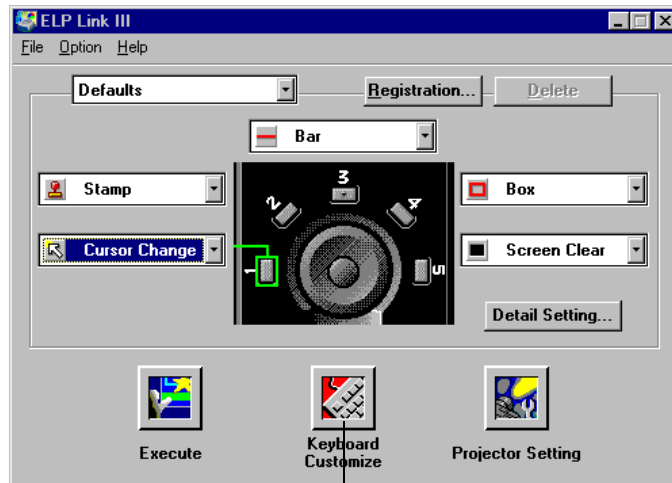

click to display the Keyboard
Customize Setting dialog box

Follow these steps to assign functions to the keyboard:

1. Click Keyboard Customize on the ELP Link III main dialog box. A dialog box similar to the following appears. (The functions listed are those currently assigned to the Effects buttons on the remote control.)

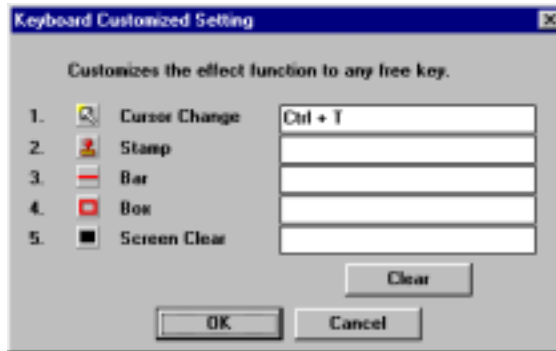

2. Position the cursor in the field beside each function and press a key or key combination. To use the combination of the Ctrl key and a second key, hold down the Ctrl key while you press the other key.

***Note:** To clear an assignment, position the cursor in the field you want to clear and click Clear.*

3. Click OK to return to the ELP Link III main dialog box.
4. If you want to make key assignments for additional functions, recall a new set of Effects button assignments in the main dialog box and repeat steps 1 through 3.

To use these functions, see the table on page 104. Instead of using the remote control's multi-purpose button, click the left mouse button (Windows) or click your mouse once (Macintosh) to define the beginning and end of lines, ellipses, boxes, and bars.

To modify functions, see "Modifying Functions" on page 107. To cancel or end a function during a presentation, click the right mouse button (Windows) or double-click your mouse (Macintosh).

Using the Projector Setting Dialog Box

You can use the Projector Setting dialog box to do the following:

- p Change projector settings
- p Test projector performance
- p Enhance details in your projected image by correcting problems with tone (gamma correction)
- p Create a custom logo to use with your presentations

To display the Projector Setting dialog box, click the Projector Setting button on the ELP Link III main dialog box. You see the Projector Setting window:

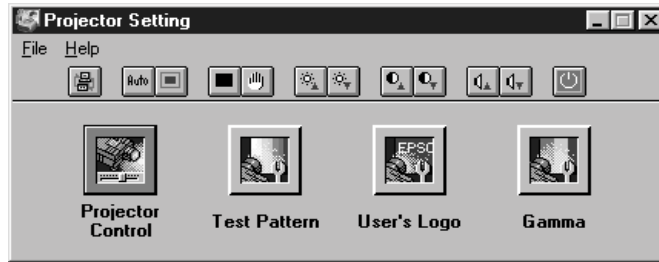

***Note:** Some options aren't available if you're running the software without the projector connected. See "Bringing out detail in your projected image" on page 128 for details.*

Using the Quick Change Toolbar

To quickly change some basic projector settings, click one of the buttons on the Projector Setting toolbar.

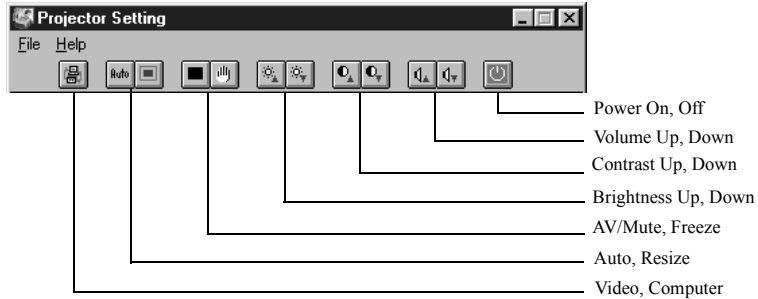

Changing Projector Settings

The settings you can adjust from the Projector Setting dialog box are almost the same as those available on the projector menus. (See Chapter 3 for information about projector menus.) However, when you access these settings from the Projector Setting dialog box, you can make your changes from a computer or central console.

Follow these steps to change projector settings:

1. Click Projector Control on the Projector Setting dialog box. The following dialog box appears:

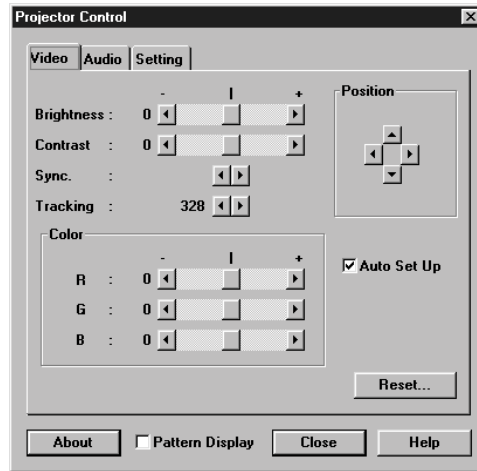

2. Click the tab for the settings you want to adjust. See the tables on the following pages for explanations of the different settings.
3. Make the changes you want, then click another tab if you want to make more changes. (To return to the default settings on a tab, click Reset.) When you're done, click Close.

Video tab (video source is a computer)

If the image source on your projector is set to Computer, you see the following options on the Video tab:

Option	Description
Brightness	Adjusts screen brightness. Increase brightness to lighten an image, or decrease it to darken the image.
Contrast	Adjusts the difference between light and dark areas. Increase the contrast to make light areas lighter and dark areas darker. Decrease it to minimize the difference between light and dark areas.
Sync.	Synchronizes with the tracking signal sent from the computer. Adjust this setting to correct fuzziness or screen flicker.
Tracking	Matches the projector's internal clock to various computer graphic signals. Adjust this setting to remove vertical lines from the image.
Color	Adjusts the balance of red, green, and blue in the image.
Position	Adjusts the horizontal and vertical screen position.
Auto Set Up	When enabled, this setting allows the projector to sense the graphic signal being sent from the computer and optimize it for the projector. If the projector doesn't automatically recognize the video source, select a different signal through your computer.
Pattern Display	Enables or disables display of the test pattern currently selected.
Reset	Resets all settings to their default values.

Video tab (video source other than a computer)

If the image source on your projector is set to Video, you see the following options on the Video tab:

Option	Description
Brightness	Adjusts screen brightness. Increase brightness to lighten an image, or decrease it to darken the image.
Contrast	Adjusts the difference between light and dark areas on the screen. Increase the contrast to make light areas lighter and dark areas darker. Decrease it to minimize the difference between light and dark areas.
Color	Adjusts the color density. Increase the setting for darker and more opaque colors. Decrease it for lighter and less opaque colors.
Tint (NTSC only)	Adjusts the red-green color balance of the screen. Increase tint to add more green, or decrease it to add more red. This setting only works with NTSC video signals.
Sharpness	Adjusts the sharpness of the screen image.
Pattern Display	Enables or disables display of the test pattern currently selected.
Reset	Resets all settings to their default values.

Audio tab

The Audio tab lets you make the following adjustments:

Option	Description
Volume	Adjusts sound volume for the speakers and audio-out terminal.

Option	Description
Treble	Adjusts the treble tone of the speakers.
Bass	Adjusts the bass tone of the speakers.
SRS SPACE	Adjusts stereo sound. Increasing the value increases the stereo sound separation.
SRS CENTER	Adjusts stereo sound. Changing the value balances the SRS sound.
Pattern Display	Enables or disables display of the test pattern currently selected.
Reset	Resets all settings to their default values.

Setting tab

The Setting tab enables you to adjust basic projector settings.

Option	Description
Blank (AV/MUTE)	Specifies whether a black screen, a blue screen, or a user-defined logo displays when the screen is blanked.
Install	Specifies how the projector is installed (if you are not using front projection): Rear Proj Use this setting when projecting to the back of a screen so the image is flipped left to right. Ceiling Use this setting when the projector is installed on the ceiling so the image is flipped top to bottom.
Prompt	Temporarily displays a prompt on the projector screen identifying which source (computer or video) is providing the image.
Color Temp	Adjusts the whiteness of the screen. Positive color temperature values provide a cold white; negative values provide a warmer white. Press the right arrow button on the control panel or press right on the remote's pointer button to increase the color temperature value; press the control panel's left arrow button or left on the remote's pointer button to decrease the color temperature value.
Mode	Specifies the input image signal mode: AUTO, NTSC, NTSC 4.43, PAL, PAL N, PAL M, PAL 60 or SECAM.
Pattern Display	Enables or disables display of the test pattern currently selected.
Reset	Resets all settings to their default values.

Testing Projector Performance

You can use the Test Pattern dialog box to test your projector's focus, resolution, color fidelity, and grayscale quality. Each of the test patterns on the dialog box tests a different aspect of projector performance.

1. Click Test Pattern on the Projector Setting dialog box. The following dialog box appears:

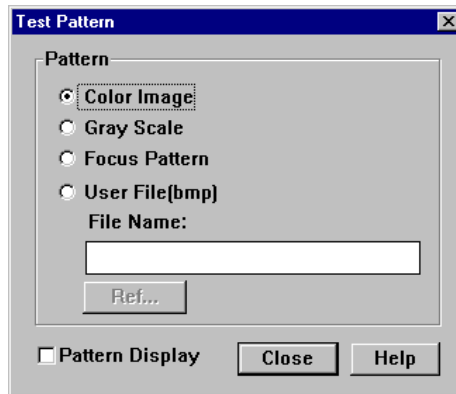

-
2. Choose one of the following:

Color Image	Displays a color bar test pattern to verify color accuracy.
Gray Scale	Displays a grayscale test pattern.
Focus Pattern	Displays a character-based focus pattern.
User File (bmp)	Displays a blow-up of the bitmap file you specify. Either type the name of the bitmap file you want to use, or click Ref... (refer) to browse your hard disk for the file. The bitmap should be 800×600 pixels. Use this pattern to test image resolution.

3. Check Pattern Display to display the test pattern selected.
4. When you're finished, click Close to end the test and return to the Projector Setting dialog box.

Creating a User Logo

You can create or edit a logo from the Projector Setting dialog box, then save it to a file on your hard disk or download it to the projector when you want to use it with a presentation.

1. Click User's Logo on the Projector Setting dialog box. The User's Logo Setting dialog box appears.

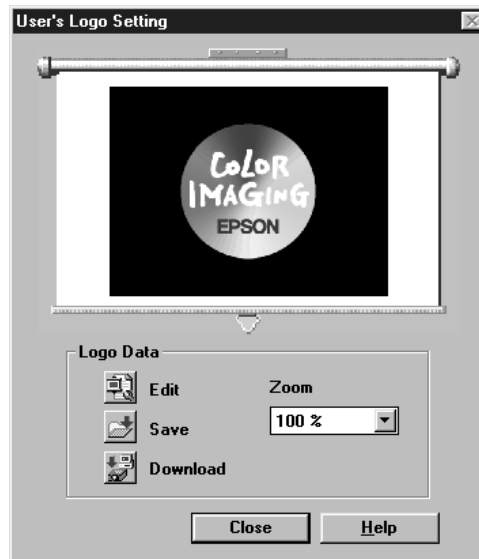

2. Click the Edit button. The following dialog box appears.

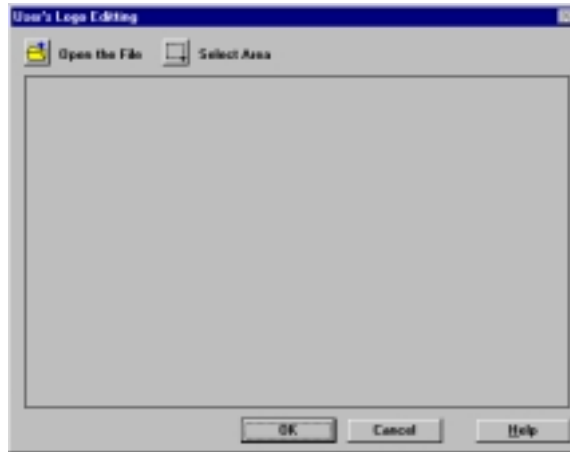

3. Click the Open the File icon to locate and open a bitmap or logo (.lgo) file. The selected image appears in the display area.

Note: If you see a screen requesting the image type, select the correct image type.

4. To crop the image, click the Select Area button and position the pointer at one corner of the area to be the logo. Click the bottom multi-purpose button, move the pointer to the opposite corner, and then click it again. Click OK to accept the changes. The User's Logo Setting dialog box reappears.
5. To increase or decrease the size at which the logo displays, select a zoom percentage from the Zoom list box.

- Click the Save button to save your logo to your hard disk. The Save As dialog box appears. Type a name for your logo, using the .lgo extension, then click OK.

Note: You must save logo files with the extension .lgo.

- To download a logo file to the projector, click the Download button and follow the instructions on the screen.
- Click Close to return to the Projector Setting dialog box.

Bringing out detail in your projected image

If much of your image appears hidden in shadow, you can increase visible detail by gamma correction, which brings out the midtones in the image. This correction often achieves better results than simply correcting contrast or brightness from the Video tab.

- Click Gamma on the Projector Setting dialog box. The Gamma Setting dialog box appears:



-
2. Select the desired gamma correction:
 - Gamma 1 Provides the greatest degree of correction (a dynamic image with a lot of contrast).
 - Gamma 2 Provides an image between Gamma 1 and Gamma 3.
 - Gamma 3 Provides a natural image.
 3. Click Pattern Display to display a test pattern with the gamma correction applied. If you're not satisfied with the image, repeat steps 2 and 3 using a different setting.
 4. Click Close when you're finished.

Running ELP Link III Without the Projector

You can run the ELP Link III software without the projector connected if you want to prepare for a presentation and the projector isn't available. You can assign new functions to the Effects buttons on the remote control, then save your changes as a set. You can assign functions to your keyboard or define a key macro to use with one of the Effects buttons. You can also create and save a new user logo, although you can't download it to the projector until the projector is connected and operating.

To run ELP Link III without the projector connected, select Unconnected and Execute from the Option menu.

***Note:** Always deselect this setting before exiting ELP Link III so the program starts correctly the next time you use it.*

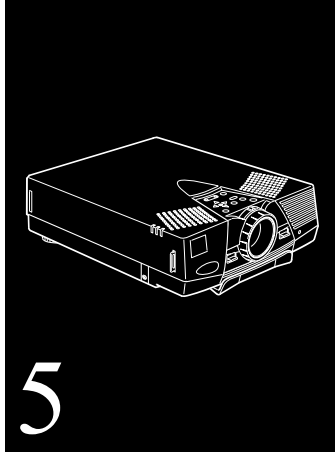

Maintenance

Your projector needs little maintenance. However, you should do the following:

- p Clean the lens so dirt or smears don't appear on the screen.
- p Clean the projector case when necessary.
- p Periodically clean the air filter at the bottom and rear of the projector. A clogged air filter can block ventilation needed to keep the projector from overheating.
- p Replace the lamp and air filter as needed. (If any other part needs replacing, contact your dealer or a qualified service person.)

-
- p When transporting the projector, follow the packing guidelines on page 137 to avoid damaging the delicate internal components.

Warning: Before you clean any part of the projector, turn it off and unplug the power cord and any other cables that are attached. Never open any cover on the projector, except the lamp and filter covers. Dangerous electrical voltages in the projector can cause severe injury. Don't try to perform any servicing other than the maintenance procedures explained in this chapter. Refer all other servicing to qualified service personnel.

Cleaning the Lens

Clean the lens whenever you notice dirt or dust on the surface. Lightly wipe the lens surface with a soft, dry, lint-free cloth. To remove dirt or smears on the lens, moisten a soft cloth with an alcohol-based cleaner and gently wipe the lens surface.

Cleaning the Projector Case

To clean the projector case, first unplug the power cord. To remove dirt or dust, wipe the case with a soft, dry, lint-free cloth. To remove stubborn dirt or stains, moisten a soft cloth with water and a mild detergent. Then wipe the case.

Don't use alcohol, benzene, thinner, or other chemical detergents. These can cause the case to warp.

Cleaning the Air Filter

Clean the air filter at the bottom of the projector after every 100 hours of use. If it isn't cleaned periodically, it can become clogged with dust, preventing proper ventilation. This can cause overheating and damage the projector. To clean the air filter, follow these steps:

1. Turn off the projector and unplug the power cord from the electrical outlet.
2. Place the projector on its side with the handle at the top so that the filter is easily accessible.

Note: Placing the projector in this position keeps dust from getting inside the projector housing.

3. Lift up the tab securing the air filter cover and remove the cover. (The air filter is attached to the inside of the filter cover.)

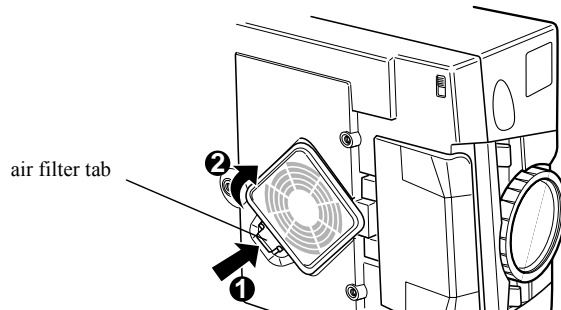

-
4. Use a small vacuum cleaner designed for computers and other office equipment to clean the filter. If you don't have one, use a dry, lint-free cloth.

If dirt is hard to remove or if the filter is torn, replace the air filter.

***Note:** An air filter comes with each replacement lamp. Contact your dealer or call EPSON Accessories at (800) 873-7766 in the U.S. to obtain a new one. Request part number ELPLP07. In Canada, call (800) 873-7766 for dealer referral.*

5. Replace the air filter cover.
6. Plug the power cord back into the electrical outlet.

Replacing the Lamp

The projector lamp typically lasts for about 2000 hours of use. It's time to replace the lamp when:

- p The projected image gets darker or starts to deteriorate.
- p The projector lamp light is red or is flashing orange and red alternately.
- p The message **LAMP REPLACE** appears on the screen when the projector lamp comes on.

To order a replacement lamp, contact your dealer or call EPSON Accessories at (800) 873-7766 in the U.S. and ask for part number ELPLP07, or visit our website at www.epsonsupplies.com (U.S. sales only). In Canada, call (800) 873-7766 for dealer referral.

Warning: Let the lamp cool before replacing it. Also, don't touch the glass portion of the lamp assembly; this can cause premature lamp failure.

1. Turn off the projector and unplug the power cord from the electrical outlet and the projector. Wait at least 20 minutes for the bulb to cool.
2. Place the projector on its side with the handle at the top so you can easily access the lamp cover.

Note: Placing the projector in this position keeps dust from getting inside the projector housing.

3. Use a screwdriver, coin, or similar object to loosen the retaining screw on the lamp cover. When the screw is loose, lift off the lamp cover. (You can't remove this screw from the cover.)

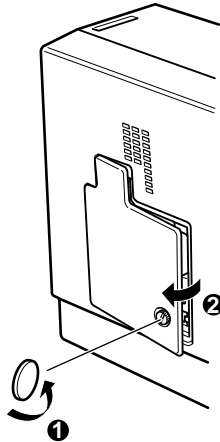

4. Use a screwdriver, coin, or similar object to loosen the two screws holding the lamp assembly in position. (You can't remove these screws either.)

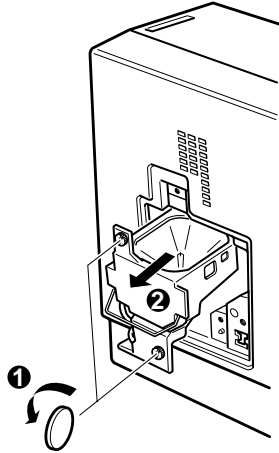

Caution: *Don't touch the glass portion of the lamp assembly; this can cause premature lamp failure.*

5. Lift up the handle and pull out the lamp assembly.
6. Gently lower the new lamp into position and make sure it's inserted securely. Tighten the screws on the new lamp assembly.
7. Replace the lamp cover and tighten the cover screw. (Make sure the lamp cover is securely fastened. The projector won't run if the lamp cover is open.)

Transporting the Projector

The projector contains many delicate parts. If you need to transport it, please follow these packing guidelines to prevent damaging the projector:

- p When shipping the projector for repairs, place plenty of cushioning around it.
- p When transporting it for business use, first put the projector in a hard-shell carrying case (such as the optional EPSON case), then pack it in a firm box, using cushioning around the case.
- p When you are carrying the projector by hand, be sure to store it in a hard-shell or soft carrying case (such as the optional cases offered by EPSON).

***Note:** EPSON shall not be liable for any damages incurred during transportation.*

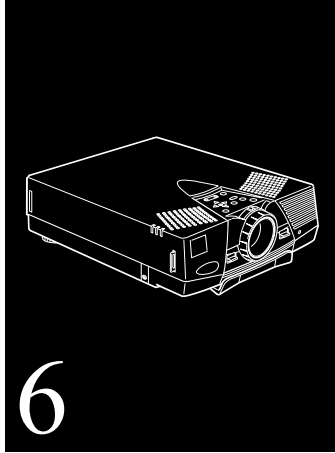

Troubleshooting

This chapter describes how to interpret your projector's warning lights and what to do when you encounter problems. It's divided into the following sections:

- p "Using the Online Help Menu" on page 140 describes how to use the projector's online help for problems with the image or sound.
- p "Problems with the Projector" on page 141 tells you what to do if any of the projector's warning lights come on.
- p "Problems with the Remote Control" on page 144 tells you what to do if the projector is not responding to remote control commands.

-
- p “Problems with the Image or Sound” on page 145 describes what to do if you can’t project an image, if the screen image is not good, or if there is no sound.

If you have a problem, check the appropriate section and follow all suggestions that apply to your problem. If none of the suggestions solve the problem, call your dealer or contact EPSON as described on page 7.

Using the Online Help Menu

The online Help menu provides useful information that can resolve some common image or sound problems. To open the online Help menu, press the Help button on the control panel or the remote control. You’ll find help for the following problems:

- p No image appears on the screen
- p The image is blurred or not in focus
- p Only part of the image is displayed
- p Colors in the image are not correct
- p The image is too dark

For some of the problems listed above, you can make adjustments within the Help menu to correct the problem.

***Note:** Each Help menu displays navigation buttons and descriptions at the bottom of the screen. Projector control functions are displayed as icons in the help text.*

Problems with the Projector

If you have problems with the projector, first turn it off and unplug it. Then plug the power cord back in and turn the projector back on. If this doesn't solve the problem, check the lights on top of the projector. These lights alert you to problems with projector operation.

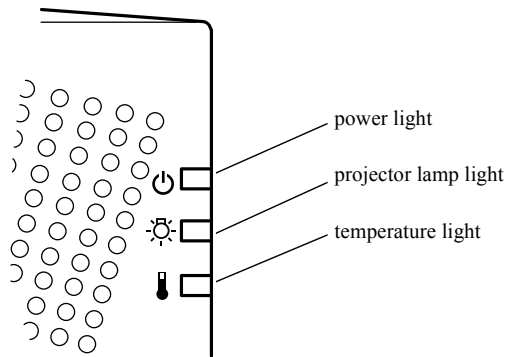

Light	Color	Meaning
Temperature	Flashing orange	The projector is too hot.
	Red	The projector has turned off automatically because of overheating.
	Flashing red	There's a problem with the cooling fan or temperature sensor. Call a service representative.
Projector lamp	Red or flashing orange and red	The lamp needs to be replaced. See "Replacing the Lamp" on page 134 for instructions.
	Flashing red	There's a problem with the projector lamp, lamp power supply, or a lamp fuse; or there's a circuit malfunction in the projector.
Power	Flashing green	The projector is warming up. Allow about 30 seconds.
	Flashing orange	The projector is cooling down.
	Steady green	Both the power and the projector lamp are on.
	Steady orange	The projector is in sleep mode.
	Off	There's an internal projector problem, or the power to the projector has been cut off.

See the following pages for information on what to do when you see these warning lights or encounter other specific problems with the projector.

-
- w **The power light is flashing orange and you can't turn the projector on.**

The projector is cooling down. Wait until the light stops flashing and then turn the projector on.

- w **The projector screen is blank and the lamp is off.**

If there is no video signal for 30 minutes, the projector goes into sleep mode. To resume, make sure the video signal is active and then press the Power button.

- w **The power light doesn't come on.**

Turn the projector off, check that the power cable is securely connected both at the electrical outlet and the projector, and press the on/off switch at the back of the projector and then press the Power button.

- w **Projected images get darker or start to deteriorate, or the projector lamp light is red.**

Replace the projector lamp as described in “Replacing the Lamp” on page 134.

- w **The temperature light is red.**

The projector is overheating, which turns the lamp off automatically. Let the projector cool for a few minutes, then turn it back on. Make sure nothing is blocking the ventilation vents.

The air filter may be clogged. Clean it as described in “Cleaning the Air Filter” on page 133, then let the projector cool for awhile.

If the projector continues to overheat after you clean the air filter, the problem may be caused by damage to the cooling fan or internal circuits. Contact a qualified service person.

***Warning:** Don't attempt to perform any servicing other than the maintenance procedures explained in Chapter 5.*

Problems with the Remote Control

w **The projector doesn't respond to remote control commands.**

The remote control may be too far from the projector, or at too wide an angle to the infrared receiver. See page 59 for details.

The remote control's batteries may be low on power. Replace them.

If you are using the remote as a wireless mouse, make sure the projector's mouse cable is securely connected to both your computer's mouse port and to the projector's Mouse/COM port (or the main cable if you are using ELP Link III). For details, see Chapter 1 (or Chapter 4 for ELP Link III).

Light that is too strong, or certain types of fluorescent lighting may affect the projector's infrared receivers. Dim the ambient lighting and turn off any fluorescent lighting. Move the projector out of direct sunlight.

Turn off any nearby equipment that emits infrared energy, such as a radiant room heater.

If you are using ELP Link III, make sure you selected the correct COM (communication) port for the serial cable when you set up the ELP Link III software. If necessary, you can change the COM port from the Option menu. See page 101 for more information.

Problems with the Image or Sound

w **No image appears on the screen.**

Check that the power light is on and the lens cover is off. Also make sure the power cord, video cable, and any other cables you are using are securely connected, as described in Chapter 1 (and Chapter 4 for ELP Link III).

The correct image source may not be selected. Press the Source button on the remote control or the control panel to choose another image source.

Some screen savers appear as a blank screen. Make sure any screen savers on your computer are disabled while using the projector.

w **A screen saver appears on the screen and won't go away.**

Press the ESC key, the right mouse button, or the top multi-purpose button (if you're using the remote control as a mouse) to stop the screen saver. This will also clear any effects you have on the screen. You should disable any screen savers on your computer before using the projector.

w **Only part of the computer image is displayed.**

If the computer's output resolution setting is higher than 800 × 600 (PowerLite 5550C) or 1024 × 768 (PowerLite 7550C), the projector resizes the image. If the computer output is not compatible with this resizing, choose a different display setting on the computer.

In Windows 3.x, use Windows Setup in the Main program group. In Windows 95/98 or NT 4.0, right-click on the desktop, select Properties, click the Settings tab, and use the dialog box to select the resolution you want.

For a Macintosh with Mac OS 8.0 or lower, choose Control Panels under the Apple menu and then choose Monitors. In the Monitors screen, choose Options and make sure Macintosh Hi-Res Display or another 800 × 600 (or 1024 × 768) display is selected. For a Macintosh with Mac OS 8.1 or above, choose Control Panels under the Apple menu and then choose Monitors & Sound. In the Monitors & Sound screen, select a resolution from the Resolution box. For supported display settings, see "Supported Computers and Monitor Displays" on page 153.

You may also need to modify your presentation file if you created it for a different resolution. See your software manual for details.

w **The message NO SIGNAL is displayed.**

The problem may be any of the following: the wrong image source is selected, the image source is not connected to the projector, there's no signal coming from the computer, or the signal isn't reaching the projector. Make sure the connectors are securely attached to both the projector and the image source.

Then check that the image source is selected correctly. If your projector is attached to a Macintosh, make sure that the DIP switches on your Macintosh desktop adapter are set correctly. (See your Macintosh documentation if you need instructions.)

When NO SIGNAL is displayed, you can't access any options on the Video menu except Auto. Try turning the Auto Set Up feature off, then restart your computer and manually adjust the Tracking and Sync settings.

The computer's power management may cause the screen to go blank or display NO SIGNAL.

w **A blank screen is displayed.**

The projector can't interpret the computer signal. Verify the display format (see page 153). When you see a blank screen, you can't access the projector menus.

w **The image or parts of the image are blurred or not in focus.**

Adjust the zoom and focus lens rings.

Try adjusting the Tracking and Sync buttons on the projector's control panel or remote control.

Adjust the Brightness and Contrast settings on the Video menu. If there is no video for 30 minutes, the projector goes into sleep mode and the lamp is turned off.

There may be dirt or smears on the lens. Clean the lens as described on page 132.

w **The colors of the image are not right.**

The color balance may be incorrect. If you're displaying a computer image, use the Color option in the Video menu to adjust the balance of red, green, and blue. If you're displaying video, adjust the Color and Tint (NTSC only) settings on the Video menu.

Check your monitor's color balance if you're displaying a computer image.

w **There is no sound.**

Make sure the volume setting isn't turned all the way down and that the audio cable is securely attached to both the projector and the audio source. Also, make sure that the Mute button is not enabled.

The wrong source may be selected. Press the Source button on the remote control or control panel to select the proper source.

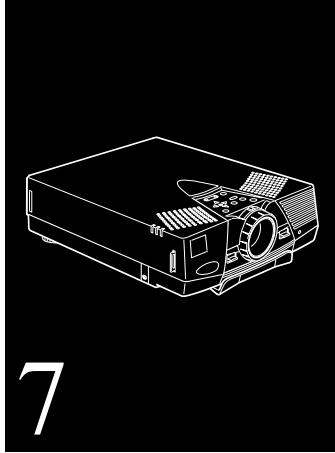

Technical Specifications

General	Type of display	Poly-silicon Thin-Film Transistor (TFT), active matrix
	Size of liquid crystal panels	Diagonal: 0.9 inches (22.9 mm)
	Lens	F=1.7 to 2.0, f=37 to 48 mm
	Resolution	5550C: SVGA 800 × 600 pixels 7550C: XGA 1024 × 768
	Color reproduction	24 bit, 16.7 million colors
	Image brightness	850 lumens (ANSI)
	Image size	19 to 300 inches

	Projection distance	3.3 to 53.5 feet (1.0 to 16.3 meters) (standard 8.2 feet [2.5 meters] on 60-inch screen)
	Projection methods	Front, rear, upside-down (ceiling mount)
	Optical aspect ratio	4:3 (horizontal:vertical)
	Zoom ratio	1:1.3
	Tilt angle	0° to 12°
	Supported video interface standards	NTSC, NTSC 4.43, PAL, PAL N, PAL M, PAL 60, SECAM
Sound	Internal speaker system	2 × 1 W SRS 3D stereo output
	Effective frequency range	100 to 15000 Hz
	S/N ratio	71 dB
Projector Lamp	Type	UHE (Ultra High Efficiency)
	Power consumption	120 W
	Lamp life	2000 hours at 50% brightness
	Part number	ELPLP07

Remote Control	Range	32.8 feet (10 meters)
	Batteries	Alkaline AA (2)
	I/R receiver interface	Supports Xantech® IR repeaters, 3.5 mm stereo mini-jack right/left: $\pm 30^\circ$; upper/lower: $\pm 15^\circ$
Mouse Compatibility		Supports PS/2, serial, ADB, and 98 Bus
Repeater Interface		Supports Xantech IR repeaters, 3.5 mm stereo mini-jack
Mechanical	Height	3.7 inches (93 mm)
	Width	9.4 inches (238.5 mm)
	Depth	13.6 inches (346 mm)
	Weight	9.4 lb (4.3 kg)
Electrical	Rated frequency	50/60 Hz
	Power supply	100 to 120 VAC $\pm 10\%$, 2.2 A, 50/60 Hz 200 to 240 VAC $\pm 10\%$, 1.0 A, 50/60 Hz
	Power consumption	Operating: 220 W Standby: 30 W
Noise Level		≤ 41 db-A (normal use)

Environmental	Temperature	Operating: 41 to 95 °F (5 to 35 °C), non-condensing Storage: 14 to 140 °F (-10 to 60 °C), non-condensing
	Humidity	Operating: 20 to 80% RH, non-condensing Storage: 10 to 90% RH, non-condensing
Safety	United States	FCC Part 15J Class B UL1950 Rev. 3
	Canada	DOC SOR/88-475 CSA C22.2 No. 950 Rev. 3

Supported Computers and Monitor Displays

The following table lists the display formats supported by the projector.

Computer type	Formats	Resolutions	
IBM PC and IBM PC-compatible	EGA	640 × 350	
	NEC PC 400	640 × 400	
	VGA60, VESA 72/75/85	640 × 480	
	VGA Text	720 × 350	
	VGA Text	720 × 400	
	SVGA 56/60/72/75/85	800 × 600	
	XGA 60/70A/75/85	1024 × 768	
	SXGA 70/75/85	1152 × 864	
	SXGA 85	1152 × 864*	
Apple Macintosh	Standard 8- and 24-bit color monitor	13"	640 × 480
		16"	832 × 624
		19"	1024 × 768
		21"	1152 × 870
EWS		1280 × 1024	
TV	NTSC	640 × 480	
	PAL, PAL60, SECAM	768 × 567	

* PowerLite 7550 only.

Note: *The frequencies of some computers may not allow the image to be displayed correctly.*

Computer In and Computer Out connector pin assignments

The Computer In and Computer Out connectors are female video RGB, 15-pin micro-D-style connectors. The pin assignments are:

Pin	Computer Out connector signals	Computer In connector signals
1	Red analog input	Red video
2	Green analog input	Green video
3	Blue analog input	Blue video
4	Reserved	Monitor (ID bit 2)
5	GND	GND
6	Red GND	Red video GND
7	Green GND	Green video GND
8	Blue GND	Blue video GND
9	Reserved	+5 V
10	GND	Synchronous GND
11	Reserved	Monitor (ID bit 0)
12	Reserved	SDA
13	Horizontal sync/composite sync	Horizontal sync
14	Vertical sync	Vertical sync
15	Vertical sync	(SCL)

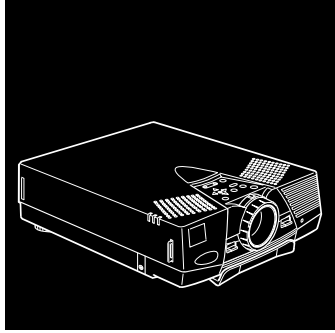

Glossary

- Brightness** The balance of light and dark shades in an image.
- Composite video** A type of video signal that encodes picture, luminance, and synchronization information so it can be carried in one signal.
- Contrast** A measure of the tonal differences between the highlights and shadows of an image. In a high-contrast image, light areas are very bright and dark areas are very dark, with relatively few levels of gray between white and black. Contrast is decreased by adding grays.
- NTSC** A 525-line video broadcast format developed by the National Television Standards Committee. NTSC is widely used in North America, Mexico, and Japan.

PAL	Phase Alternation by Line. A 625-line video broadcast format used in Western Europe, India, China, Australia, New Zealand, and parts of Africa.
Point	A measurement of drawn or printed objects. One point equals 1/72 inch.
Rear Projection	Projecting the image from behind the screen.
Resolution	A measure of the amount of detail contained in an image. Resolution can be measured in dots per inch or in pixels. Image sharpness and clarity improve as resolution increases.
RGB	A type of color scheme that defines color as percentages of red, green, and blue.
S-Video	A type of video signal used in S-VHS videotape formats. It transmits luminance and color separately.
SECAM	System Electronique pour Couleur Avec Memoire. A 625-line TV system used in France, Eastern Europe, Russia, and parts of Africa.
Sleep mode	A power-saving feature in which the projector's lamp is turned off when the projector has not been used for 30 minutes. In sleep mode, only a minimum amount of the projector's circuitry remains on.

SVGA	Super Video Graphics Array. SVGA provides higher resolution than VGA.
SXGA	Super Extended Graphics Array. SXGA provides higher resolution than XGA.
VGA	Video Graphics Array. A high-resolution display adapter that provides a variety of video modes.
XGA	Extended Graphics Array. IBM's next generation display adapter, XGA provides higher resolution than VGA.

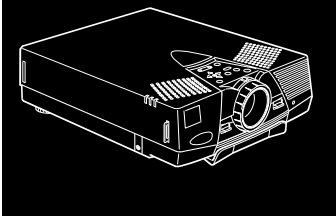

Index

A

Accessories, 3, 9

Adjusting

bass, 75, 122

brightness, 72, 74, 118, 120, 121

color balance, 73, 74, 120, 121

color saturation, 74, 120, 121

contrast, 73, 74, 118, 120, 121

image position, 72

image quality, 72 to 75, 128 to 129

screen whiteness, 76, 123

sharpness, 74, 121

speaker tone, 75, 122

speaker volume, 75, 122

stereo sound, 75, 122

treble, 75, 122

Air filter, cleaning, 133 to 134

Amplification, 45

Anti-theft device, 15

Audio

Audio tab (ELP Link III), 122

connecting, 15, 24, 27, 33, 39, 44, 45

menu, 67, 75 to 76

Auto Set Up feature, 147

B

Bar function, 105, 109

Bass, 75, 122

Batteries, changing, 18 to 19

Blank menu option, 77, 123

Boxes

drawing, 104

modifying, 81, 109

-
- Brightness
 - ELP Link III setting, 118, 120, 121
 - projector menu settings, 72, 74
 - specification, 149
 - Buttons
 - control panel, 63 to 64, 70
 - Effects, *see* Effects buttons
 - remote control, *see* Remote control
 - C**
 - Camcorder
 - adjusting the projected image, 74 to 75
 - connecting projector to, 11, 41 to 44
 - Case, cleaning, 132
 - Ceiling, hanging the projector from, 77, 123
 - Changing
 - batteries, 18 to 19
 - menu language, 77
 - projector settings, 70 to 71, 118 to 123
 - Cleaning
 - air filter, 133 to 134
 - case, 132
 - lens, 132
 - Color
 - adjusting screen whiteness, 76, 123
 - balance, 73, 74, 120, 121
 - projector menu setting, 73, 74
 - saturation, 74, 120, 121
 - COM port, changing, 101
 - Compatibility, 153
 - Composite video, 41, 155
 - CompuServe, 7
 - Computer In pin assignments, 154
 - Computer Out pin assignments, 154
 - Computer, adjusting the projected image, 72 to 75
 - Computers, supported, 153
 - Connecting projector
 - to a desktop Macintosh, 29 to 34, 92 to 95
 - to a desktop PC, 23 to 25, 88 to 91
 - to a laptop PC, 26 to 28, 88 to 91
 - to a PA system, 45
 - to a PowerBook, 35 to 40, 92 to 95
 - to a video source, 41 to 44
 - to an external speaker, 45
 - Connector pin assignments, 154
 - Contrast
 - definition, 155
 - ELP Link III setting, 120, 121
 - projector menu settings, 73, 74
 - Control panel, 63 to 64, 70
 - Cursor, changing shape, 81, 105, 109
 - Customizing the Effects buttons, 106, 109 to 111

D

Defining key macros, 110 to 111
Detail, improving display of, 128 to 129
DIP switches, Macintosh, 30, 37
Display formats, supported, 153
Displaying the Main menu, 69
Distance, calculating, 20, 52 to 53
DVD player, connecting projector to, 11,
41 to 44

E

Effects buttons
 assigning functions, 102 to 106
 modifying, 81, 107 to 109
 saving and recalling assignments, 112
 using default functions, 60 to 62
Electrical specifications, 151
Ellipse, 104, 108
ELP Link III software
 assigning functions to keyboard,
 114 to 116
 changing settings, 119 to 123
 connecting cables for a Macintosh,
 92 to 95
 connecting cables for a PC, 88 to 91
 correcting image problems, 128 to 129
 creating a logo, 126 to 128
 installing, 96 to 98
 launching, 98 to 100

ordering, 14

Setting tab, 123

testing projector performance,

124 to 125

unpacking, 86 to 87

using without the projector, 129

Environmental specifications, 152

EPSON electronic support, 7 to 8

F

FaxAdvice, EPSON, 8

Focusing, 54 to 56

Foot, raising or lowering image, 55 to 56

Formats, supported display, 153

Freeze, 60

FTP site, EPSON, 7

G

Gamma correction, 128 to 129

H

Hand strap, attaching, 16 to 17

Help

 EPSON, 7 to 8

 projector online help, 140

Highlighting portions of screen, 62, 81,

105, 109

Humidity, requirements, 152

I

Image

- adjusting image quality, 72 to 75, 128 to 129
- adjusting the position, 54 to 56, 72, 120
- calculating image size, 52 to 53
- enhancing detail, 128 to 129
- focusing, 54 to 56
- problems, 145 to 148
- resizing, 56 to 57, 64
- size range, 149
- testing, 124 to 125

Infrared receiver, location, 50

Installing the ELP Link III software, 96 to 98

Internet, 7

K

Key Macro

- defining and using, 110 to 111
- description, 106, 109

Keyboard, assigning functions, 114 to 116

L

Lamp

- light, 47, 66, 141 to 143
- replacing, 134 to 136
- specifications, 150

Language menu option, 77

Laptop, connecting projector to, 26 to 28

Launching the ELP Link III software, 98 to 100

Lens, cleaning, 132

Lights, status, 47, 65 to 66, 141 to 144

Lines

- drawing, 104
- modifying, 81, 108

Logo

- creating, 78 to 80, 126 to 128
- displaying, 77

Lumens, 149

M

Macintosh, connecting projector to, 15, 29 to 40, 92 to 95

Macro, *see* Key Macro

Main menu, displaying and hiding, 69

Maintenance, 131 to 136

Manual, using, 4

Mechanical specifications, 151

Menus

- About, 68
- accessing, 69
- Audio, 67, 75 to 76
- changing settings, 70 to 71
- Effect, 68
- online Help, 140

Reset All, 68, 83
Menus (*continued*)
 User's Logo, 67, 78 to 80
 Video, 67, 72 to 75
Monitors, supported, 153
Moving projector, 137
Mute, 64

N
NO SIGNAL message, 147
Noise level, 151
NTSC, 155

O
Optional accessories, 3

P
PA system, connecting projector to, 45
PAL, 156
Pin assignments, connector, 154
Pointer, changing shape, 81, 105, 109
Positioning
 projector, 51 to 52
 screen image, 54 to 56, 72, 120
Power
 button, 64
 consumption, 151
 light, 46 to 48, 65, 141 to 144
 supply, 151

PowerBook, connecting projector to, 15,
 35 to 40, 92 to 95

Projector
 accessories, 3, 9
 calculating distance to screen, 20,
 52 to 53
 connecting, 23 to 45, 87 to 95
 controlling, 57 to 64
 focusing, 54 to 56
 hanging from the ceiling, 52, 77, 123
 lamp specifications, 150
 maintaining, 131 to 136
 parts identified, 50
 positioning, 51 to 52
 positioning the screen image, 54 to 56,
 72, 120
 problems, 141 to 144
 setting up, 16 to 48
 settings, changing, 70 to 71, 118 to
 123
 status lights, 47, 65 to 66, 141 to 144
 transporting, 137
 turning on and off, 46 to 48
 unpacking, 12 to 14
 using the Quick Change Toolbar, 118

Projector case, cleaning, 132
Projector Control dialog box, 119 to 123
Projector lamp light, 47, 66, 141 to 143
Projector Setting dialog box, 115 to 117

Prompt menu option, 76, 123

Q

Quick Change Toolbar, 118

R

Rear projection, 77, 123, 156

Remote control

- batteries, 18 to 19

- button functions, 58 to 60

- customizing Effects buttons, 106, 110 to 111

- infrared repeater, 15

- problems, 59, 144 to 145

- range, 59, 151

- using the Effects buttons, 60 to 62

Replacing the lamp, 134 to 136

Reset All menu, 83

Resize button, 56 to 57, 64

Resolution, 56 to 57, 149, 153, 156

S

Safety instructions, 5 to 6

Saturation, 74, 120, 121

Screen image, problems, 145 to 148

Screen saver, 145

Screen, adjusting whiteness, 76, 123

SECAM, 156

Setting tab (ELP Link III), 123

Sharpness, 74, 121

Sleep mode, 48, 156

Software

- installing, 96 to 98

- launching, 98 to 100

Sound problems, 148

Speakers

- adjusting the tone, 75, 122

- adjusting the volume, 60, 64, 75, 118, 122

- connecting projector to, 45

Specifications

- electrical, 151

- environmental, 152

- general, 149 to 150

- lamp, 150

- mechanical, 151

- mouse compatibility, 151

- remote control, 151

- repeater interface, 151

- safety, 152

- sound, 150

Stamp function, 105, 109

Status lights, 47, 65 to 66, 141 to 144

Stereo sound, adjusting, 75, 122

Support, technical, 7 to 8

SVGA, 2, 21, 56 to 57, 149, 153

S-Video signal, 14, 41, 156

Switching image sources, 59, 64

SXGA, 21, 57, 153, 157

Sync, 72, 120

T

Temperature

light, 47, 65, 66, 141 to 144

requirements, 152

Test pattern, displaying, 120, 122, 123

Testing projector performance, 124 to 125

Tint, 74, 121

Tone, adjusting, 75, 122

Toolbar, using, 118

Tracking, 72, 120

Transporting projector, 137

Treble, 75, 122

Troubleshooting

image and sound problems, 145 to 148

projector problems, 141 to 144

remote control problems, 144 to 145

Turning the projector on and off, 46 to 48

TV, supported display formats, 153

U

Unpacking projector, 12 to 14

User logo

creating, 78 to 80, 126 to 128

displaying, 77

V

VCR

adjusting the projected image, 74 to 75

connecting projector to, 11, 22,

41 to 44

VGA, 2, 21, 56 to 57, 153, 157

Video

jacks, 44

menus, 67, 72 to 75

signal mode, 77, 123

supported formats, 153

Video settings (ELP Link III), 121

Video source

changing, 72, 74

connecting projector to, 41 to 44

Volume, 60, 64, 75, 118, 122

W

Warning lights, 65 to 66, 141 to 144

World Wide Web, 7

X

XGA, 2, 21, 56 to 57, 153, 157

Z

Zoom ratio, 150

Zoom ring, 54 to 55