

**PowerLite® 1725/1735W
Multimedia Projector**

User's Guide

Important Safety Information

WARNING: Never look into the projector lens when the lamp is turned on; the bright light can damage your eyes. Never let children look into the lens when it is on. Never open any cover on the projector, except the lamp and filter covers. Dangerous electrical voltages inside the projector can severely injure you. Except as specifically explained in this *User's Guide*, do not attempt to service this product yourself. Refer all servicing to qualified service personnel.

WARNING: The projector and its accessories come packaged in plastic bags. Keep plastic bags away from small children to avoid any risk of suffocation.

Caution: When you replace the lamp, never touch the new lamp with your bare hands; the invisible residue left by the oil on your hands may shorten the lamp life. Use a cloth or glove to handle the new lamp.

Copyright Notice

All rights reserved. No part of this publication may be reproduced, stored in a retrieval system, or transmitted in any form or by any means, electronic, mechanical, photocopying, recording, or otherwise, without the prior written permission of Seiko Epson Corporation. The information contained herein is designed only for use with this Epson product. Epson is not responsible for any use of this information as applied to other products.

Neither Seiko Epson Corporation nor its affiliates shall be liable to the purchaser of this product or third parties for damages, losses, costs, or expenses incurred by purchaser or third parties as a result of: accident, misuse, or abuse of this product or unauthorized modifications, repairs, or alterations to this product, or (excluding the U.S.) failure to strictly comply with Seiko Epson Corporation's operating and maintenance instructions.

Seiko Epson Corporation shall not be liable for any damages or problems arising from the use of any options or any consumable products other than those designated as Original Epson Products or Epson Approved Products by Seiko Epson Corporation.

Trademarks

Epson, EasyMP, and Instant Off are registered trademarks, and Epson Exceed Your Vision is a registered logomark of Seiko Epson Corporation.

PowerLite and PrivateLine are registered trademarks, Duet and SizeWise are trademarks, and Extra Care is a service mark of Epson America, Inc.

Pixelworks, DNX, and the DNX logo are trademarks of Pixelworks, Inc.

Windows Vista and the Windows logo are trademarks of the Microsoft group of companies.

General Notice: Other product names used herein are for identification purposes only and may be trademarks of their respective owners. Epson disclaims any and all rights in those marks.

This information is subject to change without notice.

C

Contents

<i>Welcome</i>	7
Using Your Documentation	8
Getting More Information	8
Registration and Warranty	9
Unpacking the Projector	10
Additional Components	11
Optional Accessories	12

1 <i>Displaying and Adjusting the Image</i>	13
Positioning the Projector	14
Turning the Projector On and Off	15
Turning On the Projector	16
Using the Direct Power On Function	17
Shutting Down the Projector	18
Selecting the Image Source	18
Troubleshooting Display Problems	19
You Can't Project an Image	19
The Projector and Notebook Don't Display the Same Image	20
Adjusting the Image	22
Adjusting the Height of Your Image	22
Focusing and Zooming Your Image	23
Adjusting the Image Shape	23
Correcting Computer Images	25

2	<i>Using the Remote Control</i>	27
	Using the Remote Control	28
	Replacing the Batteries.	28
	Controlling the Picture and Sound.	29
	Switching Between Picture Sources	29
	Turning Off the Picture and Sound.	30
	Stopping Action.	30
	Zooming Part of Your Image.	31
	Controlling the Volume.	31
	Adjusting the Aspect Ratio.	32
	Adjusting the Color Mode.	33
	Operating Your Computer with the Remote Control.	35
	Highlighting Your Presentation	36
	Using the Pointer Tool	36
	Customizing the Pointer Tool	36
	Operating Two or More Projectors with	
	the Remote Control.	37
	Setting the Projector ID.	37
	Checking the Projector ID.	37
	Setting the Remote Control ID	38

3	<i>Connecting to Computers, Cameras, and Other Equipment</i>	39
	Connecting to a Computer.	40
	Connecting to the Video Port	40
	Connecting to the USB Port	41
	Connecting the Cable for Remote Mouse Control.	42
	Connecting to Video Equipment	44
	Connecting a Composite Video Source	45
	Connecting an S-Video Source	46
	Connecting a Component Video Source	47
	Connecting an RGB Video Source.	48
	Connecting to a Digital Camera or Other Device.	49
	Removing the USB Cable	49
	Playing Sound Through the Projector	50
	Connecting External Speakers	51

4	<i>Setting Up Network Projection</i>	53
	Using Quick Wireless Connection	54
	Configuring Basic Settings	55
	Configuring the Connection.....	57
	Using Ad Hoc Mode	58
	Using Access Point Mode.....	64
	Making a WPS (Wi-Fi Protected Setup) Connection...	74
	Using Wireless Security Options.....	80
	Enabling WEP Encryption.....	81
	Enabling WPA Security	83
	Enabling EAP, LEAP, or PEAP Authentication	85
	Enabling EAP-TLS Certificate Validation	86
	Enabling Data Encryption from EMP NS Connection	88
	Using the EasyMP Software	88
	Removing the Wireless 802.11a/b/g Module	89
	Connecting to a Wired Network	90
	Using Projector E-mail Alerts	91
	Using SNMP to Monitor the Projector.....	93
	Connecting With Windows Vista.....	94
	Vista Network Projector Limitations	96

5	<i>Fine-Tuning the Projector</i>	97
	Using the Menu System	98
	Restoring the Default Settings	99
	Adjusting the Image	100
	Six-Axis Color Adjustment.....	101
	Adjusting Signal Settings	102
	Customizing Projector Features	104
	Using the Projector Security Features	105
	Enabling Password Protection	106
	Creating Your Own Startup Screen	108
	Disabling the Projector's Buttons.....	110
	Customizing Power and Operation.....	111
	Multi-screen Color Adjustment	113

6	<i>Maintaining the Projector</i>	115
	Cleaning the Lens.....	116
	Cleaning the Projector Case.....	116
	Cleaning the Air Filter and Vent.....	117
	Replacing the Lamp and Air Filter.....	118
	Resetting the Lamp Timer.....	121
	Transporting the Projector.....	122
7	<i>Solving Problems</i>	123
	Using On-Screen Help.....	124
	Checking Projector Status.....	124
	What To Do When the Lights Flash.....	125
	Viewing Lamp Usage and Other Information.....	127
	Solving Projector Operation Problems.....	127
	Solving Problems with the Image or Sound.....	128
	Solving Network Problems.....	134
	Solving Problems with the Remote Control.....	136
	Where To Get Help.....	138
	Speak to a Support Representative.....	138
A	<i>Projector Installation</i>	141
B	<i>Technical Specifications</i>	143
C	<i>Notices</i>	149
	Important Safety Instructions.....	149
	FCC Compliance Statement.....	152
	<i>Index</i>	153

W

Welcome

The PowerLite® 1725/1735W is an easy-to-use projector that weighs less than 4 pounds. The projector offers up to 3000 lumens of white and color light output (brightness). You can connect it to a wide range of computers and video sources, or you can project from a USB storage device, or over an 802.11g, 802.11b, or 802.11a wireless network.

Easy setup, control, and security:

- 6-second startup time and Instant Off® feature for fast setup and shut down
- Automatic digital keystone correction
- 1.2x optical zoom lens for flexible placement and positioning
- Security features including password, user's logo, and the ability to lock the projector buttons
- A/V Mute slide to block the lens and save lamp life when you want to temporarily stop projecting

New features and industry firsts:

- Connect two computers, one via USB 2.0 cable and another via VGA cable for multi-source presentations
- Wirelessly send MPEG4 full screen video from a PC
- Project up to four different images from one computer
- Color match images from up to four projectors for a uniform, wide-screen view
- Project only the PowerPoint® slide images while viewing handout notes and controls on the computer screen
- Perform six-axis color adjustment for fine art and photography

Using Your Documentation

This electronic *User's Guide* provides detailed instructions on using your projector.

In addition, your projector CD-ROM includes the *EasyMP Operation Guide* and the *EMP Monitor Operation Guide*. Refer to these manuals for detailed instructions on using the projector in a network environment (for example, to give presentations over a wireless network or monitor the projector from a remote location). To set up your projector for the first time on a network, see page 53 of this *User's Guide*.

Please follow these guidelines as you read through this manual:

- Warnings must be followed carefully to avoid bodily injury.
- Cautions must be observed to avoid damage to your equipment.
- Notes contain important information about your projector.
- Tips contain additional projection hints.

Getting More Information

Need tips on giving presentations? Quick steps for setting up your projector? Here's where you can look for help:

- **Quick Setup sheet**
Gives you the instructions you need to get your projector up and running if you are connecting to a notebook, MacBook®, PowerBook®, or iBook® computer. It also includes quick steps for projecting over a wireless network.
- **Built-in help system**
Provides assistance for common problems. Available from the ? **Help** button on the projector or the remote control. See page 124 for details.
- **epson.com/support**
Download FAQs and e-mail your questions to Epson support.

- **PrivateLine support**

If you still need help after checking this *User's Guide* and the sources listed above, you can use the Epson PrivateLine® Support service to get help fast. Call (800) 637-7661 and enter the PIN on the PrivateLine card. Or take advantage of Epson's automated support services 24 hours a day. See page 138 for more information.

- **presentersonline.com**

Includes a library of articles covering presentation tips, tricks, and technology. The site provides templates, clip art and sound clips, as well as Presenters Services to use on the road. Even more resources and services are available if you register to join the Presenters Club—and it's free.

Registration and Warranty

Your projector comes with a warranty that lets you project with confidence. For details, see the warranty statement included with your projector.

In addition, Epson offers free Extra CareSM Road Service. In the unlikely event of an equipment failure, you won't have to wait for your unit to be repaired. Instead, Epson will ship you a replacement unit anywhere in the United States or Canada, usually via overnight delivery. See the brochure included with your projector for details.

To register, simply fill out the registration card and mail it to Epson. Or you can register online at <http://www.epson.com/webreg>. Registering also lets you receive special updates on new accessories, products, and service.

Unpacking the Projector

After unpacking the projector, make sure you have all the parts shown below:

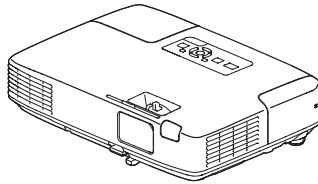

Projector

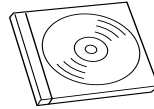

PDF manual and registration CD-ROM



Projector software CD-ROM



Wireless module



USB key*



Remote control and 2 AA batteries

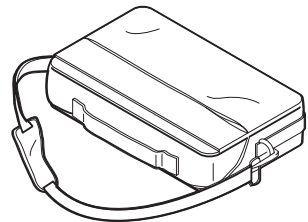

Carrying case

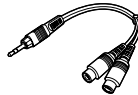

Audio adapter



Security sticker

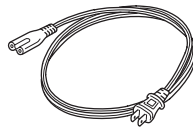

Power cable

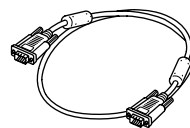

VGA computer cable

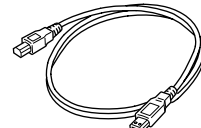

USB cable

* Stored in a small pouch inside the carrying case.

Save all packaging in case you need to ship the projector. Always use the original packaging (or the equivalent) when you need to send the projector to another location. If you are moving the projector by hand, use the carrying case. See page 122 for transportation instructions.

Additional Components

Depending on how you plan to use the projector, you may need additional components:

- To receive an S-video signal, you'll need an S-video cable. One may be provided with your video equipment, or you can purchase one from Epson; see below.
- To receive a component video signal from a VCR or other video device, you'll need an component-to-VGA video cable. You can purchase one from Epson; see below.

Optional Accessories

To enhance your use of the projector, Epson provides the following optional accessories:

Product	Part number
Replacement lamp	V13H010L48
Air filter replacement set (2 filters)	V13H134A19
Wheeled soft case	ELPKS62
Soft shoulder case for projector and laptop	ELPKS61
ATA molded hardshell case	ELPKS58
SwissGear® backpack	ELPKS63
Universal projector ceiling mount	ELPMBPJF
Adjustable suspended ceiling channel kit	ELPMBP01
Suspended false ceiling plate kit	ELPMBP02
Structural round ceiling plate	ELPMBP03
Adjustable extension column, 8 to 11 inches	ELPMBC01
Kensington® security lock	ELPSL01
Duet™ portable projector screen	ELPSC80
50-inch portable screen (4:3 aspect ratio)	ELPSC06
60-inch portable pop-up screen (4:3 aspect ratio)	ELPSC07
80-inch portable pop-up screen (4:3 aspect ratio)	ELPSC08
100-inch pop-up screen (4:3 aspect ratio)	ELPSC10
Component-to-VGA video cable	ELPKC19
S-video cable	ELPSV01
USB cable	F3U133X06
Distribution amplifier	ELPDA01
Image presentation camera (ELPDC05)	V12H162020
DC-10s document camera	ELPDC10S
Ethernet LAN module	V12H005M0B
Quick wireless connection USB key	V12H005M04

You can purchase screens, carrying cases, or other accessories from an Epson authorized reseller. To find the nearest reseller, call 800-GO-EPSON (800-463-7766). Or you can purchase online at www.epsonstore.com (U.S. sales) or www.epson.ca (Canadian sales).

1 *Displaying and Adjusting the Image*

Whether you're presenting from a computer or video equipment, you need to follow some basic steps to display your image on the screen.

Follow the guidelines in this chapter for:

- Positioning the projector
- Turning the projector on and off
- Selecting the image source
- Troubleshooting display problems
- Adjusting the image

note

You can mount the projector on the ceiling, or place it behind a translucent screen for rear projection. See page 141 for details.

Positioning the Projector

If the projector isn't already installed in the room you're using, you'll probably want to place it on a table in front of the screen. This lets you stand in the front of the room, face the audience, and remain close enough to the equipment to be able to control it. Try to leave as much space as possible between the projector and the screen to get a good-size image.

Use the figures below to help you determine placement. (The image shown below is projected at a 4:3 aspect ratio, but the PowerLite 1735W is capable of displaying images as wide as 16:10.) Image size increases with distance, but can vary depending on how you position the zoom ring and whether you've adjusted the image with other settings.

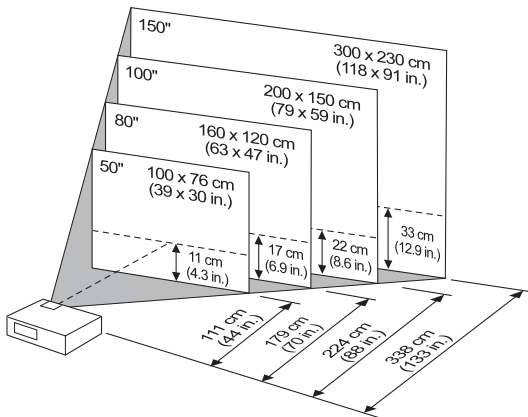

PowerLite 1725

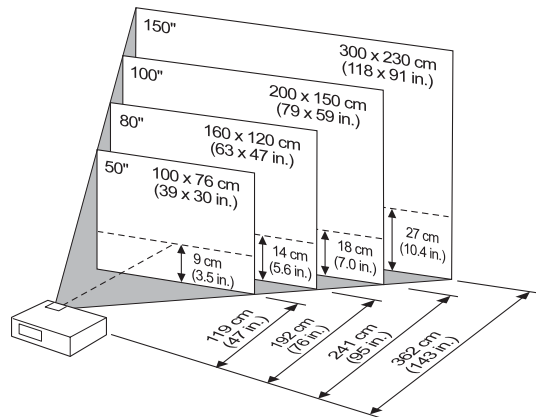

PowerLite 1735W

Also keep these considerations in mind:

- Place the projector on a sturdy, level surface.
- Make sure there is plenty of space for ventilation around and under the projector. Do not set the projector on top of anything that could block the vents.
- Make sure the projector is within 10 feet of a grounded electrical outlet or extension cord.

Ideally, you should place the projector directly in front of the center of the screen, facing it toward the screen squarely. The base of the lens should be at about the level of the bottom of the screen.

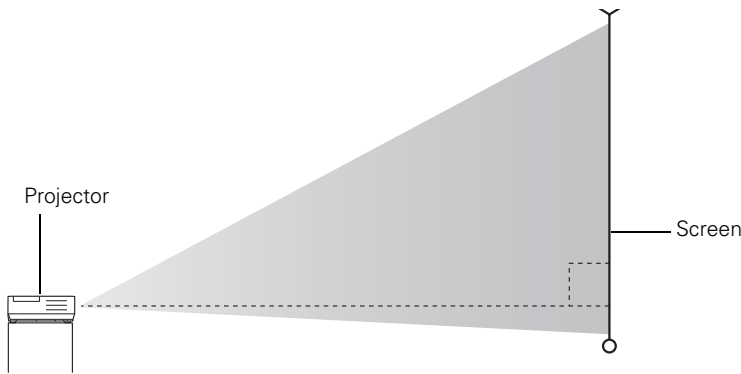

If you place the projector below screen level, you'll have to tilt it up by extending the front adjustable foot. This causes the image to become “keystone” shaped, but you can correct the distortion by pressing the buttons on the projector. See page 23 for detailed information about correcting the image shape.

For instructions on installing the projector in a permanent location, such as a theater or conference room, see page 141.

Turning the Projector On and Off

Make sure your projector and any computer or video equipment are connected as described on page 39. Turn on your connected equipment before starting the projector so it can automatically detect and display the image source. If you turn on the projector first, or have multiple pieces of connected equipment, you may have to select the image source manually (see page 18).

note

After positioning the projector, you may want to connect a Kensington MicroSaver® anti-theft device to the lock port on the projector. You can purchase this from Epson; see page 12.

note

You can set the projector to automatically turn off the lamp and enter “sleep mode” when it has not received any signals or the A/V Mute slide remains closed for a period of time. This conserves electricity, cools the projector, and extends the life of the lamp. To enable sleep mode, see page 112.

Turning On the Projector

Follow these steps to turn on the projector:

1. Open the A/V Mute slide (lens cover).

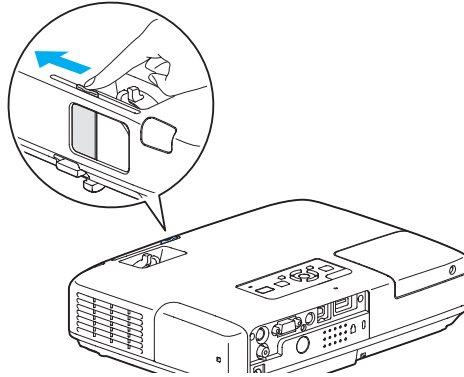

2. Plug one end of the power cable into the projector, and the other end into an electrical outlet.

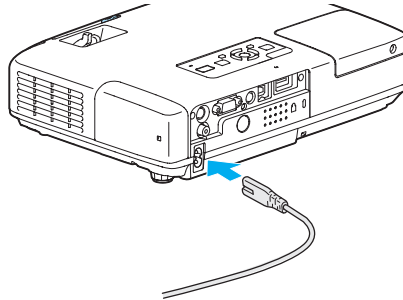

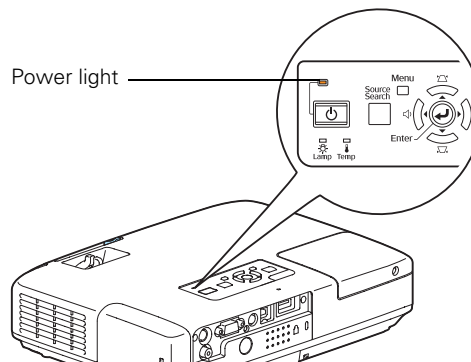

The  Power light turns orange.

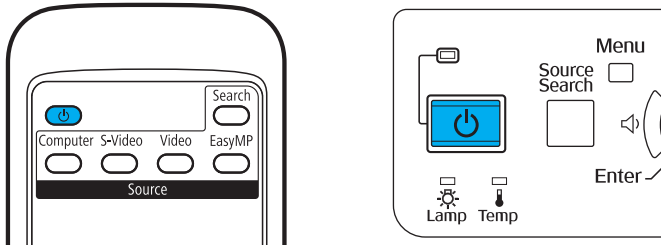

- Press the red  Power button on the remote control or on top of the projector.



The projector beeps once and the  Power light flashes green as the projector warms up, then an image begins to appear. When the  Power light stops flashing and remains green, the projector is ready for use.

- If you are prompted to enter a password, see page 106.

Using the Direct Power On Function

The Direct Power On function enables faster setup. The projector will start up automatically when you plug it in; you won't have to press the  Power button.

Follow these steps to enable Direct Power On:

- Press the **Menu** button on the remote control and select the **Extended** menu.
- Choose **Operation** and press **Enter**.
- Choose **Direct Power On** and press **Enter**.

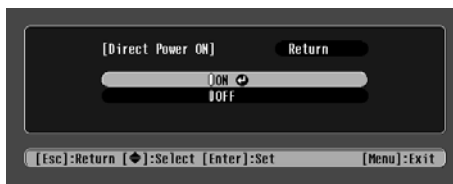

- Highlight **On** and press **Enter**.
- Press **Esc** or **Menu** to exit. The setting will take effect the next time you plug in the projector.

warning

Never look into the lens when the lamp is on. This can damage your eyes, and is especially dangerous for children.

note

If a power outage occurs when Direct Power On is enabled and the projector is plugged in, the projector will restart when the power is restored.

note

Lamp life results will vary depending on mode selected, environmental conditions, and usage.

Turn off this product when not in use to prolong the life of the projector.

Shutting Down the Projector

This projector incorporates Instant Off technology. To turn it off, you can press its **Power** button as described below, unplug it, or turn off a power switch that supplies power to the projector. You don't have to wait for the projector to cool off first.

1. To turn off the projector, press the **Power** button on the remote control or projector.

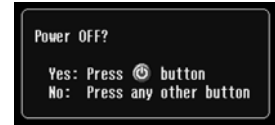

You see a confirmation message.

(If you don't want to turn it off, press any other button.)

2. Press the **Power** button again. The projection lamp turns off and you can unplug the power cord.

If you want to turn the projector on again, make sure the orange **Power** light is not flashing, then press the **Power** button.

3. If you extended the adjustable front foot, press up on the foot release lever to retract it.
4. Close the A/V Mute slide.

note

To focus and adjust the image, see page 22. If a projected image fails to appear, see page 19 for help.

Selecting the Image Source

Selecting the image source lets you switch between images input from different pieces of connected equipment (such as a computer or DVD player).

If you don't see the image you want, press the **Search** button on the remote control or the **Source Search** button on the projector until you see the image you want to project.

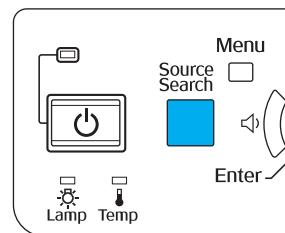
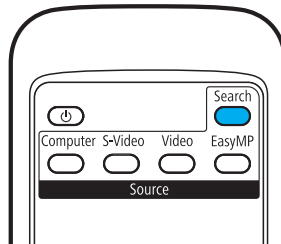

You can also use the **Source** buttons on the remote control to switch between devices connected to the ports identified on each button, or select **EasyMP™** to project wirelessly or from a USB drive.

Troubleshooting Display Problems

Follow these guidelines if you're having trouble displaying an image.

You Can't Project an Image

If you don't see the image you are trying to project, try the following:

- Make sure the cables are connected correctly, as described beginning on page 39.
- Make sure the **Power** light is green and not flashing and the **A/V Mute** slide is open.
- If you've connected more than one computer and/or video source, you may need to press the **Source Search** button on the projector's control panel or **Search** button on the remote control to select the correct source. (Allow a few seconds for the projector to sync up after pressing the button.)
- If you're using a PC notebook, press the function key on your keyboard that lets you display on an external monitor. It may be labeled **CRT/LCD** or have an icon such as . You may have to hold down the **Fn** key while pressing it. Allow a few seconds for the projector to sync up after changing the setting.
- See page 128 for more solutions.

The Projector and Notebook Don't Display the Same Image

If you're projecting from a notebook, and you can't see your image on the projection screen and on your computer at the same time, follow these guidelines.

If you're using a PC notebook:

- On most systems, there's a function key that lets you toggle between the LCD screen and the projector, or display on both at the same time. It may be labeled CRT/LCD or have an icon such as . You may have to hold down the Fn key while pressing it. Allow a few seconds for the projector to sync up after changing the setting.
- If the function key doesn't permit you to display simultaneously on both screens, you should check your monitor settings to make sure both the LCD screen and the external monitor port are enabled.

From the Control Panel, open the **Display** utility. In the Display Properties dialog box, click the **Settings** tab, then click **Advanced**. The method for adjusting the settings varies by brand; you may need to click a **MONITOR** tab, then make sure the external Monitor port is set as your primary display and/or enabled. See your computer's documentation or online help for details.

If you're using Mac OS X:

You may need to set up your system to display on the projector screen as well as the LCD screen. Make sure your projector is connected and follow these steps:

1. From the Apple® menu, select **System Preferences**, then select **Displays**.
2. Click **Detect Displays**.
3. Make sure the **VGA Display** or **Color LCD** dialog box is selected.

4. Click the Arrangement (or Arrange) tab.

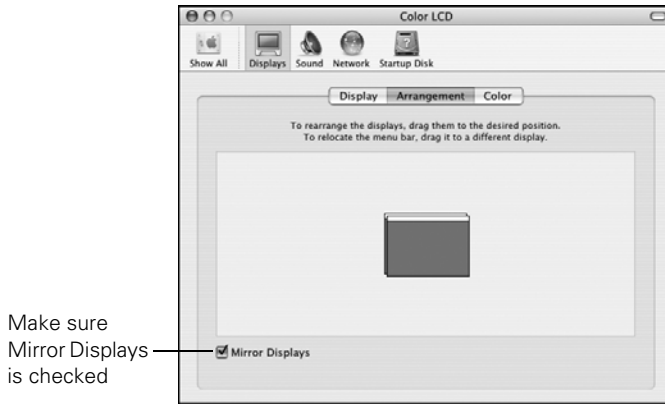

5. Make sure the Mirror Displays checkbox is selected.

Adjusting the Image

Once you see your image, you need to make certain adjustments:

- If the image is too high or too low, you can reposition it. See below.
- To focus or zoom your image, see page 23.
- If the image isn't square, see page 23.
- If a computer image displays incorrectly, see page 25.
- If you need to fine-tune the image and/or sound, see page 97.

Adjusting the Height of Your Image

If the image is too low on the screen, you can use the front adjustable foot to raise it.

1. Stand behind the projector. Press the foot release lever up and lift the front of the projector.

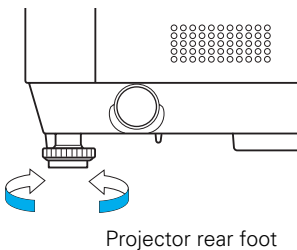
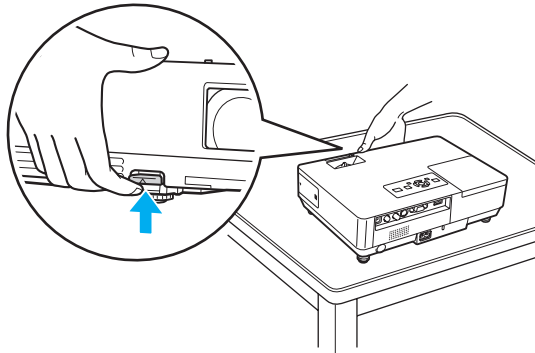

2. Once the image is positioned where you want it, release the lever to lock the foot in position.
3. If necessary, you can fine-tune the height or level of the image by turning the projector's adjustable rear feet.

Raising the projector causes the image to distort or “keystone,” but you can correct the shape as described on page 23.

Focusing and Zooming Your Image

Turn the focus ring on the projector to sharpen the image.

Turn the zoom ring on the projector to reduce or enlarge the image.

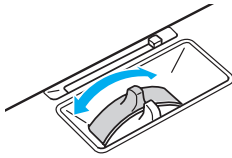

Focus



Zoom

If the image still isn't large enough, you may need to move the projector farther away from the screen. You can also use the E-Zoom buttons on the remote control to zoom in on a portion of the image. See page 31 for instructions.

Adjusting the Image Shape

In most cases, you can maintain a square or rectangular image by placing the projector directly in front of the center of the screen with the base of the lens level with the bottom of the screen.

Even if the projector is slightly tilted (within a range of 30° up or down), the projector has an automatic keystone correction function that detects and corrects vertical keystone distortion.

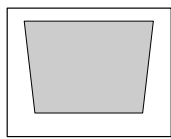

Projector tilted up

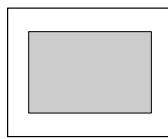

Corrected image

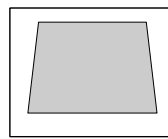

Projector tilted down

It takes about one second after projection starts for the image to be corrected. During this time, a vertical keystone correction gauge appears on the screen.

If your image is still distorted, you can correct it using the Keystone buttons on the projector's control panel or the projector's Setting menu.

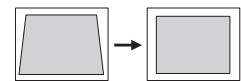

Keystone correction

Using Keystone Correction

To adjust your image when it is wider on the top or bottom, do the following:

- Press one of the two keystone correction buttons on the projector's control panel, as shown below. Continue pressing the button until you are satisfied with the shape of the image.

tip

You can display a test pattern to help align the image (see page 105).

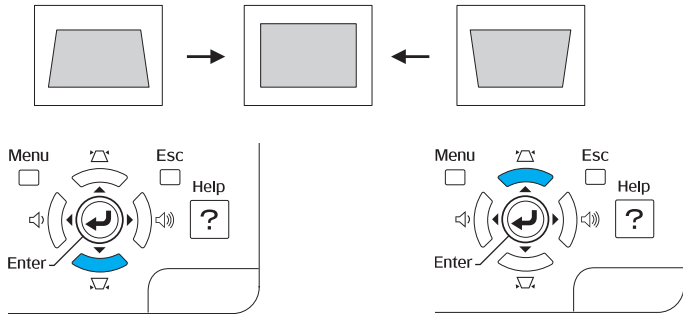

- Or press the **Menu** button on the remote control or projector, select the **Setting** menu, and press **Enter**.

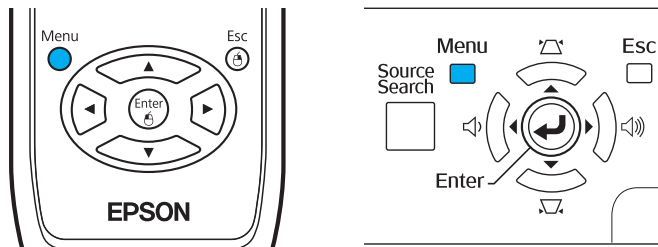

From the Setting menu, select **Keystone** and press **Enter**. Use the  pointer button on the remote control to adjust the keystone setting as needed.

If the image quality declines (for example, lines or edges look jagged), reduce the sharpness setting. See page 101.

Correcting Computer Images

If you're connected to a computer and the image doesn't look right, press the **Auto** button on the remote control or the **Enter** button on the projector. This automatically resets the projector's tracking, sync, resolution, and position settings.

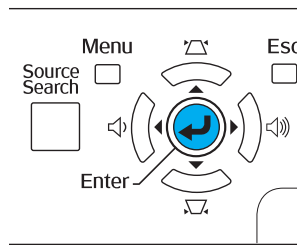
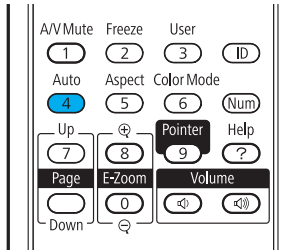

If the **Auto** button doesn't correct the problem, you may need to adjust the tracking or sync using the projector's **Signal** menu. See page 103 for more information.

note

The Auto button works only with computer images projected through the VGA port.

2

Using the Remote Control

The projector includes a number of tools to enhance your presentation. All of them can be accessed using the remote control, which lets you operate the projector from anywhere in the room—up to 20 feet away.

note

For information and resources to help you give the most professional presentation, be sure to visit presentersonline.com.

You can use the remote control to adjust the picture and sound (page 29) or to adjust the color mode for various environments (page 33). You can also use it as a wireless mouse when projecting from a computer (page 35) or as a pointer to highlight your presentation (page 36).

This chapter covers:

- Using the remote control
- Controlling the picture and sound
- Operating your computer with the remote control
- Highlighting your presentation
- Operating two or more projectors with the remote control

note

If a button is pressed longer than 30 seconds, the remote control stops operating to conserve power. When you release the button, normal operation resumes.

caution

When replacing batteries, take the following precautions:

- *Replace the batteries as soon as they run out. If the batteries leak, wipe away battery fluid with a soft cloth. If fluid gets on your hands, wash immediately.*
 - *Do not expose batteries to heat or flame.*
 - *Dispose of used batteries according to local regulations.*
 - *Remove the batteries if you won't be using the projector for a long period of time.*
-

Using the Remote Control

Follow these tips for using the remote control:

- Point the remote control at the front of the projector or at the screen.
- Stand within 20 feet of the projector.
- Avoid using the remote under bright fluorescent lamps or in direct sunlight, or the projector may not respond properly.

Replacing the Batteries

Replace the batteries as described below:

1. Turn the remote control over.
2. Press the tab on the battery cover to open it.
3. Install two AA batteries, inserting the + and – ends as shown.
4. Close the cover, pressing it down until it snaps into place.

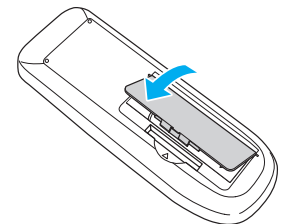
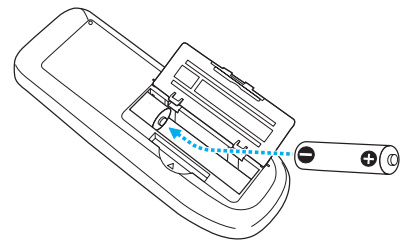
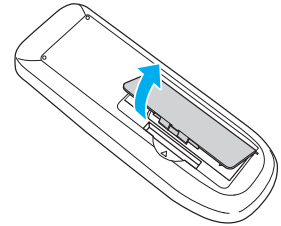

Controlling the Picture and Sound

You can use the remote control to preview and select your picture sources, temporarily turn off the picture and sound, freeze the action, zoom in on the picture, and adjust the volume.

Switching Between Picture Sources

If your projector is connected to more than one computer and/or video source, you can switch between the different sources:

- The easiest way to select your source is to press the **Search** button on the remote control (or the **Source Search** button on the projector) repeatedly until you see the image you want on the screen.

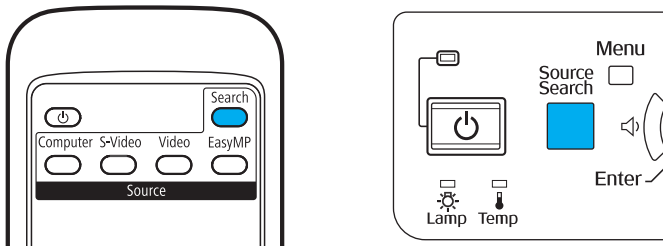

- On the remote control, there are four **Source** buttons. Use them to switch between equipment connected to the port identified on each button, or to use EasyMP.

After you select a source, the screen goes dark for a moment before the image appears.

Turning Off the Picture and Sound

You can use the **A/V Mute** button on the remote control to turn off the image and sound. This does the same thing as the A/V Mute slide (shown on page 16) and is useful if you want to temporarily redirect your audience's attention.

- To turn off the picture and sound, press the **A/V Mute** button. The screen turns black.
- To turn the image and sound back on, press the button again.

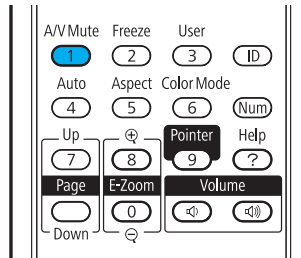

You can have the screen turn blue when you press the **A/V Mute** button. You can also have an image, such as a company logo, display on the screen (see page 108).

Stopping Action

You can use the remote control to stop the action in your video or computer image.

- To stop the action and keep the current image on the screen, press the **Freeze** button. The sound continues.
- To restart it, press the **Freeze** button again.

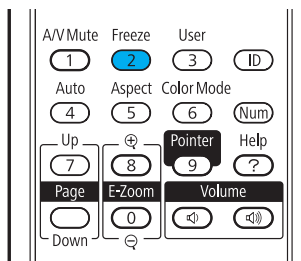





note

This function pauses the image, but not the sound. Also, because the source continues to transmit signals, you won't resume the action from the point you stopped it.



Zooming Part of Your Image

You can zoom in on a portion of the image using the E-Zoom buttons on the remote control.

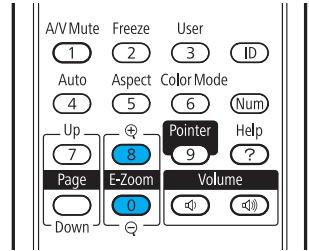
1. Press the E-Zoom  button on the remote control.
You see a crosshair indicating the center of the zoom-in area.
2. Use the  pointer button to position the crosshair.
3. Continue pressing the E-Zoom  button to enlarge the selected area up to 4× magnification.
4. While the image is enlarged, you can:
 - Use the  pointer button to move around the screen.
 - Press the E-Zoom  button to zoom out.
5. When done, press the ESC button to return the image to its original size.



Controlling the Volume

To change the volume, press the  or  button on the remote control or projector.

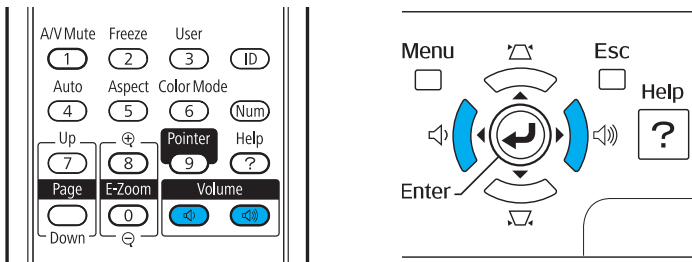

You can also adjust the volume using the projector's menu system. See page 104.

note

To temporarily shut off the sound and picture, press the A/V Mute button or close the A/V Mute slide.

Adjusting the Aspect Ratio

You can use the **Aspect** button on the remote control to adjust how an image fits into the display area. Each time you press the button, the projector changes to the next setting.

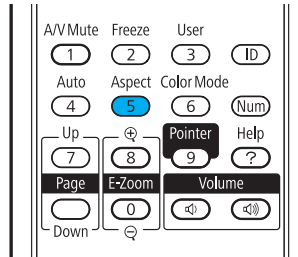

When Connected to Video Equipment

If you're projecting from video equipment such as a DVD player, set the projector's **Aspect** setting to match that of the player. For example, if the video player is set to output images at a 16:9 aspect ratio, set the projector's **Aspect** setting to **16:9** so they match. If the player outputs images at a 4:3 aspect ratio, select **4:3** (PowerLite 1725) or **Normal** (PowerLite 1735W).

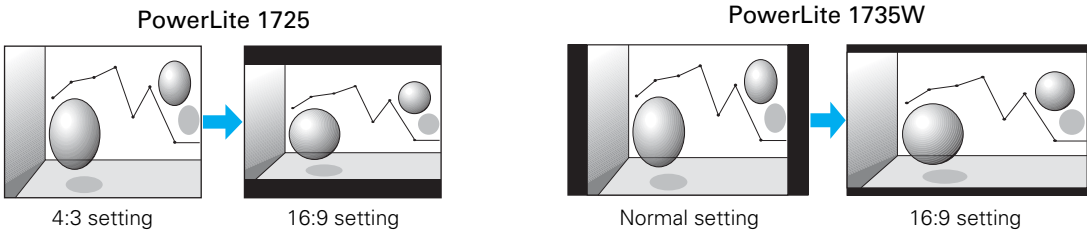

Note that the projector's native aspect ratio (XGA or WXGA, depending on the model) is narrower than 16:9. Therefore, widescreen movies and HDTV broadcasts will display with black bars at the top and bottom when **16:9** is selected as the **Aspect** setting. For the PowerLite 1735W, you can select **Full** to stretch the image vertically to fill the whole projection area.

When Connected to a Computer

For computer images, **Normal** is usually the best setting to select. This displays the image at the largest possible size without stretching it. For computers with wide-panel WXGA displays, the PowerLite 1735W displays the image at WXGA resolution, making full use of the display area; likewise, the PowerLite 1725 displays XGA images to their best advantage.

Depending on your computer display and projector model, you may see black bars at the edges. In that case, try selecting **4:3** (PowerLite 1725 only) or **16:9**. The PowerLite 1735W also lets you select:

- **Full** to stretch the image to fill the whole projection area
- **Zoom** to fit the image in one dimension only, with the other dimension cut off
- **Through** to display the image without stretching or scaling it

If the resolution of the image is the same as the projector's, changing the **Aspect** setting has no effect. Also, if you're projecting through your computer's USB port, you can't change the projector's aspect ratio; instead, change your computer's resolution to match that of the projector.

Adjusting the Color Mode

You can use the **Color Mode** button on the remote control to adjust the color, brightness, and other aspects of your image. This lets you quickly adjust the image for various uses.

Press the button repeatedly to select from the following settings:

Game: For increased brightness and contrast when playing video games or watching TV in a bright room. If you notice video delays during high-speed gaming, turn off the **Progressive** setting (see page 103).

Presentation: For computer presentations in a bright room with color graphics.

Text: For computer presentations in a bright room with black-and-white text and graphics.

note

If part of the image remains cut off, check the projector's Resolution setting (see page 102). Select Normal or Wide, depending on the size of your computer's display panel.

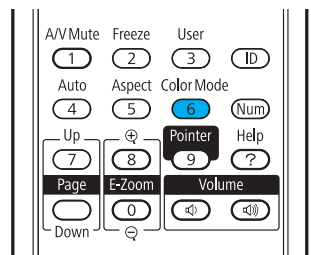

Theatre: For watching movies in a dark room.

Photo: For vivid, high-contrast still images in a bright room (computer images only).

Sports: For vivid TV images projected in a bright room (video, S-video, or composite video only).

sRGB: For matching the color palette of standard sRGB computer displays

Blackboard: For projecting accurate colors on a green chalkboard (adjusts the white point).



Customized: For manual color adjustment. (See “Six-Axis Color Adjustment” on page 101).

Operating Your Computer with the Remote Control

If you connect a computer to the projector with a USB cable, as described on page 42, then select **Wireless Mouse** for the USB Type B setting in the Extended menu (see page 112), you can use the remote control in place of your computer's mouse. This gives you more flexibility when delivering slideshow-style presentations, since you won't have to stand next to the computer to change slides.

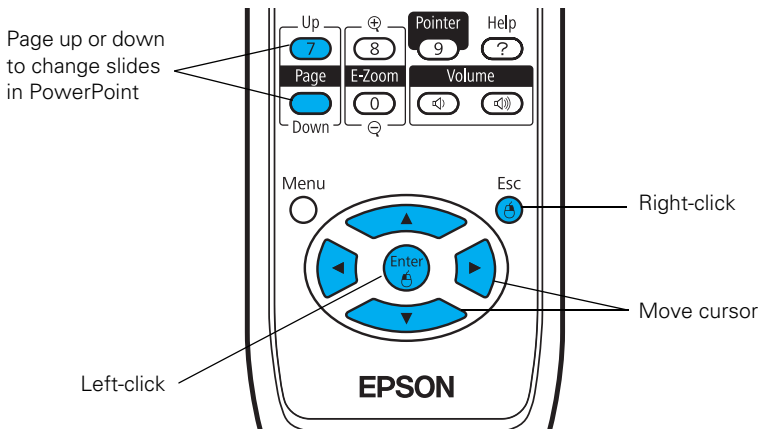
- Use the **Page Up** and **Down** buttons to move through a slideshow.



- Use the  pointer button to move the cursor on the screen.
- Press the **Enter** button once to left-click, or press it twice to double-click. Press the **Esc** button to right-click.
- To drag-and-drop, hold down the **Enter** button. Then use the  pointer button to drag the object. When it's where you want it, press **Enter** to release it.

Highlighting Your Presentation

You can display a pointer to call out important information on the screen. If you want to customize the pointer tool, you can choose from three alternative shapes.

Using the Pointer Tool

1. To activate the pointer tool, press the **Pointer** button on the remote control. A pointer appears on the screen.

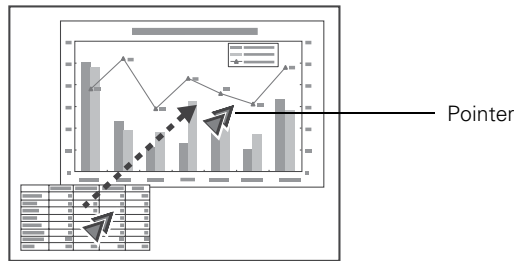
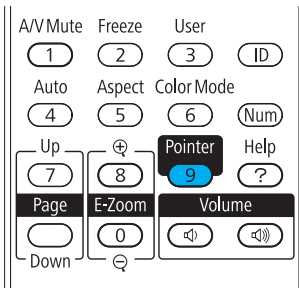

If you prefer to use a different style of pointer, see the instructions in the next section.

2. Use the  pointer button on the remote control to position the pointer on the screen.
3. When you're done using the pointer, press the **Pointer** or **Esc** button to clear the screen.

Customizing the Pointer Tool

You can change the appearance of the pointer by choosing from three alternative shapes.



1. Press the **Menu** button on the remote control, highlight the **Settings** menu, highlight **Pointer Shape**, and press **Enter**. You can select one of the pointer shapes shown at the left.
2. Select the shape you want and press **Enter**.
3. Highlight **Return** and press **Enter**.
4. Press **Menu** to exit from the menu system.

Operating Two or More Projectors with the Remote Control

If you're using more than one projector, you can control all the projectors—or just selected ones—by using the projector and remote control ID system. First assign a unique ID number to each projector. Then set the remote control to match the ID of the projector you want to operate. This lets you control it without affecting the others.

Setting the Projector ID

The projector's default ID is set to Off. This lets it respond to commands from any remote control. To change the ID, follow these steps:

1. Press the **Menu** button on the remote control. You see the projector's menu screen.
2. Select **Extended > Projector ID**.

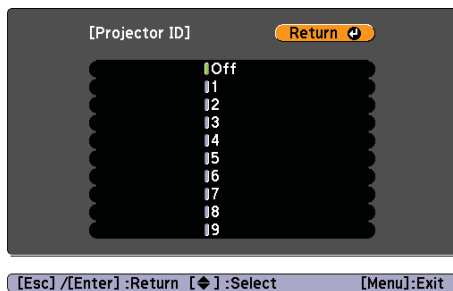

3. Use the  pointer button to highlight the new ID, and press **Enter** to select it.
4. When done, press **Menu** to exit the menu system.

Checking the Projector ID

To check the ID of a specific projector:

1. Point the remote control at the projector you want to check.

2. Press the ID button on the remote control. You see a message on the screen, showing the projector's ID:

Projector ID : 3
Remote Control: On

Projector ID : 3
Remote Control: Off

If the message says the remote control is “On,” then you can use the remote control to operate that projector. If it says “Off,” then you have to change the ID of the remote control before operation is possible, as described in the next section.

Setting the Remote Control ID

The remote control's default ID is zero. This lets it operate any projector. To set it to operate only those projectors with a specific ID, follow these steps:

1. Press and hold the ID button on the remote control.

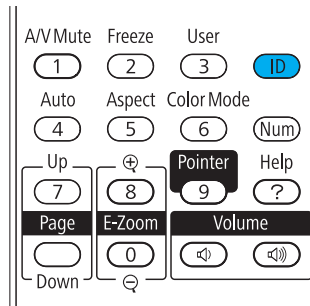

2. While holding the ID button, press the numbered button on the remote control (1 through 9) that corresponds to the ID of the projector(s) you want to operate. Selecting zero lets you control all projectors.

note

If you're using a remote control ID other than the default ID of zero, you have to set the ID each time you turn on the projector.

3

Connecting to Computers, Cameras, and Other Equipment

This chapter tells you how to connect the projector to a notebook or desktop computer, and/or to video equipment, such as a VCR, DVD player, or video camera. You can also connect the projector to a USB storage device, digital camera, or external speakers.

Follow the instructions in this chapter on:

- Connecting to a computer
- Connecting video equipment
- Connecting to a digital camera or other USB device
- Playing sound through the projector

Connecting to a Computer

note

Don't try to force a connector to fit a port with a different shape or number of pins. You may damage the port or connector.

You can connect the projector to any computer that has a standard video output (monitor) port, including desktop models, PC notebook computers, MacBook, PowerBook and iBook systems, and hand-held devices.

You can also connect to the USB port on a Windows® computer. This lets you connect up to two computers to the projector, one using a VGA cable and one using a USB cable.

- To connect to your computer's video port, see the instructions below.
- To connect using your computer's  USB port, see page 41.
- To control your presentation using the remote control as a “wireless mouse,” see page 42.

Connecting to the Video Port

You can connect to your computer using the VGA computer cable that came with the projector (the monitor port on your computer must be a mini D-sub 15-pin port).

1. Connect one end of the VGA computer cable to the projector's blue **Computer (Component Video)** port, and the other end to your computer's monitor port.

note

Make sure the Input Signal setting in the Signal menu is set to Auto or RGB (see page 103).

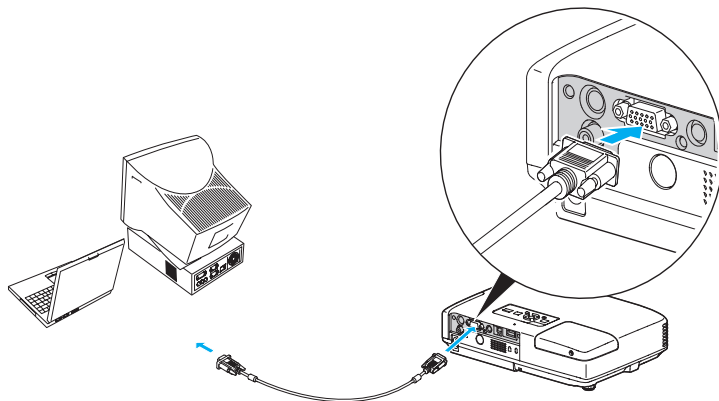

2. You can connect an optional stereo mini-jack audio cable to play sound through the projector (see page 50), or connect a USB cable to use the remote control as a mouse (see page 42).
3. When you've finished making any connections, see page 15 for instructions on turning on the projector and adjusting the image. Once the projector is turned on, select the image source: press the **Search** button on the remote control or the **Source Search** button on the projector's control panel.

Connecting to the USB Port

You can connect a Windows Vista®, Windows XP, or Windows 2000 (SP4) computer to the projector's Type B (square)  USB port and project your computer's display. The USB connection also supports computer audio output. A USB 2.0 connection provides better picture quality and response than USB 1.1.

The first time you connect your computer to the projector's USB port, software from the projector installs on your computer.

1. Follow the instructions beginning on page 16 to turn on the projector and adjust the image.
2. Set the **USB Type B** setting in the projector's Extended menu to **USB Display** (see page 112).
3. Turn on your computer.
4. Locate the USB cable that came with your projector.

note

The USB display feature is not available for Windows 98, Windows Me, or Macintosh. To use this feature, your computer must allow you to install software from the projector.

5. Connect the square end of the cable to the projector's Type B (square)  USB port.

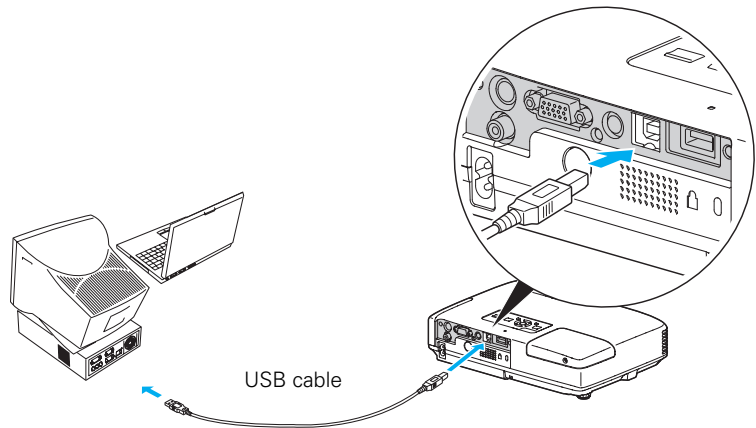

6. Connect the flat end of the cable to any available USB port on your notebook or desktop computer.

Messages appear as the projector is recognized and the software installation begins.

7. Follow the instructions on your computer screen to install the Epson USB Display software. If you see a “Digital Signature Warning,” select **Continue**. You will only need to install the software the first time you connect.
8. After the software has installed, press the **EasyMP** button on the remote control. “Easy MP” appears briefly in the upper right corner of the image and you see your computer’s desktop displayed by the projector.

note

Next time you connect via USB, you won't have to wait for the software to install.

Connecting the Cable for Remote Mouse Control

If you've connected a computer as described in this chapter using the **Computer (Component Video)** port, you can use the projector's remote control as a wireless mouse. This lets you control your computer and click through slideshow-style presentations, such as PowerPoint®, from up to 20 feet away (see page 35 for more information).

The wireless mouse function is supported on systems with a USB port running Windows or Mac OS®.

1. Locate the USB cable that came with your projector.
2. Connect the square end of the cable to the projector's **Type B** (square)  USB port.

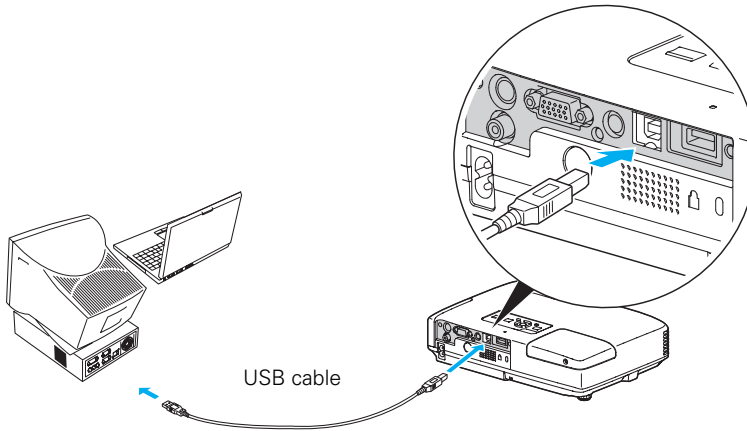

3. Connect the flat end of the cable to any available USB port on your notebook or desktop computer.
4. Set the **USB Type B** setting in the projector's Extended menu to **Link 21L** (see page 112).
5. Press the **Computer** button on the remote control to select your computer as the source. (The wireless mouse function doesn't work when other sources are selected.)
6. If necessary, configure your computer to work with a USB mouse. See your computer documentation for details.

Connecting to Video Equipment



RCA connector
(composite video)



S-video
connector

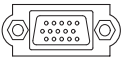

VGA connector
(RGB video)

You can connect several video sources to the projector at the same time. Before starting, look at your video equipment to determine its available video output connections:

- If your video player has a yellow RCA-style video output connector, see “Connecting a Composite Video Source” on page 45.
- If your video player has an S-video connector, see “Connecting an S-Video Source” on page 46.
- If your video player has a component video port (three connectors labeled either Y/Cb/Cr or Y/Pb/Pr), see “Connecting a Component Video Source” on page 47.
- If your video player has an RGB video port (either a single connector for a VGA-style monitor cable or three connectors labeled R/G/B), see “Connecting an RGB Video Source” on page 48.

After connecting video cables, you may also want to connect an audio cable to play sound through the projector; see page 50.

Connecting a Composite Video Source

1. Locate an RCA-style video cable (one is usually provided with your video equipment or you can purchase one from an electronics dealer).
2. Connect the cable to the yellow video output connector on your player and the yellow **Video** connector on the projector:

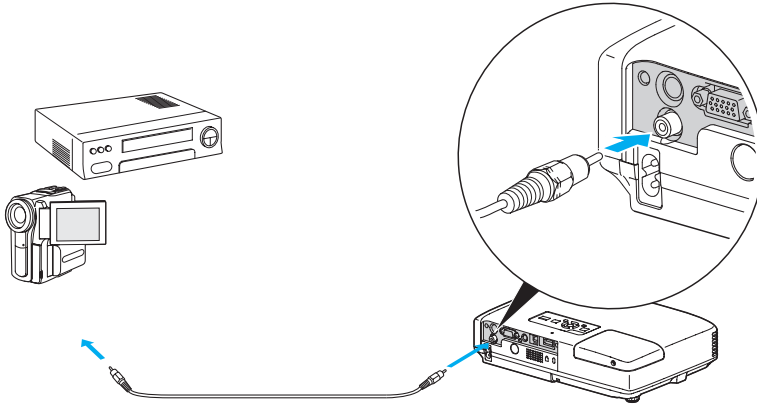

3. If you want to play sound through the projector, see page 50 for instructions on connecting audio cables.
4. If you don't need to make any other connections, see page 15 for instructions on turning on the projector and adjusting the image. Once the projector is turned on, select the image source: press the **Search** button on the remote control or the **Source Search** button on the projector's control panel.

Connecting an S-Video Source

1. Locate an S-video cable (one is usually provided with your video equipment or you can purchase one from Epson; see page 12).
2. Connect the cable to the S-video connector on your player and the S-Video connector on the projector:

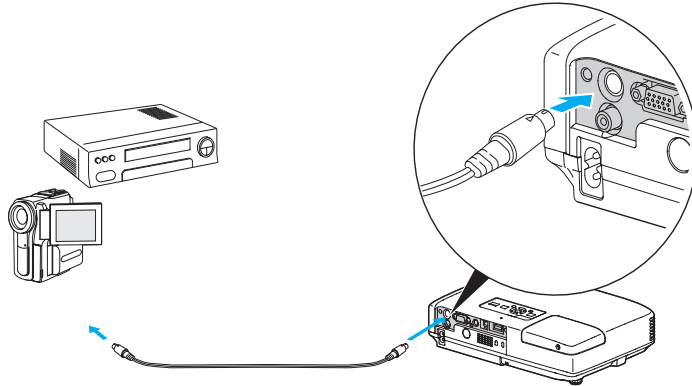

3. If you want to play sound through the projector, see page 50 for instructions on connecting audio cables.
4. If you don't need to make any other connections, see page 15 for instructions on turning on the projector and adjusting the image. Once the projector is turned on, select the image source: press the **Search** button on the remote control or the **Source Search** button on the projector's control panel.

Connecting a Component Video Source

You will need a component-to-VGA cable, or a component video cable and adapter, for this connection. You can order the component-to-VGA cable (ELPKC19) from Epson; see page 12 for more information.

1. Locate a component-to-VGA video cable or adapter.
2. Connect the cable to your player and the blue **Computer (Component Video)** connector on the projector. If you're using an adapter, connect it to a standard component video cable as shown below.

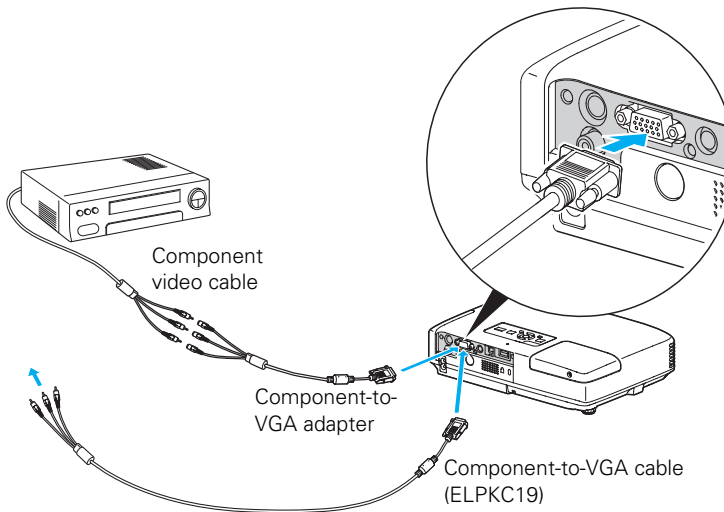

3. If you want to play sound through the projector, see page 50 for instructions on connecting audio cables.
4. If you don't need to make any other connections, see page 15 for instructions on turning on the projector and adjusting the image. Once the projector is turned on, select the image source: press the **Search** button on the remote control or the **Source Search** button on the projector's control panel.

note

Make sure the Input Signal setting in the Signal menu is set to Auto or Component Video (see page 103).

Connecting an RGB Video Source

note

Make sure the Input Signal setting in the Signal menu is set to Auto or Component Video (see page 103).

1. Locate the VGA computer cable provided with the projector.
2. Connect the cable to the video port on your player and the Computer (Component Video) port on the projector.

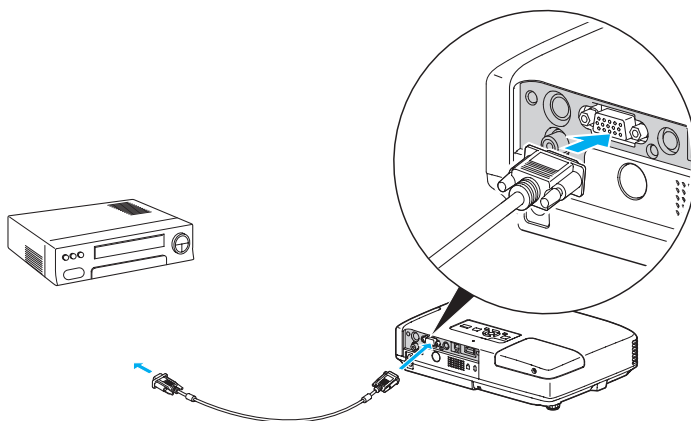

3. If you want to play sound through the projector, see page 50 for instructions on connecting audio cables.
4. If you don't need to make any other connections, see page 15 for instructions on turning on the projector and adjusting the image. Once the projector is turned on, select the image source: press the **Search** button on the remote control or the **Source Search** button on the projector's control panel.

Connecting to a Digital Camera or Other Device

You can connect your digital camera, USB flash memory drive, USB hard drive, or multimedia storage viewer, such as the Epson P-5000 or iPod® photo. Use the USB cable specified for your device. Then you can use your device's slideshow function or the projector's EasyMP PC Free feature (see the *EasyMP Operation Guide* for details) to present images.

1. Connect the flat end of the USB cable to the Type A USB port on the projector, as shown.

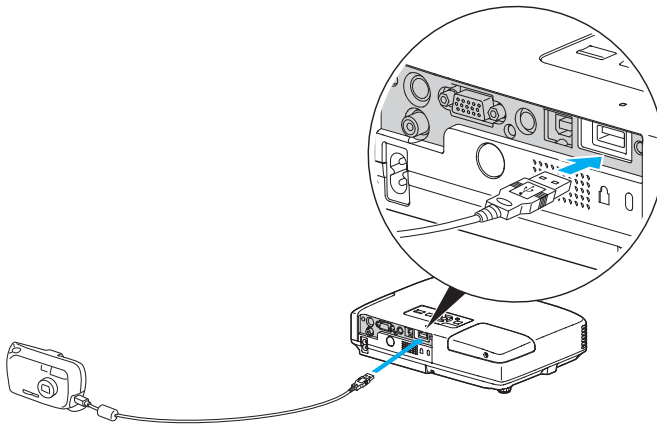

2. Connect the other end of the cable to your camera or other device.

Removing the USB Cable

If you're using PC Free mode to project your images, exit PC Free mode before you remove the USB cable from the projector.

1. Position the cursor over the Exit button in the upper right corner of the PC Free screen.
2. Press the Enter button on the remote control to close PC Free mode.
3. Disconnect the USB cable.

note

Use a cable less than 10 feet long and connect the camera directly to the projector. Your projector may not function correctly if you use a longer cable or connect your camera to a USB hub.

If you connect a USB hard drive, make sure you use the AC adapter to power the hard drive.

The slideshow function on some devices may not work with the USB connection.

Playing Sound Through the Projector

You can play sound through the projector's speaker system or attach an external speaker system (for EasyMP use only).

To play sound through the projector, follow these steps:

1. Locate the appropriate cable and connect it to the **Audio** jack on the projector.
 - For laptop and most desktop computers, use a stereo mini-jack cable.

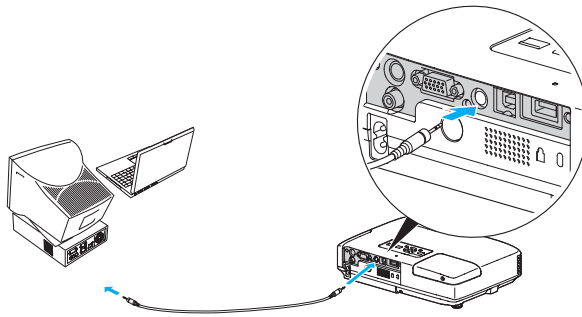

- For video equipment, use an RCA-style audio cable and the audio adapter included with the projector.

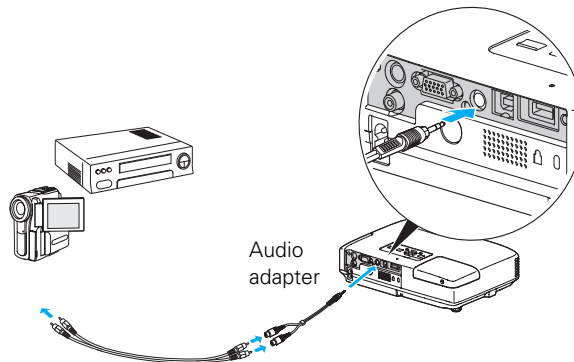

2. Connect the other end of the cable to the audio output connector(s) on your computer or video equipment.
3. Make sure the **EasyMP Audio Out** option in the Settings menu is set to **Internal**. See page 105 for instructions.

Connecting External Speakers

When you use EasyMP, you can output the sound to external speakers with a built-in amplifier.

To connect speakers to the projector, follow these steps:

1. If your speakers have a stereo mini-jack connector, connect it to the **Audio** port on the projector. If your speakers have two RCA stereo jacks, use the audio adapter included with the projector.

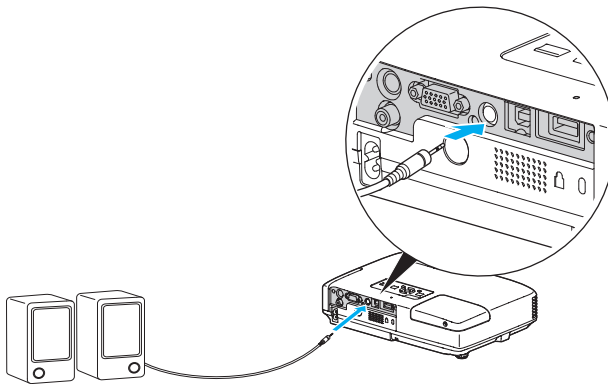

2. Set the **EasyMP Audio Out** option in the projector's Settings menu to **External**. See page 105 for instructions.

The projector's internal speaker system is disabled while sound is output to external speakers.

4

Setting Up Network Projection

This chapter tells you how to prepare to send images to your projector through a wireless or wired network.

Using Quick Wireless Connection or EMP NS Connection, you can project images shown on your computer screen—including text, graphics, and video—directly to your audience. See the *EasyMP Operation Guide* for information on features and use.

If you have Windows Vista, you can also use the Network Projector feature to communicate with your network-connected projector.

You'll find instructions in this chapter on:

- Using Quick Wireless Connection
- Configuring projector and network settings
- Using wireless security options
- Removing the wireless 802.11 a/b/g module
- Connecting the projector to a wired LAN
- Sending e-mail alerts and monitoring the projector
- Using Windows Vista Network Projector

Before starting, make sure you've installed the wireless module, as described on the *Quick Setup* sheet, or the optional Ethernet unit (see page 90). Then follow the steps in this chapter to use Quick Wireless Connection (Windows only) or configure your projector and network. Finally, see the *EasyMP Operation Guide* for instructions on installing the EMP NS Connection software. The *EasyMP Operation Guide* also contains instructions on using the software to project over the network.

Using Quick Wireless Connection

note

The USB key is stored in a small pouch inside the carrying case. Do not attempt to write to the key or use it as a flash memory drive. To replace a lost or missing key, contact Epson (see page 12).

Using the USB key that came with your projector, you can quickly connect the projector to a Windows computer without any configuration.

First, make sure you have installed the wireless module and turned on the projector as described on the *Quick Setup* sheet.

1. Connect the USB key to the projector's  Type A (flat) USB port.

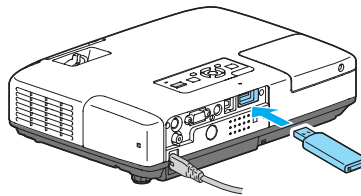

2. When you see a projected message that the network information update is complete, remove the USB key.
3. Connect the USB key to a USB port on your computer or notebook.

In Windows Vista, if you see the AutoPlay window, select **Run LaunchU3.exe**. When you see the User Account Control screen, click **Allow**.

4. When you see a license agreement, click **Agree** to install the Quick Wireless Connection driver.

If you see a Windows Firewall message, click **Yes** to disable the firewall.

After a few minutes, your computer image will be displayed through the projector. If not, try restarting your computer.

5. When you're done with your presentation, remove the USB key. You may need to restart your computer to reactivate your wireless interface.

note

The Quick Wireless Connection utility will disable any other wireless sessions and adapter programs. Make sure you leave the USB key in your computer for your entire Quick Wireless Connection session. Follow the instructions on this page to remove the USB key when you are finished with the session.

Configuring Basic Settings

You can give your projector a unique name, enable a projector keyword, or create a password for controlling the projector over the Web.

1. Press the **Menu** button, then choose **Network** and press **Enter**.
2. Choose **Network Configuration** and press **Enter**.
3. Choose **Basic** and press **Enter**.

You see the following screen:

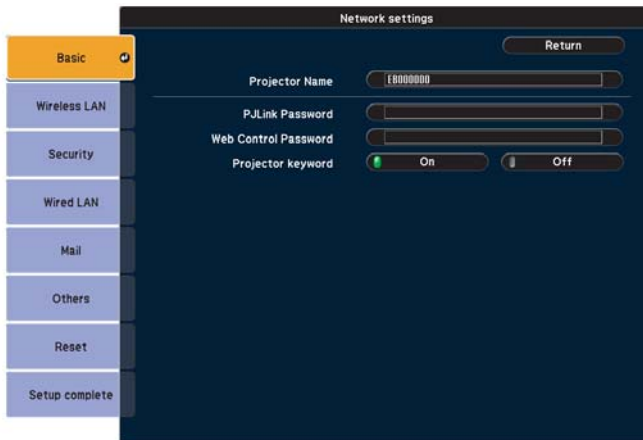

4. Make sure the projector has a unique name, so you can identify it when connecting to it from your computer.

If you need to rename it, highlight the **Projector name** text box then press **Enter**.

5. Use the  buttons on the remote control to select individual letters; then press **Enter** to input a character. To add a blank space or to navigate backward and forward through the input text, highlight the arrows and press **Enter**. To toggle symbol settings or capital letters, highlight the option and press **Enter**. When you're done, highlight **Finish** and press **Enter**.



6. If you want to create a password for remote access to the projector, highlight **Web Control Password**, press **Enter**, and enter a password of up to 8 alphanumeric characters. When you're done, highlight **Finish** and press **Enter**.
7. If you want to set up a security keyword so that only people who are in the same room as the projector can access it, turn **Projector keyword** on. Then when you want to connect to the projector, it displays a randomized four-digit number or "keyword" on the screen. If you're using EMP NS Connection, you can enter the keyword on your computer to connect (see the *EasyMP Operation Guide* for details).
8. When you're done making these settings, highlight the **Return** button at the top of the screen, then press **Enter**.

Configuring the Connection

You can use NS Connection to connect to the projector and send images wirelessly in two modes: Ad Hoc mode or Access Point mode.

- **Ad Hoc mode** (computer-to-computer mode) lets you connect just one computer to the projector at a time; it's easy to set up, and the only equipment you need is a computer with a wireless (802.11g, 802.11b, or 802.11a) network card or adapter, or a Macintosh® with an AirPort® or AirPort Extreme card. When you connect with this mode, any connection to other wireless networks is broken; you can connect to the projector only.
- **Access Point mode** (infrastructure mode) lets multiple computers access the projector at the same time and easily trade off control over the projector. To use Access Point mode, you need a wireless (802.11g, 802.11b, or 802.11a) access point or an AirPort Extreme (or AirPort) base station, and one or more computers with wireless network cards or adapters.

Follow the instructions below for the mode you want to use.

note

Make sure you've installed the NS Connection software as described in the EasyMP Operation Guide.

To connect to the projector over a wireless network, your computer must be running Windows 2000, XP, or Vista. Your Mac must be running Mac OS X 10.3 to 10.5. See the EasyMP Operation Guide for complete system requirements for projecting wirelessly.

Access Point mode (infrastructure mode) is required to achieve transfer speeds up to 54MB/sec on an 802.11g network. Ad Hoc mode (computer-to-computer mode) limits network connections to 11MB/sec. This is a standard specification of 802.11g networking.



Using Ad Hoc Mode

To use Ad Hoc (computer-to-computer) mode, adjust your projector and wireless card or adapter settings as described in this section.

Configuring the Projector

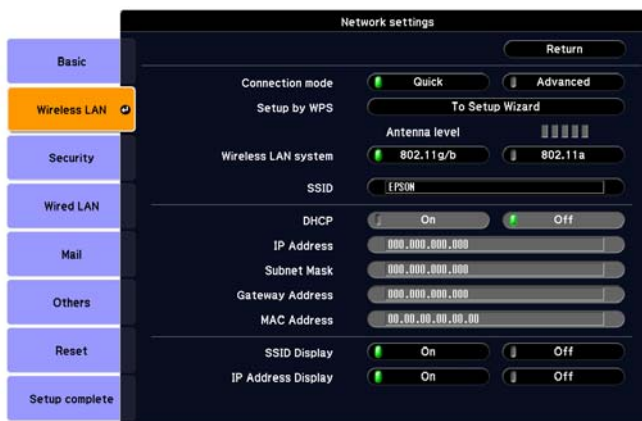
1. Press the **Menu** button, then choose **Network** and press **Enter**.
2. Choose **Network Configuration** and press **Enter**.
3. Choose **Wireless LAN** and press **Enter**. You see this screen:



4. Make sure **Quick** is selected for the **Connection mode**. If not, use the  buttons on the remote control to highlight **Quick**, then press **Enter** to select it.
5. If your network is using **802.11a**, use the  buttons on the remote control to highlight **802.11a**, then press **Enter** to select it.
6. If your network card supports an **SSID** or **ESSID** name (see page 62), highlight the **SSID** text box, press **Enter**, and enter a name:

Use the  buttons to select individual letters; then press **Enter** to input a character. To add a blank space or to navigate backward and forward through the input text, highlight the arrows and press **Enter**. To toggle symbol settings or capital letters, highlight

the option and press **Enter**. When you're done, highlight **Finish** and press **Enter**.



Note that the SSID is case-sensitive (if you enter the name in uppercase on the projector, you must type it the same way on the computer connecting to the projector).

7. If you want to prevent the SSID from being displayed on the standby screen, set the **SSID Display** option to **Off**.
8. To prevent the IP address from appearing on the standby screen, set the **IP Address Display** setting to **Off**.
9. When you're done making these settings, highlight the **Return** button at the top of the screen, then press **Enter**. Choose **Setup Complete** and press **Enter**, then choose **Yes** and press **Enter** to save your settings.

Now you're ready to set up your computer to project wirelessly. Go to "Configuring the Network Settings for Windows" on page 60, or "Setting Up Your Mac for Ad Hoc Mode" on page 62.

Configuring the Network Settings for Windows

Before connecting to the projector, you need to make sure the settings for your notebook's or PC's network card match the settings you entered for the projector.

note

On some Windows systems, you can right-click My Network Places or Network Neighborhood on the desktop and select Properties.

Settings may vary, depending on your wireless network adapter. See the documentation for your adapter for more information.

1. Access your wireless network Properties window. For example, in Windows XP you would click **Start > Control Panel > Network and Internet Connections**. Then click the **Network Connections** icon. You see a screen similar to this:

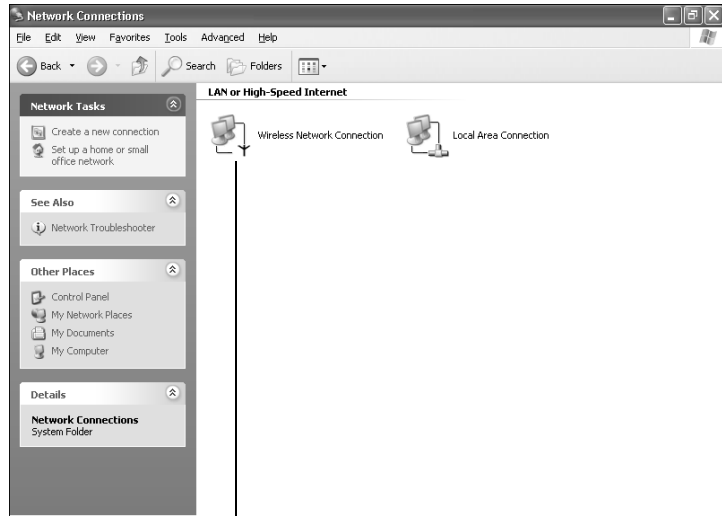

Right-click and select Properties

2. Right-click the **Wireless Network Connection** icon and select **Properties**. You see a screen similar to this:

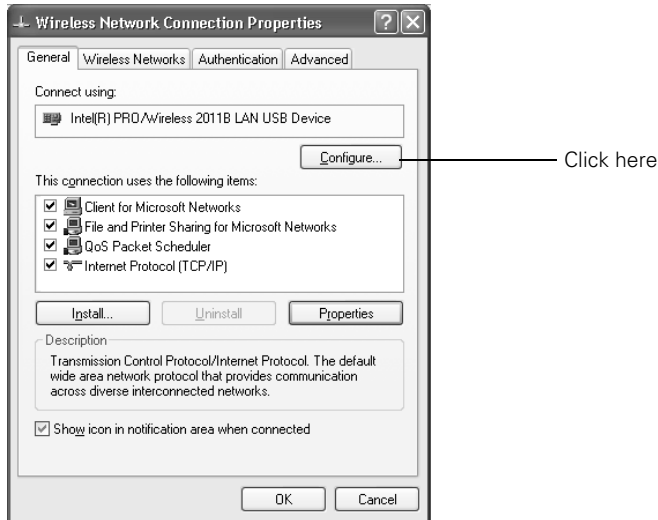

3. Click the **Configure** button.
4. Click the **Advanced** tab. You see a screen similar to this:

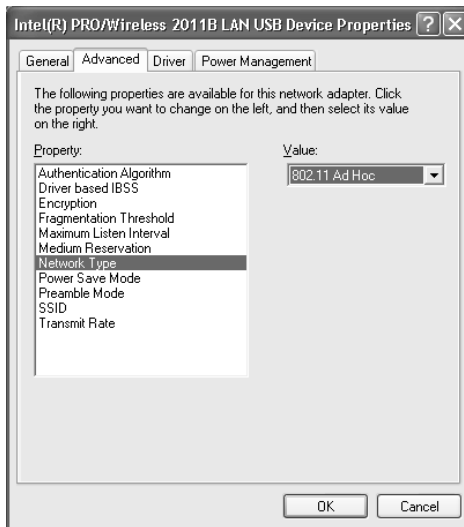

note

When you connect in Ad Hoc mode, your computer is disconnected from any other wireless networks. If you need to remain connected to your wireless network, use Access Point mode, as described on page 64. Also, make sure you reconnect to your original wireless network when you are done using the projector.

5. Check your wireless card or adapter device settings. (Depending on the type of card or adapter you're using, some of the settings may be different than those listed here.)
 - Set the Network Type to **802.11 Ad Hoc**.
 - Set the SSID to match the name you assigned to the projector's SSID.
 - Make sure Encryption is **Disabled**.
6. Click the **General** tab and make sure that your wireless card or adapter is enabled.
7. When you're done, click **OK** to close the Properties dialog box.

Now you're ready to connect to the projector. See the *EasyMP Operation Guide* for details.

Setting Up Your Mac for Ad Hoc Mode

Your AirPort software is automatically configured to allow your Mac to detect both computer-to-computer (Ad Hoc) and Access Point networks.

Typically, you only need to select your projector's SSID from the AirPort status menu on the Mac menu bar. If you're having problems detecting the projector, follow these steps:

1. From the Apple pull-down menu, select **System Preferences**.
2. Double-click the **Network** icon. You see the Network settings window.

3. Make sure Location is set to Automatic.

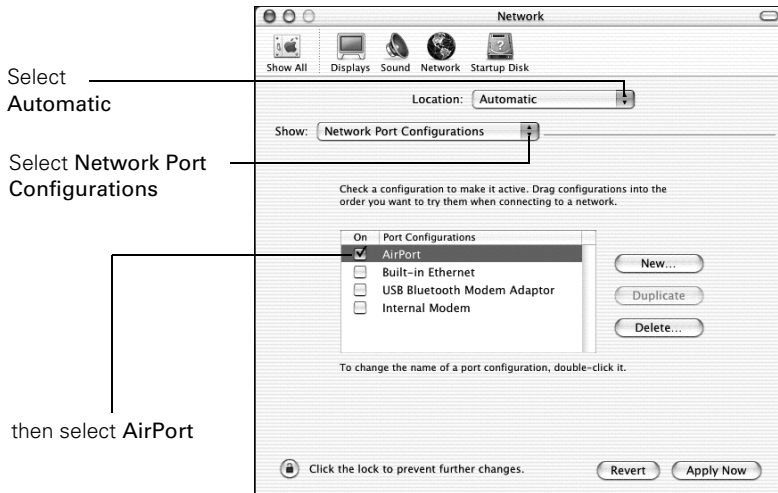

4. Select Network Port Configurations in the Show pull-down menu.
5. Under Port Configurations, select AirPort.
6. Click Apply Now. Then close the window.
7. Click the AirPort icon on the menu bar at the top of the Mac desktop. You see the AirPort status menu:

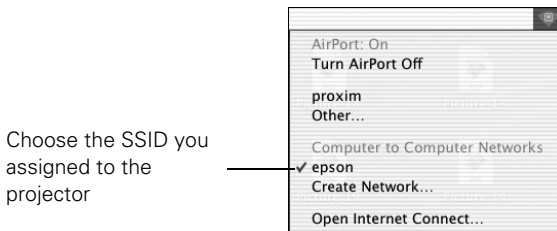

8. Check to make sure AirPort is turned on.
9. Select your projector's SSID.

note

If you don't need the other network port configurations, disable them by deselecting their checkboxes.

When you connect in Ad Hoc mode, your computer is disconnected from any other wireless networks. If you need to remain connected to your wireless network, use Access Point mode, as described on page 64. Also, make sure you reconnect to your original wireless network when you are done using the projector.



Using Access Point Mode

To use Access Point (infrastructure) mode, first adjust your projector and wireless access point or AirPort base station settings as described in this section.

Configuring the Projector

1. Press the **Menu** button, then choose **Network** and press **Enter**.
2. Choose **Network Configuration** and press **Enter**.
3. Choose **Wireless LAN** and press **Enter**. You see this screen:



4. Make sure **Advanced** is selected for the Connection mode. If not, use the  buttons on the remote control to highlight **Advanced**, then press **Enter** to select it.
5. If your network is using 802.11a, use the  buttons on the remote control to highlight **802.11a**, then press **Enter** to select it.
6. To enable your computer to find the projector on the network, you need to enter the SSID name of your access point or the name of your AirPort network in the **SSID** text box. (The name of your AirPort network may be different from that of your AirPort base station; select your base station in the AirPort Admin utility and click **Configure** to check the name of your network.)

Highlight the **SSID** text box, press **Enter**, and enter a name:

Use the  buttons to select individual letters; then press **Enter** to input a character. To add a blank space or to navigate backward and forward through the input text, highlight the arrows and press **Enter**. To toggle symbol settings or capital letters, highlight the option and press **Enter**. When you're done, highlight **Finish** and press **Enter**.



Note that the SSID is case-sensitive (if you enter the name in uppercase on the projector, you must type it the same way on the computer connecting to the projector).

7. If your access point assigns IP addresses automatically, turn on DHCP. Otherwise, turn off DHCP and enter the following information:
 - **IP address:** Enter the IP address you want to assign to the projector. It must be formatted like other addresses on the network. The last 3 digits should be unique.
 - **Subnet mask:** For example: 255.255.255.000, but this depends on how your network is set up.
 - **Gateway address:** Enter the IP address that was assigned to the access point or AirPort base station when it was set up.
8. If you want to prevent the SSID from being displayed on the standby screen, set the **SSID Display** option to **Off**.
9. To prevent the IP address from appearing on the standby screen, set the **IP Address Display** setting to **Off**.
10. When you're done making these settings, highlight the **Return** button at the top of the screen, then press **Enter**. Choose **Setup Complete** and press **Enter**, then choose **Yes** and press **Enter** to save your settings.

note

For specific details about your network, please consult your network administrator.

*If you don't know your gateway or access point address, see page 71. If you're using AirPort, start the AirPort Admin utility, select your base station and click **Configure**. Then click the **Network** tab to see your base station's IP address.*

Now you're ready to set up your computer for wireless projecting. Go to "Configuring the Network Settings for Windows" below, or go to "Setting Up Your Mac for Access Point Mode" on page 72. If you want to enable security options for your network, see page 80 to set up the option that your network uses on the projector.

Configuring the Network Settings for Windows

Before connecting to the projector, you need to make sure the settings for your computer's wireless card or adapter match the settings you entered for the projector.

note

On some Windows systems, you can right-click My Network Places or Network Neighborhood on the desktop and select Properties.

Settings may vary, depending on your wireless network adapter. See the documentation for your adapter for more information.

1. Access your wireless network Properties window. For example, in Windows XP you would click **Start > Control Panel > Network and Internet Connections**. Then click the **Network Connections** icon. You see a screen similar to this:

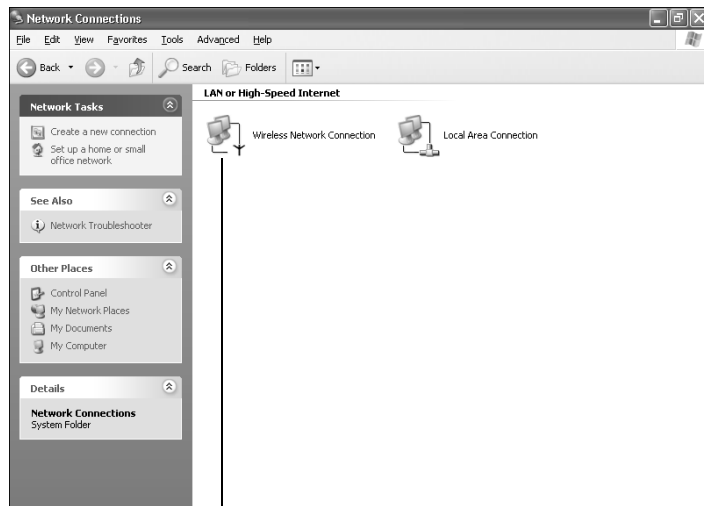

Right-click and select Properties

2. Right-click the **Wireless Network Connection** icon and select **Properties**.

You see a screen similar to this:

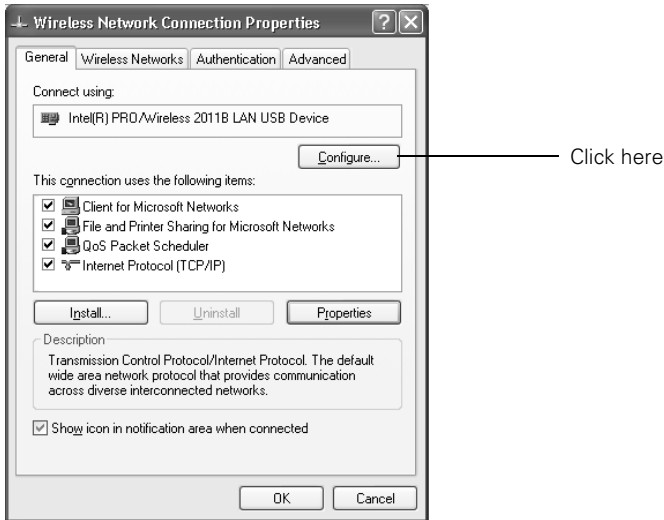

3. Click the **Configure** button.
4. Click the **Advanced** tab. You see a screen like this:

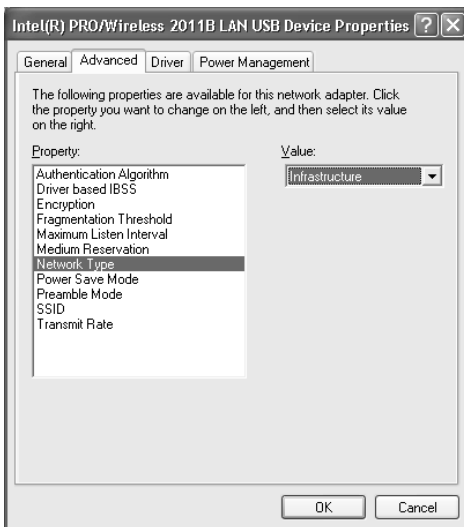

5. Check your wireless card's or adapter's device settings.
(Depending on the type of card or adapter you're using, some of the settings may be different than those listed here.)
 - Set the Network Type to **Infrastructure**.
 - Set the SSID to match the name assigned to the access point (which should also be the projector's SSID).
 - Make sure Encryption is **Disabled** if you have not set up encryption on the projector.
6. Click the **General** tab and make sure that your wireless card or adapter is enabled.
7. When you're done, click **OK** to close the wireless properties dialog box.
8. Right-click the **Wireless Network Connection** icon again and select **Properties**. You see this screen:

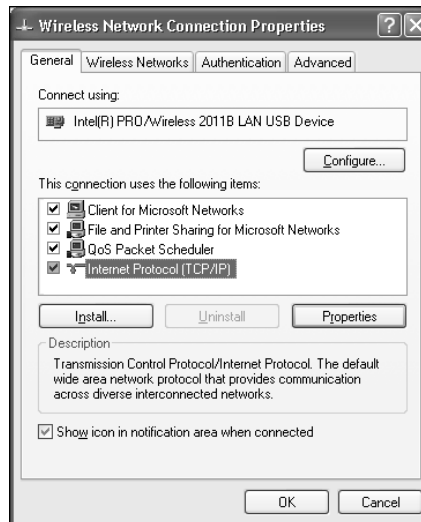

9. Select **Internet Protocol** and click the **Properties** button. You see this screen:



10. If your access point uses DHCP, select **Obtain an IP address automatically**. Otherwise select **Use the following IP address** and enter the required information:

- **IP address:** Type in the IP address you want to assign to the computer. It must be formatted like other addresses on the network. The last section must be unique.
- **Subnet mask:** For example: 255.255.255.000, but this depends on how your network is set up.
- **Default gateway:** Enter the IP address that was assigned to the access point when it was set up.
- **Preferred DNS server/Alternate DNS server:** Enter the IP address of the DNS server(s) for your network.

11. When you're done, click **OK**.
12. Click the **Wireless Networks** tab.

(If you don't see this tab, you may need to enable your wireless card or adapter by clicking **Configure** to access the device

note

For specific details about your network, please consult your network administrator.

note

If you don't know your gateway or access point address, see page 71.

settings; then follow any instructions on the screen to enable the device.) You see a screen like this:

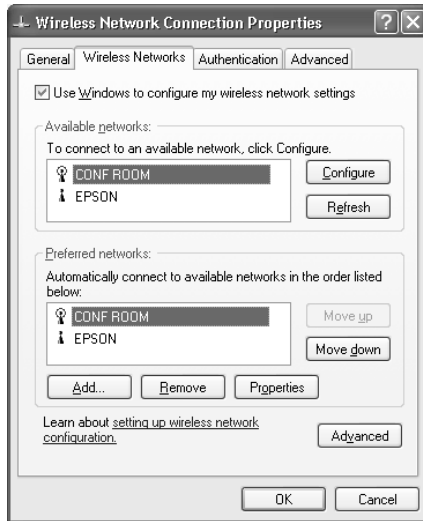

13. Verify that you've enabled your computer's connection to the access point. It should be listed with the small  icon next to it, indicating a connection.

If it's not listed, click **Configure** and type the name of your access point.

14. When you're done making settings, click **OK** to close the dialog box.

Now you're ready to connect to the projector. See the *EasyMP Operation Guide* for details.

Checking the Gateway IP Address on Windows

If you're entering IP addresses manually and need to find out the gateway IP address (the IP address of your access point), make sure the wireless connection to the access point is currently active, as described in the previous section. Then follow these steps:

1. Access your wireless network Properties window. For example, in Windows XP you would click **Start > Control Panel > Network and Internet Connections**. Then click the **Network Connections** icon. You see a screen similar to this:

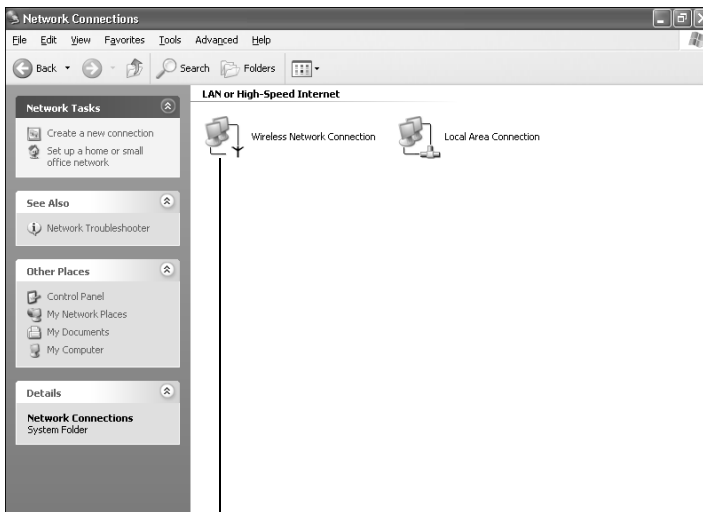

Right-click and select Status

2. Right-click the **Wireless Network Connection** icon and select **Status**.

note

If you cannot identify the gateway address using this Windows utility, use the administrator's utility software that came with your access point.

3. Click the **Support** tab. The gateway's IP address is listed as shown:

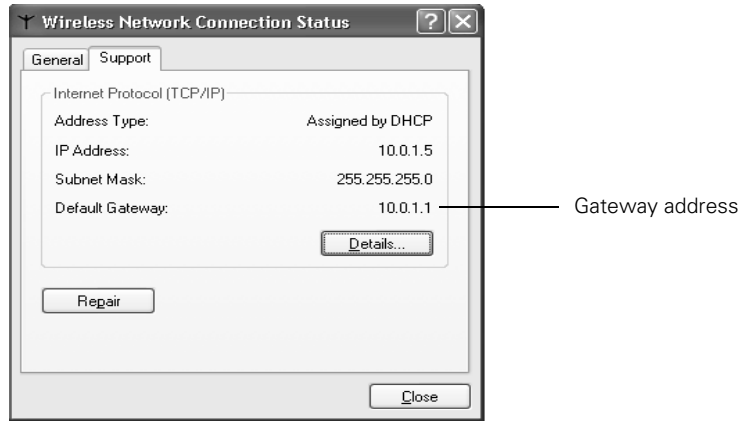

Setting Up Your Mac for Access Point Mode

Your AirPort software is automatically configured to allow your Mac to detect Access Point networks.

Typically, you only need to select your AirPort network name from the AirPort status menu on the Mac menu bar. If you're having problems connecting to the projector, follow these steps:

1. From the Apple pull-down menu, select **System Preferences**.
2. Click the **Network** icon. You see the Network settings window.

3. Make sure Location is set to Automatic.

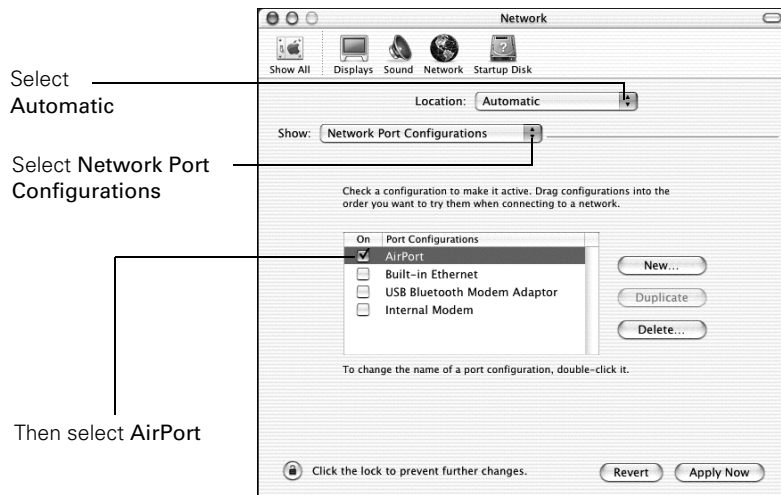

4. Select Network Port Configurations in the Show pull-down menu.

5. Under Port Configurations, select AirPort.

6. Click Apply Now. Then close the window.

7. Start the AirPort Admin utility. Select your base station, then click Configure.

8. On the AirPort tab, make sure your AirPort network name matches your projector's SSID. If not, enter the projector's SSID in the AirPort Network text box and click Update.

9. If you turned DHCP on in your projector's advanced menu, click the Network tab and make sure the Distribute IP addresses checkbox is selected. If you need to select it, click Update.

note

If you don't need the other network ports, disable them by deselecting their checkboxes. If more than one network port is enabled, the projector software warns you to turn off AirPort when you first connect the projector. Disregard this message.

Your AirPort network and base station names may be different. To check or change your AirPort network name, start the AirPort Admin utility, select your base station, and click Configure. Click Show All Settings, then make any changes you want on the AirPort tab.

If you're connecting to your projector in static IP mode, deselect the Distribute IP addresses checkbox. Make sure your projector's gateway address is identical to the base station's IP address, and the first three segments of the projector's IP address are identical to the first three segments of the base station's IP address.

10. Click the AirPort icon on the menu bar at the top of the Macintosh desktop. You see the AirPort status menu:

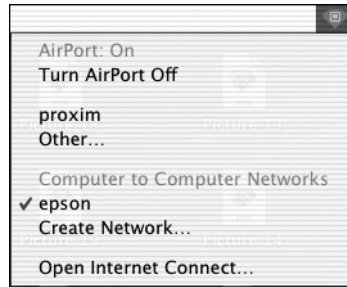

11. Check to make sure AirPort is turned on.
12. Select the name of your AirPort network.

Making a WPS (Wi-Fi Protected Setup) Connection

If you are using a WPS-compatible access point, you can configure the settings for the connection between the projector and the access point from the projector's Configuration menu using one of these methods:

- **Push Button Method**
Press both the **Enter** button on the projector and the button on the access point to make the SSID and security settings. This method is recommended when the projector and access point are close together.
- **PIN Code Method**
With the PIN code method, you enter an 8-digit code from the computer to enable the SSID and security settings. The connection between the computer and the access point must have already been established. (For connection instructions, refer to the manual provided with the access point.) This method lets you make the settings without having to press any buttons on the projector, and is recommended when the projector is mounted on the ceiling.

Follow these steps to open the WPS connection screen:

1. Press the **Menu** button to open the projector menu.
2. Select **Network**, then **Network Configuration**, and press **Enter**.

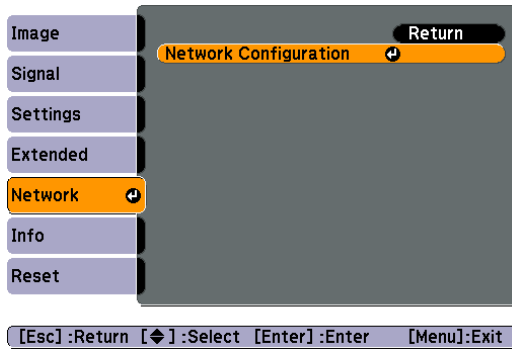

3. Select **Wireless LAN** and press **Enter**.

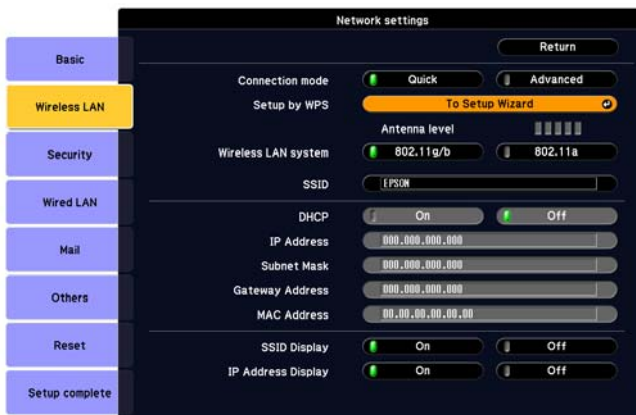

4. Select **To Setup Wizard**, then press **Enter**. You see the WPS (Wi-Fi Protected Setup) connection screen:

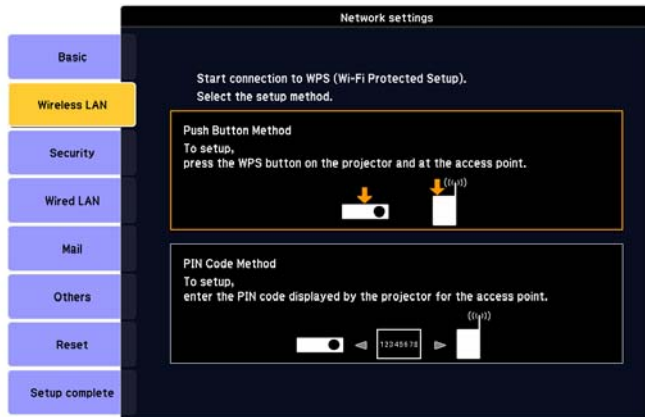

5. For the Push Button Method, follow the instructions below. For the PIN Code Method, follow the instructions on page 78.

Using the Push Button Method

1. Select **Push Button Method** and press **Enter**. You see this screen:



2. Press the **Enter** button on the projector.

- When prompted by the screen, press the WPS button on the access point.

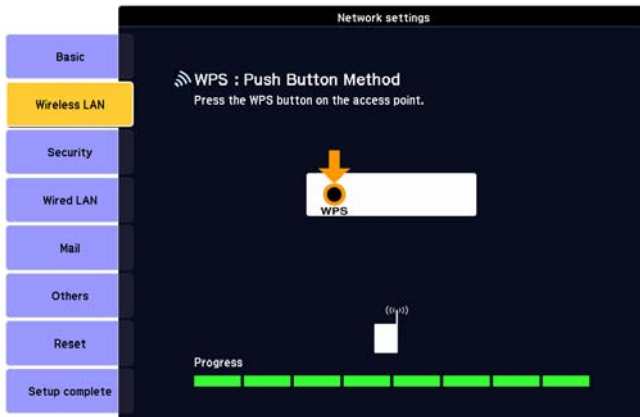

You see a message that WPS setup is complete.

- Press the Enter button or the Esc button to return to the wireless LAN setting page.
- Select Setup Complete and press Enter.

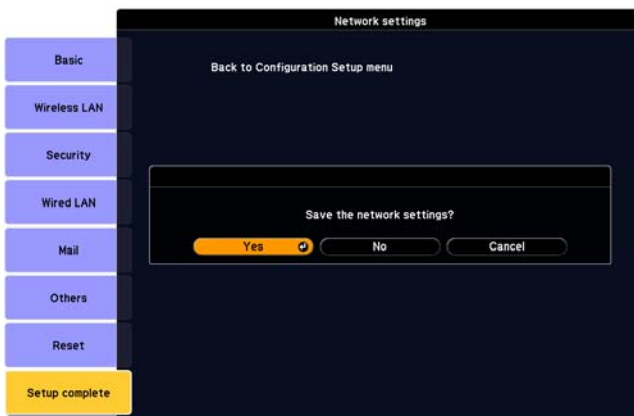

- Make sure Yes is selected and press Enter.
- Press the Menu button.

Using the PIN Code Method

Before you can make a connection using the PIN Code Method, a connection must have already been established between the computer and the access point. For details on how to make this connection, refer to the manual provided with the access point.

1. Follow steps 1 through 4 on page 75 to access the WPS Connection Screen.
2. Select **PIN Code Method** and press **Enter**. You see this screen:

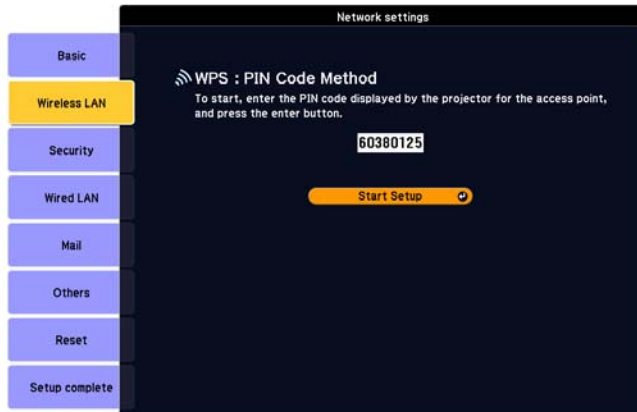

3. From the computer, enter the displayed PIN code for the access point, select **Start Setup** and then press **Enter**.

You see a progress meter on the screen.

- When you see a message that WPS Setup is complete, press the **Enter** or **Esc** button.

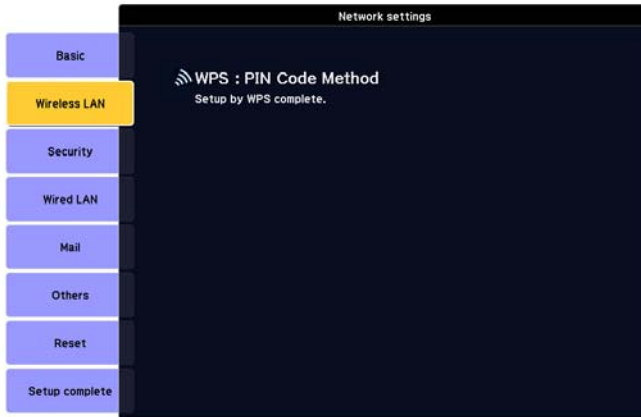

- When you see the wireless LAN setting page, select **Setup Complete** and press **Enter**. You see this screen:

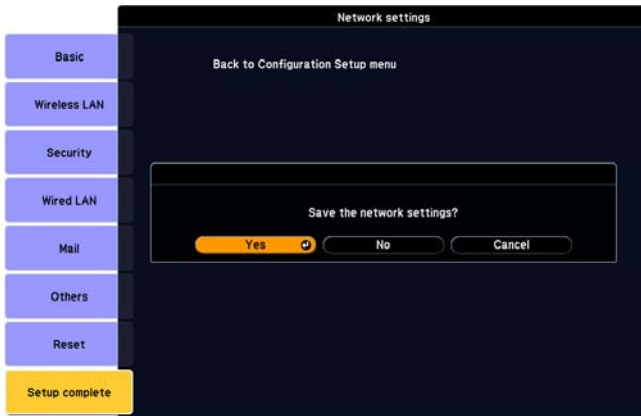

- Select **Yes** and press **Enter** to save the settings.
- Press the **Menu** button and then close the configuration menu to exit.

Using Wireless Security Options

The projector includes the following network security options which you can enable for network projection:

- **Data encryption**
WEP and WPA encryption to encode transmitted data.
- **Connection limitation (Authentication)**
EAP-TLS certificate validation, or LEAP, EAP, or PEAP authentication. A user's name and a password are registered in advance, which means that only the registered wireless port can connect to the network and prevents unauthorized third parties from connecting to the network.

The security functions that can be used with this projector vary depending on the connection mode:

- **Quick Connection Mode**
Encrypted communication
- **Advanced Connection Mode**
Encrypted communication, WEP, WPA-PSK (TKIP), WPA-PSK (AES), EAP-TLS, EAP-TTLS/MD5, EAP-TTLS/MS-CHAPv2, PEAP/MS-CHAPv2, PEAP/GTC, LEAP, EAP-FAST/MS-CHAPv2, EAP-FAST/GTC

note

The authentication and firewall features are only effective when the access point for the connection destination supports the same functions.

Make sure the settings you select match the ones used by your network; follow the directions from your network administrator. If using EAP, you need to make settings at the projector that match the authentication server settings. Check with your network administrator for details on RADIUS settings.

See the following sections to enable security options on your projector:

- “Enabling WEP Encryption” below
- “Enabling WPA Security” on page 83
- “Enabling EAP, LEAP, or PEAP Authentication” on page 85
- “Enabling EAP-TLS Certificate Validation” on page 86

You also need to enable security settings from EMP NS Connection (see page 88).

Enabling WEP Encryption

1. Press **Menu** on the projector remote. Highlight **Network** and then press **Enter**.
2. Choose **Network Configuration** and press **Enter**.
3. Highlight **Security**, then press **Enter**. You see the following screen:

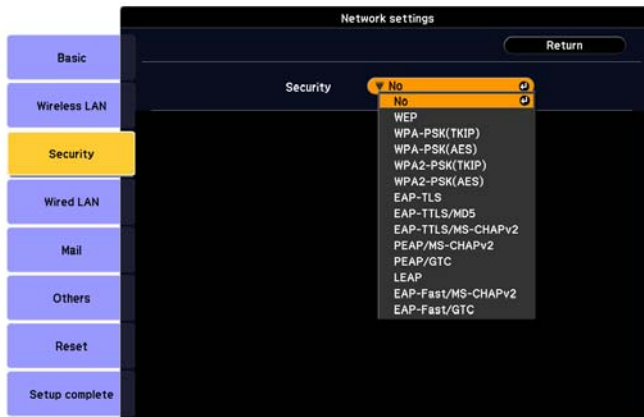

- Press **Enter** to show the menu, then highlight **WEP** and press **Enter**.

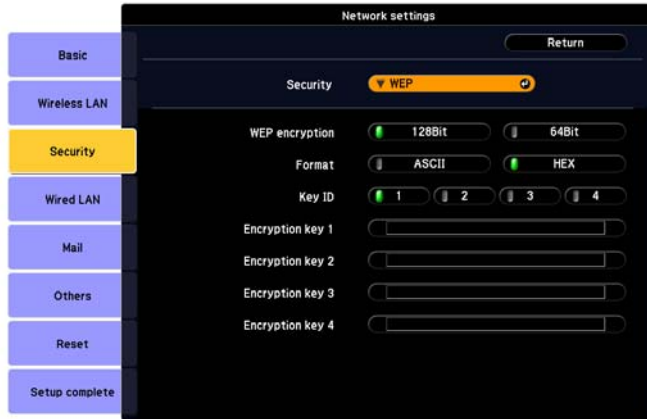

- For the WEP encryption setting, highlight **128Bit** or **64Bit** and press **Enter**.
- For **Format**, highlight **ASCII** to enable text input or **HEX** to enable hexadecimal input, then press **Enter**.
- If you chose **64Bit**, choose **Key ID 1, 2, 3, or 4**.

note

Text input for WEP encryption varies with different access points; check with your network administrator. Try ASCII first. If that doesn't work, try Text2 and then Text3.

Highlight the **Encryption key** text box that corresponds to the **Key ID** you selected, then press **Enter**. Use the  buttons to select individual letters; then press **Enter** to input a character. To add a blank space or to navigate backward and forward through the input text, highlight the arrows and press **Enter**. To toggle symbol settings or capital letters, highlight the option and press **Enter**. When you're done, highlight **Finish** and press **Enter**.



8. Check with your network administrator for directions on entering a key for your network, and follow these general guidelines:
 - For 128 bit WEP encryption with hexadecimal input, enter 26 characters, from 0 to 9 and from A to F.
 - For 64 bit WEP encryption with hexadecimal input, enter 10 characters, from 0 to 9 and from A to F.
 - For 128 bit WEP encryption with ASCII or text input, enter 13 alphanumeric characters.
 - For 64 bit WEP encryption with ASCII or text input, enter 5 alphanumeric characters.
9. When you're done making these settings, highlight the **Return** button at the top of the screen, then press **Enter**. Choose **Setup Complete** and press **Enter**, then choose **Yes** and press **Enter** to save your settings.

Enabling WPA Security

1. Press **Menu**. Highlight **Network** and then press **Enter**.
2. Choose **Network Configuration** and press **Enter**.
3. Highlight **Security**, then press **Enter**. You see the following screen:

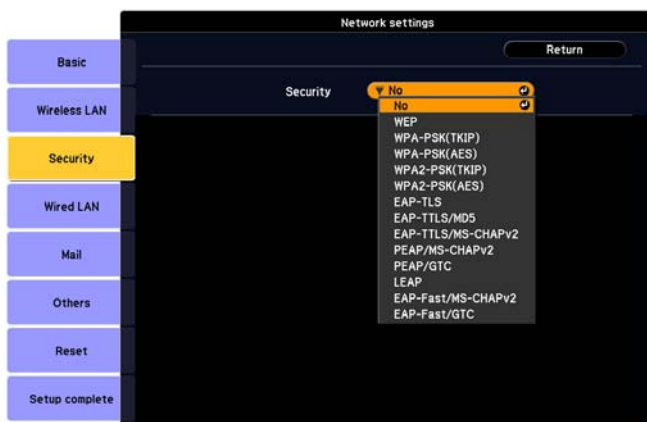

4. Press **Enter** to show the menu, then choose one of the WPA-PSK options and press **Enter**.

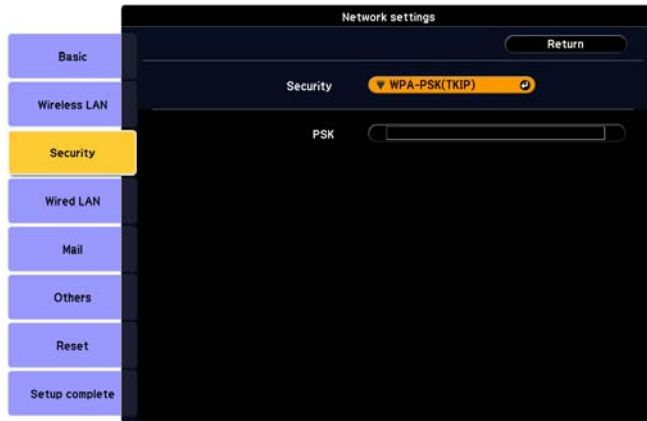

note

If the password is longer than 32 characters, enter it by accessing the projector from a web browser. This lets you enter up to 63 characters. See the EasyMP Operation guide for details.

5. Highlight the **PSK** (pre-shared key) text box and press **Enter**. Use the  buttons to select individual letters; then press **Enter** to input a character. To add a blank space or to navigate backward and forward through the input text, highlight the arrows and press **Enter**. To toggle symbol settings or capital letters, highlight the option and press **Enter**. When you're done, highlight **Finish** and press **Enter**.



6. When you're done making these settings, highlight the **Return** button at the top of the screen, then press **Enter**. Choose **Setup Complete** and press **Enter**, then choose **Yes** and press **Enter** to save your settings.

Enabling EAP, LEAP, or PEAP Authentication

1. Press Menu. Highlight Network and then press Enter.
2. Choose Network Configuration and press Enter.
3. Highlight Security, then press Enter. You see the following screen:

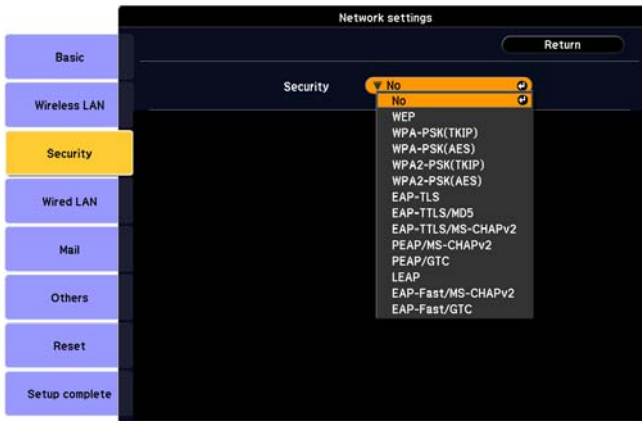

4. Press Enter to show the menu, then choose one of the EAP, LEAP, or PEAP options and press Enter.

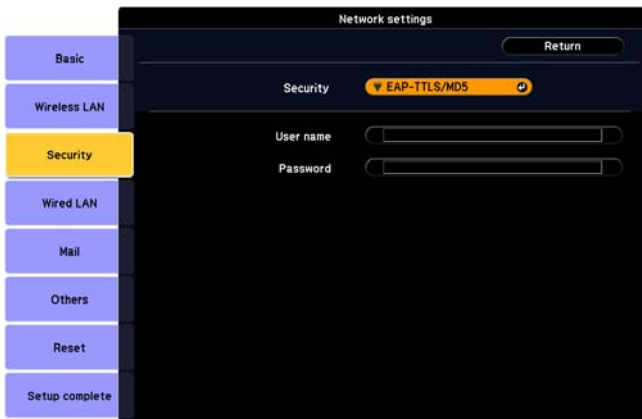

5. Enter the user name and password that match the settings on your authentication server:

Highlight the **User name** text box and press **Enter**. Use the  buttons to select individual letters; then press **Enter** to input a character. To add a blank space or to navigate backward and forward through the input text, highlight the arrows and press **Enter**. To toggle symbol settings or capital letters, highlight the option and press **Enter**. When you're done, highlight **Finish** and press **Enter**.



- Highlight the **Password** text box and press **Enter**. Enter the password as you entered the **User name**.
- 6. When you're done making these settings, highlight the **Return** button at the top of the screen, then press **Enter**. Choose **Setup Complete** and press **Enter**, then choose **Yes** and press **Enter** to save your settings.

Enabling EAP-TLS Certificate Validation

Once you have created an EAP-TLS certificate, follow the steps below to enable it. (Contact your Network Administrator for more information on obtaining or creating the certificate.)

1. Press **Menu**. Highlight **Network** and then press **Enter**.
2. Choose **Network Configuration** and press **Enter**.

3. Highlight **Security**, then press **Enter**. You see the following screen:

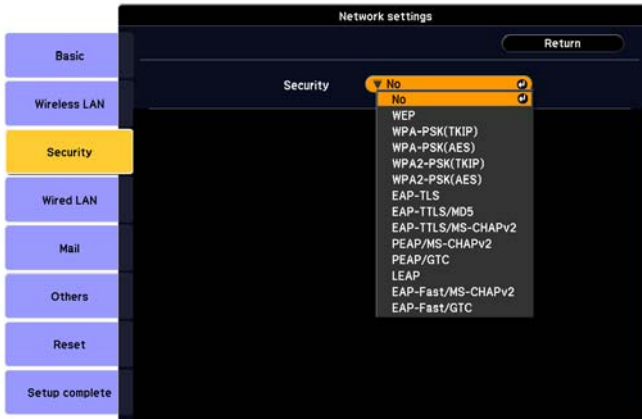

4. Press **Enter** to show the menu, then choose **EAP-TLS** and press **Enter**. The certificate information appears on the screen, for example:

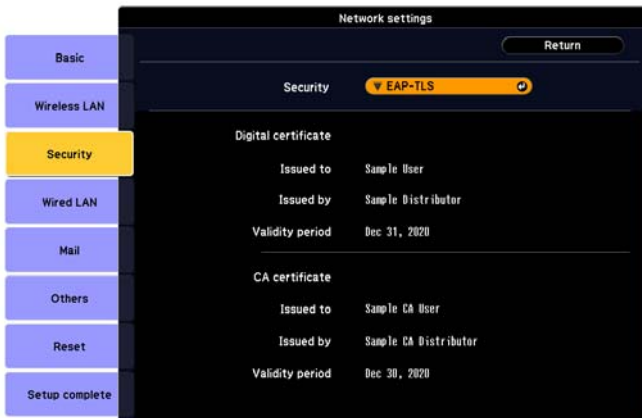

5. When you're done making these settings, highlight the **Return** button at the top of the screen, then press **Enter**. Choose **Setup Complete** and press **Enter**, then choose **Yes** and press **Enter** to save your settings.

Enabling Data Encryption from EMP NS Connection

When using the EMP NS Connection software, follow these steps to enable data encryption.

1. Click **Set options** on the main screen.
2. Click the **General Settings** tab.
3. Select the **Encrypt communications** checkbox.
4. Click **OK**.

For more information, see the *EasyMP Operation Guide*.

Using the EasyMP Software

Once you've set up your projector and computer for network projection, see the *EasyMP Operation Guide* for instructions on the following EasyMP features:

- Starting NS Connection
- Projecting over the network
- Multi-screen projection
- Projecting video clips (Movie Sending mode)
- Using Presentation mode
- Using virtual displays

Removing the Wireless 802.11a/b/g Module

Follow these steps to remove the module from your projector.

1. If you're running NS Connection, click **Disconnect** on the control bar.



2. Check the access light to make sure it isn't flashing.
3. Turn off the projector and unplug it.
4. Turn the projector over. Unscrew the cover plate, then remove it.

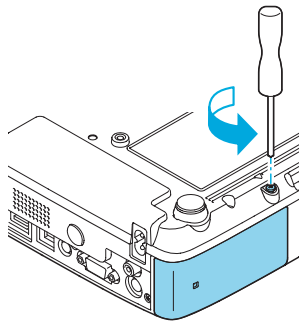

5. Pull the module off the projector.

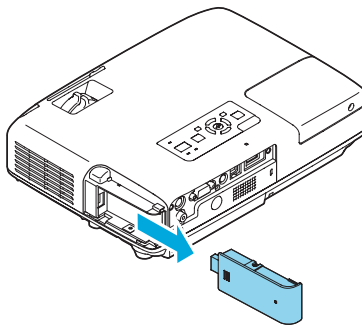

6. Replace the cover plate and secure it with the screw.

caution

Never remove the module while the indicator light is green or when projecting wirelessly. You may damage the module or lose data.

Connecting to a Wired Network

With the optional Ethernet unit, you can connect the projector to your network and configure it with an IP address. This provides an alternative to connecting to the projector wirelessly.

1. Remove the wireless module and cover plate, as described above, then insert the Ethernet unit into the projector and replace the cover plate.
2. Connect the projector to your network using a commercially available 100BaseTX or 10BaseT network cable. Connect the cable to the LAN port on the projector.
3. Point the remote control at the projector and press the **Power** button.
4. Press the **EasyMP** button on the remote control to select EasyMP as the source.
5. Press the **Menu** button on the remote control, select the **Network** menu, then press **Enter**.
6. Choose **Network Configuration** and press **Enter**.
7. Choose **Wired LAN** and press **Enter**. You see the following screen:

note

Only the Epson Ethernet unit is guaranteed to work. Other brands may not be compatible.

If you see a message asking you to insert a LAN or memory card, check to make sure your Ethernet unit is properly inserted.

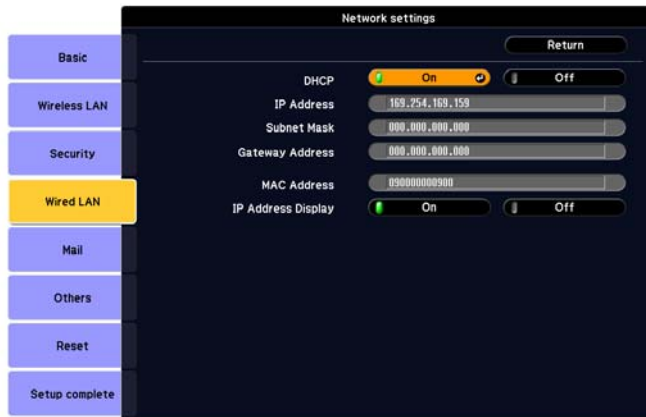

8. Do one of the following:

- If your network assigns addresses automatically, turn on the **DHCP** setting.
- If your network does not assign addresses automatically, turn off **DHCP** and enter the projector's **IP Address**, **Subnet Mask**, and **Gateway Address**, as needed.

To enter numbers, use the  buttons on the remote control to highlight the number you want to input, then press the **Enter** button. When you're finished changing an address in the network menu, highlight **Return**, then press the **Enter** button.

9. To prevent the IP address from appearing on the standby screen, set the **IP Address Display** setting to **Off**.

When you're done making all necessary changes, press **Menu** to exit the menu system.

Using Projector E-mail Alerts

When this feature is enabled, the projector sends you an e-mail alert if it has any problems.

1. Press the **Menu** button on the remote control, select the **Network** menu, then press **Enter**.
2. Choose **Network Configuration** and press **Enter**.

- Choose Mail, then press Enter. You see the following screen:



- Highlight On to receive email notifications, then press Enter.
- Enter the IP address for the SMTP server for the projector.

You can enter a number from 0 to 255 in each field of the address. However, the following IP addresses cannot be used: 127.x.x.x, 224.0.0.0 to 255.255.255.255 (where x is a number from 0 to 255).

- Enter the SMTP server's port number. The default value is 25. You can enter a numeric value from 1 to 65535.
- Choose one of the Destination Address fields, then enter the e-mail address and the contents of the message that you will receive when a problem or warning occurs. You can register up to three addresses. You can enter up to 32 alphanumeric characters for the e-mail address.
- Select problems or warnings to be notified about by mail.

When the selected problem or warning occurs, an e-mail message is sent to the specified notification addresses. The subject line of the e-mail is EPSON Projector. The e-mail includes the following information:

- Line 1: The name of the projector where the problem has occurred

note

If a critical problem develops with a projector which causes it to suddenly stop working, it may not be possible for the projector to send a message.

If Standby Mode is set to Network ON in the Extended menu, the projector can still be monitored even if the projector is in standby mode (when the power is off).

- Line 2: The IP address of the projector where the problem has occurred
- Line 3: Details of the problem

Using SNMP to Monitor the Projector

Network administrators can use SNMP (Simple Network Management Protocol) to monitor projectors.

1. Press the **Menu** button on the remote control, select the **Network** menu, then press **Enter**.
2. Choose **Network Configuration** and press **Enter**.
3. Choose **Others**, then press **Enter**. You see the following screen:



note

If you're a network administrator, you can use the SNMP option to enter a trap IP address. This lets you receive trap alerts for the projectors you're monitoring.

4. Enter up to two IP addresses for notification.

You can enter a number from 0 to 255 in each field of the address. However, the following IP addresses cannot be used: 127.x.x.x, 224.0.0.0 to 255.255.255.255 (where x is a number from 0 to 255).

5. If your network environment uses an AMX controller, select ON to allow the projector to be detected by AMX Device Discovery.

Connecting With Windows Vista

note

Use only the Epson 802.11a/b/g wireless module in the projector. If you see a message asking you to insert a LAN or memory card, check to make sure your 802.11a/b/g module is properly inserted (see the Quick Setup sheet).

If you have Windows Vista, you can use the Network Projector function to connect to the projector without installing the EasyMP software. This provides a quick, easy way to connect wirelessly, though with limited capabilities. Not all the features available with EMP NS Connection are possible when connecting using the Vista network projector function. All performances are enhanced when you use EMP NS Connection.

Follow these steps:

1. Turn on the projector.
2. Press the **EasyMP** button on the remote control. The standby screen appears.

- From the Start menu on your computer, select **All Programs**, **Accessories**, then **Connect to a Network Projector**. You see this screen:

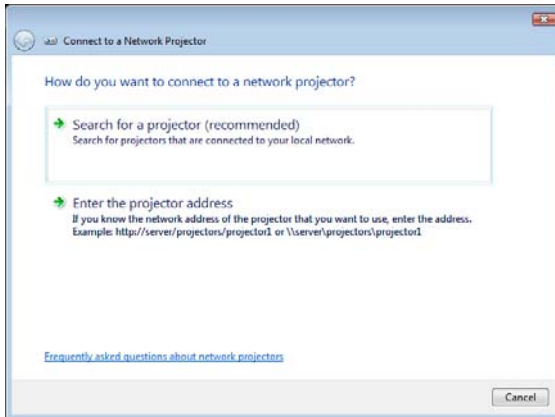

- You can select the projector automatically or manually:
 - To let your computer search automatically for the projector, select **Search for a projector**. You see this screen:

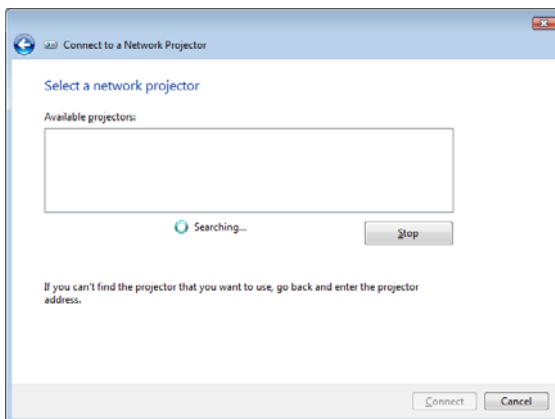

After locating the connected projectors, your computer lists them on the screen. Select the one you want and then click **Connect**.

- To locate the projector by IP address, select **Enter the projector address**. You see this screen:

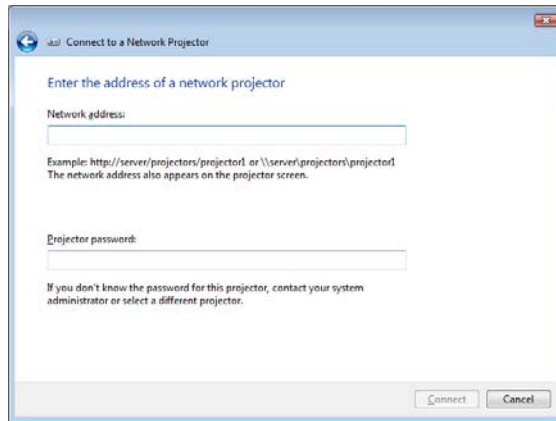

Enter the IP address for the projector in the format shown. Enter a password for the projector if one has been set. Then click **Connect**.

5. If you need to pause your presentation, press the **Pause** button. Click **Resume** when you are ready to continue.
6. When you want to disconnect from the projector, click the **Disconnect** button.

Vista Network Projector Limitations

When you connect wirelessly to the projector using Vista Network Projector, be aware of the following limitations:

- You can connect to only one projector at a time.
- You cannot connect the projector to a PC with a video output resolution in excess of 1024 × 768 (XGA).
- You cannot project a Windows Photo Gallery slideshow in full-screen mode.
- When using the optional network projector feature of the Meeting Space function, set the display color quality on your PC to Highest (32-bit).
- Network presentation via wireless ad-hoc is not supported.

6 *Fine-Tuning the Projector*

You can use the projector's on-screen menus to adjust the image, sound, and other features. This chapter covers the following information:

- Using the menu system
- Adjusting the image
- Adjusting signal settings
- Customizing projector features
- Using the projector security features
- Customizing power and operation
- Multi-screen color adjustment

Using the Menu System

You can use the remote control or the projector's control panel to access the menus and change settings. Follow these steps:

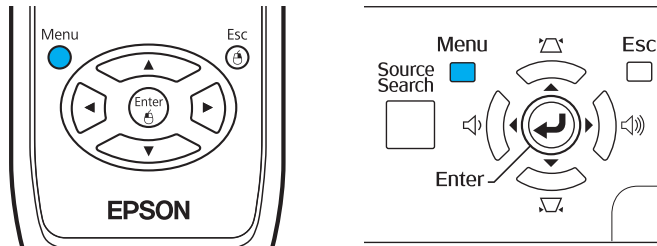

1. To display the menu screen, press the **Menu** button on the remote control or on the projector.



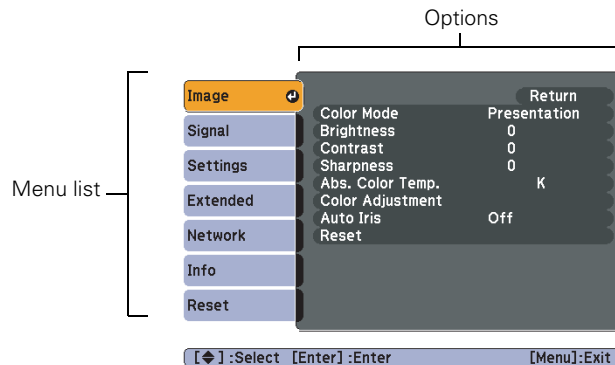

You see a menu screen similar to the one below:



The menus are listed on the left and the options available for the highlighted menu are shown on the right.

2. Use the  pointer button on the remote control (or the navigational buttons on the projector) to scroll through the menu list. When you've highlighted the desired menu, press the **Enter** button to select it.
3. Once you've selected the menu, use the  pointer button to scroll through the list of options. (Some of the options may be grayed out or unavailable, depending on the selected source.)

4. After highlighting the option you want to adjust, use the  pointer button to change the setting. In some cases, you may have to press the **Enter** button to view a sub-screen for changing the setting.

- Press the left or right side of the  pointer button to adjust a slider bar.
- To select from two or more settings, use the  pointer button to highlight the desired setting and press **Enter**.

5. After changing the settings, press the **Esc** button to save your changes and return to the previous menu (or press it repeatedly to exit the menu system).

You can also press the **Menu** button to exit.

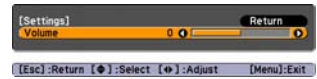

Restoring the Default Settings

You can use the menu system's **Reset** options to restore the factory-default settings for all the settings listed in a specific menu, or all the settings in all menus.

To restore the settings in a specific menu, enter the menu whose settings you want to change, select **Reset**, and confirm as needed. (The example below shows how to reset the Image menu.)

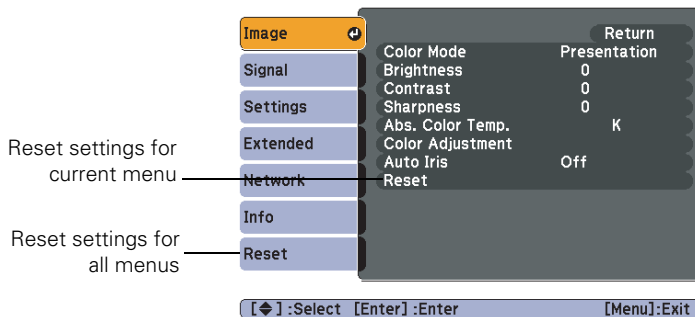

note

*When you select **Reset All** in the **Reset** menu, it does not reset the **Computer Input**, **Video Signal**, **User's Logo**, **Language**, or **Lamp** settings.*

To restore all the projector settings to their factory-default values, select the **Reset** menu, highlight **Reset All**, and press **Enter**.

Adjusting the Image

You can use the Image menu to adjust the brightness, sharpness, color, tint, and contrast.

1. Press the **Menu** button on the projector or remote control and select the **Image** menu. You see the Image menu screen.

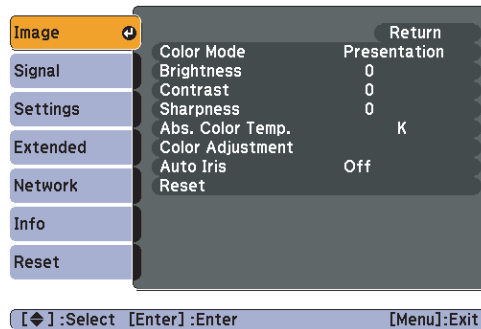

2. Use the  pointer button to highlight the desired option, then adjust it as needed:

- **Color Mode**

Lets you quickly adjust the color and brightness for various uses. You can save a different setting for each source. See page 33 for details on each setting.

You can also change the color mode by pressing the **Color Mode** button on the remote control. To use the **Customized** color mode, see “Six-Axis Color Adjustment” on page 101.

- **Brightness**

Lightens or darkens the overall image.

- **Contrast**

Adjusts the difference between light and dark areas.

- **Color Saturation (video only)**

Adjusts the color depth of the image.

- **Tint (video only)**

Adjusts the balance of green to magenta in the image (available only for component video or NTSC signals).

note

The Brightness setting changes the opacity of the projector's LCD panels. You can also change the lamp's brightness (see page 104).

- **Sharpness**
Adjusts the sharpness of the image.
- **ABS Color Temp.**
Sets a color temperature between 5000 and 10000 °K. (Not available if sRGB is selected as the Color Mode setting.)
- **Color Adjustment**
Adjusts the color values. For **Customized** color mode, select **RGBCMY** to adjust individual red, green, blue, cyan, magenta, and yellow hue and saturation values. For other color modes, **RGB** may be selected to adjust red, green, and blue hue and saturation values. (Not available if sRGB is selected as the Color Mode setting.)
- **Auto Iris**
Automatically adjusts the brightness according to the nature of the image. Improves the depth and detail of dark scenes. (Only available when **Game**, **Theatre**, or **Customized** is selected as the Color Mode setting.)

Six-Axis Color Adjustment

For special projection material, such as high-quality photographs or artwork, you can adjust the hue and saturation for six different color axes.

1. Follow the instructions on page 100 to open the Image menu and select **Color Mode**.
2. Press the **Enter** button to select **Customized**, then press **Esc** to return to the Image menu.
3. Select **Color Adjustment** and press **Enter**. You see hue and saturation controls on the screen for six colors: **RGBCMY** (red, green, blue, cyan, magenta, and yellow).
4. Select the color axis you want to adjust and press **Enter**. You see color controls for hue and saturation.

Hue changes the balance of color, and saturation changes the strength of the color.

- Use the  pointer button to adjust the hue and saturation. You see the adjustments reflected on the screen. When you are satisfied with the color, press **Esc**.
- Repeat steps 4 and 5 for each color axis you want to adjust.

You may need to readjust the color as the lamp in your projector changes over time.

Adjusting Signal Settings

Although the projector normally detects and optimizes the input signal automatically, you can use the Signal menu to make manual adjustments. In addition to changing the position of the projected image, you can correct tracking and sync for computer images, or change the aspect ratio to widescreen format for video images.

- Press the **Menu** button and select the **Signal** menu.

You see a screen similar to one of those below. (The settings will be different depending on the source you are projecting from.)

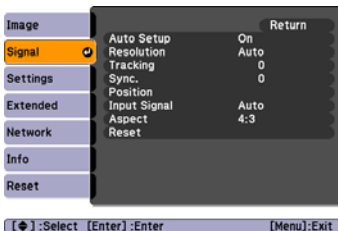

Computer image

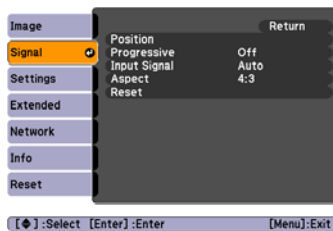

Component video

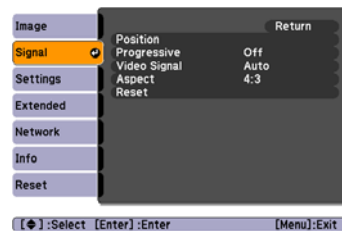

Composite video/S-video

- Use the  pointer button to highlight the desired option, then adjust it as needed:

- **Auto Setup**

Leave this setting on to automatically optimize the image when **Computer** is selected as the source. Turn it off if you want to save adjustments you have made to the video settings.

- **Resolution**

When set to **Auto**, the resolution (size) of a computer image is automatically detected so it can be scaled to fit in the

projection area. If the image doesn't display properly after you adjust the aspect ratio setting (see page 32), select **Wide** to project from a computer with a wide-panel display, or **Normal** for a computer with a 4:3 or 5:4 display.

- **Tracking**

Adjust this value to eliminate vertical stripes in the image.

- **Sync**

Adjust this value if the image appears blurry or flickers.

- **Position**

If the image is slightly cut off on one or more sides, it may not be centered exactly. Select this setting and use the  pointer button to center it.

- **Progressive**

Select **On** for moving images or **Off** for still images. If you notice video delays during high-speed gaming, turn this setting off.

- **Input Signal**

If the colors don't look right on the **Auto** setting, select the setting for the type of equipment you've connected to the **Computer (Component Video)** port:

RGB: For a computer connection.

Component Video: For a video player that outputs a component video signal.

- **Video Signal**

Leave this setting at **Auto** unless you are using a 60-Hz PAL system (then select **PAL60**).

- **Aspect**

Choose an aspect ratio setting that allows the image to fit best in the display area. See page 32 for details.

tip

Before adjusting tracking or sync, fill the screen with an image containing fine detail, such as black text on a white background.

Customizing Projector Features

You can use the Settings menu to lock the buttons on the projector, adjust audio volume, and customize several other features.

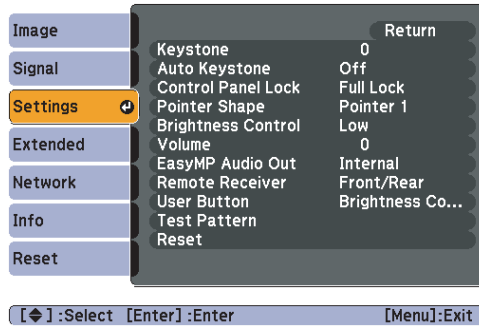

- **Keystone**
Squares up the shape of the image after the projector has been tilted upward. If you notice lines or edges looking jagged after adjusting the shape, decrease the Sharpness setting (see page 100).
- **Auto Keystone**
Automatically compensates for keystone distortion when the projector is tilted upward. This feature is available only when the projector is set for front projection (it is enabled by default).
- **Control Panel Lock**
Lets you disable the buttons on the projector. See page 110 for more information.
- **Pointer Shape**
Lets you choose from three alternative pointer shapes. See page 36 for more information.
- **Brightness Control**
Lets you select from two levels of brightness. The **Low** setting reduces power consumption and noise, and extends the lamp's operating life.
- **Volume**
Raises or lowers the volume of the projector's speaker.

note

You can also adjust the volume using the remote control.

■ EasyMP Audio Out

Lets you select whether to use the **Audio** port for input or output. Select **External** to output sound from EasyMP scenarios (.wav files) or MPEG files to external speakers with a built-in amplifier (connected as shown on page 51). Select **Internal** to use the projector's internal speaker with your computer or video equipment (connected as shown on page 50).

■ Remote Receiver

Deactivates the projector's front and/or back sensors that detect signals from the remote control. Use this setting to prevent use of the remote control or to stop interference from bright fluorescent lights. Restart the projector for this setting to take effect.

■ User Button

Lets you create a shortcut to one of the following menu items: **Brightness Control**, **Info**, **Progressive**, **Closed Caption**, **Test Pattern**, **Multi-screen**, or **Resolution**. When you press the **User** button on the remote control, the assigned menu item is displayed.

■ Test Pattern

Displays a test pattern for use when adjusting the zoom and focus, and when performing keystone correction.

Using the Projector Security Features

To prevent unauthorized use of the projector, you can do the following:

- Assign a password; this can be disabled for a set period if you want to loan the projector to someone.
- Create an identifying user logo that is displayed at startup and/or when the **A/V Mute** button is pressed. See page 108.
- Disable the projector's buttons; this is useful, for example, if you're projecting in a classroom and you want to ensure that no one touches the projector's buttons while you're using the remote control. See page 110.
- Lock the network configuration settings. See page 107.

If you create a user's logo for the projector, you can set up the logo so it is displayed as the startup screen and/or A/V Mute screen. Unauthorized users cannot turn it off or change it. This feature is intended to discourage theft and provides a way to identify the projector should it be stolen.

Enabling Password Protection

To prevent unauthorized use, you can assign the projector a password. If you do, a screen will appear requesting the password whenever the projector is plugged in and turned on. If an incorrect password is entered three times in succession, the projector's operation is locked and the power cord must be disconnected and reinserted to redisplay the password screen. If an incorrect password is entered thirty times in succession, the user must contact Epson to unlock the projector.

The default setting for the Password Protect function is **Off**. Follow these steps to turn password protection on:

1. Press the **Freeze** button on the remote control for about five seconds.

You see this screen:

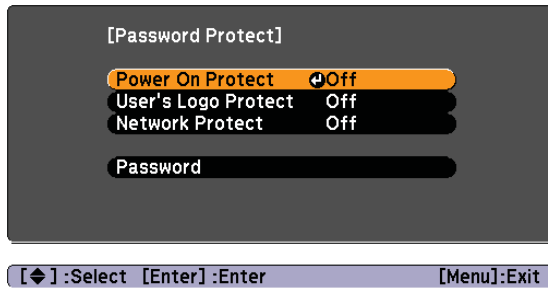

2. Use the  pointer button to set **Power On Protect** to **On**. Then press **Enter**.
3. Press **Esc**.
4. Select **Password** and press **Enter**.
5. When you see a message asking if you want to change the password, select **Yes** and press **Enter**.

note

It's a good idea to write down your password.

If you leave the projector plugged in, the Password Protect Release screen will not appear. You only need a password if you unplug and reconnect the power cable.

caution

If you lose the remote control, you will not be able to enter the password. Keep the remote control in a safe place at all times.

6. Hold down the **Num** button on the remote control and use the numeric keypad to enter a four digit password. (The default setting is 0000.)
7. When you see a confirmation message, reenter the password. Then press the **Menu** button to exit the screen.
8. To enable your screen logo, select **User's Logo Protect** and press **Enter**. Select **On** and press **Enter**.

When this feature is on, the logo appears whenever you turn on the projector (if the **Startup Screen** is enabled in the Extended menu; see page 108). It also appears when you press the **A/V Mute** button (if you selected the **Logo** for the **A/V Mute** setting under **Display** in the Extended menu). None of the **User's Logo** features in the Extended menu can be changed when the **User's Logo Protect** function is enabled.

9. To enable network setting protection, select **Network Protect** and press **Enter**. Select **On** and press **Enter**.

When this feature is on, none of the network settings on the **Configuration** menu can be changed.

Starting the Projector with a Password

When the password function is enabled, you see this screen when you plug in and turn on the projector:



Hold down the **Num** button on the remote control and use the numeric keypad to enter the four digit password.

The password screen closes, the numeric keypad is automatically deactivated, and projection begins.

If the password is not correct, you see a message prompting you to re-enter the password. If you enter an incorrect password three times in succession, you see the message **The projector's operation will be locked. Request code xxxxx** and the projector switches to standby mode for approximately 5 minutes. Write down the request code. Then disconnect the projector's power cord from the electrical outlet, reconnect it, and turn the projector back on.

When you see the Password Protect Release screen again, you can try to enter the correct password.

If you enter an incorrect password 30 times in succession, the projector remains locked and you must contact Epson to unlock it.

If you have forgotten the password, contact Epson with the request code number that appears in the Password Protect Release screen for assistance. See "Where To Get Help" on page 138.

Creating Your Own Startup Screen

You can transfer any image from your computer or video source to the projector and then use it as your startup screen. You can also use it as the screen displayed when the projector is not receiving a signal or when you press the **A/V Mute** button. The image can be a company logo, slogan, photograph, or any other image you want to use.

Capturing the Image

Start by displaying the image you want to use from either a computer or video source, such as a DVD player or digital camera. Then follow these steps to capture the image and transfer it to the projector:

1. Press the **Menu** button on the remote control, highlight the **Extended menu**, and press **Enter**.

note

Once you capture an image, it automatically replaces the Epson startup screen. Although you can change the startup screen, you cannot restore the original one.

2. Highlight User's Logo and press Enter.

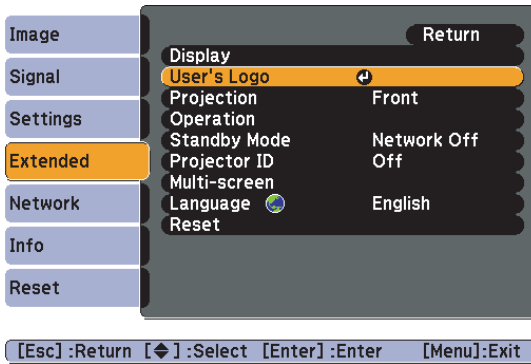

3. When you see a message asking **Choose this image as the user's logo?**, select **Yes** and press **Enter**. A selection box displays over the image.
4. Use the  pointer button to select the area of the image you want to use. Then press **Enter**.
5. When you see the message **Select this Image?**, highlight **Yes** and press **Enter**.
6. Use the arrow buttons to select a zoom factor (display size) and press **Enter**.
7. When the message **Save this image as the user's logo?** appears, select **Yes** and press **Enter**. Saving the logo may take a few moments. Do not use your projector, remote control, or video source while the logo is being saved.
8. When you see the message **Completed**, press **Esc** to return to the menu screen.

note

You can also use this menu to turn off the startup screen, disable message display, or change the background color.

Choosing When to Display the Image

After your image is saved, it is automatically set as the startup screen. You can also set it to display as the screen you see when there's no signal or when you press the **A/V Mute** button (see page 30).

1. Press the **Menu** button, highlight the **Extended** menu, and press **Enter**.
2. Select **Display** and press **Enter**.
3. Highlight **Display Background** (for when there is no signal) or **A/V Mute**, and press **Enter**.
4. Select **Logo** and press **Enter**.
5. When you're finished, press **Esc** to exit.

Disabling the Projector's Buttons

You can lock all the projector's control panel buttons, or all buttons except the **Power** button. The projector can still be operated using the remote control.

1. Press the **Menu** button, highlight the **Settings** menu, and press **Enter**.
2. Select **Control Panel Lock** and press the **Enter** button.
3. Select **Full Lock** (to lock all projector buttons) or **Partial Lock** (to lock all buttons except the **Power** button) and press **Enter**.
4. Select **Yes** and press **Enter** to confirm the setting.
5. Press the **Menu** button to exit.

note

*To unlock the projector, press the **Enter** button on the projector's control panel for 7 seconds.*

Customizing Power and Operation

You can use the Extended menu to customize the way the projector displays images, enable quick startup, turn sleep mode on or off, and customize other projector operations.

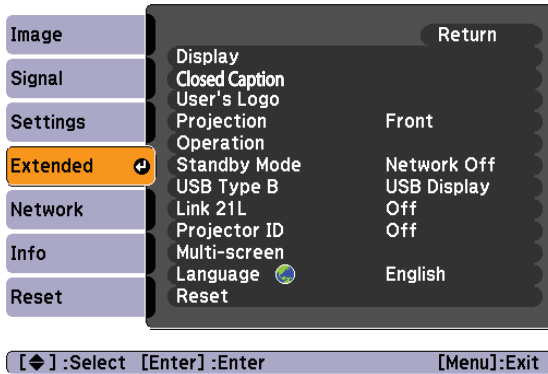

- **Display**
Use this setting to turn off the display of messages, change the background color, enable logo display, or turn off the startup screen display.
- **Closed Caption**
Lets you display closed captioning for content that provides it.
- **User's Logo**
Create a custom startup screen, as described on page 108.
- **Projection**
Select **Front** (to project from the front of a screen and right side up), **Front/Ceiling** (when the projector is mounted upside-down from the ceiling), **Rear** (to project from behind onto a transparent screen), or **Rear/Ceiling** (to project from behind onto a transparent screen when the projector is mounted upside-down from the ceiling).

When you select one of the Ceiling projection methods, the projector requires a short cool-down period after you turn it off. Wait until you hear the projector beep before unplugging it.

note

If Direct Power On is enabled, the power cable is connected, and a power outage occurs, the projector will start when the power is restored.

Do not use the projector at altitudes above 7500 ft (2,286 m).

■ Operation

Use this menu to enable the following functions:

Direct Power On to have the projector start when the power cable is connected (without pressing the  Power button).

Sleep Mode to have the projector turn off automatically if it is idle (and no signal is received) for the amount of time you select as the **Sleep Mode Timer** (1 to 30 minutes).

Lens Cover Timer to have the projector turn off automatically after 30 minutes when the A/V Mute slide is closed.

High Altitude Mode to increase cooling when you are using the projector above 4900 ft (1500 m).

■ Standby Mode

Select **Network On** to enable the projector to be monitored over a network when it is in standby mode (the power light is orange).

■ USB Type B

Select **USB Display** to project your computer's display through the projector's USB Type B port (see page 41). Choose **Link 21L** to use the remote control as a wireless mouse when your computer is connected to the **Computer (Component Video)** port; see page 42.

■ Link 21L

Enables the projector to work with Link 21L software (not supported in all regions).

■ Projector ID

Lets you selectively operate two or more projectors in the same room using one remote control. See page 37 for more information.

■ Multi-screen

Lets you match the color and brightness levels of two or more projectors used in the same room. See below for more information.

■ Language

Select from nine languages to be used for the projector menus.

Multi-screen Color Adjustment

If you are using multiple projectors in the same room (for example, with the EasyMP multi-screen display function or a distribution amplifier), you can match the color and brightness between them.

To match the display colors as closely as possible, first make sure that all the projectors are set to the same Color Mode (see page 100) and Brightness Control setting (see page 104). Then follow these steps:

1. Assign a different ID to each projector so that you can use the remote control to adjust each projector individually. See page 37 for instructions.
2. Select **Multi-screen** in the projector's Extended menu.
3. Start by selecting the same **Adjustment Level** for two projectors. Each adjustment level, 1 through 5, displays a screen that lets you adjust the color and brightness at a different level of projector output (luminance).
4. Adjust the **Brightness Correct** and **Color Correct** settings for one projector so that its brightness and color tone match that of the other projector.
5. Select the next **Adjustment Level** for both projectors, and adjust the brightness and color in the same way so the projectors match. Repeat until all five levels have been adjusted.
6. If you are using additional projectors, repeat this process to match projector 3 to projector 2, projector 4 to projector 3, and so on.

tip

Press the Enter button to view the actual image. Press Enter again to switch back to the Adjustment Level screen.

note

In some cases, the brightness and color tone may not match completely even after correction.

8

Maintaining the Projector

Your projector needs little maintenance. All you have to do is keep the lens clean. You may also need to clean the air filter and vent. A clogged air filter or vent can block ventilation needed to cool the projector.

warning

Before you clean any part of the projector, turn it off and unplug the power cord.

Never open any cover on the projector, except the lamp cover. Dangerous electrical voltages in the projector can injure you severely. Do not try to service this product yourself, except as specifically explained in this User's Guide. Refer all other servicing to qualified service personnel.

The only parts you should replace are the lamp and air filter. If any other part needs replacing, contact your dealer or a qualified servicer.

This chapter covers the following:

- Cleaning the lens
- Cleaning the projector case
- Cleaning the air filter and vent
- Replacing the lamp and air filter
- Transporting the projector

Cleaning the Lens

Clean the lens whenever you notice dirt or dust on the surface.

To remove dirt or smears on the lens, use lens-cleaning tissue. If necessary, moisten a soft cloth with lens cleaner and gently wipe the lens.

Cleaning the Projector Case

Before you clean the case, turn off the projector and unplug the power cord.

- To remove dirt or dust, wipe the case with a soft, dry, lint-free cloth.
- To remove stubborn dirt or stains, moisten a soft cloth with water and a neutral detergent. Then wipe the case.

caution

Do not use wax, alcohol, benzene, paint thinner, or other chemical detergents. These can damage the case.

Never spray a liquid of any kind directly on the projector or its lens. Always apply it to a cloth first.

Cleaning the Air Filter and Vent

Your projector includes an air filter to ensure the best performance. If dust collects on the air filter (on the side of the projector) or vent (on the front of the projector), clean them as described below. Dust clogs prevent proper ventilation and can cause overheating and damage the projector.

Follow these steps:

1. Turn off the projector. Wait for the **Power** light to stop flashing, then unplug the power cord.
2. To clean the intake vent and filter, use a small vacuum cleaner designed for computers and other office equipment. If you don't have one, gently clean the vent with a soft brush (such as an artist's paintbrush).

You can remove the air filter to clean both sides.

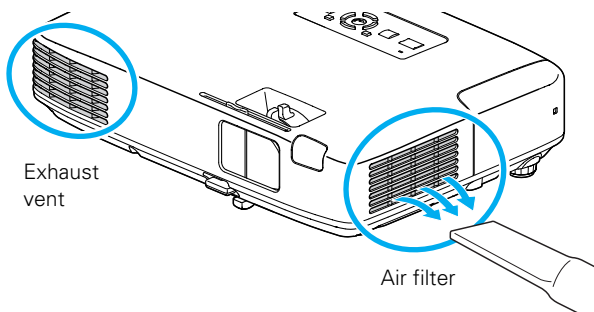

3. If the dirt is difficult to remove or the filter is broken, replace the filter as described on page 120. Contact your dealer or call Epson at 800-GO-EPSON (800-463-7766) to obtain a new filter.

note

To order replacement air filters, request part number V13H134A19. See page 12 for ordering information.

note

When you get a replacement lamp for your projector, you should replace the filter.

To check how long the lamp has been in use, see page 127.

Turn off this product when not in use to prolong the life of the projector.

warning

Let the lamp cool fully before replacing it.



In the unlikely event that the lamp has broken, small glass fragments may be present and should be removed carefully to avoid injury.

If the lamp is used after the replacement period has passed, the possibility that the lamp may break increases. When a lamp replacement message appears, replace the lamp with a new one as soon as possible, even if it is still working.

Replacing the Lamp and Air Filter

The life span of the projection lamp is about 3000 hours if Brightness Control in the Setting menu is set to High (default), and 4000 hours if Brightness Control is set to Low.

It is time to replace the lamp when:

- The projected image gets darker or starts to deteriorate.
- The message **Replace the lamp** appears on the screen when the lamp comes on and the lamp warning light  flashes orange. To maintain projector brightness and image quality, replace the lamp as soon as possible.
- The lamp warning light  flashes red (the lamp is burnt out).

Contact your dealer or call Epson at 800-GO-EPSON (800-463-7766). Request part number V13H010L48.

Follow these steps to replace the lamp and air filter:

1. Turn off the projector.
2. When the  **Power** light stops flashing, unplug the power cord.

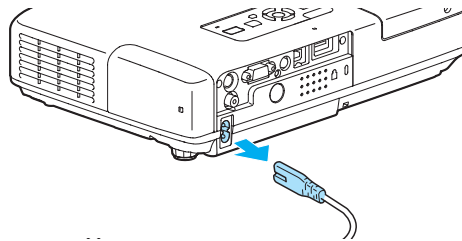

3. Let the projector cool for at least an hour (if it has been on). The lamp is extremely hot immediately after use.

4. Remove the lamp cover screw. Then slide the lamp cover to the side and lift it off of the projector.

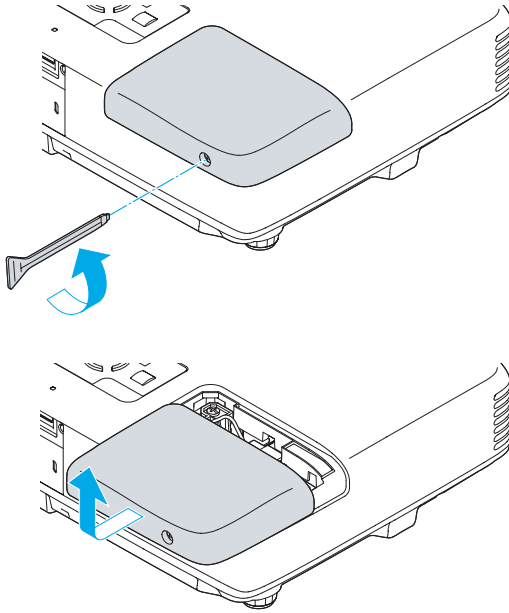

5. Loosen the two screws holding the lamp in place (you can't remove them).

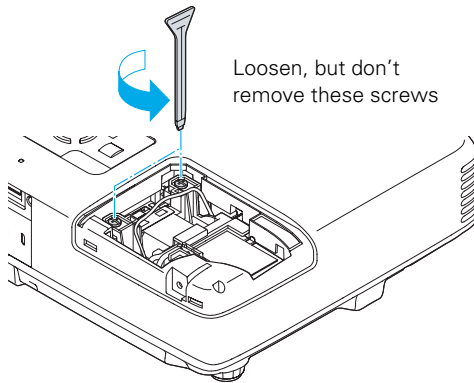

note

 *The lamp(s) in this product contain mercury. Please consult your state and local regulations regarding disposal or recycling. Do not put in the trash.*

6. Hold the lamp as shown and pull it straight out.

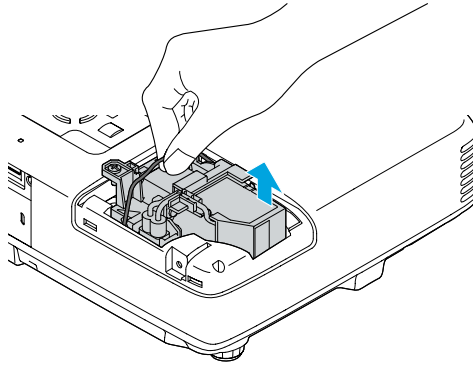

7. Gently insert the new lamp. (If it doesn't fit easily, make sure it is facing the right way.)
8. Push down the side marked **PUSH** until it snaps in.
9. Once the lamp is fully inserted, tighten its screws.
10. Replace the lamp cover, then tighten its screw.
11. Slide out the air filter on the bottom of the projector and remove it.

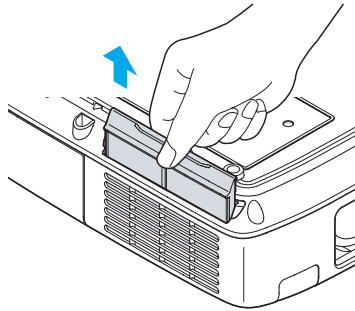

12. Slide in the new air filter until it clicks in place.
13. Reset the lamp timer as described in the next section.

Resetting the Lamp Timer

After you replace the lamp, you need to reset the lamp timer using the projector's menus.

1. Press the **Menu** button on the remote control or on the projector's control panel. You see the main menu.
2. Use the  buttons on the remote control (or the arrow buttons on the projector) to highlight **Reset**, then press **Enter**.

You see this screen:

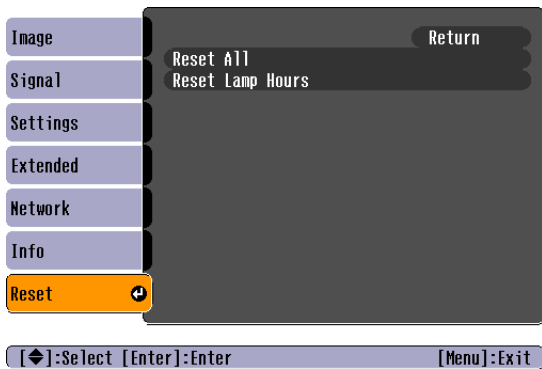

3. Select **Reset Lamp Hours** and press **Enter**.
4. When you see the prompt, select **Yes** and press **Enter**.
5. When you're finished, press **Esc** or **Menu** to exit the Menu system.

Transporting the Projector

The projector contains many glass and precision parts. Follow these guidelines to prevent damage:

- Close the A/V Mute slide (lens cover) to protect the lens.
- When shipping the projector for repairs, use the original packaging material if possible. If you do not have the original packaging, use equivalent materials, placing plenty of cushioning around the projector.
- When transporting the projector a long distance, first place it in a hard-shell shipping case, then pack it in a firm box with cushioning around the case. (An optional case is available from Epson; see page 12.)

note

Epson shall not be liable for any damages incurred during transportation.

9 *Solving Problems*

This chapter helps you solve problems with your projector, and tells you how to contact technical support for problems you can't solve yourself. The following information is included:

- Using the projector's on-screen help system
- What to do when the projector's status lights flash
- Solving projector operation problems
- Solving problems with the image or sound
- Solving network problems
- Solving problems with the remote control
- Contacting technical support

Using On-Screen Help

If the image doesn't look right or your audio isn't working, you can get help by pressing the ? Help button on top of the projector or on the remote control.

1. Press the ? Help button on the remote control or on the projector.

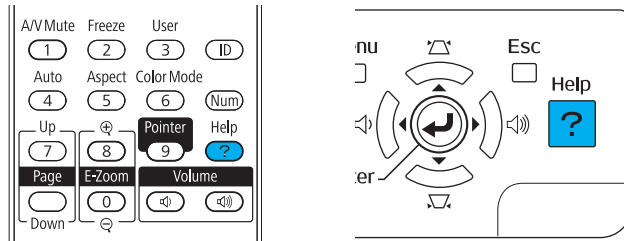

You see the Help Menu.

2. Use the  pointer button on the remote control or the navigational buttons on the projector to highlight menu items.
3. Press the Enter button on the remote control or on the projector to select the menu item.
4. To exit the help system, press the ? Help button.

If none of the suggestions solve your problem, see additional solutions to problems in the following sections.

Checking Projector Status

If your projector isn't working correctly, first turn it off, wait for it to cool (the  Power light stops flashing orange), and unplug it. Then plug the power cord back in and turn on the projector. If this doesn't solve the problem, check the lights on top of the projector.





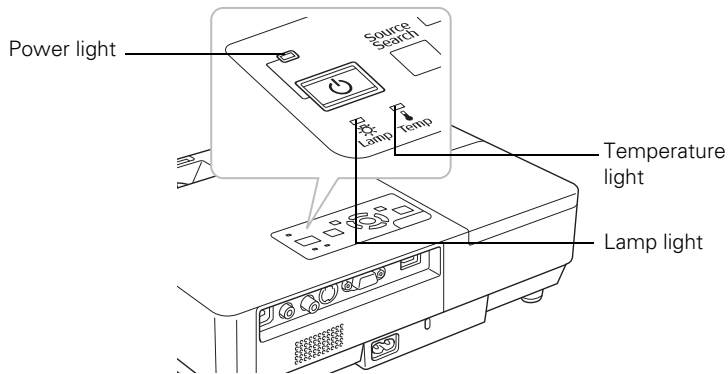

What To Do When the Lights Flash

The lights on top of the projector indicate the projector's status.









Refer to the following table for a complete description of the projector's status lights:

Status lights

Light	Status	Description
	Orange	The projector is in sleep or standby mode. You can unplug it or press the  Power button to turn it on.
	Flashing green	The projector is warming up. Wait for the image to appear.
	Green	The projector is operating normally.
	Flashing orange	The projector is cooling down. You can't turn it back on (and you should not unplug it) until the light stops flashing and remains orange.
	Red	There is a problem with the projector. Check the other two lights and the information on page 125 to diagnose the problem.
	Flashing red	There is a problem with the fan or temperature sensor. The air filter or vent may be clogged. Clean them or replace the air filter as described on page 117. If this does not resolve the problem, stop using the projector, disconnect the power cable, and contact Epson as described on page 138.

Status lights (continued)

Light	Status	Description
	Flashing orange	Rapid cooling is in progress. Although this is not an abnormal condition, projection will stop automatically if the temperature rises higher. Make sure there is plenty of space around the projector for ventilation, and that the air filter and vents are clear. If you're using the projector above 4900 feet (1500 m), turn on High Altitude Mode ; see page 112.
	Red	<p>The projector is overheating, which turns the lamp off automatically. Wait until the cooling fan stops, then unplug the power cord. Plug the power cord back in and press the  Power button. Make sure the room temperature is not above 95 °F (35 °C), and there is plenty of space around the projector for ventilation. If you're using the projector above 4900 feet (1500 m), turn on High Altitude Mode; see page 112.</p> <p>The air filter or vent may be clogged. Clean them or replace the air filter as described on page 117.</p> <p>If the projector continues to overheat after you clean the air filter, the problem may be caused by damage to the cooling fan or temperature sensor. Contact Epson for help as described on page 138.</p> <p>Warning: Except as specifically explained in this <i>User's Guide</i>, do not attempt to service this product yourself.</p>
	Flashing orange	It's time to replace the lamp. See page 118 for instructions. If you continue to use the lamp after the replacement warning, there is an increased possibility that the lamp may break.
	Flashing red	<p>The lamp may be burnt out. First make sure the lamp cover is securely installed. If that's not the problem, let the lamp cool, remove the lamp, and replace it as described on page 118.</p> <p>The air filter or vent may be clogged. Clean them or replace the air filter as described on page 117.</p> <p>If this does not resolve the problem, contact Epson as described on page 138.</p>
	Flashing red	Power is cut off because of an internal problem. Unplug the power cord and contact Epson for help, as described on page 138.
	Flashing red	The auto iris is malfunctioning. Unplug the power cord and contact Epson for help, as described on page 138.

Viewing Lamp Usage and Other Information

Use the Info menu to view information about the display settings of your computer and the number of hours the lamp has been used.

Press the **Menu** button and highlight the **Info** menu.

You see the lamp usage hours and various input signal settings on the right.

The life span of the lamp is about 3000 hours if the **Brightness Control** setting in the Setting menu is set to **High** (default), and 4000 hours if the **Brightness Control** setting is set to **Low**. Make sure you have a spare lamp handy if the usage hours on this menu are close to the life span of your lamp.

note

The information displayed depends on the input signal currently selected.

Solving Projector Operation Problems

The power doesn't turn on.

- If the projector doesn't turn on when you press the **Power** button, make sure the power cable is connected to the projector and plugged into a working electrical outlet.
- The power cable may be defective. Disconnect the cable from the outlet and contact Epson as described on page 138.
- Check to see if the A/V Mute slide is closed.
- Check the status lights (see page 125).

The buttons on the projector don't work.





If the control panels buttons have been locked, try using the remote control instead. See page 110 for information about locking the control panel.

You hear the projector's fan after the power has been turned off.

If Standby Mode is set to Network On, the fans continue to operate after the projector has cooled down. See page 112 for more information about this setting.

Solving Problems with the Image or Sound

No image appears on the screen.

- Check that the  Power light is green, not flashing.
- The projector may be in standby or sleep mode. If the  Power light is orange, press the  Power button to turn the projector on.
- If the power was switched off and then on again, the projector may be cooling down. Wait until the  Power light stops flashing and remains orange; then press the  Power button again.
- Press the A/V Mute button on the remote control to make sure the picture has not been turned off temporarily.
- Open the A/V Mute slide, if it is closed.
- The attached computer may be in sleep mode or displaying a black screen saver. Try pressing a key on the computer.
- If you are projecting from a DVD player or other video source, make sure you turn it on and press its Play button.
- If you're projecting through your computer's USB port, make sure the USB Type B setting in the Extended menu is set to USB Display (see page 112). The USB display feature is not available for Windows 98, Windows Me, or Macintosh.

You've connected a computer and see a blue screen with the message No Signal displayed.

- Make sure the cables are connected correctly, as described on page 40.
- If you've connected a computer and one or more video sources, you may need to press the **Source Search** button on the projector or one of the source buttons on the remote control to select the correct source. Allow a few seconds for the projector to sync up after pressing the button.

If you're using a PC notebook:

- Hold down the Fn key on the keyboard and press the function key that lets you display on an external monitor. It may have an icon such as , or it may be labelled CRT/LCD. Allow a few seconds for the projector to sync up after pressing it. Check your notebook's manual or online help for details.

On most systems, the  key lets you toggle between the LCD screen and the projector, or display on both at the same time.

- Depending on your computer's video card, you might need to use the Display utility in the Control Panel to make sure that both the LCD screen and external monitor port are enabled. See your computer's documentation or online help for details.

If you're using Mac OS X:

1. Open System Preferences.
2. Click Display or Displays.
3. Click Detect Displays.
4. Make sure the VGA Display or Color LCD dialog box is selected.
5. Click the Arrangement or Arrange tab.
6. Make sure the Mirror Displays checkbox is selected.



The message Not Supported is displayed.

- Make sure the correct **Input Signal** is selected in the Signal menu (see page 103).
- Make sure your computer's resolution doesn't exceed UXGA (1600 × 1200) and the frequency or refresh rate is supported by the projector (see page 146). If necessary, change your computer's resolution setting.

Only part of the image is displayed.

- Press the **Aspect** button on the remote control to select a different setting (see page 32).
- If projecting from a computer, press the **Auto** button on the remote control. Also make sure the image **Position** setting is correct in the Signal menu (see page 103).
- Check the projector's **Resolution** setting (see page 102). Select **Normal** or **Wide**, depending on the size of your computer's display panel.
- Make sure your computer is not set to display an extended desktop.
- Press the **Esc** button on the remote control to cancel the E-Zoom function.
- Make sure your computer's resolution setting is correct. Ideally, it should be 1280 × 800 to match the projector's native resolution for the PowerLite 1735W, or 1024 × 768 for the PowerLite 1725. If this option isn't available, select one of the other compatible video formats listed on page 146.
- You also may need to modify existing presentation files if you created them for a different resolution. See your software documentation for specific information.

The image isn't square, but keystone-shaped.

- If the top or bottom of the image is broader, press the  or  button on the projector until the image is square.
- If the projector is angled toward the screen from the left or right, the image will be broader on one side. Center the projector in front of the middle of the screen, facing the screen squarely.
- Enable the Auto Keystone feature to automatically fix the shape. See page 104.

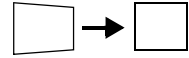
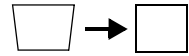

The image contains static or noise.

- If you're using a computer cable longer than 6 feet, or an extension cable, the image quality may be reduced. Use a distribution amplifier for longer distances; you can purchase one from Epson (see page 12).
- Keep your computer and video cables away from the power cord as much as possible to prevent interference.
- The video signal may be split between the computer and the projector. If you notice a decline in the projected image quality when the image is displayed simultaneously on your notebook computer and the projector, turn off the notebook's LCD display.
- Make sure the correct input signal is selected in the Signal menu (see page 103).
- If still images are jittery, turn on the **Progressive** setting in the Signal menu (see page 103).

The image is blurry.

- There may be dirt or smears on the lens. Clean the lens as described on page 116.
- Adjust the focus using the focus ring (see page 23).
- Make sure the lens is not fogged by condensation. You may need to wait before using the projector after moving it from a cold environment to a warm environment.
- Make sure the projector is facing the screen squarely.

- Adjust the **Sharpness** setting on the Image menu (see page 101). When you change video settings, you should be able to see the effect on the screen immediately. If you're projecting from a computer, you may also need to adjust the tracking and sync as described in the next section. If you don't like the new settings, you can always select **Reset** to return to the factory default settings.

You see vertical bands or the image still looks blurry after trying the solutions in the previous section.

- If you're projecting from a computer and displaying an image that contains a lot of fine detail, you may notice vertical bands or some of the characters may look heavy or blurred. Press the **Auto** button on the remote control to reset the projector's tracking and sync settings.
- If further adjustment is needed, you can fine-tune the **Tracking** and **Sync** settings manually using the Signal menu, as described on page 103.
 1. Fill the screen with an image containing fine detail, such as black text on a white background.
 2. Adjust the **Tracking** to eliminate vertical bands.

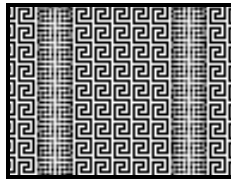

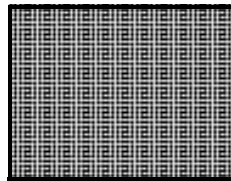

3. Adjust the **Sync** setting to increase the image sharpness.



The image is too light or dark, or colors are incorrect.

- Press the **Color Mode** button to select a different color mode (see page 33).
- Try adjusting the brightness and color settings in the Image menu (see page 100).
- Try changing the **Brightness Control** in the Settings menu (see page 104).
- For fine-art presentations, use the six-axis color adjustment as described on page 101 for precise control of the hue and saturation.
- Check your computer display settings to correct the color balance.
- The projector's lamp may need to be replaced. See page 118 for instructions.

There is no sound, or the sound is not loud enough.

- Press the  button on the projector or remote control to increase the volume.
- Make sure **A/V Mute** is not enabled. (The **A/V Mute** button on the remote control may have been pressed.)
- Make sure the A/V Mute slide is open.
- Try adjusting the **Volume** setting in the Setting menu (see page 104).
- If you're using a DVD player or VCR or other video source, make sure the volume is not turned all the way down or muted. Also, make sure the cables are connected correctly, as described on page 50.
- Make sure the audio cable is connected securely at both ends. For computer audio, connect the cable to your computer's  headphone jack or  audio out jack.
- Make sure the volume control on your computer is not turned all the way down or muted. In Windows, you may be able to use the volume control in your Windows system tray (lower right corner

note

Because of the different technologies used, your projected image may not exactly match the colors on your notebook or computer monitor.

of the screen). On a Mac, you may be able to adjust the volume from your menu bar (top right corner of the screen) or via the volume control function keys.

- If you are using the projector's internal speaker, make sure the EasyMP Audio Out option is set to **Internal**.
- If you are using external speakers, you need to set the EasyMP Audio Out option to **External**. See page 51 or page 105 for more information.

Solving Network Problems

You can't display an image using Quick Wireless Connection.

You may need to restart your computer to connect.

You can't connect to the projector using NS Connection.

- Make sure the wireless module is installed correctly in the projector, as shown on the *Quick Setup* sheet.
- Restart your computer.
- Make sure your projector and computer are configured correctly; see page 58 (Ad Hoc mode) or page 64 (Access Point mode).
- Make sure that you have sufficient wireless signal strength (above 50 percent). On a Mac, check the AirPort icon on the Mac menu bar. In Windows, see the documentation for your computer's wireless card or adapter for details.
- Make sure you aren't projecting one of the EasyMP configuration screens. (You should see a message that the projector is ready to connect.) If you have to exit a configuration screen, restart NS Connection.
- If the projector is configured for Access Point mode and you're using DHCP, allow time for your projector to appear. It takes the server a little while to pick up the IP address.

- If you've changed any settings for your projector or network, or restarted your computer, allow a minute or two for the connection to appear. If you're using AirPort, try turning AirPort off and then on again.
- Make sure that you're trying to connect to the right network. In Windows, verify that you've enabled your computer's connection to the access point (see page 70) or that your wireless card or adapter is enabled and its SSID is set to match the projector's SSID (see page 62). On a Mac, click the AirPort icon at the top of your Mac desktop to make sure AirPort is turned on and the projector's SSID or your AirPort network is selected.
- If you have an access point or AirPort base station and you're not using DHCP, check your projector's IP address on the Access Point mode advanced settings screen. The first three segments of the IP address should be identical to the first three segments of the IP address of your access point or base station. The last segment of the projector's IP address should be close, but not identical, to the last segment of the IP address of the access point or base station.
- If you're not using DHCP, check your projector's Gateway address on the projector's Access Point mode advanced settings screen. It should be identical to the IP address for your access point or AirPort base station.
- If you're using a projector keyword, it changes each time you turn the projector off and then on again. Check the projector's keyword on the EasyMP Network screen and enter it at the prompt.
- If you're using AirPort, check the configuration of your network. Start the AirPort Admin utility, select your base station, click **Configure** and click **Show All Settings**. Click the **Network** tab. If you set up your projector to connect in DHCP mode, turn on **Distribute IP Addresses** and **Share a Single IP Address**.
- If you're using AirPort and DHCP is turned off on your projector's Access Point mode advanced settings screen, make sure **Distribute IP Addresses** is off.

- If you're using Access Point mode and you're connecting to the wrong network, you may be experiencing signal interference from another network. Try resetting your access point or base station, then restart NS Connection.
- If you're using AirPort, the projector's SSID should match the AirPort network name, not the name of the AirPort base station. To check the network name, start the AirPort Admin utility, select your base station, and click **Configure**. Then click **Show All Settings**. The network name appears on the AirPort tab.
- If you're prompted for a password when you connect, enter the WEP encryption key (if you're using WEP encryption).

Solving Problems with the Remote Control

The projector doesn't respond to remote control commands.

- The remote control's batteries may not be installed correctly or may be low on power. To change the batteries, see page 28.
- Make sure you are within about 20 feet (6 meters) of the projector and within range of the projector's front or back sensor (approximately 30° to the left or right and 15° above or below).
- Dim the room lights and turn off any fluorescent lights. Make sure the projector is not in direct sunlight. Strong lighting, especially fluorescent lights, may affect the projector's infrared receivers. Also, turn off any nearby equipment that emits infrared energy, such as a radiant room heater. To avoid interference, you can also turn off the projector's front or back sensor with the **Remote Receiver** setting (see page 105), but this may limit where you can use the remote control.
- Make sure the projector's sensors have not been turned off with the **Remote Receiver** setting (see page 105).
- If the projector ID has been set, you may need to change the projector or remote control ID. See page 37.

- If any buttons are held for longer than 30 seconds, the remote enters sleep mode. Release any button that is held to wake the remote.
- If you're using the remote control as a wireless mouse, make sure the **USB Type B** setting in the Extended menu is set to **Link 21L** (see page 112).

Where To Get Help

Epson provides these technical support services:

Internet Support

Visit Epson's support website at www.epson.com/support and select your product for solutions to common problems. You can download utilities and documentation, get FAQs and troubleshooting advice, or e-mail Epson with your questions.

Visit <http://www.presentersonline.com> to access tips, templates, and training for developing successful presentations.

Speak to a Support Representative

To use the Epson PrivateLine Support service, call (800) 637-7661 and enter the PIN on the included Epson PrivateLine Support card. This is the fastest way of speaking to a live representative, and it's free. This service is available 6 AM to 6 PM, Pacific Time, Monday through Friday, for the duration of your warranty period.

You may also speak with a projector support specialist by dialing one of these numbers:

- U.S.: (562) 276-4394, 6 AM to 6 PM, Pacific Time, Monday through Friday.
- Canada: (905) 709-3839, 6 AM to 6 PM, Pacific Time, Monday through Friday.

Days and hours of support are subject to change without notice. Toll or long distance charges may apply.

Before you call for support, please have the following information ready:

- Product name (PowerLite 1725/1735W)
- Product serial number (located on the projector)
- Proof of purchase (such as a store receipt) and date of purchase
- Computer or video configuration
- Description of the problem

Purchase Supplies and Accessories

You can purchase screens, carrying cases, or other accessories from an Epson authorized reseller. To find the nearest reseller, call 800-GO-EPSON (800-463-7766). Or you can purchase online at www.epsonstore.com (U.S. sales) or www.epson.ca (Canadian sales).

A *Projector Installation*

This appendix provides guidelines on installing the projector in a permanent location, such as a theater or conference room.

The projector can be installed for four different viewing setups: front projection, ceiling projection, rear projection onto a semi-transparent screen, or rear/ceiling projection, as shown:

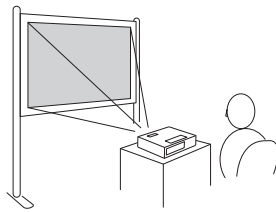

Front projection

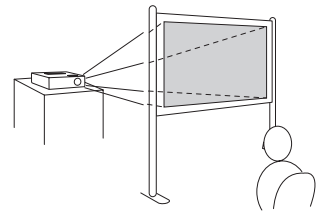

Rear projection

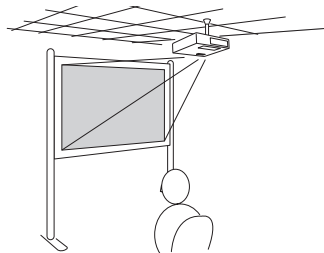

Ceiling projection

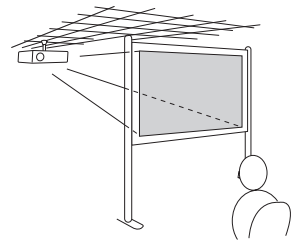

Rear/ceiling projection

To project from overhead, you'll need the optional ceiling mounting hardware; see page 12 for ordering information. You'll also need to select **Front/Ceiling** or **Rear/Ceiling** as the Projection option in the projector's Extended menu to flip the image upside-down. To project from the rear, onto a semi-transparent screen, select **Rear** or **Rear/Ceiling** (see page 111).

If you're mounting the projector on the ceiling and you place it above screen level, you'll have to tilt the projector down to position the image on the screen. This causes the image to lose its square shape. You can correct the distortion using the **Keystone** function in the projector's menu system (see page 104).

If you place the projector so that the base of the lens is level with the bottom of the screen, the image should be square and you won't have to adjust it. If you place the lens lower than the bottom of the screen, you'll have to tilt the projector upward if you want to fill the whole screen with the image.

C *Technical Specifications*

General

Type of display	Epson poly-silicon TFT active matrix
Resolution (native format)	
1735W	1280 × 800 pixels (WXGA)
1725	1024 × 768 pixels (XGA)
Color reproduction	16.8 million colors
Light output	High Brightness mode: 3000 lumens white light output (ISO 21118 standard) 3000 lumens color light output Low Brightness mode: 1900 lumens white light output (ISO 21118 standard) 1900 lumens color light output
Contrast ratio	2000:1 with auto iris
Image size	30 to 300 inches
Projection distance	
1735W	2.0 to 25.7 feet (0.62 to 7.83 meters)
1725	2.1 to 27.1 feet (0.65 to 8.26 meters)
Projection methods	Front, rear, upside-down (ceiling mount)
Internal sound system	1 W monaural
Optical aspect ratio	
1735W	16:10 (horizontal:vertical)
1725	4:3 (horizontal:vertical)

Zoom ratio	1:1.2
Noise level	30 dB in Low Brightness mode, 39 dB in High Brightness mode
Keystone correction	Automatic (manual adjustment capability $\pm 30^\circ$ vertical keystone correction)
Mouse compatibility	Supports USB (type B)

note

Lamp life results will vary depending upon mode selected, environmental conditions, and usage.

Turn off this product when not in use to prolong the life of the projector.

Projection Lamp

Type	UHE (Ultra High Efficiency)
Power consumption	170 W
Lamp life	Approx. 3000 hours (High Brightness mode) Approx. 4000 hours (Low Brightness mode)
Part number	V13H010L48

Remote Control

Range	20 feet (6 meters)
Batteries (2)	Alkaline AA

Dimensions

Height	2.8 inches (72 mm), feet retracted
Width	11.2 inches (284 mm)
Depth	7.9 inches (202 mm)
Weight	3.9 lb (1.8 kg)

Electrical

Rated frequency	50/60 Hz AC
Power supply	100 to 120 VAC, 2.7 A 200 to 240 VAC, 1.2 A

Power consumption	Operating:
	100 to 120 VAC, 243 W 200 to 240 VAC, 230 W
	Standby:
	100 to 120 VAC, 4.0 W (network off) 9 W (network on)
	200 to 240 VAC, 5.5 W (network off) 10 W (network on)

Environmental

Temperature	Operating: 41 to 95 °F (5 to 35 °C)
	Storage: 14 to 140 °F (-10 to 60 °C)
Humidity (non-condensing)	Operating: 20 to 80% RH
	Storage: 10 to 90% RH
Operating altitude	0 to 7,500 ft (0 to 2,286 m)

Safety

United States	FCC 47CFR Part 15B Class B (DoC) UL60950-1 First Edition
Canada	ICES-003 Class B CSA C22.2 No. 60950-1
CE Marking	Directive 2004/108/EC IEC 60950-1 First Edition



Pixelworks™ DNX™ ICs are used in this projector.

Compatible Video Formats

The projector supports NTSC, PAL, and SECAM international video standards, as well as the monitor display formats listed below.

To project images output from a computer, the computer's video card must be set at a refresh rate (vertical frequency) that's compatible with the projector. Some images are automatically resized using Epson's SizeWise™ technology to display in the projector's "native" format (XGA or WXGA). The frequencies of some computers may not allow images to display correctly; see your computer's documentation for details.

Mode	Refresh Rate (Hz)	Resolution
VGA EGA	70	640 × 350
VGA—60	60	640 × 480
VESA—72	72	640 × 480
VESA—75	75	640 × 480
VESA—85	85	640 × 480
SVGA—56	56	800 × 600
SVGA—60	60	800 × 600
SVGA—72	72	800 × 600
SVGA—75	75	800 × 600
SVGA—85	85	800 × 600
XGA—60	60	1024 × 768
XGA—70	70	1024 × 768
XGA—75	75	1024 × 768
XGA—85	85	1024 × 768
WXGA—60	60	1280 × 800
WXGA—75	75	1280 × 800
WXGA—85	85	1280 × 800
WXGA+—60	60	1440 × 900
WXGA+—75	75	1440 × 900
WXGA+—85	85	1440 × 900
WSXGA+—60*	60	1680 × 1050
SXGA1—70	70	1152 × 864
SXGA1—75	75	1152 × 864
SXGA1—85	85	1152 × 864

Mode	Refresh Rate (Hz)	Resolution
SXGA2—60	60	1280 × 960
SXGA2—75	75	1280 × 960
SXGA2—85	85	1280 × 960
SXGA+60	60	1400 × 1050
SXGA+75	75	1400 × 1050
SXGA+85	85	1400 × 1050
SXGA3—60	60	1280 × 1024
SXGA3—75	75	1280 × 1024
SXGA3—85	85	1280 × 1024
UXGA—60	60	1600 × 1200
iMAC VGA	117	640 × 480
iMAC SVGA	95	800 × 600
iMAC XGA	75	1024 × 768
MAC13	67	640 × 480
MAC16	75	832 × 624
MAC19	75	1024 × 768
MAC19-60	59	1024 × 768
MAC21	75	1152 × 870
NTSC	60	—
NTSC 4:43	60	—
PAL	50	—
N-PAL	50	—
M-PAL	60	—
PAL—60	60	—
SECAM	50	—
HDTV (720p)	60	—
HDTV (720p)	50	—
HDTV (1080i)	60	—
HDTV (1080i)	50	—
TV480i	60	—
TV480i	50	—
SDTV (480p)	60	—
SDTV (480p)	50	—

* Available only on the 1735W when the resolution is set to Wide.

D

Notices

This appendix includes safety instructions and other important information about your PowerLite projector.

Important Safety Instructions

Follow these safety instructions when setting up and using the projector:

- Do not look into the lens when the projector is on. The bright light can damage your eyes.
- Do not place the projector on an unstable cart, stand, or table.
- Do not operate the projector on its side, or while tilted to one side. Do not tilt the projector more than 30° forward or back.
- If the projector is mounted on a ceiling, it should be installed by qualified technicians using mounting hardware designed for use with this projector.
- If you use a ceiling mount and apply adhesives to the mount to prevent the screws from loosening, or if you use lubricants or oils on the projector, the projector case may crack and the projector may fall from its ceiling mount. This could cause serious injury to anyone under the mount and could damage the projector. When installing or adjusting a ceiling mount, do not use adhesives to prevent the screws from loosening and do not use oils or lubricants.
- Do not stand on the projector or place heavy objects on it.
- Do not use the projector where it may be exposed to rain, water, or excessive humidity.
- Unplug the projector from the wall outlet before cleaning. Use a dry cloth (or, for stubborn dirt or stains, a moist cloth that has been wrung dry) for cleaning. Do not use liquid or aerosol cleaners.
- Never spill liquid of any kind into the projector.
- Do not use the projector where it may be exposed to excessive dust or smoke.
- Never push objects of any kind through the cabinet slots.

- Do not use or store the projector or remote control in a hot location, such as near a heater, in direct sunlight, or in a closed vehicle.
- Do not block the slots and openings in the projector case. They provide ventilation and prevent the projector from overheating. Do not operate the projector on a sofa, rug, or other soft surface, or set it on top of loose papers, which could block vents underneath your projector. If you are setting up the projector near a wall, leave at least 7.9 inches (20 cm) of space between the wall and the air exhaust vent.
- Do not operate the projector in a closed-in cabinet unless proper ventilation is provided.
- If you are using two or more projectors side-by-side, leave at least 2 feet (60 cm) of space between the projectors to allow for proper ventilation.
- You may need to clean the air filter and vent. A clogged air filter or vent can block ventilation needed to cool the projector.
- Do not store the projector outdoors for an extended length of time.
- Do not use the projector outside the required temperature range of 41 to 95 °F (5 to 35 °C). Doing so may cause an unstable display and could lead to projector damage.
- Do not store the projector outside the required temperature range of 14 to 140 °F (–10 to 60 °C) or in direct sunlight for long periods of time. Doing so may cause damage to the case.
- Do not touch the plug during an electrical storm. Otherwise, you may receive an electric shock.
- Unplug the projector when it will not be used for extended periods.
- Unplug the projector from the wall outlet and refer servicing to qualified service personnel under the following conditions: If it does not operate normally when you follow the operating instructions, or exhibits a distinct change in performance; If smoke, strange odors, or strange noises come from the projector; If the power cord or plug is damaged or frayed; If liquid or foreign objects get inside the projector, or if it has been exposed to rain or water; If it has been dropped or the housing has been damaged.
- Except as specifically explained in this *User's Guide*, do not attempt to service this product yourself. Refer all servicing to qualified personnel. Opening or removing covers may expose you to dangerous voltages and other hazards.
- Never open any covers on the projector except as specifically explained in this *User's Guide*. Never attempt to disassemble or modify the projector. Refer all repairs to qualified service personnel.

- Use the type of power source indicated on the projector. Use of a different power source may result in fire or electric shock. If you are not sure of the power available, consult your dealer or power company.
- If you use the projector in a country other than where you purchased it, use the correct power cord for that country.
- Do not overload wall outlets, extension cords, or power strips. Do not insert the plug into a dusty outlet. This can cause fire or electric shock.
- Take the following precautions when handling the plug: Do not hold the plug with wet hands. Do not insert the plug into an outlet with dust present. Insert the plug firmly into the outlet. Do not pull the power cord when disconnecting the plug; always be sure to hold the plug when disconnecting it. Failure to comply with these precautions could result in fire or electric shock.
- Do not place the projector where the cord can be walked on.
- (Hg) The lamp(s) in this product contain mercury. Please consult your state and local regulations regarding disposal or recycling. Do not put in the trash.
- Do not place anything that can become warped or damaged by heat near the exhaust vents. Do not bring your hands or face close to the vents while projection is in progress.
- Before you move the projector, make sure its power is turned off, the plug is disconnected from the outlet, and all cables are disconnected.
- Never try to remove the lamp immediately after use because it will be extremely hot. Before removing the lamp, turn off the power and wait at least an hour to allow the lamp to cool completely.
- Do not place the source of an open flame, such as a lit candle, on or near the projector.
- Do not modify the power cord. Do not place heavy objects on top of the power cord or bend, twist, or pull it excessively. Keep the power cord away from hot electrical appliances.
- If the lamp breaks, ventilate the room to prevent gases contained in the lamp from being inhaled or coming in contact with the eyes or mouth.
- If the projector is mounted overhead and the lamp breaks, be careful to prevent pieces of glass from falling into your eyes when you open the lamp cover.

WARNING: The cords included with this product contain chemicals, including lead, known to the State of California to cause birth defects or other reproductive harm. *Wash hands after handling.* (This notice is provided in accordance with Proposition 65 in Cal. Health & Safety Code §25249.5 and following.)

FCC Compliance Statement

For United States Users

This equipment has been tested and found to comply with the limits for a Class B digital device, pursuant to Part 15 of the FCC Rules. These limits are designed to provide reasonable protection against harmful interference in a residential installation. This equipment generates, uses, and can radiate radio frequency energy and, if not installed and used in accordance with the instructions, may cause harmful interference to radio or television reception. However, there is no guarantee that interference will not occur in a particular installation. If this equipment does cause interference to radio and television reception, which can be determined by turning the equipment off and on, the user is encouraged to try to correct the interference by one or more of the following measures:

- Reorient or relocate the receiving antenna.
- Increase the separation between the equipment and receiver.
- Connect the equipment into an outlet on a circuit different from that to which the receiver is connected.
- Consult the dealer or an experienced radio/TV technician for help.

WARNING

The connection of a non-shielded equipment interface cable to this equipment will invalidate the FCC Certification of this device and may cause interference levels which exceed the limits established by the FCC for this equipment. It is the responsibility of the user to obtain and use a shielded equipment interface cable with this device. If this equipment has more than one interface connector, do not leave cables connected to unused interfaces. Changes or modifications not expressly approved by the manufacturer could void the user's authority to operate the equipment.

For Canadian Users

This Class B digital apparatus meets all requirements of the Canadian Interference-Causing Equipment Regulations.

Cet appareil numérique de la classe B respecte toutes les exigences du Règlement sur le matériel brouilleur du Canada.

Index

A

- A/V Mute, 30, 110, 128
- Access Point mode, 64 to 74
- Access point, checking IP address of, 71 to 72
- Accessories, 12
- Ad Hoc mode, 58 to 63
- Adapter, audio, 10, 50, 51
- Air filter
 - cleaning, 117
 - ordering, 12
 - replacing, 118 to 120
- AirPort, configuring for wireless, 62 to 63, 72 to 74
- Altitude, 112, 145
- Anti-theft device, 12, 15
- Aspect ratio, 32 to 33, 143
- Aspect setting, 32 to 33, 103
- Audio
 - adapter, 10, 50, 51
 - connecting equipment, 50 to 51
 - controlling volume, 31
 - problems, troubleshooting, 133 to 134
 - turning off (using A/V Mute), 30
- Authentication, 85 to 86
- Auto button, 25
- Auto Iris setting, 101
- Auto Keystone setting, 104
- Auto Setup setting, 102

B

- Bands, vertical, 132
- Blackboard color mode, 34
- Blackboard, projecting on, 33 to 34
- Blank screen, 19 to 21
- Blurry image, 131 to 132
- Brightness, 143
- Brightness setting, 100

C

- Cables
 - audio adapter, 10
 - illustrations, 10
 - mouse, 42
 - ordering, 12
 - remote control cable set, 12
 - S-video, 12, 46
 - USB, 10, 41, 43
 - VGA-to-component, 10, 40
- Capturing image, 108 to 109
- Carrying case, 10, 122
- Ceiling mount, 12, 141 to 142
- Certificate validation, 86 to 87
- Cleaning
 - air filter, 117
 - lens, 116
 - projector case, 116
- Closed captioning, 111
- Color
 - correcting, 33 to 34
 - mode, 33 to 34, 100
 - multi-screen adjustment, 113
 - problems, 133
 - saturation, 100
 - settings, 100 to 101
 - six-axis adjustment, 101 to 102
 - temperature, 101
- Color Adjustment setting, 101
- Color Mode setting, 100
- Color mode setting, 33 to 34
- Component video cable, 12, 44
- Composite (RCA) video cable, 44 to 45
- Computer
 - connecting to, 40 to 43
 - correcting images, 25
 - selecting source, 18 to 19

Connecting projector
to a computer, 40 to 43
to a digital camera, 49
to audio equipment, 50 to 51
to video equipment, 44 to 48
Contrast setting, 100
Control Panel Lock setting, 104, 110
Customized color mode, 34

D

Data encryption, 88
Default settings, restoring, 99
DHCP, 65, 69, 73, 135
Digital camera, connecting to, 49
Direct Power On, 17, 112
Distance from projector to screen, 14, 143
Documentation, 8
DVD player, connecting, 44 to 48

E

EAP authentication, 85 to 86
EAP-TLS certificate, 86 to 87
EasyMP button, 19, 29, 90
Electrical specifications, 144
E-mail alerts, 91 to 93
EMP NS Connection
configuring projector for, 64 to 87
creating password for, 56
problems, 134 to 136
projecting wirelessly, 53 to 88
Encryption, 62, 68, 81 to 83, 88
Environmental specifications, 145
Epson
accessories, 12
presentation tips, 9
PrivateLine Support, 9
technical support, 8, 138 to 139
Ethernet unit, optional, 90 to 91
Extended menu, 111 to 112
E-Zoom button, 31

F

FCC compliance statement, 152
Filter, *see* Air filter
Focusing image, 23
Freeze button, 30

G

Game color mode, 33
Gateway address, checking, 71

H

HDTV images, video formats, 147
Height of image, adjusting, 22
Help system, using, 124
Help, Epson, 8, 138 to 139
High altitude, 112

I

Image
adjusting, 22 to 25, 100 to 101
blurry, 131 to 132
capturing and saving in projector,
108 to 109
correcting shape, 23 to 24, 104, 131
fitting on screen, 102, 130
height, adjusting, 22
positioning, 103
problems with, 128 to 133
projecting on chalkboard, 33 to 34
raising, 22
selecting source, 18 to 19, 29, 45 to 48
size and projection distance, 14, 143
turning off (using A/V Mute), 30
zooming, 23, 31
Image menu, 100 to 101
Info menu, 127
Infrastructure mode, *see* Access Point mode
Input Signal setting, 103
Input signal, selecting, 18 to 19, 29, 45 to 48
Installing projector, 141 to 142
Instant Off, 18

K

- Kensington anti-theft device, 12, 15
- Keystone correction, 23 to 24, 104, 131, 144
- Keyword, 56

L

- Lamp
 - number of hours used, 127
 - ordering, 12
 - replacing, 118 to 121
 - specifications, 144
 - status light, 125 to 126
- Lamp timer, resetting, 121
- Language setting, 112
- Laptop computer
 - connecting to, 40 to 41
 - display problems, 20 to 21, 128 to 129
 - selecting source, 18 to 19, 29
- LEAP authentication, 85 to 86
- Lens cover timer, 112
- Lens, cleaning, 116
- Lights, status, 125 to 126
- Logo, saving on projector, 108 to 110

M

- Mac
 - configuring for wireless, 62 to 63, 72 to 74
 - display problems, 129
 - resolution setting, 130
- Manuals, 8
- Menus
 - changing settings, 98 to 99
 - default settings, restoring, 99
 - Extended, 111 to 112
 - Image, 100 to 101
 - Info, 127
 - Network, 75
 - network, 55
 - Settings, 104 to 105
 - Signal, 102 to 103
 - User's Logo, 108 to 109

- Monitoring projector
 - e-mail notifications, 91 to 93
 - SNMP, 93 to 94

- Mouse
 - compatibility, 144
 - connecting cable for remote, 42 to 43
 - using remote control as, 35
- Multiple projectors, controlling, 37 to 38
- Multi-screen color adjustment, 113

N

- Network
 - problems, 134 to 136
 - security, 80 to 88
 - wired, 90 to 91
 - wireless, 53 to 96
- Network settings, configuring, 55 to 94
- No Signal message, 19, 129
- Noise level, 144
- Not Supported message, 130
- NS Connection, *see* EMP NS Connection
- Numeric keypad, using, 107

O

- Optical aspect ratio, 143
- Options for projector, 12

P

- Password
 - default, 107
 - protection, 106 to 108
 - remote access, 56
 - request code, 108
- PEAP authentication, 85 to 86
- Photo color mode, 34
- Picture source, selecting, 18 to 19, 29, 45 to 48
- Picture, *see* Image
- PIN code method, 74, 78 to 79
- Pointer Shape setting, 104
- Pointer tool, using, 36
- Positioning
 - image, 22
 - projector, 14 to 15, 141 to 142

Power
 button, 17
 specifications, 144
 status light, 17, 125 to 126
Presentation color mode, 33
Presentations
 computer, 25, 40 to 43
 digital camera, 49
 room conditions, 14, 28
 tips and training, 9
 using the pointer tool, 36
 video, 44 to 48
 wireless, 53 to 96
Presenters Online, 9
PrivateLine Support, 9
Problems
 color, 133
 connecting wirelessly, 134 to 136
 image, 128 to 133
 no signal, 19, 129
 remote control, 136
 sound, 133 to 134
 using on-screen help, 124
Progressive format, 103
Projecting without screen, 33 to 34
Projection lamp, *see* Lamp
Projector
 carrying case, 122
 cleaning, 116
 disabling buttons, 110
 distance from screen, 14, 143
 installing, 141 to 142
 lamp specifications, 144
 options, 12
 password protection, 106 to 108
 positioning, 14 to 15
 resolution, 143
 specifications, 143 to 145
 transporting, 122
 troubleshooting, 123 to 137
 turning off, 18
 turning on, 15 to 17
 unpacking, 10
 viewing information about, 127
Projector ID, setting, 37, 112

Push button method, 74, 76 to 77

Q

Quick Wireless Connection
 troubleshooting, 134
 using, 54

R

Raising image, 22
Rear-screen projection, 111, 141 to 142
Registration, 9
Remote control
 A/V Mute button, 30
 as wireless mouse, 35
 battery used, 144
 connecting cable for mouse, 42 to 43
 controlling multiple projectors, 37 to 38
 correcting color, 33 to 34
 E-Zoom button, 31
 Freeze button, 30
 ID, 38
 numeric keypad, using, 107
 pointer tool, using, 36
 problems, 136
 range, 144
 specifications, 144
 switching sources, 29
 troubleshooting, 136
Removing wireless module, 89
Replacing lamp, 118 to 121
Request code, password, 108
Resetting lamp timer, 121
Resetting menu options, 99
Resize image, 32 to 33
Resolution, 130, 143
Resolution setting, 103

S

Safety
 instructions, 149 to 151
 specifications, 145
Saturation setting, 100

Screen
 blank, 19 to 21
 distance from projector, 14, 143
 ordering, 12
 startup screen, creating, 108 to 109
Screen image, *See* Image
Security
 control panel lock, 110
 Kensington lock, 12
 network, 80 to 88
 password protection, 106 to 108
 startup screen, 108 to 110
Settings menu, 104 to 105
Sharpness setting, 101
Signal menu, 102 to 103
Six-axis color adjustment, 101 to 102
Sleep mode, 16, 112
SNMP, 93 to 94
Sound, troubleshooting, 133 to 134
Source
 selecting, 18 to 19, 29
 viewing, 127
Speaker, specifications, 143
Speakers, connecting, 51
Specifications
 brightness, 143
 dimensions, 144
 electrical, 144
 environmental, 145
 general, 143
 lamp, 144
 remote control, 144
 resolution, 143
 safety, 145
Sports color mode, 34
sRGB color mode, 34
SSID, 59, 62, 68, 73, 135
Startup screen, creating, 108 to 110
Status lights, 125 to 126
Support, *see* Technical support
S-video cable, 12, 46
Switching picture source, 18 to 19, 29
Sync setting, 103
Synchronization, adjusting, 25, 132

T

Technical support, 8, 138 to 139
Temperature
 requirements, 145
 status light, 125 to 126
Temperature, color, 101
Test pattern, displaying, 24, 105
Text color mode, 33
Theatre color mode, 34
Tint setting, 100
Tracking, adjusting, 25, 103, 132
Transporting projector, 122
Troubleshooting
 blank screen, 19 to 21, 128 to 129
 cut-off image, 130
 distorted image, 23 to 24
 image and sound problems, 128 to 134
 network problems, 134 to 136
 no signal, 19, 129
 projector problems, 123 to 137
 remote control problems, 136
 wireless projection problems, 134 to 136
Turning off picture (using A/V Mute), 30
Turning on/off projector, 15 to 18

U

Unpacking projector, 10
USB cable, 10, 41, 43
USB display, 41 to 42
USB key, 54
User button, 105
User's Logo menu, 108 to 109

V

VCR, connecting, 44 to 48
Video
 cables, 10, 12, 44
 connecting video equipment, 44 to 48
 display settings, viewing, 127
 formats, supported, 146 to 147
 selecting source, 18 to 19, 29, 45, 46
Video Signal setting, 103
Volume, controlling, 31

W

Warning lights, 125 to 126

Warranty, 9

WEP encryption, 81 to 83

Wi-Fi Protected Setup, 74 to 79

Windows

- configuring for wireless, 60 to 62, 66 to 70

- display problems, 129

- resolution setting, 130

- Vista, 94 to 96

Wired network, 90 to 91

Wireless

- EAP, 85 to 86

- EAP-TLS, 86 to 87

- LEAP, 85 to 86

- module, 10

- network module, 89

- PEAP, 85 to 86

- presentation, 53 to 96

- problems, 134 to 136

- Quick Wireless Connection, 54

- security, 80 to 88

- WEP encryption, 81 to 83

- Windows Vista, 94 to 96

- WPA security, 83 to 84

Wireless, mouse, 35, 42 to 43

WPA security, 83 to 84

WPS connection, 74 to 79

Z

Zoom ratio, 144

Zooming image, 23, 31

EPSON[®]
EXCEED YOUR VISION