

myprojectorlamps.com

**The most trusted, dependable name
in projector lamp sales.**



<http://www.myprojectorlamps.com>



<http://www.myprojectorlamps.ca>



<http://www.myprojectorlamps.eu>

The following projector manual has not been modified or altered in any way.

Home Projector
EMP-TW500

User's Guide

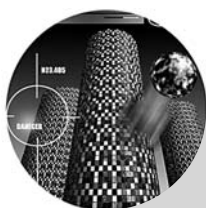

About The Manuals and Notations Used

Types of Manual

The documentation for your EPSON projector is divided into the following four manuals. Refer to the manuals in the order given below.

① Unpacking and Installation Guide

Lists the accessories that are provided with the projector.

② Safety Instructions/World-Wide Warranty Terms

This manual contains information on using the projector safely, and also includes *safety instructions*, *world-wide warranty terms* booklet and a troubleshooting check sheet.

Read this manual thoroughly before using the projector.

③ Setup Guide







Contains information on basic operations for preparing the projector before use (setup and connecting to video equipment or a computer) and for starting projection.

④ User's Guide (this manual)

Contains information on adjusting images, using the configuration menus, using the Cinema Color Editor, troubleshooting and maintenance.

Notations used in this User's Guide

General information

	Indicates procedures where personal injury or damage to the projector may occur if the procedures are not followed correctly.
	Indicates additional information and points which may be useful to know regarding a topic.
	Indicates a page where useful information regarding a topic can be found.
	Indicates that an explanation of the underlined word or words in front of this symbol appears in the glossary of terms. Refer to the "Glossary" in the "Appendix".  p.49
 ,  , etc.	Indicates buttons on the remote control or the projector's control panel.
"(Menu name)"	Indicates configuration menu items. Example: "Image" - "Color Mode"
[(Name)]	Indicates projector connection port names, and computer menu and menu item names. Example: [InputA] [Start]

Meaning of "unit" and "projector"

When "unit" or "projector" appears in the text of this *User's Guide*, they may refer to items which are accessories or optional equipment in addition to the main projector unit itself.

Contents

■ Features of the Projector	2	Remote Control	5
■ Part names and Functions	4	Rear	6
Front/Top.....	4	Base	6
Control Panel.....	4	■ Appearance	7

Basic Image Quality Adjustments

■ Basic Image Quality Adjustments	8	Hue and saturation adjustment.....	10
Selecting the Color Mode	8	■ Viewing images at a preset image quality (memory function)	12
Selecting the Image Aspect.....	8	Saving Image quality adjustments (Memory save)	12
■ Advanced Color Adjustments	10	Retrieving image quality adjustments (Memory retrieve)	12
Abs. Color Temp./Flesh Tone Adjustments.....	10		
RGB adjustment	10		





Configuration Menu

■ Configuration Menu Functions	14	"Setting" menu	18
List of Configuration Menus.....	14	"Reset" menu.....	22
"Image" menu.....	16	Using the Configuration Menus	23

Adjusting projected images using a computer

■ Preparation for Using Cinema Color Editor ..	24	■ Using Cinema Color Editor	28
Installing Cinema Color Editor.....	24	Starting Cinema Color Editor.....	28
Uninstalling Cinema Color Editor	25	Adjusting picture quality.....	28
Connecting to a Computer	25	Operating the projector.....	28
• Connection using a USB cable or RS-232C cable	26	Saving adjustment/Loading adjustments from a file.....	29
• Connection using a network cable.....	25	Saving customised settings into memory	30
Connection settings at the projector (when using a network connection).....	26	Saving/loading memory settings and editing memory area names	30
• Setting details	27		

Troubleshooting

■ Problem Solving	32	When the Indicators Provide No Help	33
Reading the Indicators	32	• Problems relating to images	34
• When the  indicator is lit or flashing red	32	• Problems when projection starts.....	38
• When the  or  indicator is flashing orange	32	• Problems with the remote control.....	38
• When the  indicator is lit or flashing green or orange.....	33	• Problems with network connections.....	39

Appendix

■ Maintenance	40	• Resetting the Lamp Operating Time	42
Cleaning	40	■ Optional Accessories	44
• Cleaning the Air Filter.....	40	■ List of Supported Monitor Displays	45
• Cleaning the Projector Body	40	• Component Video/RGB Video.....	45
• Cleaning the Lens	40	• Composite Video/S-Video.....	45
Consumable Replacement Periods.....	41	• Analog-RGB signals/signals input to the [HDMI] port	45
• Air Filter Replacement Period.....	41	■ Specifications	46
• Lamp Replacement Period	41	Compatible computers for using Cinema Color Editor	47
Replacing Consumables	42	RS-232C cable layout	47
• Replacing the Air Filter	42	■ Glossary	49
• Replacing the Lamp.....	42	■ Index	51

Features of the Projector

▶ Image appearance can be selected to match the projection environment (Color Mode)

The optimum images for the location can be projected simply by selecting the desired colour mode from the following six preset modes. No complex colour adjustments are required.

When one of "Theatre", "Natural", "Theatre Black" or "sRGB" is selected, the Epson Cinema Filter effect will be applied automatically. This increases contrast and makes flesh tones appear more natural.

In addition, if you select "Dynamic" or "Living Room", the Black-White Stretch function will operate to produce images that appear more solid, with clearer light and dark areas. [p.8](#)

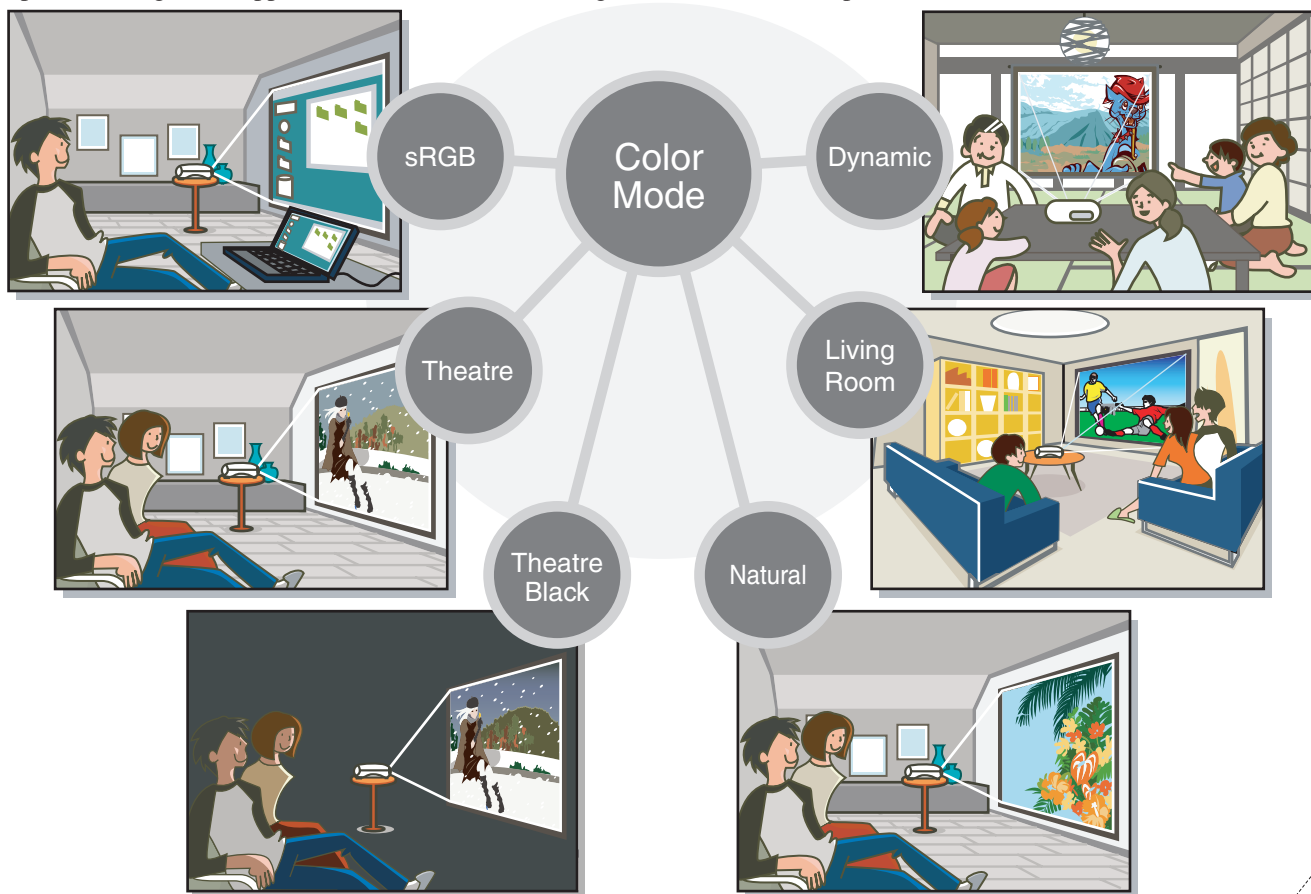

▶ Easy image adjustments by computer

The Cinema Color Editor CD-ROM supplied with the projector can be used to make fine adjustments to the hue and saturation of the projected images from a computer.

Adjustment values can be saved in computer files which can be exchanged with other people so that they can also enjoy the images adjusted by you.

In addition, if the projector is connected to a network, the projector can be operated and image adjustment data can be uploaded and downloaded via the network. [p.24](#)

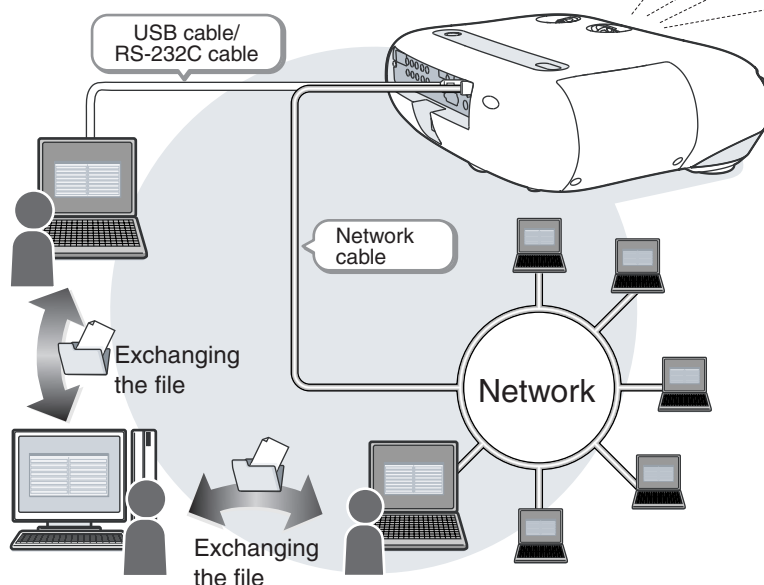

▶ Equipped with a wide-angle lens shift function

The lens shift function allows you to adjust the position of the projected images vertically and horizontally without distorting the images.

This allows the projector to be set up with greater freedom, even if it is suspended from a ceiling or at an angle to the screen. [☞ Setup Guide](#)

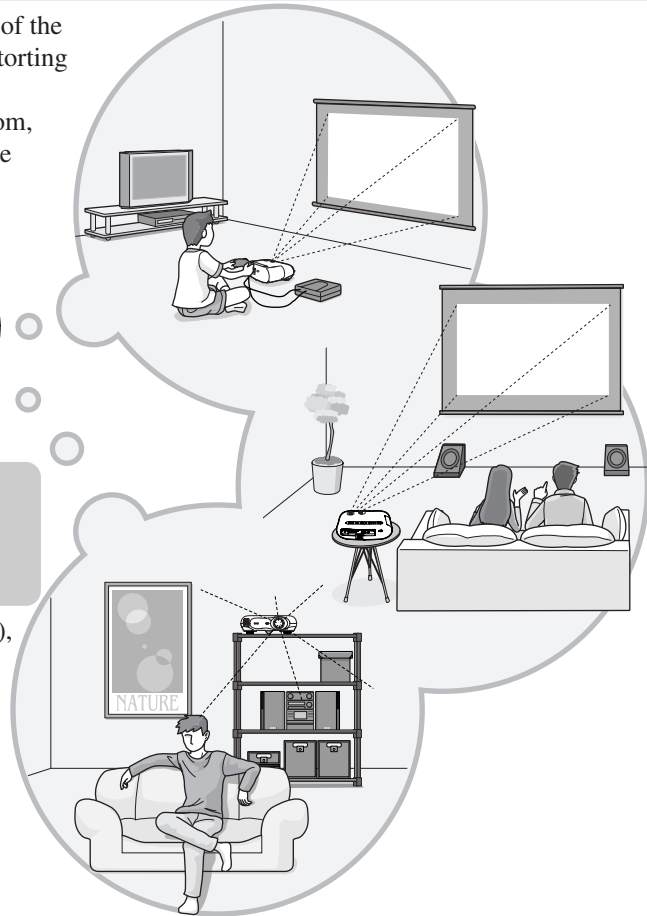
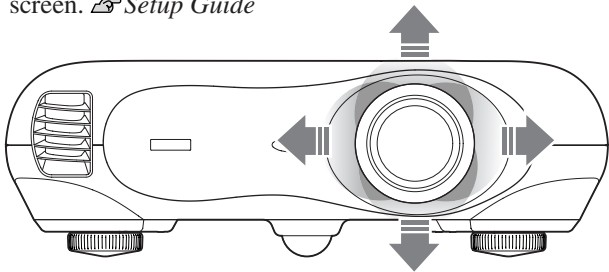

▶ Adjusting the hue and saturation of colours

The hue and saturation for each of the red (R), green (G), blue (B), cyan (C), magenta (M) and yellow (Y) colour components can be adjusted to produce images with greater depth. [☞ p.10, p.28](#)



▶ Wide range of brightness adjustments

The image brightness can be adjusted within a wide range. Optimum images can be obtained even if using the projector in a bright environment for watching videos or games, or in a dark environment such as when creating the atmosphere of a home theatre. [☞ p.16](#)

▶ Electronic zoom and focus adjustment

The projector's control panel and the accessory remote control can be used for easy zoom and focus adjustments. For zoom adjustment, a high magnification lens is provided to allow images to be increased in size by up to 1.5 times, so that images can be projected onto an 80" screen even at a distance of approximately 2.5 m (8.2 ft.). [☞ Setup Guide](#)

▶ A variety of image setting functions

Many other functions are available as follows.

- EPSON Super White function that reproduces input signals containing whites of 100IRE or higher without overexposure. [☞ p.18](#)
- Progressive and Motion Detection functions allow you to obtain ideal results both for images with large amounts of movement and for still images. [☞ p.18](#)
- An aspect function that allows images to be viewed in wide-screen format. [☞ p.8](#)
- Memory functions that allow adjustment results to be stored and later retrieved easily using the remote control. [☞ p.12](#)
- Key lock function that locks the control panel so that settings cannot be changed accidentally after adjustment. [☞ p.20](#)
- Adoption of a special high-resolution DCDi video circuit developed by Faroudja. This circuit greatly reduces the jagged edges that resulted from conventional progressive conversion.

Part names and Functions

Front/Top

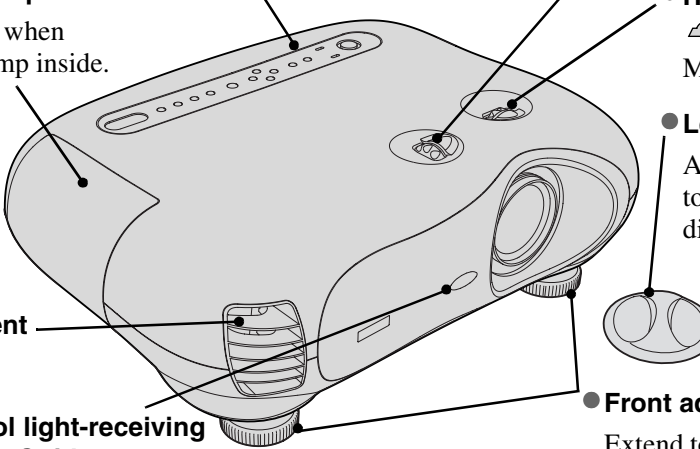
- 
- **Control panel** See below
 - **Lamp cover** p.42
Open this cover when replacing the lamp inside.
 - **Air exhaust vent**
 - **Remote control light-receiving area** **Setup Guide**
Receives signals from the remote control.
 - **Vertical lens adjustment dial** **Setup Guide**
Moves the lens vertically.
 - **Horizontal lens adjustment dial** **Setup Guide**
Moves the lens horizontally.
 - **Lens cover**
Attach when not using the projector to prevent the lens from becoming dirty or damaged.
 - **Front adjustable feet** **Setup Guide**
Extend to adjust the projection angle so that the projector is horizontal when placed on a desk top.

Control Panel

The area around the control panel buttons and characters light when the projector's power is turned on. If the "Button Illumination" configuration menu command is set to "OFF", they will not light. p.21

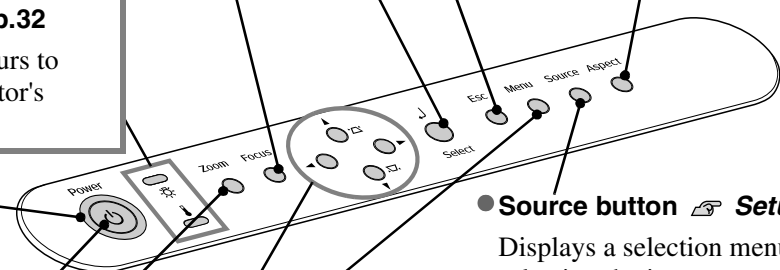
- 
- **Select button** p.8, p.10, p.12, p.23
Displays the line menu.
When viewing a configuration menu or selection menu, press this button to select the menu item and proceed to the next display.
 - **Focus button** **Setup Guide**
Press to adjust the focus of the projection lens.
 - **Esc button** p.23
Pressing [Esc] while viewing a configuration menu or selection menu displays the previous menu.
 - **Aspect button** p.8
Displays a selection menu for selecting the aspect.
 - **Source button** **Setup Guide**
Displays a selection menu for selecting the image source.
 - **Menu button** p.23
The full-screen configuration menus turn on and off each time the [Menu] button is pressed.
 - **▲ / ▽ / ◀ / ▶ buttons** p.8, p.10, p.12, p.23, **Setup Guide**
Used as up/down buttons to select items in configuration menus and select menus.
If the above menus are not displayed, corrects the keystone distortion.
 - **◀ ▶ buttons** p.23, **Setup Guide**
Press to select configuration menus or to adjust the focus and zoom.
- **Lamp indicator** p.32
Lights or flashes in different colours to indicate problems with the projection lamp.
 - **(temperature) indicator** p.32
Lights or flashes in different colours to indicate problems with the projector's internal temperature.
- **(Operation) indicator** p.32
Flashes or lights in different colours to indicate the operating status of the projector.
- **Power button** **Setup Guide**
Press to turn the power on and off.
- **Zoom button** **Setup Guide**
Press to adjust the size of projected images.

Remote Control

Buttons with no explanation function in the same way as the corresponding buttons on the projector's control panel. Refer to "Control Panel" for further details on these buttons.

● **Remote control light-emitting area** *Setup Guide*
Outputs remote control signals.

● **Indicator**
Illuminates when remote control signals are being output.

● **Menu button** *p.23*

● **Memory button** *p.12*
Displays a selection menu for selecting memory settings.

● **Select/Line menu button** *p.8, p.10, p.12, p.23*

● **▲ ▼ ◀ ▶ buttons** *p.8, p.12, p.23, Setup Guide*
Press to select configuration menu and selection menu items and adjustment values and to adjust the zoom and focus.

● **Pattern button** *Setup Guide*
Displays a selection menu for selecting a test pattern.

● **Zoom button** *Setup Guide*

● **Blank button**
The projected images switch off and on each time this button is pressed.

● **Focus button** *Setup Guide*

● **(Illumination) button**
All buttons on the remote control illuminate when this button is pressed. The button illumination switches off automatically after about 10 seconds.

● **On/Off buttons** *Setup Guide*
Press to turn the projector power on and off.

● **Color Mode button** *p.8*
Displays a selection menu for selecting the colour mode.

● **Aspect button** *p.8*

● **Esc button** *p.23*

Source *Setup Guide*

● **HDMI button:** Switches the input source to images from the [HDMI] port.

● **D4 button:** Switches the input source to the projector's [D4] port. The signal changes as follows and the "Input Signal" menu also changes each time the button is pressed.



● **InputA/InputB buttons:** Switches the input source to the projector's [InputA] or [InputB] port. The signal changes as follows and the "Input Signal" menu also changes each time a button is pressed.

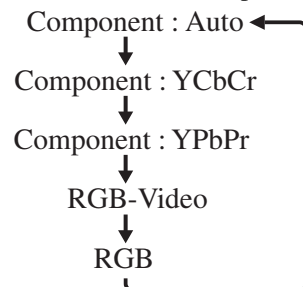





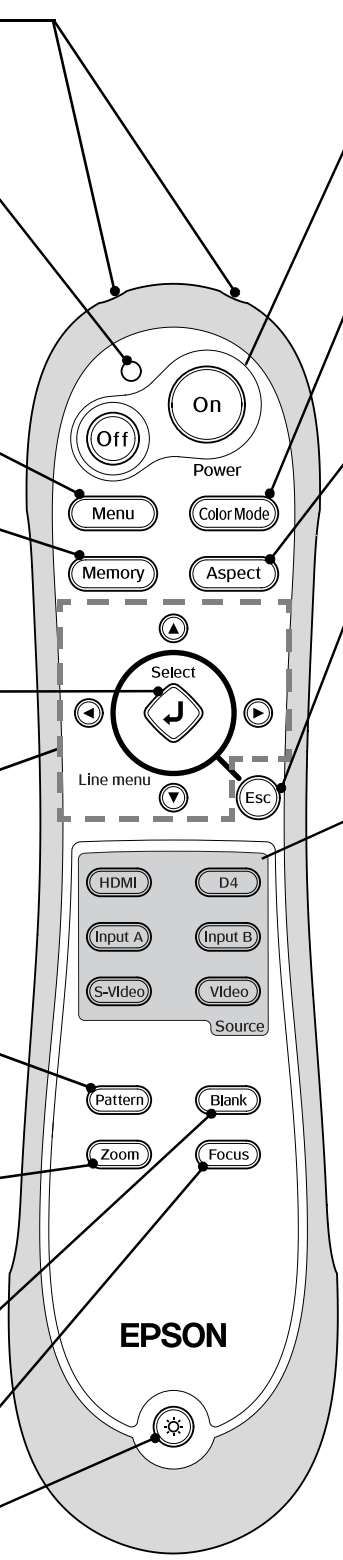



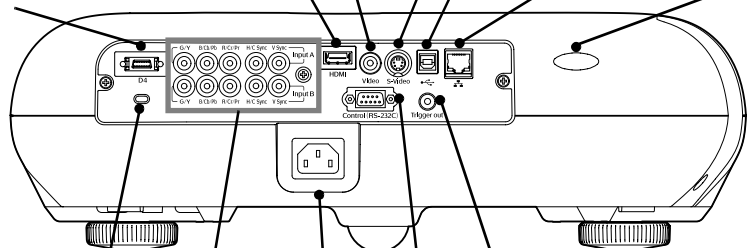





● **S-Video button:** Switches the input source to the projector's [S-Video] port.



● **Video button:** Switches the input source to the projector's [Video] port.



Rear

- 
- **[Video] port**  **Setup Guide**
Connects to general video ports of other video equipment.
 - **[HDMI] port**  **Setup Guide**
Connects to video equipment or a computer that is HDMI-compatible.
 - **[D4] port**  **Setup Guide**
Connects to the component video (YCbCr or YPbPr) ports or D port of other video equipment. (Japan only)
 - **[S-Video] port**  **Setup Guide**
Inputs an S-Video signal to the projector from other video equipment.
 - **[USB] port**  **p.26**
Connects the projector to a computer using a USB cable when using the Cinema Color Editor.
 - **[Network] port**  **p.25**
Connects the projector to a network.
 - **Remote control light-receiving area**  **Setup Guide**
Receives signals from the remote control.
 - **Security lock ()**  **p.49**
 - **[Input A]/[Input B] ports**  **Setup Guide**
Connects to the component video (YCbCr or YPbPr) ports or RGB ports of other video equipment or to a computer's video output port.
 - **Power inlet**  **Setup Guide**
Connects the power cable.
 - **[Trigger out] port**  **p.20**
When the projector power is turned on, a 12 V DC signal is output from this port. When the projector's power is turned off or a problem with operation occurs, the output becomes 0 V to send the projector's power ON/OFF status to an external device.
 - **[Control (RS-232C)] port**  **p.26**
Connects the projector to a computer using an RS-232C cable when using the Cinema Color Editor.

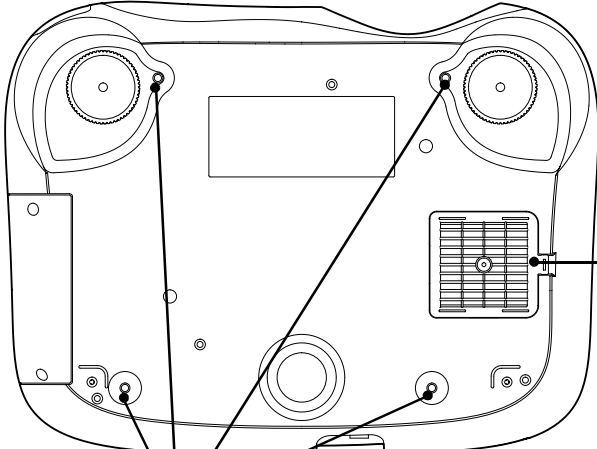
Base

- 
- **Air filter (air inlet)**  **p.40, p.42**
Prevents dust and other foreign particles from being drawn into the projector. It should be cleaned periodically.
 - **Suspension bracket fixing points (4 points)**  **p.44**
Attach the optional ceiling mount here when suspending the projector from a ceiling.

Appearance

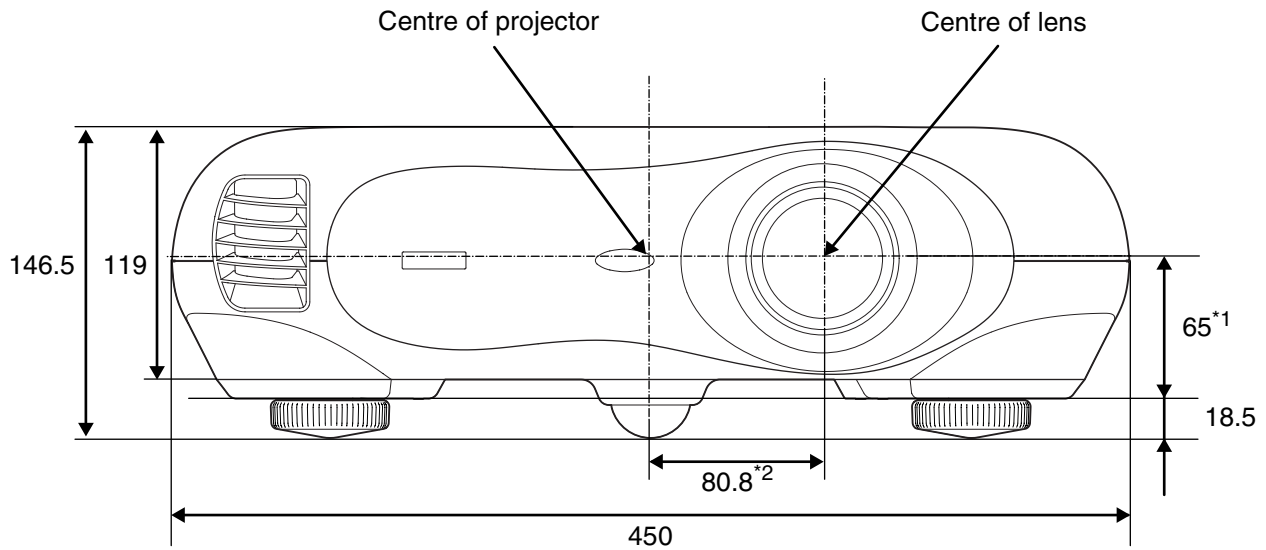

- *1 Distance from centre of lens to suspension bracket fixing point
(Lens shift amount: Max. 8.7 mm upwards, Max. 4.3 mm downwards)
- *2 Distance from centre of lens to centre of projector
(Lens shift amount: Max. 7.7 mm to the left and right)

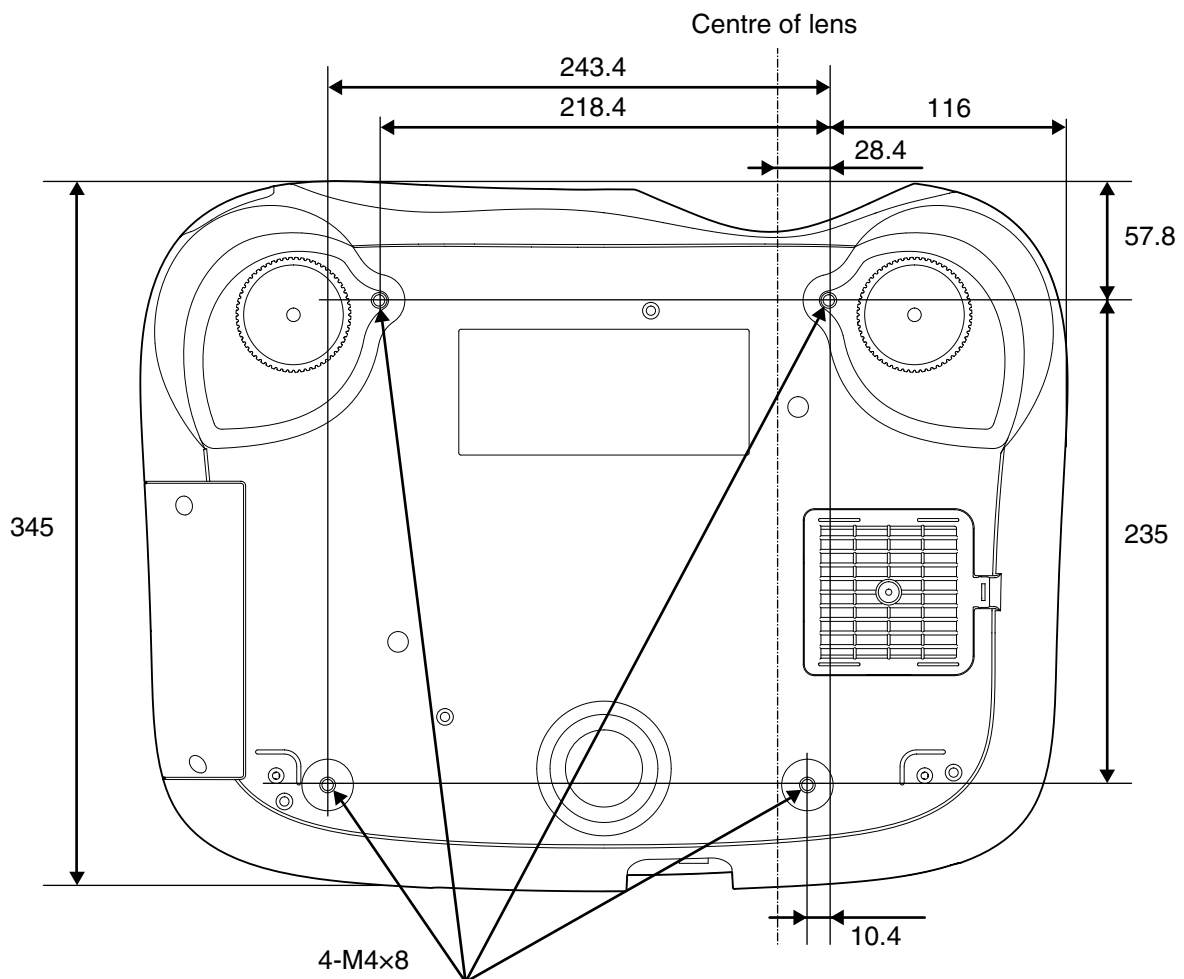

Units: mm

Basic Image Quality Adjustments

Selecting the Color Mode



Default setting : Dynamic

Selecting the Image Aspect

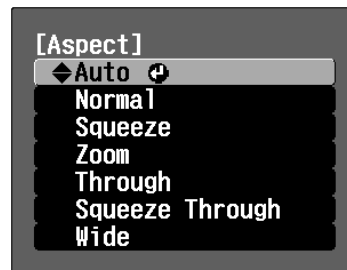

Default setting

When signals from the [Video], [S-Video], [D4] or [HDMI] port are being projected: Auto

When signals from the [InputA] or [InputB] port are being projected: Normal

When projecting using **Auto**

If the signals are being input to the [Video], [S-Video], [D4] or [HDMI] port, the optimum aspect is selected in accordance with the signal as follows.

- For 4:3 input signals → Normal
- For input images recorded in squeeze mode → Squeeze
- For letterbox input signals → Zoom

* If Auto is not suitable, the setting will become Normal.

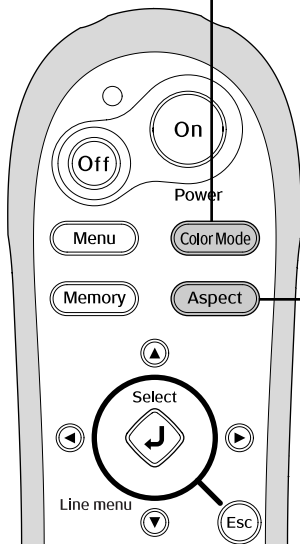

Selection menu operations

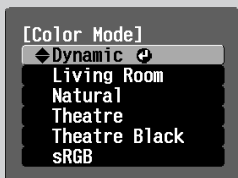

Press \uparrow or \downarrow on the remote control or \uparrow or \downarrow on the projector's control panel to select an item.

Press \diamond or \circ to confirm the selection.









* If you press Esc , the selection menu disappears.

Press **Color Mode** and select the colour mode from the six available modes in the selection menu depending on the place where the projector is being used. Setting is also possible using the configuration menu.

- Dynamic** : Ideal for using in bright rooms.
- Theatre** : Ideal for using in dark rooms.
- Living Room** : Ideal for using in rooms in which the curtains are closed.
- Theatre Black** : Ideal for using in rooms blocking light completely.
- Natural** : Ideal for using in dark rooms. It is recommended that you start in this mode when making colour adjustments.
- sRGB** : If the connected signal source has an **sRGB** mode, set both the projector and the connected signal source to sRGB. (Ideal for viewing computer images.)

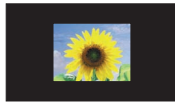
If "Natural", "Theatre", "Theatre Black" or "sRGB" is selected, the Epson Cinema Filter will be applied automatically. This increases contrast and makes flesh tones appear more natural. In addition, if "Dynamic" or "Living Room" is selected, the Black-White Stretch function will operate to produce images with greater contrast between lighter and darker shades.

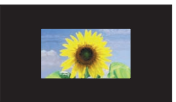
Press **Aspect** and select the aspect mode from the selection menu.

Input signal	<ul style="list-style-type: none"> ● Images from normal TV broadcasts ● Images with standard aspect ratio (4:3) ● Computer images 	Images recorded by a video camera or DVD software in squeeze mode	Letterbox images	<ul style="list-style-type: none"> ● Images from normal TV broadcasts ● Images with standard aspect ratio (4:3)
Recommended aspect mode	Normal	Squeeze	Zoom	Wide
Result	 Black bands will appear at the left and right of the images.	 Input signals will be projected at the same width as the projector's panel resolution.	 Input signals will be projected at the same height as the projector's panel resolution.	 Input signals will be projected at the same height as the projector's panel resolution. At this time, the image enlargement ratio will be smaller near the middle of the images but become larger towards the left and right edges of the images.
Remarks	 When HDTV images are projected, the images appear in 16:9 size. When the input signal resolution is 1280 × 720 or less and "Through" or "Squeeze Through" is selected, the images are projected onto the screen with the input signal resolution unchanged, and so clearer images are projected. Through  To project images so that they fill the whole of the screen, use the zoom adjustment or move the projector further away from the screen.	 When 4:3 images are projected, the images will be elongated horizontally. Squeeze Through 	<ul style="list-style-type: none"> ● When 4:3 images are projected, the top and bottom of the images will be truncated. ● When images with subtitles are projected and the subtitles are truncated, use the "Zoom Caption" menu command to adjust.  p.19 	<p>This is useful for when 4:3 images are projected onto a wide ascreen. Because there is almost no distortion due to enlargement in the middle of the images, the images appear close to what they would be at their original size. And because both ends of the images are enlarged, movement at the edges of the images appears faster and gives an impression of greater speed, making it ideal for viewing sporting events.</p> <p>*"Wide" cannot be selected if keystone correction has been carried out.</p>

Advanced Color Adjustments

If you would like to create your own images with settings adjusted the way you want them, you can adjust "Abs. Color Temp.", "Flesh Tone" "RGB" and/or "RGBCMY" in the "Color Adjustment" sub-menu of the "Image" menu.

The adjustment values can be stored in "Memory: Standard" and "Memory: Advance" so that you can retrieve them and apply them to the projected images at any time. [p.12](#)

Press or and select "Color Adjustment".

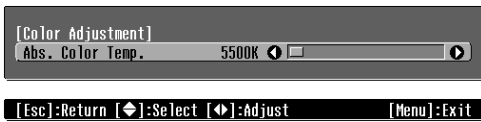

Use and to change.



Abs. Color Temp./Flesh Tone Adjustments

"Abs. Color Temp." adjustment

Flesh tone adjustment

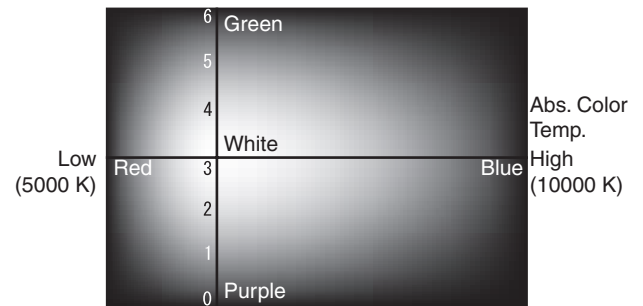

1 Press and then select "Image" - "Color Adjustment" - "RGB/RGBCMY" in that order.

2 Press and then select "RGB".



RGB adjustment

• Offset adjustment

Brightness

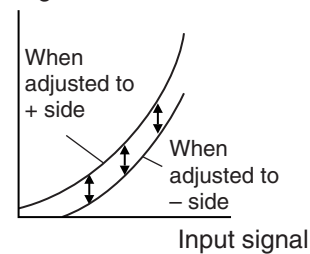

To make dark areas appear more clearly, adjust to the + side. If adjusted to the - side, the whole image will become sharper, but the contrast for dark areas will become poorer.

1 Press and then select "Image" - "Color Adjustment" - "RGB/RGBCMY" in that order.

2 Select "RGB/RGBCMY" - "RGBCMY" - "Return".

3 Press and then select "RGBCMY".

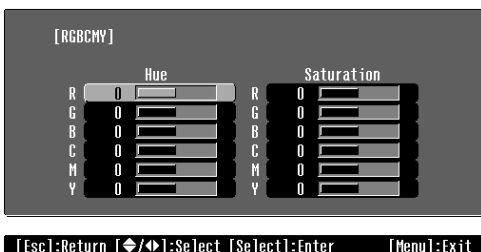

Hue and saturation adjustment



After adjusting the hue and saturation for each of the red (R), green (G), blue (B), cyan (C) magenta (M) and yellow (Y) colour components, select "Apply" to apply the adjustments to the images.

To make further adjustments, press . To adjust another colour, select "Return".



If you use the Cinema Color Editor supplied with the projector, you can make picture quality adjustments easily from a computer using a mouse. These adjustments can be saved in a computer file which can be exchanged with other people so that they can also enjoy the images adjusted by you. ↪ p.24

● Abs. Color Temp.

You can adjust the overall tint of images.

If you select a higher value, images appear bluish, and if you select a lower value, images appear reddish. The absolute colour temperature can be set to one of 12 settings within the range of 5000K to 10000K.

● Adjusting flesh tones

This can be used to adjust the flesh tones for images of people.

The Epson Cinema Filter that is automatically applied to images depending on the "Color Mode" settings creates natural-looking flesh tones. If you would like to further enhance flesh tones, use this "Flesh Tone" setting to make the adjustment.

If you select a larger value, images appear greenish, and if you select a smaller value, images appear purplish.

The image brightness can be adjusted by adjusting the individual R (red), G (green) and B (blue) components of the dark areas (offset), bright areas (gain) and intermediate areas (gamma) respectively. Because such detailed adjustments are possible, images with greater depth can be obtained.

● Gain adjustment

Brightness

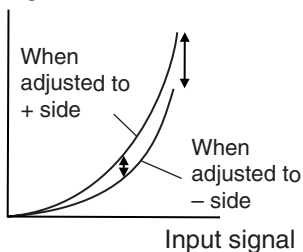

If you would like bright areas to appear more clearly, change the setting to the – side. If you change it to the + side, bright areas will become whiter, but the contrast will become poorer.

● Gamma adjustment

Brightness

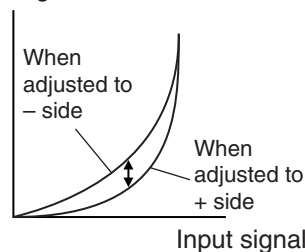

If the setting is changed to the – side, smoother images can be obtained. If the setting is changed to the + side, sharper images can be obtained.

The hue and saturation for each of the red (R), green (G), blue (B), cyan (C) magenta (M) and yellow (Y) colour components can be adjusted to produce images with greater depth.

You can use these adjustments to reproduce the image as if you are watching your favorite movie at a theatre, or even adjust the colours to other completely different colours.

Hue: Adjusts the overall colouration from blues to greens to reds.

Saturation: Adjusts the overall vividness of the images.

Viewing images at a preset image quality (memory function)

After adjusting the projected images using "Picture Quality" and "Color Adjustment", the adjustment values can be saved.

In addition, the saved data can be retrieved easily, so that you can enjoy viewing images with the adjusted settings at any time.

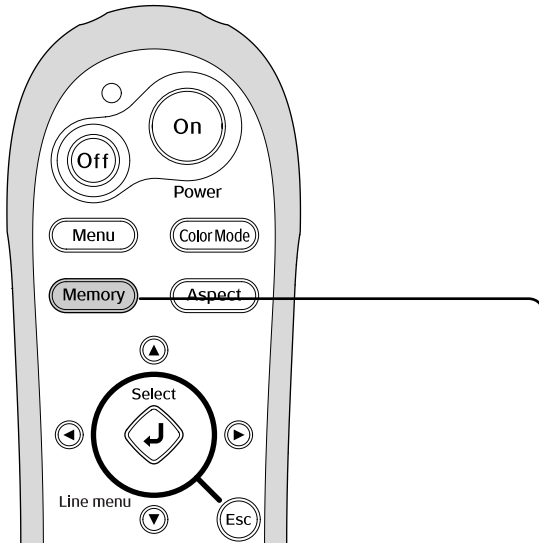

Selection menu operations



Press or on the remote control or or on the projector's control panel to select an item.

Press or to confirm the selection.

* If you press , the selection menu disappears.

Select an item to move to the next menu level for that item.

Saving image quality adjustments (Memory save)

Settings that can be saved in memory

- Configuration menus p.14

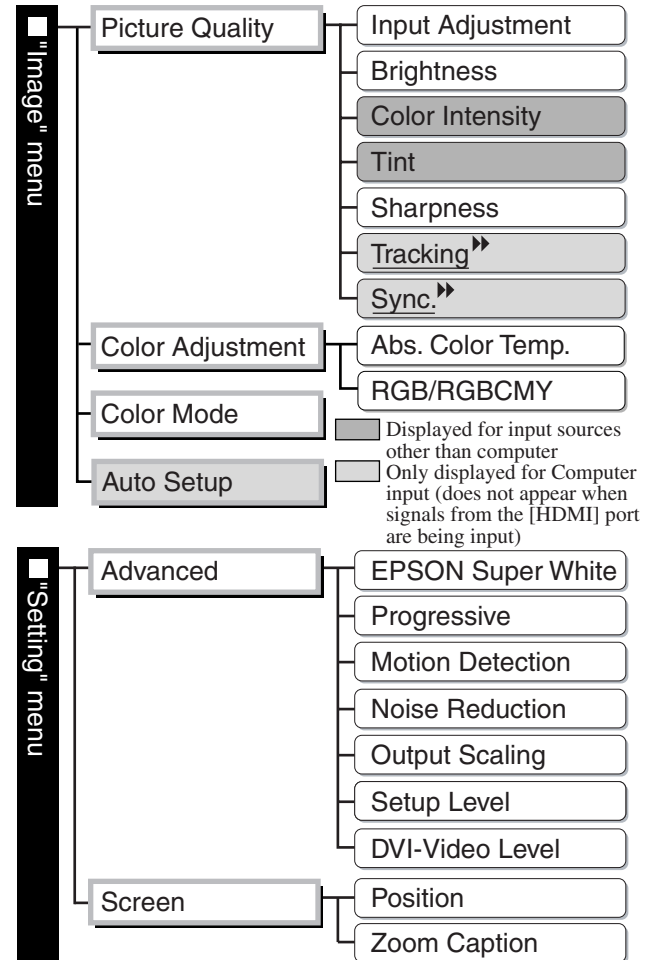

- Aspect setting p.8

Retrieving image quality adjustments (Memory retrieve)



The adjusted values for each of the configuration menu items shown at left and the aspect setting can be saved.

The memory area used to save the settings will vary depending on whether "RGB" or "RGBCMY" is selected in the "RGB/RGBCMY" setting of the "Color Adjustment" sub-menu.

If "RGB" is set : Settings will be saved into "Memory: Standard"

If "RGBCMY" is set : Settings will be saved into "Memory: Advance"



If the Cinema Color Editor has been used to make image adjustments from a computer, these adjustments can also be stored in memory and retrieved from memory. With Cinema Color Editor, the adjusted values can also be saved in files in the computer as well as in memory, so you can store many sets of adjustment values without being limited by the number of memory areas. [p.30](#)

1 Adjust the desired settings that you would like to save in memory.

2 Select "Memory: Standard" in the "Image" menu and then press .
If "RGBCMY" is set, the menu name will change to "Memory: Advance".

3 Select the memory area name you would like to save and then press .

The status of a memory area is indicated by the colour of the  symbol to the left of the memory name as follows.

 Green : Memory area is in use  Grey : Memory area is not in use  Orange : Selected

If you select a memory area that is already in use and press , the existing contents will be erased and the current settings will be saved in the area.

Up to 9 groups of settings can be stored in each of the Standard and Advance memory areas.

To erase all memory contents, select "Memory Reset" from the "Reset" menu. [p.22](#)

You can press  and select the desired memory name from the selection menu. If settings have been saved using both the "Memory: Advance" and the "Memory: Standard" commands, a screen for selecting the "Memory: Standard" or "Memory: Advance" will be displayed. Select the one where the settings that you would like to retrieve are stored between the two.



- Memory settings that have been applied to images will be retained even when the projector's power is turned off. The same memory adjustment settings will be applied to images that are projected the next time the projector's power is turned on.
- The aspect setting retrieved from memory may not be applied to the images if they are 16:9 images or if the input signal images have a particular resolution.
- It may not be possible to change settings for some configuration menu commands depending on the type of memory settings that were retrieved. In such cases, if you select "Last Memory" from the selection menu, the settings will be returned to their initial values before the adjustments were retrieved, and you will then be able to adjust these menu settings.

Configuration Menu Functions

The configuration menus can be used to make a variety of adjustments and settings involving the screen, image quality and input signals.

The following two types of menu are available.

- Full menu

All items in the configuration menu can be checked while the settings are being made.

- Line menu

This lets you adjust "Picture Quality" and "Color Adjustment" settings in the "Image" menu. This menu is useful for viewing the effects of adjustments in the images being projected while the adjustments are being made.

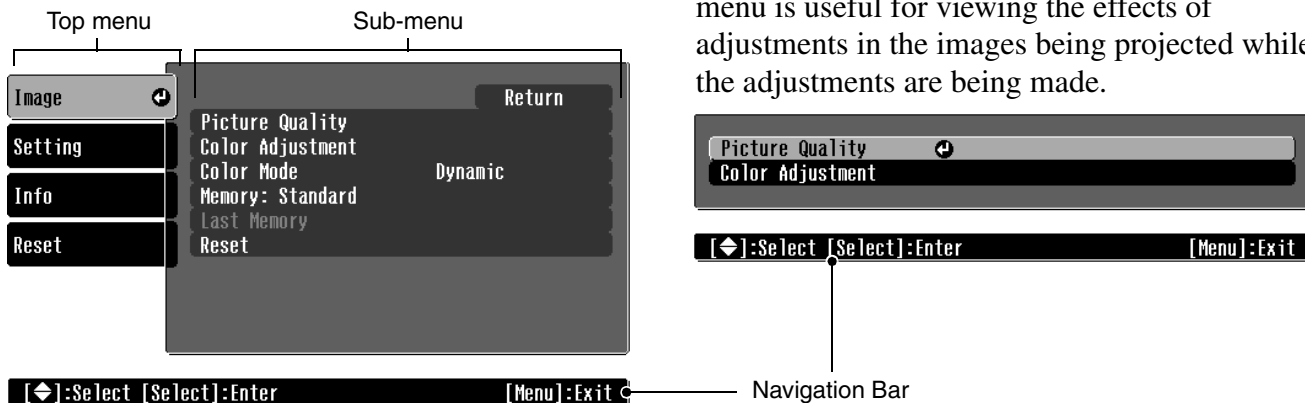

Refer to "Using the configuration menus" (p.23) for details on menu operations.



The configuration menus can be used to turn the navigation bar on and off and to change the colour pattern and display position.

→ "Setting" - "On-Screen Display" - "Menu Position", "Navigation Bar", "Menu Color"

List of Configuration Menus

If no image signals are being input, none of the settings can be adjusted except for "Brightness" in the "Picture Quality" sub-menu of the "Image" menu. The items displayed in the "Image" menu and the "Info" configuration menu will vary depending on the type of image signals that are being projected.

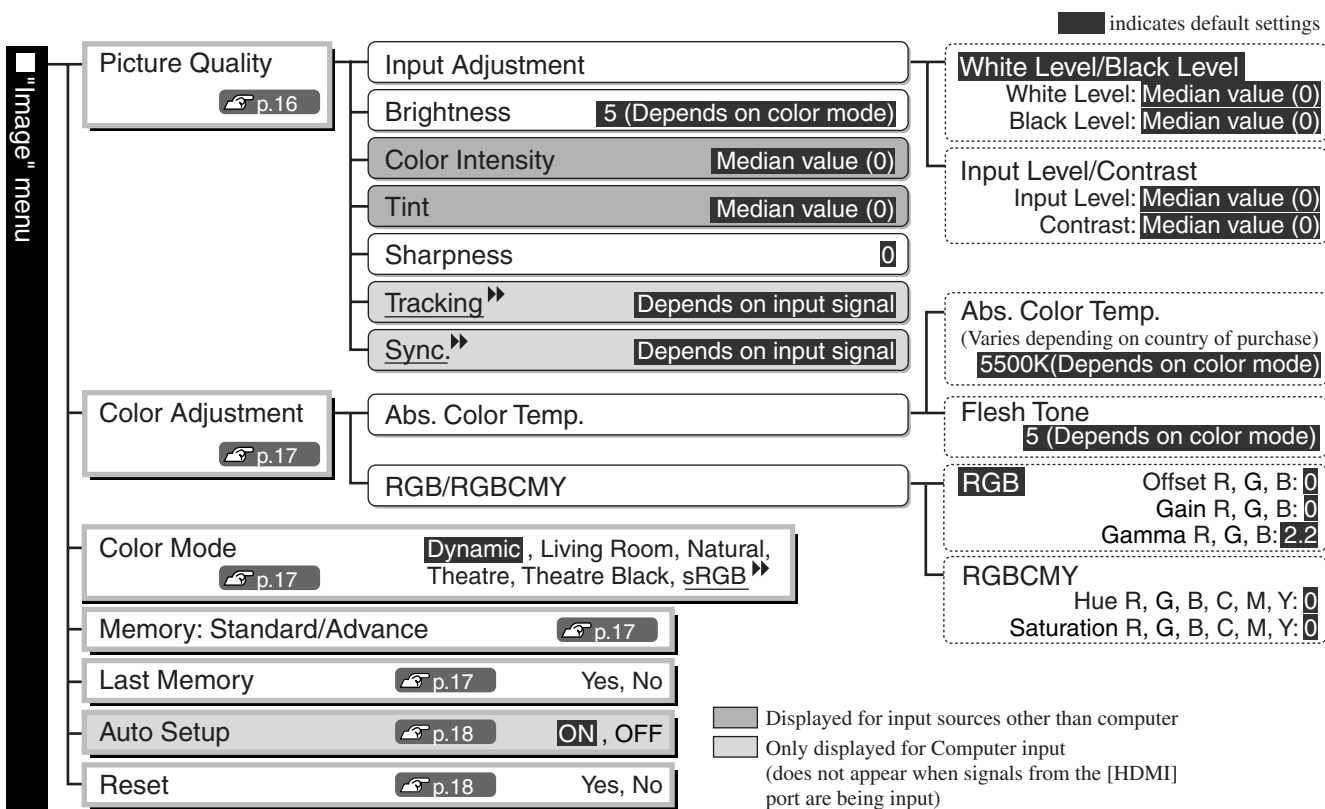

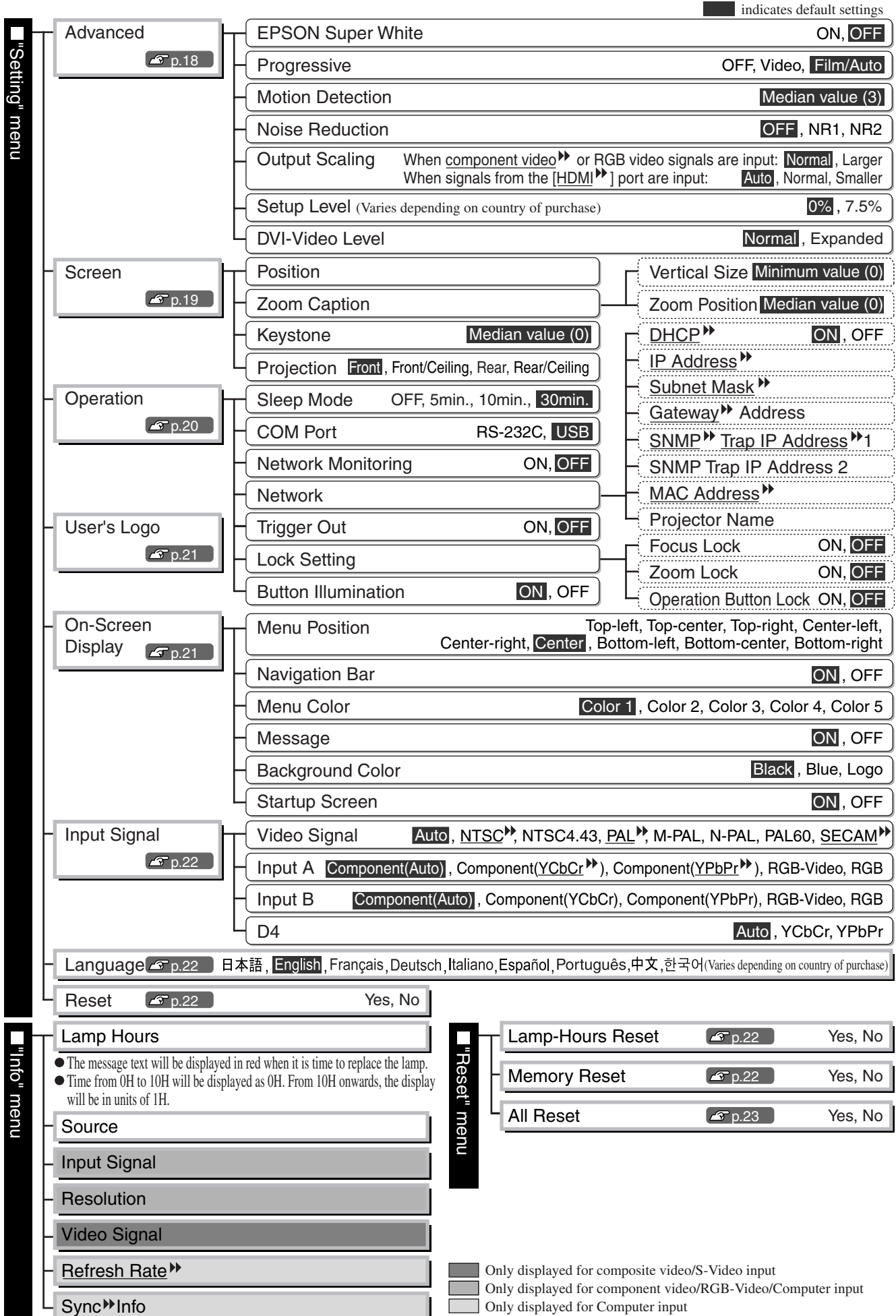

The "Info" menu is only used to display the projector status.

"Image" menu

Displayed for input sources other than computer
 Only displayed for Computer input
 (does not appear when signals from the [HDMI] port are being input)

Picture Quality	Default setting
<p>Input Adjustment *¹</p> <p>These settings can be adjusted if the output level of the connected equipment is weak and the images appear dark. The two settings cannot be made simultaneously. You can only select one of them to be adjusted.</p> <ul style="list-style-type: none"> ● White Level/Black Level: These adjust the dark and light areas of images <ul style="list-style-type: none"> White Level : Adjusts the brightness of bright shades without changing the black level. When the setting is changed to the - side, bright areas become clearer. Black Level : Adjusts the brightness of dark shades without changing the white level. When the setting is changed to the + side, dark areas become clearer. ● Input Level/Contrast: Adjusts the overall brightness of the images. <ul style="list-style-type: none"> Input Level : Adjusts the overall brightness of the images. When the setting is changed to the + side, the images appear brighter overall. Contrast : Adjusts the difference between bright and dark areas. When the contrast is increased, sharper images are obtained. 	<div style="background-color: #cccccc; padding: 5px; margin-bottom: 5px;">White Level/ Black Level</div> <div style="background-color: #e0e0e0; padding: 5px; margin-bottom: 5px;">White Level: Median value (0)</div> <div style="background-color: #e0e0e0; padding: 5px; margin-bottom: 5px;">Black Level: Median value (0)</div> <div style="background-color: #e0e0e0; padding: 5px; margin-bottom: 5px;">Input Level: Median value (0) Contrast: Median value (0)</div>
<p>Brightness *²</p> <p>The brightness of the images can be adjusted. When projecting in dark rooms or onto small screens and the images appear too bright, decrease the setting. If the setting is reduced to 0 or less, power consumption can be reduced by up to approximately 25%.</p>	<div style="background-color: #cccccc; padding: 5px;">5 (Depends on color mode)</div>
<p>Color Intensity *¹</p> <p>This adjusts the colour intensity for the images.</p>	<div style="background-color: #e0e0e0; padding: 5px;">Median value (0)</div>
<p>Tint *¹</p> <p>(Adjustment is only possible when <u>composite video</u>▶▶ or <u>S-Video</u>▶▶ signals in <u>NTSC</u>▶▶ format are being input) This adjusts the image tint.</p>	<div style="background-color: #e0e0e0; padding: 5px;">Median value (0)</div>
<p>Sharpness *¹</p> <p>This adjusts the image sharpness.</p>	<div style="background-color: #e0e0e0; padding: 5px;">0</div>
<p>Tracking▶▶ *¹</p> <p>This adjusts the images if vertical stripes appear in the images.</p>	<div style="background-color: #cccccc; padding: 5px;">Depends on input signal</div>
<p>Sync.▶▶ *¹</p> <p>This adjusts the images if flickering, fuzziness or interference appear in the images.</p> <ul style="list-style-type: none"> ● Flickering and fuzziness may also appear in images when the brightness, contrast, sharpness and keystone correction settings are adjusted. ● Clearer adjustments can be obtained if you adjust the tracking first and then adjust the sync. 	<div style="background-color: #cccccc; padding: 5px;">Depends on input signal</div>

*1 The setting values are stored separately for each image source and signal type.

*2 The setting values are stored separately for each image source and colour mode setting.

Color Adjustment

Default setting

"Color Adjustment" cannot be selected when the colour mode is set to "sRGB▶▶".

Abs. Color Temp. *2

- Abs. Color Temp. : This adjusts the overall tints of the images in accordance with the images being projected. ↗ p.10

5500K
(Varies depending on country of purchase)
(Depends on colour mode)

- Flesh Tone : This adjusts the flesh tones of people who appear in the images. ↗ p.10

5 (Depends on color mode)

RGB/RGBCMY *1

- RGB : This lets you adjust the offset, gain and gamma for each of the R/G/B colour components. ↗ p.10

Offset R/G/B: 0
Gain R/G/B: 0
Gamma R/G/B: 2.2

- RGBCMY : This lets you adjust the hue and saturation for each of the R/G/B/C/M/Y colour components. ↗ p.10

Hue
R/ G/B/C/M/Y: 0
Saturation
R/G/B/C/M/Y: 0

Color Mode *1

Default setting

The color mode can be selected from six different settings in accordance with the images being projected. ↗ p.8

Dynamic

The settings for each mode are given below.

Mode name	Epson Cinema Filter	Gamma	Abs. Color Temp. (default value)	Brightness adjustment (default value)	Flesh Tone adjustment (default value)	Black-white Stretch function
Dynamic	OFF	Original 1	5500k*	+5	5	ON
Living Room	OFF	Original 2	5500k*	+5	5	ON
Natural	ON	2.2× (basic)	6500k	0	3	OFF
Theatre	ON	Original 3	6500k	0	3	OFF
Theatre Black	ON	Original 4	6500k	-5	3	OFF
sRGB	ON	2.2× (basic)	6500k	0	3	OFF

* Varies depending on country of purchase

Memory: Standard/Advance

This can be used to save the current "Image" and "Setting" configuration menu settings and the aspect. The type of memory area used for saving will vary depending on the RGB/RGBCMY adjustments. ↗ p.12

Last Memory *1

It may not be possible to change settings for some configuration menu commands depending on the type of memory settings that were retrieved. In such cases, select "Yes" to return the settings to their initial values before the adjustments were retrieved. You will then be able to adjust these menu settings.

*1 The setting values are stored separately for each image source and signal type.

*2 The setting values are stored separately for each image source and colour mode setting.

Only displayed for Computer input
(does not appear when signals from the [HDMI] port are being input)

Auto Setup *1	Default setting
<p>This sets automatic adjustment to on or off in order to set whether the projector automatically adjusts images to their optimum condition when the input signal is changed.</p>	ON

Reset
<p>This returns all settings in the "Image" menu to their default settings, except for the settings that have been saved using the "Memory: Standard" and "Memory: Advance" commands. The "Memory: Standard" and "Memory: Advance" settings can be reset using the "Memory Reset" menu. p.22</p>

"Setting" menu

Advanced	Default setting
<p>EPSON Super White *1</p> <p>(Setting is only possible if the colour mode has been set to "Natural", "Theatre" or "Theatre Black".)</p> <p>If bright white areas of images such as clouds and T-shirts on the beach in summer appear uneven and overexposed, set to "ON". Input signals containing whites of 100IRE or higher will then be reproduced without overexposure. When set to "ON", the "DVI-Video Level" setting will be ignored.</p>	OFF
<p>Progressive *1</p> <p>(Setting is only possible when <u>composite video</u>▶▶, <u>S-Video</u>▶▶, <u>component video</u>▶▶ or 525i and 625i RGB video signals are being input.)</p> <ul style="list-style-type: none"> ● OFF : Conversion of <u>interlaced</u>▶▶ (i) signals to progressive (p) signals is carried out for each field in the screen. This is ideal for using when viewing images with a large amount of movement. ● Video : IP conversion is carried out. The film judgment function is turned off. This is ideal for general video images. The DCDi function operates. ● Film/Auto : Automatically judges the input source if it is a film source or not. When it is judged as a film, the image equivalent with its original source will be projected. The DCDi function operates. 	Film/Auto
<p>Motion Detection</p> <p>(Setting is only possible when composite video, S-Video, component video and 525i and 625i RGB video signals are being input.)</p> <p>This adjusts the IP conversion settings depending on whether the images contain large amounts of movement or they are still (or slow) images.</p> <p>If a smaller value is selected, flickering is reduced and images become sharper and more detailed, so this is ideal for viewing still images. If a larger value is selected, the movement becomes smoother with less aliasing and so this is ideal for viewing moving images.</p>	Median value (3)
<p>Noise Reduction *1</p> <p>(Setting is only possible when composite video signals or S-Video signals are being input.)</p> <p>This suppresses interference in images and makes the images appear softer. If viewing images with little or no interferences, such as images from DVDs, it is recommended that you change this setting to "OFF".</p>	OFF

Output Scaling *1

(Setting is not possible when composite video or S-Video or analogue-RGB signals are being input.)

This changes the display area (the part of projected images).

- When component video or RGB-video signals are being input
 - Normal (92% display) : Input signals are projected at the normal image size. TV images are displayed at 92% size.
 - Larger (100% display) : The areas at the top, bottom and sides of images that cannot normally be seen are inserted and projected. Interference may occur at the top or bottom of the images depending on the image signal.
- When the [HDMI] port is connected
 - Auto : Signals are automatically projected at 100% or 92% size depending on the input signals. (Not displayed when the equipment's DVI port is connected to the projector's [HDMI] port.)
 - Normal (100% display): Input signals are projected at the full image size.
 - Smaller (92% display) : The edges of the images are truncated when projected. Select this option if there is interference at the top or bottom of the images.

Normal
Auto

Setup Level *1

(Setting is only possible when composite video or S-Video signals in NTSC format are being input or component video has been set. Setting is not possible when signals are being input from the [HDMI] port.)

If using products designed for destinations such as the United States or South Korea that have different black level (setup level) settings, use this function to obtain correct images. Check the specifications of the connected equipment when changing this setting.

0% (Varies depending on country of purchase)

DVI-Video Level *1

(Setting is only possible when RGB video or computer signals are being input from the [HDMI] port.)

If the projector's [HDMI] port is connected to the DVI port of a DVD player or similar equipment using an HDMI/DVI cable, set the video level for the projector to match the video level that has been set at the DVD player. The setting at the DVD player can be either Normal or Expand.

Normal

Screen

Default setting

Position *1

(Setting is not possible when signals are being input from the [HDMI] port.)

Use , , and to move the display position for images.

Zoom Caption *1

If aspect is set to "Zoom" when viewing images with subtitles, change the setting as follows so that the subtitles are displayed. The vertical size and the display position can both be adjusted together.

- Vertical Size
The vertical size of the image is reduced so that the subtitles are displayed.
- Zoom Position
The whole of the image is moved up so that the subtitles are displayed.

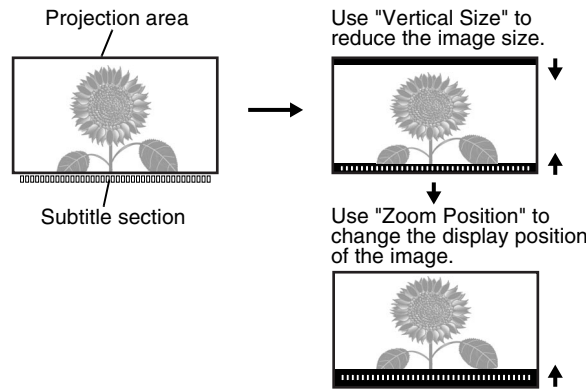

Minimum value (0)
Median value (0)

*1 The setting values are stored separately for each image source and signal type.

Keystone

(If the aspect mode is set to "Wide", keystone correction cannot be set.)
 This is used to correct keystone distortion in images. The same correction can be carried out using the projector's control panel. *Setup Guide*

Median value (0)

Projection

This should be set in accordance with the method used to set up the projector.

- **Front** : Select when the projector is set up in front of the screen.
- **Front/Ceiling** : Select when the projector is set up in front of the screen and suspended from a ceiling.
- **Rear** : Select when the projector is set up behind the screen.
- **Rear/Ceiling** : Select when the projector is set up behind the screen and suspended from a ceiling.

Front

Operation

Default setting

Sleep Mode

The projector is equipped with a power-saving function that causes the power to turn off automatically and the projector to switch to standby if no signal is input to the projector for a continuous length of time. The length of time before the power-saving function operates can be selected from four available settings. If "OFF" is selected, the power-saving function will not operate.

If you press  while the projector is in standby mode, projection will start again.

30min.

COM Port

This selects the port that is used to connect a computer when using the Cinema Color Editor to adjust the picture quality of images from the computer.

If you change the setting, the new setting will take effect after the power has been turned off and the cool-down period is complete.

USB

Network Monitoring

When set to "ON", you can turn the power for the projector on using the remote control window in Cinema Color Editor via the network when the projector is in standby mode. If you would then like to use Cinema Color Editor to adjust the picture quality, check that the projector is projecting images.

If you change the setting, the new setting will take effect after the power has been turned off and the cool-down period is complete.

OFF

Network

This is used to make network settings when connecting the projector to a network in order to use Cinema Color Editor and the SNMP function.

It can also be used for checking the Projector Name and MAC Address which are used for identifying the projector on the network. *Setup Guide* p.27

Trigger Out

This turns the trigger function on and off to determine whether the projector's power on/off status and problems with projector operation are sent to an external device.

If you change the setting, the new setting will take effect after the power has been turned off and the cool-down period is complete.

OFF

Lock Setting

This lets you turn the settings for the various lock functions on and off. When a lock function is on, a  icon appears on the screen when a button is pressed.

- **Focus Lock**: Focus adjustment is disabled.
- **Zoom Lock** : Zoom adjustment is disabled.
- **Operation Button Lock** : If this is set to "ON", you can't operate the projector's control panel buttons. If you change the setting, the new setting will take effect after exiting the configuration menu.

OFF

OFF

OFF

Button Illumination

- **ON** : The area around the control panel buttons and characters light when the projector's power is turned on. This allows you to operate the projector in a dark room.
- **OFF** : When set to "OFF", the lights for the area around the control panel buttons and characters are all turned off while images are projected.

ON

User's Logo

Default setting

You can record your favorite image as a user's logo. The logo will be projected when projection starts and when using the blank function. When a user's logo is recorded, the previous user's logo will be erased. Follow the instructions on the screen to record a user's logo.

Selection frame

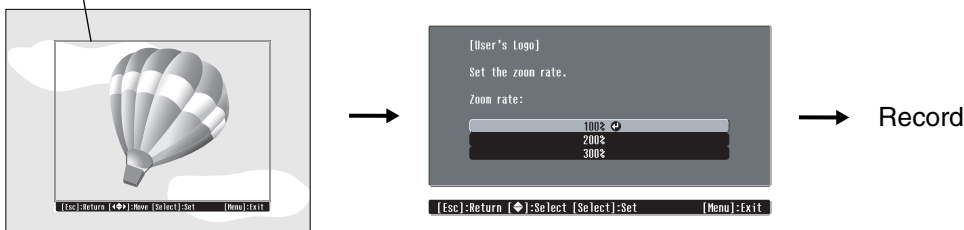

Move the selection frame so that the area of the image to be recorded is inside the frame.

Select the display ratio.

- The image will be displayed in dot format while the selection frame is displayed, therefore the display size may change.
- The size of the recorded image is 480 × 360 dots.
- Once a user's logo has been recorded, you cannot return the logo to the default setting.
- To use the recorded user's logo, set "Background Color" to "Logo".

EPSON

On-Screen Display

Default setting

Menu Position

Press , , and to specify the menu display position.

Center

Navigation Bar

This sets whether the navigation bar for the configuration menus is displayed (ON) or not displayed (OFF).

ON

Menu Color

The colour for the main configuration menu (full menu) and the navigation bar can be selected as follows.

- Color 1 : Grey
- Color 2 : Blue
- Color 3 : Green
- Color 4 : Red
- Color 5 : Purple

Color 1

Message

This sets whether the following message is displayed (ON) or not displayed (OFF).

- Item names such as Image Signal, Color Mode and Aspect when memory settings are retrieved
- Messages such as when no image signals are being input, when an incompatible signal is input, and when the internal temperature rises

ON

Background Color

Selects the screen status for the start-up screen (the image to be projected when projection starts) and the screen when the blank function is on.

Black

Startup Screen

This sets whether the start-up screen (the image that is projected when projection starts) is displayed (ON) or not displayed (OFF).
If you change the setting, the new setting will take effect after the power has been turned off and the cool-down▶▶ period is complete.

ON

Input Signal

Default setting

Video Signal

Sets the signal format in accordance with the video equipment that is connected to the [Video] or [S-Video] port. If set to "Auto", the video signal format is set automatically. If there is a lot of interference in the image, or if a problem such as no image being projected occurs even though "Auto" has been selected, select the correct signal format manually.

Auto

Input A

Input B

Sets the signal format in accordance with the video equipment that is connected to the [InputA] or [InputB] port or the signal being output from a computer. If a component video▶▶ source is connected, the video signal format is set automatically when "Component(Auto)" is selected. If "Component(Auto)" is selected and the colours appear unnatural, select the appropriate signal.

Component(Auto)

D4

This sets the signal format in accordance with the signals being output from video equipment that is connected to the [D4] port. If set to "Auto", the setting is made automatically. If "Auto" is selected and the colours appear unnatural, select the appropriate signal.

Auto

Language

Default setting

This sets the display language for messages and menus.

English
(Varies depending on country of purchase)

Reset

This resets all "Setting" menu settings to their default settings except for the "Network", "User's Logo", "Input Signal" and "Language" settings.

"Reset" menu

Lamp-Hours Reset

This initialises the lamp operating time. When this command is selected, the cumulative operating time for the lamp is cleared and returned to the default setting.

Memory Reset

This resets (erases) all settings that have been saved in the "Memory: Standard" and "Memory: Advance" commands.

All Reset

This resets all configuration menu settings to their default settings. The "Memory: Standard", "Memory: Advance", "Network", "User's Logo", "Input Signal", "Lamp Hours" and "Language" settings will not be reset.

Using the Configuration Menus

1 Displaying a menu

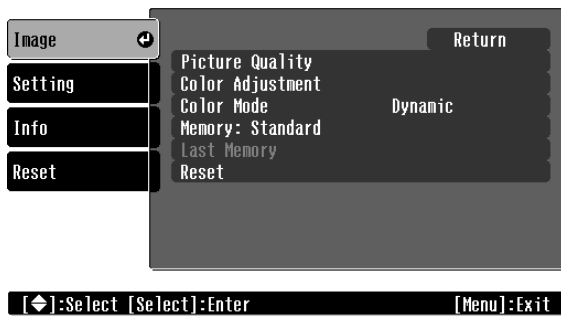

Full menu: Press .

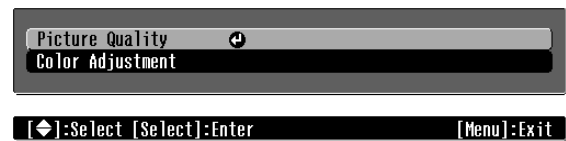

Line menu: Press  or .



2 Selecting a menu item

Use  and  to select a menu item, then press .



3 Changing settings



Example:

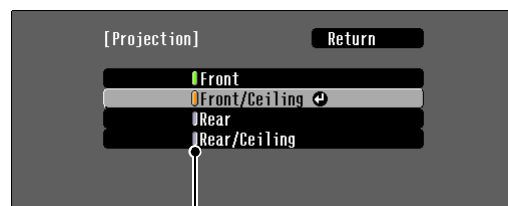



Use  and  to adjust values.



-  (green): Current setting value
-  (orange): Currently-selected item

Use  and  to select an item, then press .

If you press  when an item with  next to it is selected, the selection screen for that item will be displayed.

To return to a previous screen, press  or select [Return] and then press .

4 When setting is complete

Press .

Installing Cinema Color Editor

If any other applications are open, close them before installing Cinema Color Editor.

1 Insert the accessory Cinema Color Editor CD-ROM into your CD-ROM drive.

Windows: The installer will start automatically.

Macintosh: Click the "Installer for Mac OS Classic" icon or the "Installer for Mac OS X" icon in the "EPSON" window, depending on the operating system you are using.

A virus check program window will be displayed, so check the contents of this window and then click [Continue].

The software verification window will be displayed.

● Windows

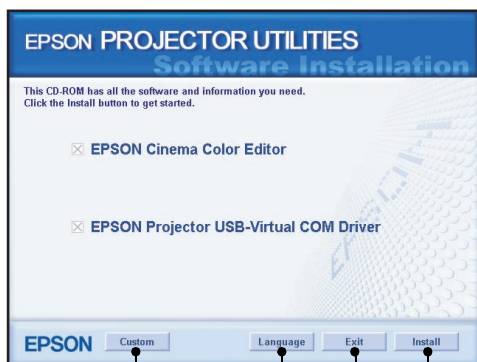

Select the software to be installed
Change the display language
Close the installer
Start installation

● Macintosh

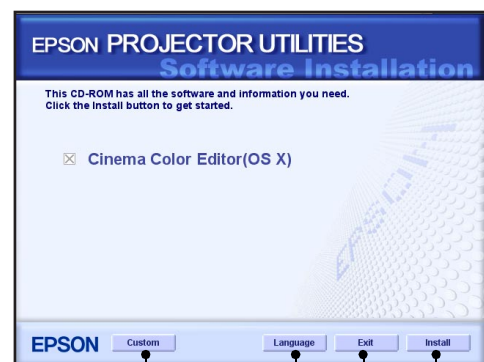

Select the software to be installed
Change the display language
Close the installer
Start installation



If using Windows:

- If the computer is connected by means of a USB cable, be sure to install the USB driver (EPSON Projector USB-Virtual COM Driver).
- If the setup program does not start automatically, click [Start] - [Run] and then open the "Browse" dialogue box and select "[CD-ROM drive]:\Epsetup.exe" and then click [OK].

2 Check the settings and then click [Install].

Installation will start. Follow the instructions which appear on the screen to complete the installation.

3 Click [Exit] to finish the installation.

If using a Macintosh a message prompting you to restart the computer may be displayed. If this happens, follow the instructions in the message and restart your computer.

Uninstalling Cinema Color Editor

If you no longer require Cinema Color Editor, uninstall it by following the procedure below.

● Windows

From My Computer, open the Control Panel, double-click "Add or Remove Programs", select "Cinema Color Editor", and then click Add/Remove] (or [Change/Remove] for Windows XP).

● Macintosh

Follow the instructions that are displayed on the screen until the following window is displayed.

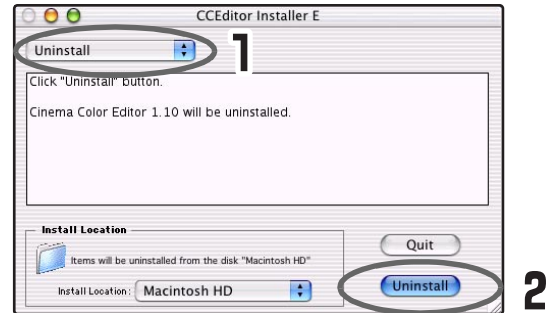

1 Select Uninstall.

2 Click [Uninstall].

Connecting to a Computer

In order to use the Cinema Color Editor to adjust picture quality, connect the projector and the computer using a USB cable, an RS-232C cable or a network cable.

Connection using a network cable

The projector can be connected to a network using a commercially-available 100baseTX or 10baseT network cable. You must use a Category 5 shielded twisted-pair cable to connect the network to prevent malfunction.

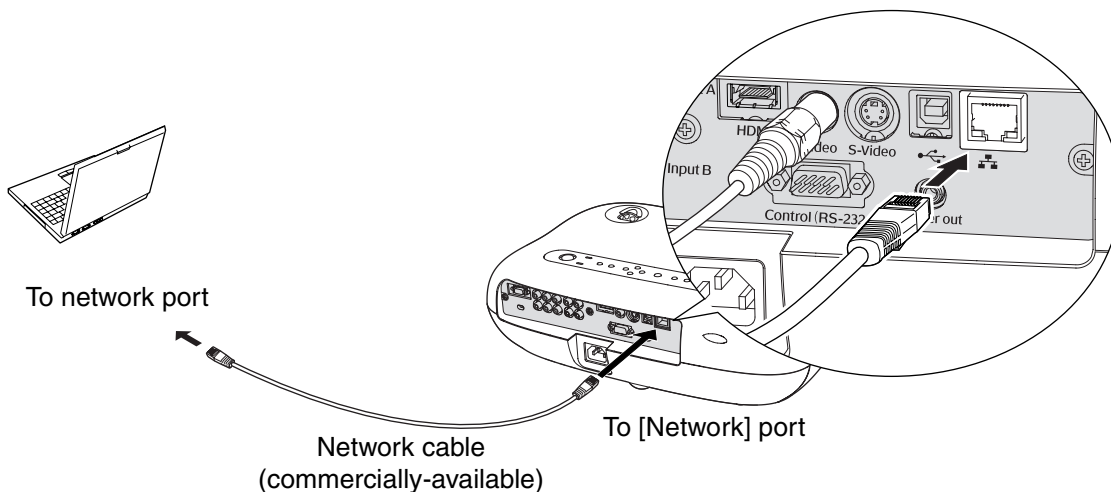

Connection using a USB cable or RS-232C cable

If connecting using a USB cable, you should install Cinema Color Editor before connecting the cable.

If using an RS-232C cable, use a cross-type cable.

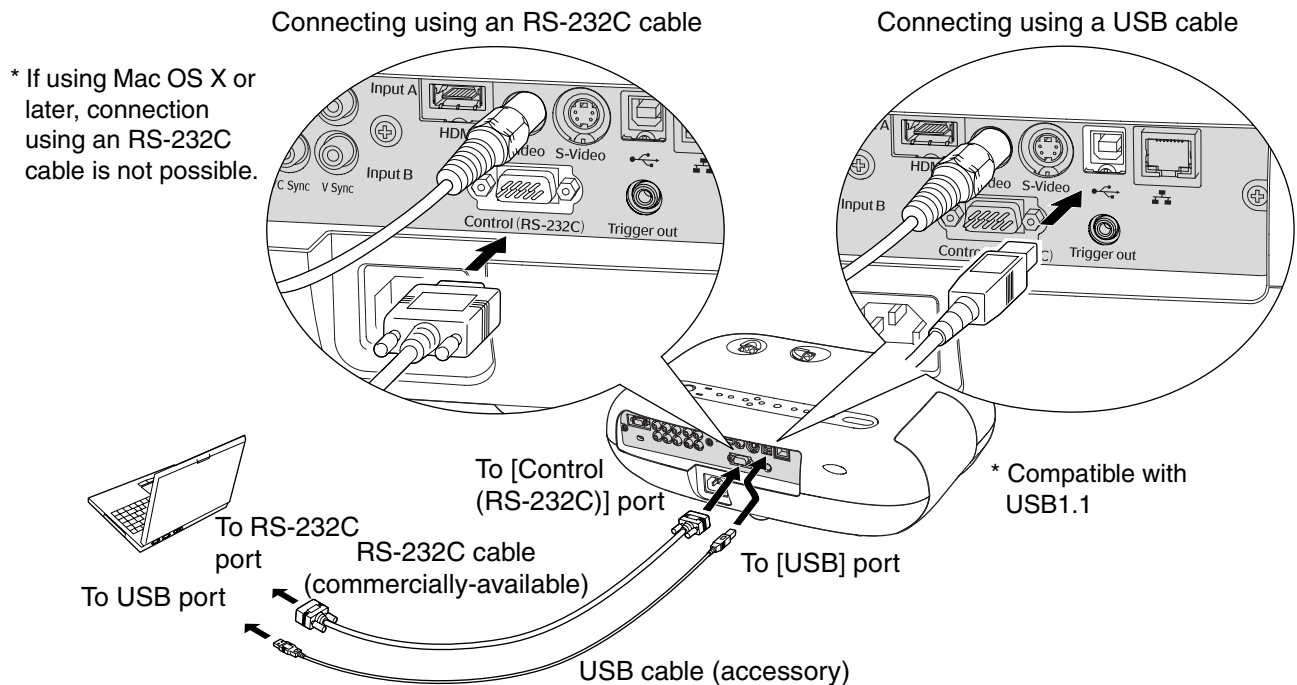

- If the "Add New Hardware Wizard" starts up or a message such as "Software needed for the USB device is not available." appears when you connect a Windows computer and the projector using a USB cable, click [Cancel] in the wizard window or the dialogue box. Disconnect the USB cable, install Cinema Color Editor and then reconnect the cable.
- Use the "COM Port" command in the "Operation" sub-menu of the "Setting" menu to select the port that is being used for the connection. Default setting: USB p.20

Connection settings at the projector (when using a network connection)

When the projector is connected to the network, make the network settings as follows.

1 Press and use the configuration menus to select "Setting" - "Operation" - "Network".

2 Use and to select the item to be set, and then press .

For details on this operation, refer to "Using the Configuration Menus". p.23

Setting details

Set the following items depending on the network environment that is used.





The settings for the computer will vary depending on the operating system being used. Refer to the computer documentation for details on the setting method.

■ When connecting directly to a computer

<u>DHCP</u> »»	Set DHCP to "OFF".
<u>IP Address</u> »»	Enter a private IP address. Example: 192.168.0.1 – 192.168.255.254 Set an IP address that does not overlap with the computer's IP address.
<u>Subnet Mask</u> »»	For example, set to 255.255.255.0.
<u>Gateway</u> »» Address	Enter the same address as the computer's IP address.
<u>SNMP</u> »» <u>Trap IP Address</u> »» 1/2	Two IP addresses can be set as notification addresses for SNMP traps. To use the SNMP function to monitor the projector, you will need to have an SNMP manager program installed on the computer. Ask the network administrator to do this step. If a notification cannot be sent to the IP address that has been set for "SNMP Trap IP Address 1", then it is sent to the IP address that has been set for "SNMP Trap IP Address 2".
<u>MAC Address</u> »»	This shows the MAC address for the projector.
Projector Name	This shows the individual name used for the projector to identify it on the network.

■ When connecting to a computer that is permanently connected to the Internet

<u>DHCP</u> »»	Set DHCP to "ON". If the DHCP function cannot be used or if assigning a static IP address, select "OFF".
<u>IP Address</u> »»	If "DHCP" is set to "ON", these items are set automatically, and so you do not need to set them yourself.
<u>Subnet Mask</u> »»	If "DHCP" is set to "OFF", enter the address specified by your Internet Service Provider.
<u>Gateway</u> »» Address	
<u>SNMP</u> »» <u>Trap IP Address</u> »» 1/2	Two IP addresses can be set as notification addresses for SNMP traps. To use the SNMP function to monitor the projector, you will need to have an SNMP manager program installed on the computer. Ask the network administrator to do this step. If a notification cannot be sent to the IP address that has been set for "SNMP Trap IP Address 1", then it is sent to the IP address that has been set for "SNMP Trap IP Address 2".
<u>MAC Address</u> »»	This shows the MAC address for the projector.
Projector Name	This shows the individual name used for the projector to identify it on the network.

If changing a numeric value, a cursor will be displayed, so use  and  to move the cursor to the value to be changed and use  and  to display the desired value.

Once the desired value is displayed, press  to accept the setting.



The following software is provided to allow you to monitor and control the status of projectors over a network.

- **EMP NetworkManager:** You can set destination addresses for the "Mail Notification function" to use for sending e-mail messages to notify the computer operator when a problem occurs with a projector.
- **EMP Monitor:** This lets you monitor the status of more than one projector on the network and to run batch operations such as turning projector power on and off and changing signal sources from a computer's monitor screen.

For details on acquiring the software, please visit the following web site:

<http://www.epson.co.uk/support/download/>

Using Cinema Color Editor

You can use the Cinema Color Editor to easily adjust the picture quality of projector images and to operate projectors. The following information describes how to use the Windows edition of the program. The Macintosh edition works in basically the same way.

Starting Cinema Color Editor

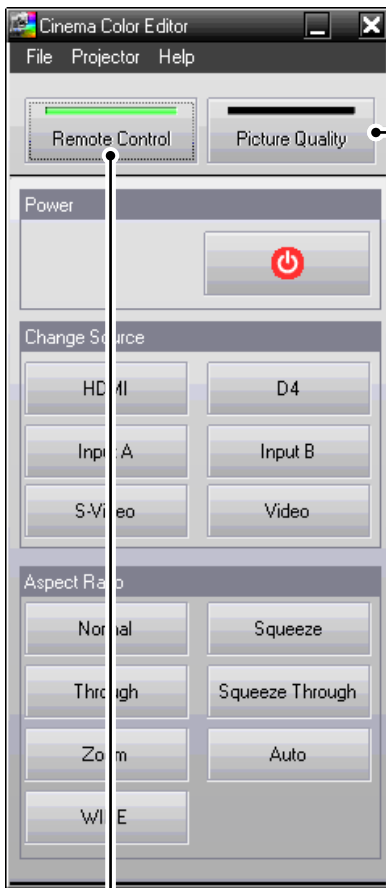
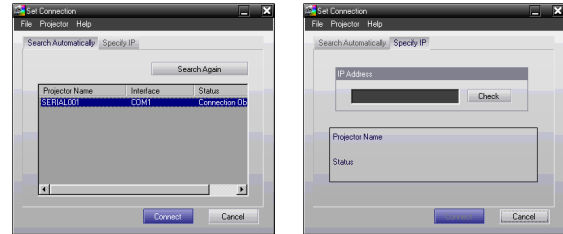

Click to go to picture quality window

Click to go to remote control window

Adjusting picture quality

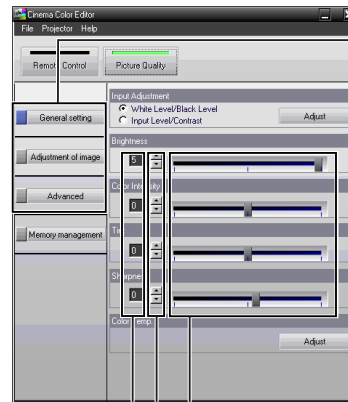

Switches the picture quality adjustment screen

Drag the gauge button to the left or right to adjust. *

Click to increase or decrease the value. Type in a value and press the [Enter] or [Return] key on your computer keyboard.

* The adjustment will be applied to the images after the gauge is adjusted and you release the mouse button.

Operating the projector

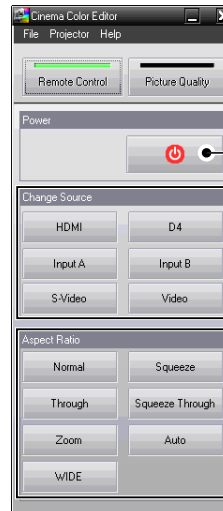

Lets you carry out the same operations as the accessory remote control.

Power ON/OFF

Input source selection
 Setup Guide

Aspect selection p.8

If using a USB cable or an RS-232C cable to connect the projectors to the computer, check that the power for the projector you would like to adjust is turned on, and then start Cinema Color Editor.

For Windows :Click "Start" →"Programs" →"EPSON Projector" →"Cinema Color Editor" in this order.

For Macintosh :Click the "Finder" icon on the dock, then click "Macintosh HD" and then "Applications", and then double-click "CCEditor V1.1" and "Cinema Color Editor" in that order.

After the opening screen, the connection screen will be displayed.

A list of the connected projectors will be displayed, so select the projector that you would like to use for picture quality adjustment and then click [Connect]. In addition, if the projector is connected to a different network from the computer (for example, via a router), the projector will not be displayed automatically. Use the "Specify IP" tab to directly enter the IP address that has been set for the projector, and then click [Check]. The projector name will be displayed, so click [Connect]. If the projector name is not displayed, check that the projector is correctly connected to the network. p.25, p.39

Projector picture quality adjustments can be easily carried out by using the mouse.

Items that can be set

Click a button at the left of the window to carry out the following adjustments. The same adjustment as the corresponding configuration menu command can be carried out. p.14

General setting

- White Level/Black Level
- Input Level/Contrast
- Brightness
- Color Intensity
- Tint
- Sharpness
- Abs. Color Temp.
- Tracking
- Sync.

Adjustment of image

- Color Mode
- Color Adjustment

Advanced

- EPSON Super White
- Progressive
- Motion Detection
- Noise Reduction
- Output Scaling
- Setup Level
- DVI-Video Level
- Auto Setup

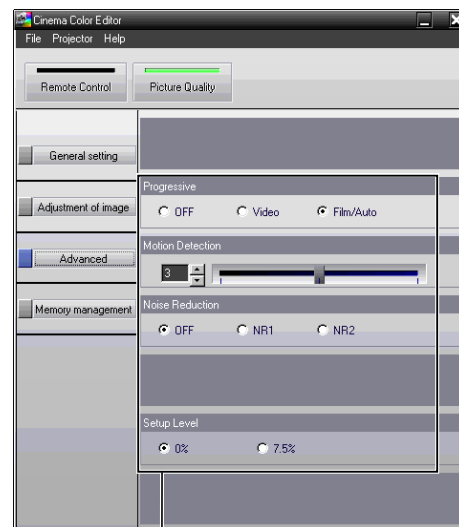

Click the item to be set.

Saving adjustments/Loading adjustments from a file

The adjustment settings of the projected images can be saved as computer files. The adjustments stored in these files can then be reloaded and applied to the projected images. In addition, these files can be sent to other people so that they can view the effects of your adjustments. You can also load the adjustment settings from a computer file into the projector memory and retrieve them. p.30

Saving files and applying settings is done from the "File" menu.

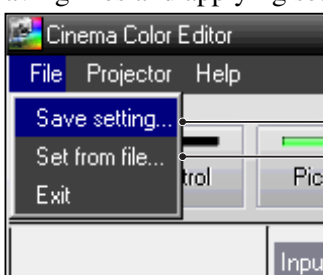

Saves current projector settings in a file.

Adjustment values saved in the file are applied to the currently projected images.

Click 

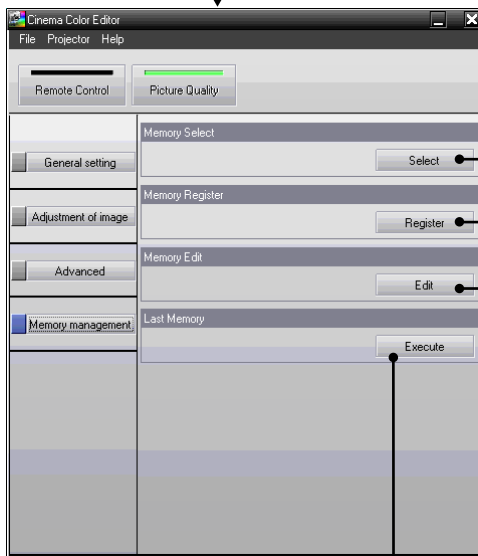

Operates in the same way as the projector's Last Memory function.
 p.17

Loads settings from a memory area
 Saves adjustments into a memory area

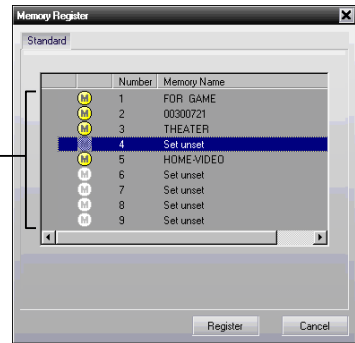

Saving customised settings into memory

Saving adjustment values into memory



Memory list

Indicates the projector memory status.

-  (yellow): In use
-  (grey): Not in use

Saving/loading memory settings and editing memory area names

Memory list

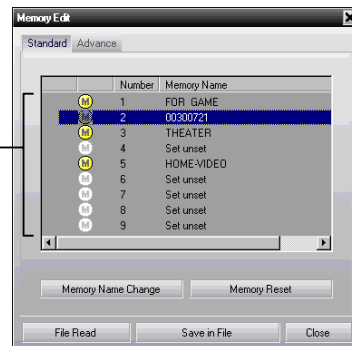

Saving adjustment values from the projector's memory onto the computer

- 1** Select the memory area to be used for saving using the memory list.
- 2** Click [Save in File].
- 3** Select the saving location, type in a filename and then click [Save].
 If a file with the same name already exists, a message will be displayed.

Loading adjustment values from a saved file into projector memory

- 1** Select a memory number for saving from the memory list.
- 2** Click [File Read].
- 3** Select the file to be loaded in the file selection window, and then click [Open].
 If the saved memory area is selected, a message will be displayed.

- 1 Make the desired adjustments.
- 2 Select the memory area to be used.

The following two types of memory area are available, and up to 9 sets of adjustment settings can be saved in each. The type of memory area will vary depending on the "Color Adjustment" settings.

Standard

When "Color Adjustment" has been set with "RGB"

Advance

When "Color Adjustment" has been set with "RGBCMY"

- 3 Select the memory area to be used for saving from the memory list, and then click [Register].

Retrieving saved memory settings

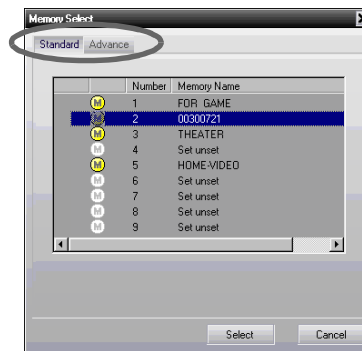

- 1 Click the "Standard" or "Advance" tab to select the type of memory.
- 2 After selecting the memory area to be retrieved from the memory list, click [Select]. The selected adjustment values will be applied to the images.

"Memory Edit" allows you to easily carry out the following processes.

Saving projector memory settings into a computer as a memory data file

Loading memory data files from a computer into projector memory

Computer files can be loaded into the projector's memory. You can store adjustment values in the computer without limitation in contrast to the projector's memory.

Load the values stored on your computer into the projector's memory area as needed.

Changing a memory area names

The preset names such as "Memory1" and "MemoryA" can be changed to names that are more descriptive of the memory area's contents. Even if you have stored a large number of memory settings in the computer, you can easily retrieve the desired settings.

Initialising memory

Memory settings that you no longer need can be selected and deleted one by one.

Changing a memory area name

- 1 Select the name to be changed from the memory list.
- 2 Click [Memory Name Change].
- 3 In the "Memory Name Change" window, type in a memory name of up to 12 characters.

The characters that can be entered include alphanumeric characters, the space character and some punctuation characters.

e.g. ! " % & ' () * + , - .

- 4 After typing in the name, click [OK].

Initialising a memory area

- 1 Select the memory area to be initialised from the memory list.
- 2 Click [Memory Reset].
- 3 At the confirmation window, click [OK].

Reading the Indicators

The projector is provided with the following three indicators which notify you of the operating status of the projector. The following tables show what the indicators mean and how to remedy the problems that they indicate.

*If the  indicator does not light when the power is turned on, the power cable may not be connected correctly or the power may not be supplied.

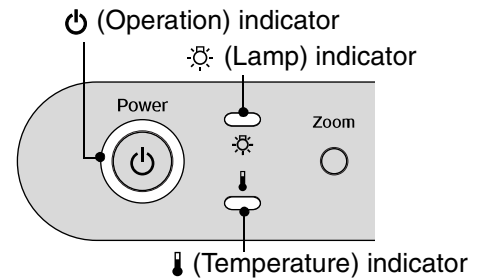

When the indicator is lit or flashing red **Abnormal**

 : Lit  : Flashing  : Off

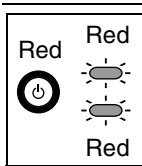

Internal problem

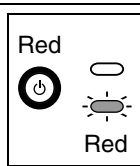

Fan problem/ Sensor problem



Disconnect the power cable from the electrical outlet. Then contact your dealer or the nearest address provided in the "International Warranty Conditions" section of the *Safety Instructions/World-Wide Warranty Terms* booklet.

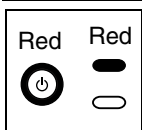

Lamp problem/ Lamp cover is open error

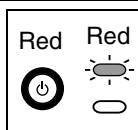

Lamp on error

Check if the lamp is broken or if the lamp cover is installed securely.  p.42

If the lamp is not broken

Replace the lamp and then turn the power on.

If the problem is still not solved after the lamp is replaced, stop using the projector and disconnect the power cable from the electrical outlet. Then contact your dealer or the nearest address provided in the "International Warranty Conditions" section of the *Safety Instructions/World Wide Warranty Terms* booklet.

If the lamp is broken

Contact your local dealer for further advice.

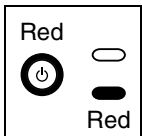

Internal temperature error (overheating)

The lamp will switch off automatically and projection will stop. Wait for approximately 5 minutes.

- When installing against a wall, leave a space of 20 cm (7.9 in.) or more between the projector and the wall.
- Clean the air filters if they are clogged.  p.40

If the problem is not solved when the power is turned back on, stop using the projector and disconnect the power cable from the electrical outlet. Then contact your dealer or the nearest address provided in the "International Warranty Conditions" section of the *Safety Instructions/World-Wide Warranty Terms* booklet.

When the or indicator is flashing orange **Warning**

 : Lit  : Flashing  : Off

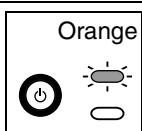

Lamp replacement notification

The lamp is near the end of its operating life. Replace the lamp with a new one as soon as possible.  p.42

If you continue to use the old lamp, the possibility that the lamp may break will increase. The  indicator will vary depending on the projector status at the time.

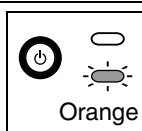





High-speed cooling in progress

You can continue using the projector, but if the temperature rises too high again, the projector will be switched off automatically. Follow the same remedy as for "Internal temperature error (overheating)" above.

The  indicator will vary depending on the projector status at the time.

When the indicator is lit or flashing green or orange **Normal**

 : Lit  : Flashing  : Off

<p>Orange</p> 	<p>Standby mode If you press , projection will start after warm-up is complete.</p>	<p>Green</p> 	<p>Projection in progress Normal operation is in progress. *If the "Button Illumination" configuration menu command is set to "OFF", they will not light. ↗ p.21</p>
<p>Green</p> 	<p>Warm-up in progress Warm-up time is approximately 45 seconds. Power off operations are ignored while warm-up is in progress.</p>	<p>Orange</p> 	<p>Cool-down^{▶▶} in progress Cool-down time is approximately 30 seconds. After cool-down is complete, the projector goes to standby mode. You cannot use the remote control or the projector's control panel during cool-down.</p>

When the Indicators Provide No Help

If any of the following problems occur and the indicators do not offer a solution, refer to the pages given for each problem.

Problems relating to images

- No images appear [↗ p.34](#)
Projection does not start, the projection area is completely black, the projection area is completely blue, etc.
- The message "Not Supported." is displayed [↗ p.34](#)
- The message "No Signal." is displayed [↗ p.35](#)
- Images are fuzzy or out of focus [↗ p.35](#)
- Interference or distortion appear in images [↗ p.36](#)
Problems such as interference, distortion or black & white checked patterns appear.
- Image is truncated (large) or small [↗ p.36](#)
Only part of the image is displayed.
- Image colours are not right [↗ p.37](#)
The whole image appears purplish or greenish, images are black & white, colours appear dull, etc.
(Computer monitors and LCD screens have different colour reproduction performance, so that the colours projected by the projector and the colours appearing on the monitor may not necessarily match, but this is not a sign of a problem.)
- Images appear dark [↗ p.37](#)
- Projection stops automatically [↗ p.37](#)

Problems when projection starts

- Power does not turn on [↗ p.38](#)

Problems with the remote control





- The remote control does not work [↗ p.38](#)

Problems with network connections

- Projector cannot be recognized [↗ p.39](#)

Problems relating to images

■ No images appear

Have you pressed the [Power] button?	Press  on the remote control or  on the projector's control panel.
Was the  indicator lit orange before the power was turned on?	Disconnect the power cable and then reconnect it. <i>☞ Setup Guide</i> Check the circuit breaker to see if power is being supplied.
Is blank mode active?	Press  on the remote control to cancel the blank function.
Is a video signal being input?	Check if the power for the connected equipment is turned on. If the "Message" menu command has been set to "ON", messages relating to the image signals will be displayed. <i>☞ "Setting" - "On-Screen Display" - "Message" p.21</i>
Are the image signal format settings correct?	Use the "Video Signal" menu command to select the signal format which matches the connected signal source. <i>☞ "Setting" - "Input Signal" - "Video Signal" p.22</i>
Have the configuration menu settings been made correctly?	Try resetting all of the current settings. <i>☞ p.23</i>
Were the projector and the computer connected while their power was turned on? <div style="background-color: black; color: white; padding: 2px; text-align: center; margin-top: 5px;">Only when projecting computer images</div>	If the connection is made while the power is already turned on, the function (Fn) key that switches the computer's video signal to external output may not work. Turn off the power for the projector and the computer and then back on again.
Is the computer display output set to only the computer's accessory screen? <div style="background-color: black; color: white; padding: 2px; text-align: center; margin-top: 5px;">Only when projecting computer images</div>	The image signals need to be output externally. Change the output setting to an external destination only or to an external destination as well as the computer's own monitor. <i>☞ Computer documentation, under a title such as "External output" or "Connecting an external monitor"</i>

■ The message "Not Supported." is displayed

Are the image signal format settings correct?	If a <u>composite video</u> ^{▶▶} or <u>S-Video</u> ^{▶▶} signal is being input If projection does not occur when the "Video Signal" menu command is set to "Auto", select the signal format that matches the signal source. <i>☞ "Setting" - "Input Signal" - "Video Signal" p.22</i>
	If connected to the [InputA] or [InputB] port Check that the connectors of the connection cable are inserted into the correct ports. <i>☞ Setup Guide</i>
Does the mode match the frequency and resolution of the image signals? <div style="background-color: black; color: white; padding: 2px; text-align: center; margin-top: 5px;">Only when projecting computer images</div>	Use the "Resolution" menu command to check the signals being input, and check the "List of Supported Monitor Displays" to make sure that the signals are compatible. <i>☞ "Info" - "Resolution" p.15</i> <i>☞ "List of Supported Monitor Displays" p.45</i>

■ The message "No Signal." is displayed

Are the cables connected correctly?	Check that all of the cables required for projection are securely connected. <i>☞ Setup Guide</i>
Has the correct video input port been selected?	Press D4 , Input A , Input B , HDMI , S-Video or Video on the remote control or Source on the projector's control panel to change the image source. <i>☞ Setup Guide</i>
Is the power for the connected equipment turned on?	Turn the power on for the devices.
Are the image signals being output to the projector? <div data-bbox="212 600 560 772" style="background-color: #333; color: #fff; padding: 5px; margin-top: 10px;"> <p>Only when projecting images from a laptop computer or computer with a built-in LCD screen</p> </div>	<p>If the image signals are only being output to the computer's LCD monitor or to the accessory monitor, you need to change the output. For some computer models, when the image signals are output externally, they no longer appear on the LCD monitor or accessory monitor.</p> <p><i>☞</i> Computer documentation, under a title such as "External output" or "Connecting an external monitor"</p> <hr/> <p>If the connection is made while the power is already turned on, the function [Fn] key that switches the computer's video signal to external output may not work. Turn the power for the projector and the computer off and then back on again. <i>☞ Setup Guide</i></p>

■ Images are fuzzy or out of focus

Has the focus been adjusted correctly?	Adjust the focus. <i>☞ Setup Guide</i>
Is the lens cover still attached?	Remove the lens cover.
Is the projector at the optimum distance?	The recommended distance from the projector to the screen is within 87–1365 cm (2.9–44.8 ft.) for a screen size of 16:9, and 108–1672 cm (3.6–54.9 ft.) for a screen size of 4:3. Set up the projector so that the projection distance is within this range. <i>☞ Setup Guide</i>
Is the keystone adjustment value too large?	Decrease the projection angle to reduce the amount of keystone correction. <i>☞ Setup Guide</i>
Has condensation formed on the lens?	If the projector is suddenly taken from a cold environment to a warm environment or if sudden ambient temperature changes occur, condensation may form on the surface of the lens, and this may cause the images to appear fuzzy. Set the projector up in the room approximately one hour before it is to be used. If condensation forms, disconnect the cable and let the projector stand for a while.



■ Interference or distortion appear in images

<p>Are the image signal format settings correct?</p>	<p>If a <u>composite video</u> or <u>S-Video</u> signal is being input If projection does not occur when the "Video Signal" menu command is set to "Auto", select the signal format that matches the signal source. ☞ "Setting" - "Input Signal" - "Video Signal" p.22</p> <p>If connected to the [InputA] or [InputB] port Check that the connectors of the connection cable are inserted into the correct ports. ☞ <i>Setup Guide</i></p>
<p>Are the cables connected correctly?</p>	<p>Check that all of the cables required for projection are securely connected. ☞ <i>Setup Guide</i></p>
<p>Is an extension cable being used?</p>	<p>If an extension cable is used, interference may increase. Try connecting a signal amplifier.</p>
<p>Have the "Sync." and "Tracking" settings been adjusted correctly?</p> <p>Only when projecting computer images</p>	<p>The projector has an automatic adjustment function that causes the optimum images to be projected. However, for some types of signal, the correct adjustments may not be obtained even after automatic adjustment is carried out. In such cases, use the "Tracking" and "Sync." menu commands to make the adjustments. ☞ "Image" - "Picture Quality" - "Tracking", "Sync." p.16</p>
<p>Has the correct resolution been selected?</p> <p>Only when projecting computer images</p>	<p>Set the computer so that the output signals are compatible with this projector. ☞ "List of Supported Monitor Displays" p.45, Computer documentation</p>

■ Image is truncated (large) or small

<p>Has the correct aspect been selected?</p>	<p>Press  to select the aspect that corresponds to the input signal. ☞ p.8 If images with subtitles are being projected using "Zoom", use the "Zoom Caption" menu command to adjust the images. ☞ p.19</p>
<p>Has the "Position" setting been adjusted correctly?</p>	<p>Use the "Position" menu command to make the adjustment. ☞ "Setting" - "Screen" - "Position" p.19</p>
<p>Has the computer been set for dual display?</p> <p>Only when projecting computer images</p>	<p>If dual display has been activated in the Display Properties of the computer's Control Panel, the projector will only project about half of the image on the computer screen. To display the whole of the image on the computer screen, turn off the dual display setting. ☞ Computer video driver documentation</p>
<p>Has the correct resolution been selected?</p> <p>Only when projecting computer images</p>	<p>Set the computer so that the signals that are output are compatible with this projector. ☞ "List of Supported Monitor Displays" p.45, Computer documentation</p>



■ Image colours are not right

<p>Are the image signal format settings correct?</p>	<p>If a <u>composite video</u> or <u>S-Video</u> signal is being input If projection does not occur when the "Video Signal" menu command is set to "Auto", select the signal format that matches the signal source. ☞ "Setting" - "Input Signal" - "Video Signal" p.22</p> <hr/> <p>If the signal source is connected to the [InputA] port, [InputB] port or [D4] port Use the "Input Signal" menu command to set the signal format that matches the signal that is being projected from the connected equipment. ☞ "Setting" - "Input Signal" p.22 You can also press ,  or  on the remote control to select the format. ☞ <i>Setup Guide</i></p>
<p>Are the cables connected correctly?</p>	<p>Check that all of the cables required for projection are securely connected. ☞ <i>Setup Guide</i></p>
<p>Has the image Contrast been adjusted correctly?</p>	<p>Use the "Contrast" or "White Level" menu command to adjust the contrast. ☞ "Image" - "Picture Quality" - "Input Adjustment" p.16</p>
<p>Has the colour been adjusted correctly?</p>	<p>Use the "Color Adjustment" menu command to adjust the colour. ☞ "Image" - "Color Adjustment" p.17</p>
<p>Have the colour intensity and tint been adjusted correctly?</p> <div style="background-color: black; color: white; padding: 5px; margin-top: 10px;"> <p>Only when projecting images from a video source</p> </div>	<p>Use the "Color Intensity" and "Tint" menu commands to adjust the colour and tint. ☞ "Image"- "Picture Quality" - "Color Intensity", "Tint" p.16</p>

■ Images appear dark





<p>Has the image brightness been adjusted correctly?</p>	<p>Use the "Input Adjustment" and "Brightness" menu commands to make the adjustments. ☞ "Image" - "Picture Quality" - "Input Adjustment", "Brightness" p.16</p>
<p>Has the image contrast been adjusted correctly?</p>	<p>Use the "Contrast" or "White Level" menu command to adjust the contrast. ☞ "Image" - "Picture Quality" - "Input Adjustment" p.16</p>
<p>Is the lamp due for replacement?</p>	<p>When the lamp is nearly due for replacement, the images will become darker and the colour quality will become poorer. When this happens, the lamp should be replaced with a new one. ☞ p.42</p>

■ Projection stops automatically

<p>Is sleep mode active?</p>	<p>If the projector remains on while no images signals are being input, after a while the lamp will automatically turn off and the projector will switch to standby mode. Press the  button on the remote control or the  button on the projector's control panel to turn the projector's power back on. To cancel the sleep mode setting, change "Sleep Mode" menu command to "OFF". ☞ "Setting" - "Operation" - "Sleep Mode" p.20</p>
-------------------------------------	---------------------------------------------------------------------------------------------------------------------------------------------------------------------------------------------------------------------------------------------------------------------------------------------------------------------------------------------------------------------------------------------------------------------------------------------------------------------------------------------------------------------------------------------------------------------------------------------------------------------

Problems when projection starts

■ Power does not turn on

Have you pressed the [Power] button?	Press  on the remote control or  on the projector's control panel.
Is "Operation Button Lock" set to "ON"?	If the "Operation Button Lock" menu command is set to "ON", all buttons on the projector's control panel are disabled. Press  on the remote control. <i>☞ "Setting" - "Operation" - "Lock Setting" - "Operation Button Lock" p.20</i>
Is the  indicator lit orange?	Disconnect the power cable and then reconnect it. <i>☞ Setup Guide</i> Check the circuit breaker to see if power is being supplied.
Do the indicators turn off and on when the power cable is touched?	Turn the power off, disconnect the power cable and then reconnect it. If this does not solve the problem, there may be a problem with the power cable. Then contact your dealer or the nearest address provided in the "International Warranty Conditions" of the <i>Safety Instructions/World-Wide Warranty Terms</i> booklet.

Problems with the remote control

■ The remote control does not work

Is the remote control light-emitting area facing towards the remote control light-receiving area when it is operated?	Face the remote control towards the remote control light-receiving area. The operating angle for the remote control is approximately $\pm 30^\circ$ horizontally and approximately $\pm 30^\circ$ vertically. <i>☞ Setup Guide</i>
Is the remote control too far from the projector?	The operating range for the remote control is approximately 10m. <i>☞ Setup Guide</i>
Is direct sunlight or strong light from fluorescent lamps shining onto the remote control light-receiving area?	Set the projector up in a location where strong light will not shine onto the remote control light-receiving area.
Are the batteries dead, or have the batteries been inserted correctly?	Insert new batteries, while making sure that they face correctly. <i>☞ Setup Guide</i>

Problems with network connections

■ Projector cannot be recognized

Are the projector and the computer correctly connected to the network?	Connect the network cable correctly.
Has the projector been set up correctly for connection to the network?	Check the settings for the "Network" menu command. ☞ "Setting"- "Operation" - "Network" p.20, p.27
Is "Network Monitoring" set to "ON"?	To turn the projector's power on from a computer while the projector is in the standby mode, you must first set "Network Monitoring" to "ON". ☞ "Setting"- "Operation" - "Network Monitoring" p.20
Is power being supplied to the projector?	Check if the power supply to the location has been interrupted, or if the circuit breaker for the electrical outlet has been tripped.

This section describes maintenance tasks such as cleaning the projector and replacing consumables.

Cleaning

You should clean the projector if it becomes dirty or if the quality of projected images starts to deteriorate.



Be sure to read the separate *Safety Instructions/World-Wide Warranty Terms* booklet for details on safe handling of the projector before cleaning.

Cleaning the Air Filter

If the airfilter becomes clogged with dust or the message "The projector is overheating. Make sure nothing is blocking the air vent, and clean or replace the air filter." is displayed, clean the air filter.

Turn the projector upside-down and use a vacuum cleaner to clean the air filter.

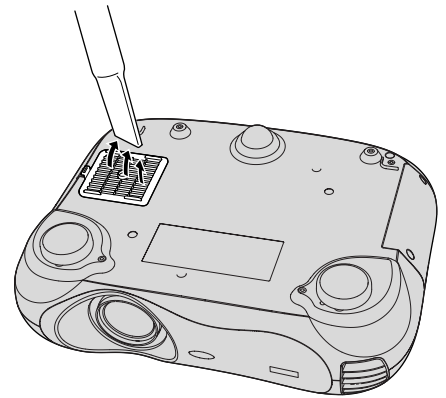

If the air filter becomes clogged with dust, it can result in overheating which may cause operating problems or reduce the operating life of the optical parts. It is recommended that you clean the air filter about once every three months. If using the projector in a dusty location, the air filter should be cleaned more often.

Cleaning the Projector Body

Clean the projector case by wiping it gently with a soft cloth.

If the projector is particularly dirty, moisten the cloth with water containing a small amount of neutral detergent, and then firmly wring the cloth dry before using it to wipe the projector case. Then wipe the body again with a soft, dry cloth.

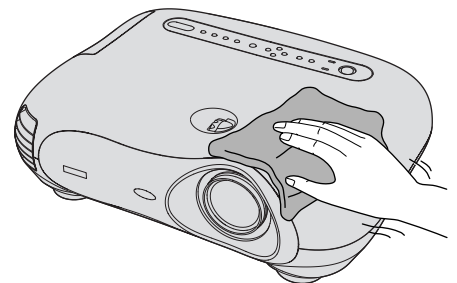

Do not use any volatile substances such as wax, alcohol or thinner to clean the projector body. It can cause the body to warp and make the coating finish peel off.

Cleaning the Lens

Use a commercially-available air blower, or use a lens cleaning paper to gently wipe the lens.

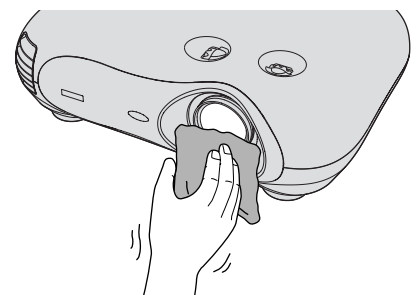

Do not rub the lens with harsh materials or subject the lens to shocks, as it can easily become damaged.

Consumable Replacement Periods

Air Filter Replacement Period

If the air filter becomes broken or too dirty to clean

Replace with an optional air filter.

☞ "Appendix: Optional Accessories" p.44

Lamp Replacement Period

- The message "Replace the lamp." appears on the screen when projection starts

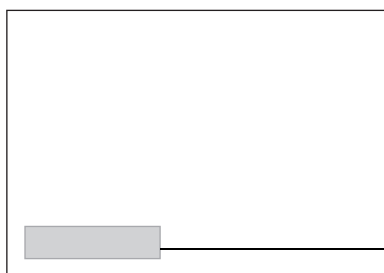

A message will be displayed.

- The projected images get darker or start to deteriorate
- The ☼ indicator is flashing orange

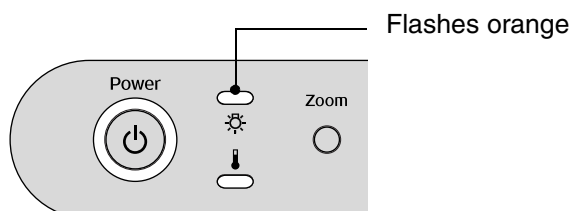

- The replacement warning message is set to appear after a minimum of about 1600 hours of lamp use in order to maintain the initial brightness and quality of the projected images. The time taken for the message to appear will vary depending on usage conditions such as Color Mode settings. If you continue to use the lamp after this period, the possibility of the lamp breaking becomes greater. When the lamp replacement message appears, replace the lamp with a new one as soon as possible, even if it is still working.
- The actual life of each individual lamp will vary depending on the characteristics of the lamp and on the way it has been used. The lamp may become dark or be off even before the lamp replacement message appears. You should always have a spare lamp ready in case it is needed.
- Contact your dealer for a spare lamp.

Replacing Consumables

Replacing the Air Filter



Dispose of used air filters properly in accordance with your local regulations.

Air filter frame:
ABS plastic

Air filter:
Polypropylene

1 Turn off the power, wait for the cool-down period to finish (takes approximately 30 seconds), then disconnect the power cable.

2 Remove the air filter cover.

- ① Put your finger under the latch.
- ② Lift up.

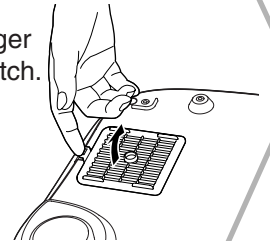

Replacing the Lamp



If the lamp stops working and needs to be replaced, there is the danger that the lamp may already be broken. If replacing the lamp of a projector which has been installed on the ceiling, you should always assume that the lamp is broken and handle it with extreme care during removal. Furthermore, you should stand to the side of the projector, not underneath it.

1 Turn off the power, wait for the cool-down period to finish (takes approximately 30 seconds), then disconnect the power cable.
* Wait until the lamp cools down (takes approximately 1 hour).

2 Loosen the screws fixing the lamp cover.

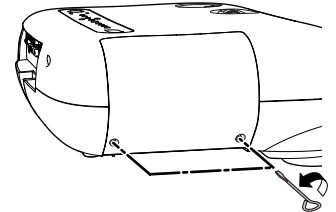

6 Install the new lamp. Make sure that it faces the correct way.

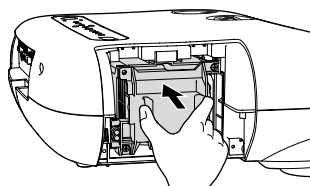

7 Securely tighten the lamp fixing screws.

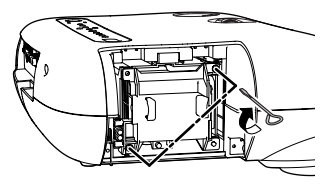

Resetting the Lamp Operating Time

The lamp operating time must always be reset after the lamp has been replaced with a new one.

The projector has a built-in lamp operating time counter. A replacement message is displayed when the counter reaches a certain amount.

1 Press **On** to turn on the power.

2 Press **Menu** to display the configuration menu.

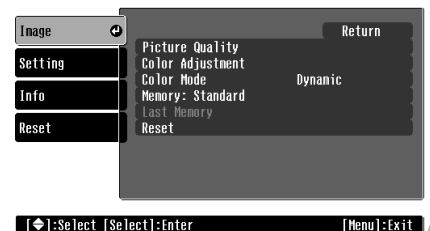

3 Remove the old air filter.

Place your finger under one of the ribs and lift up.

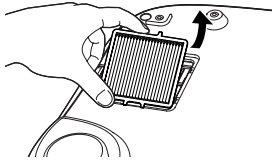

4 Install the new air filter.

Make sure that it faces the correct way.

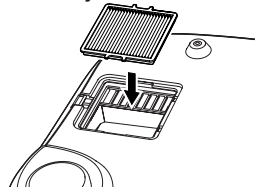

5 Install the air filter cover.

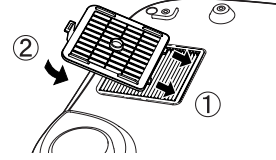

3 Remove the lamp cover.

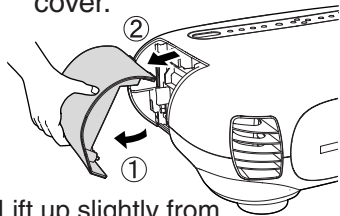

Lift up slightly from underneath to remove.

4 Loosen the screws fixing the lamp.

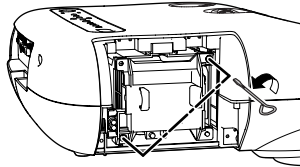

5 Remove the old lamp.

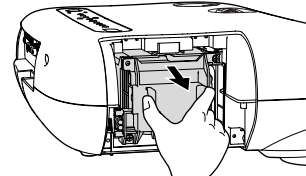

Pull out straight.

8 Install the lamp cover, then tighten the lamp cover fixing screws.

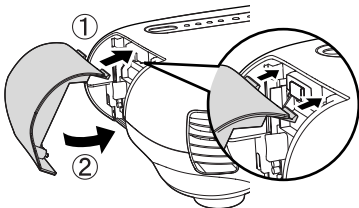

- Install the lamp and the lamp cover securely. The lamp will not be on if the lamp or the lamp cover is not installed correctly.
- The lamp contains mercury. Used lamps should be disposed of according to local waste regulations (in the same way as fluorescent lights).

3 Select "Lamp-Hours Reset" in the "Reset" menu.

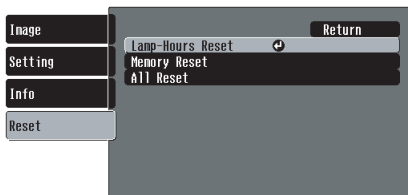

[Esc]:Return [Left Arrow]:Select [Select]:Enter [Menu]:Exit

4 Select "Yes" and then press .



[Esc]:Return [Left Arrow]:Select [Select]:Execute [Menu]:Exit

Optional Accessories

The following optional accessories are available for purchase if required. This list of optional accessories is current as of November 2003. Details of accessories are subject to change without notice.

Spare lamp	ELPLP28
-------------------	----------------

(1 spare lamp)
Use as a replacement for spent lamps.

Air filter	ELPAF04
-------------------	----------------

(1 air filter)
Use as a replacement for old air filters.

50" portable screen	ELPSC06
----------------------------	----------------

A compact screen which can be carried easily.
(Aspect 4:3).

60" screen	ELPSC07
80" screen	ELPSC08
100" screen	ELPSC10

A portable roll-type screen. (Aspect 4:3)

Ceiling mount*	ELPMB17
-----------------------	----------------

(with ceiling plate)
Use when installing the projector to a ceiling.

Pipe 600 (600 mm (23.62 in.)/white)*	ELPFP07
---------------------------------------------	----------------

Use when installing the projector on a high ceiling or a ceiling with panels.

*A special method of installation is required in order to suspend the projector from a ceiling. Please contact your dealer if you would like to use this installation method.

List of Supported Monitor Displays

Depending on the "Output Scaling" settings, the values given below will change slightly.

Component Video^{▶▶}/RGB Video

4:3 16:9 : Aspect Units: Dots

Signal	Resolution	Aspect mode					
		Normal	Squeeze	Zoom	Through	Squeeze through	Wide
SDTV ^{▶▶} (525i, 60Hz)(D1)	640×480 640×360 (for zoom)	960×720 4:3	1280×720 16:9	1280×720 16:9	596×446 4:3	794×446 16:9	1280×760 16:9
SDTV(625i, 50Hz)	768×576 768×432 (for zoom)	960×720 4:3	1280×720 16:9	1280×720 16:9	708×528 4:3	944×528 16:9	1280×760 16:9
SDTV(525p) (D2)	640×480 640×360 (for zoom)	960×720 4:3	1280×720 16:9	1280×720 16:9	596×446 4:3	794×446 16:9	1280×760 16:9
SDTV(625p)	768×576 768×432 (for zoom)	960×720 4:3	1280×720 16:9	1280×720 16:9	708×528 4:3	944×528 16:9	1280×760 16:9
HDTV ^{▶▶} (750p) 16:9(D4)	1280×720	1280×720 16:9	-	-	1176×664 16:9	-	-
HDTV(1125i) 16:9(D3)	1920×1080	1280×720 16:9	-	-	-	-	-

Composite Video^{▶▶}/S-Video^{▶▶}

4:3 16:9 : Aspect Units: Dots

Signal	Resolution	Aspect mode					
		Normal	Squeeze	Zoom	Through	Squeeze through	Wide
TV(NTSC ^{▶▶})	640×480 640×360 (for zoom)	960×720 4:3	1280×720 16:9	1280×720 16:9	596×446 4:3	794×446 16:9	1280×720 16:9
TV(PAL ^{▶▶} , SECAM ^{▶▶})	768×576 768×432 (for zoom)	960×720 4:3	1280×720 16:9	1280×720 16:9	708×528 4:3	944×528 16:9	1280×720 16:9

Analog-RGB signals/signals input to the [HDMI] port

Units: Dots

Signal	Resolution	Aspect mode					
		Normal	Squeeze	Zoom	Through	Squeeze through	Wide
VGA ^{▶▶} 60, SDTV ^{▶▶} (525p)	640×480 640×360 (for zoom)	960×720	1280×720	1280×720	640×480	853×480	1280×720
VESA72/75/85	640×480 640×360 (for zoom)	960×720	1280×720	1280×720	640×480	853×480	1280×720
SVGA ^{▶▶} 56/60/72/75/85	800×600 800×450 (for zoom)	960×720	1280×720	1280×720	800×600	1066×600	1280×720
XGA ^{▶▶} 43i/60/70/75	1024×768 1024×576 (for zoom)	960×720	1280×720	1280×720	-	-	1280×720
MAC13"	640×480	960×720	1280×720	1280×720	640×480	853×480	1280×720
MAC16"	832×624	960×720	1280×720	1280×720	832×624	1109×624	1280×720
MAC19"	1024×768	960×720	1280×720	1280×720	-	-	1280×720
SDTV(525i, 60Hz)	640×480 640×360 (for zoom)	960×720	1280×720	1280×720	640×480	853×480	1280×720
SDTV(625i, 50Hz)	768×576 768×432 (for zoom)	960×720	1280×720	1280×720	768×576	1024×576	1280×720
SDTV(625p)	768×576 768×432 (for zoom)	960×720	1280×720	1280×720	768×576	1024×576	1280×720
HDTV(750p)	1280×720	1280×720	-	-	1280×720	-	-
HDTV(1125i)	1920×1080	1280×720	-	-	-	-	-

MAC signals are only supported in analogue format.

■ correspond to input signals from the [HDMI] port.

It may be possible to project signals which are not listed in the above table. However, some functions may be limited in that case.

Specifications

Product name	Home Projector EMP-TW500		
Dimensions	450 (W) × 119 (H) × 345 (D) mm (17.7 (W) × 4.7 (H) × 13.6 (D) in.) (not including foot)		
Panel size	0.7 inches		
Display method	Polysilicon TFT active matrix		
Resolution	921,600 pixels (1280 (W) × 720 (H) dots) × 3		
Scanning frequencies	Analogue	Pixel clock	:13.5–81MHz
		Horizontal	:15–60 KHz
		Vertical	:50–85 Hz
	Digital	Pixel clock	:13.5–81MHz
		Horizontal	:15–60 KHz
		Vertical	:50–85 Hz
Focus adjustment	Electronic		
Zoom adjustment	Electronic (approx. 1 : 1.5)		
Lens shift	Manual (Approx. 100% of upwards maximum, approx. 50% of downwards maximum, approx. 50% sideways maximum)		
Lamp (light source)	UHE lamp, 200 W, Model No.: ELPLP28		
Power supply	100–240 VAC 50/60 Hz 3.3–1.5 A		
Operating temperature	+5°– +35°C (41°–95°F) (No condensation)		
Storage temperature	-10°– +60°C (14°–140°F) (No condensation)		
Weight	Approx. 6.2 kg (13.8 lbs)		
Ports	D4 (Japan only)	1	D4
	InputA	1	RCA pin jack × 5
	InputB	1	RCA pin jack × 5
	<u>HDMI</u> ▶▶	1	HDMI
	Video	1	RCA pin jack
	S-Video	1	Mini DIN 4-pin
	Network	1	RJ-45
	Control (RS-232C)	1	D-Sub 9-pin (male)
	USB *	1	USB connector (type B)
	Trigger out	1	3.5 mm mini jack

* The USB connector is not guaranteed to operate correctly with all USB-compatible devices.



Pixelworks DNX™ ICs are used in this Projector.

Compatible computers for using Cinema Color Editor

	Windows	Macintosh
OS	Windows 98SE, NT4.0(SP6a), Me, 2000 Professional, XP Home Edition, XP Professional Edition * Internet Explorer Ver. 5 or later must be installed.	Mac OS 8.6, 9.0.4, 9.1, 9.2.x MAC OS X 10.1.5, 10.2.x * Not compatible with the Classic environment of Mac OS X or higher.
CPU	Pentium MMX 166 MHz or higher (Pentium II 233 MHz or higher recommended)	Power PC G3 or higher (300 MHz or higher recommended)
Memory capacity	10 MB or more	7 MB or more
Hard disk free space	2 MB or more	5 MB or more
Display	<u>XGA</u> (1024 × 768) or greater resolution. 16-bit color or greater display	

RS-232C cable layout

- Connector shape : D-Sub 9-pin (male)
- Projector input connector : Control (RS-232C)

<At projector>



<At computer>

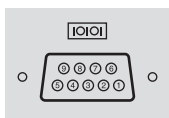

<At projector> (PC serial cable) <At computer>

GND	5	—————	5	GND
RD	2	←————	3	TD
TD	3	————→	2	RD
DTR	4	————→	6	DSR
DSR	6	←————	4	DTR

Signal	Function
GND	Signal wire earth
TD	Transmit data
RD	Receive data
DSR	Data set ready
DTR	Data terminal ready

Safety

USA
UL1950 3rd Edition
Canada
CSA C22.2 No.950-95 (cUL)
European Community
The Low Voltage Directive (73/23/EEC)
IEC60950 2nd Edition, +Amd.1, +Amd.2, +Amd.3,
+Amd.4

EMC

USA
FCC 47CFR Part15B Class B (DoC)
Canada
ICES-003 Class B
European Community
The EMC Directive (89/336/EEC)
EN55022, 1998 Class B
EN55024, 1998
IEC61000-4-2, IEC61000-4-3, IEC61000-4-4,
IEC61000-4-5,
IEC61000-4-6, IEC61000-4-8, IEC61000-4-11,
IEC61000-3-2, IEC61000-3-3
Australia/New Zealand
AS/NZS 3548:1995, A1:1997, A2:1997 Class B
CISPR Pub.22:1993, A1:1995, A2:1996, Class B

DECLARATION of CONFORMITY

According to 47CFR, Part 2 and 15
Class B Personal Computers and Peripherals; and/or
CPU Boards and Power Supplies used with Class B
Personal Computers

We :EPSON AMERICA, INC.
Located at : 3840 Kilroy Airport Way
MS: 313
Long Beach, CA 90806
Tel : 562-290-5254

Declare under sole responsibility that the product identified herein, complies with 47CFR Part 2 and 15 of the FCC rules as a Class B digital device. Each product marketed, is identical to the representative unit tested and found to be compliant with the standards. Records maintained continue to reflect the equipment being produced can be expected to be within the variation accepted, due to quantity production and testing on a statistical basis as required by 47CFR 2.909. Operation is subject to the following two conditions : (1) this device may not cause harmful interference, and (2) this device must accept any interference received, including interference that may cause undesired operation.

Trade Name : EPSON
Type of Product : Projector
Model : EMP-TW500

**FCC Compliance Statement
For United States Users**

This equipment has been tested and found to comply with the limits for a Class B digital device, pursuant to Part 15 of the FCC Rules. These limits are designed to provide reasonable protection against harmful interference in a residential installation. This equipment generates, uses, and can radiate radio frequency energy and, if not installed and used in accordance with the instructions, may cause harmful interference to radio or television reception. However, there is no guarantee that interference will not occur in a particular installation. If this equipment does cause interference to radio and television reception, which can be determined by turning the equipment off and on, the user is encouraged to try to correct the interference by one or more of the following measures.

- Reorient or relocate the receiving antenna.
- Increase the separation between the equipment and receiver.
- Connect the equipment into an outlet on a circuit different from that to which the receiver is connected.
- Consult a dealer or an experienced radio/TV technician for help.

WARNING

The connection of a non-shielded equipment interface cable to this equipment will invalidate the FCC Certification or Declaration of this device and may cause interference levels which exceed the limits established by the FCC for this equipment. It is the responsibility of the user to obtain and use a shielded equipment interface cable with this device. If this equipment has more than one interface connector, do not leave cables connected to unused interfaces. Changes or modifications not expressly approved by the manufacturer could void the user's authority to operate the equipment.

The following is an explanation of some of the terms used in this guide which may be unfamiliar or which were not explained in the manual itself. Further information can be obtained by referring to other commercially-available publications.

Component video

Video signals which have the video brightness signals and color signals separated, in order to provide better image quality.

In high-definition TV (HDTV), it refers to images which consist of three independent signals: Y (luminance signal), and Pb and Pr (color difference signals).

Composite video

Video signals which have the video brightness signals and color signals mixed together. The type of signals commonly used by household video equipment (NTSC►►, PAL►► and SECAM►► formats).

Video signals which consist of a carrier signal Y (luminance signal) within the color bar signal, and a chroma or color signal (CbCr).

Cool-down

This is the process by which the projector's lamp is cooled down after it has become hot through use. It is carried out automatically when the [Power] button on either the remote control or the projector's control panel has been pressed to the projector off. Do not disconnect the power cable while cool-down is in progress, otherwise the cool-down process will not work properly. If the cool-down period is not allowed to finish normally, the projector's lamp and internal components will remain at high temperatures, and this may shorten the useful life of the lamp or cause problems with the operation of the projector. The cool-down period lasts for about 30 seconds. The actual time will vary depending on the external air temperature.

DHCP

Abbreviation for Dynamic Host Configuration protocol, which is a protocol for automatically assigning an IP address►► for devices that are connected to a network.

Gateway

A server (router) that is used for communication over a network (subnet) that is divided up using subnet masks►►.

HDMI

An abbreviation for High Definition Multimedia Interface, and refers to a standard for digital transmission of high-definition images and multi-channel audio signals.

HDMI is a standard that is targeted towards household digital equipment and computers that allows digital signals to be transmitted in their original high quality without compression, and it also includes a digital signal encryption function.

HDTV

An abbreviation for High-Definition Television. It refers to high-definition systems which satisfy the following conditions.

- Vertical resolution of 750p or 1125i or greater (p = progressive, i = interlaced►►)
- Screen aspect of 16:9
- Dolby Digital audio reception and playback (or output)

Interlace

A method of image scanning whereby the signal bandwidth used is approximately half that required for sequential scanning when images with the same still picture resolution are broadcast.

IP address

A series of numbers that identifies a device that is connected to a network.

MAC address

Abbreviation for Media Access Control address. A MAC address is a unique ID number that is assigned to each network adapter. All network adapters are assigned this unique address, and these are used as the basis for communication between each network adapter.

NTSC

An abbreviation for National Television Standards Committee, and a format for ground-based analogue colour television broadcasts. This format is used in Japan, North America and Central and South America.

PAL

An abbreviation for Phase Alternation by Line, and a format for ground-based analogue colour television broadcasts. This format is used in Western European countries except France, and also in Asian countries such as China and in Africa.

Refresh rate

The light-emitting element of a display maintains the same luminosity and color for an extremely short time. Because of this, the image must be scanned many times per second in order to refresh the light emitting element. The number of refresh operations per second is called the "refresh rate", and is expressed in hertz (Hz).

S-Video

A video signal which has the luminance component and color component separated in order to provide better image quality.

It refers to images which consist of two independent signals: Y (luminance signal), and C (color signal).

SDTV

An abbreviation for Standard Definition Television. It refers to standard television systems which do not satisfy the conditions for HDTV►►.

SECAM

An abbreviation for Sequential Couleur A Memoire, and a format for ground-based analogue colour television broadcasts. This format is used in France, Eastern Europe and the former Soviet Union, the Middle East and Africa.

Security lock

A device consisting of a protector case with a hole in it that a commercially-available theft-prevention cable can be passed through in order to secure the device to a table or pillar. This projector is compatible with the Microsaver Security System manufactured by Kensington.

SNMP

Abbreviation for Simple Network Management Protocol. In TCP/IP networks, this protocol is used for communication between routers and other devices that are connected to the network such as computers and terminals so that these devices can be monitored and controlled over the network.

sRGB

An international standard for color intervals that was formulated so that colors which are reproduced by video equipment can be handled easily by computer operating systems (OS) and the Internet.

Subnet mask

A series of numbers that define the number of bits to be used for network addresses in a network (subnet) that is divided up according to [IP addresses](#)▶▶.

SVGA

A type of image signal with a resolution of 800 (horizontal) × 600 (vertical) dots which is used by IBM PC/ AT-compatible computers.

SXGA

A type of image signal with a resolution of 1280 (horizontal) × 1024 (vertical) dots which is used by IBM PC/ AT-compatible computers.

Sync. (Synchronization)

The signals output from computers have a specific frequency. If the projector frequency does not match this frequency, the resulting images will not be of a good quality. The process of matching the phases of these signals (the relative position of the crests and troughs in the signal) is called "synchronization". If the signals are not synchronized, problems such as flickering, blurriness and horizontal interference can occur.

Tracking

The signals output from computers have a specific frequency. If the projector frequency does not match this frequency, the resulting images will not be of a good quality. The process of matching the frequency of these signals (the number of crests in the signal) is called "tracking". If tracking is not carried out correctly, wide vertical stripes will appear in the projected images.

Trap IP address

An [IP address](#)▶▶ for the destination computer when [SNMP](#)▶▶ reports that a problem has occurred.

VGA

A type of image signal with a resolution of 640 (horizontal) × 480 (vertical) dots which is used by IBM PC/ AT-compatible computers.

XGA

A type of image signal with a resolution of 1,024 (horizontal) × 768 (vertical) dots which is used by IBM PC/ AT-compatible computers.

YCbCr

The carrier signal which is contained in the color bar signal used in modern TV transmissions. The name comes from the Y (luminance) signal and the CbCr (chroma [color]) signals.

YPbPr

The carrier signal which is contained in the color bar signal used in high-definition TV (HDTV) transmissions. The name comes from the Y (luminance) signal and the PbPr (color difference) signals.

"SG" stands for *Setup Guide*.

- A**
- Abs. Color Temp. 10,14,17
 - Advanced..... 15,18
 - Air filter..... 6
 - Air inlet..... 6
 - All Reset..... 15,23
 - Aspect 8,12,45
 - Auto 8
 - Auto Setup..... 14,18,SG
- B**
- Background Color 15,21
 - Battery replacement period(Remote control) SG
 - Black Level 14,16
 - Brightness 14,16
 - Button Illumination 15,21
- C**
- Ceiling 15,20,SG
 - Cinema Color Editor 24
 - Cleaning the Air Filter..... 40
 - Cleaning the Lens 40
 - Cleaning the Projector Body 40
 - Color Adjustment 14,17
 - Color Intensity 14,16
 - Color Mode..... 8,14,17
 - COM Port 15,20,26
 - Compatible Computers (Cinema Color Editor)..... 47
 - Component Video..... 45,SG
 - Composite Video 45,SG
 - Configuration Menu 14
 - Connecting to a Computer..... 25,SG
 - Connecting to a Video Source SG
 - Contrast 14,16
 - [Control (RS-232C)] port 6,26
 - Control panel 4
 - Cool-down 33,SG
 - Correcting keystone distortion 4,SG
 - Correcting projector tilt..... 4,SG
- D**
- [D4] port..... 6,46,SG
 - DHCP 15,27
 - DVI Video LEVEL..... 15,19
- E**
- Epson Cinema Filter..... 9,17
 - EPSON Super White 15,18
- F**
- Flesh Tone 10,14,17
 - Focus adjustment..... 4,5,SG
 - Front adjustable foot..... 4,SG
 - Full menus 14,23
- G**
- Gain adjustment 11,14,17
 - Gamma adjustment 11,14,17
 - Gateway Address 15,27
- H**
- [HDMI] port..... 6,46,SG
 - HDTV..... 45
 - Hue and saturation adjustment..... 10
- I**
- Image size SG
 - "Image" menu..... 14,16
 - Indicators..... 4,32
 - "Info" menu..... 15
 - Input Adjustment..... 14,16
 - Input Level 14,16
 - Input Signal..... 15,22
 - [InputA] port 6,46,SG
 - [InputB] port 6,46,SG
 - Install..... 24
 - IP Address 15,27
- K**
- Keystone..... 15,20,SG
- L**
- Lamp - Hours Reset 15,22,42
 - Lamp cover..... 4,42
 - Lamp Hours 15
 - Lamp indicator 4
 - Language..... 15,22
 - Last Memory 13,14,17
 - Lens cover 4,SG
 - Lens shift..... 4,SG
 - Line menu 14,23
 - Lock Setting 15,20
- M**
- MAC Address..... 15,27
 - Memory 5,12
 - Memory Edit 30
 - Memory Reset..... 15,22
 - Memory: Standard/Advance 12,14,17
 - Menu Color 15,21
 - Menu Position 15,21
 - Menus..... 14,23
 - Message..... 15,21
 - Motion Detection 15,18

N

Navigation Bar 14,15,21
 Network 6,15,20
 Network Monitoring 15,20
 [Network] port 6,25,46
 Noise Reduction 15,18
 Normal 8

O

Offset adjustment 10,14,17
 On-Screen Display 15,21
 Operation 15,20
 Operation indicator 4,SG
 Optional Accessories 44
 Output Scaling 15,19
 Overheating 32

P

Picture Quality 14,16
 Port 6,46,SG
 Position 15,19
 Power cable SG
 Power inlet 6,SG
 Progressive 15,18
 Projection 15,20,SG
 Projection distance SG
 Projection Image Position Adjustment SG
 Projector Name 15,27

R

Refresh Rate 15
 Remote control 5,SG
 Replacing the Air Filter 42
 Replacing the battery SG
 Replacing the Lamp 42
 Reset 14,15,18,22
 "Reset" menu 15,22
 Resolution 15,45
 RGB adjustment 10,14,17
 RGBCMY 10,14,17
 RGB-Video 45,SG

S

Screen 15,19
 Screen size SG
 SDTV 45
 Selecting the image source 4,5,SG
 Selection menu 8,12,SG
 "Setting" menu 15,18
 Setup Level 15,19
 Sharpness 14,16
 Sleep Mode 15,20
 Source 15
 Specifications 46
 Squeeze 8
 Squeeze Through 9
 sRGB 9,14

Startup Screen 15,22
 Sub-menu 14
 Subnet Mask 15,27
 Supported Monitor Displays 45
 S-Video 45,SG
 [S-Video] port 6,46,SG
 Sync Info 15
 Sync. 14,16

T

Temperature indicator 4
 Test Pattern 5,SG
 Through 9
 Tint 14,16
 Top menu 14
 Tracking 14,16
 Trigger Out 15,20
 [Trigger out] port 6,46
 Turning off SG

U

Uninstall 25
 [USB] port 6,26
 User's Logo 15,21
 Using the Configuration Menus 23

V

Video Signal 15,22
 [Video] port 6,46,SG

W

White Level 14,16
 Wide 8

Y

YCbCr 15,SG
 YPbPr 15,SG

Z

Zoom 8
 Zoom adjustment 4,5,SG
 Zoom Caption 9,15,19

All rights reserved. No part of this publication may be reproduced, stored in a retrieval system, or transmitted in any form or by any means, electronic, mechanical, photocopying, recording, or otherwise, without the prior written permission of SEIKO EPSON CORPORATION. No patent liability is assumed with respect to the use of the information contained herein. Neither is any liability assumed for damages resulting from the use of the information contained herein.

Neither SEIKO EPSON CORPORATION nor its affiliates shall be liable to the purchaser of this product or third parties for damages, losses, costs, or expenses incurred by purchaser or third parties as a result of: accident, misuse, or abuse of this product or unauthorised modifications, repairs, or alterations to this product, or (excluding the U.S.) failure to strictly comply with SEIKO EPSON CORPORATION's operating and maintenance instructions.

SEIKO EPSON CORPORATION shall not be liable against any damages or problems arising from the use of any options or any consumable products other than those designated as Original EPSON Products or EPSON Approved Products by SEIKO EPSON CORPORATION.

General Notice:

EPSON is a registered trademark of SEIKO EPSON CORPORATION.

Macintosh, Mac, and iMac are registered trademarks of Apple Computer, Inc.

IBM is a registered trademark of International Business Machines Corporation.

Windows and Windows NT are trademarks of Microsoft Corporation in the United States of America.

Pixelworks and DNX are trademarks of Pixelworks, Inc.

"DCDi[®] by Faroudja" is a registered trade mark of Genesis Microchip Inc.

Other product names used herein are also for identification purposes only and may be trademarks of their respective owners. EPSON disclaims any and all rights in those marks.

EPSON®

E



Printed on 100% recycled paper.



Printed in Japan
404801900
03.11-.8A(C05)