

myprojectorlamps.com

**The most trusted, dependable name
in projector lamp sales.**



<http://www.myprojectorlamps.com>



<http://www.myprojectorlamps.ca>



<http://www.myprojectorlamps.eu>

The following projector manual has not been modified or altered in any way.

Home Projector
EMP-TW200

User's Guide



About The Manuals and Notations Used

Types of Manual

The documentation for your EPSON projector is divided into the following four manuals. Refer to the manuals in the order given below.

❶ Unpacking and Installation Guide

Lists the accessories that are provided with the projector.

❷ Safety Instructions/World-Wide Warranty Terms

This manual contains information on using the projector safely, and also includes *safety instructions*, *world-wide warranty terms* booklet and a troubleshooting check sheet.

Be sure to read this manual thoroughly before using the projector.

❸ Setup Guide







Contains information on basic operations for preparing the projector before use (setup and connecting video equipment or a computer) and for starting projection.

❹ User's Guide (this manual)

Contains information on adjusting images, using the configuration menus, using the Cinema Color Editor, troubleshooting and maintenance.

Notations used in this User's Guide

General information

	Indicates procedures where personal injury or damage to the projector may occur if the procedures are not followed correctly.
	Indicates additional information and points which may be useful to know regarding a topic.
	Indicates a page where useful information regarding a topic can be found.
	Indicates that an explanation of the underlined word or words in front of this symbol appears in the glossary of terms. Refer to the "Glossary" in the "Appendix".  p.45
 ,  , etc.	Indicates buttons on the remote control or projector's control panel.

Meaning of "unit" and "projector"

When "unit" or "projector" appears in the text of this *User's Guide*, they may refer to items which are accessories or optional equipment in addition to the main projector unit itself.

Contents

■ Features of the Projector	2	Remote Control	5
■ Part names and Functions	4	Rear	6
Front/Top.....	4	Base	6
Control Panel.....	4	■ Appearance	7

Basic Image Quality Adjustments

■ Basic Image Quality Adjustments	8	RGB adjustment	10
Selecting the Color Mode	8	■ Viewing images at a preset image quality (memory function)	12
Selecting the Image Aspect.....	8	Saving Image quality adjustments (Memory save)	12
■ Advanced Color Adjustments	10	Retrieving image quality adjustments (Memory retrieve)	12
Colour Temperature /Flesh Tone Adjustments	10		

Configuration Menu

■ Configuration Menu Functions	14	"Setting" menu	18
List of Configuration Menus.....	14	"Reset" menu.....	22
"Image" menu.....	16	Using the Configuration Menus	23

Adjusting projected images using a computer

■ Preparation for Using Cinema Color Editor ..	24	Operations using the Computer.....	26
Installing Cinema Color Editor.....	24	Adjusting the color hue and saturation	26
Uninstalling Cinema Color Editor	25	Saving adjustment/Loading adjustments from a file ..	27
Connecting to a Computer	25	Saving customised settings into memory	28
■ Using Cinema Color Editor	26	Saving/loading memory settings and editing memory area names	28
Starting Cinema Color Editor.....	26		

Troubleshooting

■ Problem Solving	30	When the Indicators Provide No Help	31
Reading the Indicators	30	• Problems relating to images	31
• When the ⚠(warning) indicator is lit or flashing	30	• Problems when projection starts.....	35
• When the ⏻(operation) indicator is lit or flashing	30	• Problems with the remote control.....	35

Appendix

■ Maintenance	36	• Resetting the Lamp Operating Time	38
Cleaning	36	■ Optional Accessories	40
• Cleaning the Air Filter.....	36	■ List of Supported Monitor Displays	41
• Cleaning the Projector Case	36	• Component Video.....	41
• Cleaning the Lens	36	• Composite Video/S-Video.....	41
Consumable Replacement Periods.....	37	• RGB Video/Computer.....	41
• Air Filter Replacement Period.....	37	■ Specifications	42
• Lamp Replacement Period	37	Compatible computers for using Cinema Color Editor	43
Replacing Consumables	38	■ Glossary	45
• Replacing the Air Filter.....	38	■ Index	47
• Replacing the Lamp.....	38		

Features of the Projector

▶ Image appearance can be selected to match the projection environment (Color Mode)

The optimum images for the location can be projected simply by selecting the desired colour mode from the following five preset modes. No complex colour adjustments are required.

If "Theatre", "Natural" or "sRGB" is selected, the Epson Cinema Filter effect is applied automatically to increase the contrast and to make flesh tones appear with more natural tints. [p.8](#)

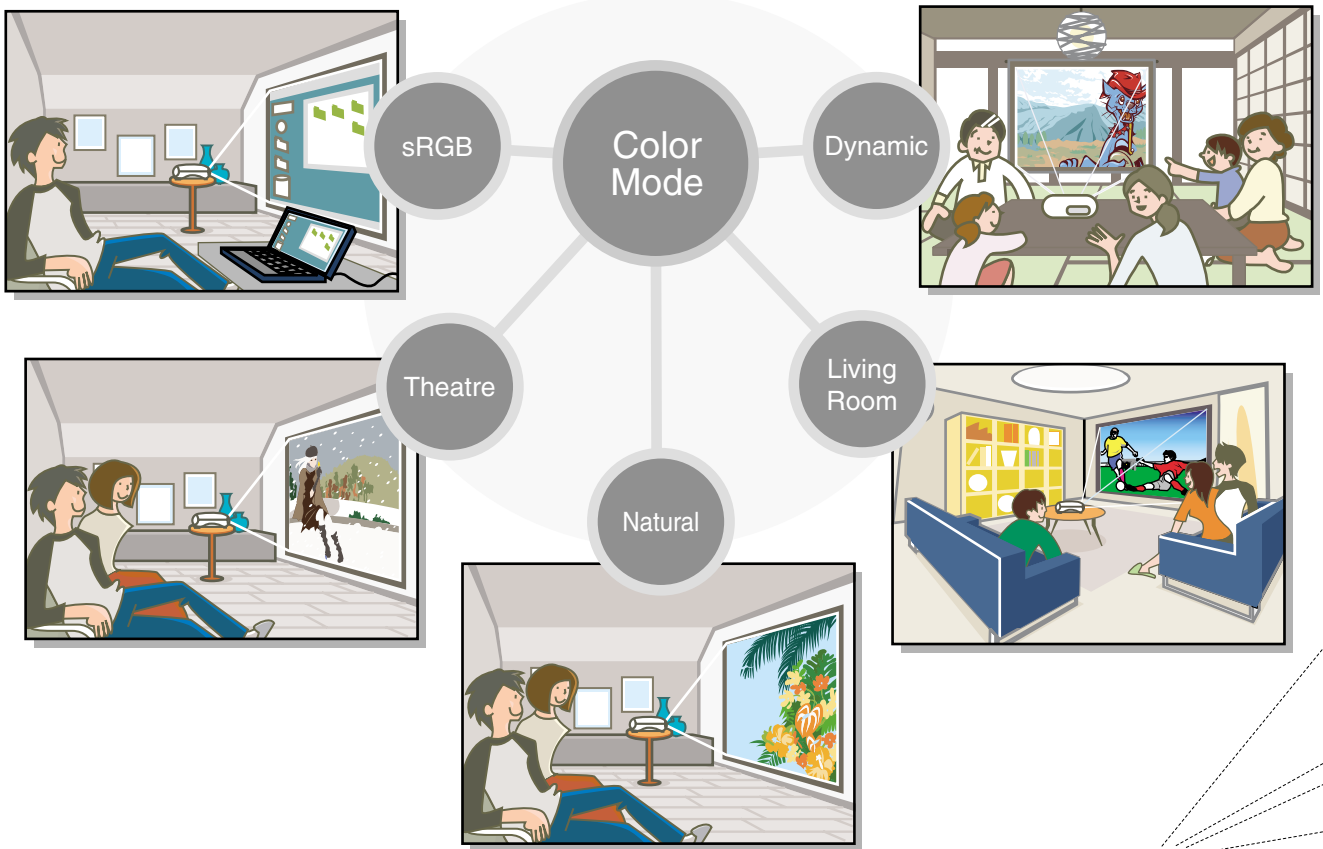

▶ Easy image adjustments by computer

The Cinema Color Editor CD-ROM that is included with the projector can be used to make fine adjustments to the hue and saturation of the projected images from a computer.

Adjustment values can be saved in computer files which can be exchanged with other people so that they can also see the results of the adjustments that you have made.

[p.24](#)

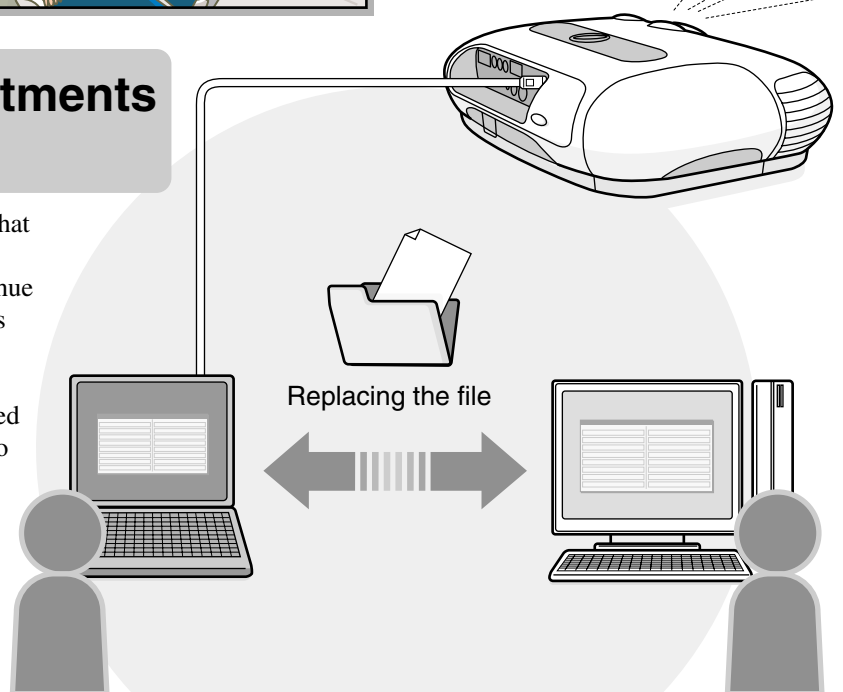

▶ Equipped with a wide-angle lens shift function

The lens shift function allows the position of the projected images to be adjusted vertically and horizontally without distorting the images.

This can allow the projector to be set up with greater freedom, even if it is suspended from a ceiling or at an angle to the screen. [☞ Setup Guide](#)

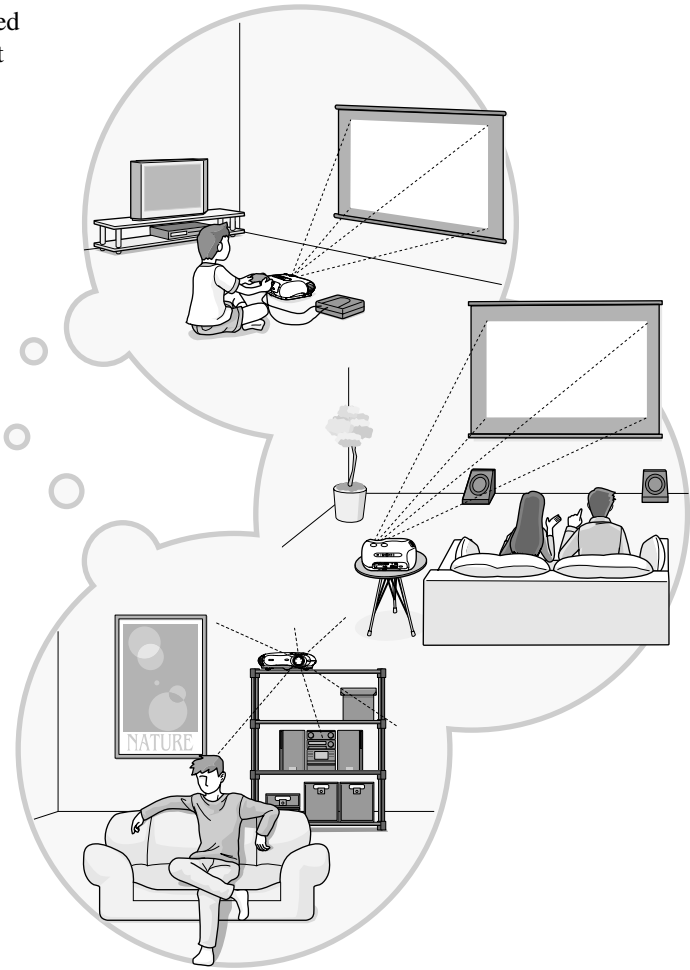
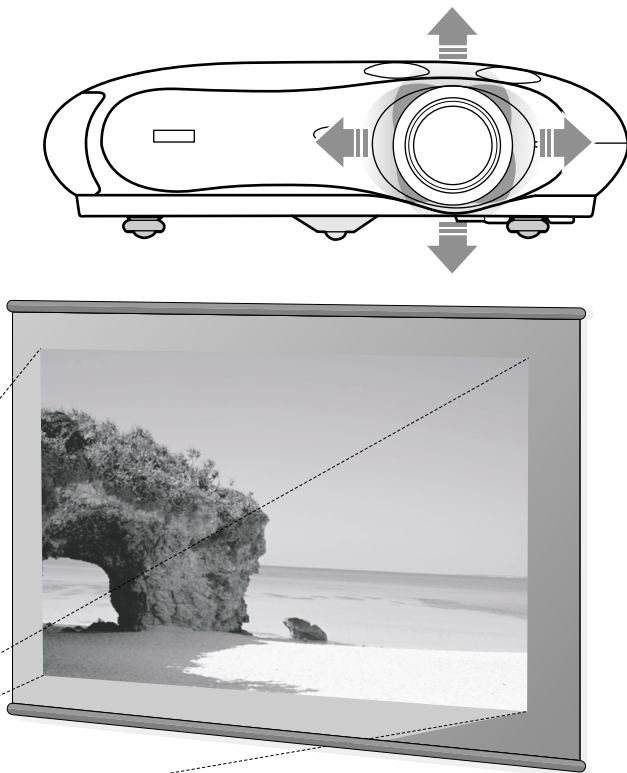

▶ Wide range of brightness adjustments

The image brightness can be adjusted within a wide range. The optimum images can be obtained even if using the projector in a bright environment for watching videos or games, or in a dark environment such as when creating the atmosphere of a home theatre. [☞ p.14](#)

▶ Electronic zoom and focus adjustment

The projector's control panel and the accessory remote control can be used for easy zoom and focus adjustments. An adjustment screen is displayed so that adjustment is possible even when no video equipment is connected. For zoom adjustment, a high magnification lens is provided to allow images to be increased in size by up to 1.5 times, so that images can be projected onto an 80" screen even at a distance of approximately 2.5 m. [☞ Setup Guide](#)

▶ A variety of image setting functions

Some of the other many functions that are available are as follows.

- A **progressive** conversion that lets you obtain ideal results both for images with large amounts of movement and for still images. [☞ p.18](#)
- An aspect function that allows images to be viewed in wide-screen format. [☞ p.8](#)
- Memory functions that allow adjustment results to be stored and later retrieved easily using the remote control. [☞ p.12](#)
- Lock settings that can be used to lock the projector's control panel after adjustments have been made so that they cannot be changed by mistake, or to prevent children from accidentally turning on the power and looking into the lens. [☞ p.20](#)

Part names and Functions

Front/Top

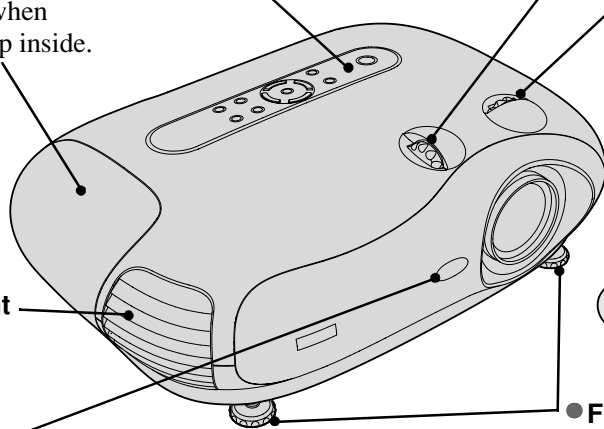
- 
- **Control panel** See below
 - **Lamp cover** p.38
Open this cover when replacing the lamp inside.
 - **Air exhaust vent**
 - **Remote control light-receiving area** **Setup Guide**
Receives signals from the remote control.
 - **Vertical lens adjustment dial** **Setup Guide**
Moves the lens vertically.
 - **Horizontal lens adjustment dial** **Setup Guide**
Moves the lens horizontally.
 - **Lens cover**
Attach when not using the projector to prevent the lens from becoming dirty or damaged.
 - **Front adjustable feet** **Setup Guide**
Extend to adjust the projection angle so that the projector is horizontal when placed on a desk top.

Control Panel

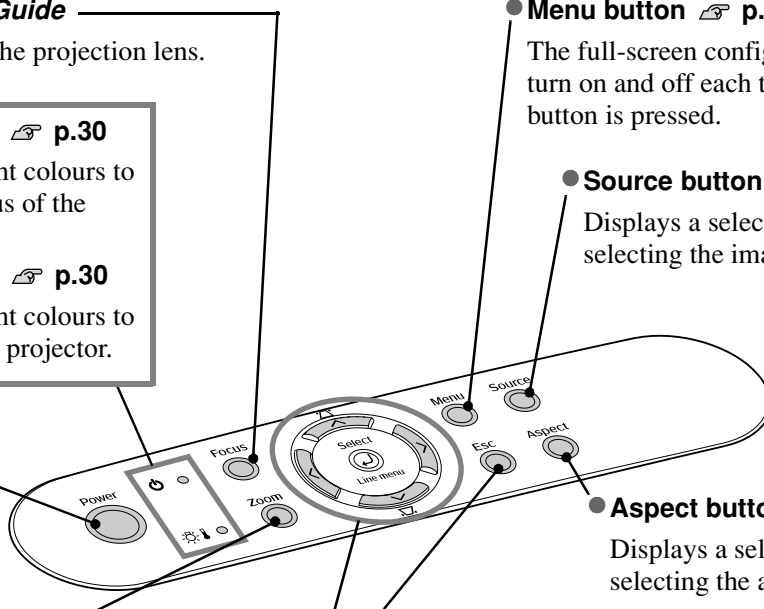
- 
- **Focus button** **Setup Guide**
Press to adjust the focus of the projection lens.
 - **Menu button** p.23
The full-screen configuration menus turn on and off each time the [Menu] button is pressed.
 - **Source button** **Setup Guide**
Displays a selection menu for selecting the image source.
 - **Aspect button** p.8
Displays a selection menu for selecting the aspect.
 - **Esc button** p.23
Pressing [Esc] while viewing a configuration menu or selection menu displays the previous menu.

- **⏻ (Operation) indicator** p.30
Flashes or lights in different colours to indicate the operating status of the projector.
- **⚠ (Warning) indicator** p.30
Flashes or lights in different colours to indicate problems with the projector.

- **Power button** **Setup Guide**
Press to turn the power on and off.
- **Zoom button** **Setup Guide**
Press to adjust the size of projected images.

- **Select/Line menu button** p.8, p.12, p.23
Displays the line menu. When viewing a configuration menu or selection menu, press this button to select the menu item and proceed to the next display.
- **^ / ▽ / ▾ / ▹ buttons** p.8, p.12, p.23, **Setup Guide**
Used as up/down buttons to select items in configuration menus and select menus. If the above menus are not displayed, correct the keystone distortion.
- **< > buttons** p.23, **Setup Guide**
Press the select adjustment values in a configuration menu and to adjust the zoom and focus.

Remote Control

Buttons with no explanation function in the same way as the corresponding buttons on the projector's control panel. Refer to "Control Panel" for further details on these buttons.

- **Remote control light-emitting area**

Setup Guide

Outputs remote control signals.

- **Indicator**

Illuminates when remote control signals are being output.

- **Menu button** *p.23*

- **Memory button** *p.12*

Displays a selection menu for selecting memory settings.

- **Select/Line menu button**

p.8, p.12, p.23

- **▲ ▼ ◀ ▶ buttons**

p.8, p.12, p.23, Setup Guide

Press to select configuration menu and selection menu items and adjustment values and to adjust the zoom and focus.

- **Pattern button** *Setup Guide*

Displays a selection menu for selecting a test pattern.

- **Zoom button**

Setup Guide

- **Blank button**

The projected images switch off and on each time this button is pressed.

- **(Illumination) button**

All buttons on the remote control illuminate when this button is pressed. The button illumination switches off automatically after about 10 seconds have passed.

- **On/Off buttons** *Setup Guide*

Press to turn the projector power on and off.

- **Color Mode button** *p.8*

Displays a selection menu for selecting the colour mode.

- **Aspect button** *p.8*

- **Esc button** *p.23*

Source

Setup Guide

- **D4 button:** Switches the input source to the projector's [D4] port. The signal changes as follows and the "Input Signal" menu also changes each time the button is pressed.



- **InputA button:** Switches the input source to the projector's [InputA] port. The signal changes as follows and the "Input Signal" menu also changes each time the button is pressed.

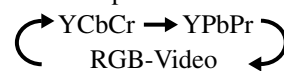

- **InputB button:** Switches the input source to the projector's [InputB] port.







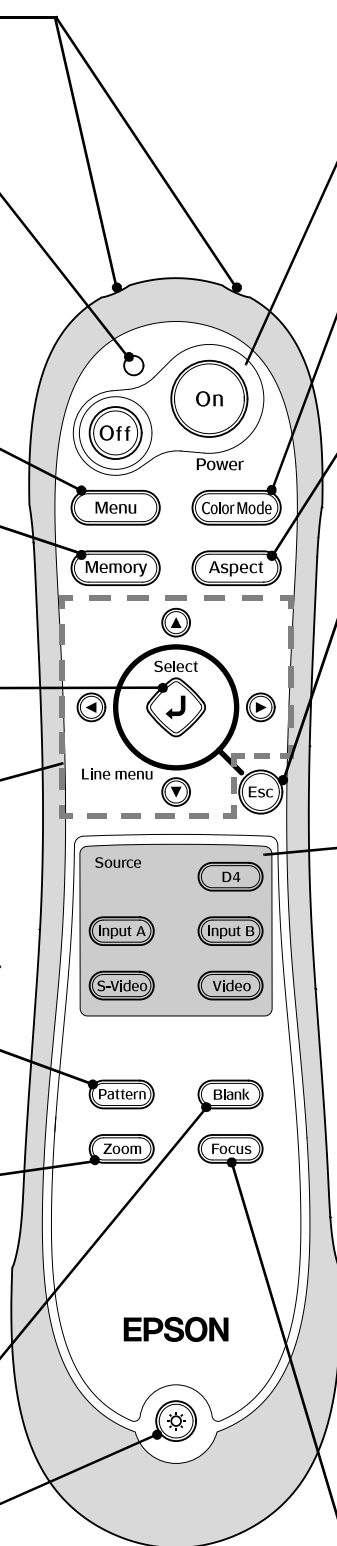





- **S-Video button:** Switches the input source to the projector's [S-Video] port.

- **Video button:** Switches the input source to the projector's [Video] port.



- **Focus button** *Setup Guide*

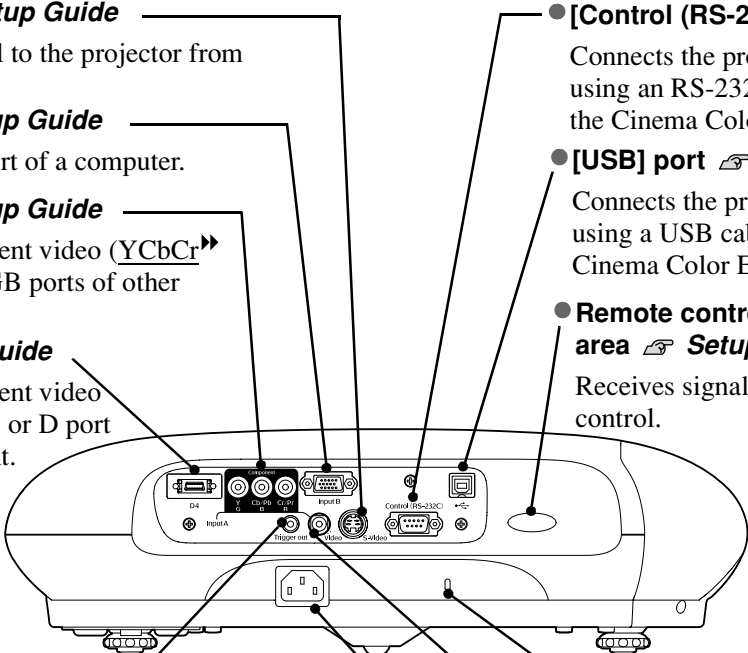

Rear

- **[S-Video] port**  **Setup Guide**
Inputs an S-Video signal to the projector from other video equipment.
 - **[InputB] port**  **Setup Guide**
Connects to the RGB port of a computer.
 - **[InputA] port**  **Setup Guide**
Connects to the component video (YCbCr^{▶▶} or YPbPr^{▶▶}) ports or RGB ports of other video equipment.
 - **[D4] port**  **Setup Guide**
Connects to the component video (YCbCr or YPbPr) ports or D port of other video equipment. (Japan only)
 - **[Control (RS-232C)] port**  **p.25**
Connects the projector to a computer using an RS-232C cable when using the Cinema Color Editor.
 - **[USB] port**  **p.25**
Connects the projector to a computer using a USB cable when using the Cinema Color Editor.
 - **Remote control light-receiving area**  **Setup Guide**
Receives signals from the remote control.
 - **[Trigger out] port**  **p.20**
When the projector power is turned on, a 12 V DC signal is output from this port. When the projector's power is turned off or a problem with operation occurs, the output becomes 0 V to communicate the projector's power ON/OFF status to an external device.
 - **Security lock** ^{▶▶} ()  **p.46**
 - **[Video] port**  **Setup Guide**
Connects to general video ports of other video equipment.
 - **Power inlet**  **Setup Guide**
Connects the power cable.
- 

Base

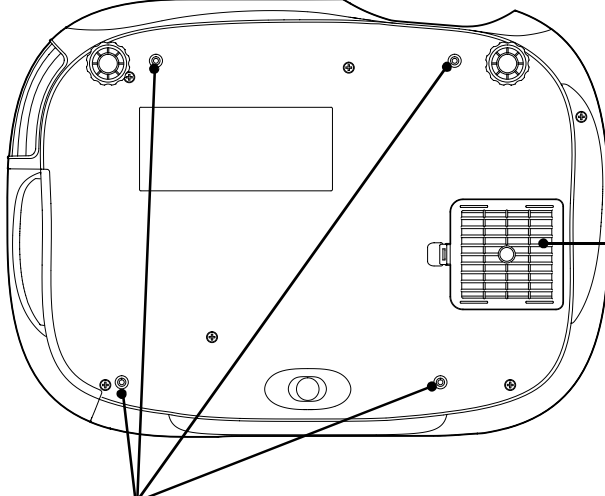
- **Air filter (air inlet)**  **p.36, p.38**
Prevents dust and other foreign particles from being drawn into the projector. It should be cleaned periodically.
 - **Suspension bracket fixing points (4 points)**  **p.40**
Install the optional ceiling mount here when suspending the projector from a ceiling.
- 

Appearance

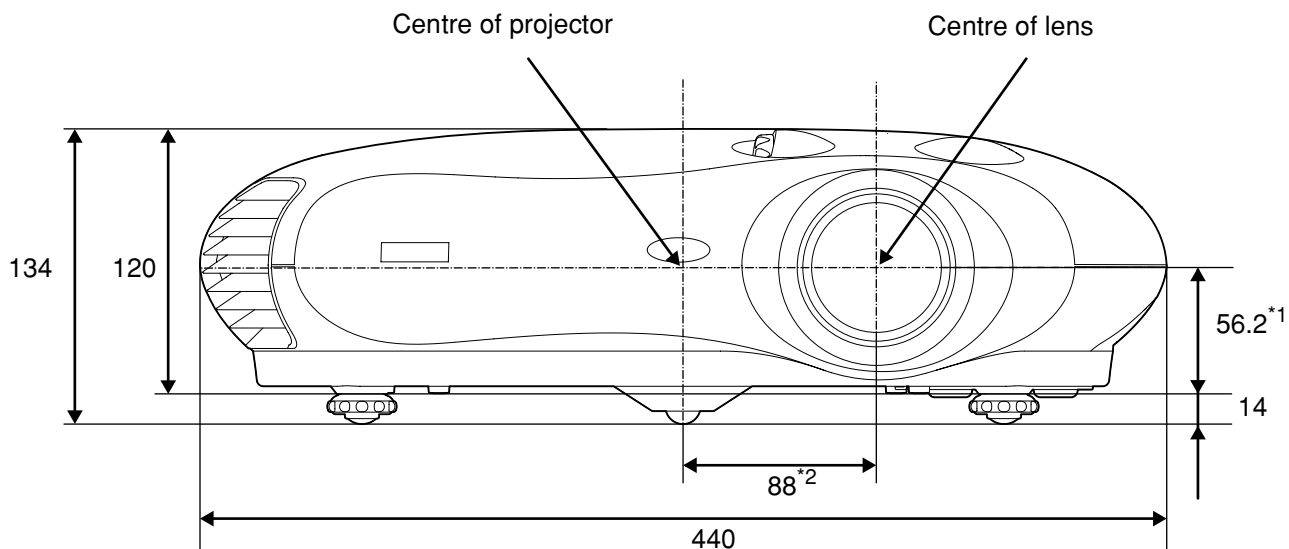

*1 Distance from centre of lens to suspension bracket fixing point
(Lens shift amount: Max. 8.7 mm upwards, Max. 4.3 mm downwards)

*2 Distance from centre of lens to centre of projector
(Lens shift amount: Max. 7.7 mm to the left and right)

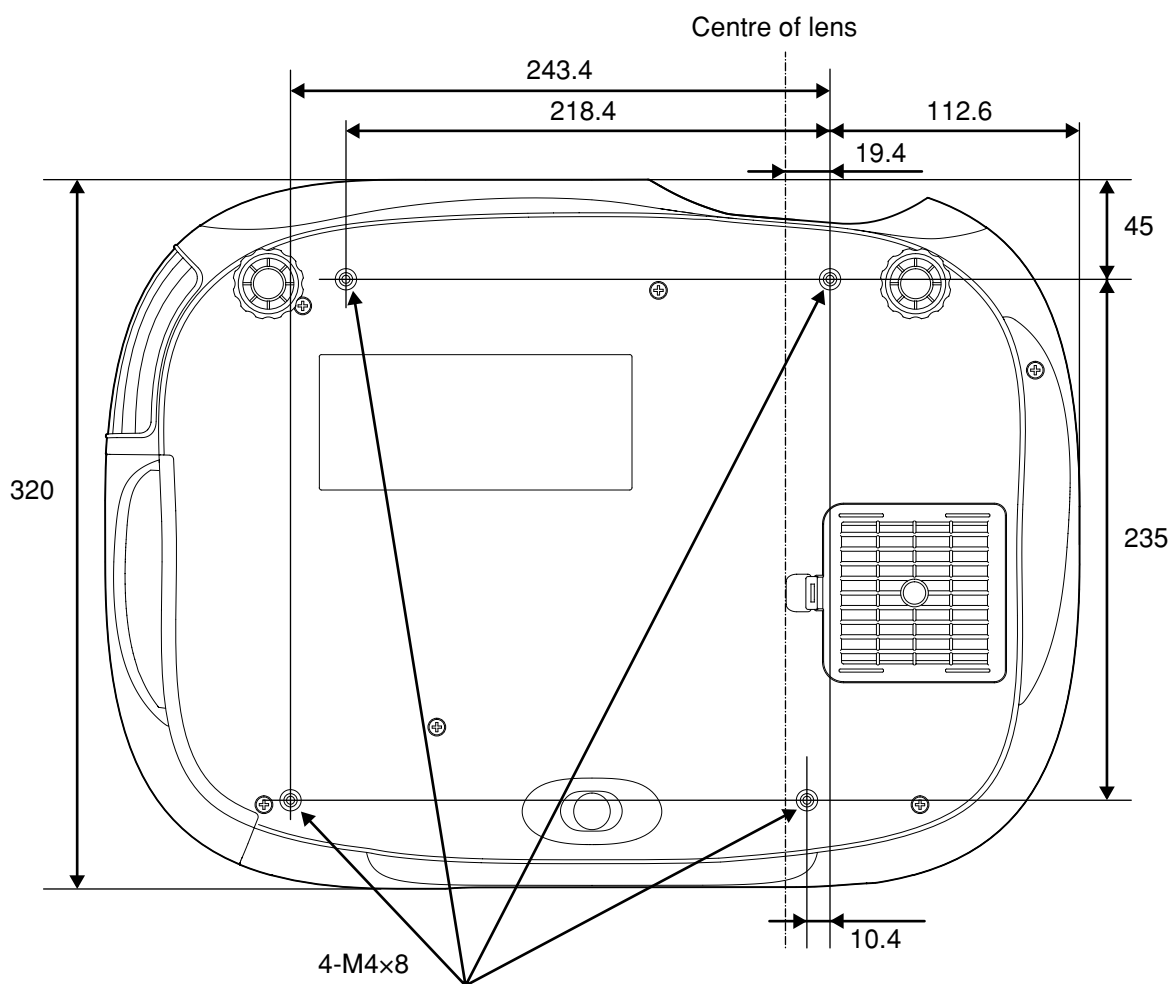

Units: mm

Basic Image Quality Adjustments

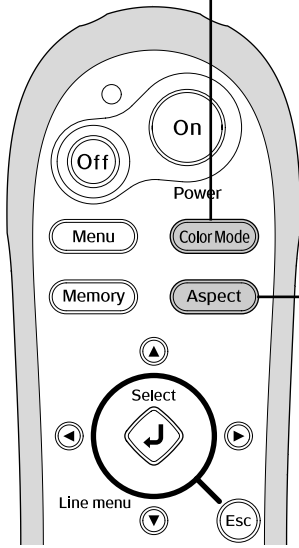

Selecting the Color Mode

*The colour mode selection menu cannot be activated when advanced memory settings have been retrieved.

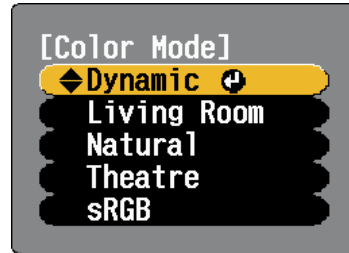

Default setting : Dynamic

Selecting the Image Aspect

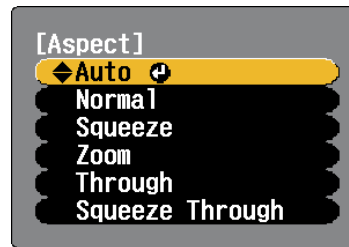

Default setting

When signals from the [Video], [S-Video] or [D4] port are being projected: Auto

When signals from the [InputA] or [InputB] port are being projected: Normal

Selection menu operations



Press or on the remote control or or on the projector's control panel to select an item.
Press or to confirm the selection.

* If you press , the selection menu disappears.

When projecting using the **Auto**

If the signals are being input to the [Video], [S-Video] or [D4] port, the optimum aspect is selected in accordance with the signal as follows.

- For 4:3 input signals → Normal
- For input images recorded in squeeze → Squeeze mode
- For letterbox input signals → Zoom







* If Auto is not suitable, the setting will become Normal.

Press **Color Mode** and select the colour mode from the five available modes in the selection menu in accordance with the place where the projector is being used. Setting is also possible using the configuration menu.

- Dynamic** : Ideal for using in bright rooms.
- Theatre** : Ideal for using in dark rooms.
- Living Room** : Ideal for using in rooms in which the curtains are closed.
- sRGB** : If the connected signal source has an **sRGB** mode, set both the projector and the connected signal source to sRGB. (Ideal for viewing computer images.)
- Natural** : Ideal for using in dark rooms. It is recommended that you start in this mode when making colour adjustments.

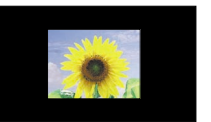
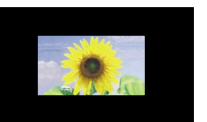
If "Natural", "Theatre" or "sRGB" is selected, the Epson Cinema Filter effect will be applied automatically. This increases contrast and makes flesh tones appear more natural.

Press **Aspect** and select the aspect mode from the selection menu.

Input signal	<ul style="list-style-type: none"> ● Images from normal TV broadcasts ● Images with standard aspect ratio (4:3) ● Computer images 	Images recorded by a video camera or DVD software in squeeze mode	Letterbox images	Images with an input resolution of 1280 × 720 or less	
				Images at standard size (4:3)	Images recorded in squeeze mode
Recommended aspect mode	Normal	Squeeze	Zoom	Through	Squeeze Through
Result	 <p>Black bands will appear at the left and right of the images.</p>	 <p>Input signals will be projected at the same width as the projector's panel resolution.</p>	 <p>Input signals will be projected at the same height as the projector's panel resolution.</p>	 <p>The images are projected onto the screen with the input signal resolution unchanged.</p>	 <p>Images will be projected in 16:9 format at the original input signal resolution.</p>
Remarks	<p>If HDTV images are projected, the images will be elongated horizontally.</p> 	<p>If 4:3 images are projected, the images will be elongated horizontally.</p> 	<ul style="list-style-type: none"> ● If 4:3 images are projected, the top and bottom of the images will be truncated. ● If images with subtitles are projected and the subtitles are truncated, use the "Zoom Caption" menu command to adjust.  p.19 	<ul style="list-style-type: none"> ● The images are not compressed or enlarged in accordance with the panel resolution, and so clearer images are projected. ● To project images so that they fill the whole of the screen, use the zoom adjustment or move the projector further away from the screen. ● If HDTV images are projected in Through mode, the images will be elongated horizontally. 	

Advanced Color Adjustments

The projector allows you to select the optimum colour settings for the images being projected by selecting the appropriate colour mode.

Furthermore, if you would like to create your own images with settings adjusted the way you want them, you can adjust "Color Temp.", "Flesh Tone" and/or "RGB" in the "Color Adjustment" sub-menu of the "Image" menu.

The adjustment values can be stored using the "Memory: Standard" menu command so that you can retrieve them and apply them to the projected images at any time. p.12

If you use the Cinema Color Editor CD-ROM that is included with the projector, you can make the above adjustments easily from a computer using a mouse. In addition, fine adjustments to the hue and saturation can also be carried out. These adjustments can be stored in the projector's memory, and they can also be saved in a computer file which can be exchanged with other people so that they can also see the results of the adjustments that you have made. p.24

If you press or , the line menu is displayed.

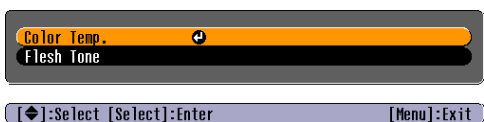

Colour temperature/ Flesh Tone Adjustments

Color temperature adjustment

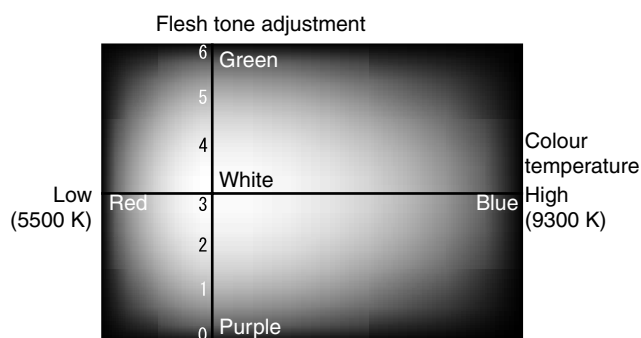

Press and select "Image" - "Color Adjustment" - "RGB".



RGB adjustment

• Offset adjustment

Brightness

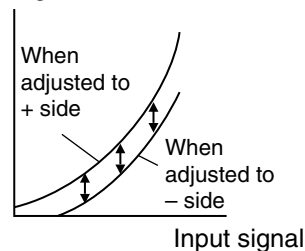

To make dark areas appear more clearly, adjust to the + side. If adjusted to the - side, the whole image will become sharper, but the contrast for dark areas will become poorer.



- **Colour temperature adjustment mode**

You can adjust the overall tint of images.

If you select "High", images appear bluish, and if you select "Low", images appear reddish. Select one of three levels: "High" (9300K), "Medium" (6500K) or "Low" (5500K).

- **Adjusting flesh tones**

This can be used to adjust the flesh tones for images of people.

The Epson Cinema Filter effect that is automatically applied to images when a "Color Mode" setting is made creates natural-looking flesh tones. If you would like to further enhance flesh tones, use this "Flesh Tone" setting to make the adjustment.

If set to the + side, the colours become greenish, and if set to the – side, the colours become reddish.

The image brightness can be adjusted by adjusting the individual R (red), G (green) and B (blue) components of the dark areas (offset), bright areas (gain) and intermediate areas (gamma) respectively. Because such detailed adjustments are possible, images with greater depth can be obtained.

- **Gain adjustment**

Brightness

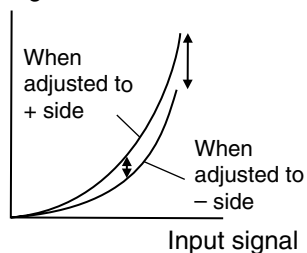

If you would like bright areas to appear more clearly, change the setting to the – side. If you change it to the + side, bright areas will become whiter, but the contrast will become poorer.

- **Gamma adjustment**

Brightness

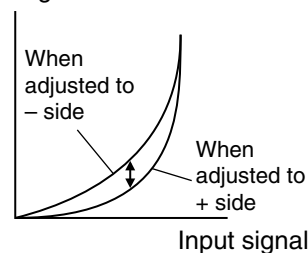

If the setting is changed to the – side, smoother images can be obtained. If the setting is changed to the + side, sharper images can be obtained.

Viewing images at a preset image quality (memory function)

After menu commands such as "Picture Quality" and "Color Adjustment" have been used to adjust the projected images, the adjustment values can then be saved.

In addition, the saved data can be retrieved easily, so that you can enjoy viewing images with the adjusted settings at any time.

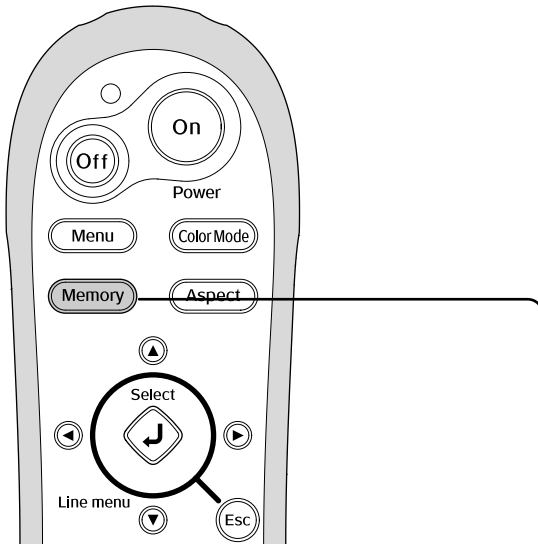

Selection menu operations



Press or on the remote control or or on the projector's control panel to select an item.

Press or to confirm the selection.

* If you press , the selection menu disappears.

Select an item to move to the next menu level for that item.

Saving image quality adjustments (Memory save)

Settings that can be saved in memory

- Configuration menus p.14

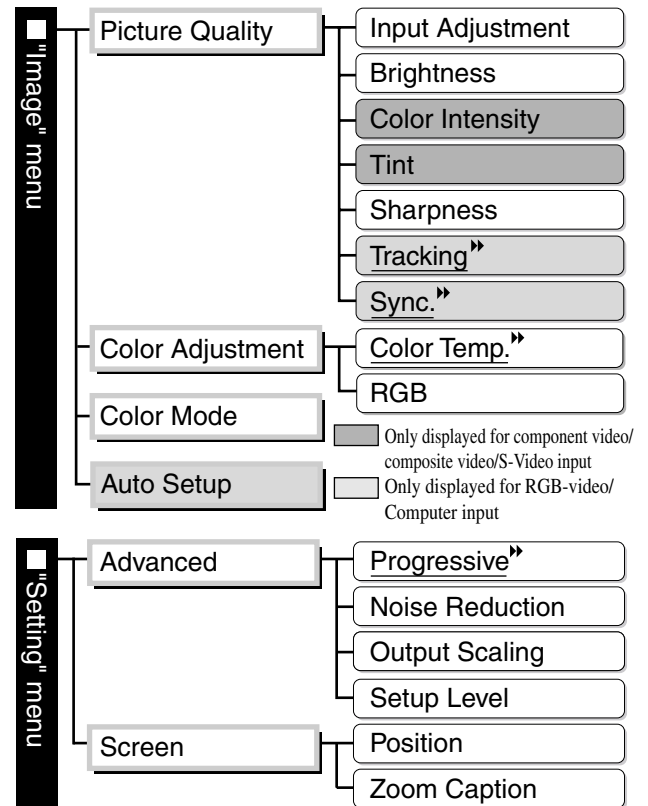

- Aspect setting p.8

Retrieving image quality adjustments (Memory retrieve)





The adjustment results for all of the configuration menu items shown at left and the aspect setting can be saved. The "Memory: Standard" command in the "Image" menu is used to save the settings.



The Cinema Color Editor program can also be used to store and retrieve memory settings from a computer. Two types of memory area ("Standard" and "Advance") are available, and each can store up to 6 sets of settings. If you have used Cinema Color Editor to adjust the hue and saturation, save these settings using "Memory: Advance". [p.28](#)

The following describes how to save settings using the "Memory: Standard" command.

- 1 Adjust the desired settings that you would like to save in memory.
- 2 Select "Memory: Standard" from the "Image" menu and then press .
- 3 Select a memory name from MEMORY1 to MEMORY6 to use for saving and then press .

The status of a memory area is indicated by the colour of the  symbol to the left of the memory name as follows.

 Green : Memory area is in use  Grey : Memory area is not in use  Orange : Selected

If you select a memory area that is already in use and press , the existing contents will be erased and the current settings will be saved in their place.

To erase all memory contents, select "Memory Reset" from the "Reset" menu. [p.22](#)

You can press  and select the desired memory name from the selection menu. If settings have been saved using both the "Memory: Advance" and the "Memory: Standard" commands, a screen for selecting the "Memory: Standard" or "Memory: Advance" screen will be first displayed. Select the memory area where the settings that you would like to retrieve is stored.



- Memory settings that have been applied to images will be retained even when the projector's power is turned off. The same memory adjustment settings will be applied to images that are projected the next time the projector's power is turned on.
- The aspect setting retrieved from memory may not be applied to the images if they are 16:9 images or if the input signal images have a particular resolution.
- If "Memory: Advance" adjustment settings have been retrieved, you can return the settings to the way they were before the "Memory: Advance" adjustment settings were retrieved. To do this, select "Last Memory" from the selection menu.

Configuration Menu Functions

The configuration menus can be used to make a variety of adjustments and settings involving the screen, image quality and input signals.

The following two types of menu are available.

- Full menu

All items in a configuration menu can be checked while the settings are being made.

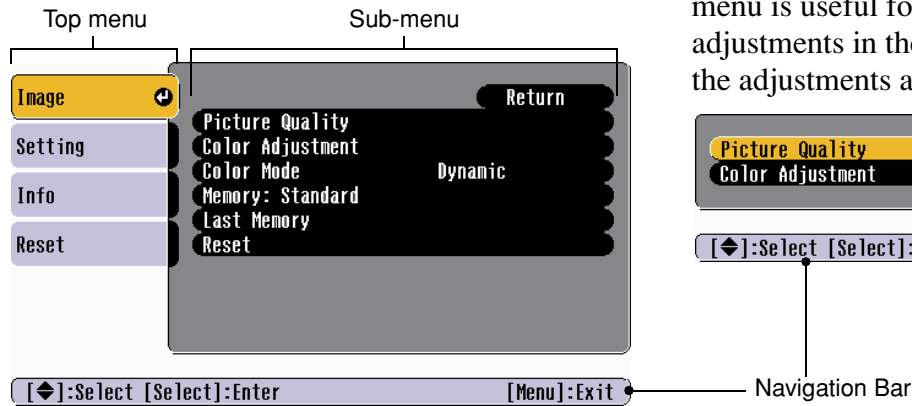

- Line menu

This lets you adjust "Picture Quality" and "Color Adjustment" settings in the "Image" menu. This menu is useful for viewing the effects of adjustments in the images being projected while the adjustments are being made.

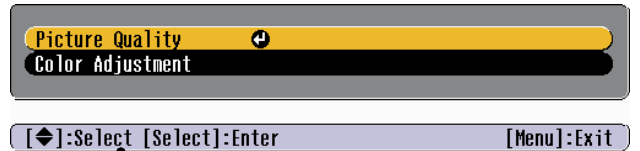

Refer to "Using the configuration menus" (p.23) for details on menu operations.



You can also change the navigation bar ON/OFF status and colour pattern settings for the configuration menus. The display position can also be changed for full menus.

☞ "Setting" - "On-Screen Display" - "Menu Position", "Navigation Bar", "Menu Color"

List of Configuration Menus

If no image signals are being input, none of the settings can be adjusted except for "Brightness" in the "Picture Quality" sub-menu of the "Image" menu. The items displayed in the "Image" menu and the "Info" configuration menu will vary depending on the type of image signals that are being projected. Some menu commands cannot be set when advanced memory settings have been retrieved.

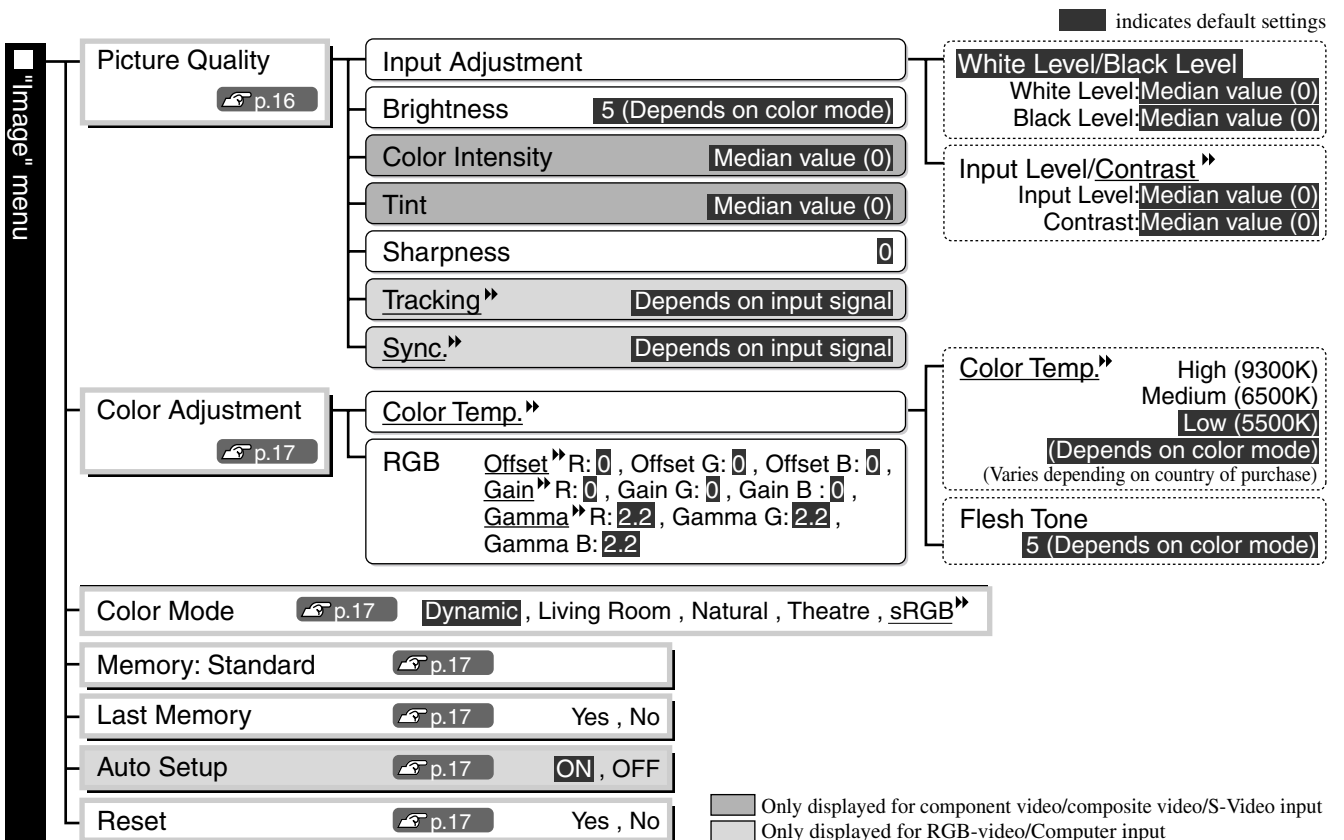

■ indicates default settings

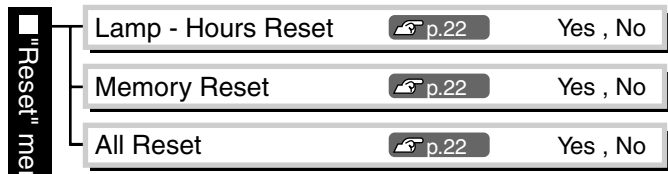
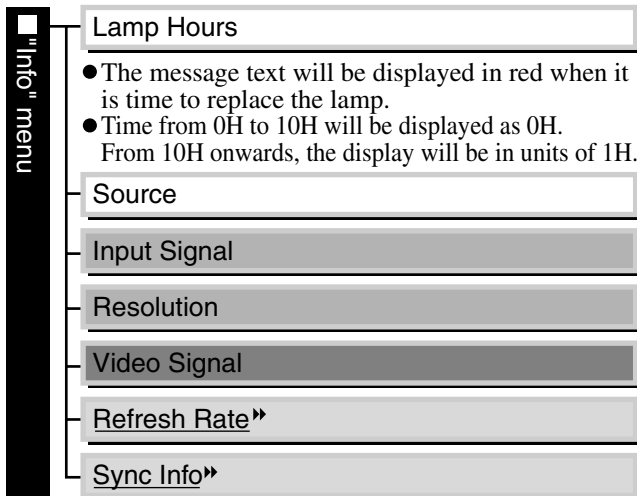
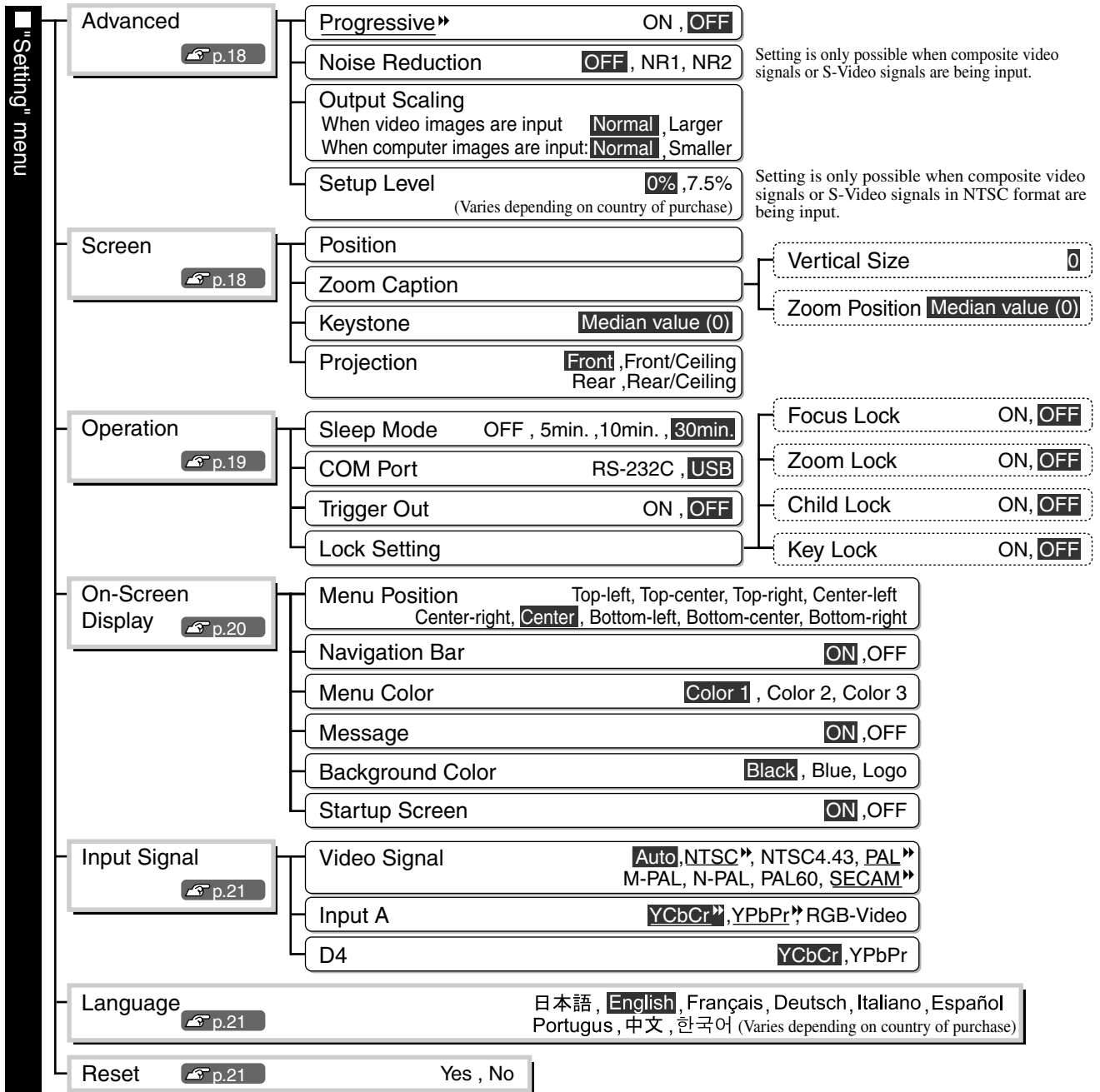

■ Only displayed for composite video/S-Video input
 ■ Only displayed for component video/RGB-video/Computer input
 ■ Only displayed for RGB-video/Computer input

The "Info" menu is only used to display the projector status.

"Image" menu

Only displayed for component video/composite video/S-Video input
 Only displayed for RGB-video/Computer input

Picture Quality	Default setting
<p>Input Adjustment *¹</p> <p>These settings can be adjusted if the output level from the connected equipment is weak and the images appear dark. The two settings cannot be made simultaneously. You can only select one of them to be adjusted.</p> <ul style="list-style-type: none"> White Level/Black Level: These adjust the dark and light areas of images White Level: Adjusts the brightness of bright shades without changing the black level. When the setting is changed to the - side, bright areas become clearer. Black Level: Adjusts the brightness of dark shades without changing the white level. When the setting is changed to the + side, dark areas become clearer. Input Level/Contrast▶▶: Adjusts the overall brightness of the images. Input Level: Adjusts the overall brightness of the images. When the setting is changed to the + side, the images appear brighter overall. Contrast: Adjusts the difference between bright and dark areas. When the contrast is increased, images with greater modulation are obtained. 	<div style="background-color: #cccccc; padding: 5px; margin-bottom: 10px;">White Level/ Black Level</div> <div style="background-color: #e0e0e0; padding: 5px; margin-bottom: 10px;">White Level: Median value (0)</div> <div style="background-color: #e0e0e0; padding: 5px; margin-bottom: 10px;">Black Level: Median value (0)</div> <div style="background-color: #e0e0e0; padding: 5px; margin-bottom: 10px;">Input Level: Median value (0)</div> <div style="background-color: #e0e0e0; padding: 5px;">Contrast: Median value (0)</div>
<p>Brightness *²</p> <p>The brightness of the images can be adjusted. If projecting in dark rooms or onto small screens and the images appear too bright, decrease the setting. If the setting is reduced to 0 or less, power consumption can be reduced by up to approximately 25%.</p>	<div style="background-color: #cccccc; padding: 5px;">5 (Depends on color mode)</div>
<p>Color Intensity *¹</p> <p>This adjusts the colour intensity for the images.</p>	<div style="background-color: #cccccc; padding: 5px;">Median value (0)</div>
<p>Tint *¹</p> <p>(Adjustment is only possible when <u>composite video</u>▶▶ and <u>S-Video</u>▶▶ signals in <u>NTSC</u>▶▶ format are being input) This adjusts the image tint.</p>	<div style="background-color: #cccccc; padding: 5px;">Median value (0)</div>
<p>Sharpness *¹</p> <p>This adjusts the image sharpness.</p>	<div style="background-color: #cccccc; padding: 5px;">0</div>
<p>Tracking▶▶ *¹</p> <p>This adjusts the images if vertical stripes appear in the images.</p>	<div style="background-color: #cccccc; padding: 5px;">Depends on input signal</div>
<p>Sync.▶▶ *¹</p> <p>This adjusts the images if flickering, fuzziness or interference appear in the images.</p> <ul style="list-style-type: none"> Flickering and fuzziness may also appear in images when the brightness, contrast, sharpness and keystone correction settings are adjusted. Clearer adjustments can be obtained if you adjust the tracking first and then adjust the sync. 	<div style="background-color: #cccccc; padding: 5px;">Depends on input signal</div>

*1 The setting values are stored separately for each image source and signal type.

*2 The setting values are stored separately for each image source and colour mode setting.

Only displayed for RGB-video/Computer input

Color Adjustment

Default setting

"Color Adjustment" cannot be selected when the colour mode is set to "sRGB".

Color Temp.▶▶ *2

- Color Temp. : The colour temperature can be selected from three settings in order to adjust the overall tint of the images that are being projected. p.10
- Flesh Tone : This adjusts the flesh tones of people who appear in the images. p.10

Low (5500K)
(Depends on colour mode)

5 (Depends on color mode)

RGB *1

This adjusts the brightness of the dark, bright and intermediate areas of the images. p.10

Offset▶▶ R/G/B: 0
Gain▶▶ R/G/B: 0
Gamma▶▶ R/G/B: 2.2

Color Mode *1

Default setting

The Color Mode can be selected from five different settings in accordance with the images being projected. p.8

Dynamic

Memory: Standard

This can be used to save the current configuration menu settings and the aspect▶▶ . p.12

Last Memory *1

This command causes images to be displayed back at their original settings if they have been adjusted according to settings that were loaded using the "Memory: Advance" command. To return images to their original settings, select "Yes".

Auto Setup *1

Default setting

This sets automatic adjustment to on or off in order to set whether the projector automatically adjusts images to their optimum condition when the input signal is changed.

ON

Reset

This returns all settings in the "Image" menu to their default settings, except for the settings that have been saved using the "Memory: Standard" command. The "Memory: Standard" settings can be reset using the "Memory Reset" menu. p.22

*1 The setting values are stored separately for each image source and signal type.

*2 The setting values are stored separately for each image source and colour mode setting.

"Setting" menu

Advanced	Default setting
<p>Progressive *¹</p> <p>(Setting is only possible when 525i or 625i <u>component video</u> signals are being input)</p> <ul style="list-style-type: none"> ● OFF :IP conversion is carried out for each field in the screen. This is ideal for using when viewing images with a large amount of movement. ● ON :<u>Interlaced</u> (i) signals are converted into progressive (p) signals. This is ideal for using when viewing still images. 	OFF
<p>Noise Reduction *¹</p> <p>(Setting is only possible when composite video signals or S-Video signals are being input.)</p> <p>This suppresses interference in images and makes the images appear softer. If viewing images with little or no interferences, such as images from DVDs, it is recommended that you change this setting to "OFF".</p>	OFF
<p>Output Scaling *¹</p> <p>This changes the display area (the part of images projected).</p> <ul style="list-style-type: none"> ● When <u>component video</u>, <u>composite video</u> or <u>S-Video</u> signals are being input <ul style="list-style-type: none"> Normal (92% display) :Input signals are projected at the normal image size. TV images are displayed at 92% size. Larger (95% display) :The areas at the top, bottom and sides of images that cannot normally be seen are inserted and projected. Interference may occur at the top or bottom of the images depending on the image signal. ● When RGB-video or computer signals are being input <ul style="list-style-type: none"> Normal (100% display) :Input signals are projected at the full image size. Smaller (95% display) :The edges of the images are truncated when projected. Select this option if there is interference at the top or bottom of the images. 	Normal
<p>Setup Level *¹</p> <p>(Setting is only possible when composite video signals or S-Video signals in <u>NTSC</u> format are being input.)</p> <p>If using products designed for destinations such as the United States or South Korea that have different black level (setup level) settings, use this function to obtain correct images. Check the specifications of the connected equipment when changing this setting.</p>	0% (Varies depending on country of purchase)
Screen	Default setting
<p>Position *¹</p> <p>Use ▲, ▶, ▼ and ◀ to move the display position for images.</p>	

*1 The setting values are stored separately for each image source and signal type.

Zoom Caption *1

If **aspect** is set to "Zoom" when viewing images with subtitles, change the setting as follows so that the subtitles are visible. The vertical size and the display position can both be adjusted together.

● **Vertical Size**

The vertical size of the image is reduced so that the subtitles are displayed.

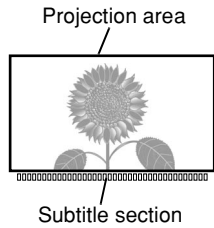

Use "Vertical Size" to reduce the image size.



Use "Zoom Position" to change the display position of the image.



● **Zoom Position**

The whole of the image is moved up so that the subtitles are displayed.

0

Median value (0)

Keystone

This is used to correct keystone distortion in images. The same correction can be carried out using the projector's control panel. *Setup Guide*

Median value (0)

Projection

This should be set in accordance with the method used to set up the projector.

- **Front** : Select when the projector is set up in front of the screen.
- **Front/Ceiling** : Select when the projector is set up in front of the screen and suspended from a ceiling.
- **Rear** : Select when the projector is set up behind the screen.
- **Rear/Ceiling** : Select when the projector is set up behind the screen and suspended from a ceiling.

Front

Operation

Default setting

Sleep Mode

The projector is equipped with a power-saving function that causes the power to turn off automatically and the projector to switch to standby if no signal is input to the projector for a continuous length of time. The length of time before the power-saving function operates can be selected from four available settings. If "OFF" is selected, the power-saving function will not operate.

If you press **On** while the projector is in standby mode, projection will start again.

30min.

COM Port

This selects the port that is used to connect a computer when using the Cinema Color Editor to adjust the picture quality of images from the computer.

If you change the setting, the new setting will take effect after the power has been turned off and the **cool-down** period is complete.

USB

*1 The setting values are stored separately for each image source and signal type.

Trigger Out

This turns the trigger function on and off to determine whether the projector's power on/off status and problems with projector operation are communicated to an external device.

If you change the setting, the new setting will take effect after the power has been turned off and the cool-down period is complete.

OFF

Lock Setting

This sets whether the following lock functions are turned on or off. When a lock function is turned on, a  is displayed on the screen when a locked operation is carried out.



● **Focus Lock** :Focus adjustment is disabled.

OFF

● **Zoom Lock** :Zoom adjustment is disabled.

OFF

● **Child Lock** :This locks the power on function of the  button on the projector's control panel, so that a child cannot accidentally turn the projector's power on and look into the projector's lens.

When the lock is applied, the power will only turn on if  is pressed down for about 3 seconds.  can be used to turn off the power, and the remote control will continue to operate as normal.

The remote control operation is unaffected by this setting.

If you change the setting, the new setting will take effect after the power has been turned off and the cool-down period is complete.

OFF

● **Key Lock** :The buttons on the projector's control panel will not operate. (If this is set to "ON", the "Child Lock" setting cannot be made.)





If you change the setting, the new setting will take effect after the configuration menu is disappears.

OFF

On-Screen Display

Default setting

Menu Position

Press , ,  and  to specify the position for the full menu to be displayed.

Center

Navigation Bar

This sets whether the navigation bar for the configuration menus is displayed (ON) or not displayed (OFF).

ON

Menu Color

The colour for the main configuration menu (full menu) and the navigation bar can be selected as follows.

● **Color 1:Blue**

● **Color 2:Green**

● **Color 3:Red**

Color 1

Message

This sets whether the following message displays appear (ON) or don't appear (OFF).

● **Image signal, colour mode , aspect** and item name when memory settings are retrieved

● Messages such as when no image signals are being input, when an incompatible signal is input, and when the internal temperature rises

ON

Background Color

Selects the screen status when a blank screen or the start-up screen (the image that is projected when projection starts) is being projected.

Black

Startup Screen

This sets whether the start-up screen (the image that is projected when projection starts) is displayed (ON) or not displayed (OFF).

If you change the setting, the new setting will take effect after the power has been turned off and the cool-down period is complete.

ON

Input Signal Default setting

Video Signal

(Adjustment is only possible when composite video or S-Video signals are being input)

This sets the video signal format. If "Auto" is selected, the video signal format is set automatically. If there is a lot of interference in the image, or if a problem such as no image being projected occurs even though "Auto" has been selected, select the correct signal format.

Auto

Input A

Change this setting depending on the type of signal that is being output from the video equipment that is connected to the [InputA] port.

YCbCr

D4

Select "YCbCr" or "YPbPr" depending on the type of signal that is being output by the source that is connected to the [D4] port.

YCbCr

Language Default setting

This sets the display language for messages and menus.

English
(Varies depending on country of purchase)

Reset

This returns all settings in the "Setting" menu to their default settings, except for the "Input Signal" and "Language" settings.

"Reset" menu

Lamp-Hours Reset

This initialises the lamp operating time. When this command is selected, the cumulative operating time for the lamp is cleared and returned to the default setting.

Memory Reset

This resets (erases) all settings that have been made using the "Memory: Standard" and "Memory: Advance" commands. "Memory: Advance" settings can be saved using the Cinema Color Editor.

All Reset

This resets all configuration menu settings to their default settings. The "Memory: Standard", "Memory: Advance", "Input Signal", "Lamp Hours" and "Language" settings will not be reset.

Using the Configuration Menus

1 Displaying a menu

Full menu: Press .

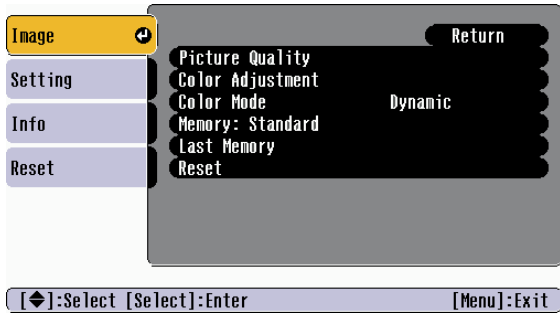

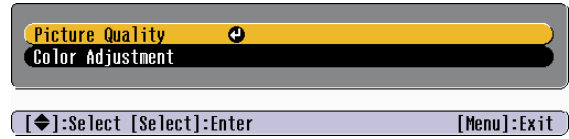

Line menu: Press .



The line menu cannot be activated when advanced memory settings have been retrieved.

2 Selecting a menu item



Use  and  to select a menu item, then press .



3 Changing settings

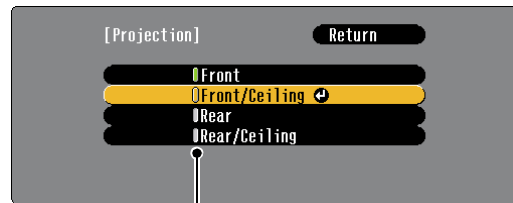



Use  and  to adjust values.



-  (green): Current setting value
-  (orange): Currently-selected item

Use  and  to select an item, then press .

If you press  when an item with  next to it is selected, the selection screen for that item will be displayed.

To return to a previous display, press . Alternatively, select [Return] and then press .

4 When setting is complete

Press .

Preparation for Using Cinema Color Editor

Installing Cinema Color Editor

If any other applications are open, close them before installing Cinema Color Editor.

1 Insert the accessory Cinema Color Editor CD-ROM into your CD-ROM drive.

Windows: The installer will start automatically.

Macintosh: Click the "Installer for Mac OS Classic" icon or the "Installer for Mac OS X" icon in the "EPSON" window, depending on the operating system you are using.

A virus check program window will be displayed, so check the contents of this window and then click [Continue].

The software verification window will be displayed.

● Windows

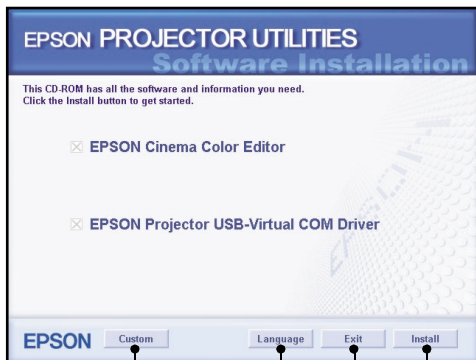

Select the software to be installed
Change the display language
Close the installer
Start installation

● Macintosh

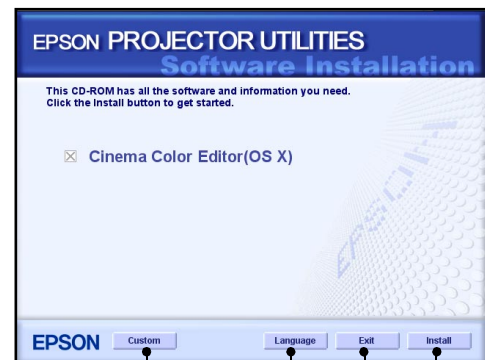

Select the software to be installed
Change the display language
Close the installer
Start installation



If using Windows:

- If connecting to a computer using a USB cable, be sure to install the USB driver (EPSON Projector USB-Virtual COM Driver).
- If the setup program does not start automatically, click [Start] - [Run] and then open the "Browse" dialogue box and select "[CD-ROM drive]:\EPSETUP.exe" and then click [OK].

2 Check the settings and then click [Install].

Installation will start. Follow the instructions which appear on the screen to complete the installation.

3 Click [Exit] to finish the installation.

If using a Macintosh and a message may be displayed prompting you to restart the computer. If this happens, follow the instructions in the message and restart your computer.

Uninstalling Cinema Color Editor

If you no longer require Cinema Color Editor, uninstall it by following the procedure below.

● Windows

From My Computer, open the Control Panel, double-click "Add or Remove Programs", select "Cinema Color Editor", and then click Add/Remove] (or [Change/Remove] for Windows XP).

● Macintosh

Follow the instructions that are displayed on the screen until the following window is displayed.

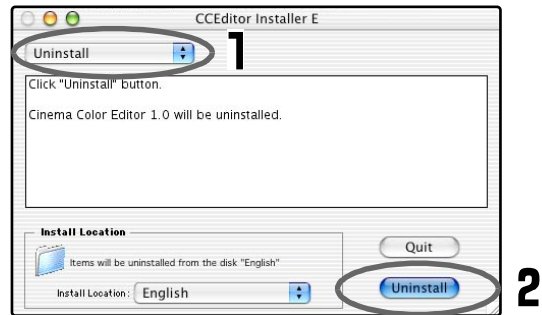

1 Select Uninstall.

2 Click [Uninstall].

Connecting to a Computer

In order to use Cinema Color Editor to adjust the quality of images, connect the computer to the projector using a USB cable or an RS-232C cable.

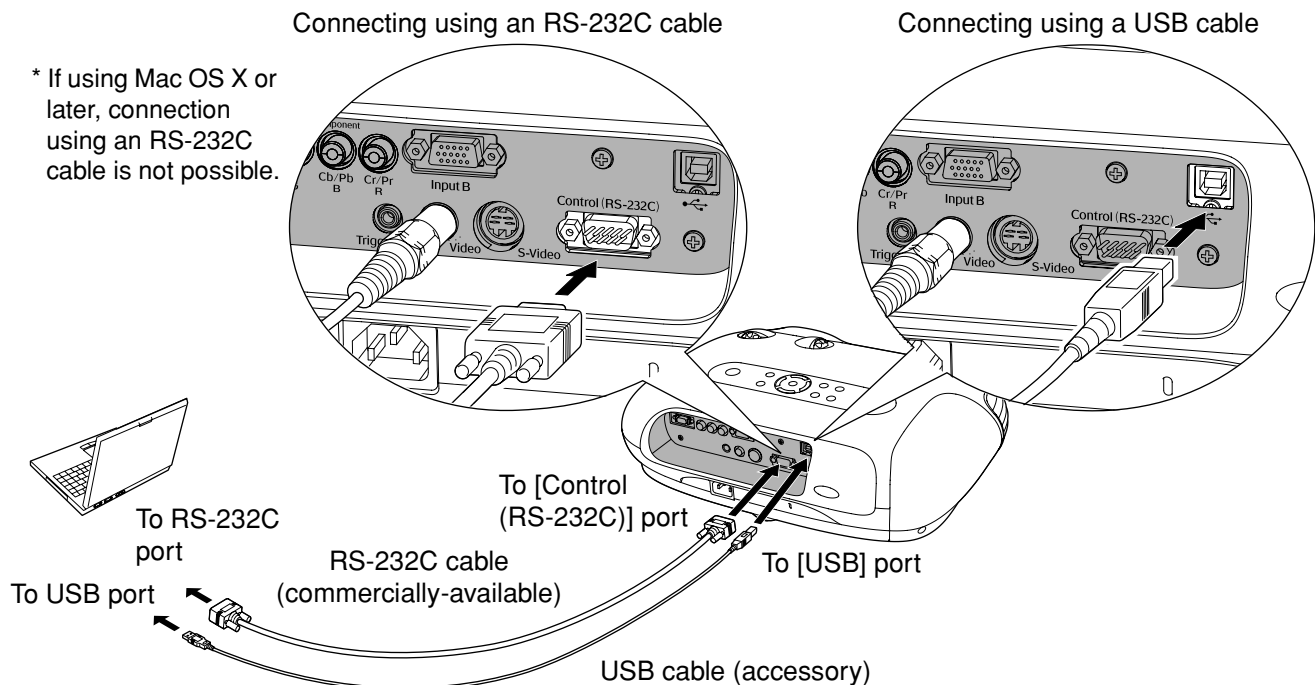

- Use the "COM Port" command in the "Operation" sub-menu of the "Setting" menu to select the port that is being used for the connection. Default setting: USB p.19
- If the "Add New Hardware Wizard" window appears when a Windows computer is connected to the projector by means of a USB cable, click [Cancel]. Install the USB driver (EPSON Projector USB-Virtual COM Driver) before making the connection.
- A maximum of 127 projectors can be connected to a single computer using a USB port, and a maximum of 2 projectors can be connected to a single computer when using an RS-232C port.

Using Cinema Color Editor

The following information describes how to use the Windows edition of the program. The Macintosh edition works in basically the same way.

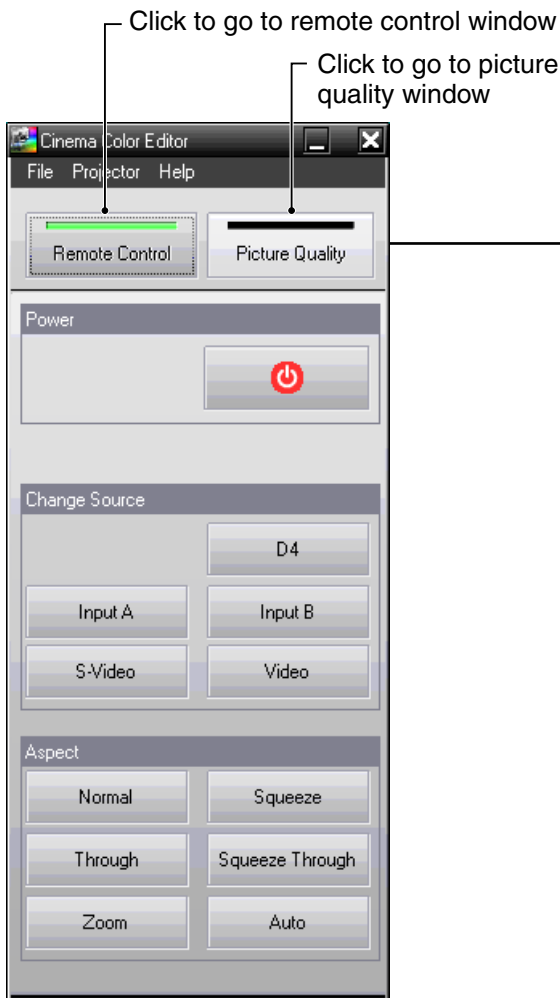

Starting Cinema Color Editor

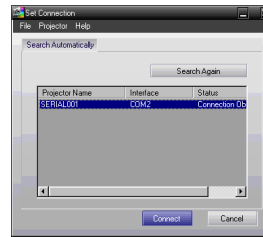

Operations using the Computer

Picture quality window

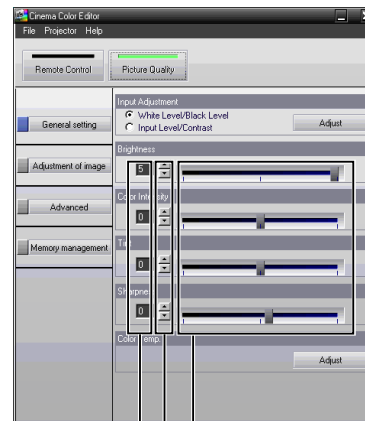

- Drag the gauge button to the left or right to adjust. *
- Click to increase or decrease the value.
- Type in a value and press the [Enter] or [Return] key on your computer keyboard.

* The adjustment will be applied to the images after the gauge is adjusted and you release the mouse button.

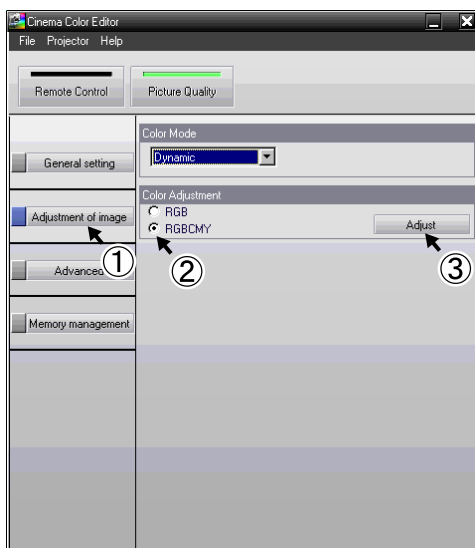

Click as above in order to display the "RGBCMY" window.

Adjusting the color hue and saturation

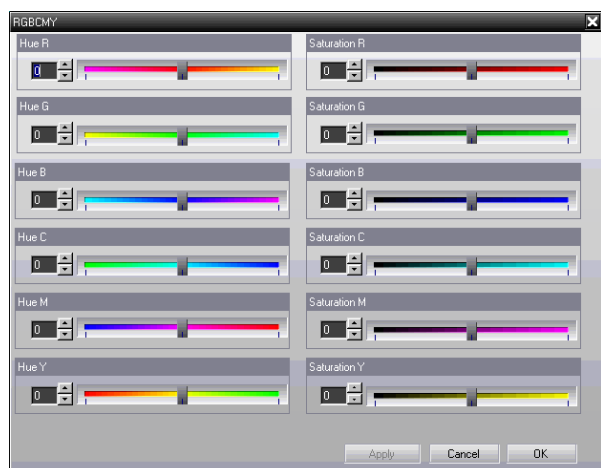

After making the adjustments, click [Apply] to apply the adjustments to the images.

If you click [OK], the adjustment window will close.

Check that the power for the projector to be adjusted is turned on, then start Cinema Color Editor.

For Windows : Click "Start" → "Programs" → "EPSON Projector" → "Cinema Color Editor" in that order.

For Macintosh : Click "Finder" and then "Applications" from the "Dock (Macintosh HD)", and then

(Names may vary depending on the version being used.) double-click "CCEditor" and "Cinema Color Editor (V1.0)" in that order.

After the opening screen, the connection screen will be displayed.

The connected projectors will be displayed, so select the projector that you would like to adjust the images for, then click [Connect].

Projector image adjustments and remote control operations can be carried out easily using a mouse.

Items that can be set

Click a button at the left of the window to carry out the following adjustments. The same adjustment as the corresponding configuration menu command can be carried out. [p.14](#)

General setting

- White Level/Black Level
- Input Level/Contrast” ● Brightness
- Color Intensity ● Tint ● Sharpness
- Color Temp.” ● Tracking* ● Sync.*

Adjustment of image

- Color Mode ● Color Adjustment

Advanced

- Progressive” ● Noise Reduction
- Output Scaling ● Setup Level
- Auto Setup*

* Only displayed when RGB-video/computer signals are being input.

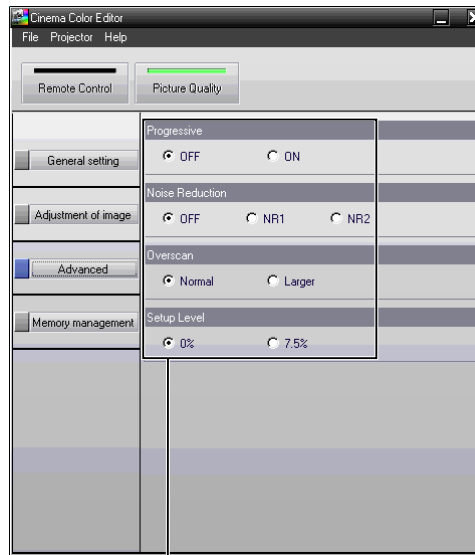

Click the item to be set.



If typing in values with decimal points, such as gamma values, use the "." character as the decimal point. "," cannot be used.

Remote control window

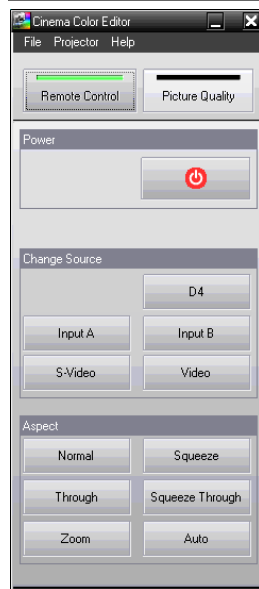

Click a button to carry out the same operation as the remote control button.

Cinema Color Editor can be used to make colour adjustments such as hue and saturation for red (R), green (G), blue (B), cyan (C), magenta (M) and yellow (Y) colours in order to obtain the preferred colours for images. You can reproduce the colours for a favourite movie to appear as though you are in a cinema, or adjust the colours to completely different colours if desired.

Hue : Adjusts the overall coloration of the images towards blue, green or red.

Saturation : Adjusts the overall brightness of the images.

Saving adjustments/Loading adjustments from a file

The adjustment settings of the projected images can be saved as computer files. The adjustments stored in these files can then be reloaded and applied to the projected images. In addition, these files can be sent to other people so that they can view the effects of your adjustments. You can also load the adjustment settings from a computer file into projector memory and retrieve them. [p.28](#)

Saving files and applying settings is done from the "File" menu.

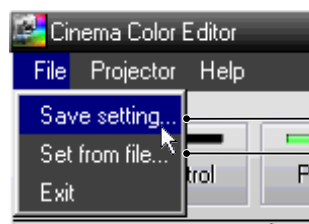

Saves current projector settings in a file

Adjustment values saved in the file are applied to the currently projected images.

Click **Memory management**

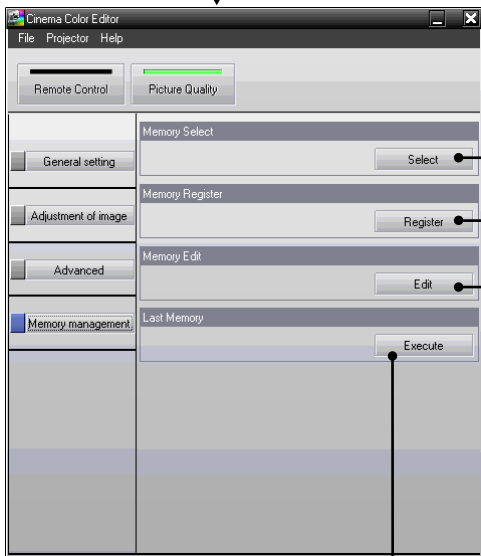

Operates in the same way as the projector's Last Memory function.

Loads settings from a memory area
Saves adjustments into a memory area

Saving customised settings into memory

Saving adjustment values into memory

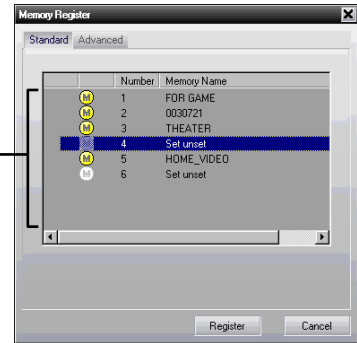

Memory list

Indicates the projector memory status.

- M** (yellow): In use
- M** (grey): Not in use

Saving/loading memory settings and editing memory area names

Memory list

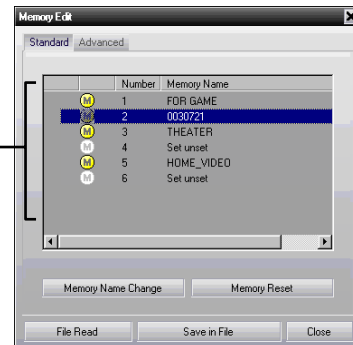

Saving adjustment values from the projector's memory onto the computer

- 1** Select the memory area to be used for saving using the memory list.
- 2** Click [Save in File].
- 3** Select the saving location, type in a filename and then click [Save].
If a file with the same name already exists, a message will be displayed.

Loading adjustment values from a saved file into projector memory

- 1** Select a memory number for saving from the memory list.
- 2** Click [File Read].
- 3** Select the file to be loaded in the file selection window, and then click [Open].
If the saved memory area is selected, a message will be displayed.

- 1 Make the desired adjustments.**
- 2 Select the memory area to be used.**

The following two types of memory area are available, and up to 6 sets of adjustment settings can be saved in each. The type of memory area that are available will vary depending on the "Color Adjustment" settings.

Standard

When "Color Adjustment" has been set with "RGB"

Advance

When "Color Adjustment" has been set with "RGBCMY"

- 3 Select the memory area to be used for saving from the memory list, and then click [Register].**

Retrieving saved memory settings

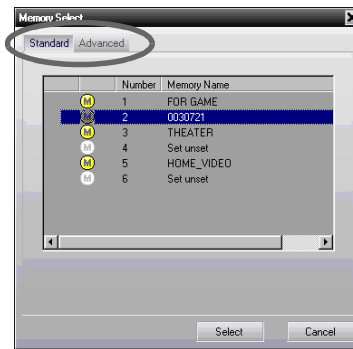

- 1 Click the "Standard" or "Advanced" tab to select the type of memory.**
- 2 After selecting the memory area to be retrieved from the memory list, click [Select].**
The selected adjustment values will be applied to the images.

"Memory Edit" can be used to carry out the following processes easily.

Saving the projector's memory settings to a computer file

Computer files can be loaded into the projector's memory.

This lets you save memory settings in a computer so that you do not need to be limited by the six available memory areas of the projector, so that they can be loaded into the projector whenever needed.

Changing a memory area names

The preset names such as "MEMORY1" and "MEMORYA" can be changed to names that are more descriptive of the memory area's contents. Even if you have stored a large number of memory settings in the computer, you can retrieve the desired settings without error.

Initialising memory

Memory settings that you no longer require can be selected and deleted one by one.

Changing a memory area name

- 1 Select the name to be changed from the memory list.**
- 2 Click [Memory Name Change].**
- 3 In the "Memory Name Change" window, type in a memory name of up to 12 characters.**

The characters that can be entered include alphanumeric characters, the space character and some punctuation characters.

e.g. ! " % & ' () * + , - .

- 4 After typing in the name, click [OK].**

Initialising a memory area

- 1 Select the memory area to be initialised from the memory list.**
- 2 Click [Memory Reset].**
- 3 At the confirmation window, click [OK].**

Reading the Indicators

The projector is provided with the following two indicators which notify you of the operating status of the projector.



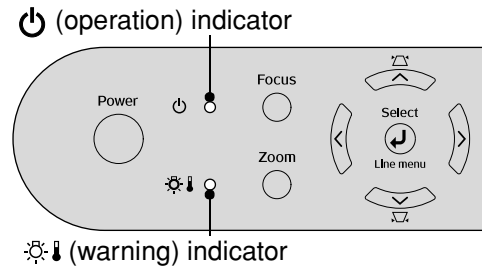

The following tables show what the indicators mean and how to remedy the problems that they indicate.

*If both indicators are switched off, check that the power cable is connected correctly and that power is being supplied.



When the ⚠ (warning) indicator is lit or flashing **warning/problem**



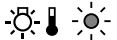

● : Lit ⚡ : Flashing

<p>Red</p>  <p>(1-second intervals)</p>	<p>Internal problem / Fan problem / Sensor problem</p>  <p>Disconnect the power cable from the electrical outlet. Then contact your dealer or the nearest address provided in the "International Warranty Conditions" section of the <i>Safety Instructions/World-Wide Warranty Terms</i> booklet.</p>
<p>Red</p>  <p>(0.5-second intervals)</p>	<p>Lamp problem / Lamp on error Check if the lamp is broken. ↗ p.38</p> <p>If the lamp is not broken</p> <div style="border: 1px solid gray; padding: 5px; display: inline-block;"> <p>Replace the lamp and then turn the power on.</p> </div> <p>If the lamp is broken</p> <div style="border: 1px solid gray; padding: 5px; display: inline-block;"> <p>Contact your local dealer for further advice.</p> </div> <p>If the problem is still not solved after the lamp is replaced, stop using the projector and disconnect the power cable from the electrical outlet. Then contact your dealer or the nearest address provided in the "International Warranty Conditions" section of the <i>Safety Instructions/World Wide Warranty Terms</i> booklet.</p>
<p>Red</p> 	<p>High internal temperature (overheating) The lamp will switch off automatically and projection will stop. Wait for approximately 5 minutes.</p> <div style="border: 1px solid gray; padding: 5px; display: inline-block;"> <ul style="list-style-type: none"> • When installing against a wall, leave a space of 20 cm or more between the projector and the wall. • Clean the air filters if they are blocked. ↗ p.36 </div> <p>If the problem is not solved when the power is turned back on, stop using the projector and disconnect the power cable from the electrical outlet. Then contact your dealer or the nearest address provided at "International Warranty Conditions" in <i>Safety Instructions/World-Wide Warranty Terms</i> booklet.</p>
<p>Orange</p> 	<p>High-speed cooling in progress You can continue using the projector, but if the temperature rises again, it will switch off automatically.</p>

When the ⏻ (operation) indicator is lit or flashing **normal**

When the ⚠ (warning) indicator is off

● : Lit ⚡ : Flashing

<p>Orange</p> 	<p>Standby condition</p> <p>If you press ⏻, projection will start after warm-up is complete.</p>
<p>Green</p> 	<p>Warm-up in progress</p> <p>Warm-up time is approximately 10 seconds. After warm-up is complete, the indicator will change to steady green and projection will start.</p>
<p>Green</p> 	<p>Projection in progress</p> <p>Normal operation is in progress.</p>
<p>Orange</p> 	<p>Cool-down in progress</p> <p>Cool-down time is approximately 30 seconds. After cool-down is complete, the projector goes to standby mode. You cannot use the remote control or the projector's control panel during cool-down.</p>

When the Indicators Provide No Help

If any of the following problems occur and the indicators do not offer a solution, refer to the pages given for each problem.

Problems relating to images

- No images appear See below
Projection does not start, the projection area is completely black, the projection area is completely blue, etc.
- The message "Not Supported." is displayed p.32
- The message "No Signal." is displayed p.32
- Images are fuzzy or out of focus p.33
- Interference or distortion appear in images p.33
Problems such as interference, distortion or black & white checked patterns appear.
- Image is truncated (large) or small p.33
Only part of the image is displayed.
- Image colours are not right p.34
The whole image appears purplish or greenish, images are black & white, colours appear dull, etc.
(Computer monitors and LCD screens have different colour reproduction performance, so that the colours projected by the projector and the colours appearing on the monitor may not necessarily match, but this is not a sign of a problem.)
- Images appear dark p.34
- Projection stops automatically p.35

Problems when projection starts

- Power does not turn on p.35

Problems with the remote control

- The remote control does not work p.35

Problems relating to images

■ No images appear

Have you pressed the [Power] button?	Press on the remote control or on the projector's control panel.
Are all of the indicators switched off?	Disconnect the power cable and then reconnect it. <i>Setup Guide</i> Check the circuit breaker to see if power is being supplied.
Is blank mode active?	Press on the remote control to cancel the blank function.
Is a video signal being input?	Check that the power for the connected equipment is turned on. If the "Message" menu command has been set to "ON", messages relating to the image signals will be displayed. "Setting" - "On-Screen Display" - "Message" p.20
Are the image signal format settings correct?	Use the "Video Signal" menu command to select the signal format which matches the connected signal source. "Setting" - "Input Signal" - "Video Signal" p.21
Have the configuration menu settings been made correctly?	Try resetting all of the current settings. p.22

<p>Were the projector and computer connected while their power was already turned on?</p> <p>When a computer is connected</p>	<p>If the connection is made while the power is already turned on, the function (Fn) key that switches the computer's video signal to external output may not work. Turn the power for the computer that is connected to the projector off and then back on again.</p>
<p>Is the computer display output set to only the computer's accessory screen?</p> <p>When a computer is connected</p>	<p>The image signals need to be output externally. Change the output setting to an external destination only or to an external destination as well as the computer's own monitor.</p> <p>☞ Computer documentation, under a title such as "External output" or "Connecting an external monitor"</p>

■ The message "Not Supported." is displayed

<p>Are the image signal format settings correct?</p> <p>Only when projecting computer images</p>	<p>If a <u>composite video</u> or <u>S-Video</u> signal is being input If projection does not occur when the "Video Signal" menu command is set to "Auto", select the signal format that matches the signal source.</p> <p>☞ "Setting" - "Input Signal" - "Video Signal" p.21</p> <p>If the signal source is connected to the [InputA] or [D4] port Use the "Input Signal" menu command to set the signal format that matches the signal that is being projected from the connected equipment. ☞ "Setting" - "Input Signal" p.21 You can also press Input A or D4 on the remote control to select the format. ☞ <i>Setup Guide</i></p>
<p>Does the mode match the frequency and resolution of the image signals?</p> <p>Only when projecting computer images</p>	<p>Use the "Resolution" menu command to check the signals being input, and check the "List of compatible signals" to make sure that the signals are compatible.</p> <p>☞ "Info" - "Resolution" p.15 ☞ "List of Supported Monitor Displays" p.41</p>



■ The message "No Signal." is displayed

<p>Are the cables connected correctly?</p>	<p>Check that all of the cables required for projection are securely connected. ☞ <i>Setup Guide</i></p>
<p>Has the correct video input port been selected?</p>	<p>Press D4, Input A, Input B, S-Video or Video on the remote control or Source on the projector's control panel to change the image source.</p> <p>☞ <i>Setup Guide</i></p>
<p>Is the power for the connected equipment turned on?</p>	<p>Turn the power on for the devices.</p>
<p>Are the image signals being output to the projector?</p> <p>Only when projecting images from a laptop computer or computer with a built-in LCD screen</p>	<p>If the image signals are only being output to the computer's LCD monitor or to the accessory monitor, you need to change the output. For some computer models, when the image signals are output externally, they no longer appear on the LCD monitor or accessory monitor.</p> <p>☞ Computer documentation, under a title such as "External output" or "Connecting an external monitor"</p>
	<p>If the connection is made while the power is already turned on, the function [Fn] key that switches the computer's video signal to external output may not work. Turn the power for the projector and the computer off and then back on again. ☞ <i>Setup Guide</i></p>

■ Images are fuzzy or out of focus

Has the focus been adjusted correctly?	Adjust the focus. ☞ Setup Guide
Is the lens cover still attached?	Remove the lens cover.
Is the projector at the correct distance?	The recommended distance from the projector to the screen is within 87–1365 cm (2.9–44.8 ft.) for a screen size of 16:9, and 108–1672 cm (3.6–54.9 ft.) for a screen size of 4:3. Set up the projector so that the projection distance is within this range. ☞ Setup Guide
Is the keystone adjustment value too large?	Decrease the projection angle to reduce the amount of keystone correction. ☞ Setup Guide
Has condensation formed on the lens?	If the projector is suddenly taken from a cold environment to a warm environment or if sudden ambient temperature changes occur, condensation may form on the surface of the lens, and this may cause the images to appear fuzzy. Set the projector up in the room approximately one hour before it is to be used. If condensation forms on the lens, turn the power off and wait for the condensation to disappear.

■ Interference or distortion appear in images

Are the image signal format settings correct?	If a <u>composite video</u> or <u>S-Video</u> signal is being input If projection does not occur when the "Video Signal" menu command is set to "Auto", select the signal format that matches the signal source. ☞ "Setting" - "Input Signal" - "Video Signal" p.21
	If the signal source is connected to the [InputA] or [D4] port Use the "Input Signal" menu command to set the signal format that matches the signal that is being projected from the connected equipment. ☞ "Setting" - "Input Signal" p.21 You can also press  or  on the remote control to select the format. ☞ Setup Guide
Are the cables connected correctly?	Check that all of the cables required for projection are securely connected. ☞ Setup Guide
Is an extension cable being used?	If an extension cable is used, interference may increase. Try connecting a signal amplifier.
Have the "Sync." and "Tracking" settings been adjusted correctly?	The projector has an automatic adjustment function that causes the optimum images to be projected. However, for some types of signal, the correct adjustments may not be obtained even after automatic adjustment is carried out. In such cases, use the "Tracking" and "Sync." menu commands to make the adjustments. ☞ "Image" - "Picture Quality" - "Tracking", "Sync." p.16
Has the correct resolution been selected?	Set the computer so that the signals that are output are compatible with this projector. ☞ "List of Supported Monitor Displays" p.41, Computer documentation

Computer and RGB video signals only



Only when projecting computer images

■ Image is truncated (large) or small

Has the correct aspect been selected?	Press  to select the aspect that corresponds to the input signal. ☞ p.8 If images with subtitles are being projected using "Zoom", use the "Zoom Caption" menu command to adjust the images. ☞ p.19
--	--

<p>Has the "Position" setting been adjusted correctly?</p>	<p>Use the "Position" menu command to make the adjustment. ☞ "Setting" - "Screen" - "Position" p.18</p>
<p>Has the computer been set for dual display?</p> <p>Only when projecting computer images</p>	<p>If dual display has been activated in the Display Properties of the computer's Control Panel, the projector will only project about half of the image on the computer screen. To display the whole of the image on the computer screen, turn off the dual display setting. ☞ Computer video driver documentation</p>
<p>Has the correct resolution been selected?</p> <p>Only when projecting computer images</p>	<p>Set the computer so that the signals that are output are compatible with this projector. ☞ "List of Supported Monitor Displays" p.41, Computer documentation</p>



■ Image colours are not right

<p>Are the image signal format settings correct?</p>	<p>If a <u>composite video</u> or <u>S-Video</u> signal is being input If projection does not occur when the "Video Signal" menu command is set to "Auto", select the signal format that matches the signal source. ☞ "Setting" - "Input Signal" - "Video Signal" p.21</p> <hr/> <p>If the signal source is connected to the [InputA] or [D4] port Use the "Input Signal" menu command to set the signal format that matches the signal that is being projected from the connected equipment. ☞ "Setting" - "Input Signal" p.21 You can also press  or  on the remote control to select the format. ☞ <i>Setup Guide</i></p>
<p>Are the cables connected correctly?</p>	<p>Check that all of the cables required for projection are securely connected. ☞ <i>Setup Guide</i></p>
<p>Has the image Contrast been adjusted correctly?</p>	<p>Use the "Contrast" or "White Level" menu command to adjust the contrast. ☞ "Image" - "Picture Quality" - "Input Adjustment" p.16</p>
<p>Has the colour been adjusted correctly?</p>	<p>Use the "Color Adjustment" menu command to adjust the colour. ☞ "Image" - "Color Adjustment" p.17</p>
<p>Have the colour intensity and tint been adjusted correctly?</p> <p>Only when projecting images from a video source</p>	<p>Use the "Color Intensity" and "Tint" menu commands to adjust the colour and tint. ☞ "Image" - "Picture Quality" - "Color Intensity", "Tint" p.16</p>

■ Images appear dark









<p>Has the image brightness been adjusted correctly?</p>	<p>Use the "Input Adjustment" and "Brightness" menu commands to make the adjustments. ☞ "Image" - "Picture Quality" - "Input Adjustment", "Brightness" p.16</p>
<p>Has the image contrast been adjusted correctly?</p>	<p>Use the "Contrast" or "White Level" menu command to adjust the contrast. ☞ "Image" - "Picture Quality" - "Input Adjustment" p.16</p>
<p>Is the lamp due for replacement?</p>	<p>When the lamp is nearly due for replacement, the images will become darker and the colour quality will become poorer. When this happens, the lamp should be replaced with a new one. ☞ p.38</p>

■ Projection stops automatically

<p>Is sleep mode active?</p>	<p>When "Sleep Mode" has been set to ON, the lamp turns off automatically if no signal is input for about 30 minutes, and the projector switches to standby mode. Press the  button on the remote control or the  button on the projector's control panel to turn the projector's power back on. To cancel the sleep mode setting, change "Sleep Mode" menu command to "OFF".  "Setting" - "Operation" - "Sleep Mode" p.19</p>
-------------------------------------	--



Problems when projection starts

■ Power does not turn on

<p>Have you pressed the [Power] button?</p>	<p>Press  on the remote control or  on the projector's control panel.</p>
<p>Is "Child Lock" set to "ON"?</p>	<p>If the "Child Lock" menu command is set to "ON", press  on the projector's control panel for about 3 seconds or press  on the remote control to turn the power on.  "Setting" - "Operation" - "Lock Setting" - "Child Lock" p.20</p>
<p>Is "Key Lock" set to "ON"?</p>	<p>If the "Key Lock" menu command is set to "ON", all buttons on the projector's control panel are disabled. Press  on the remote control.  "Setting" - "Operation" - "Lock Setting" - "Key Lock" p.20</p>
<p>Are all of the indicators switched off?</p>	<p>Disconnect the power cable and then reconnect it.  <i>Setup Guide</i> Check the circuit breaker to see if power is being supplied.</p>
<p>Do the indicators turn off and on when the power cable is touched?</p>	<p>Turn the power off, disconnect the power cable and then reconnect it. If this does not solve the problem, there may be a problem with the power cable. Then contact your dealer or the nearest address provided at "International Warranty Conditions" in <i>Safety Instructions/World-Wide Warranty Terms</i> booklet.</p>

Problems with the remote control

■ The remote control does not work

<p>Is the remote control light-emitting area facing towards the remote control light-receiving area when it is operated?</p>	<p>Face the remote control towards the remote control light-receiving area. The operating angle for the remote control is approximately $\pm 30^\circ$ horizontally and approximately $\pm 30^\circ$ vertically.  <i>Setup Guide</i></p>
<p>Is the remote control too far from the projector?</p>	<p>The operating range for the remote control is approximately 10m.  <i>Setup Guide</i></p>
<p>Is direct sunlight or strong light from fluorescent lamps shining onto the remote control light-receiving area?</p>	<p>Set the projector up in a location where strong light will not shine onto the remote control light-receiving area.</p>
<p>Are the batteries dead, or have the batteries been inserted correctly?</p>	<p>Insert new batteries, while making sure that they face correctly.  <i>Setup Guide</i></p>

This section describes maintenance tasks such as cleaning the projector and replacing consumable parts.

Cleaning

You should clean the projector if it becomes dirty or if the quality of projected images starts to deteriorate.



Be sure to read the separate *Safety Instructions/World-Wide Warranty Terms* booklet for details on safe handling of the projector during cleaning.

Cleaning the Air Filter

If the airfilter becomes blocked with dust and the message "The projector is overheating. Clean or replace the air filter and lower the room temperature" is displayed, clean the air filter.

Turn the projector upside-down and use a vacuum cleaner to clean the air filter.

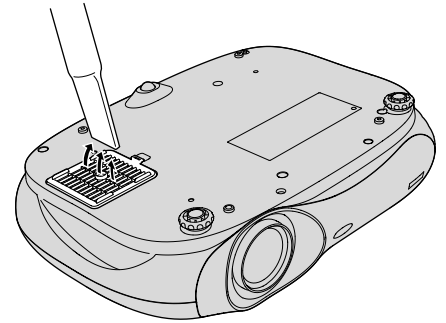

If the air filter becomes clogged with dust, it can result in overheating which may cause operating problems or reduce the operating life of the optical parts.

Cleaning the Projector Case

Clean the projector case by wiping it gently with a soft cloth.

If the projector is particularly dirty, moisten the cloth with water containing a small amount of neutral detergent, and then firmly wring the cloth dry before using it to wipe the projector case. Then wipe the case again with a soft, dry cloth.

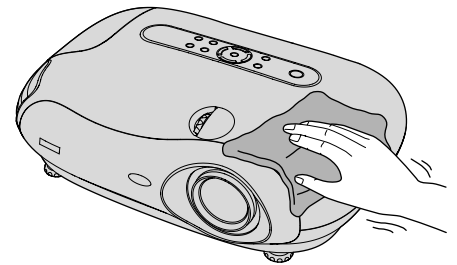

Do not use volatile substances such as wax, alcohol or thinner to clean the projector case. These can cause the case to warp and make the coating finish peel off.

Cleaning the Lens

Use a commercially-available air blower, or use a lens cleaning paper to gently wipe the lens.

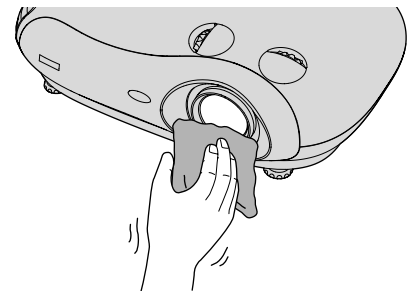

Do not rub the lens with harsh materials or subject the lens to shocks, as it can easily become damaged.

Consumable Replacement Periods

Air Filter Replacement Period

If the air filter becomes broken or too dirty to clean

Replace with an optional air filter.

☞ "Appendix: Optional Accessories" p.40

Lamp Replacement Period

- The message "Replace the lamp." appears on the screen when projection starts.

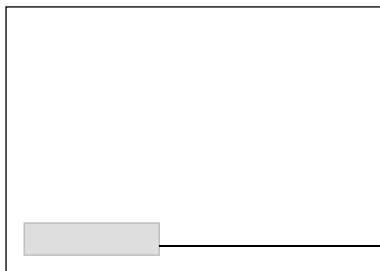

A message will be displayed.

- The projected images get darker or start to deteriorate.



- In order to maintain the brightness and quality of the projected images, a lamp replacement warning message will be displayed after approximately 1600 hours depending on the conditions that the lamp has been used under. If you continue to use the lamp after this period, the possibility of the lamp breaking becomes greater. When the lamp replacement message appears, replace the lamp with a new one as soon as possible, even if it is still working.
- The actual life of each individual lamp will vary depending on the characteristics of the lamp and on the way it has been used. The lamp may start to become dark or stop turning on even before the lamp replacement message appears. You should always have a spare lamp ready in case it is needed.
- Contact your dealer for a spare lamp.

Replacing Consumables

Replacing the Air Filter

 Dispose of used air filters properly in accordance with your local regulations.

1 Turn off the power, wait for the cool-down period to finish (takes approximately 30 seconds), then disconnect the power cable.

2 Remove the air filter cover.

- ① Put your finger under the latch.
- ② Lift up.



Replacing the Lamp



If the lamp stops working and needs to be replaced, there is the danger that the lamp may already be broken. If replacing the lamp of a projector which has been installed to the ceiling, you should always assume that the lamp is broken and handle it with extreme care during removal. Furthermore, you should stand to the side of the projector, not underneath it.

1 Turn off the power, wait for the cool-down period to finish (takes approximately 30 seconds), then disconnect the power cable.
* Wait until the lamp cools down (takes approximately 1 hour).

2 Remove the lamp cover fixing screws.

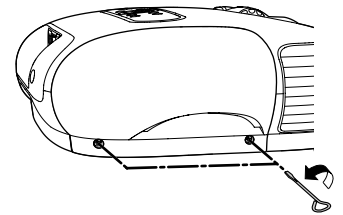

6 Insert the new lamp.
Make sure that it faces the correct way.

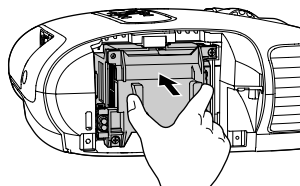

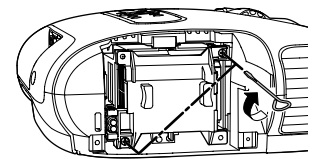

7 Securely tighten the lamp fixing screws.



Resetting the Lamp Operating Time

The lamp operating time must always be reset after the lamp has been replaced with a new one. When the cumulative operating time reaches a certain point, it causes the replacement warning message to be displayed.

1 Press  to turn on the power.

2 Press  to display the configuration menu.

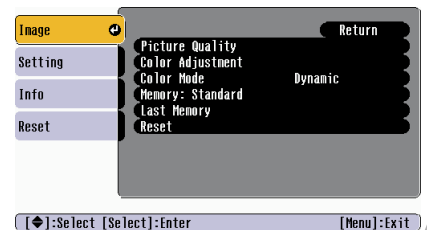

3 Remove the old air filter.

Place your finger under one of the ribs and lift up.

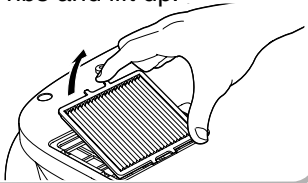

4 Insert the new air filter.

Make sure that it faces the correct way.

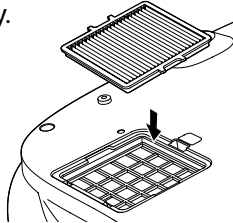

5 Install the air filter cover.

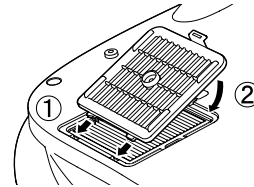

3 Remove the lamp cover.

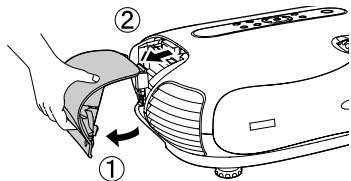

Lift up slightly from underneath to remove.

4 Loosen the lamp fixing screws.

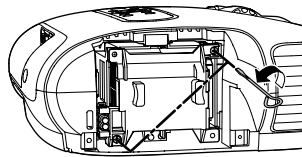

5 Remove the old lamp.

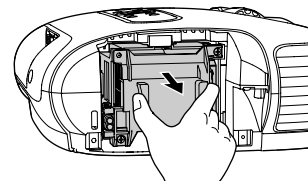

Pull out straight.

8 Install the lamp cover, then tighten the lamp cover fixing screws.

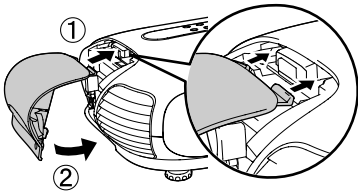

- Install the lamp and the lamp cover securely. The lamp will not turn on if the lamp or the lamp cover is not installed correctly.
- Dispose of used lamps properly in accordance with your local regulations.

3 Select "Lamp - Hours Reset" from the "Reset" menu.

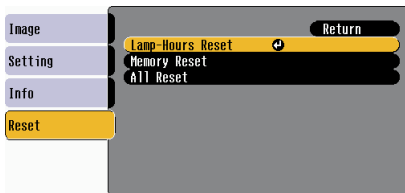

[Esc]:Return [↔]:Select [Select]:Enter [Menu]:Exit

4 Select "Yes" and then press .

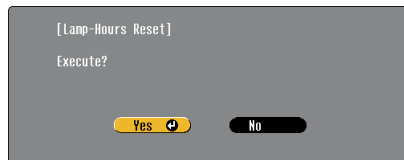

[Esc]:Return [↔]:Select [Select]:Execute [Menu]:Exit

Optional Accessories

The following optional accessories are available for purchase if required. This list of optional accessories is current as of October 2003. Details of accessories are subject to change without notice.

Spare lamp	ELPLP28
-------------------	----------------

(1 spare lamp)
Use as a replacement for spent lamps.

Air filter	ELPAF04
-------------------	----------------

(1 air filter)
Use as a replacement for old air filters.

50" portable screen	ELPSC06
----------------------------	----------------

A compact screen which can be carried easily.
(Aspect **▶** 4:3).

60" screen	ELPSC07
80" screen	ELPSC08
100" screen	ELPSC10

A portable roll-type screen. (Aspect 4:3)

Soft carry case	ELPKS51
------------------------	----------------

Use this case if you need to carry the projector by hand.

VGA-HD15 PC cable (1.8 m (6 ft.))	ELPKC02
VGA-HD15 PC cable (3 m (9.8 ft.))	ELPKC09
VGA-HD15 PC cable (20 m (65.6 ft.))	ELPKC10

(For mini D-Sub 15-pin/mini D-Sub 15-pin)
Use to connect the projector to a computer.

Ceiling mount*	ELPMB17
-----------------------	----------------

(with ceiling plate)
Use when installing the projector to a ceiling.

Pipe 600 (600 mm (23.62 in.)/white)*	ELPFP07
---	----------------

Use when installing the projector to a high ceiling or a ceiling with veneer panels.

*A special method of installation is required in order to suspend the projector from the ceiling. Please contact the place of purchase if you would like to use this installation method.

List of Supported Monitor Displays

Depending on the setting, the output screen resolution will change slightly.

Component Video

4:3 16:9 : Aspect Units: Dots

Signal	Resolution	Aspect mode				
		Normal	Squeeze	Zoom	Through	Squeeze through
<u>SDTV</u> (525i, 60Hz) (D1)	640×480 640×360 (for zoom)	960×720 4:3	1280×720 16:9	1280×720 16:9	596×446 4:3	794×446 16:9
SDTV(625i, 50Hz)	768×576 768×432 (for zoom)	960×720 4:3	1280×720 16:9	1280×720 16:9	708×528 4:3	944×528 16:9
SDTV(525p) (D2)	640×480 640×360 (for zoom)	960×720 4:3	1280×720 16:9	1280×720 16:9	596×446 4:3	794×446 16:9
SDTV(625p)	768×576 768×432 (for zoom)	960×720 4:3	1280×720 16:9	1280×720 16:9	708×528 4:3	944×528 16:9
<u>HDTV</u> (750p)16:9 (D4)	1280×720	1280×720 16:9	-	-	1176×664 16:9	-
HDTV(1125i)16:9 (D3)	1920×1080	1280×720 16:9	-	-	-	-

Composite Video/S-Video

4:3 16:9 : Aspect Units: Dots

Signal	Resolution	Aspect mode				
		Normal	Squeeze	Zoom	Through	Squeeze through
TV(NTSC)	640×480 640×360 (for zoom)	960×720 4:3	1280×720 16:9	1280×720 16:9	596×446 4:3	794×446 16:9
TV (PAL, SECAM)	768×576 768×432 (for zoom)	960×720 4:3	1280×720 16:9	1280×720 16:9	708×528 4:3	944×528 16:9

RGB Video/Computer

Units: Dots

Signal	Resolution	Aspect mode				
		Normal	Squeeze	Zoom	Through	Squeeze through
<u>VGA</u> 60, <u>SDTV</u> (525p)	640×480 640×360 (for zoom)	960×720	1280×720	1280×720	640×480	853×480
VESA72/75/85, iMac*	640×480 640×360 (for zoom)	960×720	1280×720	1280×720	640×480	853×480
<u>SVGA</u> 56/60/72/75/85, iMac*	800×600 800×450 (for zoom)	960×720	1280×720	1280×720	800×600	1066×600
<u>XGA</u> 43i/60/70/75/85, iMac*	1024×768 1024×576 (for zoom)	960×720	1280×720	1280×720	-	-
<u>SXGA</u> 70/75/85	1152×864 1152×648 (for zoom)	960×720	1280×720	1280×720	-	-
SXGA60/75/85	1280×960 1280×720 (for zoom)	960×720	1280×720	1280×720	-	-
SXGA43i/60/75/85	1280×1024 1280×720 (for zoom)	900×720	1280×720	1280×720	-	-
MAC13"	640×480	960×720	1280×720	1280×720	640×480	853×480
MAC16"	832×624	960×720	1280×720	1280×720	832×624	1109×624
MAC19"	1024×768	960×720	1280×720	1280×720	-	-
MAC21"	1152×870	954×720	1280×720	1280×720	-	-
SDTV(525i, 60Hz)	640×480 640×360 (for zoom)	960×720	1280×720	1280×720	640×480	853×480
SDTV(625i, 50Hz)	768×576 768×432 (for zoom)	960×720	1280×720	1280×720	768×576	1024×576
SDTV(625p)	768×576 768×432 (for zoom)	960×720	1280×720	1280×720	768×576	1024×576
HDTV(750p)	1280×720	1280×720	-	-	1280×720	-
HDTV(1125i)	1920×1080	1280×720	-	-	-	-

* Connection is not possible if the equipment does not have a VGA output port.

It may be possible to project signals which are not listed in the above table. However, not all functions may be supportable with such signals.

Specifications

Product name	Home Projector EMP-TW200		
Dimensions	440 (W) × 114 (H) × 320 (D) mm (not including feet)		
Panel size	0.7 inches		
Display method	Polysilicon TFT active matrix		
Resolution	921,600 pixels (1280 (W) × 720 (H) dots) × 3		
Scanning frequencies	Analogue	Pixel clock	:14 – 110 MHz
		Horizontal	:15 – 64 MHz
		Vertical	:50 – 85 MHz
Focus adjustment	Electronic		
Zoom adjustment	Electronic (approx. 1 : 1.5)		
Lens shift	Manual (Vertical 15 : -5 – 0 : 10, Horizontal 10 : 0 – 0 : 10)		
Lamp (light source)	UHP lamp, 200 W, Model No.: ELPLP28		
Power supply	100–240 VAC 50/60 Hz 3.0 – 1.4 A		
Operating temperature	+5° – +35°C (41° – 95°F) (No condensation)		
Storage temperature	-10° – +60°C (14° – 140°F) (No condensation)		
Weight	Approx. 5.3 kg (11.7 lbs)		
Ports	D4	1	D4
	InputA	1	RCA pin jack × 4
	InputB	1	Mini D-Sub 15-pin (female) blue
	Video	1	RCA pin jack
	S-Video	1	Mini DIN 4-pin
	Control (RS-232C)	1	D-Sub 9-pin (male)
	USB *	1	USB connector (type B)
	Trigger out	1	3.5 mm mini jack

* The USB connector is not guaranteed to operate correctly with all USB-compatible devices.



Pixelworks ICs are used in this projector.

Compatible computers for using Cinema Color Editor

	Windows	Macintosh
OS	Windows 98SE, NT4.0(SP6a), Me, 2000 Professional, XP Home Edition, XP Professional Edition * Internet Explorer Ver. 5 or later must be installed.	Mac OS 8.6.x, 9.0.4, 9.1, 9.2.x MAC OS X 10.1.5, 10.2.x or later * Not compatible with the Classic environment of Mac OS X or higher.
CPU	Pentium MMX 166 MHz or higher (Pentium II 233 MHz or higher recommended)	Power PC G3 or higher (300 MHz or higher recommended)
Memory capacity	10 MB or more	7 MB or more
Hard disk free space	2 MB or more	5 MB or more
Display	<u>XGA</u> (1024 × 768) or greater resolution. 16-bit color or greater display	

Safety

USA
UL1950 3rd Edition
Canada
CSA C22.2 No.950-95 (cUL)
European Community
The Low Voltage Directive (73/23/EEC)
IEC60950 2nd Edition, +Amd.1, +Amd.2, +Amd.3, +Amd.4

EMC

USA
FCC 47CFR Part15B Class B (DoC)
Canada
ICES-003 Class B
European Community
The EMC Directive (89/336/EEC)
EN55022, 1998 Class B
EN55024, 1998
IEC61000-4-2, IEC61000-4-3, IEC61000-4-4, IEC61000-4-5, IEC61000-4-6, IEC61000-4-8, IEC61000-4-11, IEC61000-3-2, IEC61000-3-3
Australia/New Zealand
AS/NZS 3548:1995, A1:1997, A2:1997 Class B
CISPR Pub.22:1993, A1:1995, A2:1996, Class B

DECLARATION of CONFORMITY

According to 47CFR, Part 2 and 15
 Class B Personal Computers and Peripherals; and/or
 CPU Boards and Power Supplies used with Class B
 Personal Computers

We :EPSON AMERICA, INC.
 Located at : 3840 Kilroy Airport Way
 MS: 313
 Long Beach, CA 90806
 Tel : 562-290-5254

Declare under sole responsibility that the product identified herein, complies with 47CFR Part 2 and 15 of the FCC rules as a Class B digital device. Each product marketed, is identical to the representative unit tested and found to be compliant with the standards. Records maintained continue to reflect the equipment being produced can be expected to be within the variation accepted, due to quantity production and testing on a statistical basis as required by 47CFR 2.909. Operation is subject to the following two conditions : (1) this device may not cause harmful interference, and (2) this device must accept any interference received, including interference that may cause undesired operation.

Trade Name : EPSON
 Type of Product : Projector
 Model : EMP-TW200

**FCC Compliance Statement
 For United States Users**

This equipment has been tested and found to comply with the limits for a Class B digital device, pursuant to Part 15 of the FCC Rules. These limits are designed to provide reasonable protection against harmful interference in a residential installation. This equipment generates, uses, and can radiate radio frequency energy and, if not installed and used in accordance with the instructions, may cause harmful interference to radio or television reception. However, there is no guarantee that interference will not occur in a particular installation. If this equipment does cause interference to radio and television reception, which can be determined by turning the equipment off and on, the user is encouraged to try to correct the interference by one or more of the following measures.

- Reorient or relocate the receiving antenna.
- Increase the separation between the equipment and receiver.
- Connect the equipment into an outlet on a circuit different from that to which the receiver is connected.
- Consult the dealer or an experienced radio/TV technician for help.

WARNING

The connection of a non-shielded equipment interface cable to this equipment will invalidate the FCC Certification or Declaration of this device and may cause interference levels which exceed the limits established by the FCC for this equipment. It is the responsibility of the user to obtain and use a shielded equipment interface cable with this device. If this equipment has more than one interface connector, do not leave cables connected to unused interfaces. Changes or modifications not expressly approved by the manufacturer could void the user's authority to operate the equipment.

Following is an explanation of some of the terms used in this guide which may be unfamiliar or which were not explained in the manual itself. Further information can be obtained by referring to other commercially-available publications.

Aspect

The ratio between an image's length and its height. HDTV images have an aspect of 16:9 and appear elongated. The aspect for standard images is 4:3.

Colour temperature

The temperature of an object which is emitting light. If the colour temperature is high, the colors tend to take on a bluish tinge. If the colour temperature is lower, the colors tend to take on a reddish tinge.

Component video

Video signals which have the video brightness signals and color signals separated, in order to provide better image quality.

In high-definition TV (HDTV), it refers to images which consist of three independent signals: Y (luminance signal), and Pb and Pr (color difference signals).

Composite video

Video signals which have the video brightness signals and color signals mixed together. The type of signals commonly used by household video equipment (NTSC▶▶, PAL▶▶ and SECAM▶▶ formats).

Video signals which consist of a carrier signal Y (luminance signal) within the color bar signal, and a chroma or color signal (CbCr).

Contrast

The relative brightness of the light and dark areas of an image can be increased or decreased in order to make text and graphics stand out more clearly, or to make them appear softer.

Cool-down

This is the process by which the projector's lamp is cooled down after it has become hot through use. It is carried out automatically when the [Power] button on either the remote control or the projector's control panel has been pressed to turn off the projector. Do not disconnect the power cable while cool-down is in progress, otherwise the cool-down process will not work properly. If the cool-down period is not allowed to finish normally, the projector's lamp and internal components will remain at high temperatures, and this may shorten the useful life of the lamp or cause problems with the operation of the projector. The cool-down period lasts for about 5 minutes. The actual time will vary depending on the external air temperature.

Gain

The adjustment of minute changes in color that occur as result of factors such as differences in the equipment used to display images. It adjusts the coloration in brighter ranges separately for R, G and B components.

Gamma

The adjustment of minute changes in color that occur as result of factors such as differences in the equipment used to display images. It adjusts the coloration in intermediate ranges separately for R, G and B components.

HDTV

An abbreviation for High-Definition Television. It refers to high-definition systems which satisfy the following conditions.

- Vertical resolution of 750p or 1125i or greater (p = progressive▶▶, i = interlaced▶▶)
- Screen aspect▶▶ of 16:9
- Dolby Digital audio reception and playback (or output)

Interlace

A method of image scanning whereby the signal bandwidth used is approximately half that required for sequential scanning when images with the same still picture resolution are broadcast.

NTSC

An abbreviation for National Television Standards Committee, and a format for ground-based analogue colour television broadcasts. This format is used in Japan, North America and Central and South America.

Offset

The adjustment of minute changes in color that occur as result of factors such as differences in the equipment used to display images. It adjusts the coloration in darker ranges separately for R, G and B components.

PAL

An abbreviation for Phase Alternation by Line, and a format for ground-based analogue colour television broadcasts. This format is used in Western European countries except France, and also in Asian countries such as China and in Africa.

Progressive

A method of image scanning whereby the image data from a single image is scanned sequentially from top to bottom to create a single image.

Refresh rate

The light-emitting element of a display maintains the same luminosity and color for an extremely short time. Because of this, the image must be scanned many times per second in order to refresh the light emitting element. The number of refresh operations per second is called the "refresh rate", and is expressed in hertz (Hz).

S-Video

A video signal which has the luminance component and color component separated in order to provide better image quality.

It refers to images which consist of two independent signals: Y (luminance signal), and C (color signal).

SDTV

An abbreviation for Standard Definition Television. It refers to standard television systems which do not satisfy the conditions for HDTV▶▶.

SECAM

An abbreviation for Sequential Couleur A Memoire, and a format for ground-based analogue colour television broadcasts. This format is used in France, Eastern Europe and the former Soviet Union, the Middle East and Africa.

Security lock

A device consisting of a protector case with a hole in it that a commercially-available theft-prevention cable can be passed through in order to secure the device to a table or pillar. This projector is compatible with the Microsaver Security System manufactured by Kensington.

sRGB

An international standard for color intervals that was formulated so that colors which are reproduced by video equipment can be handled easily by computer operating systems (OS) and the Internet.

SVGA

A type of image signal with a resolution of 800 (horizontal) x 600 (vertical) dots which is used by IBM PC/ AT-compatible computers.

SXGA

A type of image signal with a resolution of 1280 (horizontal) x 1024 (vertical) dots which is used by IBM PC/ AT-compatible computers.

Sync. (Synchronization)

The signals output from computers have a specific frequency. If the projector frequency does not match this frequency, the resulting images will not be of a good quality. The process of matching the phases of these signals (the relative position of the crests and troughs in the signal) is called "synchronization". If the signals are not synchronized, problems such as flickering, blurriness and horizontal interference can occur.

Tracking

The signals output from computers have a specific frequency. If the projector frequency does not match this frequency, the resulting images will not be of a good quality. The process of matching the frequency of these signals (the number of crests in the signal) is called "tracking". If tracking is not carried out correctly, wide vertical stripes will appear in the projected images.

VGA

A type of image signal with a resolution of 640 (horizontal) x 480 (vertical) dots which is used by IBM PC/ AT-compatible computers.

XGA

A type of image signal with a resolution of 1,024 (horizontal) x 768 (vertical) dots which is used by IBM PC/ AT-compatible computers.

YCbCr

The carrier signal which is contained in the color bar signal used in modern TV transmissions. The name comes from the Y (luminance) signal and the CbCr (chroma [color]) signals.

YPbPr

The carrier signal which is contained in the color bar signal used in high-definition TV (HDTV) transmissions. The name comes from the Y (luminance) signal and the PbPr (color difference) signals.

"SG" stands for *Setup Guide*.

- A**
- Adjusting the color hue and saturation26
 - Advanced..... 15,18
 - Air filter.....6
 - Air inlet6
 - All Reset..... 15,22
 - Aspect.....8,12,41
 - Auto.....8
 - Auto Setup.....14,17,SG
- B**
- Background Color15,20
 - Battery replacement period (Remote control).....SG
 - Black Level14,16
 - Brightness.....14,16
- C**
- Ceiling15,19,SG
 - Child Lock.....15,20,SG
 - Cinema Color Editor24
 - Cinema Filter.....2,9
 - Cleaning the Air Filter36
 - Cleaning the Lens.....36
 - Cleaning the Projector Case.....36
 - Color Adjustment10,14,17
 - Color Intensity.....14,16
 - Color Mode8,14,17
 - Color Temp.....10,14,17
 - [Control (RS-232C)] port.....6,25
 - COM Port.....15,19,25
 - Compatible Computers (Cinema Color Editor).....43
 - Component Video.....41,SG
 - Composite Video.....41,SG
 - Configuration Menu14
 - Connecting to a Computer25,SG
 - Connecting to a Video Source.....SG
 - Contrast14,16
 - Control Panel.....4
 - Cool-down.....30,SG
 - Correcting keystone distortion4,SG
 - Correcting projector tilt.....4,SG
- D**
- [D4] port.....6,42,SG
- F**
- Flesh Tone10,14,17
 - Focus adjustment.....4,5,SG
 - Front adjustable foot4,SG
 - Full menus.....14
- G**
- Gain adjustment11,14,17
 - Gamma adjustment.....11,14,17
- H**
- HDTV.....41
- I**
- Image size.....SG
- "Image" Menu.....14,16
- Indicators4,30
 - "Info" Menu15
 - Input Adjustment14,16
 - Input Level14,16
 - Input Signal15
 - [InputA] port6,42,SG
 - [InputB] port6,42,SG
 - Install24
- K**
- Keystone.....15,19,SG
- L**
- Lamp - Hours Reset15,22,38
 - Lamp cover4,38
 - Lamp Hours15
 - Language.....15,21
 - Last Memory12,14,17
 - Lens cover4,SG
 - Lens shift.....4,SG
 - Line menu14,23
 - Lock Setting.....15,20
- M**
- Memory5,12
 - Memory Edit28
 - Memory Reset.....15,22
 - Memory: Standard12,14
 - Menu Color15,20
 - Menu Position15,20
 - Menus.....14
 - Message15,20
- N**
- Navigation Bar14,15,20
 - Noise Reduction.....15,18
 - Normal8
- O**
- Offset adjustment10,14,17
 - On-Screen Display15,20
 - Operation15,19
 - Operation indicator4,SG
 - Optional accessories.....40
 - Output Scaling15,18
 - Overheating.....30
- P**
- Picture Quality14,16
 - Port.....6,42,SG
 - Position15,18
 - Power cable.....SG
 - Power inlet6,SG
 - Progressive15,18
 - ProjectionSG
 - Projection distanceSG
 - Projection Image Position AdjustmentSG
- R**
- Refresh Rate.....15
 - Remote control.....5,SG
- Replacing the Air Filter38
 - Replacing the batterySG
 - Replacing the Lamp.....38
 - Reset14,15,17,22
 - "Reset" Menu.....15,22
 - Resolution15,41
 - RGB adjustment10,14,17
 - RGB-Video41,SG
- S**
- Screen15,18
 - Screen sizeSG
 - SDTV41
 - Selecting the image source4,SG
 - Selection menu8,12,SG
 - Setup Level15,18
 - "Setting" Menu15,18
 - Sharpness14,16
 - Sleep Mode15,19
 - Source15
 - Specifications.....42
 - Squeeze8
 - Squeeze Through8
 - sRGB9,14
 - Startup Screen.....15,21
 - Sub-menu.....14
 - Supported Monitor Displays.....41
 - S-Video41,SG
 - [S-Video] port6,42,SG
 - Sync Info.....15
 - Sync.14,16
- T**
- Test Pattern5,SG
 - Through8
 - Tint.....14,16
 - Top menu14
 - Tracking.....14,16
 - Trigger Out15,20
 - [Trigger out] port6,42
 - Turning off.....SG
- U**
- Uninstall.....25
 - [USB] port6,25
 - Using the Configuration Menus.....23
- V**
- [Video] port.....6,42,SG
 - Video Signal15,21
- W**
- Warning indicator4
 - White Level14,16
- Y**
- YCbCr.....15,21,SG
 - YPbPr.....15,21,SG
- Z**
- Zoom.....8
 - Zoom adjustment4,SG
 - Zoom Caption9,15,19

All rights reserved. No part of this publication may be reproduced, stored in a retrieval system, or transmitted in any form or by any means, electronic, mechanical, photocopying, recording, or otherwise, without the prior written permission of SEIKO EPSON CORPORATION. No patent liability is assumed with respect to the use of the information contained herein. Neither is any liability assumed for damages resulting from the use of the information contained herein.

Neither SEIKO EPSON CORPORATION nor its affiliates shall be liable to the purchaser of this product or third parties for damages, losses, costs, or expenses incurred by purchaser or third parties as a result of: accident, misuse, or abuse of this product or unauthorised modifications, repairs, or alterations to this product, or (excluding the U.S.) failure to strictly comply with SEIKO EPSON CORPORATION's operating and maintenance instructions.

SEIKO EPSON CORPORATION shall not be liable against any damages or problems arising from the use of any options or any consumable products other than those designated as Original EPSON Products or EPSON Approved Products by SEIKO EPSON CORPORATION.

General Notice:

EPSON is a registered trademark of SEIKO EPSON CORPORATION.

Macintosh, Mac, and iMac are registered trademarks of Apple Computer, Inc.

IBM is a registered trademark of International Business Machines Corporation.

Windows and Windows NT are trademarks of Microsoft Corporation in the United States of America.

Other product names used herein are also for identification purposes only and may be trademarks of their respective owners. EPSON disclaims any and all rights in those marks.

EPSON®

E



Printed on recycled paper.



Printed in China
404662400
03.09-.XA(C01)