

Home Projector  
**EMP-TW1000**

**User's Guide**

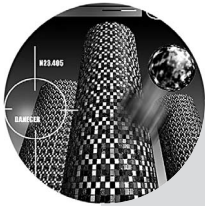

# About the Manuals and Notations Used

## Types of Manual

The documentation for your EPSON projector is divided into the following two manuals. Refer to the manuals in the order given below.

### ❶ Safety Instructions/World-Wide Warranty Terms

This manual contains information on using the projector safely, and also includes a guide for warranty service, and a troubleshooting check sheet.







Be sure to read this manual thoroughly before using the projector.

### ❷ User's Guide (this manual)

This User's Guide contains information on installing the projector, basic operations, using the configuration menus, troubleshooting and maintenance.

## Notations used in this User's Guide

### General information

	Indicates procedures where personal injury or damage to the projector may occur if the procedures are not followed correctly.
	Indicates additional information and points which may be useful to know regarding a topic.
	Indicates a page where useful information regarding a topic can be found.
	Indicates that an explanation of the underlined word or words in front of this symbol appears in the glossary of terms. Refer to the "Glossary" in the "Appendix".  p.54
 ,  etc.	Indicates buttons on the remote control or projector's control panel.
" (Menu Name) "	Indicates configuration menu items. Example: "Image"- "Color Mode"
[ (Name) ]	Indicates the port name of the projector. Example: [Video]

### Meaning of "unit" and "projector"

When "unit" or "projector" appears in the text of this *User's Guide*, they may refer to items which are accessories or optional equipment in addition to the main projector unit itself.

# Checking the Components

When you unpack the projector, make sure that you have all these components.

If any of the components are missing or incorrect, please contact the place of purchase.

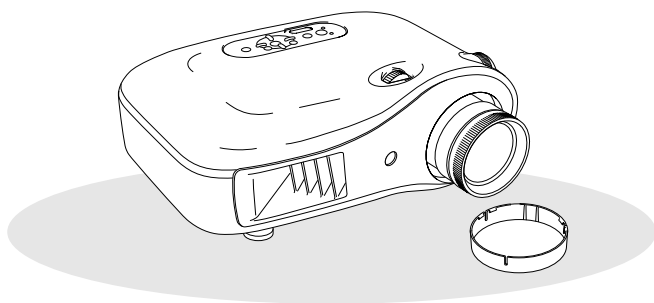

❑ **Projector (with lens cover)**

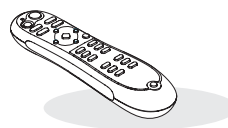

❑ **Remote control**

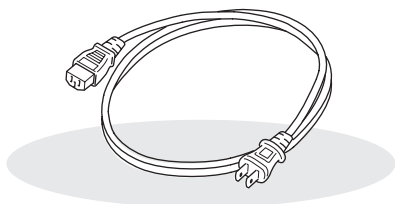

❑ **Power cable (3.0m)**  
Connect to the projector and to a wall outlet.



❑ **AA alkali batteries (2 pcs.)**  
Insert into the remote control.

## Documentation

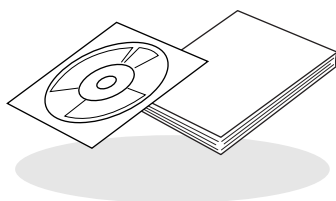

- ❑ **Document CD-ROM (Safety Instructions/World-Wide Warranty Terms, User's Guide)**
- ❑ **Quick Start Guide**
  - \* Some regions may have paper manuals instead of a CD-ROM, or may not have the Quick Start Guide.

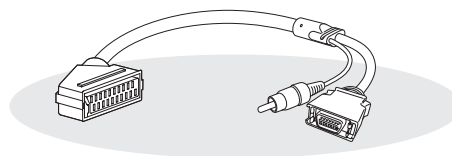

- ❑ **D SCART adapter**
  - Use a commercially-available SCART cable to make the connections when projecting RGB-video and component video images.
  - \* Some regions may not have the D SCART adapter included as an accessory.

# Table of Contents

■ <b>Features of the Projector</b> .....	4	Remote control .....	7
■ <b>Part Names and Functions</b> .....	6	Rear.....	8
Front / Top.....	6	Base .....	8
Control panel.....	6	■ <b>Appearance</b> .....	9

## Installing the Projector

■ <b>Setting up</b> .....	10	■ <b>Preparing the Remote Control</b> .....	13
Adjusting the projection size.....	10	Inserting batteries into the remote control ..	13
■ <b>Connecting Image Sources</b> .....	12		

## Basic Operations

■ <b>Projecting Images</b> .....	14	■ <b>Adjusting the Projection Screen</b> .....	16
Turning the power on and projecting images .....	14	Focus adjustment .....	16
		Fine adjustments to image size (Zoom adjustment) .....	16
		Projection image position adjustment (Lens shift).....	16



## Image Quality Adjustments

■ <b>Basic Image Quality Adjustments</b> .....	18	■ <b>Examining Image Quality Further</b> .....	23
Selecting the colour mode.....	18	Sharpness (Advanced) adjustment .....	23
Selecting the aspect .....	18	Auto Iris (automatic aperture) setting .....	23
■ <b>Advanced Colour Adjustments</b> .....	20	■ <b>Viewing Images at a Preset Image Quality (Memory Function)</b> .....	24
Skin tone adjustment.....	20	Saving, Loading and Erasing Memory .....	24
Absolute colour temperature adjustment....	20		
Gamma adjustment .....	20		
RGB adjustment (Offset, Gain) .....	22		
Hue and saturation adjustment .....	22		

## Configuration Menu

■ <b>Configuration Menu Functions</b> .....	26	"Settings" menu .....	33
Using the configuration menus .....	26	"Memory" menu .....	35
List of configuration menus .....	28	"Reset" menu.....	35
"Image" menu .....	30		
"Signal" menu.....	31		

## Troubleshooting

■ <b>Problem Solving</b> .....	<b>36</b>	When the indicators provide no help.....	37
Reading the indicators .....	36	•Problems relating to images.....	38
•  When the (warning) indicator is lit or flashing .....	36	•Problems when projection starts .....	43
•  When the (operation) indicator is lit or flashing .....	37	•Problems with the remote control.....	43

## Appendix

■ <b>Maintenance</b> .....	<b>44</b>	■ <b>Optional Accessories / Consumables</b> .....	<b>48</b>
Cleaning .....	44	■ <b>List of Supported Monitor Displays</b> .....	<b>49</b>
• Cleaning the air filter .....	44	• Component Video .....	49
• Cleaning the projector case .....	44	• Composite Video/S-Video .....	49
• Cleaning the lens .....	44	• Computer image (analog RGB) .....	50
Consumable replacement periods .....	45	• Input signal from the [HDMI] input port.....	50
• Air filter replacement period .....	45	■ <b>Specifications</b> .....	<b>51</b>
• Lamp replacement period .....	45	■ <b>Glossary</b> .....	<b>54</b>
Replacing consumables .....	46	■ <b>Index</b> .....	<b>56</b>
• Replacing the air filter .....	46		
• Replacing the lamp .....	46		
• Resetting the lamp operating time .....	46		

# Features of the Projector

## ▶ Image appearance can be selected to match the projection environment (Color Mode)

The optimum images for the location can be projected simply by selecting the desired colour mode from the following six preset modes.

If "Natural", "Theatre", "Theatre Black 1" or "Theatre Black 2" is selected, the Epson Cinema Filter effect is applied automatically to increase the contrast and to make skin tones appear with more natural tints.  p.18

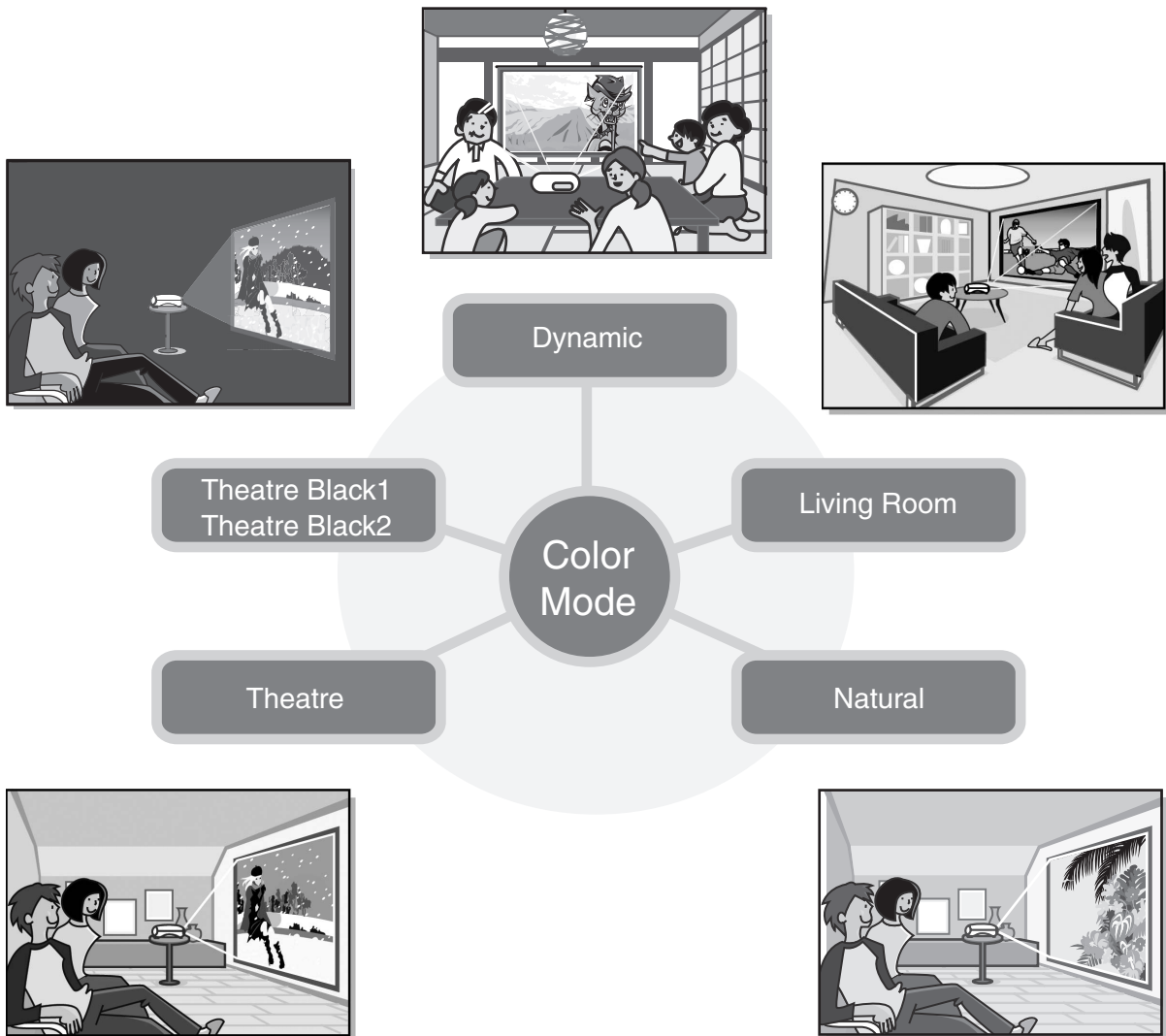

## ▶ Sophisticated colour adjustment

In addition to the "Color Mode", the absolute colour temperature and skin tones can be adjusted by simple procedures to render the picture even more to your own liking. Further, you can adjust gamma, the offset and gain for RGB colours, and the hue and saturation of RGB/CMY colours, to create colours that match the image.

 p.20

## ▶ Equipped with a wide-angle lens shift function

The lens shift function allows the position of the projected images to be adjusted vertically and horizontally without distorting the images. This can allow the projector to be set up with greater freedom, even if it is suspended from a ceiling or at an angle to the screen. 📖 p.16

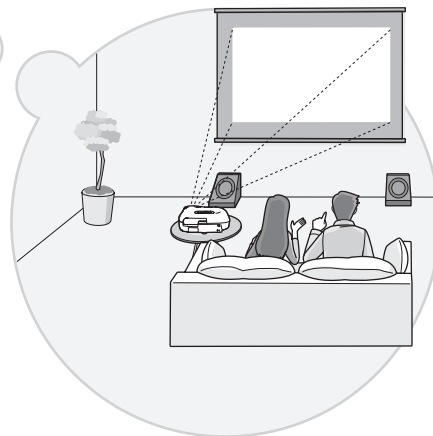
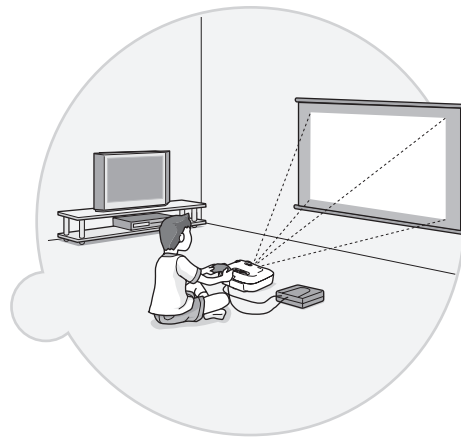
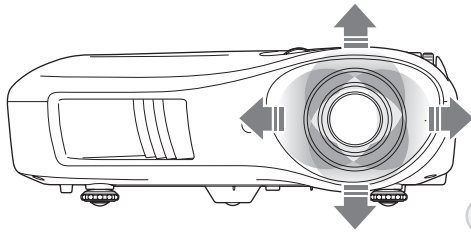

## ▶ Equipped with 2.1x short throw zoom lens

For zoom adjustment, 2.1x short throw zoom lens is provided. Images can be projected onto an 100" screen (16:9 screen only) even at a distance of approximately 3 m (10 ft.). 📖 p.10

## ▶ Advanced image quality adjustment functions

Advanced image quality adjustment functions such as "Auto Iris" and "Sharpness (Advanced)" can be used to enjoy even sharper images. With the Auto Iris function turned on, the amount of light can be automatically adjusted to match the images being projected, to create images with depth and perspective. The Sharpness function is used to adjust not only the entire image, but also to emphasize specific regions, such as hair and clothing.

📖 p.23

## ▶ A variety of image setting functions

Some of the other many functions that are available are as follows.

- EPSON Super White is used to prevent overexposure that can result in images that are too bright. 📖 p.32
- A progressive▶ conversion that lets you obtain ideal results both for images with large amounts of movement and for still images. 📖 p.32
- An aspect▶ function that allows images to be viewed in wide-screen format. 📖 p.18
- Memory functions that allow adjustment results to be stored and later retrieved easily using the remote control. 📖 p.24
- Lock settings that can be used to lock the projector's control panel after adjustments have been made so that they cannot be changed by mistake, or to prevent children from accidentally turning on the power and looking into the lens. 📖 p.33

# Part Names and Functions

## Front / Top

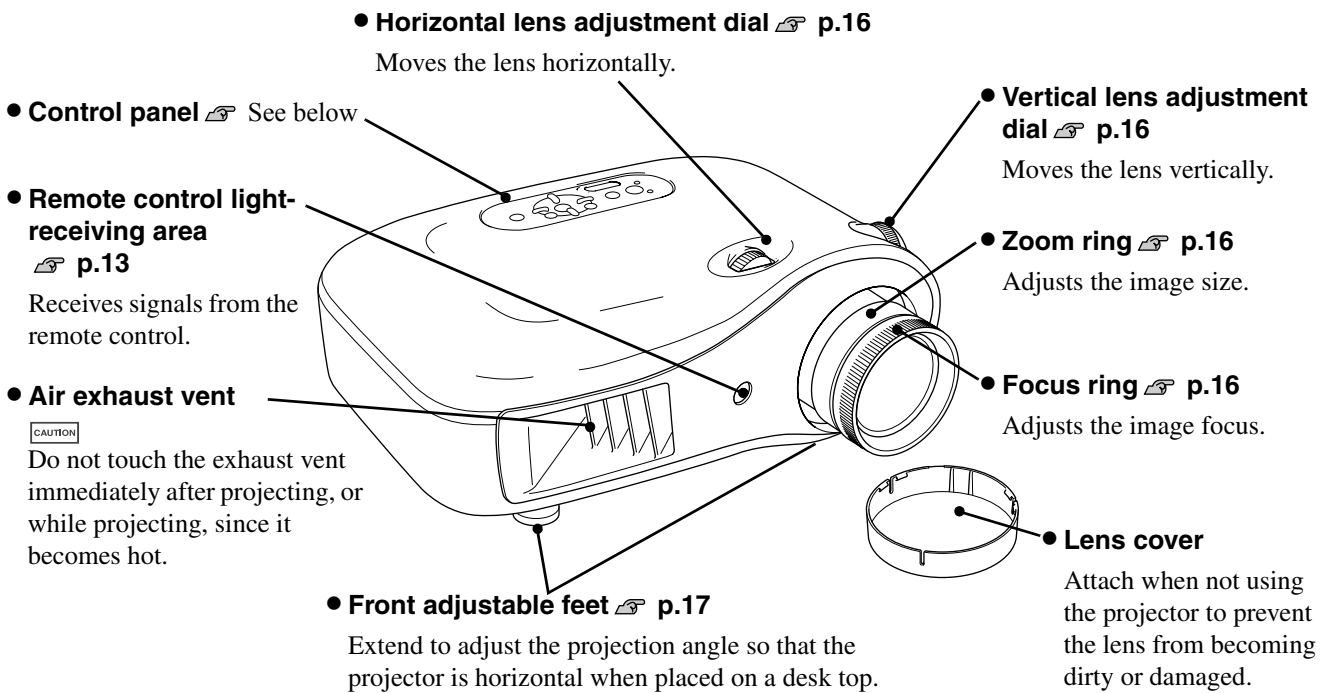

## Control panel

Buttons with no explanation function in the same way as the corresponding buttons on the remote control. Refer to "Remote control" for further details on these buttons.

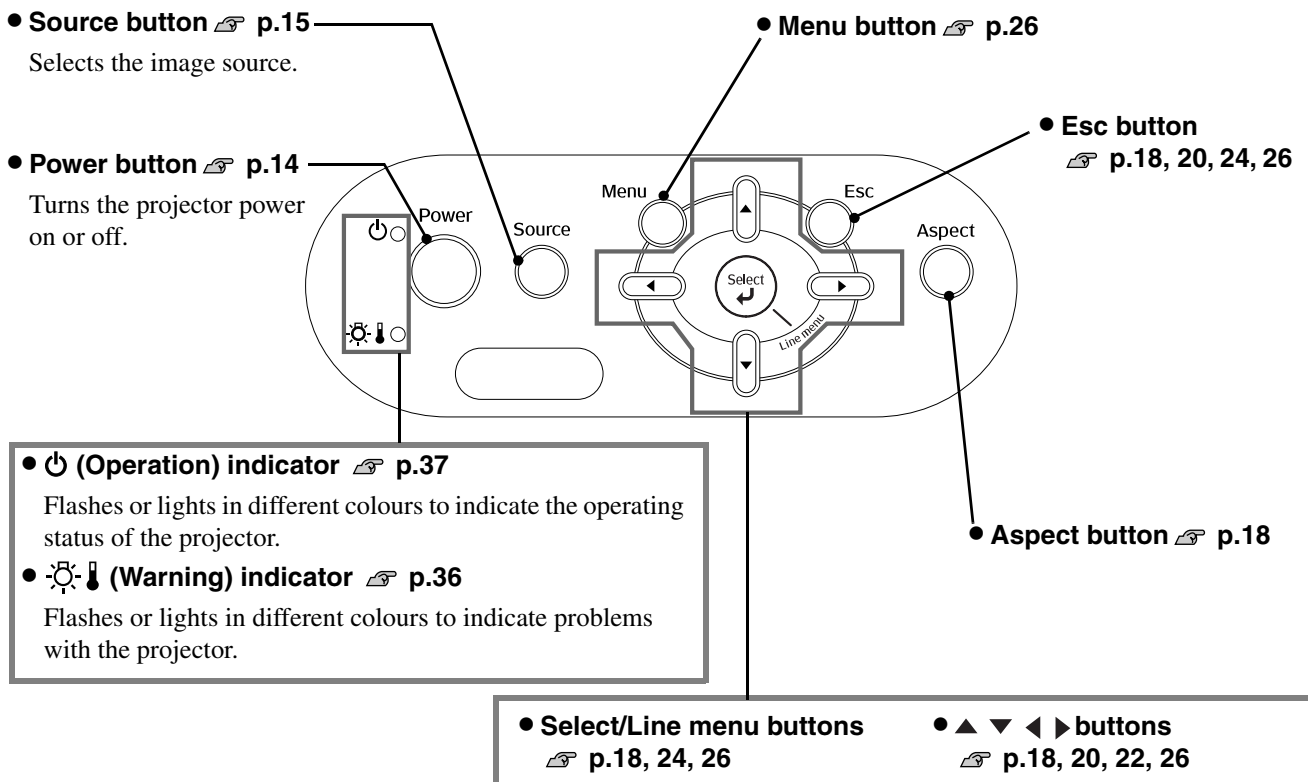





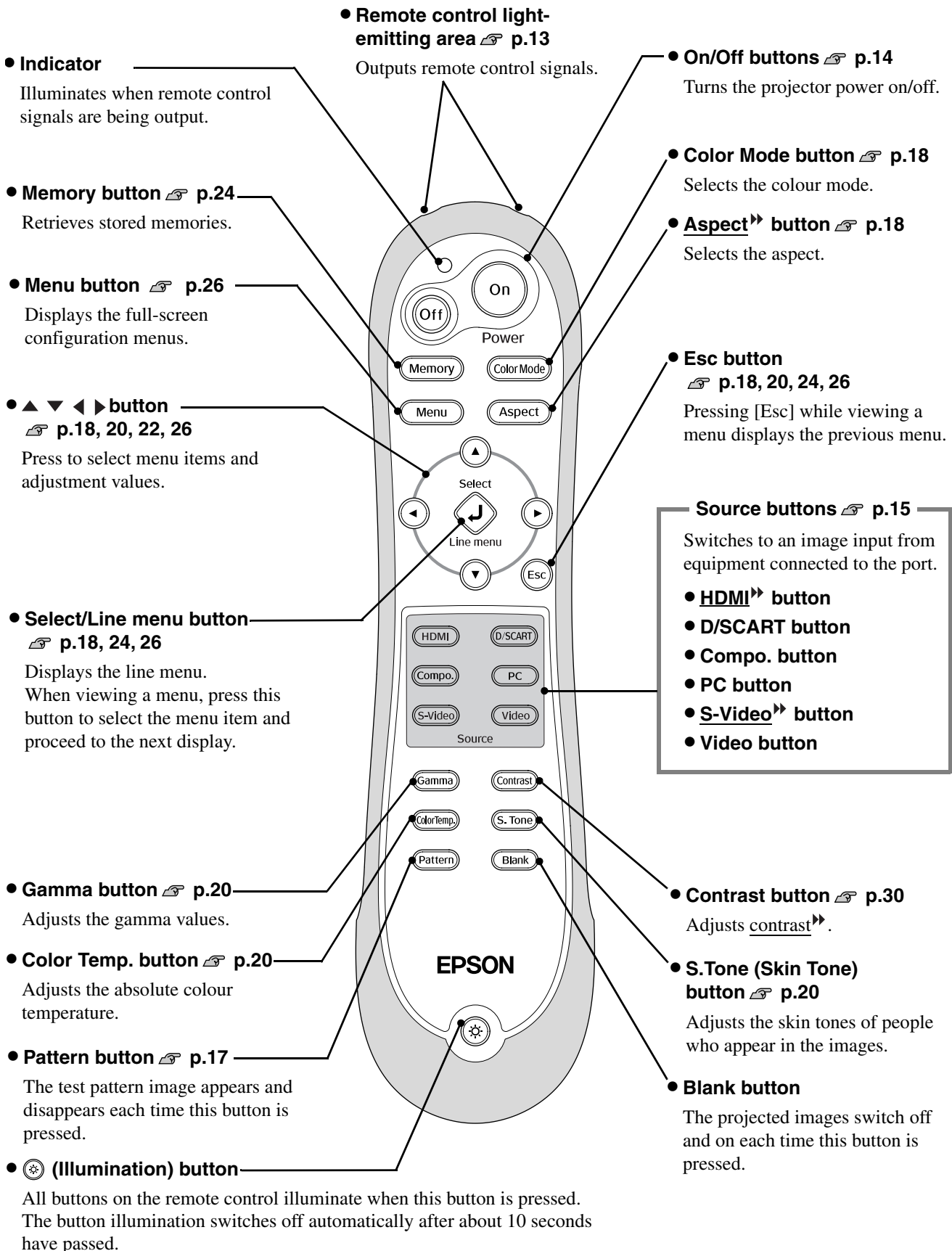







## Remote control



## Rear

- **[SCART] input port**  p.12  
Connects to the component (YCbCr or YPbPr) out port or D out port of the video equipment.
- **[Component] input port**  p.12  
Connects to the component (YCbCr or YPbPr) out port of the video equipment.
- **[PC] input port**  p.12  
Connects to the RGB out port of the computer.
- **[HDMI] input port**  p.12  
Connects to video equipment or a computer that is HDMI-compatible.
- **[Trigger out] port**  
When the projector power is turned on, a 12 V DC signal is output from this port. When the projector's power is turned off or a problem with operation occurs, the output becomes 0 V to send the projector's power ON/OFF status to an external device.
- **Remote control light-receiving area**  p.13  
Receives signals from the remote control.
- **Security lock**  p.55 
- **[Video] input port**  p.12  
Connects to general video out ports of the video equipment.
- **Main power switch**  p.14
- **[RS-232C] port**  
Connects the projector to a computer using an RS-232C cable. This port is for control use and should not be used by the customer.
- **[S-Video] input port**  p.12  
Connects to the S-Video out ports of the video equipment.
- **Power inlet**  p.14  
Connects the power cable.

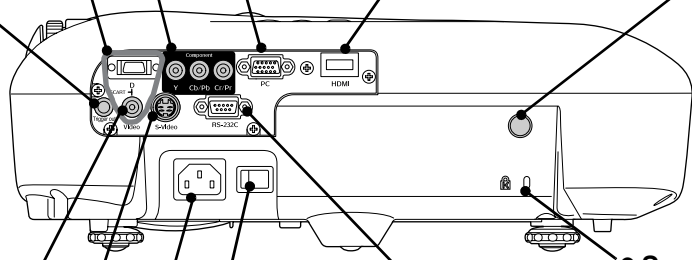

## Base

- **Suspension bracket fixing points (4 points)**  p.48  
Install the optional ceiling mount here when suspending the projector from a ceiling.

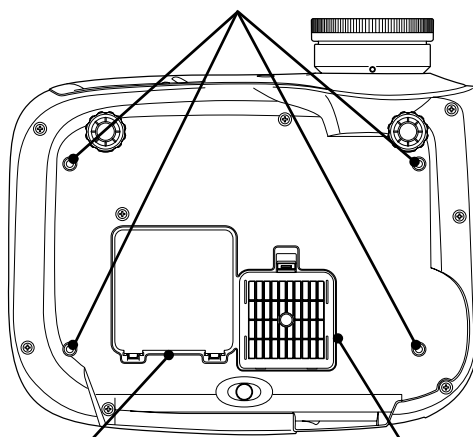

- **Lamp cover**  p.46  
Open this cover when replacing the lamp inside.
- **Air filter (air intake vent)**  p.44, 46  
Prevents dust and other foreign particles from being drawn into the projector. It should be cleaned periodically.

# Appearance

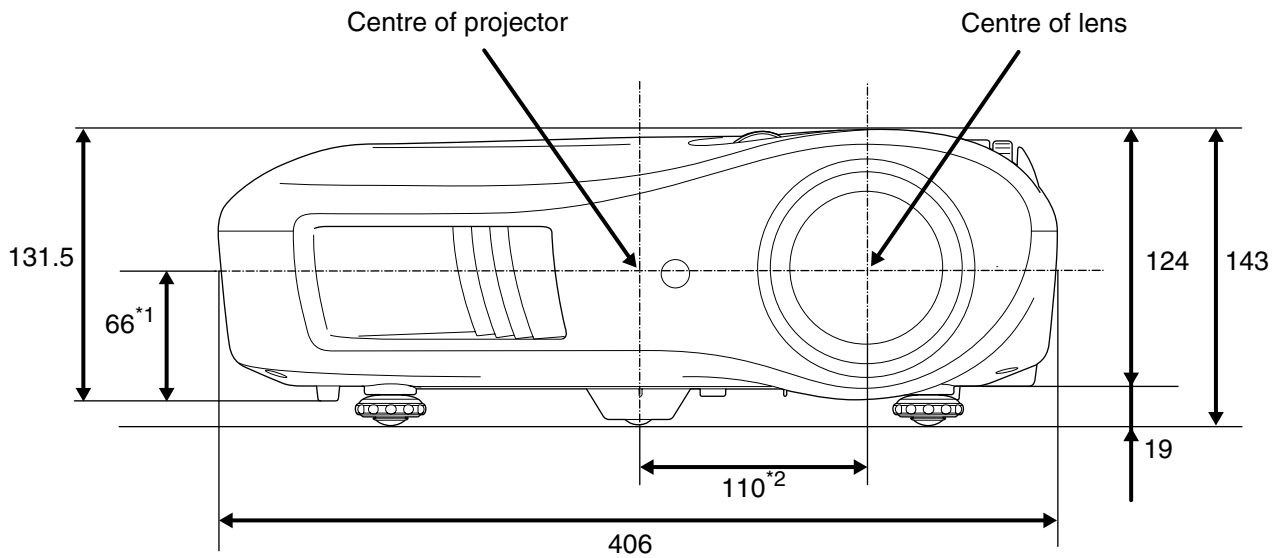

- \*1 Distance from centre of lens to suspension bracket fixing point (Lens shift amount: Max. 8.8 mm vertically)
- \*2 Distance from centre of lens to centre of projector (Lens shift amount: Max. 7.7 mm horizontally)

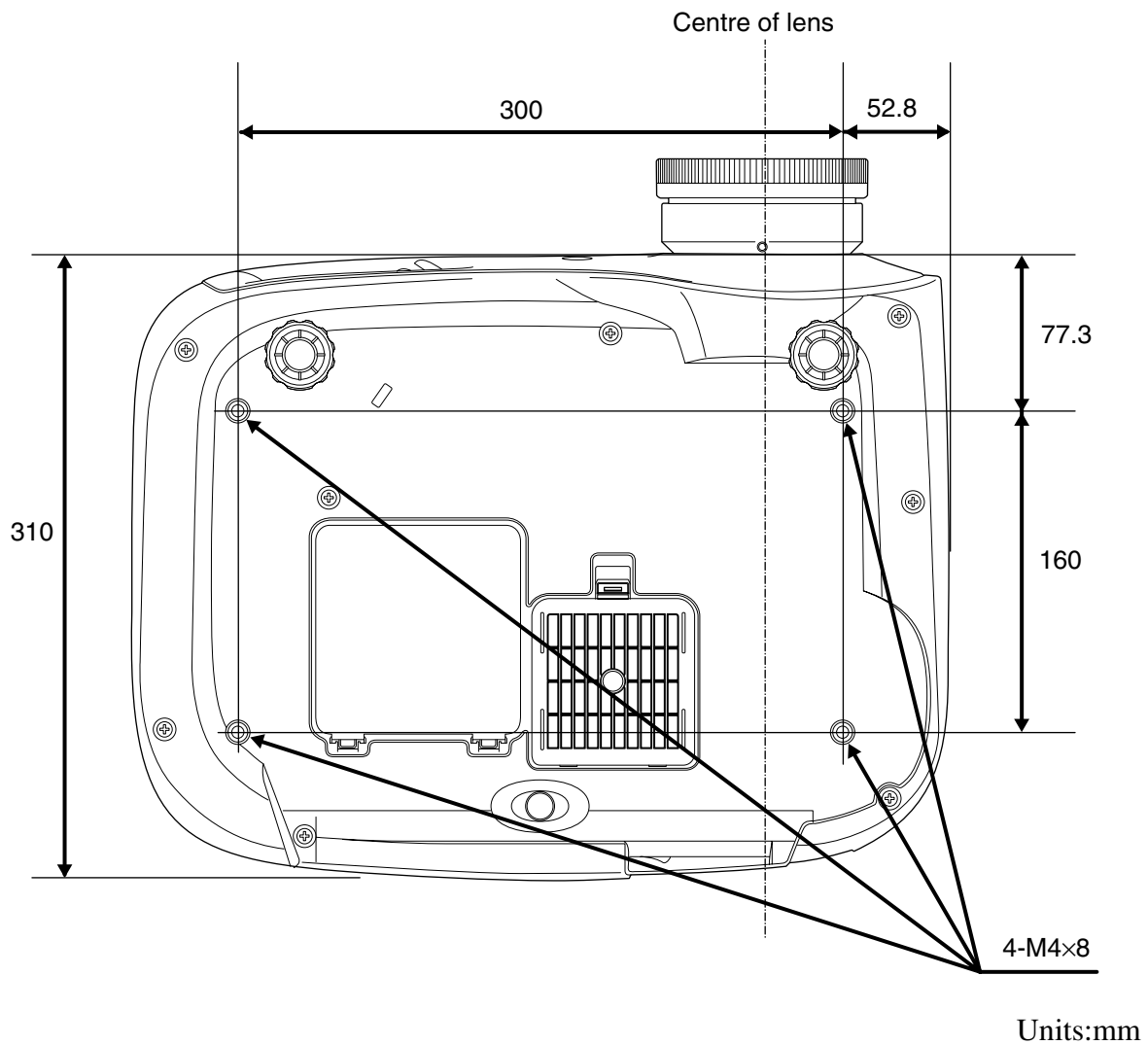

## Adjusting the projection size

The size of the projected image is basically determined by the distance from the projector's lens to the screen.

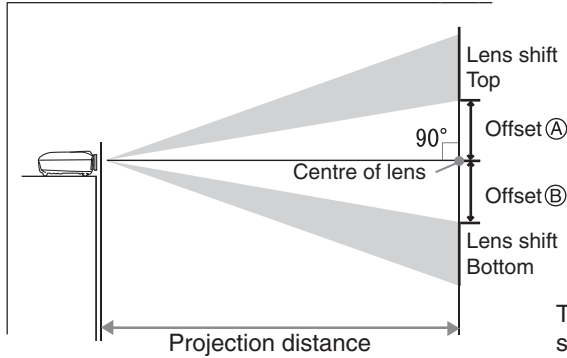

The height from the centre of the lens to the bottom of the screen will vary depending on the lens shift setting.

While referring to the table below, position the projector so that the images are projected onto the screen at the optimum size.

The values should be used as a guide for setting up the projector.

Units: cm (in.)		Units: cm (ft.)	Units: cm (in.)	
16:9 screen size		Projection distance		Offset (A) to Offset (B)
		Shortest (Wide)	Longest (Tele)	
30"	66x37 (26x15)	87 to 188 (2.8 to 6.2)	17 to -17 (6.8 to -6.8)	
40"	89x50 (35x20)	117 to 252 (3.8 to 8.3)	23 to -23 (9.1 to -9.1)	
60"	130x75 (51x28)	177 to 380 (5.8 to 12.5)	35 to -35 (13.6 to -13.6)	
80"	180x100 (71x39)	238 to 508 (7.8 to 16.7)	46 to -46 (18.2 to -18.2)	
100"	220x120 (87x47)	298 to 636 (9.8 to 20.9)	58 to -58 (22.7 to -22.7)	
120"	270x150 (106x59)	359 to 764 (11.8 to 25.1)	69 to -69 (27.2 to -27.2)	
150"	330x190 (130x75)	450 to 956 (14.7 to 31.4)	86 to -86 (34.0 to -34.0)	

Units: cm (in.)		Units: cm (ft.)	Units: cm (in.)	
4:3 screen size		Projection distance		Offset (A) to Offset (B)
		Shortest (Wide)	Longest (Tele)	
30"	61x46 (24x18)	106 to 230 (3.5 to 7.6)	21 to -21 (8.3 to -8.3)	
40"	81x61 (32x24)	143 to 309 (4.7 to 10.1)	28 to -28 (11.1 to -11.1)	
60"	120x90 (47x35)	217 to 465 (7.1 to 15.3)	42 to -42 (16.7 to -16.7)	
80"	160x120 (63x47)	291 to 622 (9.6 to 20.4)	56 to -56 (22.2 to -22.2)	
100"	200x150 (79x59)	365 to 778 (12.0 to 25.5)	71 to -71 (27.8 to -27.8)	
120"	240x180 (94x71)	439 to 935 (14.4 to 30.7)	85 to -85 (33.3 to -33.3)	
150"	300x230 (118x91)	550 to 1170 (18.0 to 38.4)	106 to -106 (41.7 to -41.7)	

### Lens shift adjustment

The lens shift dials can be used to position the image and is especially useful when using the projector in the following locations. 📖 p.16

- Hanging from the ceiling
- A screen in a high location
- Projector situated to the side so that the screen can be viewed sitting right in front of it
- Projector situated on a shelf, etc.

When positioning an image using the lens shift dial, hardly any deterioration of the image occurs because the lens shift correction is adjusted optically. However, for optimal image quality the lens shift function should not be used.

## Projection methods

### CAUTION

- Avoid setting the projector up in a place which is very dusty or humid, or where there will be cigarette or other smoke, especially oily smoke.
- Clean the air filter at least once every 3 months.  
Clean the air filter more frequently if using the projector in a dusty environment.
- A special method of installation is required when suspending the projector from the ceiling (ceiling mount). If it is not installed correctly, it could fall causing an accident and injury.
- If you use adhesives on the ceiling mount to prevent the screws from loosening, or if you use things such as lubricants or oils on the projector, the projector case may crack causing it to fall from its ceiling mount. This could cause serious injury to anyone under the ceiling mount and could damage the projector.  
When installing or adjusting the ceiling mount, do not use adhesives to prevent the screws from loosening and do not use oils or lubricants and so on.
- Do not use the projector on its side. This may cause malfunctions to occur.

### ■ When projecting from directly in front

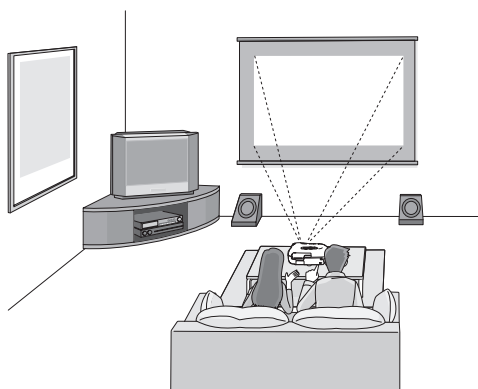

### ■ When projecting from the side of the screen

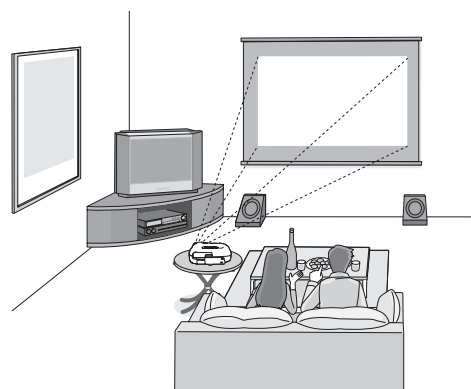

### ■ When projecting from a ceiling

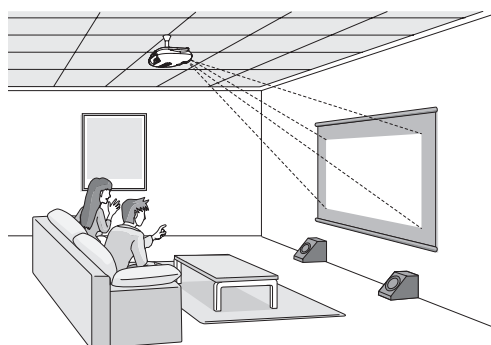

\* Even if projection will be from the screen side, set up the screen and projector so that they are parallel.

\* When suspending the projector from a ceiling, change the configuration menu settings. p.34

#### Configuration menu

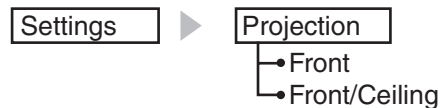

# Connecting Image Sources

## CAUTION

- Turn the power off for both the projector and the signal source before connecting them. If the power for either device is on at the time of connection, damage may result.
- Check the shapes of the cable connectors and the device ports before making the connections. If you try to force a connector to fit a device port with a different shape or number of terminals, a malfunction or damage to the connector or port may result.

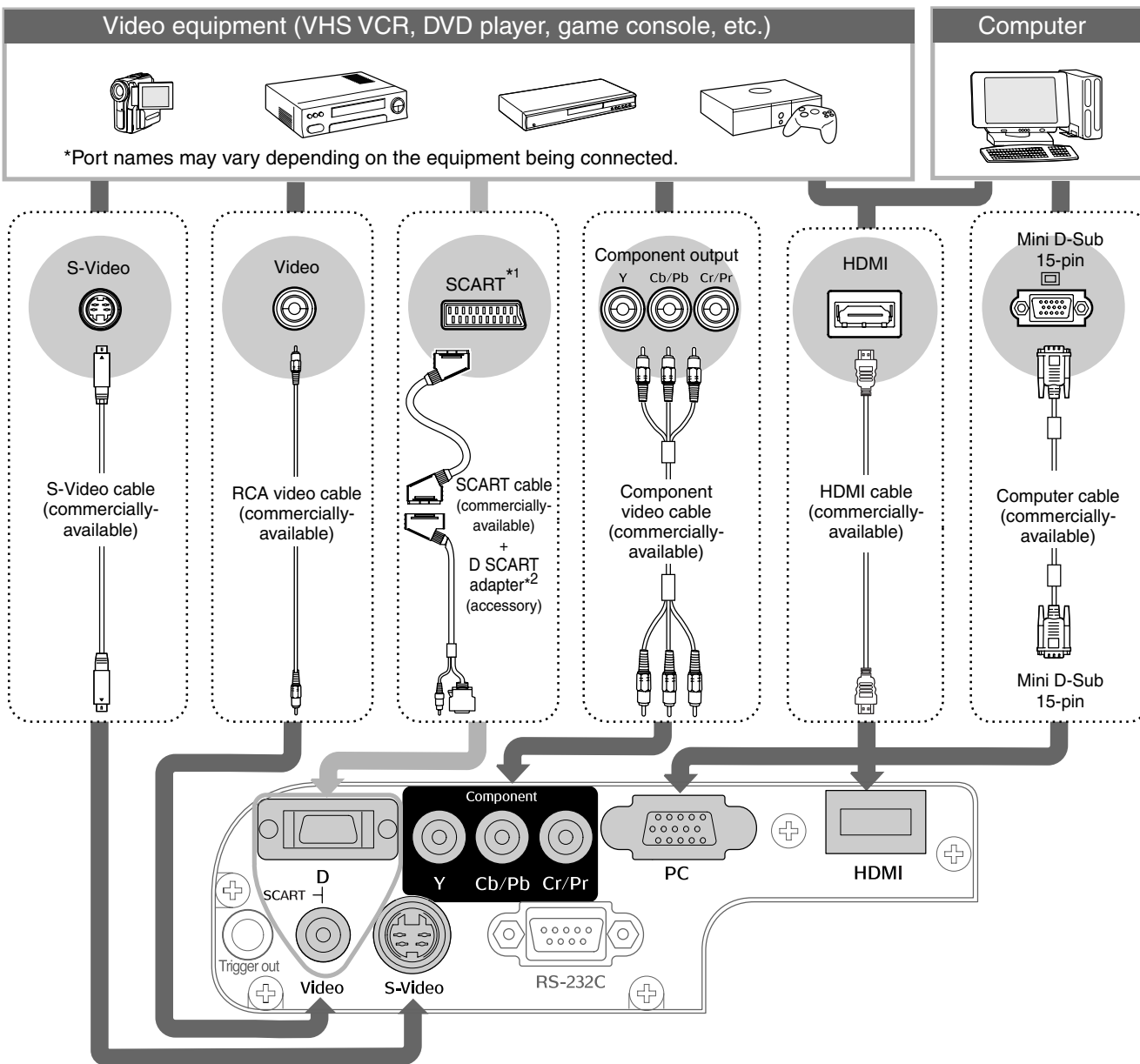

\*1 If a DVD has been connected using a D SCART adapter, change the "D/SCART" setting in the "Input Signal" to "SCART". p.34

\*2 Some regions may not have the D SCART adapter included as an accessory.



TIP

- Some signal sources may have specially-shaped ports. In such cases, use the accessory or optional cables that are supplied with the signal source to make the connections.
- The cable that should be used to connect video equipment to the projector will depend on the type of video signal that the equipment outputs. Some kinds of video equipment output several different types of video signal. The image quality ranking of the video signal types is generally held to be as follows, in descending order of quality: Digital component video [HDMI] Analog component video [D] [Component] S-Video [S-Video] Composite video [Video]  
You should refer to the documentation provided with the video equipment being used to check what types of video signal formats the equipment can output. The composite video format is sometimes simply called "video output".

# Preparing the Remote Control

## Inserting batteries into the remote control

The remote control is not supplied with batteries already inserted. Insert the accessory batteries before using the remote control.

### 1 Remove the battery cover.

While pressing the knob, lift up.

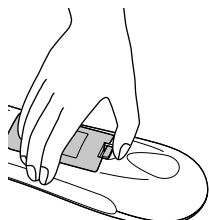

### 3 Install the battery cover.

- ① Insert the tab.
- ② Press down until the battery cover clicks into place.

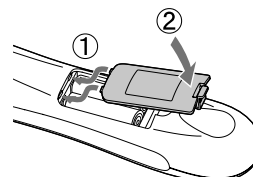

### 2 Insert the batteries.

**CAUTION** Check the (+) and (-) indications inside the battery compartment and insert the batteries so that they face correctly.

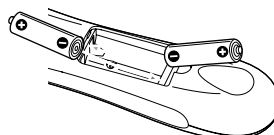

TIP

If delays in the responsiveness of the remote control occur or if it does not operate after it has been used for some time, it probably means that the batteries are becoming flat. If this happens, replace the batteries with two new batteries. Use two new AA batteries as replacement batteries.

## Using the remote control

### ■ Operating range (horizontal)

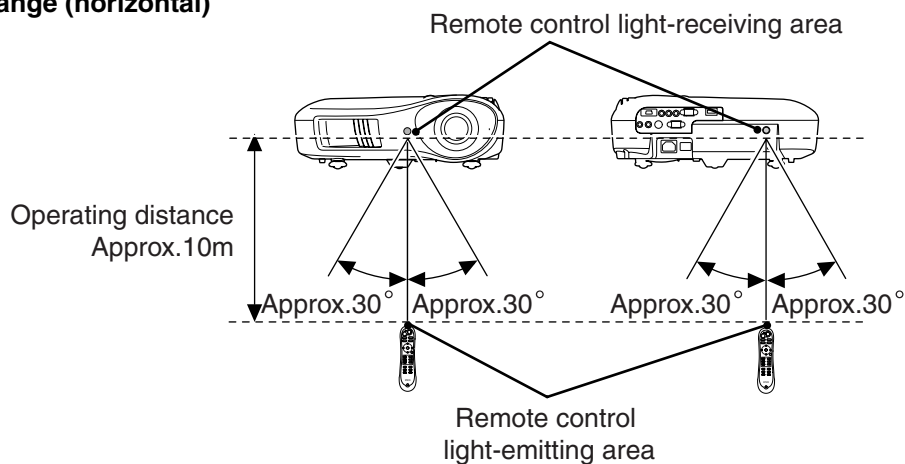

### ■ Operating range (vertical)

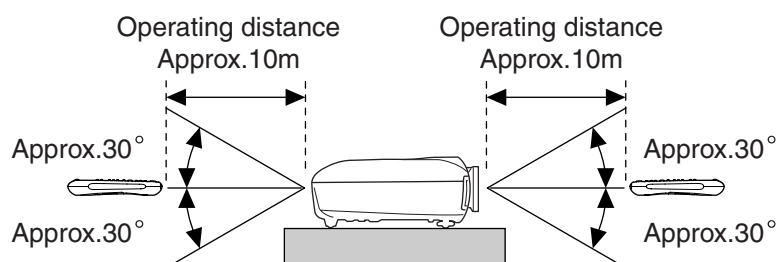

# Projecting Images

## Turning the power on and projecting images

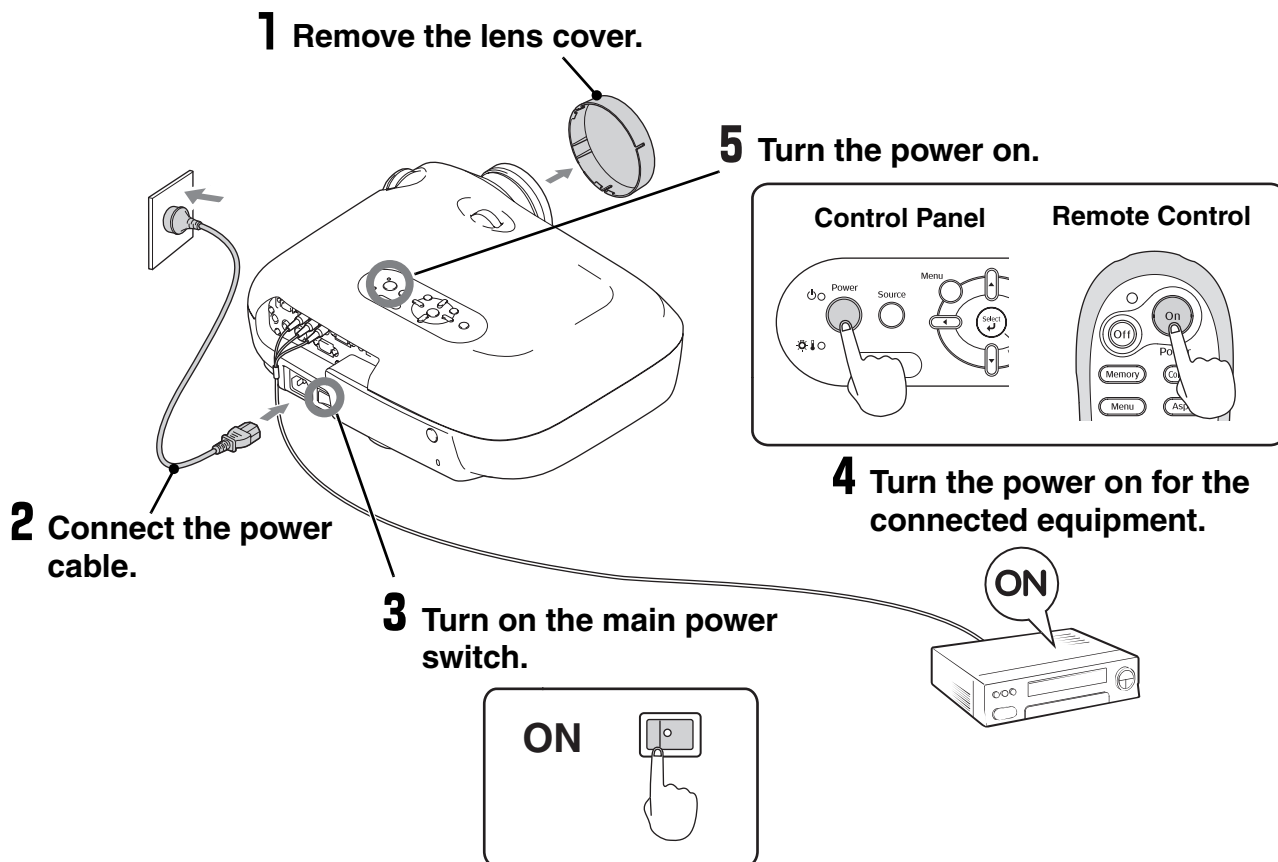

If there is a problem with projection even though the projector is set up and connected correctly, refer to [p.15, 36](#).



TIP

- If you set the "Direct Power On" to "On", the power of the unit will turn ON when the main power switch is turned ON, without having to press the power button of the remote control or the projector's control panel.
- The projector is equipped with a "Child Lock" function that prevents young children from accidentally turning the power on and looking into the lens, and also an "Operation Lock" function that prevents mis-operations. [p.33](#)
- When using above an altitude of about 1500 m, make sure you set the "High Altitude Mode" to "On". [p.33](#)
- This projector is equipped with an automatic adjustment function that automatically optimizes it when a computer input signal is switched.
- If a laptop computer or a computer with a LCD screen has been connected to the projector, you may need to use keyboard or function settings to change the output destination. While holding down the **Fn** key, press **F0** (the key with a symbol such as / on it). After the selection is made, projection will soon start.  
[Computer documentation](#)

Example of output selection

NEC	
Panasonic	<b>Fn</b> + <b>F3</b>
SOTEC	
HP	<b>Fn</b> + <b>F4</b>
Toshiba	<b>Fn</b> + <b>F5</b>
IBM	
SONY	<b>Fn</b> + <b>F7</b>
DELL	<b>Fn</b> + <b>F8</b>
Fujitsu	<b>Fn</b> + <b>F10</b>
Macintosh	Set mirror setting or display detection. Depending on OS, you can change the output selection by pressing <b>F7</b> .



## When the expected images are not projected

If more than one signal source has been connected, or if no images are projected, use the remote control or the projector's control panel buttons to select the signal source. For video devices, press the [Play] button on the video equipment first, then select the signal source.

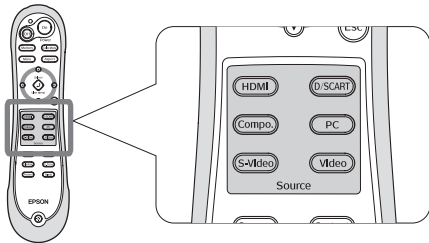

### Using the remote control

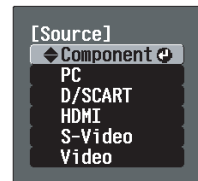
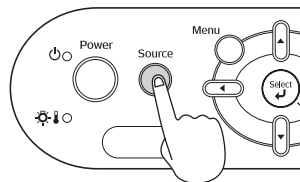

Press the button that has the name of the port on it that the desired signal source is connected to.

### Using the control panel









When you press , the menu is displayed. Each press of  moves the pointer. Move the pointer to the target input source to select it. Press  to accept. The input source is automatically changed if no operations are performed for about 5 seconds with the pointer at the target input source.



**TIP** When the colour of the image projected from the [D] or [Component] input port is unnatural, select an appropriate signal according to the signal from the device connected at "Input Signal" in the Configuration menu.  p.34

## Turning the power off

- 1** Turn the power off for the signal sources that are connected to the projector.
- 2** Press  on the remote control or  on the projector's control panel. If you press  on the projector's control panel, the following message will be displayed. Press  again to continue.
- 3** When the projector has cooled down  (takes about 30 seconds), turn off the main power switch. Simply pressing  or  does not stop electricity consumption.
- 4** Attach the lens cover.

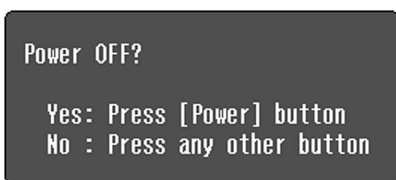

# Adjusting the Projection Screen

## Focus adjustment

Turn the focus ring to adjust the focus.

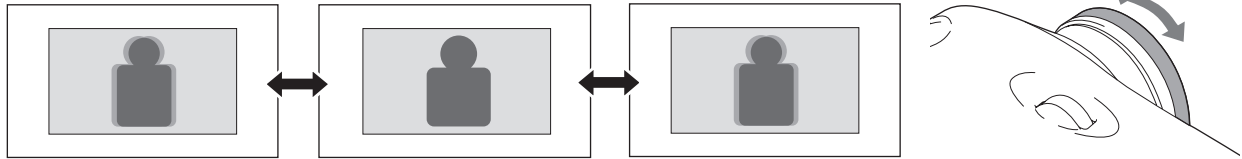

## Fine adjustments to image size (Zoom adjustment)

Turn the zoom ring to adjust the size of the projected image.

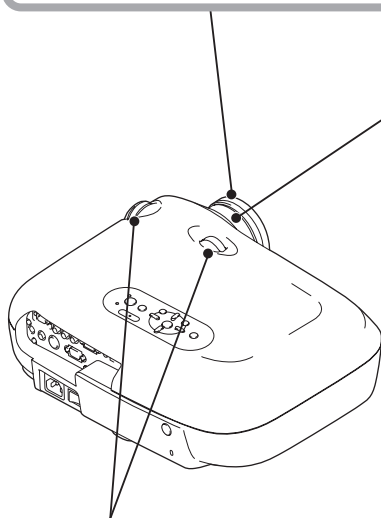
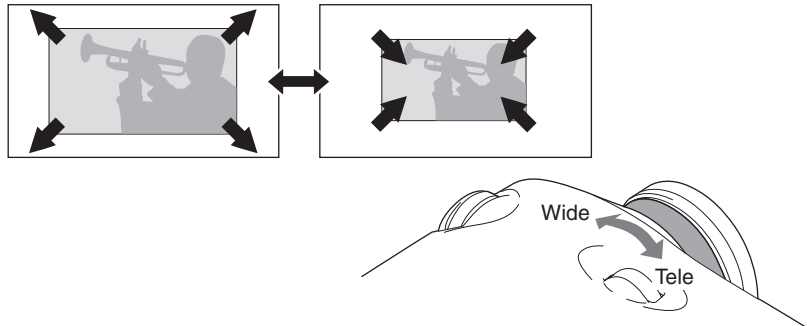

## Projection image position adjustment (Lens shift)

The lens shift function can be used to move the image display position vertically and horizontally within the range shown in the figure on the right when you cannot set up this projector directly in front of the screen, or when the image is projected too low or too high.

When you turn the lens shift dial and hear a click, the lens position is almost centred.

The image display position cannot be moved to the maximum positions in both the vertical and horizontal positions.

Ex) The image cannot be shifted vertically when it has been shifted horizontally by the full amount. When the image has been shifted vertically by the full amount, it can be shifted up to 9% of the horizontal width of the screen.

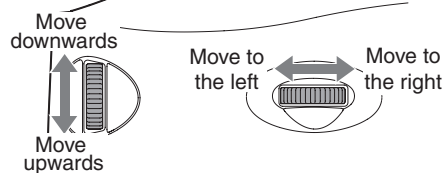
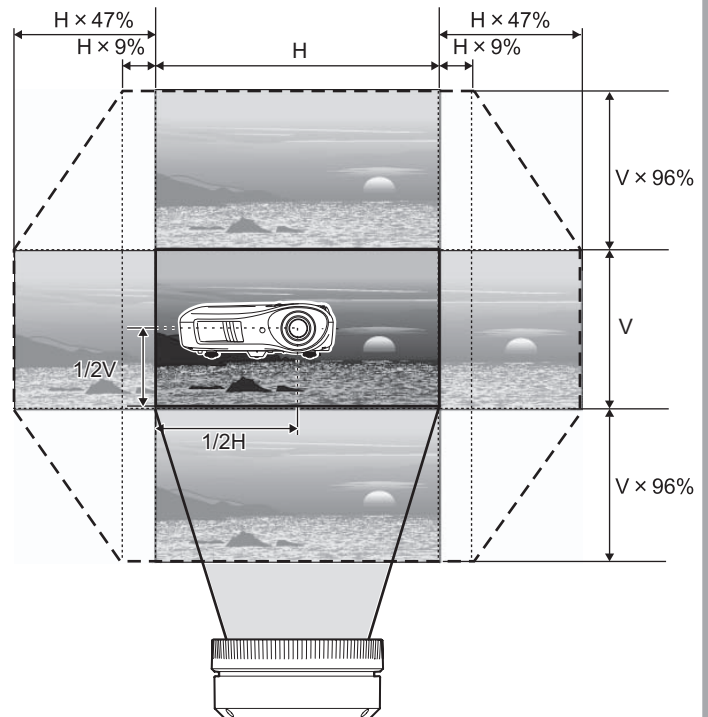

Standard projection position  
(centre position for lens shift)

Range that the picture can be shifted  
from the standard projection position

### CAUTION

When transporting the projector, make sure to turn the lens position down by the full amount. Otherwise the lens shift mechanism may be damaged.

### Correcting projector tilt

If the projected images are tilted horizontally (, use the front adjustable feet to adjust the projector so that it is horizontal.

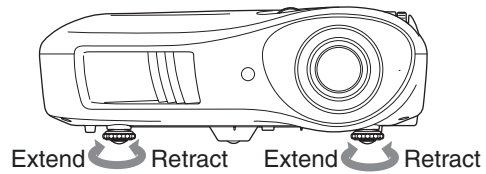

### Displaying a test pattern

You can project a test pattern at times such as when setting up the projector in order to perform adjustments in the line menu, and zoom and focus adjustments without having to connect video equipment. If  on the remote control is pressed, the test pattern appears.

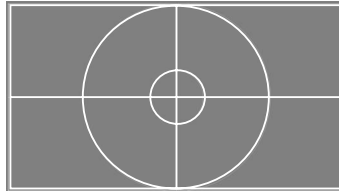

To stop displaying the test pattern, press  again.

# Basic Image Quality Adjustments

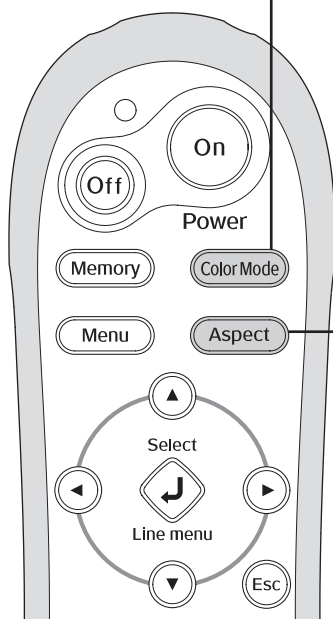

## Selecting the colour mode

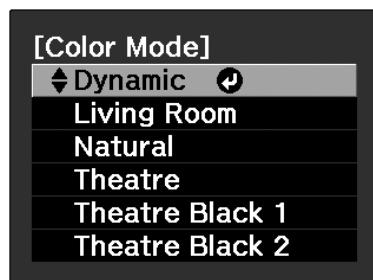

Press **Color Mode** and select the colour mode from the menu.  
Setting is also possible using the configuration menu.

## Selecting the aspect

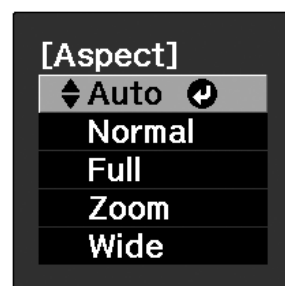

Press **Aspect** and select the aspect mode from the menu.

### Select Menu Operations

Press **▲** or **▼** on the remote control or **↑** on **↓** on the projector's control panel to select an item.

Press **↵** or **↵** to confirm the selection.

\*If you press **Esc**, the Select menu disappears.



TIP

If you project an image that is compressed, enlarged or separated using the aspect function in public places such as a store or hotel for the purposes of profit-making or public display, it may result in infringing on the author's right that is protected by copyright law.

### When projecting using **Auto**









- For 4:3 input signals → Normal
- For input images recorded in squeeze mode → Full
- For letterbox input signals → Zoom

\*1 Not usable during computer input. Not compatible with certain component video signals.

\*2 If Auto is not suitable, the setting will become Normal.

- Dynamic** : Ideal for using in bright rooms.
- Living Room** : Ideal for using in rooms in which the curtains are closed.
- Natural** : Ideal for using in dark rooms. It is recommended that you start in this mode when making colour adjustments.
- Theatre** : Ideal for using in dark rooms.
- Theatre Black 1** : Suitable for use in a completely darkened room.
- Theatre Black 2** 1: A clear tone of colour one might see in professional monitors used when creating DVD software.  
2: A deep warm tone of colour that gives you the feeling of enjoying a movie at the theatre.

When you select the colour mode indicated with **■**, the Epson Cinema Filter will be applied automatically to increase the contrast and makes skin tones more natural.

Input signal	<ul style="list-style-type: none"> <li>● Normal TV broadcasts</li> <li>● Images with standard aspect ratio (4:3)</li> <li>● Computer images</li> </ul>	Images recorded by a video camera or DVD software in squeeze mode	Letterbox images	<ul style="list-style-type: none"> <li>● Normal TV broadcasts</li> <li>● Images with standard aspect ratio (4:3)</li> </ul>
Recommended aspect mode	<b>Normal</b>	<b>Full</b>	<b>Zoom</b>	<b>Wide</b>
Result	 Black bands will appear at the left and right of the images.	 Input signals will be projected at the same width as the projector's panel resolution.	 Input signals will be projected at the same height as the projector's panel resolution.	 Input signals will be projected at the same height as the projector's panel resolution. At this time, the image enlargement ratio will be smaller near the middle of the images but become larger towards the left and right edges of the images.
Remarks	 When <b>HDTV</b> mode images are projected, the images appear in 16:9 size.	 When 4:3 images are projected, the images will be elongated horizontally.	<ul style="list-style-type: none"> <li>● When a 4:3 image is projected, the top and bottom of the image are hidden from view. If this happens, the part of the image hidden from view at the top and bottom can be reduced in size in the vertical direction so that it can be viewed by "Zoom Size" in the configuration menu.  p.31</li> <li>● When images with subtitles are projected and the subtitles are truncated, use the "Zoom Caption Pos." menu command to adjust.  p.31</li> </ul>	This is useful for when 4:3 images are projected onto a wide screen. Because there is almost no distortion due to enlargement in the middle of the images, the images appear close to what they would be at their original size. And because both ends of the images are enlarged, movement at the edges of the images appears faster and gives an impression of greater speed, making it ideal for viewing sporting events.

# Advanced Colour Adjustments

If you would like to create your own images with settings adjusted the way you want them, you can adjust "Abs. Color Temp.", "Skin Tone" and/or "Advanced" in the "Image" menu.

The adjustment values can be stored in the memory so that you can retrieve them and apply them to the projected images at any time. ( p.24)

"Skin Tone", "Abs.Color Temp." and "Gamma" are adjusted in a single operation using the respective remote control buttons.

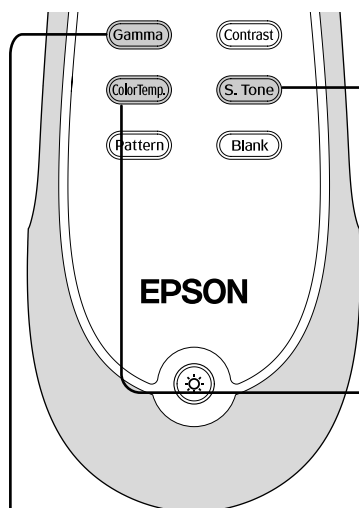

## Skin tone adjustment



## Absolute colour temperature adjustment



## Gamma adjustment

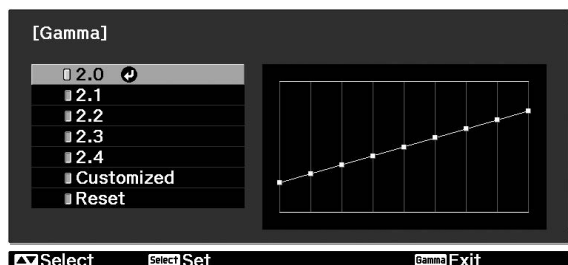

Differences between equipment may result in a slight variation in the colouring when images are projected, and you may want to adjust this. (Projection will stop temporarily during such adjustment.) There are two methods of doing so. One is to select one of the gamma correction values [2.0], [2.1], [2.2], [2.3], [2.4]. The other is customized adjustment, which is done with reference to the projected image or a gamma graph. The gamma graph's horizontal axis represents the input signal level and its vertical axis the output signal level.

### ■ Adjusting from the gamma correction values

From among the gamma correction values [2.0], [2.1], [2.2], [2.3], [2.4], select one that suits the connected equipment, or one of your own liking, using  $\uparrow$   $\downarrow$  or  $\leftarrow$   $\rightarrow$ , and press  $\diamond$  or  $\odot$  to confirm the selection.

Observe the gamma graph to check the result of the adjustment.

Lower values will increase the contrast of the dark portions but will tend to blur the bright portions. This is indicated by bulging in the upper portion in the gamma graph.

Higher values will darken the bright portions. This is indicated by bulging in the lower portion in the gamma graph.

This can be used to adjust the skin tones for images of people.

The Epson Cinema Filter effect that is automatically applied to images when a "Color Mode" setting is made creates natural-looking skin tones. If you would like to further enhance skin tones, use this "Skin Tone" setting to make the adjustment.

If set to the + side, the colours become greenish, and if set to the – side, the colours become reddish.

You can adjust the overall tint of images.

If you select a higher value, images appear bluish, and if you select a lower value, images appear reddish. The absolute colour temperature can be set to one of 12 settings within the range of 5000K to 10000K.

### ■ Customized ("Adjust it from the image")

Use or to select first "Customized", then "Adjust it from the image". Press or to confirm the selection each time. A gamma icon will appear in the projected image.



Use or to move the gamma icon to the place where you want to adjust the brightness, and press or to confirm the selection. The place selected and the regions of the same brightness will flash, and a gamma graph will appear. Press or again to reconfirm. A screen for adjusting the tone will appear. Use or to make the adjustment, and press or to confirm it. Press to go back and do it again.

### ■ Customized ("Adjust it from the graph")

Use or to select first "Customized", then "Adjust it from the graph". Press or to confirm the selection each time. A gamma adjustment graph will appear.

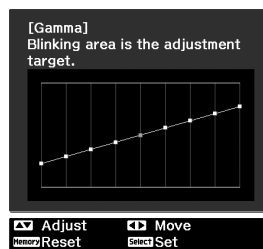

Use or to select the point where you want to adjust the tone brightness, and press or to confirm the selection. A screen for adjusting the tone will appear.

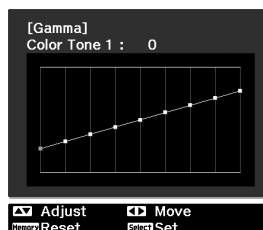

Use or to make the adjustment, and press or to confirm it.

## RGB adjustment (Offset, Gain)

The image brightness can be adjusted by adjusting the individual R (red), G (green) and B (blue) components of the dark areas (offset) and bright areas (gain).

### ■ Offset

If you would like dark areas to appear more clearly, change the setting to the + (right) side. If you change it to the – (left) side, the whole image will become sharper, but the contrast in dark areas will become poorer.

### ■ Gain

If you would like bright areas to appear more clearly, change the setting to the – (left) side. If you change it to the + (right) side, you will feel that the image is becoming brighter and closer to white, but the contrast in light areas will become poorer.

- 1 Press **Menu** and then select "Image" - "Advanced" - "RGB" in that order and confirm the selection.



- 2 Use **▲▼** or **◀▶** to select a menu item, and use **◀▶** or **◀▶** to make adjustments.

To return the adjustment results to their default settings, press **Memory**.

- 3 Press **Menu** to exit the menu.

## Hue and saturation adjustment

The hue and saturation for each of the red (R), green (G), blue (B), cyan (C), magenta (M) and yellow (Y) colour components can be adjusted.

### ■ Hue

Adjusts the tone of the entire image to bluish, greenish and reddish.

### ■ Saturation

Adjusts the overall vividness of the images.

- 1 Press **Menu** and then select "Image" - "Advanced" - "RGBCMY" in that order and confirm the selection.

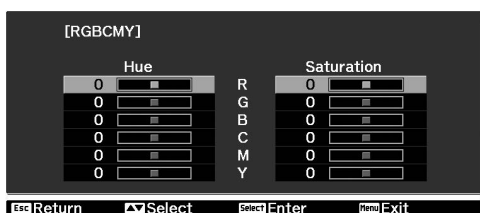

- 2 Press **▲▼** or **◀▶** to select a colour and press **Select** or **Enter** to confirm. Select either hue or saturation and use **◀▶** or **◀▶** to adjust.

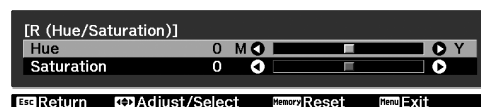

To adjust another colour, press **Esc**.

To return the adjustment results to their default settings, press **Memory**.

- 3 Press **Menu** to exit the menu.



# Examining Image Quality Further

In addition to colour adjustments, adjustments to advanced sharpness and the amount of light from the lamp can also be made to match the image in search of the best picture.

## Sharpness (Advanced) adjustment

This cannot be adjusted during input of computer image signals.

If "High-band Enhancement" is set in the + direction, hair and the detailed areas of clothing will be emphasized.

If "Low-band Enhancement" is set in the + direction, the areas emphasized by "High-band Enhancement" will be hardly emphasized. Instead, the rough areas of the entire subject, such as contour and background, will be emphasized, resulting in a sharp image.

Setting "Horiz. Line Enhancement" / "Vert. Line Enhancement" to the + side will enhance the image sharpness in the horizontal / vertical direction. Setting them to the - side will give a soft image.

- 1 Press **Menu**, and then select "Image" - "Sharpness". Select "Advanced" at the top-right corner of the screen to confirm the selection.

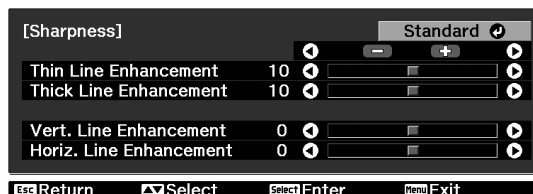

- 2 Use **Up/Down** or **Left/Right** to select a menu item, and use **Left/Right** or **Up/Down** to make adjustments. You can adjust "High-band Enhancement" and "Low-band Enhancement" at the same time by using the bar on the top in the screen. To return the adjustment results to their default settings, press **Memory**.

- 3 Press **Menu** to exit the menu.

## Auto Iris (automatic aperture) setting

When "Auto Iris" is set to "On", the amount of light will be automatically adjusted to the brightness of the image, creating a picture with depth and perspective.

\* An operation sound of Auto Iris function may be emitted while projecting some images. This is not a failure of the projector.

- 1 Press **Menu**, and then select "Image" - "Auto Iris".

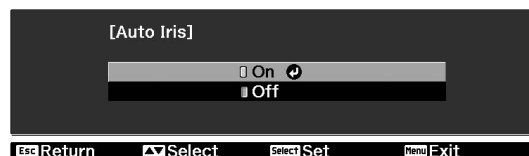

- 2 Select "On".
- 3 Press **Menu** to exit the menu.

# Viewing Images at a Preset Image Quality(Memory Function)

After menu commands such as "Image" has been used to adjust the projected images, the adjustment values can then be saved (Save Memory).

In addition, the saved data can be retrieved easily, so that you can enjoy viewing images with the adjusted settings at any time (Load Memory).

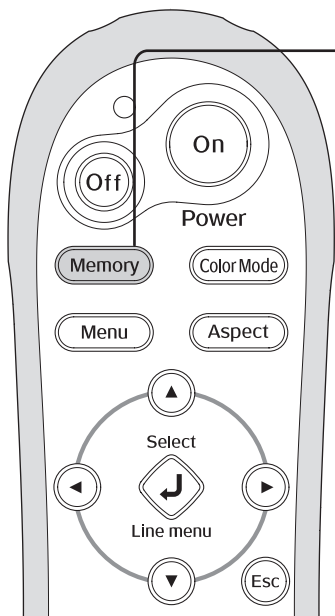

## Saving, Loading and Erasing Memory

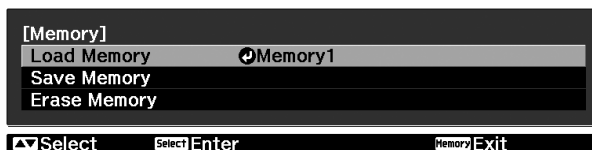

The adjustments that can be saved to memory are as follows.

Up to ten adjustments can be saved to memory.

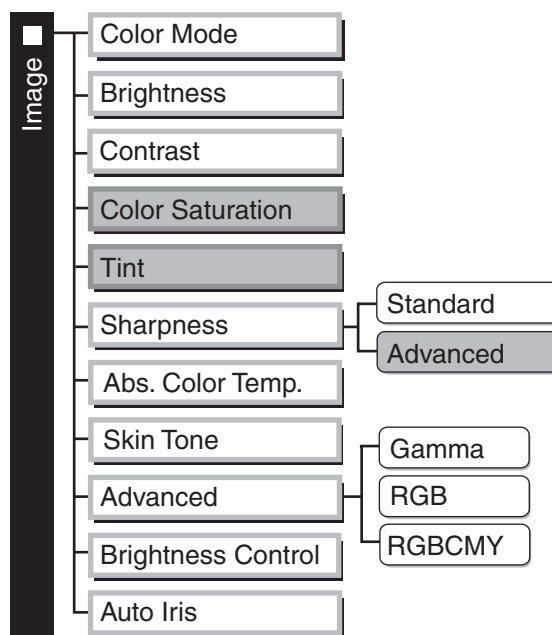

## ■ Save Memory

1 Adjust each of the settings to the values to be saved.

2 Press **Memory**, and select "Save Memory".

The Save Memory screen is displayed.

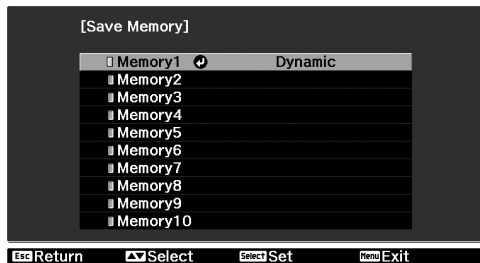

3 Select the memory name to register the adjustments to from Memory1 to 10, and press **Select** or **Select**.

When **█** preceding the memory name is green, this indicates that adjustments are already saved to memory.

Select an already saved memory name, and press **Select** or **Select**.

A confirmation message will be displayed.

If you select "Yes", the previous memory content is erased, and the current adjustment values are saved.

## ■ Load Memory

Load saved memories.

1 Press **Memory**, and select "Load Memory".  
The Load Memory screen will be displayed.

2 Select the target memory name.



TIP

- The colour mode selected when the memory was registered is displayed on the right side.
- Memory settings that have been applied to images will be retained even when the projector's power is turned off. The same memory adjustment settings will be applied to images that are projected the next time the projector's power is turned on.
- The **aspect** setting retrieved from memory may not be applied to the images if they are 16:9 images or if the input signal images have a particular resolution.

## ■ Erase Memory

This feature can be used to erase and clean up unwanted memories.

1 Press **Memory**, and select "Erase Memory".  
The Erase Memory screen will be displayed.

2 Select the memory name to erase.  
A confirmation message will be displayed. If you select "Yes", the memory will be erased.

To erase all saved memories, select "Reset" - "Reset Memory" in the Configuration menu.

p.35

# Configuration Menu Functions

The configuration menus can be used to make a variety of adjustments and settings involving image quality and input signals.

The following two types of menu are available.

## ■ Full menu

All items in the configuration menu can be checked while the settings are being made.

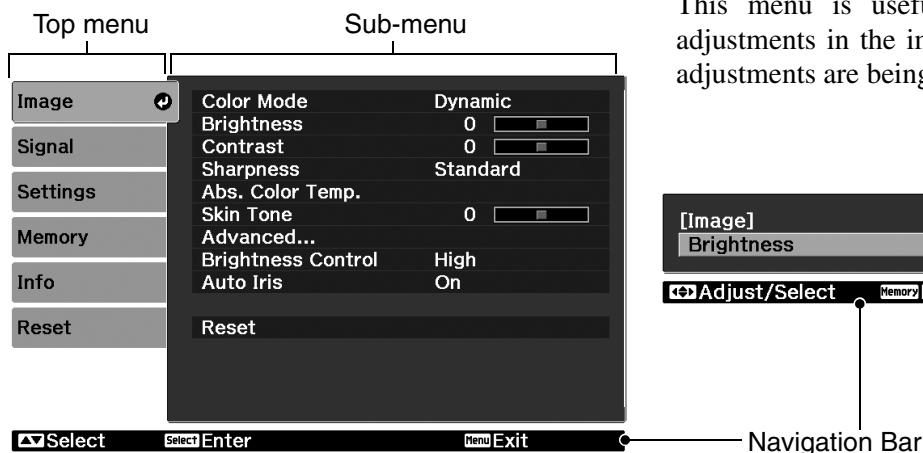

## ■ Line menu

Some of the items in the "Image" menu in the Configuration menu can be adjusted.

This menu is useful for viewing the effects of adjustments in the images being projected while the adjustments are being made.



Refer to "Using the configuration menus" (p.26) for details on menu operations.



The Configuration menu can be used to change the colour pattern and display position of the menus.

☞ "Settings" - "Display" - "Menu Position", "Menu Color"

## Using the configuration menus

### 1 Displaying a menu

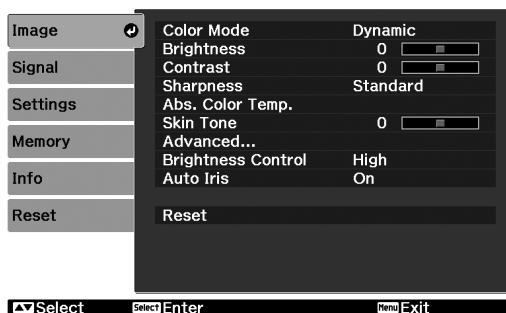

Full menu: Press .



Line menu: Press  or .



### 2 Selecting a menu item

Use  or  to select a menu item, then press .

### 3 Changing settings

Example:



Use or to adjust values.

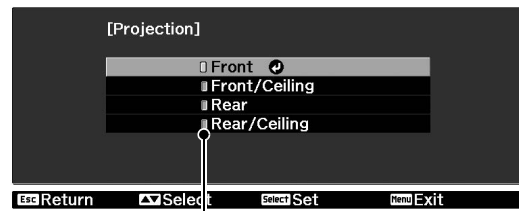

(green): Current setting value

Use or to select an item, then press .

If you press when an item with next to it is selected, the selection screen for that item will be displayed.

To return to a previous display, press .

### 4 When setting is complete



Press .

## List of configuration menus

When no image signals are being input, the "Image" menu and the "Signal" menu cannot be adjusted. Also, the items displayed in the "Image" menu, the "Signal" menu and the "Info" menu will vary depending on the type of image signals that are being projected.

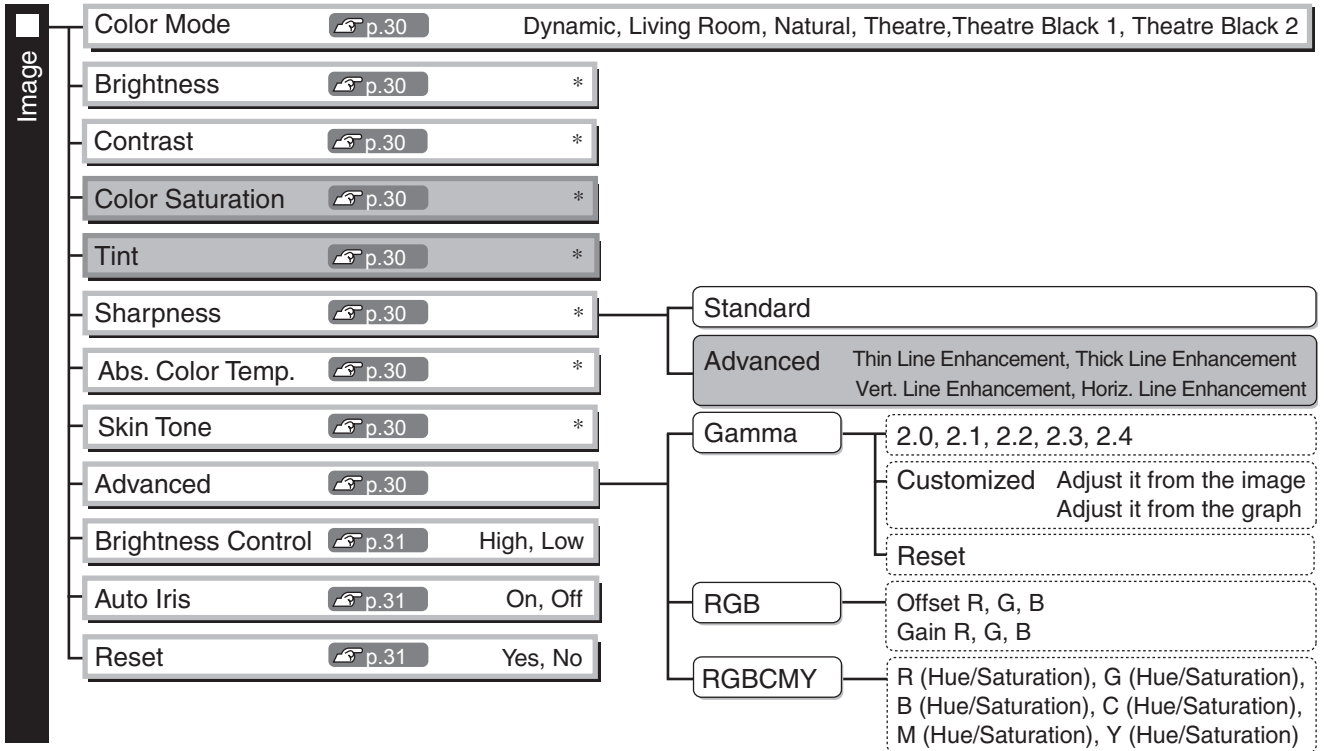
 Displayed for input sources other than computer      \* This is displayed in the line menu.



 Displayed for input sources other than computer       Only displayed for Computer input  
(does not appear when signals from the [HDMI] input port are being input)

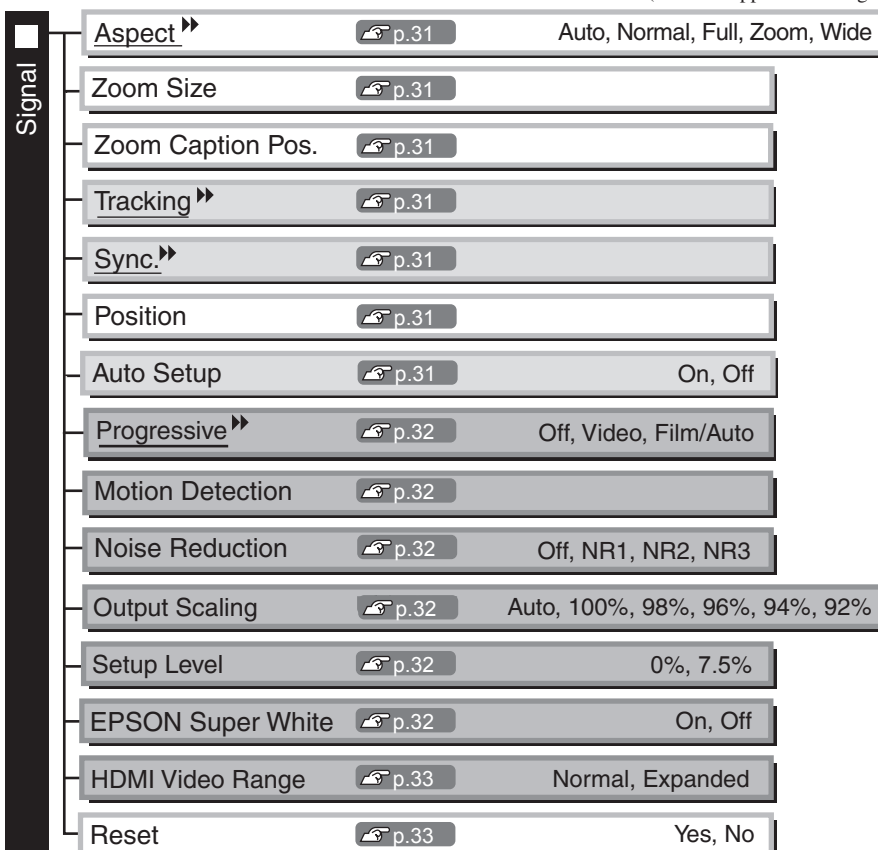

Settings	Direct Power On	p.33	On, Off	
	Sleep Mode	p.33	Off, 5min., 10min., 30min.	
	Child Lock	p.33	On, Off	
	Operation Lock	p.33	On, Off	
	Trigger Out	p.33	On, Off	
	High Altitude Mode	p.33	On, Off	
	Projection	p.34	Front, Front/Ceiling, Rear, Rear/Ceiling	
	Display	p.34	Menu Position	Top-left, Top-center, Top-right, Center-left, Center, Center-right, Bottom-left, Bottom-center, Bottom-right
			Menu Color	Color 1, Color 2
			Messages	On, Off
			Display Background	Black, Blue, Logo
			Startup Screen	On, Off
	Input Signal	p.34	Video Signal	Auto, <u>NTSC</u> *, NTSC4.43, <u>PAL</u> *, M-PAL, N-PAL, PAL60, <u>SECAM</u> **
			Component	Auto, <u>YCbCr</u> *, <u>YPbPr</u> **
D/SCART			D(Auto), D(YCbCr), D(YPbPr), SCART	
Language	p.34	日本語, English, Français, Deutsch, Italiano, Español, Português, 中文, 한국어, Nederlands, Dansk, Polski, Magyar, Český, Norsk, Svenska, Suomi, Русский, Ελληνικά, Türkçe		
Reset	p.35	Yes, No		

Only displayed for composite video/S-Video input  
 Only displayed for component video/Computer input  
 Only displayed for Computer input

Info	Lamp Hours	<ul style="list-style-type: none"> <li>• The message text will be displayed in yellow when it is time to replace the lamp.</li> <li>• Time from 0H to 10H will be displayed as 0H. From 10H onwards, the display will be in units of 1H.</li> </ul>
	Source	
	Input Signal	
	Resolution	
	Scan Mode	
	Refresh Rate ▶▶	
	Sync Info	
	Video Signal	The "Info" menu is only used to display the projector status.
	Deep Color	Display the color depth of HDMI transmission.
	Status	This is information about errors that have occurred on the projector. This value is sometimes referred to when inquiries are made.

Memory	Load Memory	p.35	Memory1 to Memory10
	Save Memory	p.35	Memory1 to Memory10
	Erase Memory	p.35	Memory1 to Memory10
Reset	Reset All	p.35	
	Reset Memory	p.35	
	Reset Lamp Hours	p.35	

## "Image" menu

Displayed for input sources other than computer

### Color Mode \*1

Six different settings can be selected for the Color Mode, to match the images being projected or the projection environment. p.18

### Brightness \*2

Adjust this when the output level of the connected equipment is weak and you feel that images are dark.

### Contrast ▶ \*2

Adjusts the difference between bright and dark areas.  
When the contrast is increased, images with greater modulation are obtained.

### Color Saturation \*2

This adjusts the colour intensity for the images.

### Tint \*2

(Adjustment is only possible when composite video▶▶ and S-Video▶▶ signals in NTSC▶▶ format are being input.)

This adjusts the image tint.

### Sharpness \*2

This adjusts the image sharpness.

Standard

The adjustment results are applied to the entire image.

Advanced

This can be used to adjust a specific region. p.23

### Abs. Color Temp.\*2

This adjusts the overall tints of the images. p.20

### Skin Tone \*2

This adjusts the skin tones of people who appear in the images. p.20

### Advanced

Gamma \*1

This adjusts gamma. You can select a value, or make adjustments while viewing an image or a graph. p.20

RGB \*1

This lets you adjust the offset and gain for each of the R/G/B colour components. p.22

RGBCMY \*1

This lets you adjust the hue and saturation for each of the R/G/B/C/M/Y colour components. p.22

\*1 The setting values are stored separately for each image source and signal type.

\*2 The setting values are stored separately for each image source and colour mode setting.



Only displayed for Computer input  
(does not appear when signals from the [HDMI] input port are being input)

### Brightness Control <sup>\*2</sup>

This lets you set the lamp brightness to one of two settings.

Select "Low" if the images being projected are too bright such as when projecting images in a dark room or onto a small screen. Use of "Low" prolongs the life of the lamp, and reduces the amount of power and noise produced by fan rotation during projection.

### Auto Iris <sup>\*3</sup>

The amount of light is adjusted appropriately depending on images (On)/ or not adjusted (Off). p.23

### Reset

This returns all settings in the "Image" menu to their default settings.

## "Signal" menu

### Aspect <sup>\*1</sup>

Selects the aspect mode. p.18

### Zoom Size <sup>\*1</sup>

This can be set only when "Aspect" is set to "Zoom".

This function enables the image to be reduced in size in the vertical direction so that the top and bottom of images that are hidden from view can be viewed when "Zoom" is set. The larger the adjustment value (reduction ratio) set here, the more the image is compressed and displayed squashed in the vertical direction.

### Zoom Caption Pos. <sup>\*1</sup>

This can be set only when "Aspect" is set to "Zoom".

This function moves the display position of the image in one direction, up or down, to display captions when projecting images with captions.

### Tracking <sup>\*1</sup>

This adjusts the images if vertical stripes appear in the images.

### Sync. <sup>\*1</sup>

This adjusts the images if flickering, fuzziness or interference appear in the images.

- Flickering and fuzziness may also occur when the brightness, contrast and sharpness settings are adjusted.
- Clearer adjustments can be obtained if you adjust the "Tracking" first and then adjust the "Sync".

### Position <sup>\*1</sup>

(Setting is not possible when signals are being input from the [HDMI] input port.)

When part of the image is clipped, move the image display position vertically and horizontally so that the entire image is projected. Press , , and to adjust the position.

### Auto Setup

This sets automatic adjustment to on or off in order to set whether the projector automatically adjusts images to their optimum condition when the input signal is changed. The three automatically adjusted items are "Tracking", "Position" and "Sync."

\*1 The setting values are stored separately for each image source and signal type.

\*2 The setting values are stored separately for each image source and colour mode setting.

\*3 The setting values are stored separately for each colour mode setting.

 Displayed for input sources other than computer

### Progressive<sup>▶▶</sup>\*1

(This can be set only when signals are being input from the [Video] / [S-Video] input port, 525i, 625i signals are being input from the [SCART] input port, or 525i, 625i, 1125i signals are being input from the [Component] / [HDMI] input port.)

**Interlace<sup>▶▶</sup>** (i) signals are converted to progressive (p) signals using a method appropriate for the image.

- Off :This is ideal for using when viewing images with a large amount of movement.
- Video :This is ideal for general video images.
- Film/Auto :By pulling down 3-2/2-2, images (e.g. video films/CG or animations) recorded in 24/30 frames are automatically converted to the optimum progressive signals so that images are reproduced looking natural as originally intended.

### Motion Detection<sup>\*</sup>1

(This can be set only when signals are being input from the [Video] / [S-Video] input port, 525i, 625i signals are being input from the [SCART] input port, or 525i, 625i, 1125i signals are being input from the [Component] / [HDMI] input port.)

Select whether the progressive conversion operation mode is for fast-moving images or for slow-moving images. The smaller the value, the more suitable the mode is for viewing still images. The larger the value, the more suitable the mode is for viewing video images.

### Noise Reduction<sup>\*</sup>1

This reduces flickering of images.

Three modes are available. Select the mode to suit your liking.

Set "Off" when the image source, such as DVD, contains little electrical interference.

### Output Scaling<sup>\*</sup>1

(Setting is not possible when **composite video<sup>▶▶</sup>**, **S-Video<sup>▶▶</sup>**, or computer signals are being input.)

This changes the display area (the part of projected images).

- 100% - 92% :When 100% is set, the top and bottom of the image is sometimes affected by electrical interference depending on the image signal. In such cases, try to adjust the display position ("Position").  p.31
- Auto :Displayed when the signals from **[HDMI<sup>▶▶</sup>]** input port are being input. Signals are automatically projected at 100% or 92% size depending on the input signals. (Not displayed when the equipment's DVI port is connected to the projector's [HDMI] input port.)

### Setup Level<sup>\*</sup>1

(This can be set when **NTSC<sup>▶▶</sup>** signals are being input from the [Video] / [S-Video] input ports, when composite video signals are being input from the [Component] input port, or when signals are being input from the [SCART] input port.)

If using products designed for destinations such as South Korea that have different black level (setup level) settings, use this function to obtain correct images. Check the specifications of the connected equipment when changing this setting.

### EPSON Super White<sup>\*</sup>1

(Setting is only possible when Color Mode is "Natural", "Theatre", "Theatre Black 1", or "Theatre Black 2", and composite video, S-video, component video, or SCART signals are being input.)

If bright white areas of images such as clouds and T-shirts on the beach in summer appear uneven and overexposed, set to "On". When set to "On", the "HDMI Video Range" setting will be ignored.

 Displayed for input sources other than computer

## HDMI Video Range\*<sup>1</sup>

(Setting is possible only when "EPSON Super White" is "Off".)



When the [HDMI▶] input port of the projector is connected to a DVD player, for example, set the video range of the projector to suit the video range setting of the DVD player. The setting at the DVD player can be either Normal or Expand.

## Reset

All the adjustment values on the "Signal" menu, except "Aspect▶", are returned to their default values.

# "Settings" menu

## Direct Power On

When the main power switch is turned on, you can set for projection to start (On) / not start (Off) without pressing  or .



When set to "On" with the main power switch left on, be aware that sudden surges of electricity that may occur when the power comes back on after a power outage may cause the projector to turn on.

## Sleep Mode

The projector is equipped with a power-saving function that causes the power to turn off automatically and the projector to switch to standby if no signal is input to the projector for a continuous length of time. The length of time before the power-saving function operates can be selected from four available settings. If "Off" is selected, the power-saving function will not operate.

If you press  while the projector is in standby mode, projection will start again.



## Child Lock

This locks the power on function of the  button on the projector's control panel, so that a child cannot accidentally turn the projector's power on and look into the projector's lens. When the lock is applied, the power will only turn on if  is pressed down for about 3 seconds.  can be used to turn off the power, and the remote control will continue to operate as normal.

If you change the setting, the new setting will take effect after the power has been turned off and the cool-down period is complete.

Even if "Child Lock" is set to "On", be aware that projection starts merely by turning the main power switch on when "Direct Power On" is set to "On".

## Operation Lock

If this is set to "On", you can't operate the projector's control panel buttons and a  icon appears on the screen when a button is pressed. To cancel, press and hold  on the projector's control panel for about seven seconds or more.

If you change the setting, the new setting will take effect after exiting the configuration menu.

## Trigger Out

This turns the trigger function on and off to determine whether the projector's power on/off status and problems with projector operation are communicated to an external device.

If you change the setting, the new setting will take effect after the power has been turned off and the cool-down▶ period is complete.

## High Altitude Mode

A fan is set at a certain speed of rotation so as to bring down internal temperature.

When using above an altitude of about 1500m, set to "On".

\*1 The setting values are stored separately for each image source and signal type.





## Projection

This should be set in accordance with the method used to set up the projector.

- Front : Select when the projector is set up in front of the screen.
- Front/Ceiling : Select when the projector is set up in front of the screen and suspended from a ceiling.
- Rear : Select when the projector is set up behind the screen.
- Rear/Ceiling : Select when the projector is set up behind the screen and suspended from a ceiling.

## Display

### Menu Position

Press , ,  and  to specify the position for the menus to be displayed.

### Menu Color

Selects the color for the main configuration menu.

- Color 1:Black
- Color 2:Blue

### Messages

This sets whether the following message displays appear (On) or don't appear (Off).

- Image signal, colour mode, aspect and item name when memory settings are retrieved.
- Messages such as when no image signals are being input, when an incompatible signal is input, and when the internal temperature rises.

### Display Background

Displays a menu for selecting the screen status for when using the blank function or when no image signal is input.

### Startup Screen

This sets whether the start-up screen (the image that is projected when projection starts) is displayed (On) or not displayed (Off).

If you change the setting, the new setting will take effect after the power has been turned off and the cool-down period is complete.

## Input Signal

### Video Signal

Sets the signal format in accordance with the video equipment that is connected to the [Video] or [S-Video] input port. If set to "Auto", the video signal format is set automatically.

If there is a lot of interference in the image, or if a problem such as no image being projected occurs even though "Auto" has been selected, select the correct signal format manually.

### Component

Change this setting depending on the type of signal that is being output from the video equipment that is connected to the [Component] input port.

If "Auto" is selected, appropriate signal is automatically set. If colours appear unnatural even though "Auto" is selected, select appropriate signal name in the menu.

### D/SCART

This sets the signal format in accordance with the signals being output from video equipment that is connected to the [SCART] port (in Europe) or [D] port (in Japan).

## Language

This sets the display language for messages and menus.

**Reset**

Adjustment values for the "Settings" menu functions are returned to their default settings, except for the "High Altitude Mode", "Projection", "Component", "D/SCART", and "Language".

**"Memory" menu****Load Memory**

This retrieves settings previously saved using "Save Memory".  p.24  
This cannot be selected when nothing is saved at "Save Memory".

**Save Memory**

This can be used to save "Image" menu settings.  p.24

**Erase Memory**

This is used to erase unwanted saved memory.  p.24

**"Reset" menu****Reset All**

This resets all configuration menu settings to their default settings. "Component", "D/SCART" and "Language" in the "Settings" menu, and the settings of "Memory" menu are not returned to their default even if "Reset All" is executed.

**Reset Memory**

This resets (erases) all settings that have been made using the "Save Memory".

**Reset Lamp Hours**

Clear the cumulative lamp operating time and reset to "0H". Perform this procedure when you replace the lamp.

## Reading the indicators

The projector is provided with the following two indicators which notify you of the operating status of the projector.

The following tables show what the indicators mean and how to remedy the problems that they indicate.

\* If all indicators are switched off, check that the power cable is connected correctly and that the main power switch is on.

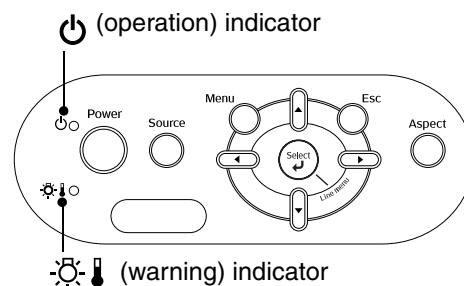

### When the (warning) indicator is lit or flashing **warning/problem**

● : Lit : Flashing

<p>Red</p> <p>(Lit/off for 1 sec)</p>	<p><b>Internal problem / Fan problem / Sensor problem / Cinema filter problem / Auto iris problem</b></p> <div style="border: 1px solid black; padding: 5px;"> <p><b>CAUTION</b> Disconnect the power cable from the electrical outlet. Then contact your local dealer or the nearest address provided in the <i>World-Wide Warranty Terms</i>.</p> <p> Inquiries</p> </div>
---------------------------------------	--

<p>Red</p> <p>(Lit/off for 0.5 sec)</p>	<p><b>Lamp problem / Lamp on error / Lamp cover open error</b></p> <p>Check if the lamp is broken.  p.46</p> <p>Clean the air filter.  p.44</p> <div style="display: flex; justify-content: space-between; margin-top: 20px;"> <div style="width: 30%; border: 1px solid gray; padding: 5px;"> <p>If the lamp is not broken</p> </div> <div style="width: 35%; border: 1px solid gray; padding: 5px;"> <p>Replace the lamp and then turn the power on.</p> </div> <div style="width: 30%; border: 1px solid gray; padding: 5px;"> <p>If the problem is still not solved after the lamp is replaced, stop using the projector and disconnect the power cable from the electrical outlet. Then contact your local dealer or the nearest address provided in the <i>World-Wide Warranty Terms</i>.  Inquiries</p> </div> </div> <div style="margin-top: 20px; border: 1px solid gray; padding: 5px;"> <p>If the lamp is broken</p> <p>Contact your local dealer for further advice.</p> </div>
---	---

Check that the lamp and the lamp cover are securely installed.







When using above an altitude of about 1500 m, make sure you set the "High Altitude Mode" to "On". p.33

<p>Red</p>	<p><b>High internal temperature (overheating)</b></p> <p>The lamp will switch off automatically and projection will stop. Wait for approximately 5 minutes. When the cooling fan stops, turn off the main power switch at the rear of the projector.</p>	<ul style="list-style-type: none"> <li>• If the projector is installed against a wall, leave a space of 20 cm or more between it and the wall.</li> <li>• Clean the air filters if they are blocked.  p.44</li> </ul>	<p>If the problem is not solved when the power is turned back on, stop using the projector, turn off the main power switch, and disconnect the power cable from the electrical outlet. Then contact your local dealer or the nearest address provided in the <i>World-Wide Warranty Terms</i>.  Inquiries</p>
<p>Orange</p>	<p><b>High-speed cooling in progress</b></p> <p>You can continue using the projector, but if the temperature rises again, it will switch off automatically.</p>		

## When the (operation) indicator is lit or flashing **normal**

When the  (warning) indicator is off

●: Lit : Flashing

Orange  ●	<b>Standby condition</b> If you press  , projection will start after a brief interval.
Green  	<b>Warm-up in progress</b> Warm-up time is approximately 30 seconds. Power off operations are ignored while warm-up is in progress.
Green  ●	<b>Projection in progress</b> Normal operation is in progress.
Orange  	<b>Cool-down<sup>▶</sup> in progress</b> Cool-down time is approximately 30 seconds. After cool-down is complete, the projector goes to standby mode. You cannot use the remote control or the projector's control panel during cool-down. If the main power switch at the rear of the projector is turned off before cool-down is complete, wait for the lamp to cool down (normally about one hour is required) before turning the power back on again.

## When the indicators provide no help

If any of the following problems occur and the indicators do not offer a solution, refer to the pages given for each problem.

### Problems relating to images

● **No images appear**  p.38

Projection does not start, the projection area is completely black, the projection area is completely blue, etc.

● **Moving images are not displayed**  p.38

Moving images played on computer are not displayed.

● **The message "Not Supported" is displayed**  p.39

● **The message "No Signal" is displayed**  p.39

● **Images are fuzzy or out of focus**  p.39

● **Interference or distortion appear in images**  p.40

Problems such as interference, distortion or black & white checked patterns appear.

● **Image is truncated (large) or small**  p.40

Only part of the image is displayed.

● **Image colours are not right**  p.41

The whole image appears purplish or greenish, images are black & white, colours appear dull, etc.

(Computer monitors and LCD screens have different colour reproduction performance, so that the colours projected by the projector and the colours appearing on the monitor may not necessarily match, but this is not a sign of a problem.)

● **Images appear dark**  p.41

● **Projection stops automatically**  p.42

### Problems when projection starts













● **Power does not turn on**  p.43

### Problems with the remote control

● **The remote control does not work**  p.43

## Problems relating to images

### ■ No images appear

<b>Have you pressed the [Power] button?</b>	Press  on the remote control or  on the projector's control panel.
<b>Is the main power switch turned off?</b>	Turn on the main power switch at the rear of the projector.
<b>Are all of the indicators switched off?</b>	Disconnect the power cable and then reconnect it.  p.14 Check the circuit breaker to see if power is being supplied.
<b>Is blank mode active?</b>	Press  on the remote control to cancel the blank function.
<b>Is a video signal being input?</b>	Check that the power for the connected equipment is turned on. If the "Messages" menu command has been set to "On", messages relating to the image signals will be displayed.  "Settings" - "Display" - "Messages" p.34
<b>Are the image signal format settings correct?</b>	<p>If a <b>composite video</b>  or <b>S-Video</b>  signal is being input If projection does not occur when the "Video Signal" menu command is set to "Auto", select the signal format that matches the signal source.  "Settings" - "Input Signal" - "Video Signal" p.34</p> <p>If the signal source is connected to the [Component] or [D] input port If projection does not occur when the "Component" in the "Input Signal" menu command is set to "Auto", set the signal format that matches the signal that is being projected from the connected equipment.  "Settings" - "Input Signal" - "Component" p.34</p> <p>If the VCR or DVD equipment is connected using a D SCART adapter Press  to set the signal format to "D/SCART".  p.15 When still no images appear and the DVD equipment is connected, change the setting at the DVD equipment to RGB output.</p>
<b>Have the configuration menu settings been made correctly?</b>	Try resetting all of the current settings.  p.35
<b>Were the projector and computer connected while their power was already turned on?</b>  <div data-bbox="288 1619 604 1697" style="background-color: black; color: white; padding: 5px; width: fit-content;"> <b>When a computer is connected</b> </div>	If the connection is made while the power is already turned on, the function [Fn] key that switches the computer's video signal to external output may not work. Turn the power for the computer that is connected to the projector off and then back on again.

### ■ Moving images are not displayed







<b>Is the computer image signal set to output simultaneously both externally and to the LCD monitor?</b>  <div data-bbox="252 1962 647 2101" style="background-color: black; color: white; padding: 5px;"> <b>Only when projecting images from a laptop computer or computer with a built-in LCD screen</b> </div>	Set the image signal to output only externally.  Computer documentation, under a title such as "External output" or "Connecting an external monitor"
--	--



■ The message "Not Supported" is displayed

<p><b>Are the image signal format settings correct?</b></p>	<p>If a <u>composite video</u> or <u>S-Video</u> is being input If projection does not occur when the "Video Signal" menu command is set to "Auto", select the signal format that matches the signal source. ☞ "Settings" - "Input Signal" - "Video Signal" p.34</p>
<p><b>Does the mode match the frequency and resolution of the image signals?</b></p> <p><b>Only when projecting computer images</b></p>	<p>If the signal source is connected to the [Component] or [D] input port If projection does not occur when the "Component" in the "Input Signal" menu command is set to "Auto", set the signal format that matches the signal that is being projected from the connected equipment. ☞ "Settings" - "Input Signal" - "Component" p.34</p> <p>Use the "Resolution" menu command to check the signals being input, and check the "List of Supported Monitor Displays" to make sure that the signals are compatible. ☞ "Info" - "Resolution" p.29 ☞ "List of Supported Monitor Displays" p.49</p>

■ The message "No Signal" is displayed

<p><b>Are the cables connected correctly?</b></p>	<p>Check that all of the cables required for projection are securely connected. ☞ p.12</p>
<p><b>Has the correct video input port been selected?</b></p>	<p>Press , , ,  or  on the remote control or  on the projector's control panel to change the image source. ☞ p.15</p>
<p><b>Is the power for the connected equipment turned on?</b></p>	<p>Turn the power on for the devices.</p>
<p><b>Are the image signals being output to the projector?</b></p> <p><b>Only when projecting images from a laptop computer or computer with a built-in LCD screen</b></p>	<p>If the image signals are only being output to the computer's LCD monitor, you need to change the output. For some computer models, when the image signals are output externally, they no longer appear on the LCD monitor. ☞ Computer documentation, under a title such as "External output" or "Connecting an external monitor"</p> <p>If the connection is made while the power is already turned on, the function [Fn] key that switches the computer's video signal to external output may not work. Turn the power for the projector and the computer off and then back on again. ☞ p.14</p>

■ Images are fuzzy or out of focus

<p><b>Has the focus been adjusted correctly?</b></p>	<p>Adjust the focus. ☞ p.16</p>
<p><b>Is the lens cover still attached?</b></p>	<p>Remove the lens cover.</p>
<p><b>Is the projector at the correct distance?</b></p>	<p>The recommended distance from the projector to the screen is within 87 to 956 cm (2.8 to 31.4 ft.) for a screen size of 16:9, and 106 to 1170 cm (3.5 to 38.4 ft.) for a screen size of 4:3. Set up the projector so that the projection distance is within this range. ☞ p.10</p>

<p><b>Has condensation formed on the lens?</b></p>	<p>If the projector is suddenly taken from a cold environment to a warm environment or if sudden ambient temperature changes occur, condensation may form on the surface of the lens, and this may cause the images to appear fuzzy. Set the projector up in the room approximately one hour before it is to be used. If condensation forms on the lens, turn the power off and wait for the condensation to disappear.</p>
<p><b>■ Interference or distortion appear in images</b></p>	
<p><b>Are the image signal format settings correct?</b></p>	<p>If a <u>composite video</u> or <u>S-Video</u> is being input If projection does not occur when the "Video Signal" menu command is set to "Auto", select the signal format that matches the signal source. ☞ "Settings" - "Input Signal" - "Video Signal" p.34</p> <hr/> <p>If the signal source is connected to the [Component] or [D] input port If projection does not occur when the "Component" in the "Input Signal" menu command is set to "Auto", set the signal format that matches the signal that is being projected from the connected equipment. ☞ "Settings" - "Input Signal" - "Component" p.34</p>
<p><b>Are the cables connected correctly?</b></p>	<p>Check that all of the cables required for projection are securely connected. ☞ p.12</p>
<p><b>Is an extension cable being used?</b></p>	<p>If an extension cable is used, interference may increase. Try connecting a signal amplifier.</p>
<p><b>Have the "Sync." and "Tracking" settings been adjusted correctly?</b></p> <p style="background-color: black; color: white; padding: 5px; text-align: center;"><b>Only when projecting computer images</b></p>	<p>The projector has an automatic adjustment function that causes the optimum images to be projected. However, for some types of signal, the correct adjustments may not be obtained even after automatic adjustment is carried out. In such cases, use the "Tracking" and "Sync." menu commands to make the adjustments. ☞ "Signal" - "Tracking", "Sync." p.31</p>
<p><b>Has the correct resolution been selected?</b></p> <p style="background-color: black; color: white; padding: 5px; text-align: center;"><b>Only when projecting computer images</b></p>	<p>Set the computer so that the signals that are output are compatible with this projector. ☞ "List of Supported Monitor Displays" p.49 Computer documentation</p>

**■ Image is truncated (large) or small**

<p><b>Has the correct <u>aspect</u> been selected?</b></p>	<p>Press  to select the aspect that corresponds to the input signal. ☞ p.18 If images with subtitles are being projected using "Zoom", use the "Zoom Caption Pos." menu command to adjust the images. ☞ p.31</p>
<p><b>Has the "Position" setting been adjusted correctly?</b></p>	<p>Use the "Position" the menu command to make the adjustment. ☞ "Signal" - "Position" p.31</p>
<p><b>Has the computer been set for dual display?</b></p> <p style="background-color: black; color: white; padding: 5px; text-align: center;"><b>Only when projecting computer images</b></p>	<p>If dual display has been activated in the Display Properties of the computer's Control Panel, the projector will only project about half of the image on the computer screen. To display the whole of the image on the computer screen, turn off the dual display setting. ☞ Computer video driver documentation</p>

<p><b>Has the correct resolution been selected?</b></p> <p><b>Only when projecting computer images</b></p>	<p>Set the computer so that the signals that are output are compatible with this projector.</p> <p>☞ "List of Supported Monitor Displays" p.49 Computer documentation</p>
--	---

■ Image colours are not right



<p><b>Are the image signal format settings correct?</b></p>	<p>If a <u>composite video</u> or <u>S-Video</u> is being input If projection does not occur when the "Video Signal" menu command is set to "Auto", select the signal format that matches the signal source.</p> <p>☞ "Settings" - "Input Signal" - "Video Signal" p.34</p> <hr/> <p>If the signal source is connected to the [Component] or [D] input port If projection does not occur when the "Component" in the "Input Signal" menu command is set to "Auto", set the signal format that matches the signal that is being projected from the connected equipment. ☞ "Settings" - "Input Signal" - "Component" p.34</p>
<p><b>Are the cables connected correctly?</b></p>	<p>Check that all of the cables required for projection are securely connected. ☞ p.12</p>
<p><b>Has the image contrast been adjusted correctly?</b></p>	<p>Use the "Contrast" menu command to adjust the color.</p> <p>☞ "Image" - "Contrast" p.30</p>
<p><b>Has color been adjusted appropriately?</b></p>	<p>Use the "Advanced" menu command to adjust the colour.</p> <p>☞ "Image" - "Advanced" p.30</p>
<p><b>Have the colour intensity and tint been adjusted correctly?</b></p> <p><b>Only when projecting images from a video source</b></p>	<p>Use the "Color Saturation" and "Tint" menu commands to adjust the colour and tint.</p> <p>☞ "Image" - "Color Saturation", "Tint" p.30</p>

■ Images appear dark

<p><b>Has the image brightness been adjusted correctly?</b></p>	<p>Use the "Brightness" menu commands to make the adjustments.</p> <p>☞ "Image" - "Brightness" p.30</p>
<p><b>Has the image contrast been adjusted correctly?</b></p>	<p>Use the "Contrast" menu command to adjust the color.</p> <p>☞ "Image" - "Contrast" p.30</p>
<p><b>Is the lamp due for replacement?</b></p>	<p>When the lamp is nearly due for replacement, the images will become darker and the colour quality will become poorer. When this happens, the lamp should be replaced with a new one. ☞ p.46</p>

■ **Projection stops automatically**









---

<p><b>Is sleep mode active?</b></p>	<p>When "Sleep Mode" has been set to On, the lamp turns off automatically if no signal is input for about 30 minutes, and the projector switches to standby mode. Press the  button on the remote control or the  button on the projector's control panel to turn the projector's power back on. To cancel the sleep mode setting, change "Sleep Mode" menu command to "Off".  "Settings" - "Sleep Mode" p.33</p>
-------------------------------------	--

---



## Problems when projection starts

### ■ Power does not turn on

<b>Have you pressed the [Power] button?</b>	Press  on the remote control or  on the projector's control panel.
<b>Is "Child Lock" set to "On"?</b>	If the "Child Lock" menu command is set to "On", press  on the projector's control panel for about 3 seconds or press  on the remote control to turn the power on.  "Settings" - "Child Lock" p.33
<b>Is "Operation Lock" set to "On"?</b>	If the "Operation Lock" menu command is set to "On", all buttons on the projector's control panel are disabled. Press  on the remote control.  "Settings" - "Operation Lock" p.33
<b>Are all of the indicators switched off?</b>	Disconnect the power cable and then reconnect it.  p.14 Check the circuit breaker to see if power is being supplied.
<b>Do the indicators turn off and on when the power cable is touched?</b>	Turn the power off, disconnect the power cable and then reconnect it. If this does not solve the problem, there may be a problem with the power cable. Then contact your local dealer or the nearest address provided in the <i>World-Wide Warranty Terms</i> .  Inquiries

## Problems with the remote control

### ■ The remote control does not work

<b>Is the remote control light-emitting area facing towards the remote control light-receiving area when it is operated?</b>	Face the remote control towards the remote control light-receiving area. The operating angle for the remote control is approximately $\pm 30^\circ$ horizontally and approximately $\pm 30^\circ$ vertically.  p.13
<b>Is the remote control too far from the projector?</b>	The operating range for the remote control is approximately 10m.  p.13
<b>Is direct sunlight or strong light from fluorescent lamps shining onto the remote control light-receiving area?</b>	Set the projector up in a location where strong light will not shine onto the remote control light-receiving area.
<b>Are the batteries dead, or have the batteries been inserted correctly?</b>	Insert new batteries, while making sure that they face correctly.  p.13

This section describes maintenance tasks such as cleaning the projector and replacing consumable parts.

## Cleaning

You should clean the projector if it becomes dirty or if the quality of projected images starts to deteriorate.

**CAUTION** Be sure to read the separate *Safety Instructions/World-Wide Warranty Terms* booklet for details on safe handling of the projector during cleaning.

### Cleaning the air filter

If the air filter becomes blocked with dust and the message "The projector is overheating. Make sure nothing is blocking the air vent, and clean or replace the air filter" is displayed, clean the air filter.

Turn the projector upside-down and use a vacuum cleaner to clean the air filter

**CAUTION** If the air filter becomes clogged with dust, it can result in overheating which may cause operating problems or reduce the operating life of the optical parts. It is recommended that you clean the air filter about once every three month. If using the projector in a dusty location, the air filter should be cleaned more often.

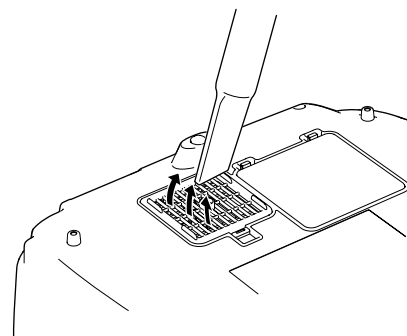

### Cleaning the projector case

Clean the projector case by wiping it gently with a soft cloth. If the projector is particularly dirty, moisten the cloth with water containing a small amount of neutral detergent, and then firmly wring the cloth dry before using it to wipe the projector case. Then wipe the case again with a soft, dry cloth.

**CAUTION** Do not use volatile substances such as wax, alcohol or thinner to clean the projector case. These can cause the case to warp and make the coating finish peel off.

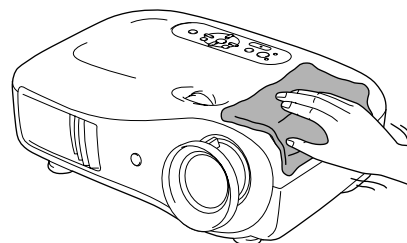

### Cleaning the lens

To clean the lens it is preferable to use an air blower purchased for the purpose. But alternatively you can wipe it gently clean with a spectacle-cleaning cloth.

**CAUTION** Do not rub the lens with harsh materials or subject the lens to shocks, as it can easily become damaged.

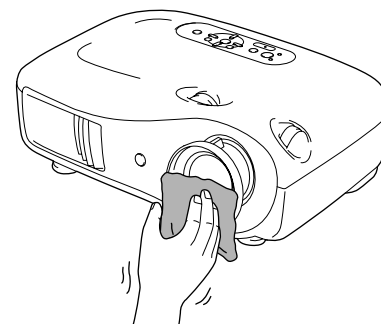

## Consumable replacement periods

### Air filter replacement period

- If the air filter has been broken or the "Replace" message is displayed even though the air filter has been cleaned.

Replace with an optional air filter.

 Replacing the air filter p.46

### Lamp replacement period

- The message "Replace the lamp." appears on the screen when projection starts.

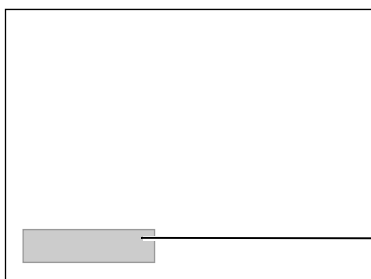

A message will be displayed.

- The projected images get darker or start to deteriorate.



TIP

- The replacement warning message is set to appear after a minimum of about 1600 hours of lamp use in order to maintain the initial brightness and quality of the projected images. The time taken for the message to appear will vary depending on usage conditions such as Color Mode settings. If you continue to use the lamp after this period, the possibility of the lamp breaking becomes greater. When the lamp replacement message appears, replace the lamp with a new one as soon as possible, even if it is still working.
- Depending on the characteristics of the lamp and on the way it has been used, the lamp may become darker or stop working before the lamp warning message appears. You should always have a spare lamp ready in case it is needed.
- Contact your dealer for a spare lamp.

## Replacing consumables

### Replacing the air filter



TIP

Dispose of used air filters properly in accordance with your local regulations.  
Air Filter:  
Polypropylene

**1** Press **Off** or **Power** to turn the power off, wait until the projector cools down, and then turn off the main power switch.

**2** Remove the air filter cover.

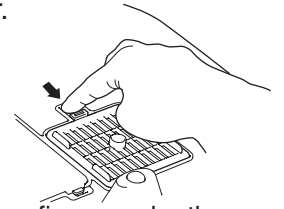

Put your finger under the latch and pull it upward.

### Replacing the lamp

#### CAUTION

If the lamp stops working and needs to be replaced, there is the danger that the lamp may already be broken. If replacing the lamp of a projector which has been installed to the ceiling, you should always assume that the lamp is broken and handle it with extreme care during removal. Furthermore, you should stand to the side of the projector, not underneath it.

**1** Press **Off** or **Power** to turn the power off, wait until the projector cools down, and then turn off the main power switch.

\* Wait until the lamp cools down (takes approximately 1 hour).

**2** Remove the lamp cover.

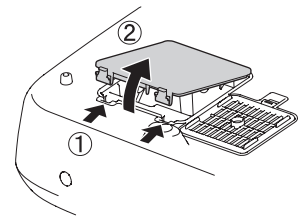

**6** Securely tighten the lamp fixing screws.

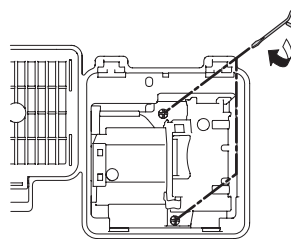

**7** Install the lamp cover.

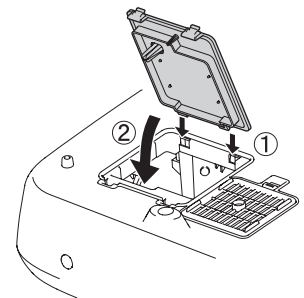

### Resetting the lamp operating time

The lamp operating time must always be reset after the lamp has been replaced with a new one.

The projector has a built-in counter which keeps track of the lamp operating time. When the cumulative operating time reaches a certain point, it causes the replacement warning message to be displayed.

**1** Press **On** to turn on the power.

**2** Press **Menu** to display the configuration menu.

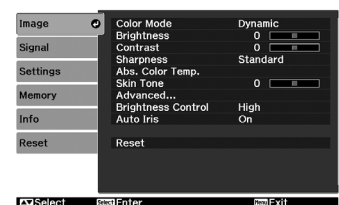



**3** Remove the old air filter.

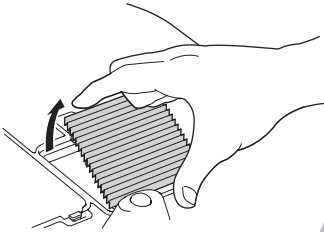

**4** Insert the new air filter.

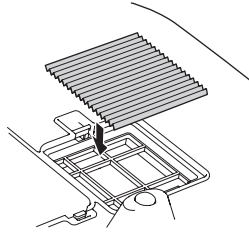

**5** Install the air filter cover.

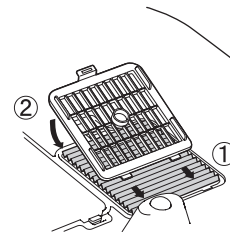

**3** Loosen the lamp fixing screws.

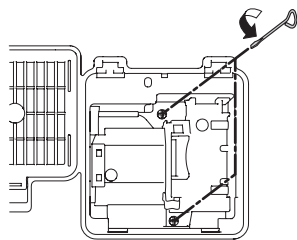

**4** Remove the old lamp.

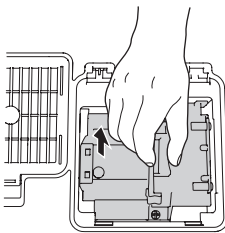

Pull out straight.

**5** Insert the new lamp.

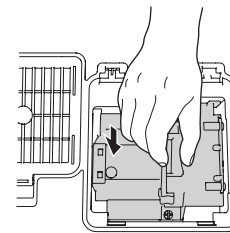

Make sure that it faces the correct way.

**CAUTION**

- Install the lamp and the lamp cover securely. The lamp will not turn on if the lamp or the lamp cover is not installed correctly.
- This product includes a lamp component that contains mercury (Hg). Please consult your local regulations regarding disposal or recycling. Do not dispose of it with normal waste.

**3** Select "Reset Lamp Hours" from the "Reset" menu.

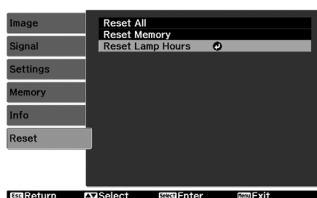

**4** Select "Yes" and then press .

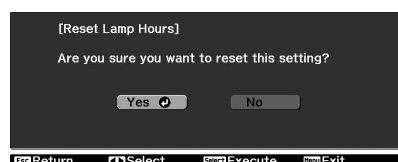

 Return  Select  Execute  Exit

# Optional Accessories / Consumables

The following optional accessories / consumables are available for purchase if required. This list of optional accessories and consumables is current as of December, 2006. Details of accessories are subject to change without notice.

Varies depending on country of purchase.

## ■ Optional Accessories

50" Portable Screen	ELPSC06
---------------------	---------

A compact screen which can be carried easily.  
(Aspect▶▶ 4:3)

60" Portable Screen	ELPSC07
80" Portable Screen	ELPSC08
100" Portable Screen	ELPSC10

A portable roll-type screen. (Aspect 4:3)

VGA-HD15 PC Cable (1.8 m)	ELPKC02
VGA-HD15 PC Cable (3 m)	ELPKC09
VGA-HD15 PC Cable (20 m)	ELPKC10

(For mini D-Sub 15-pin/mini D-Sub 15-pin)  
Use to connect the projector to a computer.

Ceiling Mount*	ELPMB20
----------------	---------

(with ceiling plate)  
Use when installing the projector to a ceiling.

Celling Pipe 600 (600 mm/white)*	ELPFP07
----------------------------------	---------

Use when installing the projector to a high ceiling or a ceiling with veneer panels.

\* A special method of installation is required in order to suspend the projector from the ceiling. Please contact the place of purchase if you would like to use this installation method.

## ■ Consumables

Lamp Unit	ELPLP39
-----------	---------

(1 spare lamp, 1 spare screwdriver)  
Use as a replacement for spent lamps.

Air Filter Set	ELPAF09
----------------	---------

(1 air filter)  
Use as a replacement for old air filters.

# List of Supported Monitor Displays

Depending on the setting, the output screen resolution will change slightly.

## Component Video

4:3 16:9 : Aspect Units: Dots

Signal	Resolution	Aspect mode			
		Normal	Full	Zoom	Wide
SDTV (525i, 60Hz)	720×480 720×360 *	1440×1080 4:3	1920×1080 16:9	1920×1080 16:9	1920×1080 16:9
SDTV(625i, 50Hz)	720×576 720×432 *	1440×1080 4:3	1920×1080 16:9	1920×1080 16:9	1920×1080 16:9
SDTV(525p)	720×480 720×360 *	1440×1080 4:3	1920×1080 16:9	1920×1080 16:9	1920×1080 16:9
SDTV(625p)	720×576 720×432 *	1440×1080 4:3	1920×1080 16:9	1920×1080 16:9	1920×1080 16:9
HDTV (750p) 16:9	1280×720	1920×1080 16:9	-	-	-
HDTV(1125i) 16:9	1920×1080	1920×1080 16:9	-	-	-
HDTV(1125p) 16:9	1920×1080	1920×1080 16:9	-	-	-

\*Letterbox signal

## Composite Video/S-Video

4:3 16:9 : Aspect Units: Dots

Signal	Resolution	Aspect mode			
		Normal	Full	Zoom	Wide
TV(NTSC)	720×480 720×360 *	1440×1080 4:3	1920×1080 16:9	1920×1080 16:9	1920×1080 16:9
TV(PAL, SECAM)	720×576 720×432 *	1440×1080 4:3	1920×1080 16:9	1920×1080 16:9	1920×1080 16:9

\*Letterbox signal

## Computer image (analog RGB)

Units: Dots

Signal	Resolution	Aspect mode			
		Normal	Full	Zoom	Wide
<u>VGA</u> 60	640×480 640×360 *2	1440×1080	1920×1080	1920×1080	1920×1080
VESA72/75/85, iMac *1	640×480 640×360 *2	1440×1080	1920×1080	1920×1080	1920×1080
<u>SVGA</u> 56/60/72/ 75/85, iMac *1	800×600 800×450 *2	1440×1080	1920×1080	1920×1080	1920×1080
<u>XGA</u> 60/70/75/ 85, iMac *1	1024×768 1024×576 *2	1440×1080	1920×1080	1920×1080	1920×1080
WXGA60-1	1280×768	1800×1080	1920×1080	1920×1080	-
WXGA60-2	1360×768	1912×1080	1920×1080	1920×1080	-
<u>SXGA</u> 60	1280×1024	1350×1080	1920×1080	1920×1080	-
	1280×960	1440×1080			1920×1080
MAC13"	640×480	1440×1080	1920×1080	1920×1080	1920×1080
MAC16"	832×624	1440×1080	1920×1080	1920×1080	1920×1080
MAC19"	1024×768	1440×1080	1920×1080	1920×1080	1920×1080

\*1 Connection is not possible if the equipment does not have a VGA output port.

\*2 Letterbox signal

It may be possible to project signals which are not listed in the above table. However, some functions may be limited in that case.

## Input signal from the [HDMI] input port

Units: Dots

Signal	Resolution	Aspect mode			
		Normal	Full	Zoom	Wide
<u>VGA</u> 60	640×480 640×360 *2	1440×1080	1920×1080	1920×1080	1920×1080
<u>SDTV</u> (525i, 60Hz)	720×480 720×360 *2	1440×1080	1920×1080	1920×1080	1920×1080
SDTV(525p)	720×480 720×360 *2	1440×1080	1920×1080	1920×1080	1920×1080
SDTV(625i, 50Hz)	720×576 720×432 *2	1440×1080	1920×1080	1920×1080	1920×1080
SDTV(625p)	720×576 720×432 *2	1440×1080	1920×1080	1920×1080	1920×1080
<u>HDTV</u> (750p)	1280×720	1920×1080	-	-	-
HDTV(1125i)	1920×1080	1920×1080	-	-	-
HDTV(1125p)	1920×1080	1920×1080	-	-	-

\*1 Connection is not possible if the equipment does not have a VGA output port.

\*2 Letterbox signal

■ are input signals through the [SCART] input port.

It may be possible to project signals which are not listed in the above table. However, some functions may be limited in that case.

# Specifications

<b>Product name</b>	Home Projector EMP-TW1000		
<b>Dimensions</b>	406 (W) × 124 (H) × 310 (D) mm (not including feet)		
<b>Panel size</b>	0.74 inch wide		
<b>Display method</b>	Polysilicon TFT active matrix		
<b>Resolution</b>	2,073,600 pixels (1920 (W) × 1080 (H) dots) × 3		
<b>Scanning frequencies</b>	Analogue	Pixel clock : 13.5 to 150 MHz	
		Horizontal : 15 to 80 kHz	
		Vertical : 50 to 85 Hz	
	Digital	Pixel clock : 13.5 to 150 MHz	
		Horizontal : 15 to 80 kHz	
		Vertical : 50 to 85 Hz	
<b>Focus adjustment</b>	Manual		
<b>Zoom adjustment</b>	Manual (approx. 1 : 2.1)		
<b>Lens shift</b>	Manual (Maximums: Approx. 96% vertically, 47% horizontally)		
<b>Lamp (light source)</b>	UHE lamp, 170 W, Model No.: ELPLP39		
<b>Power supply</b>	100 to 240V AC 50/60Hz 2.7 to 1.2A Power Consumption Operating: 245W(100 to 120V area), 240W(220 to 240V area) Standby: 4.0W(100 to 120V area), 5.0W(220 to 240V area)		
<b>Operating altitude</b>	0 to 2286m (0 to 7500ft.)		
<b>Operating temperature</b>	+5 to +35°C (No condensation)		
<b>Storage temperature</b>	-10 to +60°C (No condensation)		
<b>Weight</b>	Approx. 5.6kg		
<b>Ports</b>	SCART input	1	D + RCA pin jack
	Component input	1	RCA pin jack × 3
	PC input	1	Mini D-sub 15-pin (female) blue
	<b>HDMI</b> ™ input	1	HDMI
	Video input	1	RCA pin jack
	S-Video input	1	Mini DIN 4-pin
	RS-232C	1	D-sub 9-pin (male)
	Trigger out	1	3.5 mm mini jack

Other detailed spec, please access your location (country/area) from Epson homepage, <http://www.epson.com>



Pixelworks DNX™ ICs are used in this Projector.

■ Angle of tilt

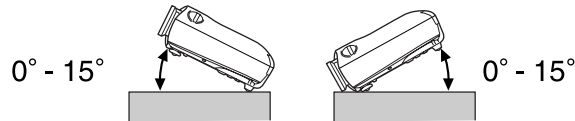

If you set the projector higher than 15°, it could damage the projector and cause an accident.

■ RS-232C cable layout

- Connector shape : D-Sub 9-pin (male)
- Projector input connector : RS-232C

<At projector>

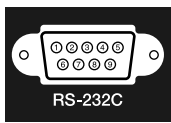

<At computer>

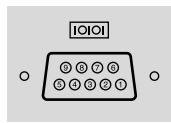

<At projector> (PC serial cable) <At computer>

GND	5	—————	5	GND
RD	2	←————	3	TD
TD	3	————→	2	RD
DTR	4	————→	6	DSR
DSR	6	←————	4	DTR

Signal	Function
GND	Signal wire earth
TD	Transmit data
RD	Receive data
DSR	Data set ready
DTR	Data terminal ready

Safety

USA  
UL60950-1

Canada  
CSA C22.2 No.60950-1

EU  
The Low Voltage Directive  
(73/23/EEC)  
IEC/EN60950-1

EMC

USA  
FCC Part 15B Class B (DoC)

Canada  
ICES-003 Class B

EU  
The EMC Directive  
(89/336/EEC)  
EN55022 Class B  
EN55024  
IEC/EN61000-3-2  
IEC/EN61000-3-3

Australia/New Zealand  
AS/NZS CISPR 22:2002 Class B

**DECLARATION of CONFORMITY**

According to 47CFR, Part 2 and 15  
 Class B Personal Computers and Peripherals; and/or  
 CPU Boards and Power Supplies used with Class B  
 Personal Computers

We : EPSON AMERICA, INC.  
 Located at : 3840 Kilroy Airport Way  
 MS: 313  
 Long Beach, CA 90806  
 Tel : 562-290-5254

Declare under sole responsibility that the product identified herein, complies with 47CFR Part 2 and 15 of the FCC rules as a Class B digital device. Each product marketed, is identical to the representative unit tested and found to be compliant with the standards. Records maintained continue to reflect the equipment being produced can be expected to be within the variation accepted, due to quantity production and testing on a statistical basis as required by 47CFR 2.909. Operation is subject to the following two conditions : (1) this device may not cause harmful interference, and (2) this device must accept any interference received, including interference that may cause undesired operation.

Trade Name : EPSON  
 Type of Product : Projector  
 Model : EMP-TW1000

**FCC Compliance Statement  
 For United States Users**

This equipment has been tested and found to comply with the limits for a Class B digital device, pursuant to Part 15 of the FCC Rules. These limits are designed to provide reasonable protection against harmful interference in a residential installation. This equipment generates, uses, and can radiate radio frequency energy and, if not installed and used in accordance with the instructions, may cause harmful interference to radio or television reception. However, there is no guarantee that interference will not occur in a particular installation. If this equipment does cause interference to radio and television reception, which can be determined by turning the equipment off and on, the user is encouraged to try to correct the interference by one or more of the following measures.

- Reorient or relocate the receiving antenna.
- Increase the separation between the equipment and receiver.
- Connect the equipment into an outlet on a circuit different from that to which the receiver is connected.
- Consult the dealer or an experienced radio/TV technician for help.

**WARNING**

The connection of a non-shielded equipment interface cable to this equipment will invalidate the FCC Certification or Declaration of this device and may cause interference levels which exceed the limits established by the FCC for this equipment. It is the responsibility of the user to obtain and use a shielded equipment interface cable with this device. If this equipment has more than one interface connector, do not leave cables connected to unused interfaces. Changes or modifications not expressly approved by the manufacturer could void the user's authority to operate the equipment.

Following is an explanation of some of the terms used in this guide which may be unfamiliar or which were not explained in the manual itself. Further information can be obtained by referring to other commercially-available publications.

## Aspect

The ratio between an image's length and its height. **HDTV** images have an aspect of 16:9 and appear elongated. The aspect for standard images is 4:3.

## Component video

Video signals which have the video brightness signals and color signals separated, in order to provide better image quality.

In high-definition TV (HDTV), it refers to images which consist of three independent signals: Y (luminance signal), and Pb and Pr (color difference signals).

## Composite video

Video signals which have the video brightness signals and color signals mixed together. The type of signals commonly used by household video equipment (**NTSC**, **PAL** and **SECAM** formats).

Video signals which consist of a carrier signal Y (luminance signal) within the color bar signal, and a chroma or color signal (CbCr).

## Contrast

The relative brightness of the light and dark areas of an image can be increased or decreased in order to make text and graphics stand out more clearly, or to make them appear softer.

## Cool-down

This is the process by which the projector's lamp is cooled down after it has become hot through use. It is carried out automatically when the [Power] button on either the remote control or the projector's control panel has been pressed to turn off the projector. Do not turn off the main power switch while cool-down is in progress, otherwise the cool-down process will not work properly. If the cool-down period is not allowed to finish normally, the projector's lamp and internal components will remain at high temperatures, and this may shorten the useful life of the lamp or cause problems with the operation of the projector. The projector takes about 30 seconds to cool down. The actual time will vary depending on the external air temperature.

## HDMI

An abbreviation for High Definition Multimedia Interface, and refers to a standard for digital transmission of high-definition images and multi-channel audio signals.

HDMI is a standard that is targeted towards household digital equipment and computers that allows digital signals to be transmitted in their original high quality without compression, and it also includes a digital signal encryption function.

## HDTV

An abbreviation for High-Definition Television. It refers to high-definition systems which satisfy the following conditions.

- Vertical resolution of 750p or 1125i or greater (p = **progressive**, i = **interlaced**)
- Screen **aspect** of 16:9
- Dolby **Digital** audio reception and playback (or output)

## Interlace

A method of image scanning whereby the signal bandwidth used is approximately half that required for sequential scanning when images with the same still picture resolution are broadcast.

## NTSC

An abbreviation for National Television Standards Committee, and a format for ground-based analogue colour television broadcasts. This format is used in Japan, North America and Central and South America.

## PAL

An abbreviation for Phase Alternation by Line, and a format for ground-based analogue colour television broadcasts. This format is used in Western European countries except France, and also in Asian countries such as China and in Africa.

## Progressive

A method of image scanning whereby the image data from a single image is scanned sequentially from top to bottom to create a single image.

## Refresh rate

The light-emitting element of a display maintains the same luminosity and color for an extremely short time. Because of this, the image must be scanned many times per second in order to refresh the light emitting element. The number of refresh operations per second is called the "refresh rate", and is expressed in hertz (Hz).

## S-Video

A video signal which has the luminance component and color component separated in order to provide better image quality.

It refers to images which consist of two independent signals: Y (luminance signal), and C (color signal).

## SDTV

An abbreviation for Standard Definition Television. It refers to standard television systems which do not satisfy the conditions for HDTV.

## SECAM

An abbreviation for Sequential Couleur A Memoire, and a format for ground-based analogue colour television broadcasts. This format is used in France, Eastern Europe and the former Soviet Union, the Middle East and Africa.



**Security lock**

A device consisting of a protector case with a hole in it that a commercially-available theft-prevention cable can be passed through in order to secure the device to a table or pillar. This projector is compatible with the Microsaver Security System manufactured by Kensington.

**SVGA**

A type of image signal with a resolution of 800 (horizontal) x 600 (vertical) dots which is used by IBM PC/ AT-compatible computers.

**SXGA**

A type of image signal with a resolution of 1280 (horizontal) x 1024 (vertical) dots which is used by IBM PC/ AT-compatible computers.

**Sync. (Synchronization)**

The signals output from computers have a specific frequency. If the projector frequency does not match this frequency, the resulting images will not be of a good quality. The process of matching the phases of these signals (the relative position of the crests and troughs in the signal) is called "synchronization". If the signals are not synchronized, problems such as flickering, blurriness and horizontal interference can occur.

**Tracking**

The signals output from computers have a specific frequency. If the projector frequency does not match this frequency, the resulting images will not be of a good quality. The process of matching the frequency of these signals (the number of crests in the signal) is called "tracking". If tracking is not carried out correctly, wide vertical stripes will appear in the projected images.

**VGA**

A type of image signal with a resolution of 640 (horizontal) x 480 (vertical) dots which is used by IBM PC/ AT-compatible computers.

**XGA**

A type of image signal with a resolution of 1,024 (horizontal) x 768 (vertical) dots which is used by IBM PC/ AT-compatible computers.

**YCbCr**

The carrier signal which is contained in the color bar signal used in modern TV transmissions. The name comes from the Y (luminance) signal and the CbCr (chroma [color]) signals.

**YPbPr**

The carrier signal which is contained in the color bar signal used in high-definition TV (**HDTV**) transmissions. The name comes from the Y (luminance) signal and the PbPr (color difference) signals.

## A

Absolute Color Temperature .....	20,28,30
Advanced .....	28,30
Air filter .....	8
Aspect .....	7,18,28,31,49
Auto .....	18
Auto Iris .....	23,28,31
Auto Setup .....	24,28,31

## B

Battery replacement period (Remote control) .....	13
Brightness .....	28,30
Brightness Control .....	28,31

## C

Ceiling.....	11,29,34
Child Lock .....	29,33
Cinema Filter .....	21
Cleaning the air filter .....	44
Cleaning the lens.....	44
Cleaning the projector case.....	44
Color Mode.....	7,18,28,30
Color Saturation.....	28,30
[Component] input port .....	8,12,15,51
Component Video .....	12,49
Composite Video.....	12,49
Configuration menu .....	26
Connecting to a computer.....	12
Connecting to a video source.....	12
Consumables.....	48
Contrast.....	7,28,30
Control panel.....	6
Cool-down.....	15,36
Correcting projector tilt .....	6,17

## D

Direct Power On .....	29,33
Display .....	29,34
Display Background .....	27,34

## E

Epson Cinema Filter .....	21
EPSON Super White.....	28,32
Erase Memory.....	29,35

## F

Focus adjustment .....	6,16
Front adjustable foot .....	6,17
Full.....	18
Full Menu.....	26

## G

Gain.....	22,28
Gamma.....	20,28,30

## H

HDTV .....	49
[HDMI] input port .....	8,12,50,51
HDMI-Video Range.....	28,33
High Altitude Mode .....	29,33
Hue and saturation .....	22

## I

Image size .....	10
"Image" menu .....	28,30
Indicators .....	6,36
"Info" menu .....	29
Input Signal.....	29,34

## L

Lamp cover .....	8,46
Lamp Hours .....	29
Language.....	29,34
Lens cover.....	6,14
Lens shift .....	6,16
Line menu .....	26
Load Memory .....	24,29,35

## M

Main power switch.....	8,14,15
Memory.....	7,24
"Memory" Menu .....	29,35
Menu Color.....	29,34
Menu Position.....	29,34
Menus .....	26
Messages.....	29,34
Motion Detection .....	28,32

## N

Noise Reduction.....	28,32
Normal .....	19

## O

Offset .....	22,28
Operation indicator .....	6,36
Operation Lock .....	29,33
Optional accessories .....	48
Output Scaling .....	28,32
Overheating.....	36

## P

[PC] input port .....	8,12,51
Port.....	8,12,51
Position .....	28,31
Power cable.....	14
Power inlet .....	8,14
Progressive.....	28,32
Projection.....	11,29,34
Projection distance.....	10
Projection image position adjustment.....	16
Projection methods .....	11

- R**
- Refresh Rate ..... 29
  - Remote control ..... 7,13
  - Replacing the air filter ..... 46
  - Replacing the battery ..... 13
  - Replacing the lamp ..... 46
  - Reset ..... 28,29,31,33,35
  - Reset All ..... 29,35
  - "Reset" menu ..... 29,35
  - Reset Lamp Hours ..... 29,35,46
  - Reset Memory ..... 29,35
  - Resolution ..... 29,49
  - RGB ..... 22,28,30
  - RGBCMY ..... 22,28,30
  - [RS-232C] port ..... 8,51,52
- S**
- Save Memory ..... 24,29,35
  - SCART ..... 1,29,34
  - [SCART] input port ..... 8,12,51
  - Screen size ..... 10
  - SDTV ..... 49
  - Selecting the image source ..... 6,7,15
  - Setup Level ..... 28,32
  - "Settings" menu ..... 29,33
  - Sharpness ..... 28,30
  - Sharpness (Advanced) ..... 23,28,30
  - "Signal" menu ..... 28,31
  - Skin Tone ..... 7,20,28,30
  - Sleep Mode ..... 29,33
  - Source ..... 29
  - Specifications ..... 51
  - Startup Screen ..... 29,34
  - Sub-menu ..... 26
  - Supported Monitor Displays ..... 49
  - S-Video ..... 12,49
  - [S-Video] input port ..... 8,12,51
  - Sync Info ..... 29
  - Sync ..... 28,31
- T**
- Test Pattern ..... 7,17
  - Tint ..... 28,30
  - Top menu ..... 26
  - Tracking ..... 28,31
  - Trigger Out ..... 29,33
  - [Trigger out] port ..... 8,51
  - Turning off ..... 15
- U**
- Using the configuration menus ..... 26
- V**
- [Video] input port ..... 8,12,51
  - Video Signal ..... 29,34
- W**
- Warning indicator ..... 6,36
  - Wide ..... 19
- Y**
- YCbCr ..... 12,29
  - YPbPr ..... 12,29
- Z**
- Zoom ..... 19
  - Zoom adjustment ..... 6,16
  - Zoom Caption Pos. .... 19,28,31
  - Zoom Size ..... 28,31

# MEMO

# MEMO

# MEMO

All rights reserved. No part of this publication may be reproduced, stored in a retrieval system, or transmitted in any form or by any means, electronic, mechanical, photocopying, recording, or otherwise, without the prior written permission of Seiko Epson Corporation. No patent liability is assumed with respect to the use of the information contained herein. Neither is any liability assumed for damages resulting from the use of the information contained herein.

Neither Seiko Epson Corporation nor its affiliates shall be liable to the purchaser of this product or third parties for damages, losses, costs, or expenses incurred by purchaser or third parties as a result of: accident, misuse, or abuse of this product or unauthorised modifications, repairs, or alterations to this product, or (excluding the U.S.) failure to strictly comply with Seiko Epson Corporation's operating and maintenance instructions.

Seiko Epson Corporation shall not be liable against any damages or problems arising from the use of any options or any consumable products other than those designated as Original Epson Products or Epson Approved Products by Seiko Epson Corporation.

The contents of this guide may be changed or updated without further notice.

Illustrations and screens used in this publication may differ from actual illustrations and screens.

**General Notice:**

Macintosh, Mac, and iMac are registered trademarks of Apple Computer, Inc.

IBM is a registered trademark of International Business Machines Corporation.

Windows, WindowsNT and VGA are trademarks or registered trademarks of Microsoft Corporation in the United States.

Dolby is a trademark of Dolby Laboratories.

HDMI and High-Definition Multimedia Interface are trademarks or registered trademarks of HDMI Licensing LLC.

Pixelworks and DNX are trademarks of Pixelworks, Inc.

Other product names used herein are also for identification purposes only and may be trademarks of their respective owners. Epson disclaims any and all rights in those marks.

# EPSON

E



Printed on 100% recycled paper.



Printed in China  
410812300  
06.XX-XA(G04)