

myprojectorlamps.com

**The most trusted, dependable name
in projector lamp sales.**



<http://www.myprojectorlamps.com>



<http://www.myprojectorlamps.ca>



<http://www.myprojectorlamps.eu>

The following projector manual has not been modified or altered in any way.

EPSON®

User's Guide





MM PROJECTOR
ULTI EDIA

EMP-821

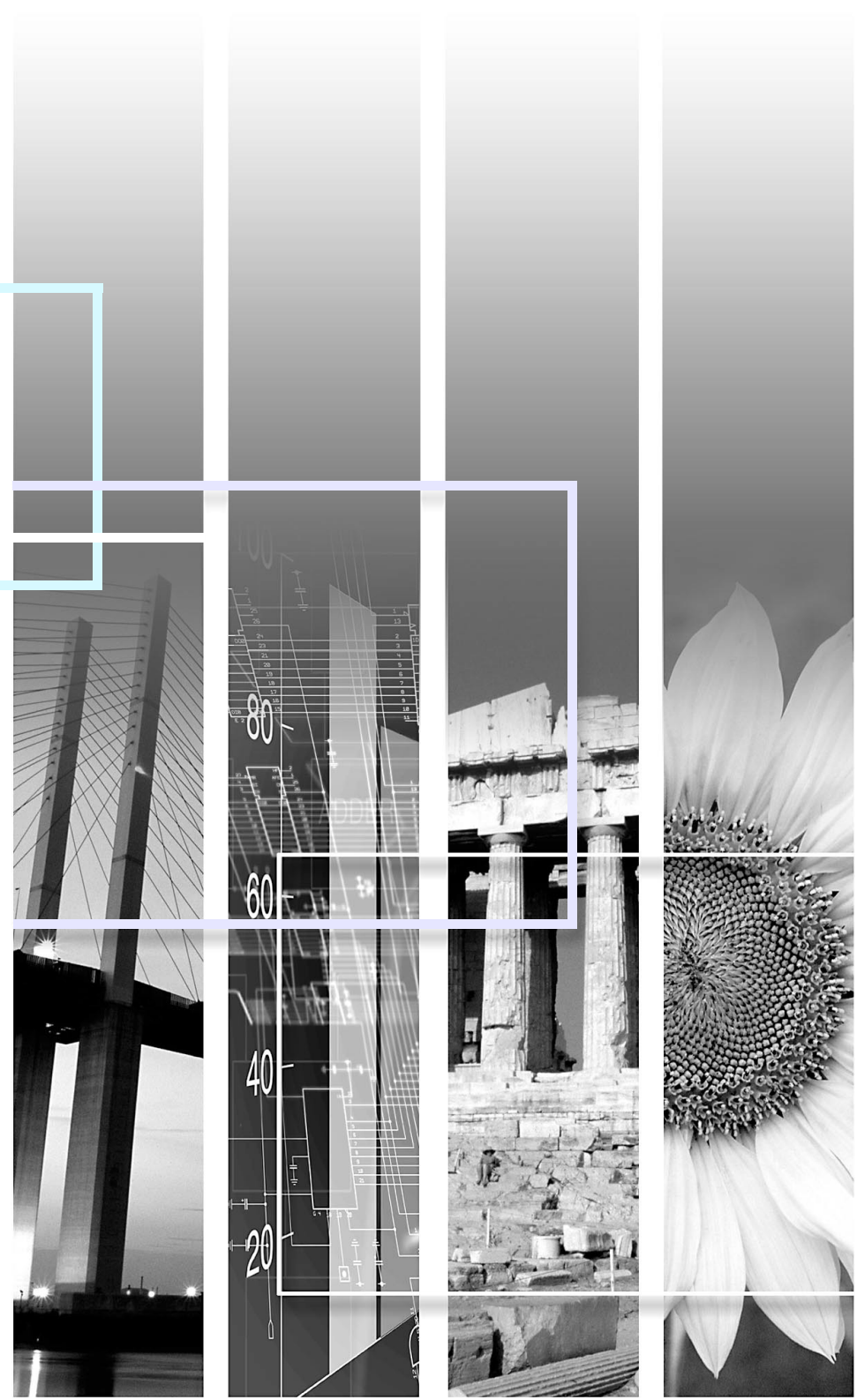
EMP-81

EMP-61



 CAUTION	Indicates procedures which may result in damage or injury if sufficient care is not taken.
 TIP	Indicates additional information and points which may be useful to know regarding a topic.
	Indicates a page where useful information regarding a topic can be found. Click on the page number to display that page.
	Indicates that an explanation of the underlined word or words in front of this symbol appears in the glossary of terms. Click the underlined word or words to display the corresponding entry in the "Glossary" section of the "Appendices".  p.94
PROCEDURE	Indicates operating methods and the order of operations. The procedure indicated should be carried out in the order of the numbered steps.
[(Name)]	Indicates the name of the buttons on the control panel or the remote control. And also port names. Example: [Esc] button, [Audio1] port
" (Menu Name) "	Indicates configuration menu items. Example: "Image"- "Brightness"

When "unit" or "projector" appears in the text of this *User's Guide*, it may refer to items which are accessories or optional equipment in addition to the main projector unit itself.

Colour mode function

The following six preset colour modes are provided so that you can easily obtain the optimum images simply by selecting the image quality. In addition, if projecting onto blackboards rather than projection screens in places such as schools, you can select the "Blackboard" setting to allow images to be projected in their natural tints.

☛ p.43, p.51, p.53

- Dynamic
- Presentation
- Theatre
- Living Room
- [sRGB](#)
- Blackboard

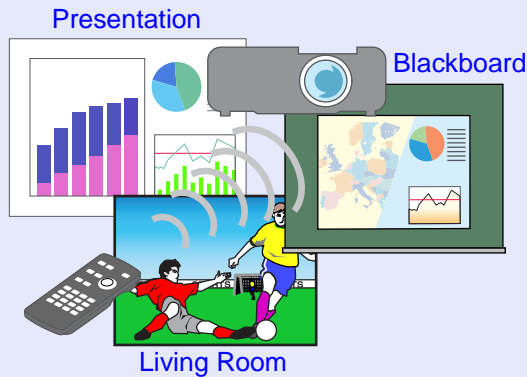

Brightness Control

The brightness of the lamp can be set to one of two settings. Fine and clear images can be obtained even in a bright room like a conference room and a classroom. If projecting images in a dark room or onto a small screen and the images are too bright, change the setting to "Low".

Merit of "Low"

- Reduction in power consumption of approximately 20%
- Reduction in operating noise of approximately 17%
- Approximately 1.5 times longer lamp life

☛ p.59

Automatic keystone correction function

The vertical angle of the projector is detected, so that any vertical keystone distortion in the projected images can be automatically corrected. ☛ p.37

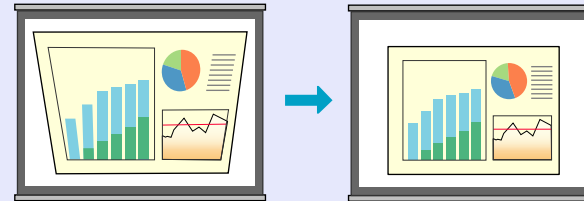

Easy to Operate

The accessory remote control can be used to carry out operations such as pausing projection (Freeze function [p.47](#)), zooming in on important parts of images (E-Zoom function [p.48](#)) and pointing out important parts of images using a pointer icon (Pointer function [p.49](#)).

In addition, the remote control can be used to move the pointer around on the computer screen during projection (see "Wireless Mouse Function" [p.20](#)).

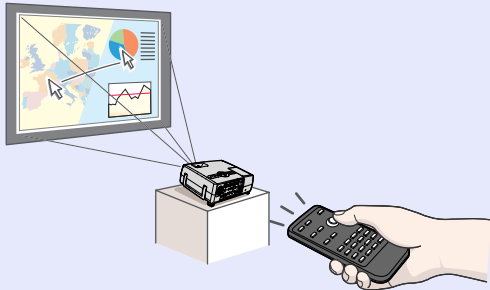

Password protect function assists administration and theft prevention

Password protection function allows you to limit using and changing the settings of the projector. This means that the projector cannot be used if it is taken without authorisation, and thus serves as a theft-prevention feature. [p.27](#)

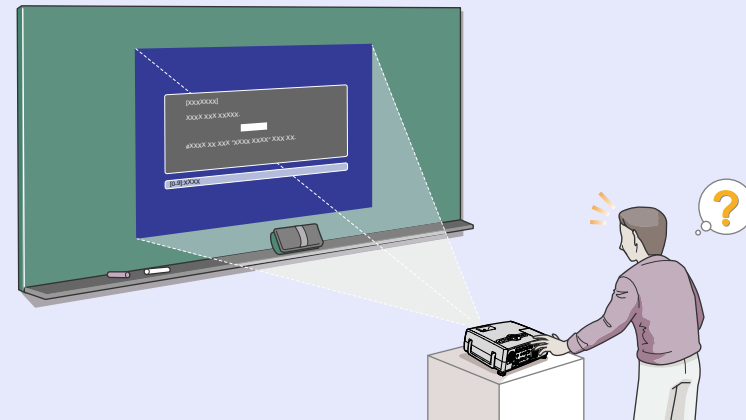

Notations Used in This User's Guide	1
Features of the Projector	2

Before Using the Projector

Part Names and Functions	7
Front/Top	7
Control Panel	8
Rear	9
Base	10
Remote Control	11
Before Using the Remote Control	12
Inserting the Batteries	12
Using the Remote Control and Remote Operating Range	13
Installation	15
Setting Up the Projector	15
Screen Size and Projection Distance	16
Connecting to a Computer	18
Eligible Computers	18
Projecting Images from the Computer	19
Using the Remote Control to Operate the Mouse Pointer (Wireless Mouse Function)	20
Connecting to an External Monitor	22
Connecting to a Video Source	23
Projecting Composite Video Images	23
Projecting S-Video Images	24
Projecting Component Video Images	24
Projecting RGB Video Images	25
Playing Sound from Video Equipment	26
Preventing theft (Password Protect)	27
When Password Protect is enabled	27
Setting Password Protect	28

Basic Operations

Turning the Projector On	31
Connecting the Power Cable	31
Turning the Power On and Projecting Images	32
Turning the Projector Off	34
Adjusting the Screen Image	36
Adjusting the Image Size (Zoom Function)	36
Focusing the Screen Image	36
Adjusting the Image Angle and Automatic Keystone Correction Function	37
Manually Correcting Keystone Distortion	39
Adjusting the Image Quality	40
Adjusting Computer Images and RGB Video Images	40
Selecting the Projection Quality (Colour Mode Selection)	43
Adjusting the Volume	44

Advanced Operations

Functions for Enhancing Projection	46
A/V Mute	46
Freeze	47
Wide-screen Projection of Images from Video Equipment (Changing the Aspect Ratio)	47
E-Zoom	48
Pointer function	49
Using the Configuration Menu Functions	50
List of Functions	51
Using the Configuration Menus	66



Troubleshooting

Using the Help	69
Problems Solving	71
Reading the Indicators	71
When the Indicators Provide No Help	74

Appendices

Maintenance	84
Cleaning	84
Replacing Consumables	85
Saving a User's Logo	90
Optional Accessories and Consumables	93
Glossary	94
List of ESC/VP21 Commands	96
Command List	96
Communication Protocol	96
Cable Layouts	97
USB Connection Setup	98
List of Supported Monitor Displays	99
Specifications	100
Appearance	102
Index	103





Before Using the Projector

This chapter describes the procedures for setting up the projector before use.

Part Names and Functions..... 7

- Front/Top7
- Control Panel.....8
- Rear9
- Base.....10
- Remote Control11

Before Using the Remote Control 12

- Inserting the Batteries12
- Using the Remote Control and Remote Operating Range13
 - Using the Remote Control 13
 - Remote Operating Range..... 14

Installation 15

- Setting Up the Projector15
- Screen Size and Projection Distance.....16
 - EMP-821 16
 - EMP-81/61 16

Connecting to a Computer..... 18

- Eligible Computers18
- Projecting Images from the Computer.....19
 - If the Monitor Port is a Mini D-Sub 15-pin Port (Example) 19

- Using the Remote Control to Operate the Mouse Pointer (Wireless Mouse Function) 20
- Connecting to an External Monitor 22

Connecting to a Video Source 23

- Projecting Composite Video Images 23
- Projecting S-Video Images..... 24
- Projecting Component Video Images 24
- Projecting RGB Video Images..... 25

Playing Sound from Video Equipment 26

Preventing theft (Password Protect)..... 27

- When Password Protect is enabled 27
 - When "Power ON Protect" is enabled (ON)27
 - When "User's Logo Protect" is enabled (ON).....28
- Setting Password Protect 28

Front/Top

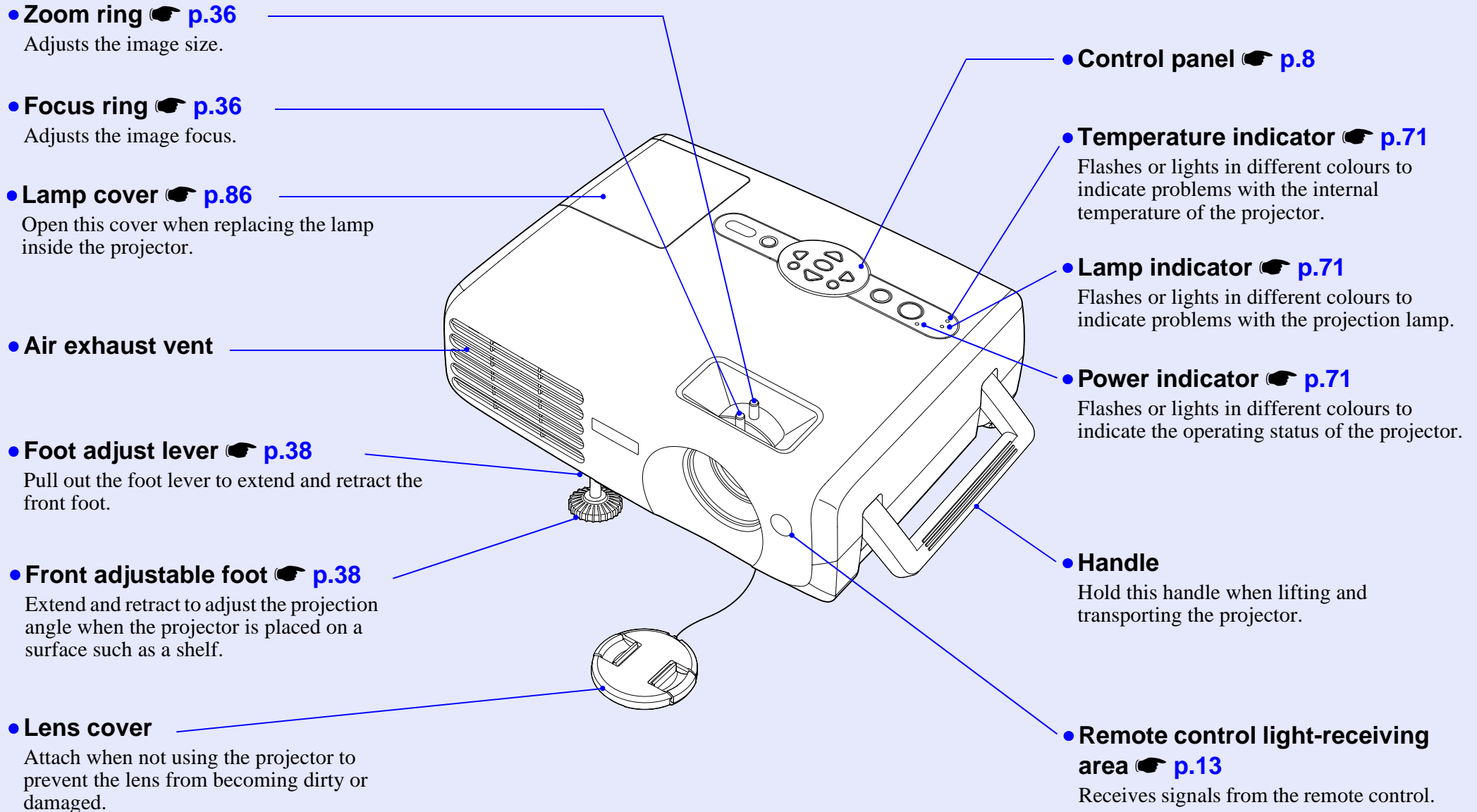

Control Panel

- **[Menu] button**  [p.66](#)

Displays and hides the configuration menu.

- **[Power] button**  [p.32, p.34](#)

Turns the projector power on and off.

- **[Source Search] button**  [p.33](#)

The next input source is searched for automatically in the following order and the image input from the connected equipment is projected each time this button is pressed.

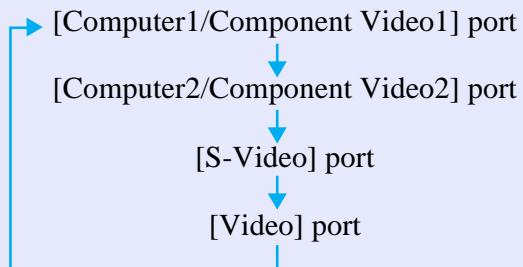

- **[Enter] button**  [p.40, p.66, p.69](#)

Automatically adjusts analogue RGB images from computers and RGB video images to the optimum images.
If a configuration menu or help screen is displayed, it accepts the current selection and moves on to the next-lowest level.

- **[Esc] button**  [p.21](#)

Stops the current function.
Displays the previous screen or menu while viewing a configuration menu.

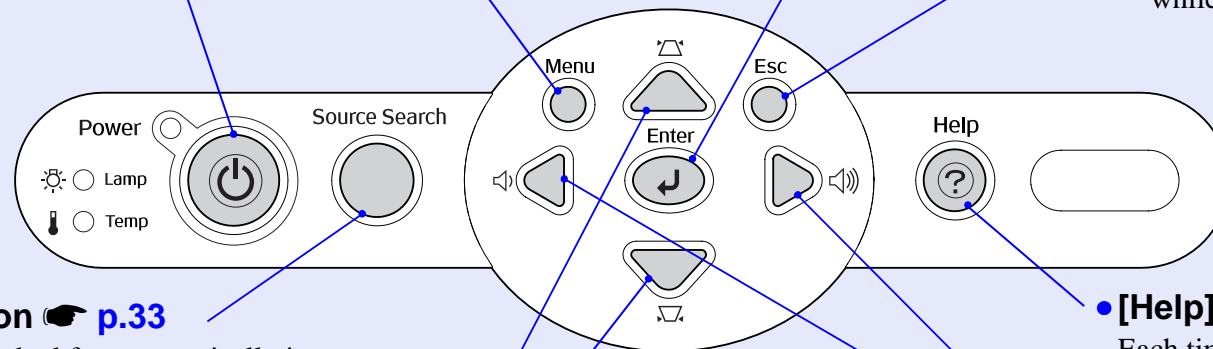

- **[Help] button**  [p.69](#)

Each time this button is pressed, it displays and hides the online help menu that can assist you if you have a problem.

- **[<] [>] button**  [p.44, p.69](#)

Press to adjust the sound volume. If a configuration menu or help screen is displayed, it selects menu items and setting values.

- **[△] [▽] button**  [p.38, p.66, p.69](#)

Press to correct keystone distortion.
If a configuration menu or help screen is displayed, it selects menu items and setting values.

Rear

• [Monitor Out] port p.22

Outputs the projected computer's analogue RGB signals or RGB video signals to an external monitor from the source that is connected to the [Computer1/Component Video1] port. This feature is not available for video equipment signals.

• [Audio Out] port

This outputs the audio signals from the currently-selected input source to external speakers.

• [Computer1/Component Video1] port

• [Computer2/Component Video2] port p.19, p.24, p.25

Input analogue RGB video signals from a computer and RGB video signals and [component video](#) signals from other video sources.

• [Audio1] port p.26

This is used to input audio signals from the equipment that is connected to the [Computer1/Component Video1] port.

• [Audio2] port p.26

This is used to input audio signals from the equipment that is connected to the [Computer2/Component Video2] port.

• Speaker

• Power inlet p.31

Connects to the power cable.

• Rear adjustable foot

• [Video] port p.23

Inputs [composite video](#) signals to the projector from other video sources.

• [Audio] port p.26

This is used to input audio signals from the equipment that is connected to the [Video] port.

• [S-Video] port p.24

Inputs [S-Video](#) signals to the projector from other video sources.

• [Audio] port p.26

This is used to input audio signals from the equipment that is connected to the [S-Video] port.

• [USB] port p.20, p.97

Connects the projector to a computer via the [USB](#) cable when using the wireless mouse function.

Computer images cannot be projected by the projector by using the USB cable to connect the computer.

• Remote control light-receiving area p.13

Receives signals from the remote control.

• Rear adjustable foot

• Security lock (🔒) p.95

• Air intake vent p.84

Clean the air intake vent periodically.

• [Control (RS-232C)] port p.97

Connects the projector to a computer using an RS-232C cable. This port is for control use and should not normally be used.

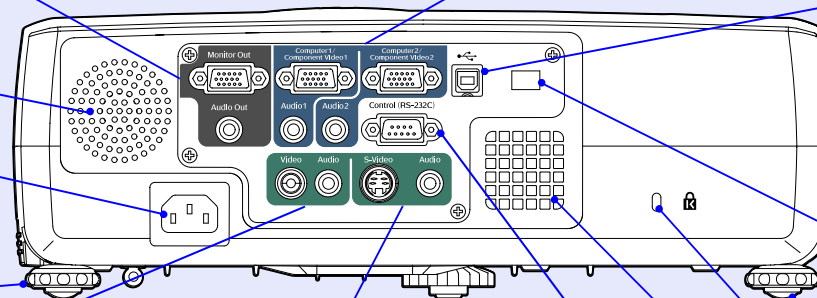

Base

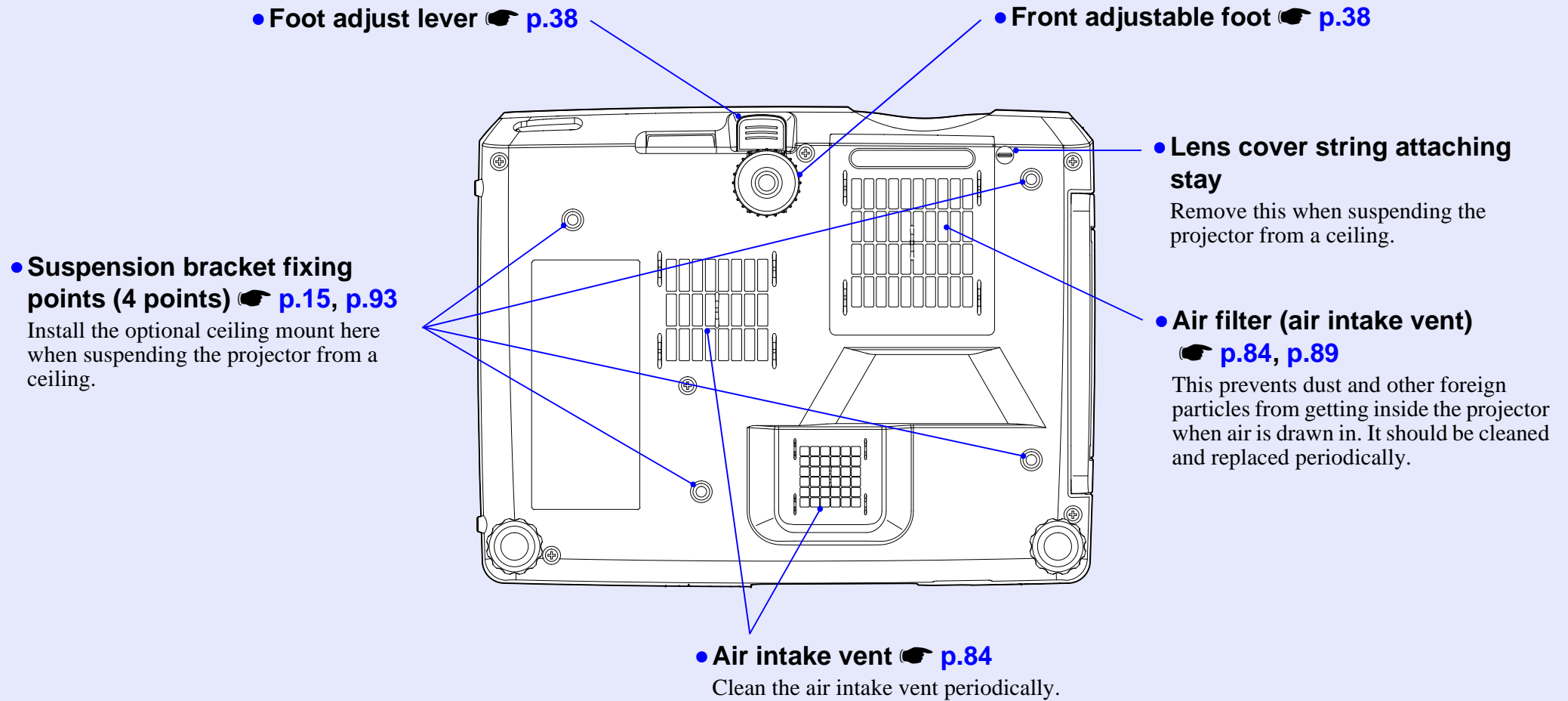

Remote Control

If you position the  over the button icon or button name, a description of that button will appear.

• [Page down] [Page up] buttons  p.20

• [E-Zoom] button (⊕) (⊖)  p.48

• [Enter] button  p.21, p.66, p.69

• [Esc] button  p.21

• [Pointer] button  p.49

• [A/V Mute] button  p.46

• [Computer1] button  p.33

• [Computer2] button  p.33

• [S-Video] button  p.33

• [Video] button  p.33

• [Auto] button  p.40

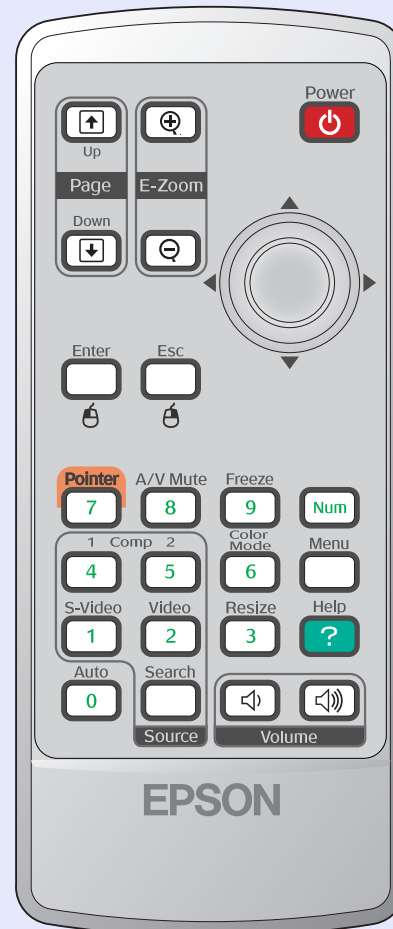

• Remote control light-emitting area  p.13

• [Power] button  p.32, p.34

• [⊕] buttons  p.21, p.66, p.69

• [Freeze] button  p.47

• [Num] button  p.27

• [Color Mode] button  p.43

• [Menu] button  p.66

• [Resize] button  p.47

• [Help] button  p.69

• [Volume] buttons  p.44

• [Search] button  p.33

• Numeric buttons  p.27

Inserting the Batteries

The batteries are not already inserted into the remote control at the time the projector is purchased. You will need to insert the batteries that are provided with the projector before the remote control can be used.



CAUTION

Be sure to read the Safety Instructions/World-Wide Warranty Terms before handling the batteries.

PROCEDURE

1 Remove the battery cover.

While pushing the catch of the battery compartment cover, lift the cover up.

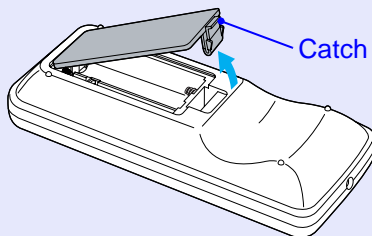

2

Insert the batteries.

Check the positions of the (+) and (-) marks inside the battery holder to ensure that the batteries are inserted the correct way.

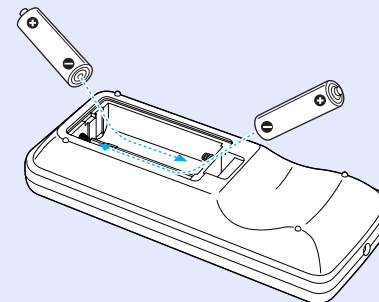

3

Replace the battery cover.

Press the battery compartment cover until it clicks into place.

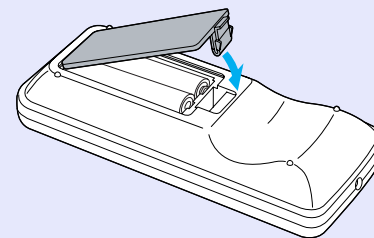

TIP

If delays in the responsiveness of the remote control occur or if it does not operate after it has been used for some time, it probably means that the batteries are becoming flat. Have two spare AAA-size alkali batteries ready to use when required.

Using the Remote Control and Remote Operating Range

Using the Remote Control

The remote control is used in the following way.

PROCEDURE

Point the remote control light-emitting area toward one of the remote control light-receiving areas on the projector and operate the remote control buttons.

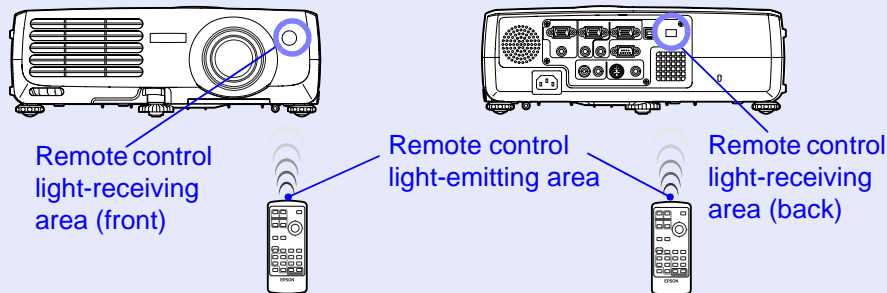

TIP

- Do not allow sunlight or light from fluorescent lamps to shine directly onto the projector's remote control light-receiving areas, otherwise it may interfere with the reception of signals from the remote control.
- If delays in the responsiveness of the remote control occur or if it does not operate after it has been used for some time, it probably means that the batteries are getting flat. If this happens, replace the batteries with new ones. [p.12](#)
- If any of the buttons on the remote control are pressed down for more than 30 seconds, the remote control stops to send signals (remote control's sleep mode). The purpose of this is to prevent the batteries from being consumed due to something being placed on top of the remote control. When the button is released, normal remote control operation will resume.

Remote Operating Range

Use the remote control within the ranges indicated below. If the distance or angle between the remote control and the remote control light-receiving area is outside the normal operating range, the remote control may not work.

Operating distance	Operating angle
Approx. 6 m (20 ft.)	Approx. $\pm 30^\circ$ horizontally Approx. $\pm 15^\circ$ vertically

Operating angle (horizontal)

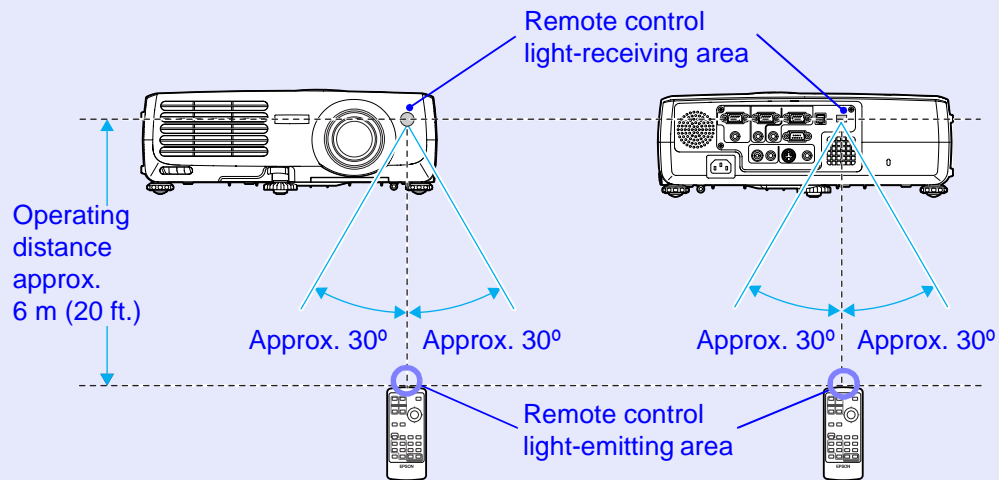

Operating angle (vertical)

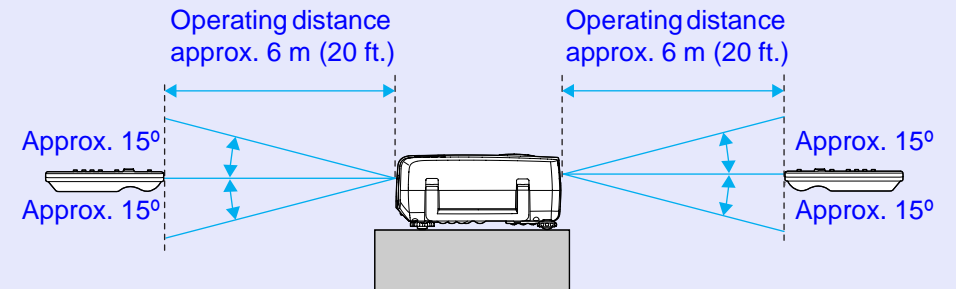

When suspended from the ceiling

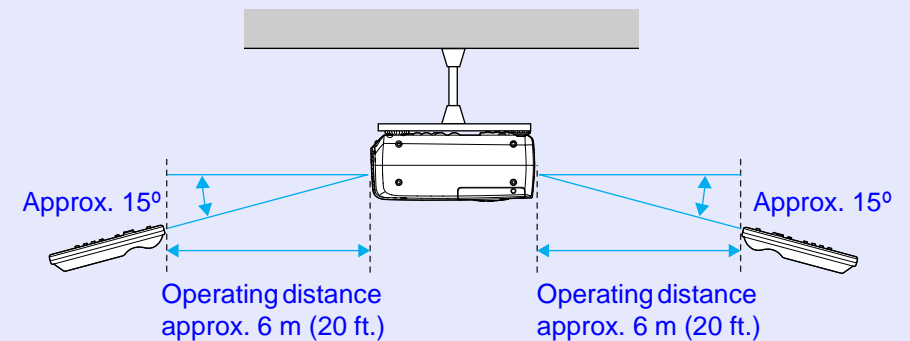

Setting Up the Projector

The projector supports the following four different projection methods, allowing you to choose the best method for displaying your images.



CAUTION

Before setting up the projector, be sure to first read the separate Safety Instructions/World-Wide Warranty Terms.

- Front projection (Front projection)

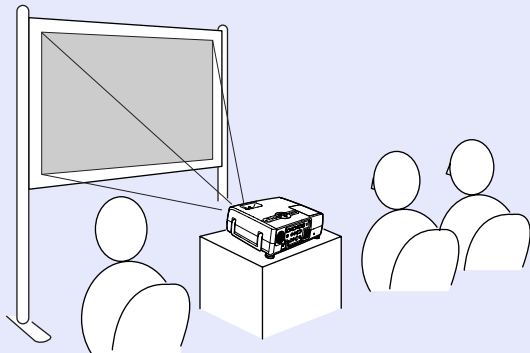

- Rear projection using a translucent screen (Rear projection)

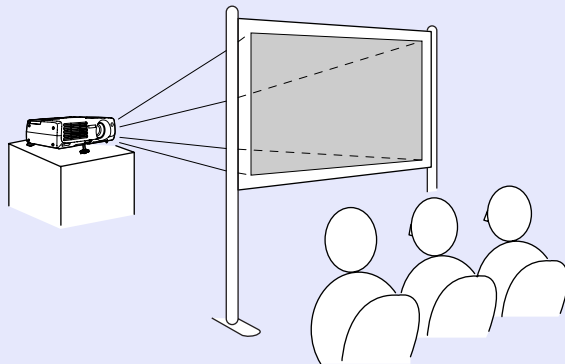

- Front/ceiling projection (Front/Ceiling projection)

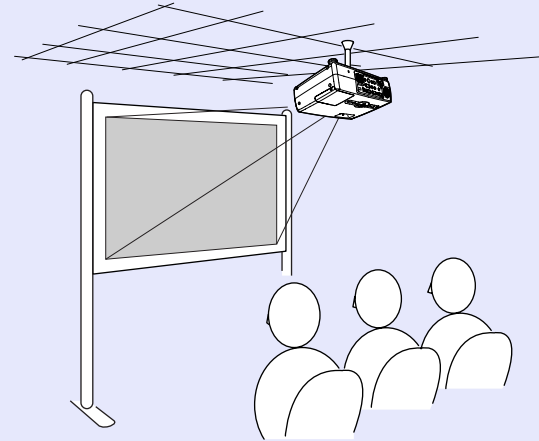

- Rear/ceiling projection using a translucent screen (Rear/Ceiling projection)

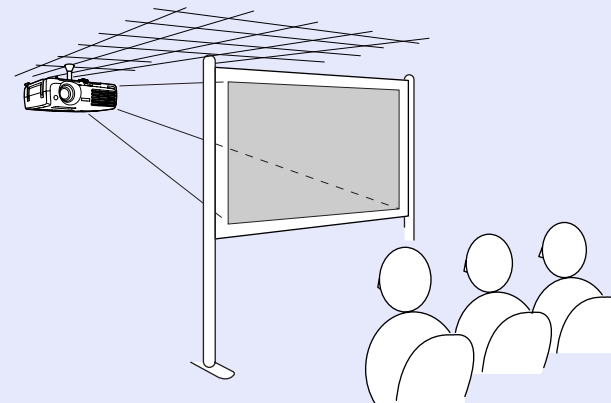

* A special method of installation is required for suspending the projector from the ceiling. Please contact your supplier if you would like to use this installation method. The optional ceiling mount is required when installing the projector on the ceiling. [p.93](#)



TIP

When using ceiling projection or projection using a translucent screen, set the "Projection" command in the "Extended" menu to match the installation method. [p.62](#)

Screen Size and Projection Distance

The distance between the projector's lens and the screen determines the actual image size.

While referring to the following table, position the projector so that the images are projected onto the screen at the optimum size.

The values should be used as a guide for setting up the projector. The actual values will vary depending on projection conditions and the zoom setting.

EMP-821

Recommended distance	86–1473 cm (2.8–48.3 ft.)
-----------------------------	---------------------------

Units: cm (in.)

Units: cm (ft.)

Units: cm (in.)

4:3 Screen size		Projection distance A		Distance from centre of lens to bottom edge of screen B
		Shortest (wide)	Longest (tele)	
30"	61 × 46 (24.0 × 18.1)	86 (2.8)–142 (4.7)		4 (1.6)
40"	81 × 61 (31.9 × 24.0)	117 (3.8)–192 (6.3)		6 (2.2)
50"	100 × 76 (39.4 × 30.0)	147 (4.8)–241 (5.9)		7 (2.7)
60"	120 × 90 (47.2 × 35.4)	178 (5.8)–290 (9.5)		8 (3.3)
80"	160 × 120 (63.0 × 47.2)	239 (7.8)–389 (12.8)		11 (4.4)
100"	200 × 150 (78.7 × 59.1)	300 (9.8)–487 (16.0)		14 (5.5)
200"	410 × 300 (161.4 × 118.1)	604 (19.8)–980 (32.2)		28 (10.9)
300"	610 × 460 (240.2 × 181.1)	909 (29.8)–1473 (48.3)		42 (16.4)

EMP-81/61

Recommended distance	87–1094 cm (2.9–35.9 ft.)
-----------------------------	---------------------------

Units: cm (in.)

Units: cm (ft.)

Units: cm (in.)

4:3 Screen size		Projection distance A		Distance from centre of lens to bottom edge of screen B
		Shortest (wide)	Longest (tele)	
30"	61 × 46 (24.0 × 18.1)	87 (2.9)–104 (3.4)		4 (1.6)
40"	81 × 61 (31.9 × 24.0)	117 (3.8)–141 (4.6)		6 (2.2)
50"	100 × 76 (39.4 × 30.0)	148 (4.9)–177 (5.8)		7 (2.7)
60"	120 × 90 (47.2 × 35.4)	179 (5.9)–214 (7.0)		8 (3.3)
80"	160 × 120 (63.0 × 47.2)	240 (7.9)–287 (9.4)		11 (4.4)
100"	200 × 150 (78.7 × 59.1)	301 (9.9)–361 (11.8)		14 (5.5)
200"	410 × 300 (161.4 × 118.1)	608 (19.9)–728 (23.9)		28 (10.9)
300"	610 × 460 (240.2 × 181.1)	915 (30.0)–1094 (35.9)		42 (16.4)



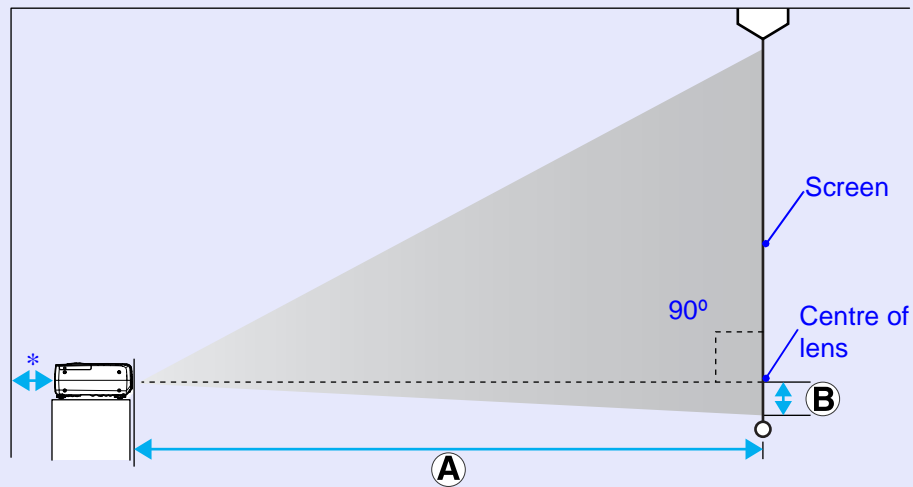

* When installing against a wall, leave a space of about 20 cm (7.9 in.) between the projector and the wall.

**TIP**

- *The lens allows a zoom ratio of up to the following ratio.*
EMP-821 :Approx. $\times 1.6$
EMP-81/61 :Approx. $\times 1.2$
The projected images can be enlarged up to the following ratio.
EMP-821 :Approx. $\times 1.6$
EMP-81/61 :Approx. $\times 1.2$
- *The image size will be reduced when keystone correction is carried out.*



CAUTION

When connecting the projector to a computer, be sure to check the following.

- *Turn off the power for both the projector and the computer before connecting them. If the power for either device is on at the time of connection, damage may result.*
- *Check the shapes of the cable connectors and the device ports before making the connections. If you try to force a connector to fit a device port with a different shape or number of terminals, damage to the connector or port may result.*
- *Do not bind the power cable and the connecting cable together. If the power cable and the connecting cable are bound together, image interference or errors in operation may result.*

Eligible Computers

The projector cannot be connected to some types of computer, or projection of images may not be possible even if actual connection is possible. Make sure that the computer you intend to use satisfies the conditions given below.

- **Condition 1:** The computer must have an image signal output port. Check that the computer has a port such as an "RGB port", "monitor port" or "CRT port" which can output image signals. If the computer has a built-in monitor, or if using a laptop computer, it may not be possible to connect the computer to the projector, or alternatively you may need to purchase a separate external output port. Refer to the documentation for your computer under a heading such as "Connecting an external monitor" or similar for further details.
- **Condition 2:** The display resolution and frequency of the computer must be listed in the "List of Supported Monitor Displays".
☛ "Appendices: List of Supported Monitor Displays" [p.99](#).
Some computers allow you to change the output resolution, so if necessary, change the resolution to one that matches a setting in the "List of Supported Monitor Displays", while referring to the documentation provided with the computer.

TIP

- *You may need to purchase a separate adapter depending on the shape of the computer's port. Refer to the documentation provided with the computer for further details.*
- *If the computer and projector are too far away from each other for the accessory computer cable to reach, use the optional VGA-HD15 PC cable. ☛ "Appendices: Optional Accessories" [p.93](#)*

Projecting Images from the Computer

The shape and specifications of the computer's monitor port will determine what type of cable should be used. Check the following to see which type of port your computer has.

■ If the Monitor Port is a Mini D-Sub 15-pin Port (Example)

Use the accessory computer cable to make the connection.

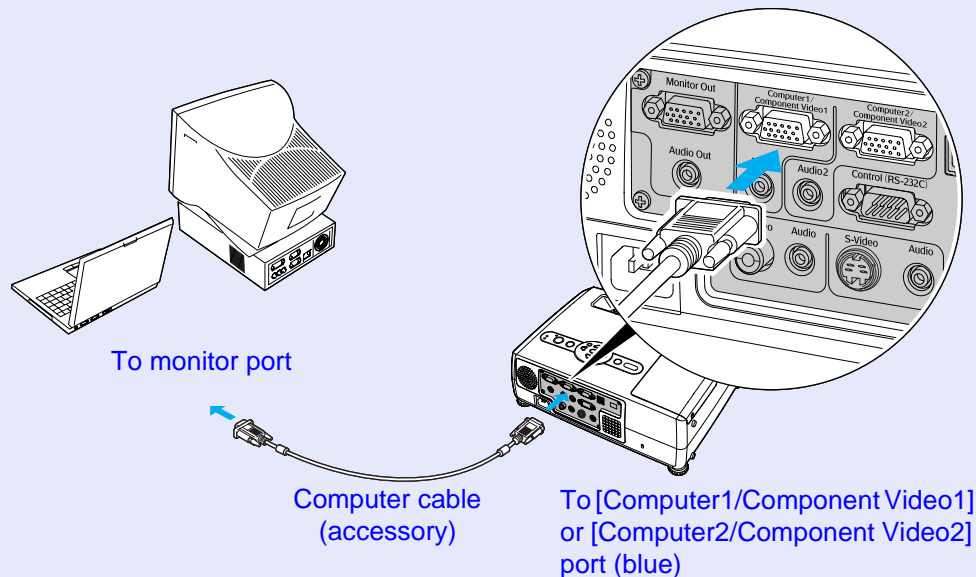

TIP

- *The input source is determined automatically based on the input signals.
Some computer signals may be reproduced with different colours from the original images. If this happens, set the input source to "Computer1" or "Computer2".* 🖱️ [p.55](#)
- *If more than one input source is connected to the projector at the same time, you can use button operations to select the signals to be projected.* 🖱️ [p.33](#)

Using the Remote Control to Operate the Mouse Pointer (Wireless Mouse Function)

You can use the remote control as a wireless mouse to control the mouse pointer on the computer screen. To do this, you must use the accessory [USB](#) cable to connect the USB port of the computer to the [USB] port at the rear of the projector.

Computer	Mouse used	Applicable cable
Windows 98/2000/Me/XP Home Edition/XP Professional	USB mouse	USB cable (accessory)
Macintosh (OS 8.6–9.2/10.0–10.3)	USB mouse	USB cable (accessory)

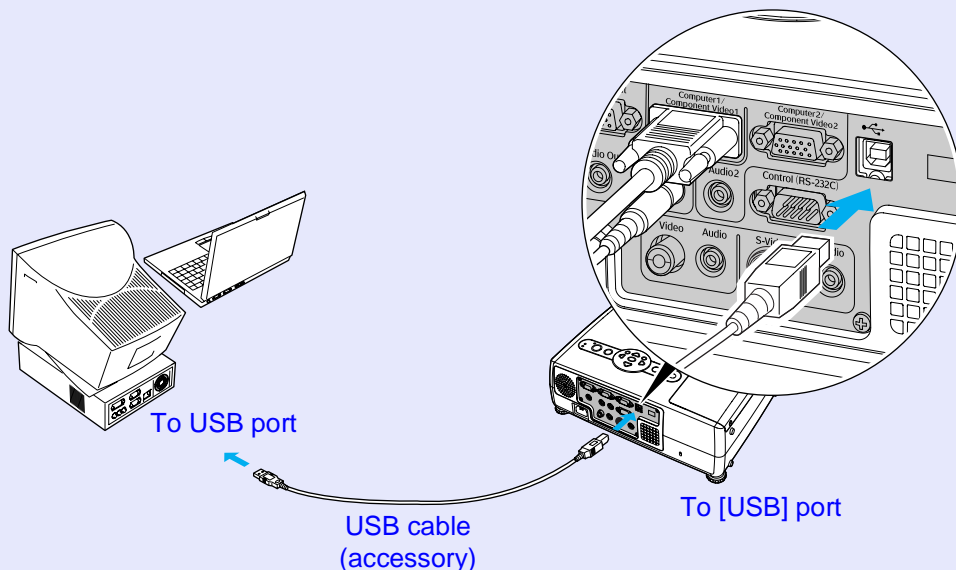

TIP

- **The USB cable can only be connected to computers with a standard USB interface. If using a computer which is running Windows, the computer must have had a full version of Windows 98/2000/Me/XP Home Edition/XP Professional installed. If the computer is running a version of Windows 98/2000/Me/XP Home Edition/XP Professional that has been upgraded from an earlier version of Windows, correct operation cannot be guaranteed.**
- **It may not be possible to use the mouse function under some versions of both the Windows and Macintosh operating systems.**
- **Some computer settings may have to be changed in order for the mouse function to be used. Consult the documentation for the computer for further details.**

* When using the remote control as a wireless mouse, the [Page down] and [Page up] buttons on the remote control can be used to scroll back and forth through pages when projecting a PowerPoint presentation.



Once the connection has been made, the mouse pointer can be operated as follows.

Moving the mouse pointer

If you tilt the [Dial] button on the remote control, the mouse pointer will move in the direction of tilt.

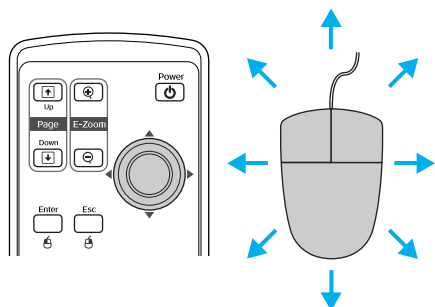

Left click

Press the [Enter] button.
If you press the [Enter] button twice in rapid succession, it has the effect of a double-click.

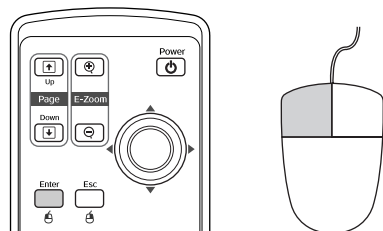

Right click

Press the [Esc] button.

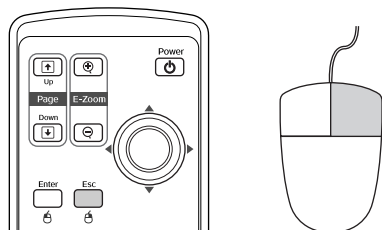

Drag and drop

If you tilt the [Dial] button while keeping the [Enter] button pressed down, you can carry out drag operations. Press the [Enter] button at the desired location to drop the item being dragged.

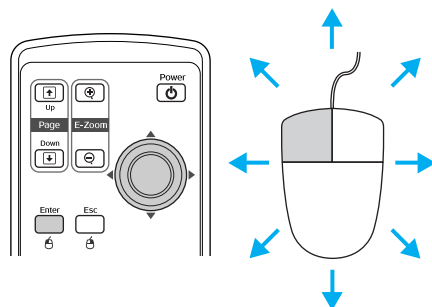

TIP

- *If the mouse button settings have been reversed at the computer, the operation of the remote control buttons will also be reversed.*
- *The wireless mouse function cannot be used while the following functions are being used.*
 - *While a configuration menu is being displayed*
 - *While a help menu is being displayed*
 - *While the E-Zoom function is being used*
 - *While a user's logo is being captured*
 - *Pointer function*
 - *While adjusting sound volume*



Connecting to an External Monitor

Analogue RGB images and RGB video images from a computer that are being input to the [Computer1/Component Video1] port can be viewed on an external computer monitor at the same time they are being projected by the projector, so that the images can be checked at times such as when giving presentations.

If the images being projected are from a source that is connected to the [Computer2/Component Video2] port, these images cannot be output to an external monitor.

Connect the external monitor using the cable that is provided with the monitor.

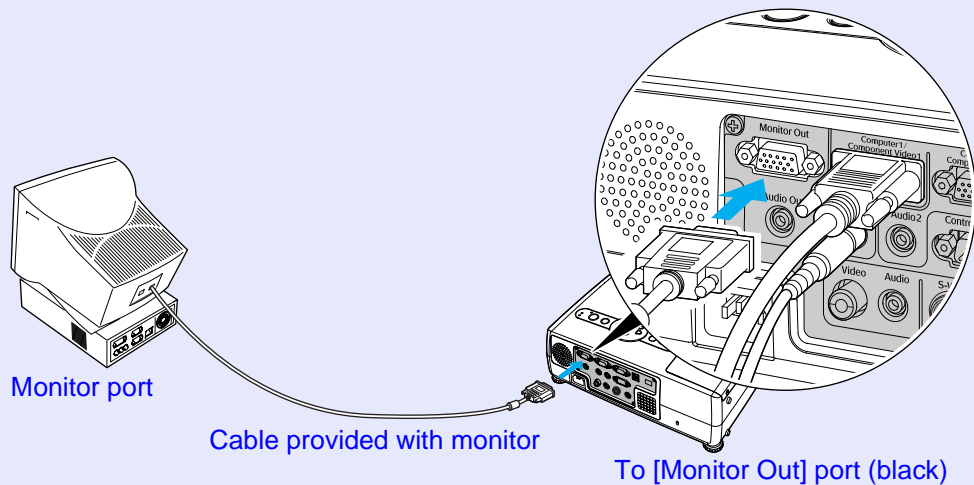

TIP

- *Video images cannot be output to an external monitor.*
- *The setting gauge for keystone correction and the configuration menus and help menus are not output to the external monitor.*

CAUTION

When connecting the projector to video equipments, take the following precautions.

- Turn off the power for both the projector and the video equipments before connecting them. If the power for either device is on at the time of connection, damage may result.
- Check the shapes of the cable connectors and the device ports before making the connections. If you try to force a connector to fit a device port with a different shape or number of terminals, a malfunction or damage to the connector or port may result.
- Do not bind the power cable and the connecting cable together. If the power cable and the connecting cable are bound together, image interference or errors in operation may result.

Projecting Composite Video Images

Use a commercially- available A/V cable to make the connection.

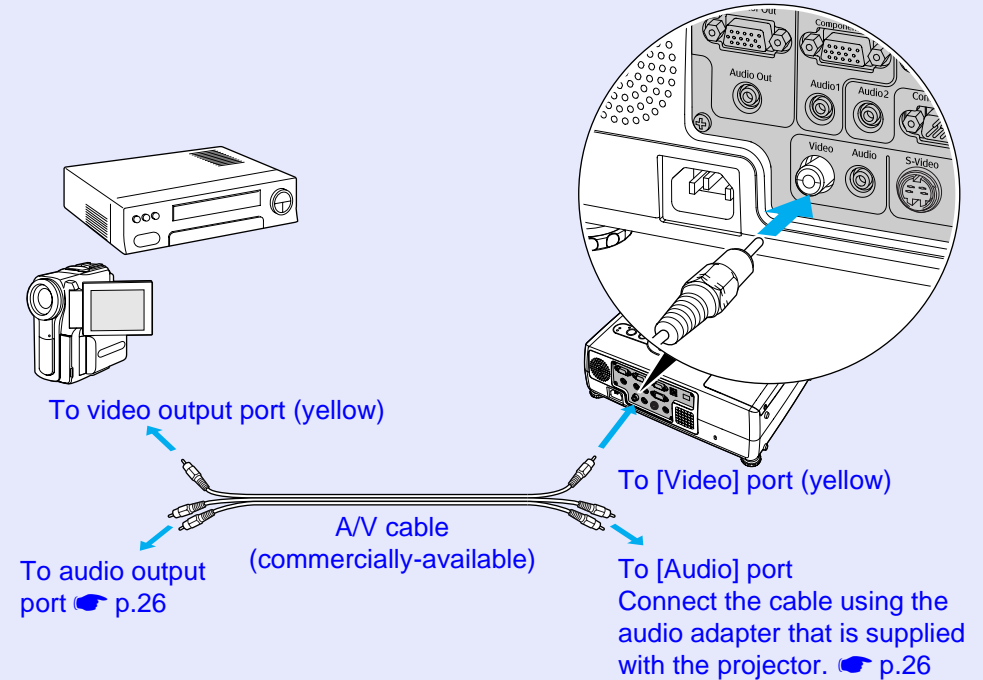

TIP

If more than one input source is connected to the projector at the same time, you can use button operations to select the signals to be projected. p.33

Projecting S-Video Images

Use a commercially-available [S-Video](#) cable to make the connections.

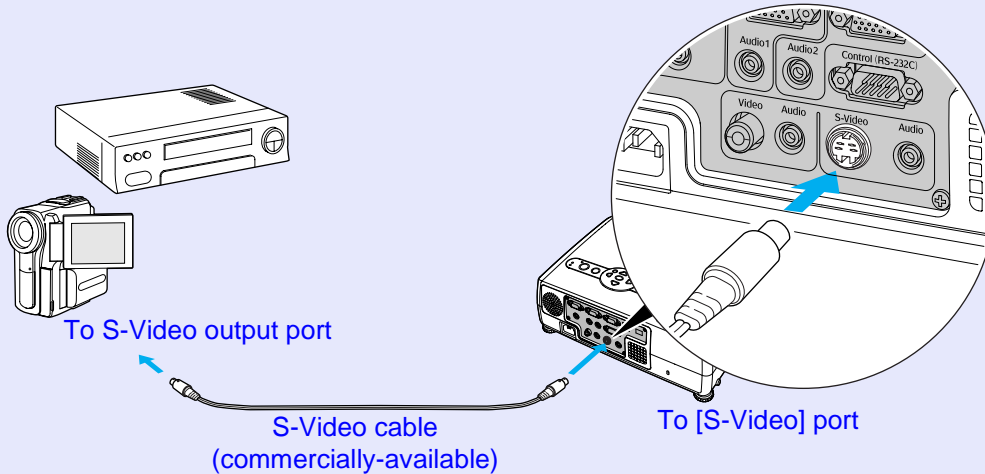

TIP

If more than one input source is connected to the projector at the same time, you can use button operations to select the signals to be projected. [p.33](#)

Projecting Component Video Images

Use the optional [component video](#) cable to make the connection. "Appendices: Optional Accessories" [p.93](#)

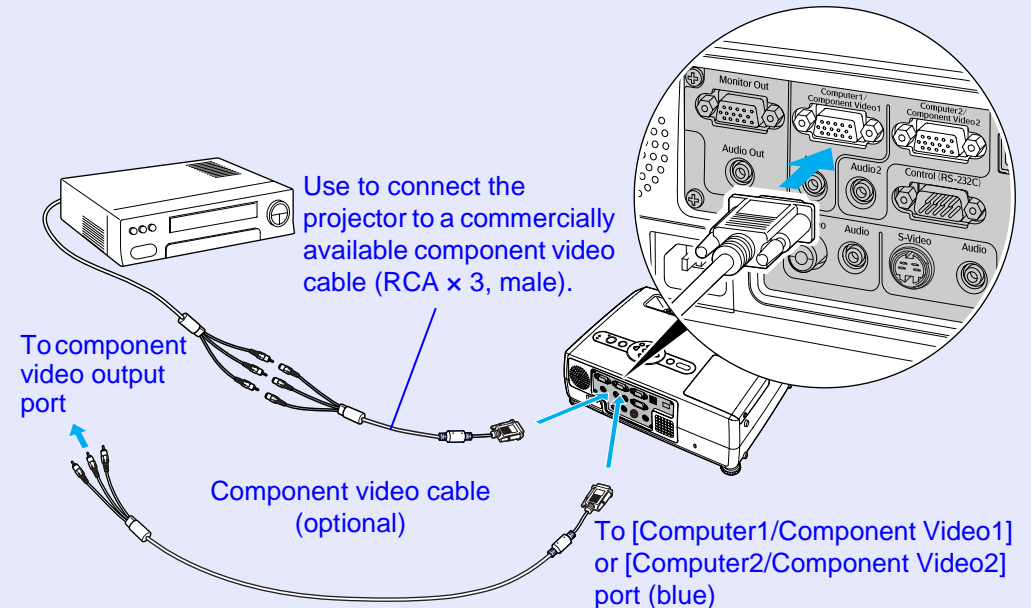

TIP



- *The input source is determined automatically based on the input signals. Some video signals may be reproduced with different colours from the original images. If this happens, set the input source to "Component Video1" or "Component Video2".* [p.57](#)
- *If more than one input source is connected to the projector at the same time, you can use button operations to select the signals to be projected.* [p.33](#)

Projecting RGB Video Images

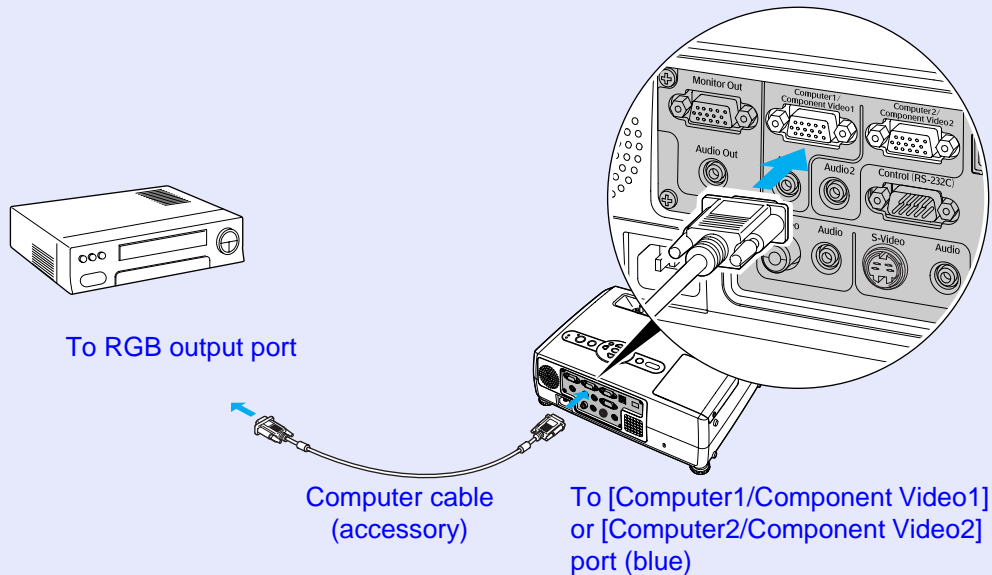
Use the accessory computer cable to make the connections.



TIP

- *The input source is determined automatically based on the input signals. Some video signals may be reproduced with different colours from the original images. If this happens, set the input source to "Computer1" or "Computer2".*  [p.55](#)
- *If more than one input source is connected to the projector at the same time, you can use button operations to select the signals to be projected.*  [p.33](#)

The projector has a built-in speaker with a maximum output of 5 W. You can output sound from connected video equipment (such as a computer or video deck) through the projector's built-in speaker if the video equipment has an audio output port.

The [Audio] port to use is the port that is in the same box as the port being used to input the video signals. p.9

Select the audio cable that is used for this connection from the following, depending on the shape of the other equipment's port.

- If connecting to a stereo mini jack (such as the audio output port of a computer): Use a commercially-available stereo mini jack audio cable to make the connection.
- If connecting to an RCA pin jack ×2 (red/white) (such as the audio output port of video equipment): Use the audio adapter that is supplied with the projector and a commercially-available A/V cable to make the connection.



TIP

- You can adjust the volume after projection has started. p.44
- If using a commercially-available 2RCA (L/R)/stereo mini-jack audio cable, use one that is marked as "No resistance".

If the image signals are being input to the [Computer1/Component Video1] port

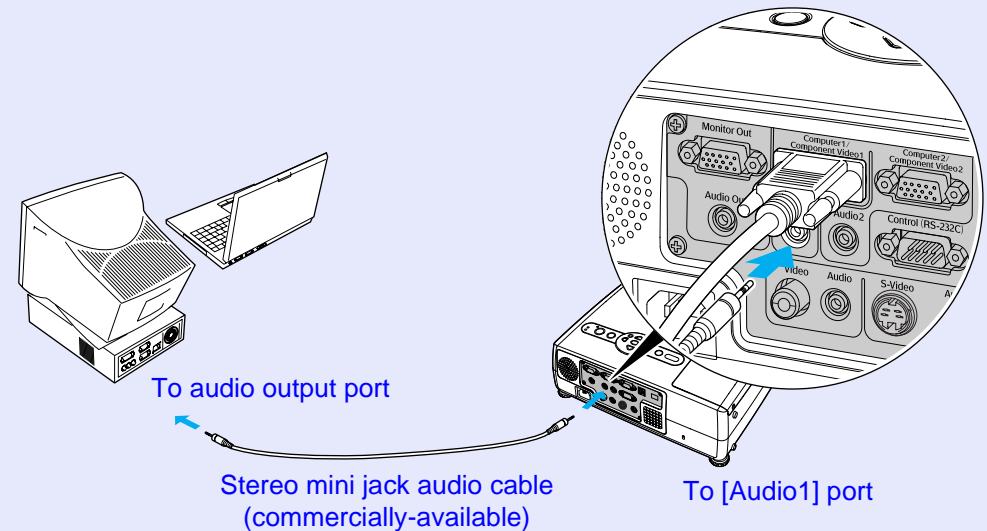

If the video signals are being input to the [Video] port

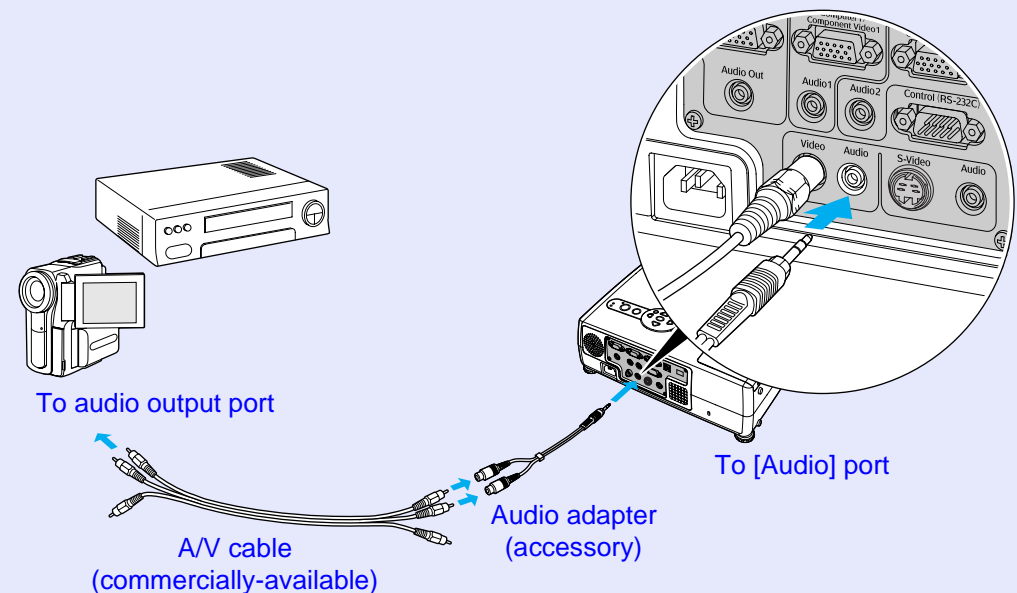

When the Password Protect function is activated, people who do not know the password cannot use the projector to project images when the power is turned on. Furthermore, the user's logo that is displayed on the background of the screen cannot be changed. This is effective against theft.

When Password Protect is enabled

■ When "Power ON Protect" is enabled (ON)

When the power is turned on, the password entry screen is displayed. If a window asking you to enter a password is displayed, press the [Num] button to switch the buttons shown in the box in the illustration below to numeric keypad mode.

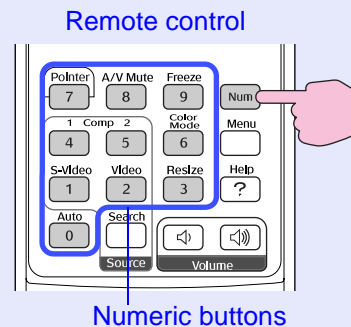
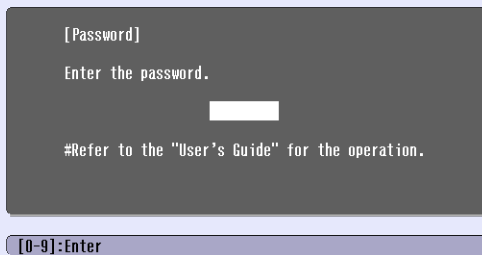

While holding down the [Num] button, press the numeric keypad buttons to enter the password. If the password is entered correctly, projection will then start.



TIP

- ***If an incorrect password is entered three times in succession, the message "The projector's operation will be locked." will be displayed for approximately five minutes, and then the projector will switch to standby mode. If this happens, disconnect the power plug from the electrical outlet and then reinsert it and turn the projector's power back on. A window requesting you to enter the password will be displayed, so enter the correct password.***
If you happen to forget the password, make a note of the "Request Code: xxxxx" number that appears in the Password screen and contact the nearest address provided in the "International Warranty Conditions" section of the Safety Instructions/World-Wide Warranty Terms booklet.
- ***If you repeat the above operations ten times resulting in an incorrect password being entered thirty times, the following message will be displayed and the projector will not accept password entries any more.***
"The projector's operation will be locked. Contact the nearest address provided in the "International Warranty Conditions" section of the Safety Instructions/World Wide Warranty Terms booklet."

When "User's Logo Protect" is enabled (ON)

If an attempt is made to carry out any of the following user logo operations, a message is displayed and the setting cannot be changed. To change the setting, set "User's Logo Protect" to "OFF" first.  p.29

- Capturing a user's logo
- When the "Extended" - "Display" - "Background Color" menu setting is changed from "Logo" to "Black" or "Blue", or changed from "Black" or "Blue" to "Logo".
- When the "Extended" - "Display" - "Startup Screen" menu setting ("ON" or "OFF") is changed.

Setting Password Protect

Use the following procedure to set Password Protect.

PROCEDURE

1 Hold down the [Freeze] button for approximately 5 seconds.

The "Password Protect" menu will be displayed.
This can also be displayed by pressing the [Menu] button while holding down the [▶] button continuously for about 5 seconds.

Remote control

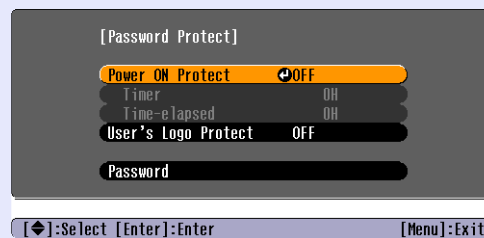
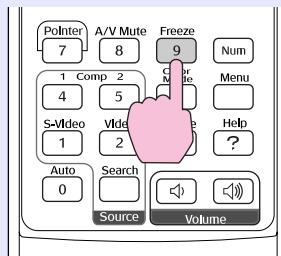

TIP

- If Password Protect has already been enabled, the "Password" screen will be displayed.
If the password has been entered correctly, the "Password Protect" menu will be displayed.
 "When Password Protect is enabled" p.27
- If Password Protect is set to "ON", attach the accessory Password Protect sticker to your preferred position on the projector as a theft-prevention measure.



2 Turn "Power ON Protect" on.

- (1) Select "Power ON Protect", and then press the [Enter] button.
- (2) Select "ON", and then press the [Enter] button.
- (3) Press the [Esc] button.

In the following "Timer" setting, you can set the time that the projector can be used without needing to enter a password.

If setting the time, continue on to the next step. If not setting the time, continue on to step 5.



TIP

The portion of the length of time set that has already been used can be checked using the "Timer-elapsd" command.



3 Select "Timer" and then press the [Enter] button.



4 Enter the setting time as a number of up to 4 digits.

While holding down the [Num] button, use the numeric keypad buttons to enter the setting time within the range of 0 to 9999 hours and then press the [Enter] button. If you make a mistake entering the time, press the [Esc] button and re-enter the time. A message will appear after this.

When you have finished using the "Password Protect" menu, the countdown for the elapsed time will start.

**TIP**

If the setting time is set to "0", projection will not be possible when the power cord is disconnected from the wall outlet and then reconnected, unless you first enter the password.

5 Turn "User's Logo Protect" on.

- (1) Select "User's Logo Protect", and then press the [Enter] button.
- (2) Select "ON", and then press the [Enter] button.
- (3) Press the [Esc] button.

6 To set a password, select "Password" and then press the [Enter] button.**7 The message "Change the password?" will be displayed, so select "Yes" and then press the [Enter] button.**

The default setting for the password is "0000", but you should change this to your own desired password.

If you select "No", the screen shown at step 1 will be displayed again.

8 Enter a 4-digit password.

While holding down the [Num] button, use the numeric keypad buttons to enter a 4-digit number. The number entered will be displayed as "* * * *".

Once four digits have been entered, the confirmation screen will be displayed.

9 Re-enter the password that you entered in step 8.

The message "The new password is stored." will be displayed. If you enter the password incorrectly, a message will be displayed prompting you to re-enter the password.

10 Once the setting is complete, press the [Menu] button.**TIP**

- *When the time period has elapsed and the password is entered, projection will start again, the "Timer-elapsed" setting will be reset to "0" and the countdown will start again.*
- *Make a note of the password so that you do not forget it and keep it in a safe place.*
- *If you lose the remote control, you will not be able to enter the password. Keep the remote control in a safe place at all times.*

Basic Operations

This chapter describes basic operations such as turning the projector on and off and adjusting the projected images.

Turning the Projector On.....	31	Adjusting the Image Quality.....	40
• Connecting the Power Cable	31	• Adjusting Computer Images and RGB Video Images	40
• Turning the Power On and Projecting Images	32	• Automatic Setup	40
Turning the Projector Off.....	34	• Adjusting the Tracking	41
Adjusting the Screen Image	36	• Adjusting the Sync	42
• Adjusting the Image Size (Zoom Function)	36	• Selecting the Projection Quality	
• Focusing the Screen Image	36	(Colour Mode Selection)	43
• Adjusting the Image Angle and Automatic Keystone		Adjusting the Volume.....	44
Correction Function.....	37		
• Manually Correcting Keystone Distortion.....	39		

Turn on the power to start projecting images.



CAUTION

Be sure to read the separate Safety Instructions/World-Wide Warranty Terms before projecting images.

Connecting the Power Cable



TIP

When the "Extended" - "Operation" - "Direct Power ON" menu item is set to "ON", a confirmation buzzer sounds and the projector's power turns on as soon as the power plug is inserted into the electrical outlet, and projection then starts. [p.62](#)

The power for the equipment that is connected to the projector should be turned on beforehand.

PROCEDURE

- 1** Check that the power is turned off for the projector and all components connected to the projector.
- 2** Connect the computer or other video source to the projector. [p.18](#), [p.23](#)
- 3** Remove the lens cover.
Hold the lens cover by the knob in the middle of the cover and remove it.

4

Connect the accessory power cable to the projector.

Check that the power cable connector is facing the same way as the power inlet on the projector, and then insert the power cable connector securely into the projector.

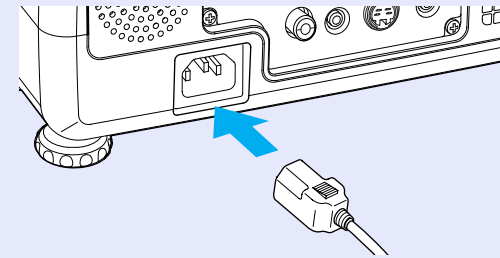
**5**

Connect the other end of the power cable to an earthed electrical outlet.

The Power indicator will light orange.

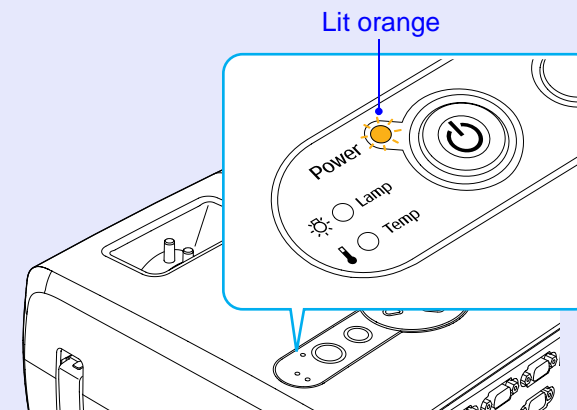

Turning the Power On and Projecting Images



TIP

The *Password Protect* setting may cause the password entry screen to be displayed each time the power is turned on. If this happens, enter the password. [p.27](#)

PROCEDURE

- 1 Check that the Power indicator has stopped flashing and is lit orange.

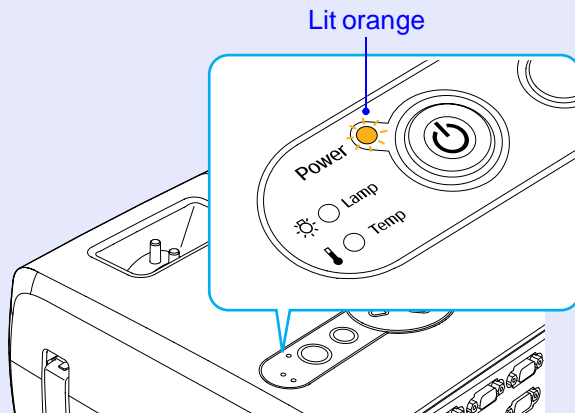

- 2 Turn on the power for all equipment connected to the projector.

For a video source, press the [Play] button at the video source to start playback if necessary.

3

- 3 Press the [Power] button on either the projector's control panel or the remote control to turn on the power for the projector.

A beep will sound to indicate that the projector is starting up. The Power indicator starts to flash green as the projector warms up, and an image begins to appear.

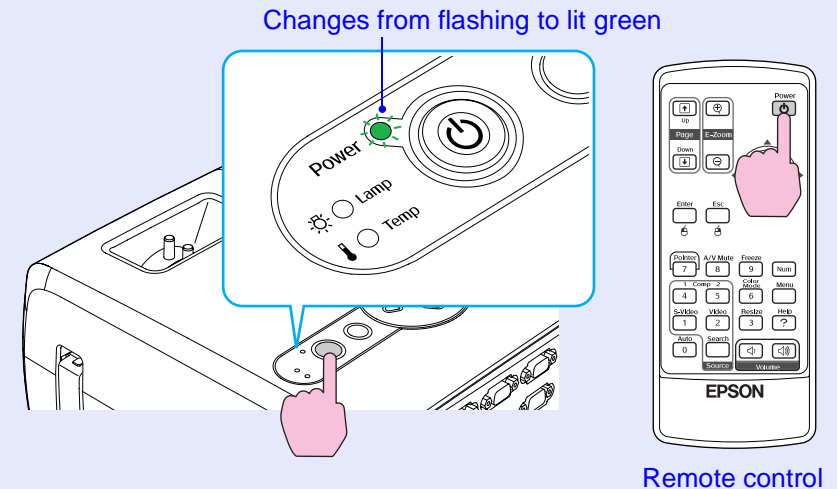

TIP

- If the Power indicator is flashing green, operation of the [Power] buttons is disabled.
- Depending on the settings, the message "No Signal." may appear. ["Extended" - "Display" - "Message" p.61](#)
- If the "Setting" - "Operation Lock" menu setting is set to "ON", none of the buttons on the projector's control panel will work except for the [Power] button. [p.59](#)
Use the remote control buttons at such times.



4 If more than one external device is connected to the projector, use the remote control or projector control panel buttons to select the image source to be projected while referring to the following table.

The input source can also be searched for automatically by pressing the [Source Search] button. Images from the connected equipment will be projected in turn.

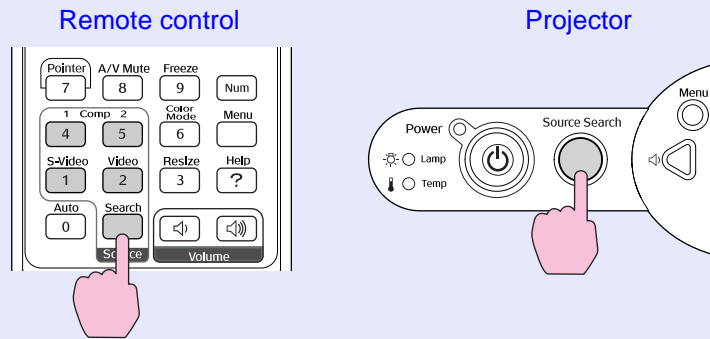

Port	Remote control button selected	Display at top-right of screen
Computer1/ Component Video1	Computer1	Computer1 (Auto)* Computer1* Component Video1*
Computer2/ Component Video2	Computer2	Computer2 (Auto)* Computer2* Component Video2*
S-Video	S-Video	S-Video
Video	Video	Video

* The signal name that has been set for the "Computer1 Input" and "Computer2 Input" in the "Signal" menu will be displayed.



TIP

- If only one signal source has been connected, the signals from that source will be projected without needing to press any of the buttons on the remote control or the projector's control panel.
- If the "No Signal." message does not disappear, check the connections again.
- If a laptop computer or a computer with an LCD screen has been connected to the projector, the images may not be projected straight away. After starting projection, check that the computer has been set up to output signals externally.

The following table shows examples of how to toggle output settings. For details, refer to the section of the documentation provided with your computer under a heading such as "External output", "Connecting an external monitor" or similar.

NEC	Panasonic	Toshiba	IBM	Sony	Fujitsu	Macintosh
[Fn]+[F3]	[Fn]+[F3]	[Fn]+[F5]	[Fn]+[F7]	[Fn]+[F7]	[Fn]+[F10]	Set mirror setting or display detection.

- If the same still picture is projected for a long period of time, the projected image may become burned into the screen. You should avoid leaving the same image displayed for long periods.



Follow the procedure below to turn off the power of the projector.

PROCEDURE

- 1 Turn off the power for the signal sources that are connected to the projector.**

Check that the power for all connected components has been turned off.

- 2 Press the [Power] button.**

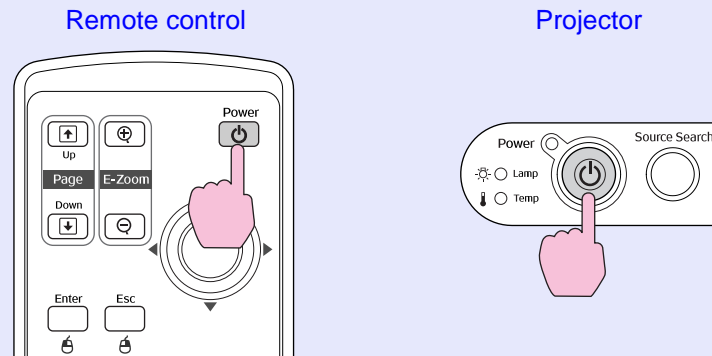

The following confirmation message will appear.

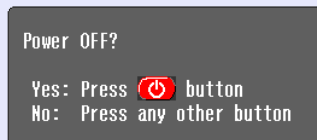

If you do not want to turn the power off, press any button except the [Power], [Page down], [Page up] and [Num] button. If you do not press any button, the message will disappear automatically after seven seconds. (The power will not turn off at this time.)

CAUTION

If the message "The projector is over heating. Make sure nothing is blocking the air vent, and clean or replace the air filter." appears on the screen, press the [Enter] button on either the projector's control panel or on the remote control to turn the power the air filters.

 [p.84](#)

- 3 Press the [Power] button once more.**

The lamp will switch off. The Power indicator will flash orange and [cool-down](#) will start.

The cool-down period lasts for about 20 seconds.

When the cool-down is complete, a "pip-pip" confirmation buzzer will sound, and the Power indicator will change to light orange.

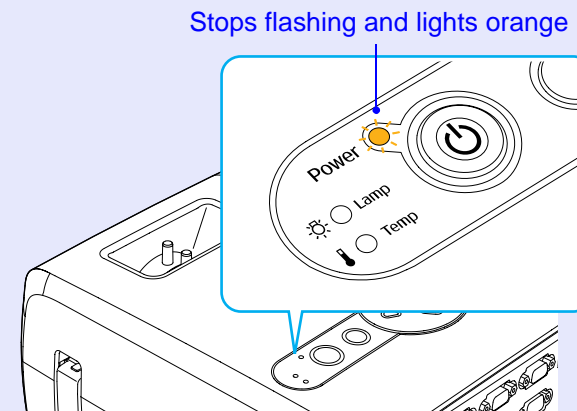



TIP

- *If the Power indicator is flashing orange, operation of the [Power] buttons is disabled. Wait until the indicator lights continuously.*
- *If "Standby Mode" in the configuration menu is set to "Network ON", fans will continue operating. This is normal and does not indicate a problem.*

4

If not using the projector for a long period, unplug the power cable from the electrical outlet.



CAUTION

Do not disconnect the power cable from the outlet while the Power indicator is still flashing orange, otherwise it may result in errors in projector operation and reduce the lamp unit operating life.

5

Attach the lens cover.

Attach the lens cover to the lens when not using the projector, in order to prevent the lens from getting dusty or dirty.

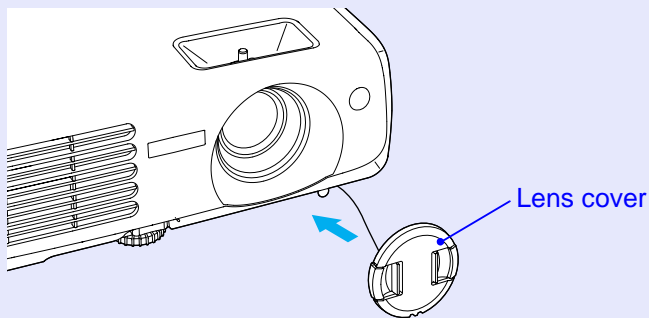

These functions correct and adjust the projected images so that optimum images can be obtained.

Adjusting the Image Size (Zoom Function)

The size of the projected image is basically determined by the distance from the projector to the screen.  [p.16](#)

The following procedures explain how to adjust the screen image once the projector itself has been set up.

**TIP**

The E-Zoom function lets you enlarge parts of the image.  [p.48](#)

PROCEDURE

Adjust by turning the zoom ring.

The maximum zoom ratio of the EMP-821 is $\times 1.6$, and that of the EMP-81/61 is $\times 1.2$.

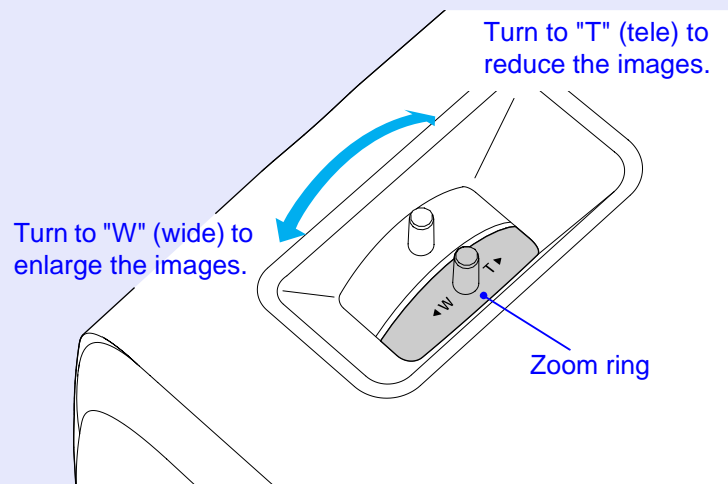

If you would like to enlarge the image further, move the projector further away from the screen.  [p.16](#)



Focusing the Screen Image

PROCEDURE

Turn the focus ring to adjust the image focus.

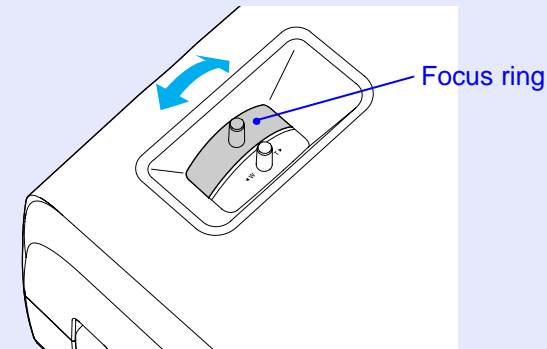
If keystone correction or Sharpness settings have been made, it may not be possible to adjust the focus correctly.

**TIP**

- *If the surface of the lens is dirty or misted over as a result of condensation, it may not be possible to adjust the focus correctly. If this happens, clean or de-mist the lens.*  [p.77, p.84](#)
- *If the distance from the lens to the screen is not within the recommended distance, it is impossible to bring the lens into focus. If you have trouble obtaining the correct focus, check the projection distance.*  [p.16](#)

Adjusting the Image Angle and Automatic Keystone Correction Function

The projector should be set up so that it is as perpendicular to the screen as possible.

Seen from the side

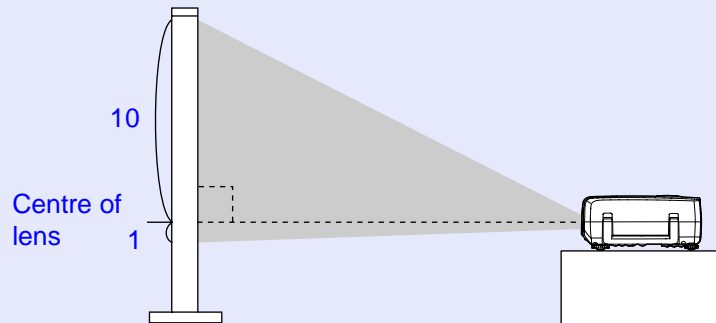

Seen from above

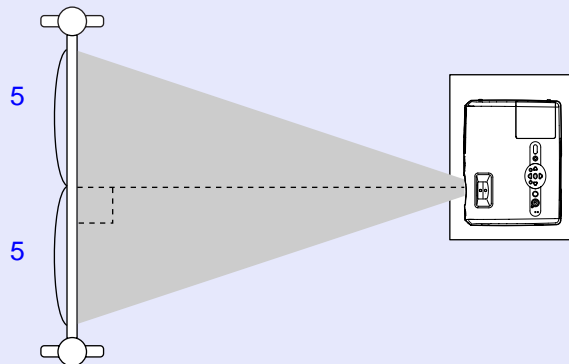

If it is not possible to set up the projector so that it is perpendicular to the screen, it can be set up at a slight vertical angle instead. You can adjust the upward projection angle of the projector to a maximum of 12° and the downward projection angle to a maximum of 4° by extending and retracting the front adjustable foot and rear adjustable feet.



CAUTION

Do not tilt the projector at more than the maximum angle. Doing so may cause the projector to fall down or fall off a desk and may result in injury.



PROCEDURE

While pulling the foot adjust lever at the front of the projector, lift up the front of the projector to extend the front adjustable foot.

Extend the front adjustable foot until the desired angle is obtained, and then release the foot adjust lever.

To retract the front adjustable foot, gently push down on the projector while pulling the foot adjust lever.

Foot adjust lever (Front)

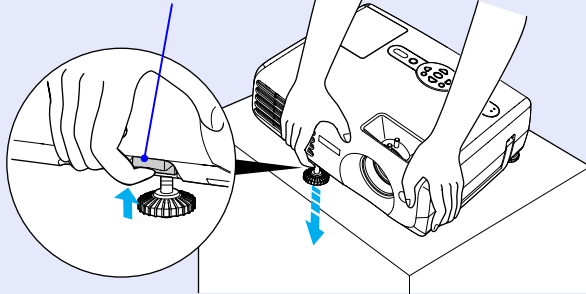

TIP

If the projector is tilted vertically or horizontally, turn the bases of the rear adjustable feet to make fine adjustments to the height of the projector. When the projector is tilted horizontally, the correction may not be carried out correctly. [p.38](#)

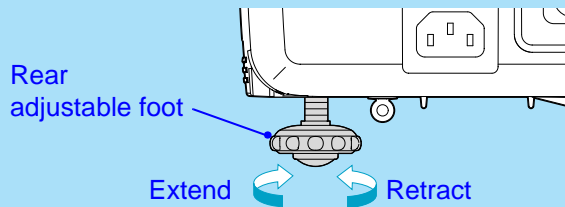

When the projector is tilted vertically, it will cause keystone distortion to appear in the image. However, the projector is equipped with an automatic keystone correction function that can automatically correct this keystone distortion as long as the vertical angle of tilt is within a range of approximately 15°*. Automatic keystone correction is carried out approximately one second after the projector is tilted vertically while the power is on.

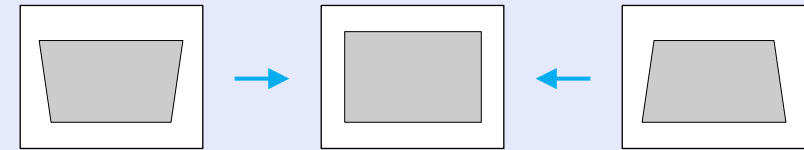

* This value applies when the zoom ring is turned to the maximum "T" setting. If the zoom ring is turned to the "W" setting, the available angle of tilt for automatic adjustment will be less.

TIP

- Automatic keystone correction is not carried out when the "Projection" command in the "Extended" menu is set to "Front".
- If you would like to make further fine adjustments after automatic keystone correction has been carried out, press the [▽] and [△] buttons on the projector's control panel. [p.39](#)
- When keystone correction is carried out, the projected image will become smaller.
- If the images become uneven in appearance after keystone correction is carried out, decrease the sharpness setting. [p.51, p.53](#)
- If automatic keystone correction is not required, set "Auto Keystone" in the "Setting" menu to "OFF". [p.59](#)



Manually Correcting Keystone Distortion

The projector is provided with an automatic keystone correction function which detects the vertical angle of the projector and carries out keystone correction automatically. If you would like to make further fine adjustments to the results of automatic keystone correction, press the [∇] and [\triangledown] buttons.

PROCEDURE

If the bottom of the image is elongated

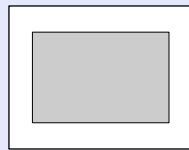
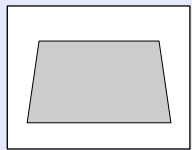

If the top of the image is elongated

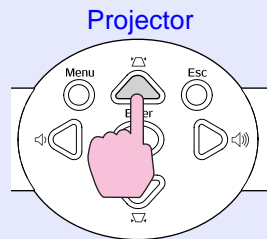
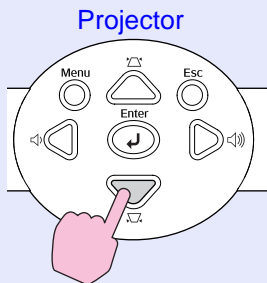
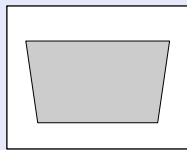

TIP

- When keystone correction is carried out, the projected image will become smaller.
- If the text part of the image is blurred after keystone correction is carried out, decrease the sharpness setting. [p.51](#), [p.53](#)
- Keystone correction can also be carried out using the configuration menu. [p.59](#)
- If the value displayed in the gauge on the screen stops changing when keystone correction is being carried out, it indicates that the limit for keystone correction has been reached. Check that the projector has not been set up at an angle which exceeds the proper limit.

The quality of the screen images can be adjusted as follows.

Adjusting Computer Images and RGB Video Images

Automatic Setup

Automatic setup detects analogue RGB signals coming from a connected computer, and automatically adjusts these signals so that the optimum images can be obtained.

Automatic setup involves adjustment of the following three items: [Tracking](#), Position and [Sync \(synchronisation\)](#).



TIP

- If "Auto Setup" in the "Signal" menu is set to "OFF" (the default setting for this item is "ON"), automatic setup is not carried out. In this case, press the [Auto] button on the remote control or the [Enter] button on the projector's control panel to make the adjustment while computer or RGB video images are being projected.

Remote control

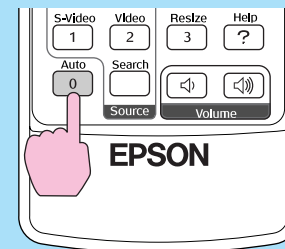

Projector

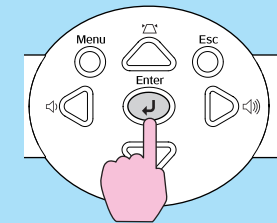

When you press the [Auto] button, the screen will turn to solid black colour for a moment and then return to a previous image. The auto adjustment is still in progress even after returning to the previous image. Wait about 3 seconds before pressing any other buttons.

- If you press the [Auto] button on the remote control while any of the following functions are in use, the function in use will be cancelled and then the adjustment will be carried out.

- E-Zoom function
- Configuration menu display
- Freeze function
- Help menu display

If you press the [Enter] button on the projector's control panel while any of the following functions are in use, the function in use will be cancelled and then the adjustment will be carried out.

- E-Zoom function
- Freeze function

- Sometimes the signals may not be adjusted correctly depending on the type of computer or RGB video signals being output. In such cases, use the configuration menu commands to adjust the tracking and sync settings manually. [p.41, p.42](#)

Adjusting the Tracking

If vertical stripes appear in the projected computer or RGB video images, and this cannot be fixed using automatic setup, you will need to adjust the [Tracking](#) manually using the following procedure.

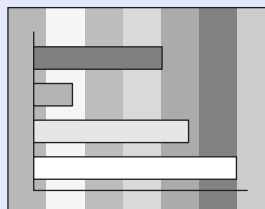

PROCEDURE

- 1 Press the [Menu] button on the remote control or the projector's control panel, and then select "Tracking" from the "Signal" configuration menu.

For details on this operation, refer to "Using the Configuration Menus".  p.66

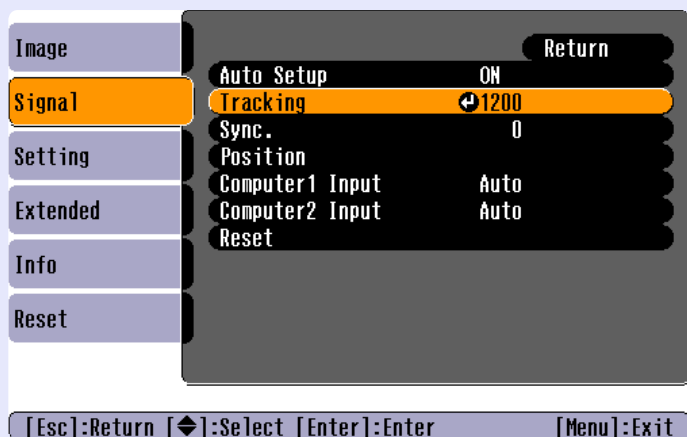

- 2 Tilt the [⊙] button on the remote control or press the [Left Arrow] and [Right Arrow] buttons on the projector's control panel to adjust the tracking value until the vertical stripes disappear from the images.

The tracking value increases or decreases each time a button is pressed.



- 3 After making the adjustment, press the [Menu] button to exit the configuration menu.



TIP

The image will flash when continuous tracking adjustment is carried out, but this is normal.

Adjusting the Sync

If flickering, fuzziness or interference appear in computer or RGB video images, and this cannot be fixed using automatic setup, you will need to adjust the [Sync \(synchronisation\)](#) manually using the following procedure.

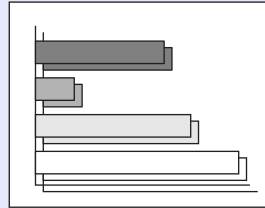

PROCEDURE

- 1 Press the [Menu] button on the remote control or the projector's control panel, and then select "Sync." from the "Signal" configuration menu.

For details on this operation, refer to "Using the Configuration Menus".  p.66

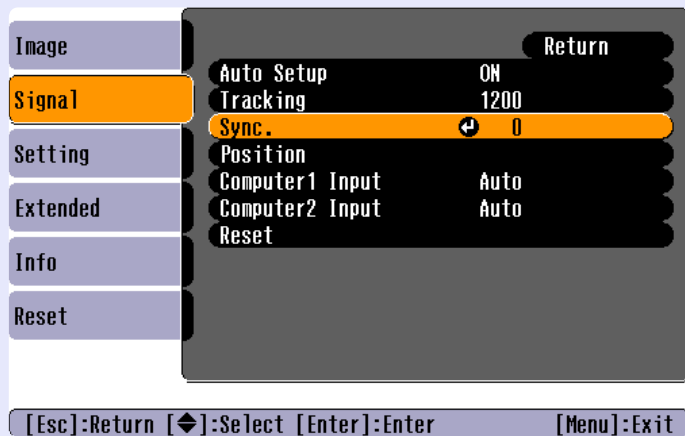

- 2 Tilt the [⊙] button on the remote control or press the [◀] and [▶] buttons on the projector's control panel to adjust the synchronisation value until the flickering, fuzziness or interference disappears from the images.

The sync value increases or decreases each time a button is pressed.

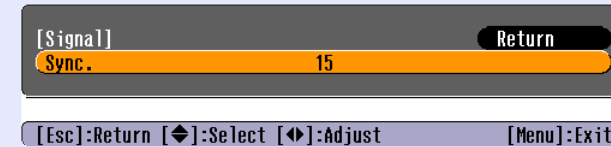

- 3 After making the adjustment, press the [Menu] button to exit the configuration menu.



TIP

- If you adjust the sync without adjusting the [tracking](#) first, it will not be possible to get the best adjustment results. Incorrect tracking adjustment may not be noticeable with some types of picture. However, pictures with lots of lines and shading will tend to show incorrect tracking adjustments more clearly, so be sure to check the tracking adjustment first.
- Flickering and fuzziness may also occur when the brightness, [contrast](#), sharpness and keystone correction settings are adjusted.

Selecting the Projection Quality (Colour Mode Selection)

The following six preset colour modes are available for use depending on the characteristics of the images that are being projected. You can easily obtain the optimum image quality simply by selecting the colour mode that corresponds to the projected images. The brightness of the images will vary depending on which colour mode is selected.

Mode	Application
Dynamic	Brightness is emphasised, so that images are fresher and have greater modulation than in Presentation mode.
Presentation	Brightness is emphasised to produce images that are ideal for presentations.
Theatre	Movie images are optimised using natural tints.
Living Room	Brightness is emphasised to produce images that are ideal for projecting TV images, etc. in bright rooms.
sRGB	Images conform to the sRGB colour standard. If the connected source has a sRGB mode, set both the projector and the connected signal source to sRGB.
Blackboard	Images with natural tints can be obtained when projecting onto a blackboard (green).

The default setting for the colour mode is as follows.
 When computer or RGB video images are being input: "Presentation"
 When other images are being input: "Dynamic"

PROCEDURE

The colour mode changes as follows each time the [Color Mode] button is pressed.

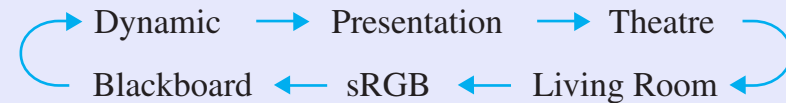

Remote control

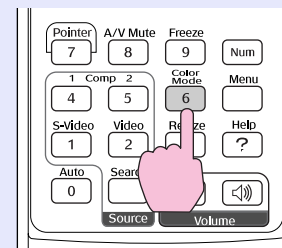

The current setting appears in the top-right corner of the screen each time the colour mode is changed.

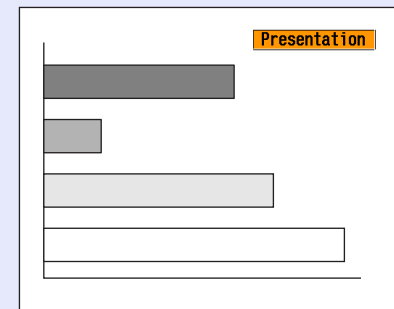

TIP

The colour mode can also be set using the "Color Mode" command in the "Image" menu. p.51, p.53

The volume of the projector's built-in speaker can be adjusted as follows.

PROCEDURE

Press the [Volume] buttons on the remote control or the [◀] and [▶] buttons on the projector's control panel to adjust the volume.

When the button is pressed to the [▶] side, the volume increases, and when it is pressed to the [◀] side, the volume decreases. The volume gauge appears on the screen when the volume is being adjusted.

Remote control

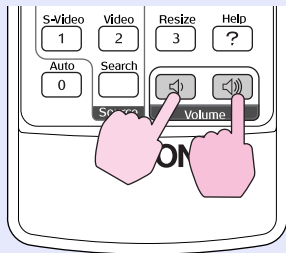

Projector

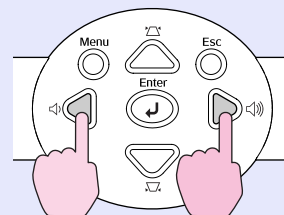

TIP

- If the value displayed in the gauge on the screen stops changing when the volume is being adjusted, it indicates that the limit for volume adjustment has been reached.
- Volume adjustments are stored separately for each input source.
- The volume can also be adjusted using the configuration menu.

☞ p.59

Advanced Operations

This chapter describes functions for enhancing the projection of images, and how to use the configuration menus.

Functions for Enhancing Projection	46
• A/V Mute.....	46
• Freeze	47
• Wide-screen Projection of Images from Video Equipment (Changing the Aspect Ratio)	47
• E-Zoom.....	48
• Pointer function	49

Using the Configuration Menu Functions.....	50
• List of Functions	51
• "Image" Menu	51
• "Signal" Menu	55
• "Setting" Menu	59
• "Extended" Menu	61
• "Info" Menu.....	64
• "Reset" Menu	65
• Using the Configuration Menus	66

This section describes the various useful functions that can be used to enhance presentations.

A/V Mute

This function momentarily pauses the image and sound.

For example, it can be used when you do not want to show details of operations such as selecting different files while computer images are being projected.

However, if you use this function when projecting moving images, the images and sound will still continue to be played back by the source, and you cannot return to the point where the mute function was activated.

PROCEDURE

Press the [A/V Mute] button.

The image and sound will then be paused.

Projection starts again when the [A/V Mute] button on the remote control is pressed.

You can also continue normal projection by pressing the [Esc] button.

Remote control

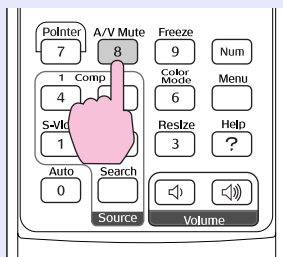

You can use the "Extended" - "Display" - "Background Color" menu setting to select the screen status when video and audio are paused from the following three options.  p.61

Solid black

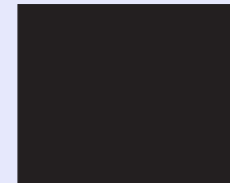

Solid blue



Default setting

User's logo

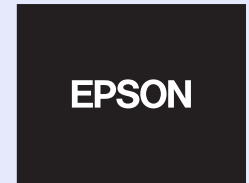

TIP

- *The default user's logo is the EPSON logo. To change the user's logo, you need to record your own logo.  p.90*
- *When the A/V Mute function is being used, the "Brightness Control" setting in the "Setting" menu will automatically change to "Low". When the A/V mute function is cancelled, the "Brightness Control" setting will return to the original setting.*

Freeze

This function pauses only the projected images. The sound keeps playing without pausing.

The image source will still be playing back the images even while projection is paused, and so it will not be possible to resume projection from the point where it was paused.

PROCEDURE

Press the [Freeze] button.

The images will then be paused.

To cancel the pause, press the [Freeze] button once more. You can also cancel it by pressing the [Esc] button.

Remote control

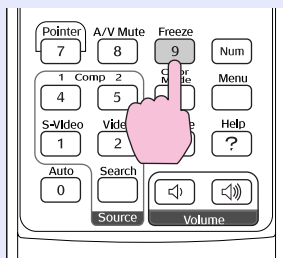

TIP

- Pressing the [Freeze] button also clears configuration menu displays and help messages.
- The freeze function still works while the E-Zoom function is being used.

Wide-screen Projection of Images from Video Equipment (Changing the Aspect Ratio)

This function changes the [aspect ratio](#) of images from 4:3 to 16:9 when [component video](#) images, [S-Video](#) or [composite video](#) images are being projected.

Images which have been recorded in digital video or onto DVDs can be viewed in 16:9 wide-screen format.

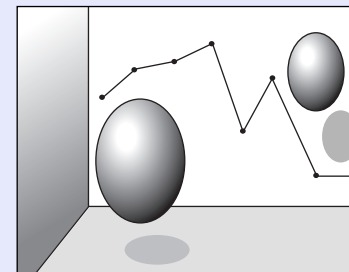

When images in [Squeeze mode](#) are projected at 4:3

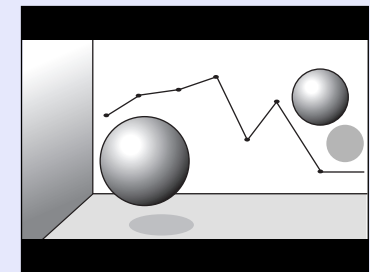

When images in [squeeze mode](#) are projected at 16:9

PROCEDURE

The aspect ratio changes each time the [Resize] button is pressed.

Remote control

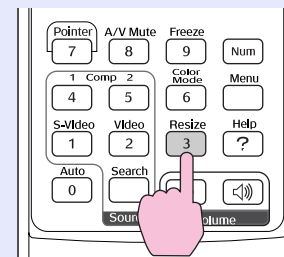

TIP

You can also make this setting using the "Resize" command in the "Signal" menu.

E-Zoom

This function lets you enlarge and reduce a part of projected images such as graphs and tables.

PROCEDURE

1 Press the [E-Zoom +] button.

A cursor (cross) indicating the centre point for the area to be enlarged will appear on the screen.

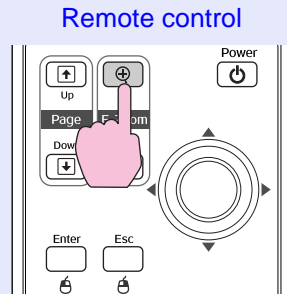

2 Move the cross to the area of the image that is to be enlarged or reduced.

Tilt the [⊙] button on the remote control to move the cross.

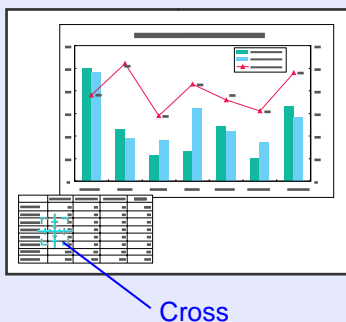

3

When the [⊕] button is pressed, the image is enlarged with the cross at its centre. When the [⊖] button is pressed, the enlarged image is then reduced.

The enlargement ratio will appear on the screen. You can scroll the screen by tilting the [⊙] button.

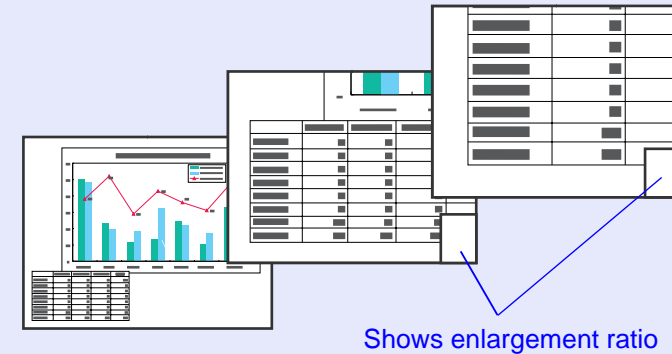

To cancel the E-Zoom, press the [Esc] button.



TIP

The selected area can be enlarged to between 1– 4 times, in 25 steps of $\times 0.125$.

Pointer function

This function lets you use the remote control to move a pointer icon around on the images being projected.

This function can be used to emphasise parts of an image that you want to draw attention to.

Use the remote control to carry out pointer function operations.



TIP

You can use the "Pointer Shape" command in the "Setting" menu to change the shape of the pointer to one of three different shapes.

☞ p.59

PROCEDURE

1 Press the [Pointer] button.

The pointer icon will appear in the middle of the projection area.

Remote control

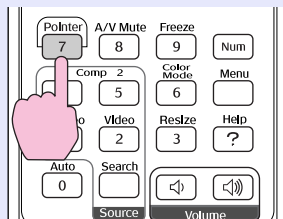

2 Tilt the [⊙] button to move the pointer icon.

To cancel the Effect function, press the [Pointer] button. The pointer icon will then disappear from the screen.

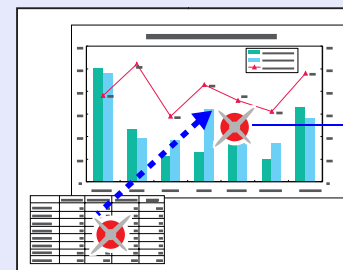

Pointer icon

The configuration menus can be used to carry out a variety of settings and adjustments.

The menus have a hierarchical structure, with a main menu that is divided into sub-menus, which are further divided into other sub-menus.

Refer to "Using the Configuration Menus"  p.66 for details on using the menus.

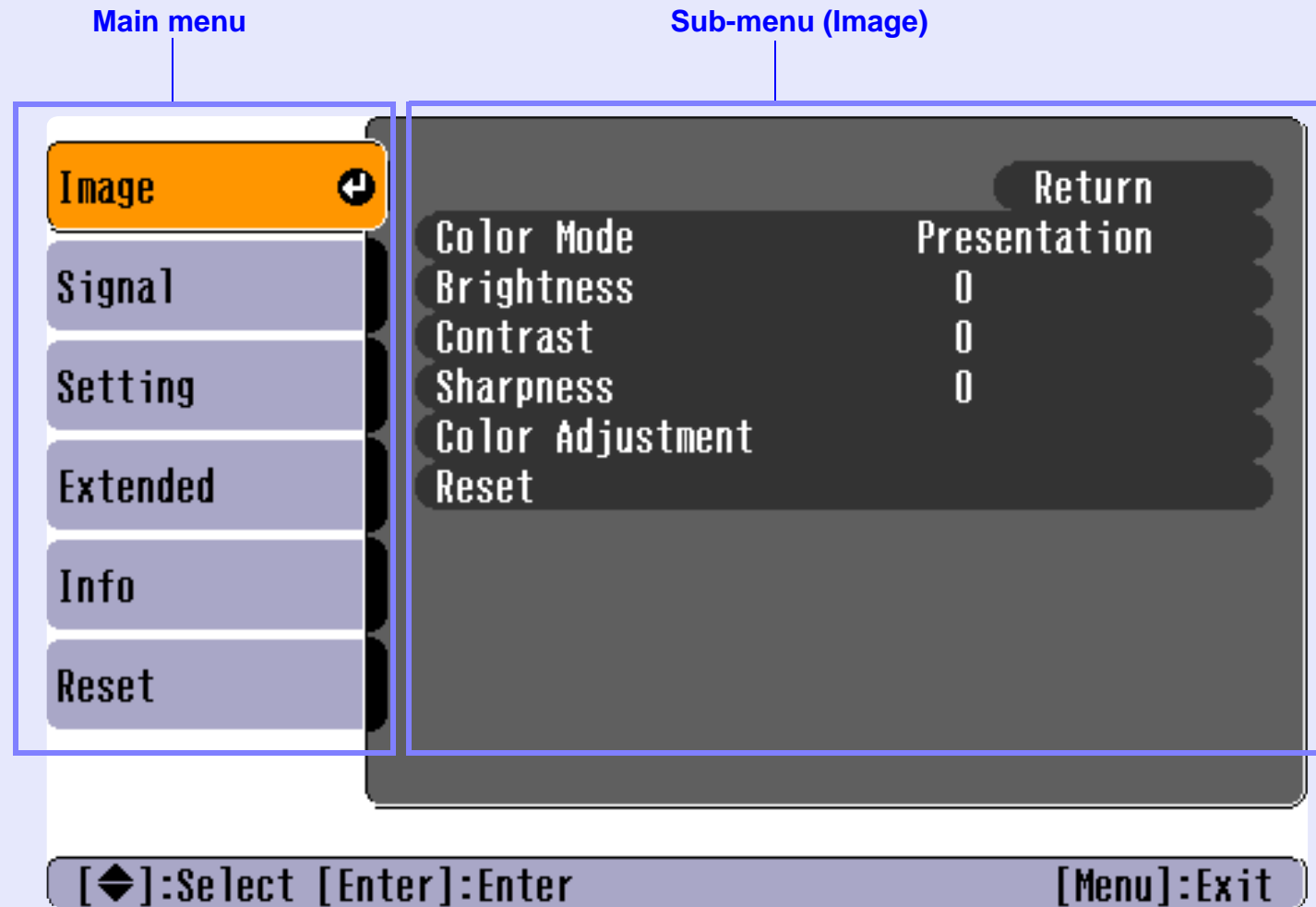

List of Functions

"Image" Menu

- None of the settings can be adjusted if no signals are being input.
- The commands displayed in the "Image" menu change depending on the input signal that is being projected. Menu commands that do not apply to the current input signal cannot be adjusted.

Computer/RGB video



Sub-menu	Function	Default
Color Mode	<p>Corrects the vividness of the image colour. The settings can be saved separately for each type of source (computer or video source). You can select from six different quality settings depending on the surroundings.</p> <ul style="list-style-type: none"> •Dynamic : Brightness is emphasised, so that images are fresher and have greater modulation than in Presentation mode. •Presentation : Brightness is emphasised to produce images that are ideal for presentations. •Theatre : Images are optimised using natural tints. It emphasises colour gradations (differences between light and dark) when projecting images that are very dark or very light and bright, to make such images easier to see. •Living Room: Brightness is emphasised to produce images that are ideal for projecting TV images, etc. in bright rooms. •sRGB : Images conform to the sRGB standard. If set to "sRGB", the Abs. Color Temp. for the "Color Adjustment" command in the "Image" menu will be set to 6500K. •Blackboard : Images with natural tints can be obtained when projecting onto a blackboard (green). 	Presentation
Brightness	Adjusts the image brightness.	Median value (0)
Contrast	Adjusts the difference between light and shade in the images.	Median value (0)
Sharpness	Adjusts the image sharpness.	Median value (0)



Sub-menu	Function	Default
Color Adjustment	<p>Adjusts the absolute colour temperature and the intensity of the red, green and blue components for each input source.</p> <p>Abs. Color Temp.▶:</p> <p>Lets you adjust bright colours within a range from reddish tinges to bluish tinges.</p> <p>If the colour temperature is lower, colours appear reddish and color tones appear softer.</p> <p>If the colour temperature is higher, colours appear bluish and colour tones appear sharper.</p> <p>Red: Adjust the intensity of the red components.</p> <p>Green: Adjusts the intensity of the green component.</p> <p>Blue: Adjusts the intensity of the blue component. (This item cannot be selected if "sRGB"▶ has been selected as the "Color Mode" setting in the "Image" menu.)</p>	<p>Abs. Color Temp.: 7500K</p> <p>Red: Median value (0)</p> <p>Green: Median value (0)</p> <p>Blue: Median value (0)</p>
Reset	<p>Resets all adjustment values for the "Image" menu functions to their default settings.</p> <ul style="list-style-type: none"> • Press the [Enter] button on the remote control or on the projector's control panel. • To return all settings such as the "Image" and "Signal" menu settings to their default values, select "Reset All" from the "Reset" menu.  p.65 	-



[Component video](#) / [Composite video](#) / [S-Video](#)



Sub-menu	Function	Default
Color Mode	<p>Corrects the vividness of the image colour. The settings can be saved separately for each type of source (computer or video source). You can select from six different quality settings depending on the surroundings.</p> <ul style="list-style-type: none"> •Dynamic : Brightness is emphasised, so that images are fresher and have greater modulation than in Presentation mode. •Presentation : Brightness is emphasised to produce images that are ideal for presentations. •Theatre : Images are optimised using natural tints. It emphasises colour gradations (differences between light and dark) when projecting images that are very dark or very light and bright, to make such images easier to see. •Living Room: Brightness is emphasised to produce images that are ideal for projecting TV images, etc. in bright rooms. •sRGB : Images conform to the sRGB standard. If set to "sRGB", the Abs. Color Temp. for the "Color Adjustment" command in the "Image" menu will be set to 6500K. •Blackboard : Images with natural tints can be obtained when projecting onto a blackboard (green). 	Dynamic
Brightness	Adjusts the image brightness.	Median value (0)
Contrast	Adjusts the difference between light and shade in the images.	Median value (0)
Color Intensity	Adjusts the colour intensity for the images.	Median value (0)
Tint	(Adjustment is only possible when component video or NTSC signals are being input.) Adjust the image tint.	Median value (0)
Sharpness	Adjusts the image sharpness.	Median value (0)



Sub-menu	Function	Default
Color Adjustment	<p>Adjusts the absolute colour temperature and the intensity of the red, green and blue components for each input source.</p> <p>Abs. Color Temp.▶:</p> <p>Lets you adjust bright colours within a range from reddish tinges to bluish tinges.</p> <p>If the colour temperature is lower, colours appear reddish and color tones appear softer.</p> <p>If the colour temperature is higher, colours appear bluish and colour tones appear sharper.</p> <p>Red: Adjust the intensity of the red components.</p> <p>Green: Adjusts the intensity of the green component.</p> <p>Blue: Adjusts the intensity of the blue component.</p> <p>(This item cannot be selected if "sRGB"▶ has been selected as the "Color Mode" setting in the "Image" menu.)</p>	<p>Abs. Color Temp.: 6500K</p> <p>Red: Median value (0)</p> <p>Green: Median value (0)</p> <p>Blue: Median value (0)</p>
Reset	<p>Resets all adjustment values for the "Image" menu functions to their default settings.</p> <ul style="list-style-type: none"> • Press the [Enter] button on the remote control or on the projector's control panel. • To return all settings such as the "Image" and "Signal" menu settings to their default values, select "Reset All" from the "Reset" menu.  p.65 	-



"Signal" Menu

- The "[Tracking](#)", "[Sync.](#)", "Position" and "Resize" settings can not be adjusted if no signals are being input.
- The items displayed in the "Signal" menu change depending on the input signal that is being projected. Menu commands that do not apply to the current input signal cannot be adjusted.

Computer/RGB video

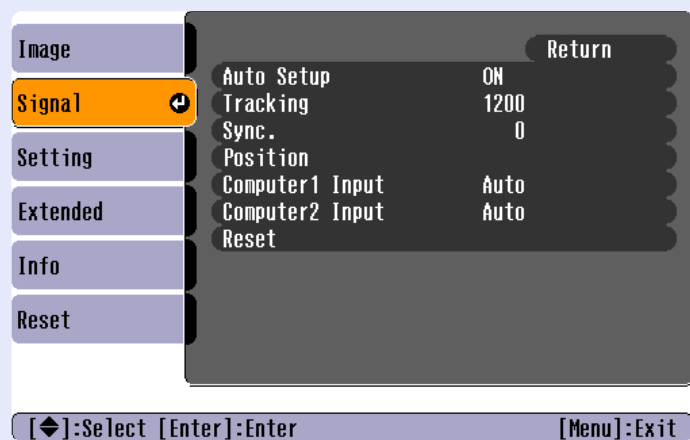

Sub-menu	Function	Default
Auto Setup	Selects whether the automatic adjustment function for automatically optimising images when the input source is changed is turned "ON" or "OFF".	ON
Tracking	Adjusts computer images when vertical stripes appear in the images.	Depends on connection
Sync.	Adjusts computer images when flickering, fuzziness or interference appear in the images. <ul style="list-style-type: none"> •Flickering and fuzziness may also appear when the brightness, contrast, sharpness or keystone settings are adjusted. •You can obtain the best results if you adjust the tracking first and then adjust the sync. 	Depends on connection
Position	Moves the image display position vertically and horizontally. <ul style="list-style-type: none"> •Press the [Enter] button on the remote control or on the projector's control panel and then make the adjustment using the display position adjustment screen that appears. 	Depends on connection
Computer1 Input	Selects the input signal in accordance with the equipment that is connected to the [Computer1/Component Video1] port. If set to "Auto" the input signal is set automatically in accordance with the connected equipment. If you select "Auto", and the colours appear unnatural, select "Computer1".	Auto
Computer2 Input	Selects the input signal in accordance with the equipment that is connected to the [Computer2/Component Video2] port. If set to "Auto" the input signal is set automatically in accordance with the connected equipment. If you select "Auto", and the colours appear unnatural, select "Computer2".	Auto



Sub-menu	Function	Default
Reset	<p>Reset all adjustment values for the "Signal" menu functions to their default settings except for "Computer1 Input" and "Computer2 Input".</p> <ul style="list-style-type: none">• Press the [Enter] button on the remote control or on the projector's control panel.• To return all settings such as the "Image" and "Signal" menu settings to their default values, select "Reset All" from the "Reset" menu.  p.65	-



Component video

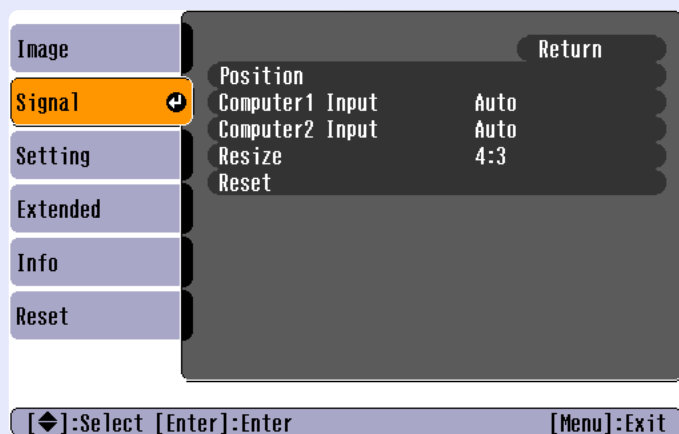

Composite video / S-Video

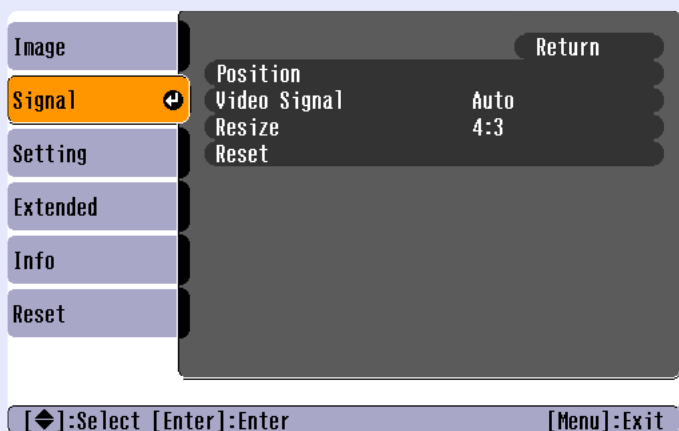

Sub-menu	Function	Default
Position	Moves the image display position vertically and horizontally. •Press the [Enter] button on the remote control or on the projector's control panel and then make the adjustment using the display position adjustment screen that appears.	Depends on connection
Computer1 Input	(Adjustment is only possible when component video signals are being input.) Selects the input signal in accordance with the equipment that is connected to the [Computer1/Component Video1] port. If set to "Auto" the input signal is set automatically in accordance with the connected equipment. If you select "Auto", and the colours appear unnatural, select "Component Video1".	Auto
Computer2 Input	(Adjustment is only possible when component video signals are being input.) Selects the input signal in accordance with the equipment that is connected to the [Computer2/Component Video2] port. If set to "Auto" the input signal is set automatically in accordance with the connected equipment. If you select "Auto", and the colours appear unnatural, select "Component Video2".	Auto
Video Signal	(Adjustment is only possible when composite video/S-Video signals are being input.) Sets the video signal format. •Press the [Enter] button on the remote control or on the projector's control panel and then make the selection from the video signal format selection menu that appears. •When set to "Auto", the video signal format is set automatically.	Auto
Resize	Sets the aspect ratio for projected images.	Depends on connection





Sub-menu	Function	Default
Reset	Returns "Position", "Video Signal" and "Resize" in the "Signal" menu to their default setting. <ul style="list-style-type: none">• Press the [Enter] button on the remote control or on the projector's control panel.• To return all settings such as the "Image" and "Signal" menu settings to their default values, select "Reset All" from the "Reset" menu.  p.65	-

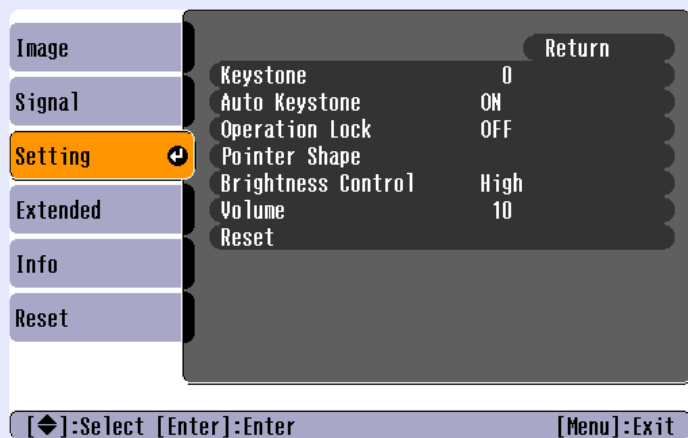

"Setting" Menu



Sub-menu	Function	Default
Keystone	<p>Corrects vertical keystone distortion in images.</p> <ul style="list-style-type: none"> •When keystone correction is carried out, the projected image will become smaller. •If the images become uneven in appearance after keystone correction is carried out, decrease the sharpness setting. 	Median value (0)
Auto Keystone	<p>Sets the function for automatically detecting the projector angle and correcting keystone "ON" or "OFF" when the projector is tilted vertically.</p> <p>This function is only enabled when the "Projection" command in the "Extended" menu is set to "Front". If it is set to something other than "Front", this menu cannot be selected.</p>	ON
Operation Lock	<p>When set to "ON", the operation of all buttons on the projector's control panel except for the [Power] button will be disabled.</p> <ul style="list-style-type: none"> •When "Operation Lock" is set to "ON", the operation lock function can be cancelled by holding down the [Enter] button on the projector's control panel for approximately 7 seconds. •If you change the setting, the new setting will take effect after exiting the configuration menu. 	OFF
Pointer Shape	<p>The shape of the pointer icon that appears when you press the [Pointer] button on the remote control can be selected from the following three shapes.</p> <p>Pointer 1:  Pointer 2:  Pointer 3: </p>	Pointer 1
Brightness Control	<p>This lets you set the lamp brightness to one of two settings. Select "Low" if the images being projected are too bright such as when projecting images in a dark room or onto a small screen.</p> <p>When "Low" is selected, the brightness of the images is reduced, the amount of electricity consumed and noise produced during projection are reduced and the lamp's operating life is extended.</p>	High
Volume	Adjusts the volume.	Median value (10)



Sub-menu	Function	Default
Reset	Resets all adjustment values for the "Setting" menu functions to their default settings. <ul style="list-style-type: none">• Press the [Enter] button on the remote control or on the projector's control panel.• To return all settings such as the "Image" and "Signal" menu settings to their default values, select "Reset All" from the "Reset" menu.  p.65	-



"Extended" Menu

- The "User's Logo" setting can not be adjusted if no signals are being input.

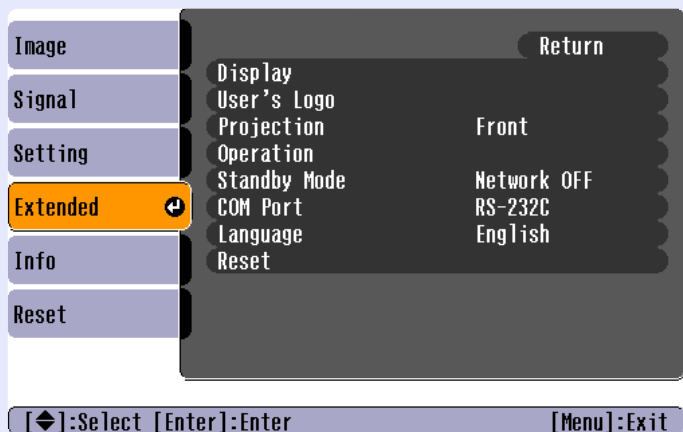

Sub-menu	Function	Default
Display	<p>This lets you make settings related to the projector's display.</p> <p>Message: Sets whether display of the following messages is turned "ON" or "OFF".</p> <ul style="list-style-type: none"> Signal name when the video signal is switched Colour mode name when the colour mode is switched When no image signals are being input When an incompatible signal is input When the air filter needs replacing <p>Background Color: Sets the screen status when the [A/V Mute] button on the remote control is being pressed or when no image signals are being input to "Black", "Blue" or "Logo".</p> <ul style="list-style-type: none"> To change the user's logo, you need to record your own logo. p.90 If the "User's Logo Protect" function of Password Protect has been set to "ON", the "Logo" setting cannot be changed from "Logo" to "Black" or "Blue", or from "Black" or "Blue" to "Logo". Cancel the Password Protect function before changing these settings. p.29 <p>Startup Screen: Sets whether the startup screen is displayed or not. To change the user's logo, you need to record your own user's logo. p.90 This cannot be changed from enabled ("ON") to disabled ("OFF") if the "User's Logo Protect" function of Password Protect has been set to "ON". Cancel the Password Protect function before changing the setting. p.29</p>	<p>Message: ON</p> <p>Background Color: Blue</p> <p>Startup Screen: ON</p>
User's Logo	<p>Records a user's logo. p.90</p> <ul style="list-style-type: none"> Press the [Enter] button on the remote control or on the projector's control panel and then follow the instructions that appear on the screen. A user's logo cannot be recorded if the "User's Logo Protect" function of Password Protect has been set to "ON". Cancel the Password Protect function before recording a user's logo. p.29 	EPSON logo

* EMP Monitor : Allows you to monitor multiple projectors on the network and control them all at once using functions such as turning the power on and off and switching input sources.

To use the EMP Monitor, an adapter and cable for conversion are required. The followings are available products.

(As of May, 2004)

For details on the products, visit LANTRONIX's website.

Adapters:

UDS100, UDS200 (LANTRONIX)

Cables:

For the UDS100



RS-232C cable (straight, mini D-Sub9pin female/mini D-Sub25pin male)

For the UDS200

RS-232C cable (cross, mini D-Sub9pin female/mini D-Sub9pin female)

For the detailed and current information about the software, please visit the following website.

<http://www.epson.co.uk/support/download/>

Sub-menu	Function	Default
Standby Mode	Set to "Network ON" to use network monitoring and control functions and the standby monitor out function while the projector is in standby mode. If you change the setting, the new setting will be enabled after the power is turned off. <ul style="list-style-type: none"> •We provide softwares* for network monitoring and controlling projectors. •When set to "Network ON", the Power indicator will flash orange and then remain orange after disconnecting the power plug and reinserting it into the electrical outlet. 	Network OFF
COM Port	This can be set to either "RS-232C" or "USB", depending on the port that is being used for communication with a computer. If you change the setting, the new setting will be enabled after the power is turned off.	RS-232C
Language	Sets the language for message displays. <ul style="list-style-type: none"> •Press the [Enter] button on the remote control or on the projector's control panel and then make the selection. 	English (Varies depending on country of purchase)
Reset	Returns "Display" and "Operation" settings in the "Extended" menu to their default settings. However, if "Background Color" has been set to "Logo" or if "Startup Screen" has been set to "OFF", the settings will not be returned to their defaults if "User's Logo Protect" is set to "ON".  p.29 <ul style="list-style-type: none"> •Press the [Enter] button on the remote control or on the projector's control panel. •To return all settings such as the "Image" and "Signal" menu settings to their default values, select "Reset All" from the "Reset" menu.  p.65 	-



"Info" Menu

- The "Info" menu shows the setting details for the current image source.
- The "Lamp Hours" item appears as 0H for 0–10 hours, and after that, it appears in units of 1 hour.

Computer/RGB Video/[Component video](#)

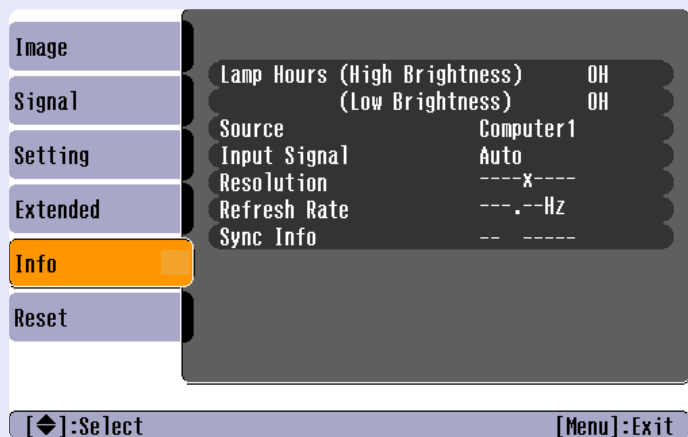

[Composite video](#) / [S-Video](#)

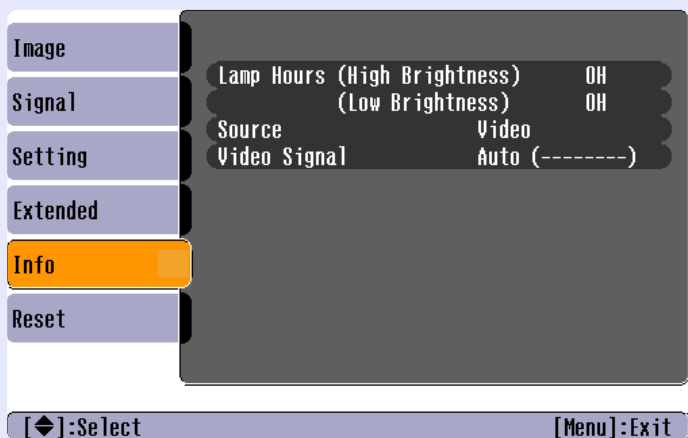

Sub-menu	Function	Default
Lamp Hours	Displays the cumulative lamp operating time for both "High Brightness" and "Low Brightness". •When the lamp warning period is reached, the display characters appear in red.	0H
Source	Displays the input source which is currently being projected.	
Input Signal	Displays the input signal settings. (Does not appear when the input source is composite video or S-video.)	
Resolution	Displays the input resolution. (Does not appear when the input source is composite video or S-video.)	-
Video Signal	Shows the video signal format. (Not displayed for computer, RGB video or component video images)	-
Refresh Rate	Displays the refresh rate. (Does not appear when the input source is composite video or S-video.)	-
Sync. Info	Informations in this menu may be required in case that you ask for service to your dealer or the nearest address provided at "International Warranty Conditions" section of the <i>Safety Instructions/World Wide Warranty Terms</i> booklet. (Does not appear when the input source is composite video or S-video.)	-

"Reset" Menu



Sub-menu	Function	Default
Reset All	<p>Resets all items in all menus to their default settings.</p> <ul style="list-style-type: none"> • Press the [Enter] button on the remote control or on the projector's control panel. • To reset settings such as "Image" or "Signal", select "Reset" from the respective sub menus. • The "Computer1 Input", "Computer2 Input", "Video Signal", "User's Logo", "Lamp Hours" and "Language" settings will not be reset to their defaults. However, if "Background Color" is set to "Logo" or "Startup Screen" is set to "OFF", these settings will not be returned to their defaults when "User's Logo Protect" is set to "ON". <p> p.29</p>	-
Lamp-Hours Reset	Initialises the lamp operating time. When this command is selected, the cumulative lamp operating time is reset to the initial default value.	-

Using the Configuration Menus

The configuration menus can be operated using either the remote control or the projector's control panel.



PROCEDURE

1 Press the [Menu] button.

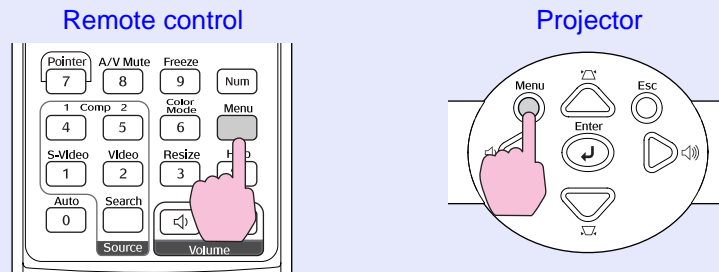
The configuration menu appears.



2 Select a menu item.

Tilt the [] button on the remote control up and down or press the [] and [] buttons on the projector's control panel to move to the item to be set.

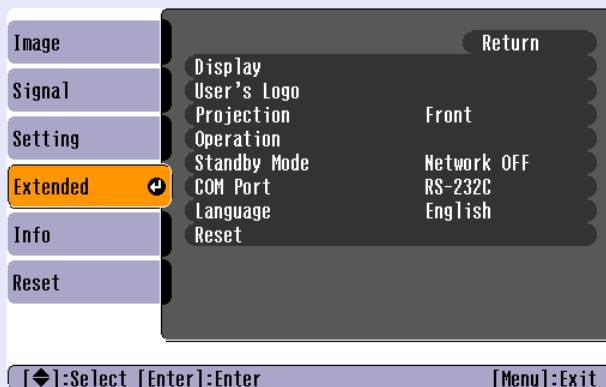

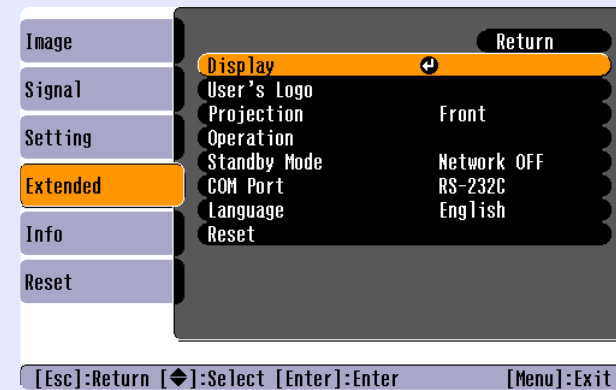

3 Confirm the selection.

Press the [Enter] button to confirm the selection of a menu item.







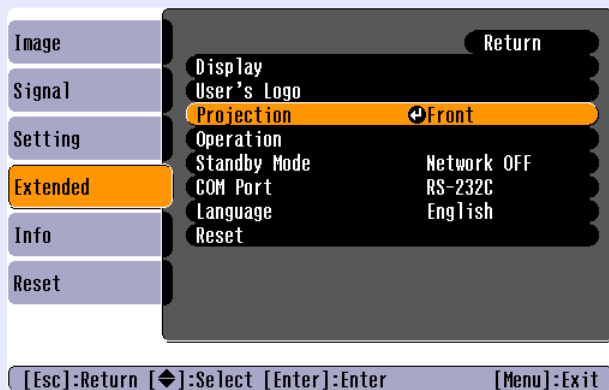

4 Select a sub-menu item.

Tilt the [] button on the remote control up and down or press the [] and [] buttons on the projector's control panel to move to the sub-item to be set, and then press the [Enter] button.

The items that are displayed in the "Image" menu, "Signal" menu and "Info" menu vary depending on the input source that is being projected.



5 Change the setting.

- Tilt the [] button on the remote control or press the [], [], [] and [] buttons on the projector's control panel to change the setting.
 - : Current setting value
 - : Currently-selected setting item
- If you press the [Enter] button when at items with a  displayed, the setting screen for that item will be displayed. After making the setting, press the [Enter] button to accept the setting. The ● will change to green.

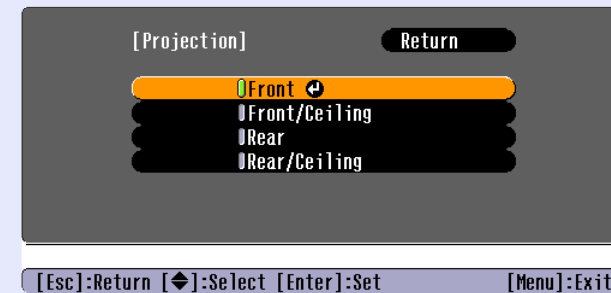

6 Close the menu.

Press the [Menu] button.



TIP

Refer to "List of Functions" for details on the functions of each menu item.  p.51

Troubleshooting

This chapter describes how to identify problems and what to do if a problem is found.

Using the Help	69
Problems Solving	71
• Abnormal	71
• Reading the Indicators	71
• Power indicator lights red	71
• Warning.....	72
• Lamp or Temp indicator flashes orange	72
• Normal	73
• Power indicator lights green or orange/ flashes green or orange	73
• When the Indicators Provide No Help	74
• Problems relating to images	75
• Problems when projection starts	81
• Other problems	82

If a problem occurs with the projector, the Help function uses on-screen displays to assist you in solving the problem. It uses a series of menus in a question and answer format.

PROCEDURE

1 Press the [Help] button.

The help menu will be displayed.

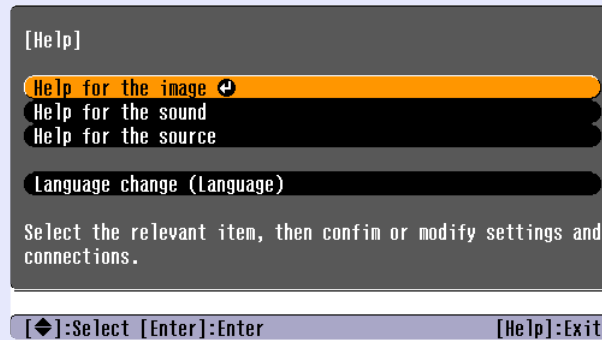
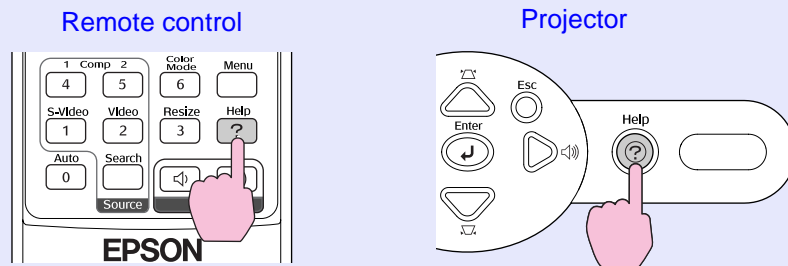

2 Select a menu item.

Tilt the [◀] button on the remote control or press the [△] and [▽] buttons on the projector's control panel to select an item.

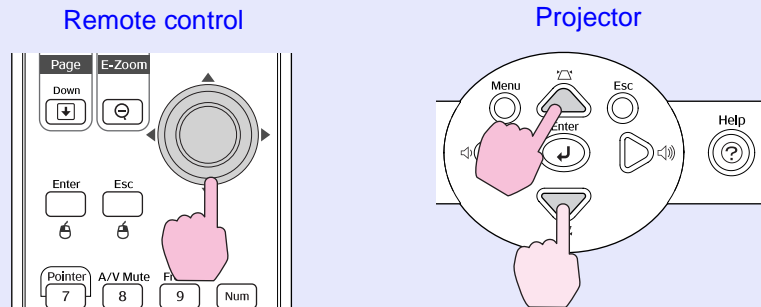

3 Confirm the selection.

Press the [Enter] button to confirm the selection of a menu item.

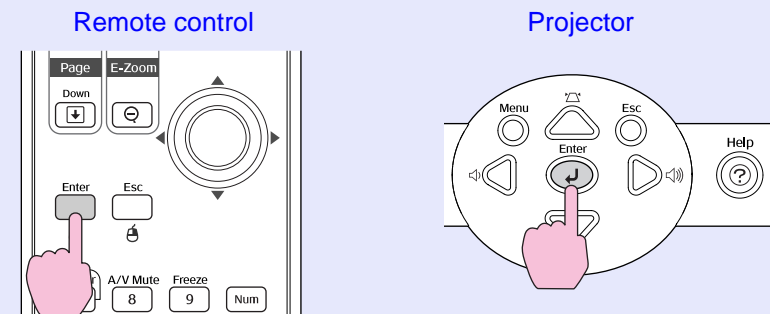

- 4** Repeat the operations in steps 2 and 3 to proceed through the menu to more detailed items.

The help menu is cleared when the [Help] button is pressed.

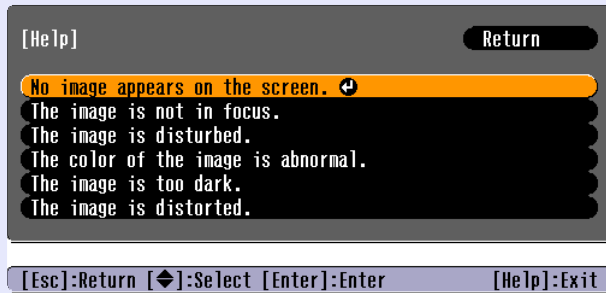
**TIP**

If the Help function does not provide a solution to the problem, refer to "Problem Solving"  [p.71](#)



If you are having a problem with the projector, first check the projector's indicators and refer to "Reading the Indicators" below. If the indicators do not show clearly what the problem might be, refer to "When the Indicators Provide No Help". p.74

Reading the Indicators

The projector is provided with the following three indicators which indicate the operating status of the projector.

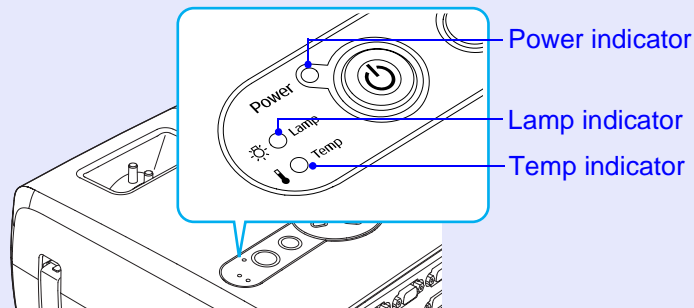

The following tables show what the indicators mean and how to remedy problems that they indicate. If all indicators are switched off, check that the power cable is connected correctly and that power is being supplied normally.

■ Power indicator lights red **Abnormal**

● : lit : flashing ○ : off

Status	Cause	Remedy or Status
Power ● Red Red Red	Internal error	Stop using the projector, disconnect the power cable from the electrical outlet, and contact your dealer or the nearest address provided in the "International Warranty Conditions" section of the <i>Safety Instructions/World-Wide Warranty Terms</i> booklet.
Power ● Red ○ Red	Fan related error/ Sensor error	Stop using the projector, disconnect the power cable from the electrical outlet, and contact your dealer or the nearest address provided in the "International Warranty Conditions" section of the <i>Safety Instructions/World-Wide Warranty Terms</i> booklet.



● : lit ☀ : flashing ○ : off

Status	Cause	Remedy or Status
Power ● Red ☀ ○ 🌡 ● Red	Internal temperature error (overheating)	The lamp will turn off automatically and projection will stop. Wait for about 5 minutes. After about 5 minutes the projector will switch to standby mode, so check the following two points. After checking, press the [Power] button to turn the power back on. •Check that the air filter and air exhaust vent are clear, and that the projector is not positioned against a wall. 🖱 p.17 •If the air filters are blocked, clean or replace them. 🖱 p.84, p.89 If this does not solve the problem and the projector continues to overheat or the indicators continue to show a problem when the power is turned on, stop using the projector, disconnect the power cable from the wall outlet, and contact your dealer or the nearest address provided in the "International Warranty Conditions" section of the <i>Safety Instructions/World-Wide Warranty Terms</i> booklet.
Power ● Red ☀ ● Red 🌡 ○	Lamp timer failure/ Lamp out	Take out the lamp and check if it is broken. 🖱 p.86 If the lamp is not broken, put it back in and then turn the power on. If the lamp still does not turn on, replace it with a new lamp. If this does not solve the problem, stop using the projector and disconnect the power cable from the electrical outlet. Then contact your dealer or the nearest address provided in the "International Warranty Conditions" section of the <i>Safety Instructions/World-Wide Warranty Terms</i> booklet If the lamp is broken replace it with a new lamp, or contact your local dealer for further advice. If replacing the lamp yourself, be careful to avoid pieces of broken glass. (Projection cannot be carried out until the lamp is replaced.) Check that the lamp and the lamp cover are securely installed. If the lamp or lamp cover is not securely installed, the lamp will not switch on.

■ Lamp or Temp indicator flashes orange **Warning**

● : lit ☀ : flashing ○ : off

Status	Cause	Remedy or Status
Power ● Red ☀ ○ 🌡 ☀ Orange	High-speed cooling in progress	(This is not an abnormality, but if the temperature rises too high again, projection will stop automatically.) •Check that the air filters and air exhaust vent are clear and that they are not up against a surface such as a wall. 🖱 p.17 •If the air filters are clogged, clean or replace them. 🖱 p.84, p.89



● : lit ☀ : flashing ○ : off

Status	Cause	Remedy or Status
Power ● ☀ Orange 🌡 ○	Lamp replacement notification	Replace the lamp with a new one. p.86 If you continue to use the lamp after it has passed the replacement period, the possibility that the lamp may break will increase. Replace the lamp with a new one as soon as possible. The Power indicator status will vary depending on the projector status at the time.

■ Power indicator lights green or orange/ flashes green or orange **Normal**

● : lit ☀ : flashing ○ : off

Status	Cause	Remedy or Status
Power ● Orange ☀ ○ 🌡 ○	Standby condition	Projection starts again when the [Power] button is pressed. You can disconnect the power plug from the electrical outlet when the status light is in this condition.
Power ● Green ☀ ○ 🌡 ○	Warm-up in progress	Warm-up time is approximately 40 seconds. After warm-up is complete, the indicator stops flashing.
Power ● Green ☀ ○ 🌡 ○	Projection in progress	
Power ☀ Orange ☀ ○ 🌡 ○	Cool-down in progress	Please wait. <ul style="list-style-type: none"> •The cool-down period lasts about 20 seconds. •The [Power] button will not operate if it is pressed while cool-down is in progress. When the cool-down period is finished and the confirmation buzzer has sounded and the indicator changes to light orange, repeat the operation.



TIP











- If the projector is not operating properly even though the indicators are all showing normal, refer to "When the Indicators Provide No Help" on the following page.
- If an indicator is showing a status which does not appear in the previous tables, contact your dealer or the nearest address provided in the "International Warranty Conditions" section of the Safety Instructions/World-Wide Warranty Terms booklet.



When the Indicators Provide No Help

If any of the following problems occur and the indicators do not offer a solution, refer to the pages given for each problem.



Problems relating to images

- No images appear  [p.75](#)
Projection does not start, the projection area is completely black, the projection area is completely blue, etc.
- Can not switch projection to a video source by pressing the [Source Search] button  [p.75](#)
- Projection stops automatically  [p.76](#)
- The message "Not Supported." is displayed  [p.76](#)
- The message "No Signal." is displayed  [p.77](#)
- Images are fuzzy or out of focus  [p.77](#)
- Interference or distortion appear in images  [p.78](#)
Problems such as interference, distortion or black & white checked patterns appear.
- Image is truncated (large) or small  [p.79](#)
Only part of the image is displayed.
- Image colours are not right  [p.80](#)
The whole image appears purplish or greenish, images are black & white, colours appear dull, etc.
(Computer monitors and LCD screens have different colour reproduction performance, so that the colours projected by the projector and the colours appearing on the monitor may not necessarily match, but this is not a sign of a problem.)
- Images appear dark  [p.81](#)
- Nothing appears on the external monitor  [p.81](#)

Problems when projection starts

- Power does not turn on  [p.81](#)



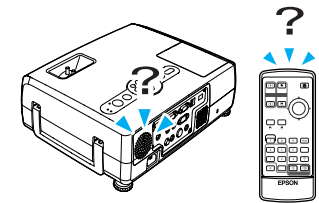

Other problems

- No sound can be heard or the sound is faint  [p.82](#)
- The remote control does not work  [p.82](#)
- The fans do not stop when power is turned off  [p.82](#)



■ Problems relating to images

■ No images appear

Check	Remedy
Was the [Power] button pressed?	Press the [Power] button to turn the power on.
Are both indicators switched off?	The power cable is not connected correctly or power is not being supplied normally. Connect the projector's power cable correctly.  p.31 Check that your power supply socket is working.
Is A/V Mute mode active?	Press the [A/V Mute] button on the remote control to cancel the mute.  p.46
Has "Message" been set to "OFF"?	If the "Message" command is set to "OFF", set it to "ON" so that messages can be displayed. When a message is displayed, refer to the item that it indicates. "Extended" - "Display" - "Message"  p.61
Have the configuration menu settings been made correctly?	Reset all of the settings. "Reset" - "Reset All"  p.65
Is the projected image completely black? Only when projecting computer images	Some input images, such as screen savers, may be completely black.
Are the image signal format settings correct? Only when projecting images from a video source	If a composite video or S-Video source is connected to the projector, use the "Video Signal" menu command to select the signal format. "Signal" - "Video Signal"  p.57



■ Can not switch projection to a video source by pressing the [Source Search] button

Check	Remedy
Is the image signal output from the video equipment? Only when projecting images from a video source	Press the [Play] button of the video equipment. Or press one of the source buttons on the remote control ([Computer1], [Computer2], [S-Video] or [Video] button) to switch to the desired source.

■ Projection stops automatically

Check	Remedy
<p>Is "Sleep Mode" set to "ON"?</p>	<p>When the "Sleep Mode" menu command has been set to "ON", the lamp turns off automatically if no operations are carried out for about 30 minutes while no video signal is being input. The Power indicator will flash orange at this time. Press the [Power] button to turn the power on. If you do not want sleep mode to be used, change the "Sleep Mode" setting to "OFF". "Extended" - "Operation" - "Sleep Mode"  p.62</p>

■ The message "Not Supported." is displayed

Check	Remedy
<p>Are the image signal format settings correct?</p> <p>Only when projecting images from a video source</p>	<p>If a composite video or S-Video source is connected to the projector, use the "Video Signal" menu command to select the signal format. "Signal" - "Video Signal"  p.57</p>
<p>Does the mode match the frequency and resolution of the image signals?</p> <p>Only when projecting computer images</p>	<p>Refer to the documentation provided with your computer for details on changing the resolution and frequency of the image signals being output from the computer. "List of Supported Monitor Displays"  p.99</p>





■ The message "No Signal." is displayed

Check	Remedy
Are the cables connected correctly?	Check that all of the cables required for projection are securely connected. 🖱️ p.18– p.25
Has the correct video input port been selected?	Press the [Computer1], [Computer2], [S-Video] or [Video] button on the remote control or the [Source Search] button on the remote control or the projector's control panel to change the image. 🖱️ p.33
Is the power for the computer or video source turned on?	Turn the power on for the devices. 🖱️ p.32
Are the image signals being output to the projector? <div style="background-color: #333; color: white; padding: 5px; margin-top: 10px;"> Only when projecting images from a laptop computer or computer with a built-in LCD screen </div>	<p>If the image signals are only being output to the computer's LCD monitor or to the accessory monitor, you need to change the output to an external destination as well as the computer's own monitor. For some computer models, when the image signals are output externally, they no longer appear on the LCD monitor or accessory monitor.</p> <p>🖱️ Computer documentation, under a title such as "External output" or "Connecting an external monitor"</p> <p>If the connection is made while the power is already turned on, the function [Fn] key that switches the computer's video signal to external output may not work. Turn the power for the projector and the computer off and then back on again. 🖱️ p.32, p.34</p>







■ Images are fuzzy or out of focus

Check	Remedy
Has the focus been adjusted correctly?	Turn the focus ring on the projector to adjust the focus. 🖱️ p.36
Is the lens cover still attached?	Remove the lens cover. 🖱️ p.31
Is the projector at the correct distance?	The recommended projection distance range of the EMP-821 is 86–1473 cm (2.8–48.3 ft.) and that of the EMP-81/61 is 87–1094 cm (2.9–35.9 ft.). Set the projector up so that it is within this range. 🖱️ p.16
Is the keystone adjustment value too large?	Decrease the projection angle to reduce the amount of keystone correction. 🖱️ p.39
Has condensation formed on the lens?	If the projector is suddenly taken from a cold environment to a warm environment or if sudden ambient temperature changes occur, condensation may form on the surface of the lens, and this may cause the images to appear fuzzy. Set the projector up in the room approximately one hour before it is to be used. If condensation forms on the lens, turn the power off and wait for the condensation to disappear.







■ Interference or distortion appear in images

Check	Remedy
<p>Are the image signal format settings correct?</p> <p>Only when projecting images from a video source</p>	<p>If a composite video or S-Video source is connected to the projector, use the "Video Signal" menu command to select the signal format. "Signal" - "Video Signal"  p.57</p>
<p>Are the cables connected correctly?</p>	<p>Check that all of the cables required for projection are securely connected.  p.18– p.25</p>
<p>Is an extension cable being used?</p>	<p>If an extension cable is used, electrical interference may affect the signals. Use the accessory cables and check if this helps.</p>
<p>Has the correct resolution been selected?</p> <p>Only when projecting computer images</p>	<p>Set the computer so that the signals that are output are compatible with this projector. "List of Supported Monitor Displays"  p.99  Computer documentation</p>
<p>Have the "Sync." and "Tracking" settings been adjusted correctly?</p> <p>Computer and RGB video signals only</p>	<p>Press the [Auto] button on the remote control or the [Enter] button on the projector's control panel to carry out automatic adjustment. If the images have not been adjusted correctly after using automatic adjustment, you can make the adjustments using the "Sync." and "Tracking" menus.  p.41, p.42</p>

■ Image is truncated (large) or small

Check	Remedy
Has the "Resize" been set correctly?	Press the [Resize] button on the remote control.  p.47
Is the image still being enlarged by the E-Zoom function?	Press the [Esc] button on the remote control to cancel the E-Zoom function.  p.48
Has the "Position" setting been adjusted correctly?	<p>If analogue RGB images from a computer or RGB video images are being projected, press the [Auto] button on the remote control or the [Enter] button on the projector's control panel to carry out automatic adjustment.</p> <p>If the images have not been correctly adjusted after using the automatic setup function, adjust the setting manually using the "Position" menu command.</p> <p>If signals other than analogue RGB images from a computer or RGB video images are being input, adjust the setting manually using the "Position" menu command.</p> <p>"Signal" - "Position"  p.55, p.57</p>
Has the computer been set for dual display? <div style="background-color: black; color: white; padding: 2px; display: inline-block;">Only when projecting computer images</div>	<p>If dual display has been activated in the Display Properties of the computer's Control Panel, the projector will only project about half of the image on the computer screen. To display the whole of the image on the computer screen, turn off the dual display setting.</p> <p> Computer video driver documentation</p>
Has the correct resolution been selected? <div style="background-color: black; color: white; padding: 2px; display: inline-block;">Only when projecting computer images</div>	<p>Set the computer so that the signals that are output are compatible with this projector.</p> <p>"List of Supported Monitor Displays"  p.99</p> <p> Computer documentation</p>

■ Image colours are not right

Check	Remedy
<p>Do the input signal settings match the signals from the connected device?</p>	<p>If you connect a computer or RGB video to the [Computer1/Component Video1] or [Computer2/Component Video2] port, and select "Component Video1" or "Component Video2" for "Computer1 Input" or "Computer2 Input" in the configuration menu, the projected image is tinged with purplish red.</p> <p>If you connect a component video to the [Computer1/Component Video1] or [Computer2/Component Video2] port, and select "Computer1" or "Computer2" for the "Computer1 Input" or "Computer2 Input" in the configuration menu, the projected image is tinged with green.</p> <p>"Signal" - "Computer1 Input", "Computer2 Input"  p.55, p.57</p> <p>If a composite video or S-Video source is connected to the projector, use the "Video Signal" menu command to select the video signal format.</p> <p>"Signal" - "Video Signal"  p.57</p>
<p>Has the image brightness been adjusted correctly?</p>	<p>Use the "Brightness" menu command to adjust the brightness.</p> <p>"Image" - "Brightness"  p.51, p.53</p>
<p>Are the cables connected correctly?</p>	<p>Check that all of the cables required for projection are securely connected.  p.18– p.25</p>
<p>Has the image contrast been adjusted correctly?</p>	<p>Use the "Contrast" menu command to adjust the contrast.</p> <p>"Image" - "Contrast"  p.51, p.53</p>
<p>Has the colour been adjusted correctly?</p>	<p>Use the "Color Adjustment" menu command to adjust the colour.</p> <p>"Image" - "Color Adjustment"  p.52, p.54</p>
<p>Have the colour intensity and tint been adjusted correctly?</p> <div data-bbox="257 1069 734 1161" style="background-color: black; color: white; padding: 5px; margin-top: 10px;"> <p>Only when projecting images from a video source</p> </div>	<p>Use the "Color Intensity" and "Tint" menu commands to adjust the colour and tint.</p> <p>"Image" - "Color Intensity", "Tint"  p.53</p>

■ Images appear dark

Check	Remedy
Have the image brightness and luminance been adjusted correctly?	Use the "Brightness" and "Brightness Control" menu commands to adjust the brightness and luminance. "Image" - "Brightness" 🖱️ p.51, p.53 "Setting" - "Brightness Control" 🖱️ p.59
Has the image contrast been adjusted correctly?	Use the "Contrast" menu command to adjust the contrast. "Image" - "Contrast" 🖱️ p.51, p.53
Is the lamp due for replacement?	When the lamp is nearly due for replacement, the images will become darker and the colour quality will become poorer. When this happens, the lamp should be replaced with a new one. 🖱️ p.86

■ Nothing appears on the external monitor

Check	Remedy
Are images from a port other than the [Computer1/Component Video1] port being projected?	The only images that can be displayed on an external monitor are those from the [Computer1/Component Video1] port. The [Computer2/Component Video2] port cannot be used for an external monitor, and images from a video equipment cannot be send to the external monitor regardless of the port. 🖱️ p.22



■ Problems when projection starts

■ Power does not turn on



Check	Remedy
Have you pressed the [Power] button?	Press the [Power] button to turn the power on.
Are all of the indicators switched off?	The power cable is not connected correctly or power is not being supplied. Connect the power cable to the projector correctly. 🖱️ p.31 Alternatively, check the circuit breaker to see if power is being supplied.
Do the indicators turn off and on when the power cable is touched?	There is probably a poor contact in the power cable, or the power cable may be defective. Reinsert the power cable. If this does not solve the problem, stop using the projector, disconnect the power cable from the wall outlet and contact the nearest address provided in the "International Warranty Conditions" section of the <i>Safety Instructions/World-Wide Warranty Terms</i> booklet.

■ Other problems

■ No sound can be heard or the sound is faint

Check	Remedy
Is the audio source connected correctly?	Check that the cable is connected to the correct [Audio] port.  p.26
Has the volume been adjusted to the minimum setting?	Adjust the volume so that sound can be heard.  p.44
Is A/V Mute mode active?	Press the [A/V Mute] button on the remote control to cancel the A/V mute function.  p.46

■ The remote control does not work

Check	Remedy
Is the remote control light-emitting area facing towards the remote control light-receiving area when it is operated?	Face the remote control towards the remote control light-receiving area. The operating angle for the remote control is approximately $\pm 30^\circ$ horizontally and approximately $\pm 15^\circ$ vertically.  p.14
Is the remote control too far from the projector?	The operating range for the remote control is approximately 6m.  p.14
Is direct sunlight or strong light from fluorescent lamps shining onto the remote control light-receiving area?	Set the projector up in a location where strong light will not shine onto the remote control light-receiving area.
Are the batteries dead, or have the batteries been inserted correctly?	Insert new batteries, while making sure that they are inserted the correct way around.  p.12

■ The fans do not stop when power is turned off

Check	Remedy
Is the "Standby Mode" configuration menu set to "Network ON"?	If the menu is set to "Network ON", the fans will continue to operate after the cool-down period has finished.  "Extended" - "Standby Mode" p.63



Appendices

This chapter provides information on maintenance procedures to ensure the best level of performance from the projector.

Maintenance	84	List of ESC/VP21 Commands.....	96
• Cleaning	84	• Command List	96
• Cleaning the Projector's Surface	84	• Communication Protocol	96
• Cleaning the Lens	84	• Cable Layouts	97
• Cleaning the Air Filters and Air Intake Vent	84	• Serial connection	97
• Replacing Consumables.....	85	• USB connection.....	97
• Lamp Replacement Period.....	85	• USB Connection Setup	98
• Replacing the Lamp.....	86	List of Supported Monitor Displays	99
• Resetting the Lamp Operating Time.....	88	• Computer/RGB Video	99
• Replacing the Air Filter	89	• Component Video/RGB Video	99
Saving a User's Logo	90	• Composite Video/S-Video	99
Optional Accessories and Consumables	93	Specifications	100
• Optional Accessories	93	Appearance.....	102
• Consumables.....	93	Index	103
Glossary	94		

This section describes maintenance tasks such as cleaning the projector and replacing consumable parts.

Cleaning

You should clean the projector if it becomes dirty or if the quality of projected images starts to deteriorate.



CAUTION

Be sure to read the separate Safety Instructions/World-Wide Warranty Terms before cleaning.

Cleaning the Projector's Surface

Clean the projector's surface by wiping it gently with a soft cloth. If the projector is particularly dirty, moisten the cloth with water containing a small amount of neutral detergent, and then firmly wring the cloth dry before using it to wipe the projector's surface. Then wipe it again with a soft, dry cloth.



CAUTION

Do not use volatile substances such as wax, alcohol or thinner to clean the projector's surface. These can cause the projector to warp and make the coating finish peel off.

Cleaning the Lens

Use a commercially-available air blower, or use a lens cleaning paper to gently wipe the lens.



CAUTION

Do not rub the lens with harsh materials or subject the lens to shocks, as it can easily become damaged.

Cleaning the Air Filters and Air Intake Vent

If dust collects on the air filter or the air outlet, it can cause the internal temperature of the projector to rise, and this can lead to problems with operation and shortening of the optical engine's service life. It is recommended that you clean these parts at least once every three months. Clean them more often than this if using the projector in particularly dusty environments.

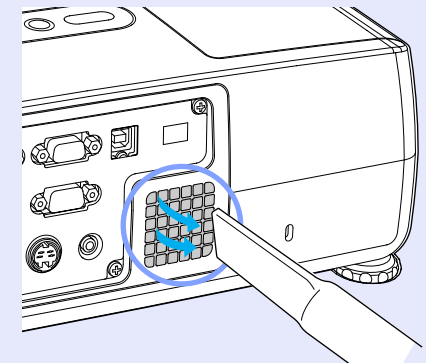
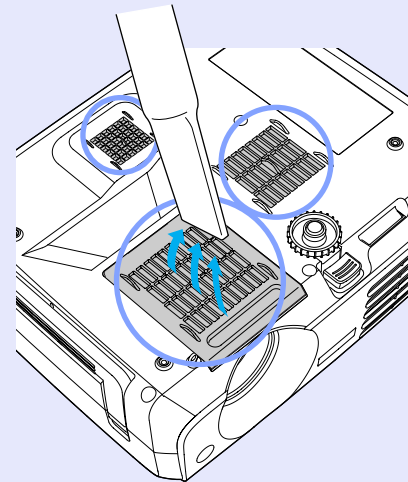

TIP

If the air filters are broken or if the warning message reappears after they have been cleaned, they should be replaced. Replace with a new air filter. See "Appendices: Optional Accessories".  p.93

Replacing Consumables

This section describes how to replace the lamp and the air filters.

Lamp Replacement Period

It is time to replace the lamp when:

- The message "Replace the Lamp." appears on the screen when projection starts.

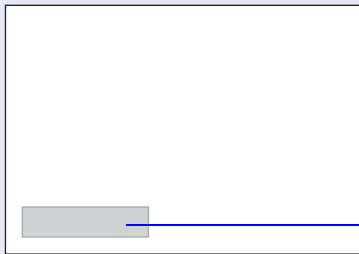

A message will be displayed.

- When the Lamp indicator is flashing orange.

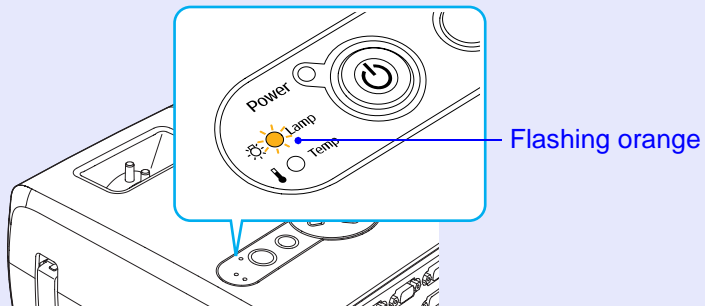

- The projected image gets darker or starts to deteriorate.



TIP

- *The lamp replacement message is set to appear after the following periods of time in order to maintain the initial brightness and quality of the projected images.*
 - *When used continuously at high brightness: Approx. 1900 hours*
 - *When used continuously at low brightness : Approx. 2900 hours*
- *"Brightness Control"  p.59*
- *If you continue to use the lamp after this period, the possibility of the lamp breaking becomes greater. When the lamp replacement message appears, replace the lamp with a new one as soon as possible, even if it is still working.*
- *Depending on the characteristics of the lamp and on the way it has been used, the lamp may become darker or stop working before the lamp warning message appears. You should always have a spare lamp ready in case it is needed.*
- *Contact your dealer for a spare lamp.*

■ Replacing the Lamp

! CAUTION

- *If you are replacing the lamp because it has stopped working, it is possible that the lamp is broken. If replacing the lamp of a projector which has been installed on a ceiling, you should always assume that the lamp is broken and be extremely careful when removing the lamp cover.*
- *Wait until the lamp has cooled down sufficiently before removing the lamp cover. It takes a further one hour after the **cool-down** period has finished for the lamp to be cool enough.*

PROCEDURE

- 1 Turn off the projector's power, wait until the cool-down period has ended and a "pip-pip" confirmation buzzer sounds, and then disconnect the power cable.

The cool-down period lasts for about 20 seconds.

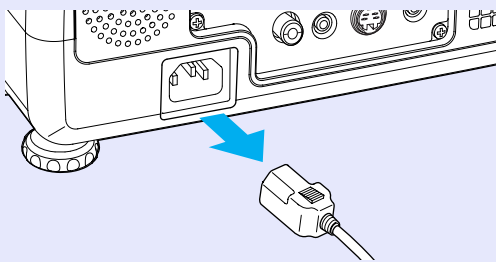

- 2 Wait until the lamp has cooled down, then remove the lamp cover from the base of the projector.

It takes approximately one hour for the lamp to cool down by itself after the cool-down period has finished.

Loosen the lamp cover fixing screw with the screwdriver that is supplied with the spare lamp (or your own cross head screwdriver).

Then slide the lamp cover straight forward and lift it to remove.

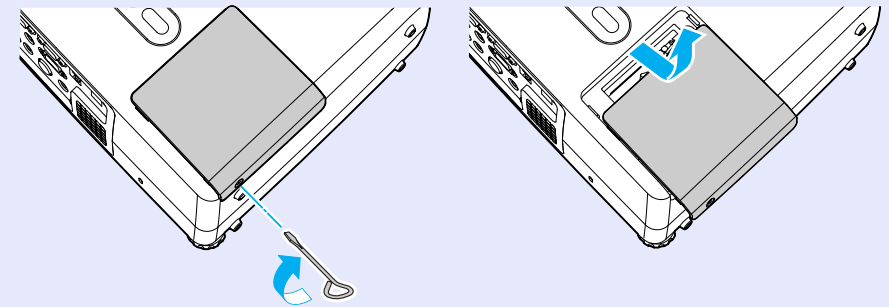

- 3 Loosen the two lamp fixing screws.

Loosen the two lamp fixing screws with the screwdriver that is supplied with the spare lamp (or your own cross head screwdriver).

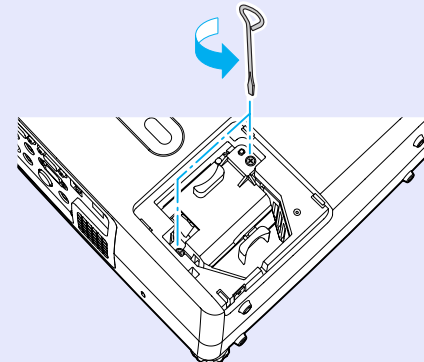

4 Take out the lamp.

Hold the lamp as shown in the illustration below and lift it up and out of the projector.
If the lamp is broken replace it with a new lamp, or contact your local dealer for further advice. If replacing the lamp yourself, be careful to avoid pieces of broken glass.

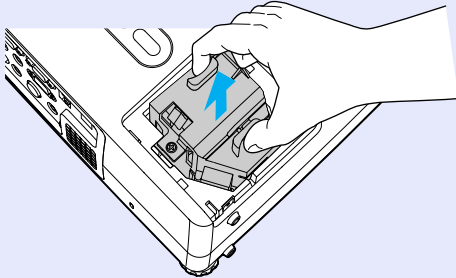
**5 Install the new lamp.**

Insert the new lamp so that the lamp fits the place correctly and once it is fully inserted, tighten the two screws.

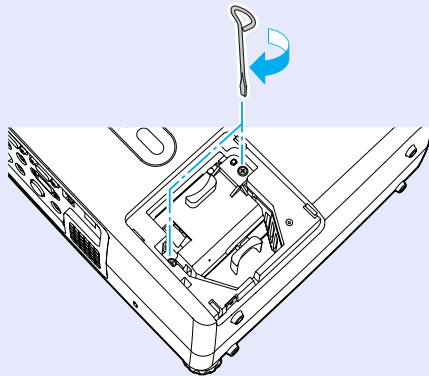
**6 Install the lamp cover.**

Slide the lamp cover and tighten the cover fixing screws.

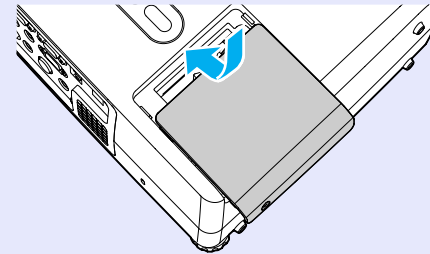
**TIP**

- *Install the lamp securely. If the lamp cover is removed, the lamp turns off automatically as a safety precaution. Moreover, the lamp will not turn on if the lamp or the lamp cover is not installed correctly.*
- *The lamp contains mercury. Dispose of used lamps properly in accordance with your local regulations.*



Resetting the Lamp Operating Time

The projector has a built-in counter which keeps track of the lamp operating time. When the cumulative operating time reaches a certain point, it causes the replacement warning message to be displayed. Therefore, the counter needs to be reset after the lamp has been replaced with a new one. You can do this using the configuration menu.



TIP

Do not reset the lamp operating time except after the lamp has been replaced, otherwise the lamp replacement period will not be indicated correctly.

PROCEDURE

- 1 Connect the power cable, turn on the projector's power, and then press the [Menu] button.

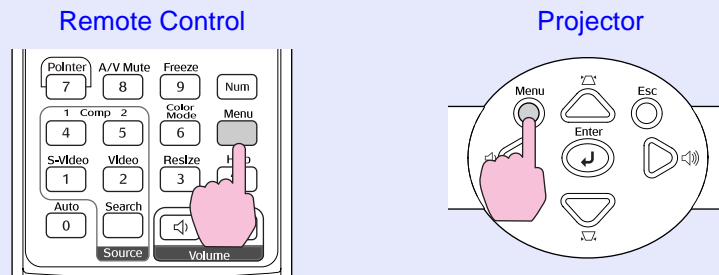
The configuration menu will be displayed.



- 2 Select "Lamp-Hours Reset" from the "Reset" menu and then press the [Enter] button.

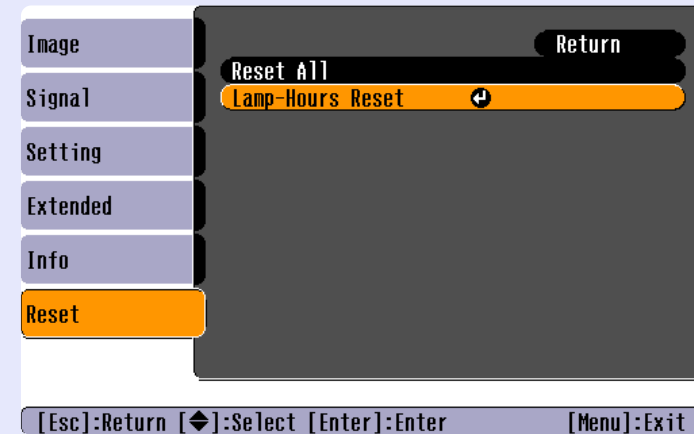

- 3 Select "Yes" and then press the [Enter] button. The lamp operating time will then be reset.

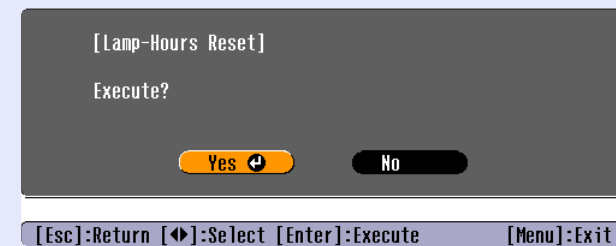

■ Replacing the Air Filter

If the air filters are broken or if the warning message reappears after they have been cleaned, they should be replaced.

The air filter can be replaced even if the projector is installed on a ceiling.

PROCEDURE

- 1** Turn off the projector's power, wait until the **cool-down** period has ended and a "pip-pip" confirmation buzzer sounds, and then disconnect the power cable.

The cool-down period lasts for about 20 seconds.

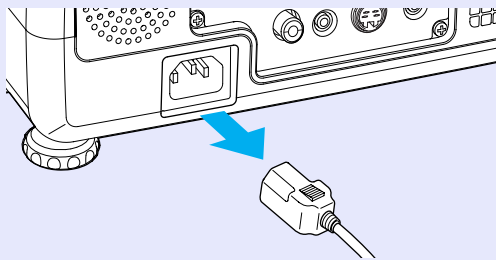

- 2** Remove the air filter.

Put your finger into the recess of the air filter and slide it forward to remove it.

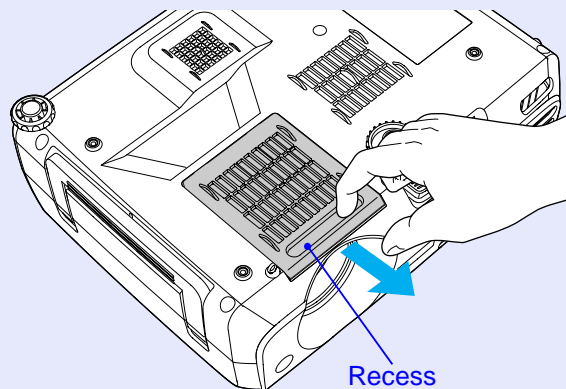

- 3** Install the new air filter.

Slide the air filter covers in from the outside and push them in until they click into place.

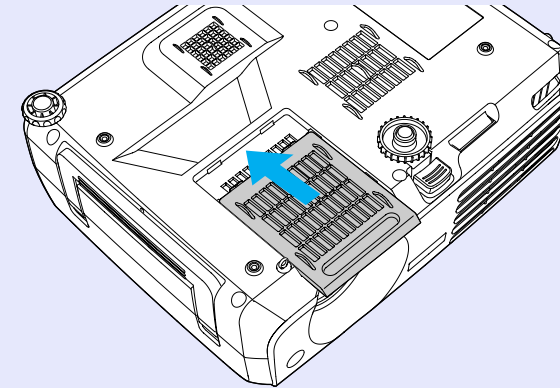

TIP

Dispose of used air filters properly in accordance with your local regulations.

Air filter frame: Polycarbonate, ABS plastic

Air filter: Polyurethane foam

You can record the image that is currently being projected as a user's logo.

**TIP**

When a user's logo is recorded, the previous user's logo will be erased.

PROCEDURE

- 1 Project the image that you would like to use as a user's logo, and then press the [Menu] button.

Remote Control

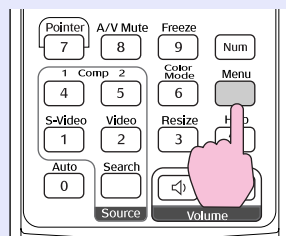

Projector

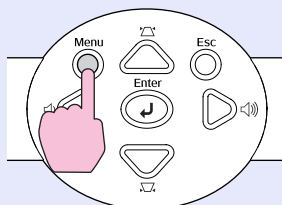
**2**

- 2 Select "User's Logo" from the "Extended" menu, and then press the [Enter] button.

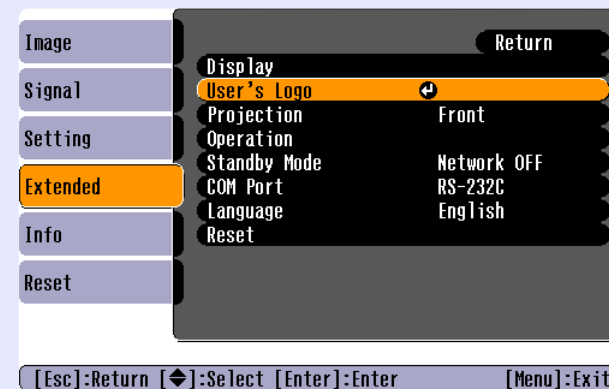
**TIP**

- If the "User's Logo Protect" function of "Password Protect" is set to "ON", a message is displayed and the user's logo can not be recorded. To record a user's logo, set "User's Logo Protect" to "OFF" first. [p.29](#)
- If keystone correction or E-Zoom have been carried out, they will be cancelled when the "User's Logo" menu is selected.

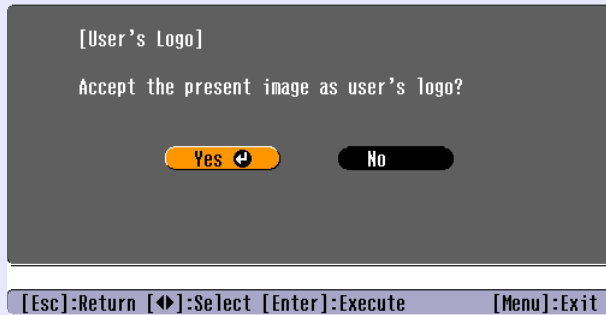

- 3** Select "Yes" in the sub-menu, then press the [Enter] button.

**TIP**

When you press the [Enter] button on either the remote control or the projector's control panel, the image signal will be displayed at their original resolution, so if a signal with a resolution that is different from the panel resolution of the projector is projected, or if a video image is being projected, the display size will change.

- 4** The image to be recorded and a selection marquee box will be displayed. Move the marquee box to select the part of the image to use.

Tilt the [\odot] button on the remote control or press the [\triangle], [∇], [\triangleleft] and [\triangleright] buttons on the projector's control panel to select the area of the image to use as the user's logo, and then press the [Enter] button.

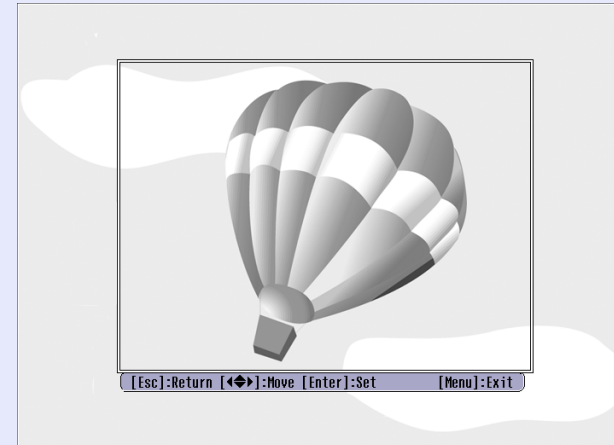
**TIP**

User's logos can be saved at up to 480 × 360 dots in size.

- 5 Select "Yes" at the confirmation screen, and then press the [Enter] button.

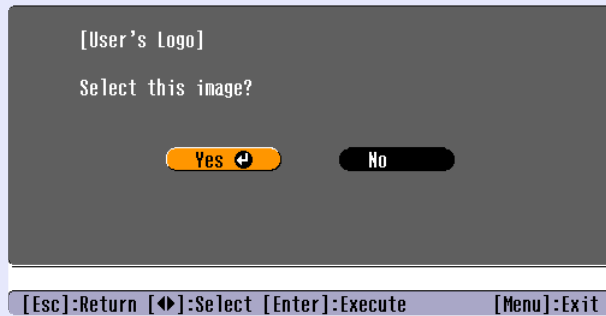

- 6 Select the zoom rate in the Zoom rate setting screen, and then press the [Enter] button.

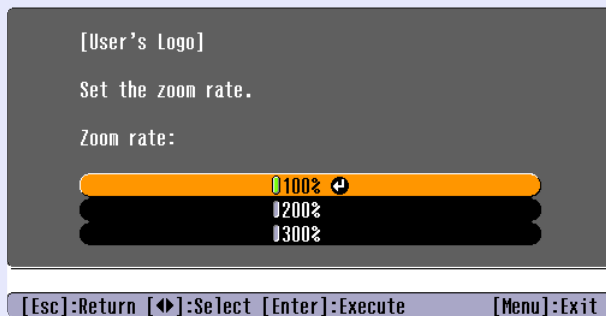

- 7 Select "Yes" at the confirmation screen, and then press the [Enter] button.

The image will then be saved. Once the image has been saved, the message "Completed." will be displayed.

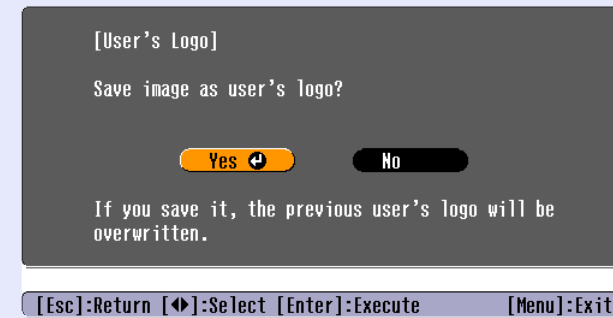
**TIP**

- Saving the user's logo may take a few moments (about 15 seconds). Do not use the projector or any other sources which are connected to the projector while the user's logo is being saved, otherwise it may result in errors in projector operation.
- Once a user's logo has been saved, the logo setting cannot be returned to the factory default.



The following optional accessories are available for purchase if required. This list of optional accessories is current as of June, 2004. Details of accessories are subject to change without notice.

■ Optional Accessories

Soft carrying case ELPKS27

Use this case if you need to carry the projector by hand.

60" screen ELPSC07

80" screen ELPSC08

100" screen ELPSC10

A portable roll-type screen. ([Aspect ratio](#)▶ 4:3)

50" portable screen ELPSC06

A compact screen which can be carried easily. (Aspect ratio 4:3)

VGA-HD15 PC cable ELPKC02

(1.8 m (6 ft.) - for mini D-Sub 15-pin/mini D-Sub 15-pin)

This is the same computer cable as the projector's accessory computer cable.

VGA-HD15 PC cable ELPKC09

(3 m (9.8 ft.) - for mini D-Sub 15-pin/mini D-Sub 15-pin)

VGA-HD15 PC cable ELPKC10

(20 m (65.6 ft.) - for mini D-Sub 15-pin/mini D-Sub 15-pin)

Use this extension cable if the accessory computer cable is too short.

Component video cable ELPKC19

(3 m (9.8 ft.) - for mini D-Sub 15-pin/RCA male × 3)

Component video cable ELPKC27

(0.35 m (1.15 ft.) - for mini D-Sub 15-pin/RCA female × 3)

Use to connect a [component video](#)▶ source.

Ceiling mount * ELPMB07

Use when installing the projector to a ceiling.

Ceiling plate* ELPFC03

Pipe 370 (370 mm (14.57 in.)/silver)* ELPFP04

Pipe 570 (570 mm (22.44 in.)/silver)* ELPFP05

Pipe 770 (770 mm (30.31 in.)/silver)* ELPFP06

Use when installing the projector on a high ceiling or a ceiling with veneer panels.

Image presentation camera ELPDC04

Use to project books, OHP films and slides.

* A special method of installation is required in order to suspend the projector from the ceiling. Please contact your dealer if you would like to use this installation method.

■ Consumables

Spare lamp ELPLP30

Use as a replacement for used lamps.

Filter kit ELPAF06

(2 air filters)

Use as a replacement for used air filters.

The following is an explanation of some of the terms used in this guide which may be unfamiliar or which are not explained in the text of this guide itself. Further information can be obtained by referring to other commercially-available publications.

Abs. Color Temp.	The temperature of an object which is emitting light. If the absolute colour temperature is high, the colours tend to take on a bluish tinge. If the absolute colour temperature is lower, the colours tend to take on a reddish tinge.
Aspect ratio	The ratio between an image's length and its height. HDTV images have an aspect ratio of 16:9 and appear elongated. The aspect ratio for standard images is 4:3.
Component video	Video signals which have the video brightness signals and colour signals separated, in order to provide better image quality. In high-definition TV (HDTV), it refers to images which consist of three independent signals: Y (luminance signal), and Pb and Pr (colour difference signals).
Composite video	Video signals which have the video brightness signals and colour signals mixed together. The type of signals commonly used by household video equipment (NTSC, PAL and SECAM formats). The carrier signal Y (luminance signal) and chroma (colour) signal which are contained in the colour bar are overlapped to form a single signal.
Contrast	The relative brightness of the light and dark areas of an image can be increased or decreased in order to make text and graphics stand out more clearly, or to make them appear softer. Adjusting this particular property of an image is called "contrast adjustment".
Cool-down	This is the process by which the projector's lamp is cooled down after it has become hot through use. Cool-down is carried out automatically when the [Power] button is pressed to turn off the power. Do not disconnect the power cable while cool-down is in progress, otherwise the cool-down process will not work properly. If the cool-down period is not allowed to finish normally, the projector's lamp and internal components will remain at high temperatures, and this may shorten the operating life of the lamp or cause problems with the operation of the projector.
Dolby Digital	A sound format developed by Dolby Laboratories. Normal stereo is a 2-channel format which uses two speakers. Dolby Digital is a 6-channel (5.1-channel) system which adds to this a centre speaker two rear speakers and a sub-woofer.
HDTV	An abbreviation for High-Definition Television. It refers to high-definition systems which satisfy the following conditions. <ul style="list-style-type: none"> • Vertical resolution of 750p or 1125i or greater (p = progressive scanning, i = interlaced scanning) • Screen aspect ratio of 16:9 • Dolby Digital audio reception and playback (or output)
Interlaced scanning	A method of image scanning whereby the image data is divided into fine horizontal lines which are displayed in sequence starting from left to right and then from the top to the bottom of the screen. The even-numbered lines and odd-numbered lines are displayed alternately.
Progressive scanning	A method of image scanning whereby the image data from a single image is scanned sequentially from top to bottom to create a single image.
Refresh rate	The light-emitting element of a display maintains the same luminosity and colour for an extremely short time. Because of this, the image must be scanned many times per second in order to refresh the light-emitting element. The number of refresh operations per second is called the "refresh rate", and is expressed in hertz (Hz).



Resize display	This function is used to allow images that have a resolution more than or less than the projector's panel resolution to be projected so that they fill the whole of the projection area.
SDTV	An abbreviation for Standard Definition Television. It refers to standard television systems which do not satisfy the conditions for High-Definition Television.
Security lock	A device consisting of a projector case with a hole in it that a commercially-available theft-prevention cable can be passed through in order to secure the device to a table or pillar. This projector is compatible with the Microsaver Security System manufactured by Kensington.
Squeeze mode	In this mode, wide-screen images in 16:9 mode are compressed in the horizontal direction so that they are stored on the recording medium as 4:3 images. When these images are played back by the projector in squeeze mode, they are restored to their original 16:9 format.
sRGB	An international standard for colour intervals that was formulated so that colours which are reproduced by video equipment can be handled easily by computer operating systems (OS) and the Internet.
SVGA	A type of video signal with a resolution of 800 (horizontal) × 600 (vertical) dots which is used by IBM PC/AT-compatible computers.
S-Video	A video signal which has the luminance component and colour component separated in order to provide better image quality. It refers to images which consist of two independent signals: Y (luminance signal), and C (colour signal).
SXGA	A type of video signal with a resolution of 1280 (horizontal) × 1024 (vertical) dots which is used by IBM PC/AT-compatible computers.
Sync (synchronisation)	The signals output from computers and RGB video equipment have a specific frequency. If the projector frequency does not match this frequency, the resulting images will not be of a good quality. The process of matching the phases of these signals (the relative position of the crests and troughs in the signal) is called "synchronisation". If the signals are not synchronized, problems such as flickering, blurriness and horizontal interference can occur.
Tracking	The signals output from computers and RGB video equipment have a specific frequency. If the projector frequency does not match this frequency, the resulting images will not be of a good quality. The process of matching the frequency of these signals (the number of crests in the signal) is called "tracking". If tracking is not carried out correctly, wide vertical stripes will appear in the projected images.
USB	An abbreviation for Universal Serial Bus. USB is an interface for connecting personal computers to peripheral devices which only support relatively low data transmission speeds.
UXGA	A type of video signal with a resolution of 1600 (horizontal) × 1200 (vertical) dots which is used by IBM PC/AT-compatible computers.
VGA	A type of video signal with a resolution of 640 (horizontal) × 480 (vertical) dots which is used by IBM PC/AT-compatible computers.
XGA	A type of video signal with a resolution of 1024 (horizontal) × 768 (vertical) dots which is used by IBM PC/AT-compatible computers.



Command List

When a power on command is sent to the projector, the power will turn on and the projector will change to warm-up mode. When the power has turned on, a colon ":" (3Ah) will be returned.

When the projector executes a command, it returns a ":" and waits for the next command to be sent.

If command processing terminates with an error, the projector outputs an error message and then returns the ":" code.

	Item	Command
Power ON/OFF	ON	PWR ON
	OFF	PWR OFF
Signal selection	Computer1 (Auto)	SOURCE 1F
	Computer1	SOURCE 11
	Component Video1	SOURCE 14
	Computer2 (Auto)	SOURCE 2F
	Computer2	SOURCE 21
	Component Video2	SOURCE 24
	Video	SOURCE 41
	S-Video	SOURCE 42
A/V Mute ON/OFF	ON	MUTE ON
	OFF	MUTE OFF
A/V Mute Selection	Black	MSEL 00
	Blue	MSEL 01
	User's Logo	MSEL 02

* When issuing any of the above commands, tack a Carriage Return (CR) code (0Dh) on to the end.

Communication Protocol

- Standard baud rate : 9600 bps
- Data length : 8 bits
- Parity : None
- Stop bit : 1 bit
- Flow control : None
- Connector shape : D-Sub 9-pin (male)
- Projector input port : Control (RS-232C)

Cable Layouts

Serial connection

- Connector shape : D-Sub 9 pin (male)
- Projector input connector : Control (RS-232C)

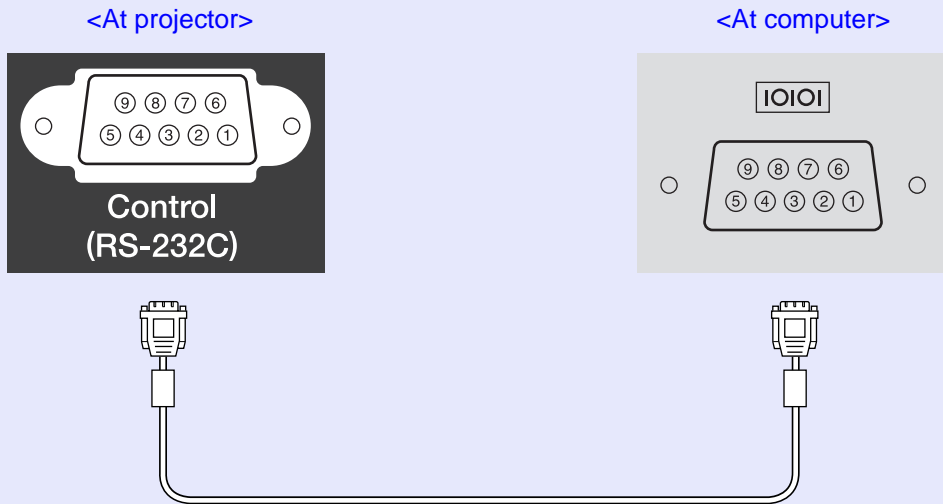

<At projector>	(PC serial cable)	<At computer>	Signal	Function
GND	5	5	GND	Signal wire ground
RD	2	3	TD	Transmit data
TD	3	2	RD	Receive data
DTR	4	6	DSR	Data set ready
DSR	6	4	DTR	Data terminal ready

USB connection

- Connector shape : USB (type B)

<At projector>

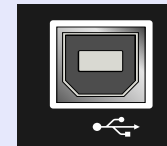

(type B)

<At computer>

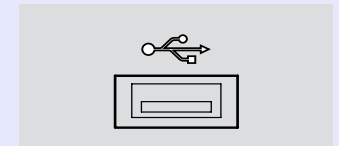

USB Connection Setup

In order to control the projector using ESC/VP21 commands via a USB connection, the following preparations must be carried out.

PROCEDURE

- 1 Download the USB driver (USB-COM Driver) from the EPSON website to your computer.**

The URL is as follows.

<http://www.epson.co.uk/support/download/index.htm>

- 2 Install the downloaded USB driver on your computer.**
Read the instructions displayed on the download screen.

- 3 Change the "COM Port" setting in the "Extended" menu to "USB".**

- 4 Turn the projector's power off.**

- 5 Wait until the **cool-down** period has ended and a "pip-pip" confirmation buzzer sounds, and then turn on the power.**

Once the projector's power has turned back on, communication via a USB Connection will then be possible.



CAUTION

If you disconnect the power cable before the cool-down period has ended and a "pip-pip" confirmation buzzer sounds, the communication port will not change.

■ Computer/RGB Video

Signal	Refresh rate [▶] (Hz)	Resolution (dots)	Resolutions for resize display [▶] (dots)	
			EMP-821/81	EMP-61
VGA [▶]	60	640×480	1024×768	800×600
VGAEGA		640×350	1024×560	800×438
VESA	60/72/75/85,iMac*	640×480	1024×768	800×600
SVGA [▶]	56/60/72/75/ 85,iMac*	800×600	1024×768	800×600
XGA [▶]	60/70/75/85,iMac*	1024×768	1024×768	800×600
SXGA [▶]	70/75/85	1152×864	1024×768	800×600
SXGA	60/75/85	1280×960	1024×768	800×600
SXGA	60/75/85	1280×1024	960×768	750×600
UXGA [▶]	60	1600×1200	1024×768	-
MAC13"		640×480	1024×768	800×600
MAC16"		832×624	1024×768	800×600
MAC19"		1024×768	1024×768	800×600
MAC19"	60	1024×768	1024×768	800×600
MAC21"		1152×870	1016×768	794×600
SDTV [▶] (625i)	50	720×576	1024×768	800×600
SDTV(525i)	60	720×480	1024×768	800×600
SDTV(525p)	60	640×480	1024×768	800×600
HDTV [▶] (750p)	60	1280×720	1024×576	800×450
HDTV(1125i)	60	1920×1080	1024×576	800×450

* Connection is not possible if the equipment does not have a VGA output port.

The projection of some signals not listed in the table may still be possible. However, not all functions may be supported.

■ Component Video/RGB Video

Signal	Refresh rate [▶] (Hz)	Resolutions (dots)			
		EMP-821/81		EMP-61	
		Aspect ratio [▶] 4:3	Aspect ratio 16:9	Aspect ratio 4:3	Aspect ratio 16:9
SDTV [▶] (525i) (D1)	60	1024×768	1024×576	800×600	800×450
SDTV (625i)	50	1024×768	1024×576	800×600	800×450
SDTV (525p) (D2)	60	1024×768	1024×576	800×600	800×450
HDTV [▶] (750p) 16:9 (D4)	60	1024×768	1024×576	800×600	800×450
HDTV (1125i) 16:9 (D3)	60	1024×768	1024×576	800×600	800×450

■ Composite Video/S-Video

Signal	Refresh rate [▶] (Hz)	Resolutions (dots)			
		EMP-821/81		EMP-61	
		Aspect ratio [▶] 4:3	Aspect ratio 16:9	Aspect ratio 4:3	Aspect ratio 16:9
TV (NTSC)	60	1024×768	1024×576	800×600	800×450
TV (PAL, SECAM)	50	1024×768	1024×576	800×600	800×450

Product name	Multimedia Projector EMP-821/81/61
Dimensions	350 (W) × 109 (H) × 272 (D) mm (12.4 (W) × 4.3 (H) × 9.45 (D) in.) (not including feet)
Panel size	EMP-821 : 0.8 inches EMP-81/61 : 0.7 inches
Display method	Polysilicon TFT active matrix
Resolution	EMP-821/81 : XGA 786,432 pixels (1024 (W) × 768 (H) dots) × 3 EMP-61 : SVGA 480,000 pixels (800 (W) × 600 (H) dots) × 3
Focus adjustment	Manual
Zoom adjustment	EMP-821 : Manual (approx. 1:1.6) EMP-81/61 : Manual (approx. 1:1.2)
Lamp (light source)	UHE lamp, 200 W, Model No.: ELPLP30
Max. audio output	5W monaural
Speaker	1
Power supply	100–240VAC 50/60Hz 3.2–1.6A
Operating temperature	+5°– +35°C (41°–95°F) (No condensation)
Storage temperature	-10°– +60°C (14°–140°F) (No condensation)
Weight	Approx. 4.0 kg (8.9 lbs)

Connectors	Computer1/Component Video1:	1	Mini D-Sub 15-pin (female) Blue
	Audio1:	1	Stereo mini jack
	Computer2/Component Video2:	1	Mini D-Sub 15-pin (female) Blue
	Audio2:	1	Stereo mini jack
	S-Video:	1	Mini DIN 4-pin
	Audio:	1	Stereo mini jack
	Video:	1	RCA pin jack
	Audio:	1	Stereo mini jack
	USB*:	1	USB connector (B series)
	Control (RS-232C) :	1	D-Sub 9-pin (male)
Monitor Out :	1	Mini D-Sub 15-pin (female) Black	
Audio Out:	1	Stereo mini jack	

* The USB interface complies with the USB 1.1 standard.
The USB connector is not guaranteed to operate correctly with all USB-compatible devices.



Pixelworks DNX™ ICs are used in this Projector.

Safety

USA

UL60950 Third Edition

Canada

CSA C22.2 No.60950 (cUL)

European Community

The Low Voltage Directive (73/23/EEC)

IEC60950 3rd Edition

EMC

USA

FCC Part15B Class B (DoC)

Canada

ICES-003 Class B

European Community

The EMC Directive (89/336/EEC)

EN55022, 1998 Class B

EN55024, 1998

IEC/EN61000-3-2

IEC/EN61000-3-3

Australia/New Zealand

AS/NZS CISPR 22:2002 Class B

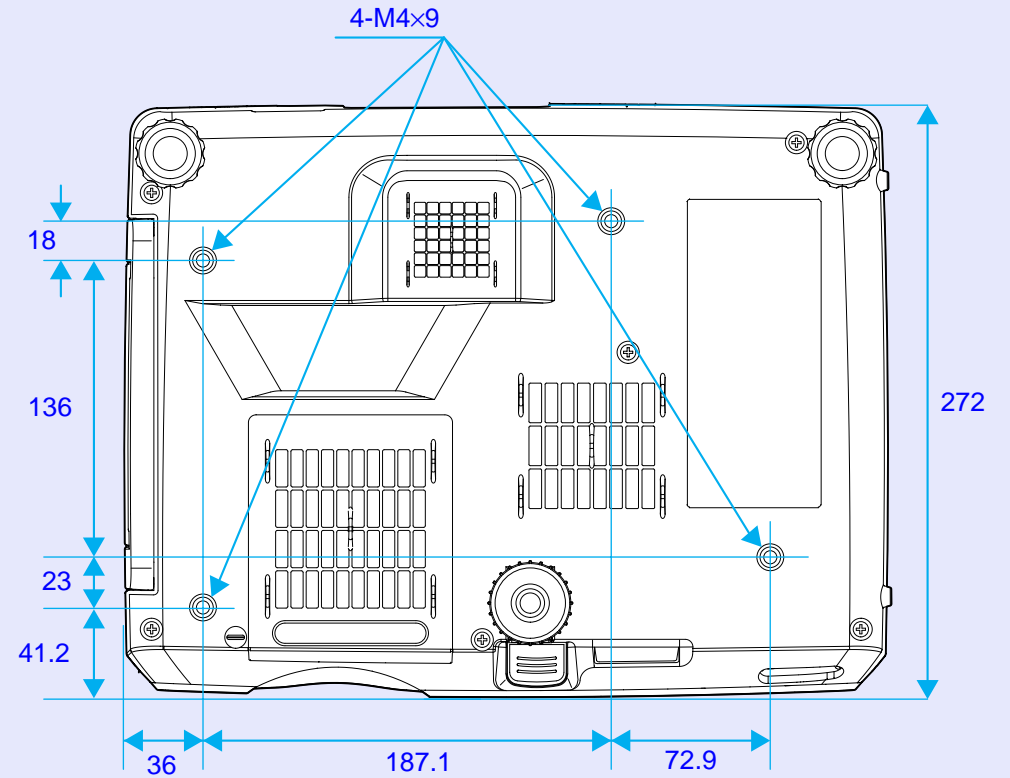
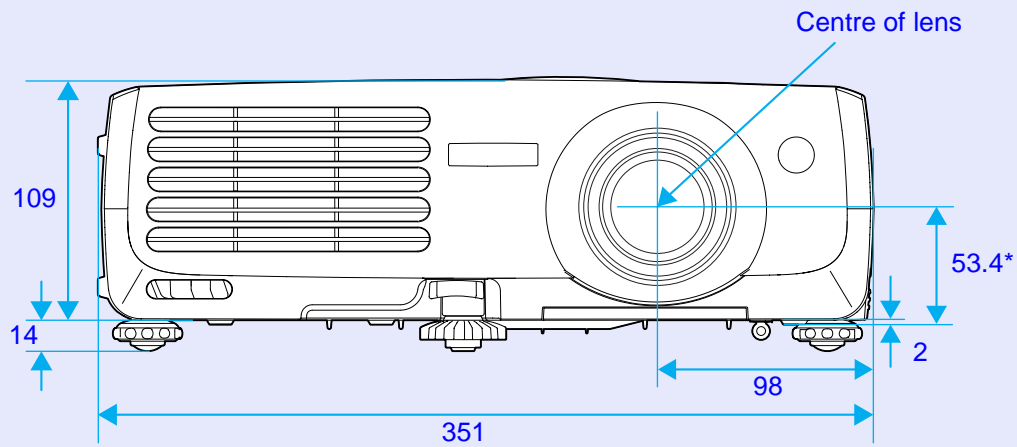

*Distance from center of lens to suspension bracket fixing point

Units: mm

A

Abs. Color Temp.	52, 54
Air exhaust vent.....	7
Air filter	10
Air intake vent	9, 10
Aspect ratio.....	47
[Audio1] port	9, 26
[Audio2] port	9, 26
[Audio Out] port	9
[Audio] port	9, 26
Auto Keystone	59
Auto Setup	40, 55
A/V cable.....	23, 26
A/V Mute.....	46

B

Background Color	61
Blackboard.....	43, 51, 53
Brightness	51, 53
Brightness Control.....	59
Buzzer for notice of termination..	34

C

Cleaning the Air Filter	84
Cleaning the Lens.....	84
Cleaning the Projector Surface.....	84, 93
Color Intensity.....	53
Color Mode	43, 51, 53
Component video	24
COM Port	63
Composite video.....	23
[Computer1/Component Video1] port	9
Computer1 Input	55, 57
[Computer2/Component Video2] port	9
Computer2 Input	55, 57
Computer cable	19, 25
Connecting to a Computer	18
Connecting to a Video Source.....	23
Contrast	51, 53
Control Panel.....	8
[Control (RS-232C)] port.....	9
Cool-down.....	34, 73
Cross.....	48

D

DirectPower ON	62
Display	61
Dynamic.....	43, 51, 53

E

Eligible computers	18
ESC/VP21	96
"Extended" Menu.....	61
E-Zoom	48

F

Focus.....	36
Focus ring	7
Foot adjustment	38
Freeze.....	47
Front adjustable foot	7, 10

G

Glossary	94
----------------	----

H

Handle.....	7
HDTV	99
Help function	69

High.....	59
-----------	----

I

"Image" Menu	51
Image size.....	16, 36
Indicators	7, 71
"Info" Menu.....	64
Input Signal	64
Inserting the Batteries.....	12

K

Keystone.....	37, 59
---------------	--------

L

Lamp cover.....	7
Lamp Hours.....	64
Lamp-Hours Reset.....	65, 88
Lamp indicator	7, 71
Lamp replacement period.....	85
Language	63
Lens cover	7
Living Room	43, 51, 53
Low.....	59



M

- Main menu 50
- Manually Correcting Keystone Distortion 39
- Menu 50
- Message 61
- Mini D-Sub 15-pin port 19
- [Monitor Out] port 9
- Mouse pointer 21

N

- Numeric buttons 11

O

- Operating distance (Remote control) 14
- Operating range (Remote control) 14
- Operating temperature 100
- Operation 62
- Operation Lock 59
- Optional accessories 93
- Overheating 72

P

- Part Names and Functions 7
- Password Protect 27

- Password Protect stickers 28
- Pointer 49
- Pointer Shape 59
- Port 9, 33
- Position 40, 55, 57
- Power cable 31
- Power indicator 7, 71
- Power inlet 9
- Power ON Protect 27
- Presentation 43, 51, 53
- Problem Solving 71
- Projecting Images 32
- Projection 62
- Projection angle 37
- Projection distance 16

R

- Rear adjustable foot 9, 38
- Refresh Rate 64
- Remote control 11, 12, 13, 20
- Remote control light-emitting area 11
- Remote control light-receiving area 7, 9
- Replacing the Air Filter 89
- Replacing the Lamp 86
- Request code 27
- Reset All 65
- "Reset" Menu 65

- Resized display 99
- Resolution 64, 99
- RGB Video 25

S

- Screen size 16
- Security lock 9
- "Setting" Menu 59
- Setting Up the Projector 15
- Sharpness 51, 53
- "Signal" Menu 55
- Sleep Mode 62
- Source 64
- Speaker 9, 26
- Specifications 100
- Squeeze mode 47
- sRGB 43, 51, 53
- Standby Mode 63
- Startup Screen 61
- Stereo mini jack audio cable 26
- Storage temperature 100
- Sub-menu 50
- Supported Monitor Displays 99
- Suspension bracket fixing point 10, 102
- S-Video 24, 53, 57, 64
- [S-Video] port 9
- Sync 40, 55
- Sync. Info 64

T

- Temp indicator 7, 71
- Theatre 43, 51, 53
- Tint 53
- Tracking 40, 41, 55
- Translucent screen 15

U

- USB cable 20
- USB connection 98
- USB mouse 20
- [USB] port 9
- User's Logo 46, 90
- User's Logo Protect 28
- Using the Configuration Menu Functions 50

V

- Video 53, 57, 64
- Video Signal 57, 64
- [Video] port 9
- Volume 44

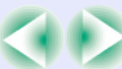

W

Wide-screen Projection 47

Wireless Mouse Function 20

Z

Zoom ring 7



DECLARATION of CONFORMITY

According to 47CFR, Part 2 and 15
Class B Personal Computers and Peripherals; and/or
CPU Boards and Power Supplies used with Class B
Personal Computers

We :EPSON AMERICA, INC.
Located at :3840 Kilroy Airport Way
MS: 3-13
Long Beach, CA 90806
Tel :562-290-5254

Declare under sole responsibility that the product identified herein, complies with 47CFR Part 2 and 15 of the FCC rules as a Class B digital device. Each product marketed, is identical to the representative unit tested and found to be compliant with the standards. Records maintained continue to reflect the equipment being produced can be expected to be within the variation accepted, due to quantity production and testing on a statistical basis as required by 47CFR 2.909. Operation is subject to the following two conditions : (1) this device may not cause harmful interference, and (2) this device must accept any interference received, including interference that may cause undesired operation.

Trade Name :EPSON
Type of Product :Projector
Model :EMP-821/81/61

**FCC Compliance Statement
For United States Users**

This equipment has been tested and found to comply with the limits for a Class B digital device, pursuant to Part 15 of the FCC Rules. These limits are designed to provide reasonable protection against harmful interference in a residential installation. This equipment generates, uses, and can radiate radio frequency energy and, if not installed and used in accordance with the instructions, may cause harmful interference to radio or television reception. However, there is no guarantee that interference will not occur in a particular installation. If this equipment does cause interference to radio and television reception, which can be determined by turning the equipment off and on, the user is encouraged to try to correct the interference by one or more of the following measures.

- Reorient or relocate the receiving antenna.
- Increase the separation between the equipment and receiver.
- Connect the equipment into an outlet on a circuit different from that to which the receiver is connected.
- Consult the dealer or an experienced radio/TV technician for help.

WARNING

The connection of a non-shielded equipment interface cable to this equipment will invalidate the FCC Certification or Declaration of this device and may cause interference levels which exceed the limits established by the FCC for this equipment. It is the responsibility of the user to obtain and use a shielded equipment interface cable with this device. If this equipment has more than one interface connector, do not leave cables connected to unused interfaces. Changes or modifications not expressly approved by the manufacturer could void the user's authority to operate the equipment.

All rights reserved. No part of this publication may be reproduced, stored in a retrieval system, or transmitted in any form or by any means, electronic, mechanical, photocopying, recording, or otherwise, without the prior written permission of SEIKO EPSON CORPORATION. No patent liability is assumed with respect to the use of the information contained herein. Neither is any liability assumed for damages resulting from the use of the information contained herein.

Neither SEIKO EPSON CORPORATION nor its affiliates shall be liable to the purchaser of this product or third parties for damages, losses, costs, or expenses incurred by the purchaser or third parties as a result of: accident, misuse, or abuse of this product or unauthorized modifications, repairs, or alterations to this product, or (excluding the U.S.) failure to strictly comply with SEIKO EPSON CORPORATION's operating and maintenance instructions.

SEIKO EPSON CORPORATION shall not be liable against any damages or problems arising from the use of any options or any consumable products other than those designated as Original EPSON Products or EPSON Approved Products by SEIKO EPSON CORPORATION.

General Notice:

EPSON is a registered trademark of SEIKO EPSON CORPORATION. Macintosh, Mac, and iMac are registered trademarks of Apple Computer, Inc.

IBM is a registered trademark of International Business Machines Corporation.

Windows and Windows NT are trademarks of Microsoft Corporation in the United States of America.

Dolby is a registered trademark of Dolby Laboratories.

Pixelworks and DNX are trademarks of Pixelworks, Inc.

Other product names used herein are also for identification purposes only and may be trademarks of their respective owners. EPSON disclaims any and all rights in those marks.

This product uses open source software.

Remote Control

- **[Page down][Page up] buttons** p.20

When using the remote control as a wireless mouse, press these buttons to scroll back and forth through pages in a PowerPoint file.

- **[E-Zoom] button** (⊕) (⊖) p.48

[⊕]:Enlarges parts of images without changing the size of the projection area.
[⊖]:Reduces the part of images that have been enlarged using the [⊕] button.

- **[Enter] button** p.21, p.66, p.69

Accepts a menu or help item or displays the next screen or menu when viewing a configuration menu or help menu.
Acts as a mouse left-click when using the wireless mouse function.

- **[Esc] button** p.21

Stops the current function.
Displays the previous screen or menu while viewing a configuration menu.
Acts as a mouse right-click when using the wireless mouse function.

- **[Pointer] button** p.49

Press to indicate part of an image being projected as part of a presentation.

- **[A/V Mute] button** p.46

The audio and video are turned on or off each time the button is pressed.

- **[Computer1] button** p.33

Switches to images from the [Computer1/Component Video1] port.

- **[Computer2] button** p.33

Switches to images from the [Computer2/Component Video2] port.

- **[S-Video] button** p.33

Switches to images from the [S-Video] port.

- **[Video] button** p.33

Switches to images from the [Video] port.

- **[Auto] button** p.40

Automatically adjusts and optimises analogue RGB computer video signals.

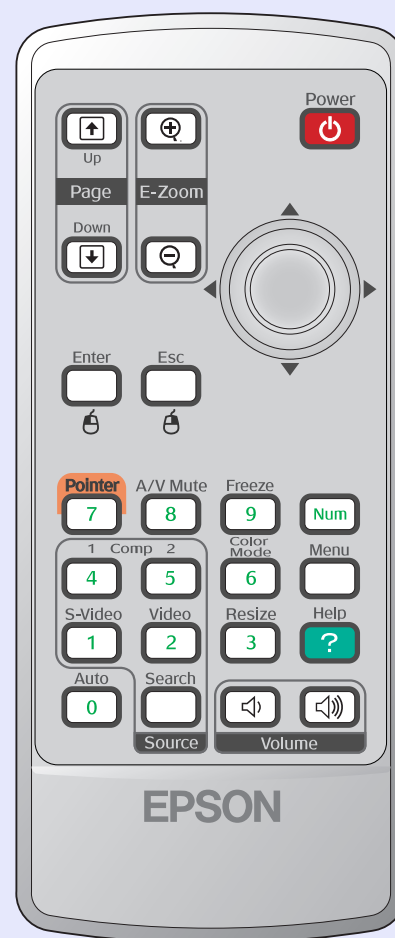

- **Remote control light-emitting area** p.13

Outputs remote control signals.

- **[Power] button** p.32, p.34

Turns the projector power on and off.

- **[⊙] buttons** p.21, p.66, p.69

When a configuration menu or help menu is displayed, these buttons select menu items and setting values.
When the wireless mouse function is activated, tilting this button moves the pointer in the direction of tilt.

- **[Freeze] button** p.47

Images are paused or unpaused each time the button is pressed.

- **[Num] button** p.27

This is used when entering and changing passwords.

- **[Color Mode] button** p.43

Selects the colour mode. The colour mode changes in the order of Dynamic, Presentation, Theatre, Living Room, sRGB and Blackboard each time the button is pressed.

- **[Menu] button** p.66

Displays and hides the configuration menu.

- **[Resize] button** p.47

When component video, composite video or S-Video signals are being projected, the aspect ratio changes each time this button is pressed.

- **[Help] button** p.69

Each time this button is pressed, it displays and hides the online help menu that can assist you if you have a problem.

- **[Volume] buttons** p.44

Adjust the sound volume.

- **[Search] button** p.33

The next input source is searched for automatically in the following order and the image input from the connected equipment is projected each time this button is pressed.

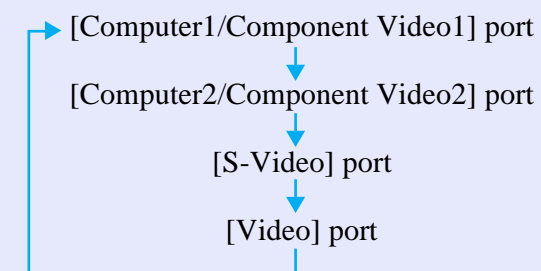

- **Numeric buttons** p.27

Use these buttons to enter a password when using Password Protect.