

myprojectorlamps.com

**The most trusted, dependable name
in projector lamp sales.**



<http://www.myprojectorlamps.com>



<http://www.myprojectorlamps.ca>



<http://www.myprojectorlamps.eu>

The following projector manual has not been modified or altered in any way.

EPSON®

MEDIA PROJECTOR

EMP-715/505™

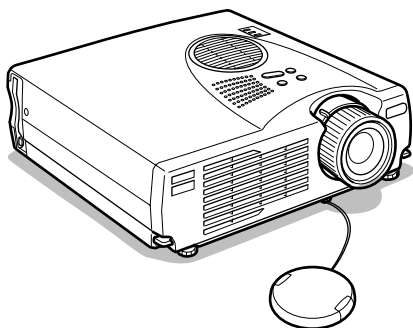

Before use

Installation

Connections

Projection

Useful Functions

Adjustments and
Setting

Troubleshooting







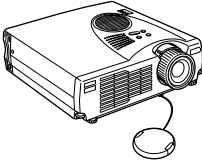
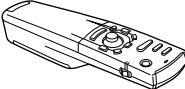
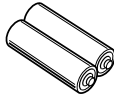
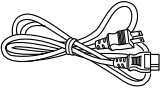
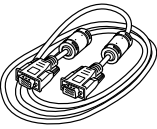

Maintenance

Others

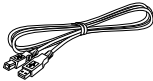
Owner's Manual

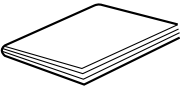
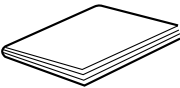
Accessory Verification

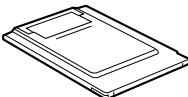
Check to confirm that the following items are included in the package when removing the projector and accessories from the box. Contact your dealer if any items are found to be missing.

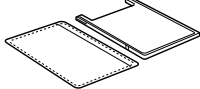
<ul style="list-style-type: none"> · Projector · Lens Cover with string 	<ul style="list-style-type: none"> · Remote Control 	<ul style="list-style-type: none"> · Two alkaline dry cells for the remote control 	
<ul style="list-style-type: none"> · Power Cord 	<ul style="list-style-type: none"> · Computer Cable (mini D-Sub 15pin/mini D-Sub 15pin) 	<ul style="list-style-type: none"> · Video/ Audio Cable (Red/White/Yellow) 	<ul style="list-style-type: none"> · USB Mouse Cable 
<ul style="list-style-type: none"> · PS/2 Mouse Cable 	<ul style="list-style-type: none"> · Owner's Manual (this document) 	<ul style="list-style-type: none"> · EasyMP User's Guide 	<ul style="list-style-type: none"> · Safety Instructions/World-Wide Warranty Terms 
<ul style="list-style-type: none"> · Memory Card Set (8Mbyte compact flash card + PC card adapter)  <p>* The memory set has been inserted into the projector.</p>	<ul style="list-style-type: none"> · EasyMP Software (CD-ROM) 	<ul style="list-style-type: none"> · Dummy card (Dummy card and card case) 	

Types of Manual

The documentation for your EPSON projector is divided into the following three manuals. The manuals cover the following topics.

- Safety Instructions/World-Wide Warranty Terms**
This manual contains information on using the projector safely, and also includes World-Wide Warranty Terms and a Troubleshooting check sheet.
Be sure to read this manual thoroughly before using the projector.
- Owner's Manual (this manual)**
This Owner's Manual contains information on installing the projector, basic operation, using the projector menus, troubleshooting and maintenance.
- EasyMP User's Guide**
This manual describes the functions of EasyMP, as installed in the projector, and how to use the "EasyMP Software" supplied with the projector.

■ Features

● Crystal clear screen

Clarity has been vastly improved.

Provides crystal clear projections even in bright areas, perfect for presentation purposes.

● Wide range of display resolution

Uses a newly-developed high resolution liquid crystal panel.

(1024×768)

● Compact and light

A compact body makes it easy for carrying around.

(approximately 2.7Kg, 6 litres)

● Supports the D output port

Supports digital tuners up to D4 ratings.

● Mounting the PCMCIA card slot

The data saved onto the memory card can be projected for presentation purposes.

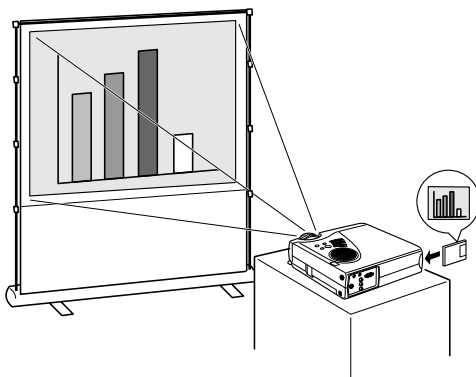

● USB port mounted

In addition to enabling the use of a USB mouse, this also allows data to be transmitted to the projector's memory card when connected to a computer (only when a list of files is displayed with EasyMP).

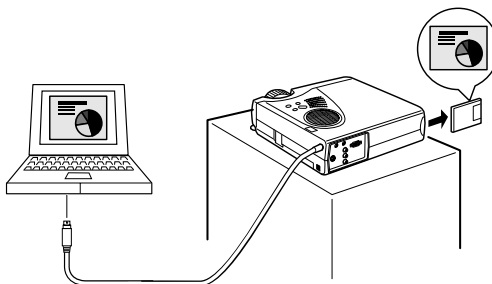

■ Contents

Features	1
-----------------	----------

Using this manual	7
--------------------------	----------

Symbol displays	7
-----------------------	---

Before Using This Equipment	8
------------------------------------	----------

Parts, Names and Operations	8
------------------------------------	----------

Projector	8
Remote Control	12
Range of Remote Control Operations	15
Inserting the Remote Control Batteries	16

Installation	17
---------------------	-----------

Installation Procedure	17
-------------------------------	-----------

Screen size and projection distance	18
Projection angles	19

Connections	20
--------------------	-----------

Connecting the projector to a computer	20
---	-----------

Eligible computers	20
In the case of the mini D-Sub 15 pin	22
Sound connection	23
Connecting external audio equipment	24
Connecting up the mouse (wireless mouse function)	25

Connecting the video equipment **27**

In the case of composite image signals	27
In the case of S image signals	27
In the case of component (color differential*) image signals	28
In the case of the digital tuner's D output port	29

Projection **30**

Projection **30**

Preparations	30
Commencing projection	32

Ending **35**

Adjusting the Projection Position **38**

Feet adjustments	38
------------------------	----

Adjusting the Projection Size **39**

Zoom adjustment	39
Keystone adjustment	40

Picture Quality Adjustment **41**

Focus adjustment	41
Auto adjustment (when projecting computer images)	41
Tracking adjustments (when projecting computer images)	42
Synchronization adjustments (when projecting computer images)	42

Introduction of Functions **43**

Useful Functions **44**

Useful Functions **44**

Help Function44

Projection Cutting **46**

A/V Mute Function46

Freeze Function46

Switching Image Sizes **47**

Enlarging Images (E-zooming function) **49**

Effect Function **50**

Cursor/Stamp50

Box51

Spotlight52

Bar53

Cancelling effects53

P in P Function **54**

Adjustment and Settings **55**

Volume Adjustment **55**

Menu Configuration **56**

Menu items56

Menu Operations **58**

Operation method58

Setting items60

Image capture64

User logo registration66

Troubleshooting **68**

Troubleshooting **68**

Operation Indicator	68
Lamp Indicator	69
Temperature Indicator	70

When the Indicators Provide No Help **71**

The image is not projected	71
The image is unclear	75
The image is cut up (Large)/Small	76
The image color is bad	77
The image is dark	77
No sound	78
The remote control will not work	78
The projector will not switch off (after the [Power] button has been pressed)	79

Maintenance **80**

Cleaning the Projector, Cleaning the Lens, Cleaning the Air Filter **80**

Cleaning the projector	81
Cleaning the lens	81
Cleaning the Air Filter	81

Replacing the Air Filter **82**

Replacement method	82
--------------------------	----

Replacing the Lamp **83**

Replacement method	84
--------------------------	----

Others **86**

Optional Parts **86**

Terminology	87
--------------------	-----------

Specifications	89
-----------------------	-----------

Index	90
--------------	-----------

■ Using this manual

Symbol displays

A variety of picture displays have been used in this manual and on the actual product to ensure that the projector is used correctly and safely in order to prevent risks to users and other people, and to prevent damage to property. Explanations for these displays are provided below. Ensure that they are fully understood before reading this manual.



Warning

Displays details that may result in death or injury if ignored.



Caution

Displays details that may result in injury or damage to property if ignored.

Point: Includes supplementary explanations and useful tips.

(See page xx): Indicates reference pages

*: Refer to the terminology

· Usage of the terms “this unit” and “this projector” in this manual

The terms “this unit” and “this projector” appear regularly in this manual, and these terms also cover the accessories supplied with the projector and other optional products.

Before Using This Equipment

This section provides explanations on parts and part names, and the items that should be verified before operating the projector.

■ Parts, Names and Operations

Projector

● Front Panel

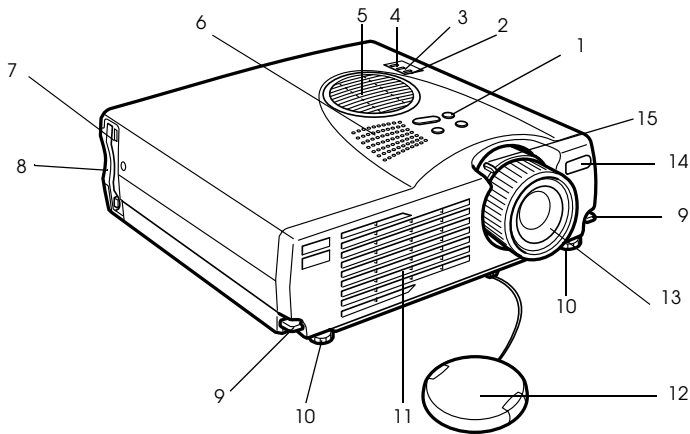

- 1 Operation Panel
- 2 Operation Indicator
- 3 Lamp Indicator
- 4 Temperature Indicator
- 5 Air Filter (ventilation inlet)
- 6 Speaker
- 7 PCMCIA Card Access Lamp
- 8 PCMCIA Card Slot
- 9 Foot Adjust Lever
- 10 Front Foot
- 11 Ventilation Outlet
- 12 Lens Cover
- 13 Focus Ring
- 14 Remote Control Light-receiving Area
- 15 Zoom Lever

● **Rear surface, Side surface**

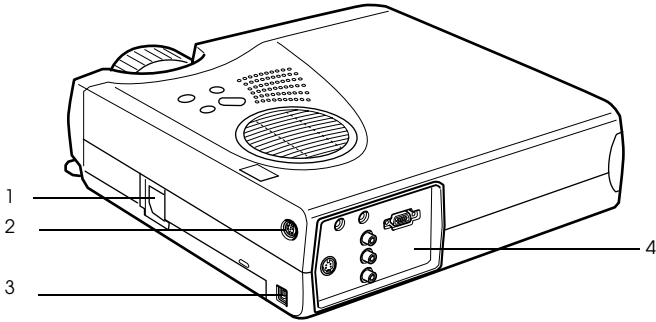

- 1 Power Inlet
- 2 Mouse/Com Port
- 3 USB Mouse Port
- 4 I/O Port

● **Rear Panel**

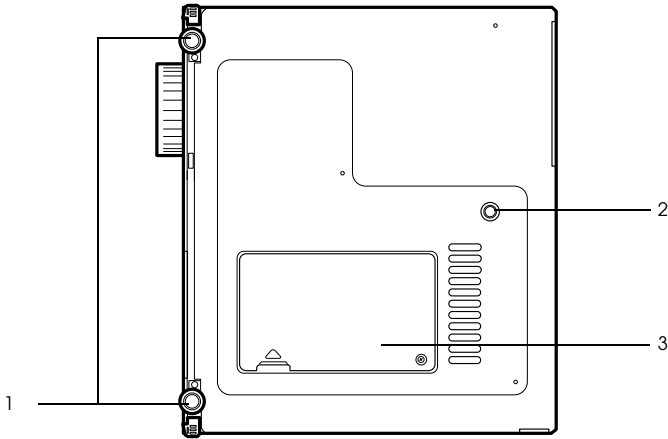

- 1 Front Foot
- 2 Rear Foot
- 3 Lamp Cover

● Operation panel (on top of the projector)

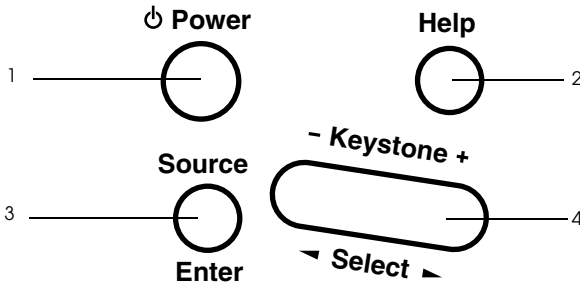

1 [Power] button (see page 32, 35)

Switches the power supply on and off.

- Press twice to switch off the power supply.

2 [Help] button (see page 44)

Displays the methods of solving problems. Press this button when trouble occurs.

3 [Source] (Enter) button (see page 33, 45)

- The projected images will be switched sequentially between Computer (component) --> S-Video --> Composite Video --> EasyMP. S-Video will not be displayed when no S-Video signals are being input. EasyMP will not be displayed when a memory card has not been inserted.
- Operates as an [Enter] button (to set selections) when the help text is displayed.

4 [Keystone] (Select) button (see page 40)

- Performs the necessary adjustments when the screen distorts into a trapezoid shape.
- This button functions as the [Select] button (vertical selection) when the help screen is displayed.

● I/O Ports

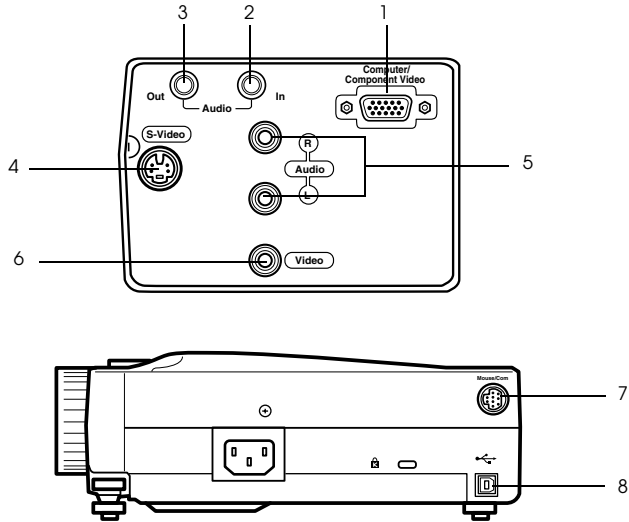

1 Computer / Component Video Port

Inputs computer analog image signals and AV equipment component image signals.

2 Audio In Port

Inputs the sound signals from equipment connected to the Computer #1 port. Use a stereo mini-jack when making the connection.

3 Audio Out Port

Outputs the projector's sound signals.

- The sound will no longer be output from the projector's speakers when a stereo mini-jack is connected here.

4 S-Video Port

Inputs the video equipment's S image signals.

5 L-Audio-R Port

Inputs the sound signals from A/V equipment connected to the Video port or the S-Video port. The connection is established with an RCA pin jack.

Only the sound for connected computers or A/V equipment is output.

6 Video Port

Inputs the A/V equipment's component image signals.

7 Mouse/Com Port

Connected to the computer when the remote control is to be used as a wireless mouse.

8 USB Mouse Port

Connect up the computer with the USB mouse cable when the remote control is to be used as a wireless mouse. Connect up the computer with the USB cable when data is to be transferred from the computer to the projector's memory card.

Remote Control

● Front Panel

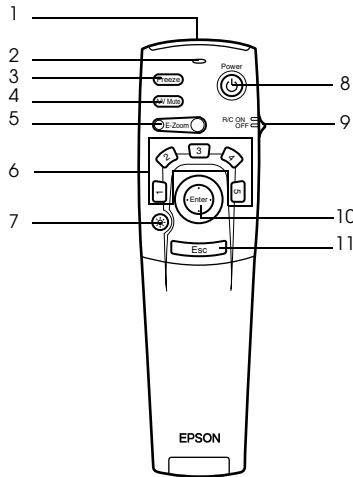

1 Remote control transmitter

Outputs the remote control unit's signals.

2 Indicator

Illuminated when the remote control unit signals are being output.

- Light will not be emitted when the batteries are getting low or when the [R/C ON OFF] switch is set at [OFF].

3 [Freeze] button (see page 46)

Temporarily freezes the image. Press this button once more to cancel the freeze mode.

4 [A/V Mute] button (see page 46)

Temporarily mutes the images and sound. To resume projection, press the button once more, adjust the volume control, or display the menu.

It is also possible to project the user logo when the A/V mute function is operating.

5 [E-Zoom] button (see page 49, 54)

Enlarges and reduces the size of the image. The image in the sub-screen will be enlarged when Picture-in-Picture images are being projected. Press the [Esc] button to cancel this function.

6 [Effect] button (see page 50)

Executes the allocated effect function. Press the [Esc] key to cancel this mode.

7 [☀ (Light)] button

The remote control button will be illuminated for approximately ten seconds.

8 [Power] button (see page 32, 35)

Switches the power supply to the projector on and off.

9 [R/C ON OFF] switch (see page 32, 36)

Switches the remote control unit on and off. The remote control unit cannot be used for operations when this switch is not set at [ON].

10 [Enter] button (see page 26, 58)

- Sets the menu item when pressed, and then moves onto the lower stage. Becomes a cursor key to select the menu items when moved up, down, left or right.
- This function operates as a left-hand click on the mouse when computer images are being projected. The pointer will move when this button is moved up, down, left or right.

11 [Esc] button (see page 26, 59)

- Ends the function being used. Returns to the previous stage when the menu or help text is being displayed.
- This function operates as a right-hand click on the mouse when computer images are being projected.

● Inside of the Cover

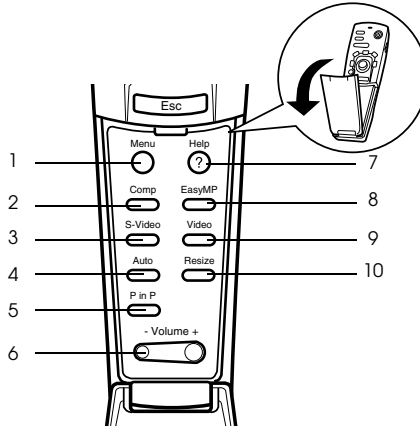

1 [Menu] button (see page 58)

Displays and ends the menu.

2 [Comp] button (see page 33)

Switches across to the image from computer port.

3 [S-Video] button (see page 33)

Switches S-video images (S-Video).

4 [Auto] button (see page 41)

Optimizes the computer image.

5 [P in P] button (see page 54)

Displays the video image within the computer image or the video image as a sub-screen. This function is cancelled by pressing this button once again.

6 [Volume] button (see page 55)

Adjusts the volume.

7 [Help] button (see page 44)

Displays the method of solving problems. Press this button when trouble occurs.

8 [Easy-MP] button (see page 33)

Switches the memory card data across to the projected Easy-MP images.

9 [Video] button (see page 33)

Switches across to the video images.

10 [Resize] button (see page 47)

Switches between the window display and the resizing display when computer images are being projected. Switches the aspect ratio between 4:3 and 16:9 when video images are being projected.

● **Rear Panel**

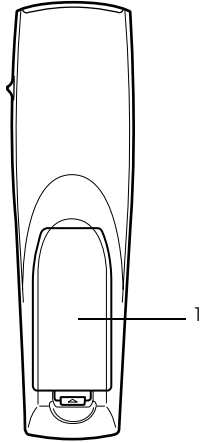

1 Battery Cover

Range of Remote Control Operations

Depending on the distance and angle from the main unit's light receiving area, there are cases where the remote control will not function. Ensure that the remote control is used within the following conditions:

● **Operable distance: Approximately 10 metres**

● **Operable range:**

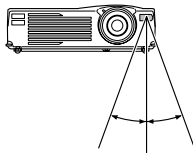

Approximately 30 degrees to the left and right



Approximately 15 degrees up and down

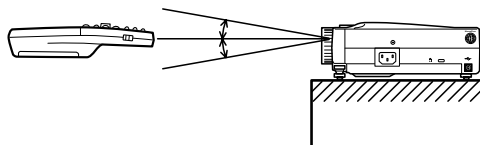

Point

- Ensure that the [R/C ON OFF] switch is set at [ON] when using the remote control unit.
 - Aim the remote control at the projector's light-receiving area.
 - There are cases where the operable distance (approximately 10 meters) of the remote control is diminished when signals are reflected off screens depending on the type of screen in use.
 - Ensure that sunlight and florescent lighting is not shining directly into the projector's light-receiving area.
 - If the remote control will not function or malfunctions, there is a possibility that the batteries need changing. In this event, replace the batteries accordingly.
-

Inserting the Remote Control Batteries

The remote control batteries are inserted in accordance with the following procedure:

⚠ Caution

Ensure that unused batteries of the same type are used.

1 Remove the Battery Cover.

Apply pressure to the clip holding the Battery Cover, and then lift it upwards.

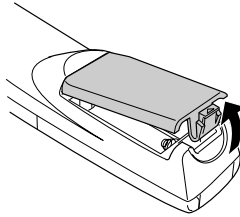

2 Insert the batteries.

Ensure that the batteries are aligned correctly with the "+" and "-" labels on the remote control.

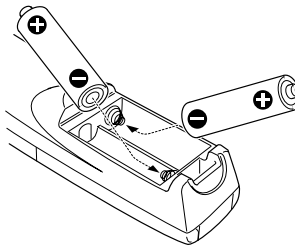

3 Replace the cover.

Apply pressure to the battery cover until it clicks firmly into place.

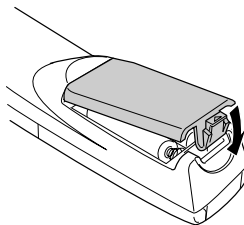

Point

- Specified batteries: Two alkaline dry cells LR6 (AA).
 - The batteries should be replaced approximately once every three months when used for thirty minutes per day.
-

Installation

This section provides an example of projector installation, and explanations on the projection distances and projection angles.

■ Installation Procedure

This section provides an example of projector installation, and explanations on projection distances and angles.

Caution

- Do not block the ventilation outlet on the front of the projector, or the air filter (suction inlet) on the top.
- Take note that there is a possibility that pieces of cloth or paper may be sucked into the air filter on the top of the projector during projection.
- Do not place the projector in a location where it is subject to the direct air flow from air conditioners or heaters.
- When the projector is to be placed near a wall, ensure that there is at least 20cm of space between the wall and the projector.
- Do not cover the projector with table cloths or other material.

Screen size and projection distance

Determines the distance that the screen must be from the lens in order to obtain the required screen size.

The projector's Standard Lens is approximately a 1.2x zoom lens and the largest screen size is about 1.2 times the size of the smallest screen.

Using the following table for reference purposes, install the projector so that the screen size is smaller than the screen.

Screen Size	Approximate Projection Distance
30-inch (61×46cm)	1.1m to 1.3m
40-inch (81×61cm)	1.5m to 1.8m
60-inch (120×90cm)	2.2m to 2.7m
80-inch (160×120cm)	3.0m to 3.7m
100-inch (200×150cm)	3.8m to 4.6m
120-inch (224×183cm)	4.6m to 5.4m
150-inch (305×229cm)	5.7m to 6.9m
200-inch (410×300cm)	7.6m to 9.2m
300-inch (610×460cm)	11.5m to 13.9m

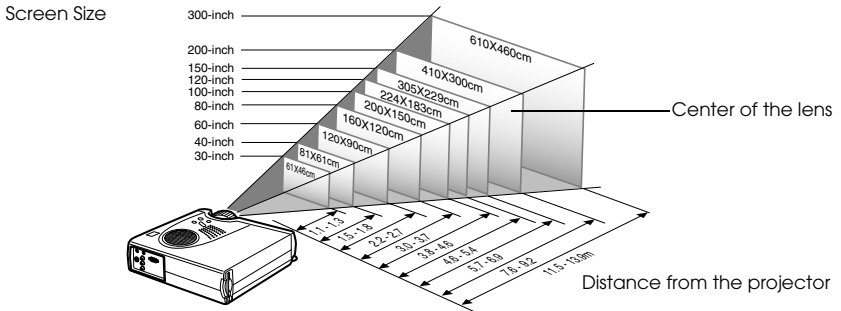

Point

- The screen size will become smaller when the trapezoid correction function is used.
- Install the projector at least 20cm away from the wall.

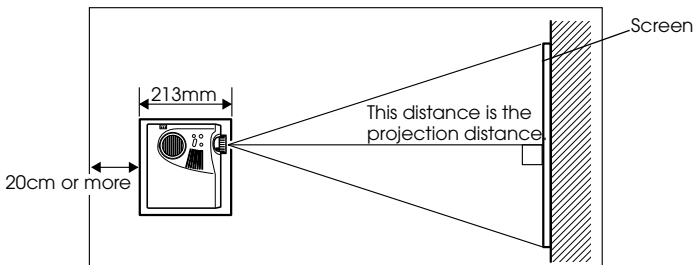

Projection angles

The optimum projection screen is acquired by placing the center of the projector's lens and a right-angle to the screen.

When viewing from the side

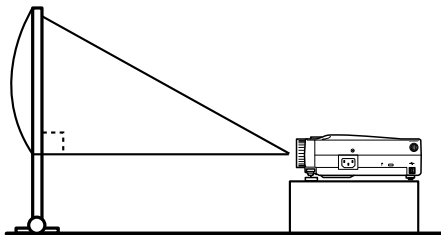

A:B 10: Becomes 0

When viewing from the top or bottom

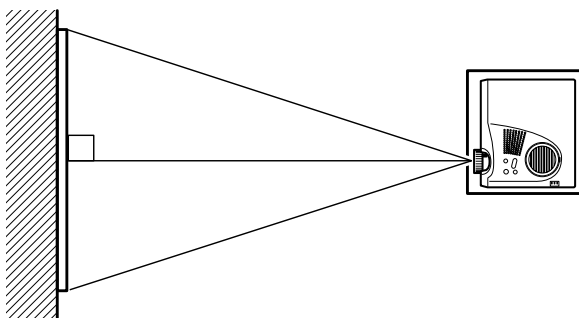

Point

Although the projection angle can be adjusted with the front foot (see page 38), there are cases where the screen will distort into a trapezoid shape. In this event, adjust the trapezoid distortion with the trapezoid correction function. (see page 40)

Connections

This section provides explanations on connecting the projector to computers and video equipment.

■ Connecting the projector to a computer

Switch off the power supply to the projector and computer before attempting to make the connection.

Eligible computers

There are computers with which connections cannot be established and computers that cannot be used for projection purposes even though a connection has been established. First of all, it is necessary to confirm that a connection can be established with the computer in use.

● Conditions for eligible computers

Condition #1: The computer must be fitted with an image signal output port.

Check to ascertain that the computer is fitted with ports that will output image signals, such as the [RGB Port], the [Monitor Port] and the [Video Port]. If you have trouble confirming this, refer to chapter on external monitor connections in the computer's instruction manual.

There are computers, such as combined computer/monitor models and laptop models, that do not allow connections or for which optional external output ports must be purchased.

Point

Depending on the computer, there are cases when it is necessary to switch the image signal output with the connection key (≡□, etc.) and the settings.

NEC	Panasonic	Toshiba	IBM	SONY	FUJITSU	Macintosh
Fn+F3	Fn+F3	Fn+F5	Fn+F7	Fn+F7	Fn+F10	Mirroring is set up with monitor adjustments on the control panel after starting up.

The table shown above provides examples for certain products. Refer to the computer's instruction manual for further details.

Condition #2: The resolution and frequency of the computer must be within the boundaries listed in the chart below.

Projection will not be possible if the computer does not support the output image signal resolutions and frequencies shown in the chart below (there are cases where projection is possible, but vivid projection will not be possible).

Confirm the image signal resolution and frequency with the computer's instruction manual.

There are also computers available that allow the output resolution to be amended. In this case, amend the parameters to fit within the ranges shown in the chart below.

Signal	Refresh Rate (Hz)	Resolution (Dots)	Pixels (dots) Used During Resizing Display (Resize On)	Pixels (dots) Used During Real Display (Resize Off)	Remarks
VGAEGA		640×350	1024×560	640×350	
VGA	60	640×480	1024×768	640×480	
VGA Text		720×350	1024×640	720×350	
		720×400	1024×640	720×400	
VESA	72/75/85	640×480	1024×768	640×480	
SVGA	56/60/72/75/85	800×600	1024×768	800×600	
XGA	43i/60/70/75/85	1024×768	1024×768	1024×768	
SXGA	70/75/85	1152×864	1024×768	1152×864	Virtual (Partial) Display
SXGA	60/75/85	1280×960	1024×768	1280×960	Virtual (Partial) Display
SXGA	43i/60/75/85	1280×1024	960×768	1280×1024	Virtual (Partial) Display
UXGA ^{*1}	60	1600×1200	1024×768	1600×1200	Virtual (Partial) Display
MAC13		640×480	1024×768	640×480	
MAC16		832×624	1024×768	832×624	
MAC19		1024×768	1024×768	1024×768	
MAC21		1152×870	1016×768	1152×870	Virtual (Partial) Display
NTSC			1024×768	1024×576	4:3 ↔ 16:9, Selectable
PAL			1024×768	1024×576	4:3 ↔ 16:9, Selectable
SECAM			1024×768	1024×576	4:3 ↔ 16:9, Selectable
SDTY (480i/P)	60		1024×768	1024×576	4:3 ↔ 16:9, Selectable
HDTV (720P)16:9			1024×576		
HDTV (1080i)16:9					

^{*1}The EMP-505 is not compatible with UXGA.

In the case of the mini D-Sub 15 pin

⚠ Caution

- Switch off the power supply to the projector and computer before attempting to make the connection. Failure to observe this may result in damage.
- Confirm the shape of the cable connector and the shape of the port before making the connection. Applying excessive force when the direction or shape of the connector and port differ may result in defects and damage to the equipment.
- Connect the computer's monitor port to the projector's Computer/Component Video port with the computer cable supplied.

● When the monitor port is the D-Sub 15 pin

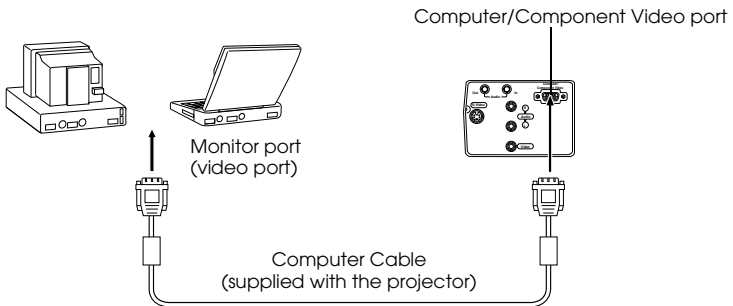

Point

- Set the input signal parameter on the image menu to [RGB] once the connection has been established.
- Do not bunch the power cable and the computer cable together. Failure to observe this may result in noise appearing in the images, and may cause malfunctions.
- An adapter may be required when making the connection depending on the stand of the computer's port. Refer to the computer instruction manual for further details.
- An optional MAC Adapter Set (ELPAP01) is required when connecting up to a Macintosh computer.

● When the monitor port is 13w3

The Computer/Component Video port is also connected to the D-Sub 15 port with the use of the conversion cable when the 13w3 port is used for connecting the computer's monitor port to a work station.

- Connect the computer's monitor port (13w3) to the projector's Computer/Component Video port with a 13w3 cable (available on the open market).

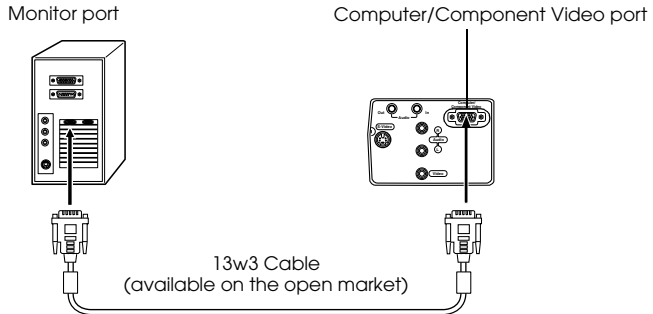

Sound connection

The projector is equipped with a single speaker capable of outputting a maximum of 1W, and it is possible to output computer sound from the projector's speaker. Connect the computer's Audio Out port to the projector's Audio In port (stereo mini-jack) with an audio cable (available on the open market).

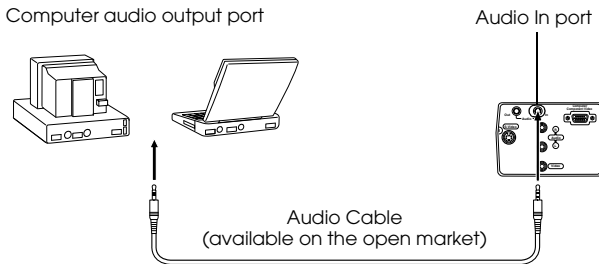

Point

The audio signals output the selected image's sound.

Connecting external audio equipment

It is possible to enjoy dynamic sound by connecting the Audio Out port on the projector to a PA system, an active speaker system, or other speakers equipped with built-in amplifiers.

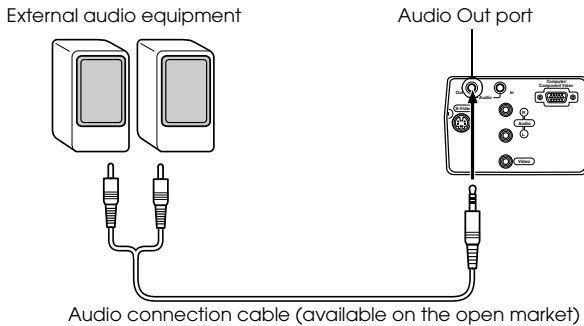

Use audio connection cables available on the open market (pin plug <--> 3.5mm stereo mini-jack plug).

Point

- The sound will be output externally if a stereo mini-jack is inserted into the Audio Out port. The sound will not be emitted from the projector's speakers at this time.
 - The sound on the images being projected will be output.
 - Purchase an audio connection cable that matches up with the connector on the external audio equipment to be used.
-

Connecting up the mouse (wireless mouse function)

This enables the computer's mouse pointer to be operated with the remote control in the same way as a wireless mouse.

Connect the computer's mouse port to the projector's Mouse/Com port or USB mouse port with the mouse cable.

Computer	Mouse to use	Mouse cable to use
PC/AT DOS/V	PS/2 mouse	PS/2 mouse cable (supplied)
	USB mouse	USB mouse cable (supplied)
Macintosh (OS9 or higher)	USB mouse	USB mouse cable (supplied)

PS/2 mouse connection

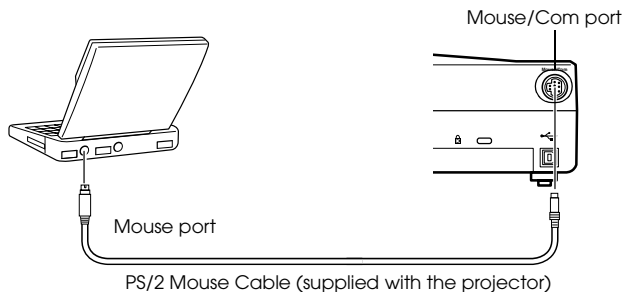

USB mouse connection

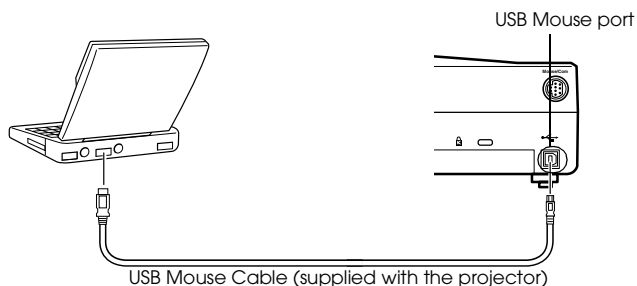

Refer to the above table before making your selection.

Point

- Only the USB standard mounted model supports USB Mouse Cable connections. In the case of Windows, only the Windows 98/2000/Me preinstalled model is supported. Operations cannot be guaranteed on upgraded Windows 98/2000/Me environments. Supports OS9 and higher with the Macintosh environment. There are cases where it is not possible to use a mouse with both the Windows and Macintosh platforms depending on the version of the OS.
- There are cases where certain settings must be made on the computer in order to use a mouse. Refer to the computer's instruction manual for further details.
- Switch off the power supply to the projector and computer prior to making the connection.
- The computer will require rebooting if it does not work.
- Consult with your vendor if with to use a serial mouse, or ADB mouse on a Macintosh.

Perform the following mouse operations after the connection has been established:

Left click ----- Press the [Enter] button.

Right click ----- Press the [Esc] button.

Mouse pointer movement --- Lower the remote control [Enter] button.

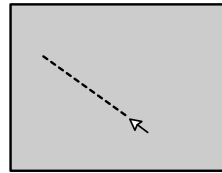
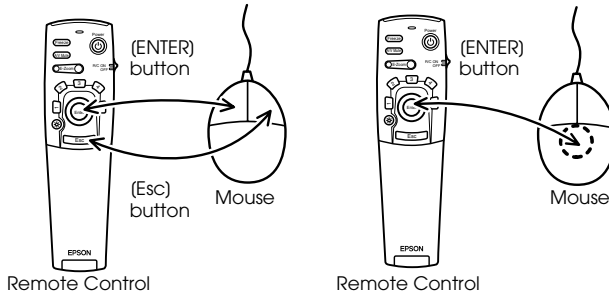

Point

- The operations will be reversed if the left/right button functions of the mouse pointer have been amended with the computer.
- The mouse cannot be used when the menu is being displayed, when the effect, Picture-in-Picture or E-zoom functions are in use, or when the size of the image is set for real display(resize off).
- The movement speed of the mouse pointer can be changed. ([see page 61](#))

■ Connecting the video equipment

Switch off the power supply to the projector and video equipment prior to attempting to make the connection.

Point

The sound for the selected image will be output.

In the case of composite image signals

- Connect the video port, the projector's video port and the L-Audio-R port with the video/audio cable (red/white/yellow) supplied.

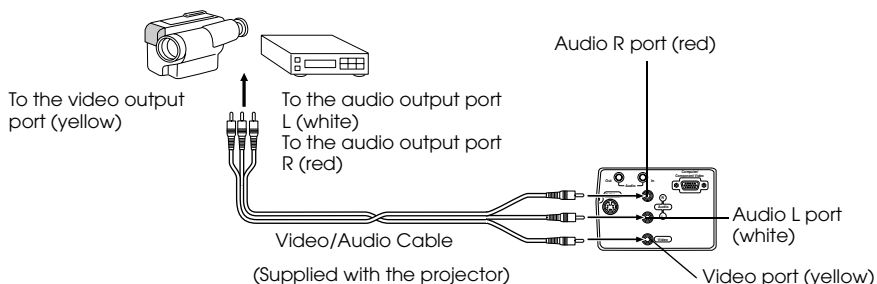

In the case of S image signals

- Connect the projector's S-Video port to the video equipment with the S-Video cable (available on the open market).
- Connect the L-Audio-R ports with the video/audio Cable (red/white/yellow) supplied to output the sound from the projector's speaker.

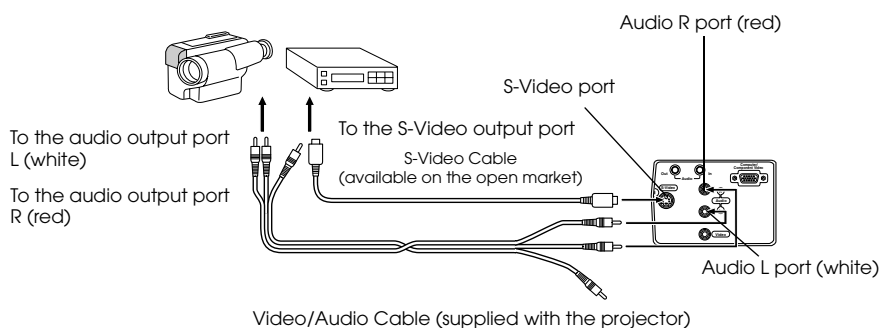

In the case of component (color differential*) image signals

- Connect the video equipment to the projector's Computer/Component Video port with the optional component video cable (ELPKC19.)
- Connect the L-Audio-R ports with the video/audio cable supplied (red/white/yellow) to output sound from the projector's speakers.

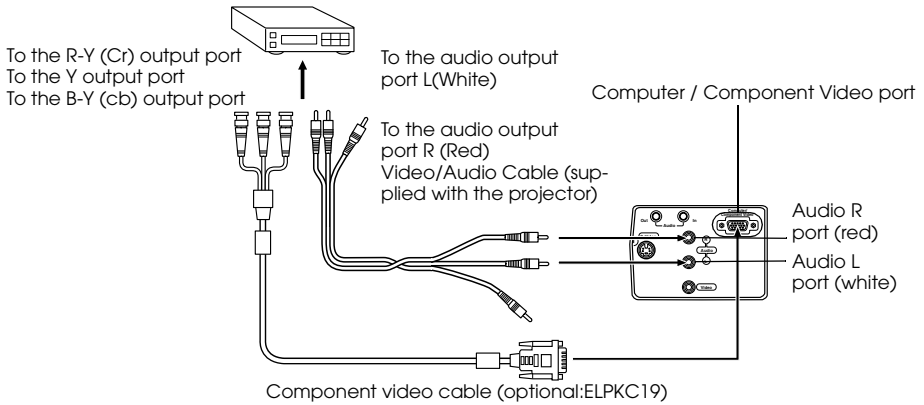

Point

Set the input signal parameter on the image menu to [YCbCr] or [YPbPr] in accordance with the equipment's signals after the connection has been established.

In the case of the digital tuner's D output port

- Connect the digital tuner to the projector's Computer/Component Video port with the optional D port cable (ELPKC22).
- Connect the L-Audio-R ports with the video/audio cable supplied (red/white/yellow) to output sound from the projector's speakers.

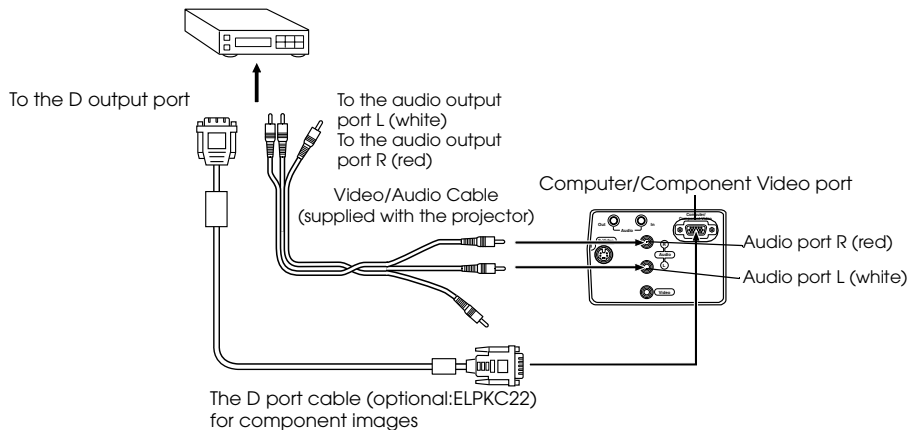

Point

- Set the image menu's input signals to either [YCbCr] or [YPbPr] in accordance with the equipment being used when establishing the connections. (see page 60)
 - Establishing connections with digital tuners is only possible in Japan.
 - Supports digital tuners up to the D4 rating.
-

Projection

This section provides explanations on starting and ending projection, and on the basic functions for adjusting projected images.

■ Projection

Images can be projected after all connections have been completed.

Preparations

⚠ Warning

- Never look directly into the lens once the power supply has been switched on. Failure to observe this may result in the powerful light damaging eyesight.
- Ensure that the Power Cord supplied is used. The use of cables other than the one supplied may result in the outbreak of fire or electric shocks.

⚠ Caution

Do not perform any projection tasks with the Lens Cover attached. Failure to observe this may result in the cover becoming malformed due to heat.

1 Connect the projector to a computer and video equipment. (see page 20, 27)

2 Rotate the zoom lever to the central position to extend the lens.

Images will be out of focus when projected if the zoom lever is not moved to the central position.

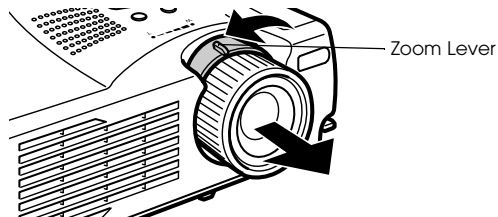

3 Remove the Lens Cover.

4 Attach the supplied Power Cord to the projector.

Check to confirm the shape of the projector's Power Inlet and Power Connector, align the connector in the correct direction, and then insert it as far as it will go.

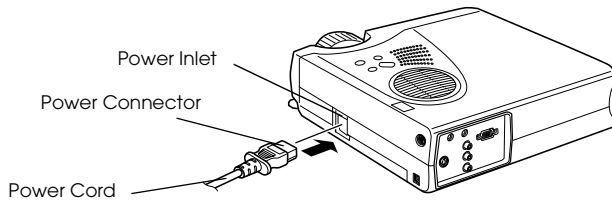

5 Plug the Power Plug into the power socket.

The Operation Indicator will be illuminated in orange.

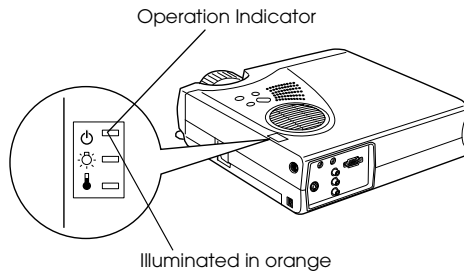

Point

Button operations are not possible when the Operation Indicator is blinking in orange.

Commencing projection

1 Press the [Power] button to turn on the power supply.

The Operation Indicator will begin to blink in green, and projection will be started.

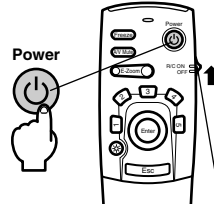
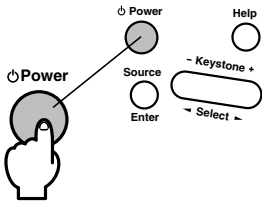

Set the R/C ON OFF switch to (ON) first of all when using the remote control unit

The operation indicator will change from blinking to being illuminated in green after a while.



A message stating (No image signals being input) will be displayed when no image signals are being input. (Note that there are cases where this will not be displayed depending on the no-signal display setting.) (see page 62)

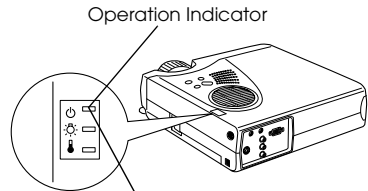

Blinking in green → Illuminated

Point

Button operations are not possible when the Operation Indicator is blinking in green.

2 Open the remote control cover when a remote control is to be used.

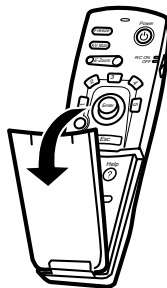

3 Select the Port to which the connection has been made when more than one item of equipment has been connected.

Press the port button connected to the computer or video equipment to switch the input source.

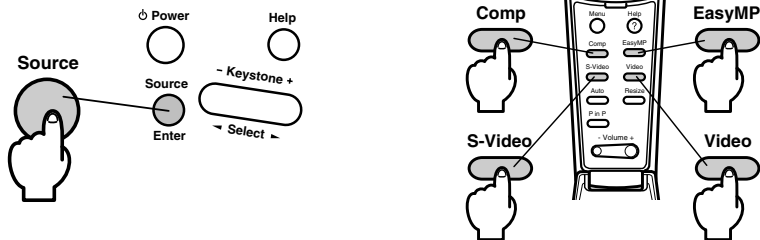

Image	Button to Select		Display at the top right-hand corner of the screen
	Main Unit	Remote Control	
Computer (Component)	[Source] (will change whenever pressed)	[Comp]	Computer
Video		[Video]	Video
S-Video		[S-Video]	S-Video
Memory card		[EasyMP]	[EasyMP]

Point

- Projection will take place without pressing the button if only one item of equipment is connected.
- It is not possible to switch across to S-Video with the [Source] button when no S-Video input exists.
- It is not possible to switch across to EasyMP with the [Source] button when a memory card has not been inserted.

4 Starting projection.

Switch on the power supply to the computer or video equipment. If the equipment connected is video equipment, then also press the [Playback] or [Play] buttons.

The [No Signal] display will be erased, and projection will commence.

Point

- If [No Signal] remains displayed, check the connections once again.
- Depending on the computer, there are cases when it is necessary to switch the image signal output destination with the key (\square , etc.) or the settings after establishing the connection.

NEC	Pana-sonic	Toshiba	IBM	SONY	FUJITSU	Macintosh
Fn+F3	Fn+F3	Fn+F5	Fn+F7	Fn+F7	Fn+F10	Mirroring is set up with monitor adjustments on the control panel after starting up.

The table shown above provides examples for certain products. Refer to the computer's instruction manual for further details.

- Press the [Resize] button when signals that support DVD players or wide television screens (16:9 images) have been input. The parameters will change between 4:3 images and 16:9 images whenever the switch is pressed.
 - There are cases where a projected image will remain projected if a still image is projected for a long period of time.
-

Ending

End projection in accordance with the following procedure.

1 Switch off the power supply to the connected equipment.

2 Press the [Power] button.

A message to confirm that the power needs to be switched off will be displayed.

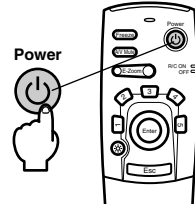
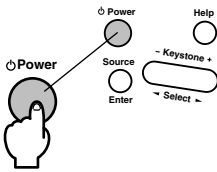

3 Press the [Power] button once more.

The lamp will be extinguished, the Operation Indicator will blink in orange, and the cool-down process will commence.

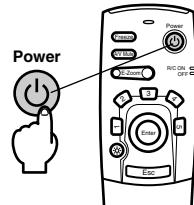
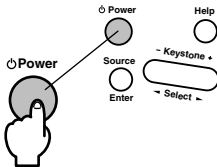
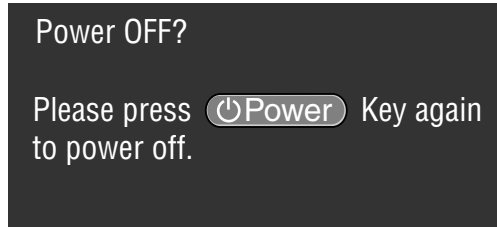

The Operation Indicator will change from blinking to being illuminated in orange once the cool-down process has been completed. The cool-down period will take approximately ninety seconds (depending on the surrounding temperature).

Point

- Press a different button if you do not want to turn off the projector. The message will be erased after seven seconds if no buttons are pressed (the power will remain on).
- Button operations are not possible when the Operation Indicator is blinking in orange. In this event, please wait until full illumination has been attained.

- 4** Check to ascertain that the cooling down period has ended (the operation indicator will be illuminated in orange), and then remove the power plug from the socket.

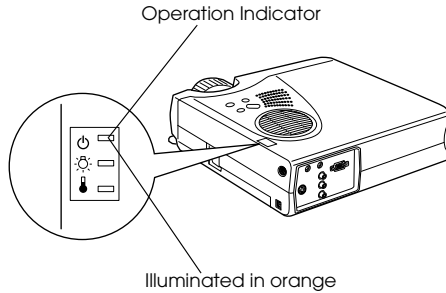

⚠ Caution

Do not remove the Power Plug from the socket when the Operation Indicator is blinking in orange. Failure to observe this may result in damage to the equipment and will speed up the period for replacing the lamp.

- 5** Set the R/C ON OFF switch to [OFF] when not using the remote control.

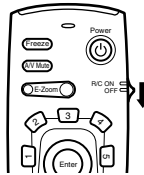

Point

The batteries are being consumed when the [R/C ON OFF] switch on the remote control unit is set at [ON]. Ensure that the [R/C ON OFF] switch on the remote control unit is set to [OFF] when not in use.

- 6** Restore the Front Foot if it has been extended.

Steady the projector by hand, and then lift the Foot Adjust Lever with a finger and gently lower it into the main Unit.

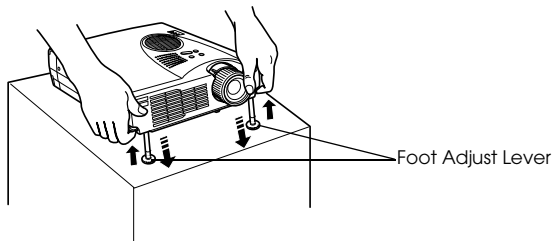

7 Attach the lens cover.

8 Rotate the zoom lever to store the lens inside the projector.

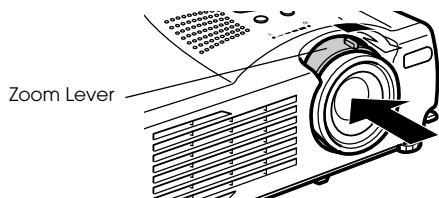

■ Adjusting the Projection Position

The projector can be adjusted into the following vertical projection positions.

Feet adjustments

Adjusts the projection angle of the projector.

- 1** Lift the Foot Adjust Lever with a finger and raise the front part of the projector.
The Front Foot will protrude.

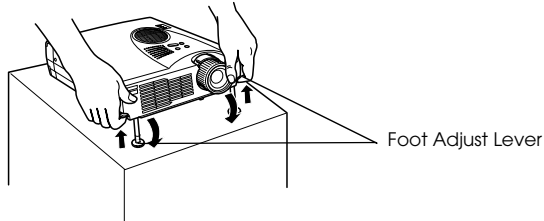

- 2** Remove your finger from the Foot Adjust Lever, and then let go of the projector.
- 3** Rotate the lower part of the Front Foot to minutely adjust the height.

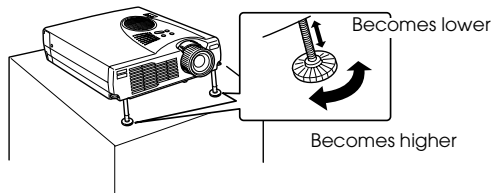

Point

- There are cases where the screen will be distorted into a trapezoid shape when foot adjustments are performed. This trapezoid distortion can be adjusted with the use of the keystone correction function. (see page 40)
 - The Front Foot is restored by lifting the Foot Adjust Lever with a finger and lowering the projector.
-

■ Adjusting the Projection Size

It is possible to adjust the size of the projection and correct any trapezoid distortion.

Point

A function to resize the screen ([see page 47](#)) and an E-Zoom function for enlarging certain areas ([see page 49](#)) are also available.

Zoom adjustment

- 1 Turn the zoom lever to make the adjustment (enlargement up to 1.2X is possible).

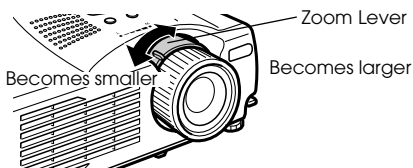

The projection distance must also be adjusted when enlarging the screen. ([see page 18](#))

Point

Set the zoom lever between the [W] and [T] positions during projection. If the lever is set at a position that exceeds the adjustable range from the [W] (center) position, the lens will be stored inside the projector and the images will be out of focus.

Keystone adjustment

Make the necessary adjustment when the screen has been distorted into a trapezoid with foot adjustment.

1 Press the [Keystone +, -] button on the projector to change the screen into a rectangle.

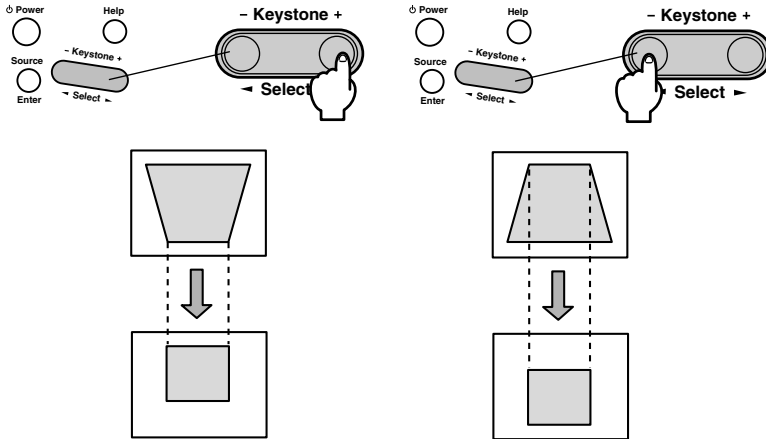

The corrected screen will shrink in size.

The corrected screen will shrink in size.

It is possible to make adjustments with keystone correction (through 30 stages) as long as the tilt angle of the projector is within a maximum vertical range of approximately 15 degrees.

The maximum value of the tilt angle will differ slightly in accordance with the projected size adjusted with the zoom.

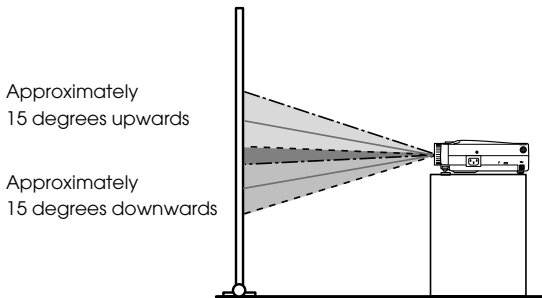

Point

- The screen will be reduced in size when keystone correction has been performed.
- The details of trapezoid correction will be stored. This must be readjusted to match the installation status after the projection position and angle have been amended.
- Reduce the sharpness if blurring occurs after keystone correction. ([see page 60](#))
- Keystone correction is performed from the menu. ([see page 62](#))

Picture Quality Adjustment

Adjusts image focus and disturbance.

Focus adjustment

Aligns the focus of the image.

- 1 Rotate the Focus Ring to make the required adjustment.

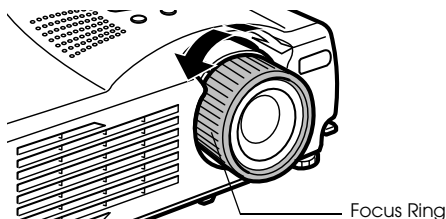

Point

- It is not possible to align the focus if the lens is dirty or fogged over with condensation. In this event, clean the lens accordingly. (see page 81)
- Correct adjustment is not possible if the installation position is out of line by between 1.1 to 13.9 meters.
- Images will be out of focus if the position of the zoom lever is outside of the [W] to [T] range.

Auto adjustment (when projecting computer images)

Automatically adjusts the computer image to attain the optimum effect. The items adjusted include the Tracking, Position and Sync.

- 1 Press the [Auto] button on the remote control.

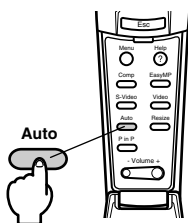

Point

- If auto adjustments are initiated when the E-Zoom, A/V Mute or P in P functions are executing, adjustment will not be carried out until the executing function has been cancelled.
- Depending on the type of signals being output by the computer, there are cases when adjustment cannot be carried out correctly. In this event, adjust the Tracking and Sync. (see page 42)

Tracking adjustments (when projecting computer images)

Adjusted when vertical stripes are apparent on the computer image.

- 1** Make the adjustment with the [Menu] - [Video] - [Tracking] function.

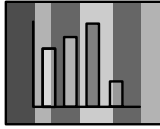

Synchronization adjustments (when projecting computer images)

Adjusted when flashing, blurring and vertical noise are apparent on the computer image.

- 1** Make the adjustment with the [Menu] - [Video] - [Sync.] function.

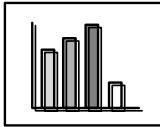

■ Introduction of Functions

The functions that can be operated by pressing buttons when images are being projected are listed below.

Function	Outline	Button		Reference Page
		Main Unit	Remote Control Unit	
Help	Displays the method of solving problems when trouble occurs.	Help	Help	44
A/V Mute	Temporarily mutes the image and sound.	-	A/V mute	46
Freeze	Temporarily pauses image movement.	-	Freeze	46
Resize	Changes the size of the image.	-	Resize	47
E-Zoom	Enlarges a part of image.	-	E-Zoom	49
Effect	Adds decorations to the image.	-	[1]-[5] (Effect)	50
P in P	Adds a sub-screen to the image.	-	P in P	54
Keystone correction	Corrects trapezoid correction.	Keystone	-	40
Auto adjustment	Automatically adjusts the image for optimum effect.	-	Auto	41
Volume	Adjusts the volume.	-	Volume	55
Menu	Displays the menu.	-	Menu	58

Useful Functions

This section provides explanations on the effective and useful functions, such as presentations, available with this projector.

Useful Functions

Help Function

The methods of solving trouble when it occurs are divided into separate sections and explained below for use when problems arise.

1 Press the [Help] button.

The help menu will be displayed.

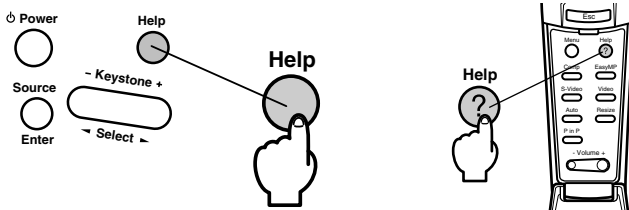

2 Select the item.

Press the [Select] button on the main unit (move the [Enter] button up and down on the remote control) to select the item.

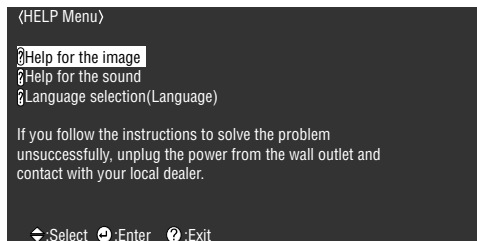

3 Set the item.

Press the [Enter] button to select the required item.

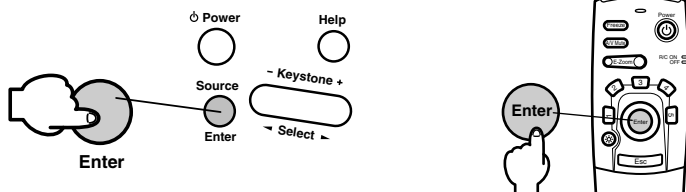

4 Repeat the operations explained in procedures 2 and 3 to select and set the detailed items.

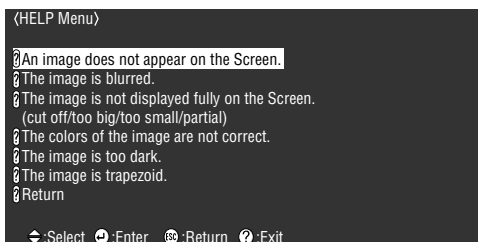

Point

- Refer to [Troubleshooting] in this manual if the help text does not solve your problems. (see page 68)
- The help menu can be cancelled by pressing the [Help] button.

■ Switching Image Sizes

Switches between the window display and the resize display when projecting computer images. Switches between an aspect ratio of 4:3 and 16:9 when projecting video images.

1 Press the [Resize] button on the remote control.

The screen size will switch.

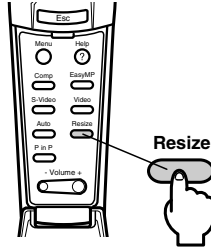

● In the case of computer images

Window display: Projects with the input resolution (real display). There are cases where the size of the projection and the size of the image will differ.

Resize display: Reduces or enlarges the resolution so that the size of the projection fits the entire screen.

(Example) When the input resolution is smaller than the display resolution (in the case of 800 x 600)

Resize Display

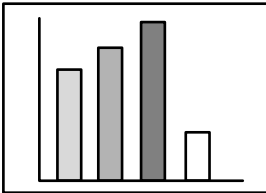

Window Display

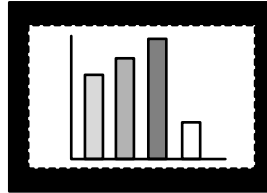

**(Example) When the input resolution is greater than the display resolution
(in the case of 1600 x 1200)**

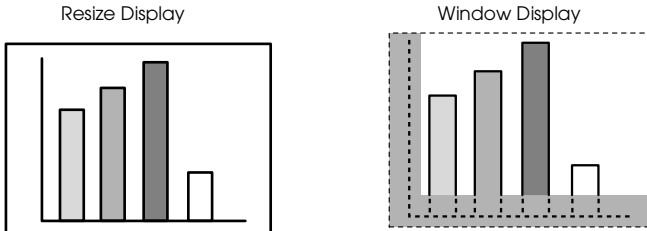

Lower the (Enter) button on the remote control to enable scrolling.

Point

- The size will not be switched if the display resolution of the liquid crystal is the same as the entered resolution (1024 x 768 dots).
- A certain portion of the image will not be displayed if the entered resolution is larger than the display resolution of the liquid crystal. Lower the [Enter] button on the remote control unit to scroll through the areas not displayed.

● In the case of video images

Switching will be performed for 4:3 and 16:9 image sizes. Images recorded with digital videos and DVD images can be projected on 16:9 wide screens.

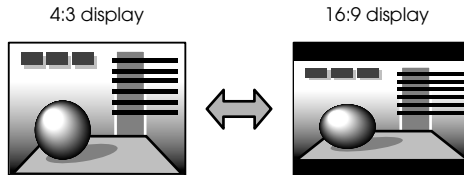

■ Enlarging Images (E-zooming function)

The projected size will remain as it is while the image will be proportionally enlarged.

1 Press the [Zoom] button on the remote control.

The size percentage will be displayed in the bottom right-hand corner to enable the image to be reduced or enlarged.

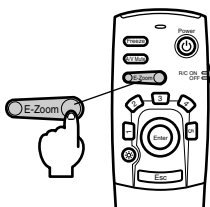
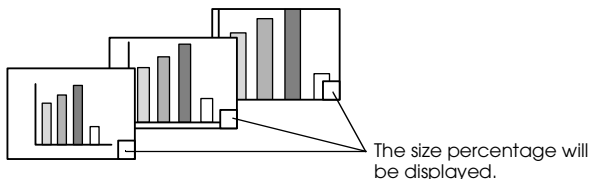

Press the [Esc] button on the remote control to cancel the setting.

Point

- Enlargement is possible with 24 stages between 1x and 4x at increments of 0.125x.
 - A certain portion of the image will not be displayed when it has been enlarged. Lower the [Enter] button on the remote control to scroll the screen and display this portion accordingly.
 - Sub-screens will be enlarged when the P in P function is being used.
-

■ Effect Function

Effects can be added to the presentation images with the use of the [Effect] buttons on the remote control. The effects used can be amended on the [Effect] screen. (see page 61)

Cursor/Stamp

Imprints a stamp on the image.

1 Press the [1] button on the remote control.

The Cursor/Stamp will be displayed.

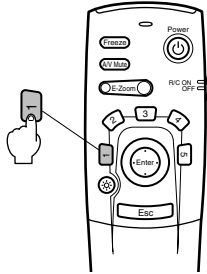

2 Lower the [Enter] button on the remote control unit to move the position of the cursor/stamp.

3 The stamp will be imprinted at the location of the cursor when the [Enter] button on the remote control unit has been pressed.



Point

- The effect function will be canceled and the cursor will disappear when the [Esc] or [5] button is pressed.
 - The mouse cannot be used when the effect function is in progress.
-

Box

Draws a Box on the image.

1 Press the [2] button on the remote control.

A box will be displayed.

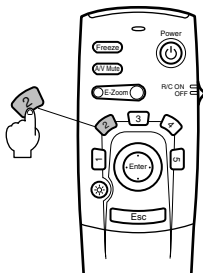

2 Lower the [Enter] button on the remote control unit to move the cursor to the starting position.

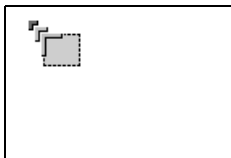

3 Press the [Enter] button to set the start position.

4 Lower the [Enter] button on the remote control unit to move the cursor to the ending position.

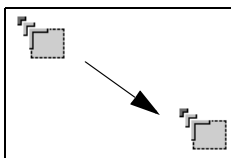

5 Press the [Enter] button to set the end position.

Point

- The decoration will be erased when the [5] button is pressed.
 - There are cases where the effect will be difficult to see depending on the color combination of the image's background and four corners. Amend the color of the corners in this event. ([see page 61](#))
 - The mouse cannot be used when the effect function is in progress.
-

Spotlight

Shines a spotlight on a certain part of the image.

1 Press the [3] button on the remote control.

The spotlight will be displayed.

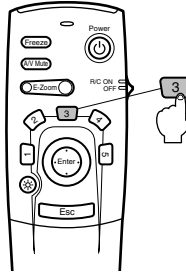

2 Lower the [Enter] button to move the spotlight.

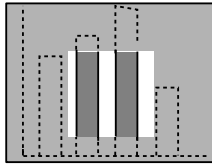

Point

- The effect function will be cancelled and the spotlight will disappear when the [Esc] or [5] button is pressed.
 - The mouse cannot be used when the effect function is in progress.
-

Bar

Draws a bar line on the image.

1 Press the [4] button on the remote control.

A bar will be displayed.

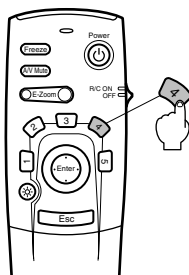

2 Press the [Enter] button to set the end position.

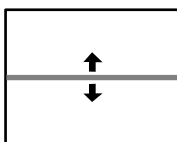

Point

- The effect function will be cancelled and the bar will disappear when the [Esc] or [5] button is pressed.
 - There are cases where the effect will be difficult to see depending on the color combination of the image's background and the bar. Amend the color of the bar in this event. ([see page 61](#))
 - The mouse cannot be used when the effect function is in progress.
-

Cancelling effects

1 Press the [5] button on the remote control.

The box and bar decorations will all disappear.

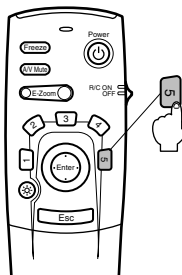

■ P in P Function

It is possible to display a video image as a sub-screen within a computer image or component video image. It is also possible to output the sound.

1 Press the [P in P] button on the remote control.

An operation guide will be displayed in the lower left-hand corner of the screen and the sub-screen will be displayed at the upper right-hand side of the screen.

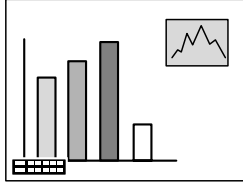

2 Press the [Enter] button on the remote control to move the position of the sub-screen.

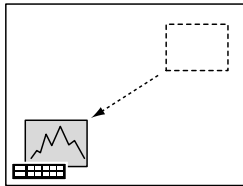

3 Press the [E-Zoom] button to change the size of the sub-screen.

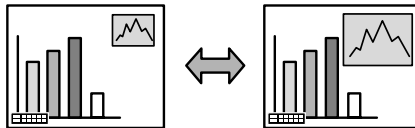

4 Press the [Enter] button to set the sub-screen display.

Point

- The sub-screen will be erased when the [P in P] button is pressed again.
 - The computer image or video image (only component video image signals) will be displayed in the main screen, and the video image (Video, S-Video) will be displayed in the sub-screen. The video image displayed in the sub-screen can be amended with the P in P setting. (see page 62)
 - Adjust the position and size of the sub-screen prior to displaying it.
 - The sub-screen can be switched between five different sizes.
 - When the position of the sub-screen has been amended, it will be displayed in the previously determined position the next time the Picture-in-Picture function is executed.
-

Adjustment and Settings

This section provides explanations on adjusting the projector volume and on setup menu operations.

■ Volume Adjustment

The volume can be amended when sound is emitted from the projector speakers.

- 1 Press the [Volume +, -] button on the remote control.

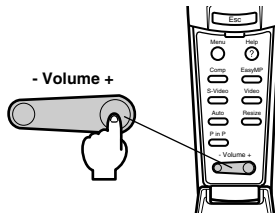

Point

- Adjustment is not possible when no sound signals are being input.
- Adjustment is possible when outputting sound to external speakers.

Menu Configuration

The menu enables the various adjustments and settings to be made.

Menu items

The menus are split into top menus and sub menus and consist of a hierarchy structure. Also, the image menu will differ in accordance with the input source (connected port).

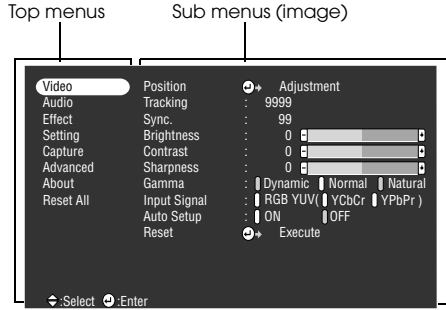

Menu items

Video menu · Computer

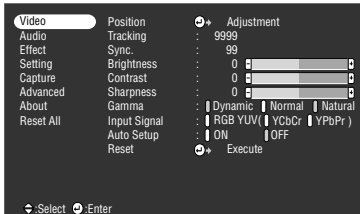

Video menu · EasyMP



Video menu · Video (Video/S-Video)



Video menu · Component



Point

- The items displayed on the image menu will differ in accordance with the projected input source, and menus other than that belonging to the projected input source cannot be adjusted. When the input source is switched with the menu displayed as it is, the menu will be automatically switched to the one for the relevant input source.
- The image menu cannot be adjusted when no image signals are being input.

Audio menu

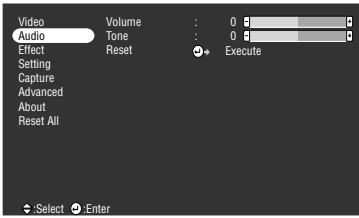

Effect menu

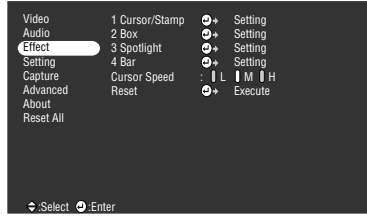

Setting menu

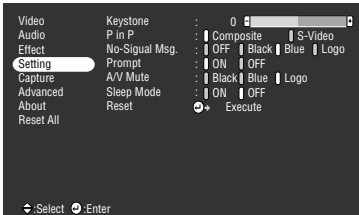

Capture menu

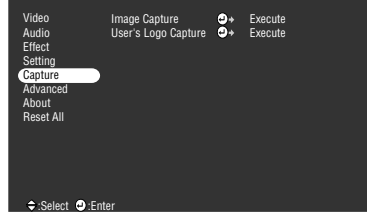

Advanced menu



About menu

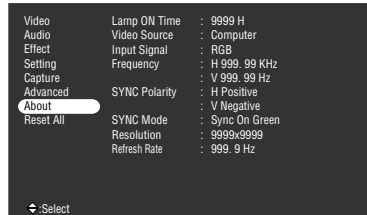

The information menu displays the cumulative lamp operating time and the setup status of the projected input source

Reset All menu

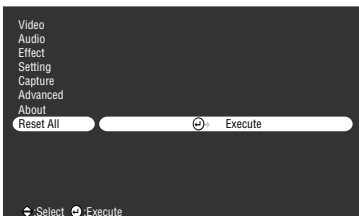

Point

The lamp illumination time is displayed in units of 0H between 0 and 10 hours, and, in units of 1 hour above 10 hours.

■ Menu Operations

The menu is operated with the remote control.

Operation method

1 Press the [Menu] button on the remote control.

The top menu will be displayed.

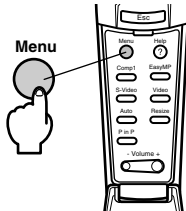

2 Select the required item.

Move the [Enter] button on the remote control up and down to select the required item.

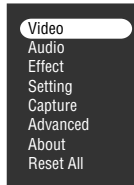

3 Set the selected item.

Press the [Enter] button to determine the relevant item.

The sub-menu is selected.

4 Then select the detailed sub item.

Move the [Enter] button up and down to select the required sub-item.

The items displayed on the image menu and information menu will differ depending on the input source being projected.

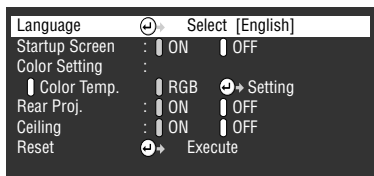

5 Select the parameter value.

Move the [Enter] button to the left and right to select the required setting.

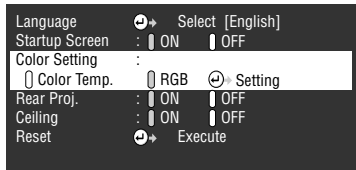

Point

- ↵ (Enter) is attached to the rear of the sub item names that execute the parameters and continue onto the lower hierarchies. Press the [Enter] button to set this selection, and then select the parameter setting again.
- Refer to the list of settings for further information on the function of each setting. ([see page 60](#))

6 Set all of the other items in the same way.

7 Press the [Menu] button.

The menu will end.

Point

- Press the [Esc] button to return to the previous menu in the hierarchy.
 - The items displayed on the image menu will differ in accordance with the projected input source, and menus other than that belonging to the projected input source cannot be adjusted.
 - Image menus cannot be adjusted when no image signals are being input.
-

Setting items

Top Menu	Sub Menu	Function	Default Value
Video	Position	Moves the position of the image display up, down, left and right. Press the [Enter] button to perform the adjustments on the display position adjustment screen.	Depends on the connection signals
	Tracking	Adjusts vertical stripes that appear on the Computer image.	Depends on the connection signals
	Sync.	Adjusts disturbance, blurring and vertical noise that appears on the Computer image. · Disturbance and blurring may occur as a result of adjusting the brightness and contrast. · It is possible to regulate the vividness of the image by adjusting the synchronization after adjusting the tracking.	0
	Brightness	Adjusts the brightness of the image.	Center value (0)
	Contrast	Adjusts the contrast of the image.	Center value (0)
	Color	Adjusts the color depth of the image.	Center value (0)
	Tint	Adjusts the tint of the image.	Center value (0)
	Sharpness	Adjusts the sharpness of the image.	Center value (0)
	Gamma	Corrects the color vividness of the image. Dynamic: Produces an image with clear color differences. Suitable for displaying plans, etc. Normal: Projects tint without correction. Natural: Produces an image with natural tint. Suitable for video images.	Normal
	Input signals	Sets the mode for the input image signals connected to the Computer/Component Video port. RGB : Set when RGB signals are being input. YCbCr: Set when component video signals (YCbCr) are being input. YPbPr : Set when component video signals (YPbPr) are being input.	RGB
	Auto Setup	Automatic setup: Optimizes the computer input image when set at [ON].	ON
Reset	Returns all image menu adjustment values to the default values. Press the [Enter] button and then select [Yes] on the confirmation screen displayed. · Select [Reset All] to return all image and sound values to the default settings. (see page 63)	-	

Top Menu	Sub Menu	Function	Default Value
Audio	Volume	Adjusts the volume.	15
	Tone	Adjusts the tone	0
	Reset	Returns all sound menu adjustment values to the default values. Press the [Enter] button and then select [Yes] on the confirmation screen displayed. · Select [Reset All] to return all image and sound values to the default settings. (see page 63)	-
Effect	Cursor/Stamp	Sets the shape, size, color and length of the cursor/stamp assigned to the [1] button on the remote control. Press the [Enter] button and select the item to be displayed from the cursor/stamp setup menu. (depending on the selected cursor shape, size, color and length cannot be set up.) · The [1] button executes the cursor/stamp function.(see page 50)	Model:  Zoom: 100%
	Box	Sets color, shape and the necessity of the shading for the square assigned to the [2] button on the remote control. Press the [Enter] button and select the required item from the Box setup menu. · The [2] button executes the Box function. (see page 51)	Color: Green Shading: Yes Shape: Square
	Spotlight	Sets the size of the spotlight assigned to the [3] button on the remote control. Press the [Enter] button and select the required item from the spotlight setup menu. · The [3] button executes the spotlight function. (see page 52)	Size: Medium
	Bar	Sets the color, direction and width of the bar assigned to the [4] button on the remote control. Press the [Enter] button and select the required item from the bar setup menu. · The [4] button executes the bar function.(see page 53)	Color: Magenta Direction: Horizontal Line thickness: 8
	Cursor Speed	Selects the speed of Cursor. L: Slow M:Medium H:Fast	M
	Reset	Returns all effect menu adjustment values to the default values. Press the [Enter] button and then select [Yes] on the confirmation screen displayed. · Select [Reset All] to return all image and sound values to the default settings. (see page 63)	-

Top Menu	Sub Menu	Function	Default Value
Setting	Keystone	<p>Corrects screens distorted into trapezoid shapes.</p> <ul style="list-style-type: none"> · The screen will be reduced in size when trapezoid correction has been performed. · The status of trapezoid correction will be recorded. Perform readjustments that match the installation position when the projection position or angle have been changed. · Reduce the sharpness if blurring occurs after trapezoid correction. (see page 60) 	Center value (0)
	P-in-P	<p>Sets the input source for the P in P function's sub-screen.</p> <ul style="list-style-type: none"> · The P in P function is executed by pressing the [PinP] button. (see page 54) 	Composite
	No-Signal Msg	<p>The status for [No Image Signal Input] and other message display.</p> <ul style="list-style-type: none"> · The user logo must be registered and set up before it can be amended. 	Blue
	Prompt	<p>Sets whether to display the input source on the screen or not.</p>	ON
	A/V Mute	<p>Sets up the screen status for when the [A/V Mute] button is pressed.</p> <ul style="list-style-type: none"> · User logos must be registered and set up before they can be amended. 	Black
	Sleep Mode	<p>Sets the energy-saving function for when no image signals are being input. When this is set at [ON], projection will be automatically ended and the projector will enter the sleep mode if no image signals are input and no operations are performed for a period of thirty minutes (the operation indicator will be illuminated in orange). Press the [Power] button to restart projection.</p>	ON
	Reset	<p>Returns all setting menu adjustment values to the default values.</p> <p>Press the [Enter] button and then select [Yes] on the confirmation screen displayed.</p> <ul style="list-style-type: none"> · Select [Reset All] to return all image and sound values to the default settings. (see page 63) 	-
Capture	Image capture	<p>Saves the image currently being projected in the memory card. Press the [Enter] button and perform the operations as directed with the confirmation screen displayed. (see page 64)</p> <ul style="list-style-type: none"> · A certain amount of time is required for the saving process. 	-
	User's Logo Capture	<p>Registers user logos. (see page 66)</p> <p>Press the [Enter] button and follow the instructions displayed on the confirmation screen.</p> <ul style="list-style-type: none"> · The saving procedure requires a certain amount of time to complete. Do not attempt to operate the projector or the equipment connected to the projector while this procedure is running. Failure to observe this may result in damage. · The size that can be registered is 400 x 300 dots. · The display size will be adjusted when video images are being projected. 	EPSON's logo

Top Menu	Sub Menu	Function	Default Value
Ad- vanced	Language	Sets the language with which messages are to be displayed. Press the [Enter] button and select the required language from the language selection menu displayed.	English
	Startup Screen	Displays the user logo during warm-up after the power has been switched on. · The user logo must be registered and set up before it can be amended.	ON
	Color Setting	Adjusts the color temperature (*) of the image. Color temperature: Sets the color temperature. Press the [Enter] button and make the setting on the color setup menu displayed. RGB: Sets the strength of the RGB colors (red, green and blue.) · Press the [Enter] button, select the R (red), G (green) and B (blue) items on the color setup menu displayed, and then make the necessary setting. · Observe the status of the screen when adjusting the settings.	Color temperature
	Rear Proj.	Set at [ON] to project images onto a half-transparent screen from the rear. The projected image will be inverted.	OFF
	Ceiling	The projected image will be inverted up, down, left and right when this is set at [ON].	OFF
	Reset	Returns all advanced setting menu adjustment values to the default values. Press the [Enter] button and then select [Yes] on the confirmation screen displayed. · Select [Reset All] to return all image and sound values to the default settings.	-
About		(Displays the current settings)	-
Reset all	Execute	Returns all items in the set-up menus to the default values. Press the [Enter] button and then select [Yes] on the confirmation screen displayed. · Execute the [Reset] function from each individual sub menu to return the image and sound settings to the default values for each menu. · The User's Logo Capture, Lamp ON Time, language and BNC settings cannot be restored to the default values.	-

- The image menu and information displayed will differ in accordance with the projected input source, and Menus other than that belonging to the projected input source cannot be adjusted.
- The information menu displays the status of the input source settings being projected.

Image capture

The image currently being displayed will be saved onto the memory card.

- 1** Displays the images that are to be captured.
- 2** Press the [Menu] button and then select [Capture] - [Image Capture].
A confirmation screen will be displayed.

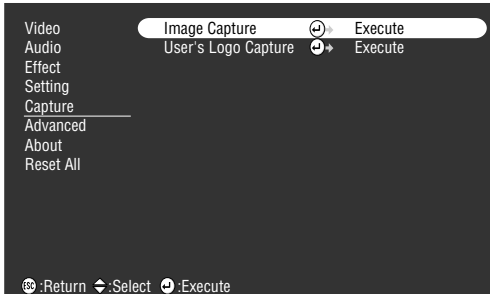

- 3** Select [Yes] and then press the [Enter].
A screen to reconfirm the image to be registered will be displayed.



- 4** Select [Yes] and then press the [Enter].
The image will be saved. Wait for a moment until the saving completion screen is displayed.



Point

- A certain amount of time is required for the saving process. Do not operate the projector or connected equipment while saving is in progress. Failure to observe this may result in defects.
 - Images cannot be saved if the memory card has not been inserted.
 - Do not remove the memory card while images are being saved.
 - A [Capture] folder will be created on the memory card when an image has been captured, and the contents of that screen will be saved in the jpg format.
 - Images cannot be captured when a USB connection has been established with the computer.
 - Images cannot be captured if the memory card has not been inserted.
 - EasyMP images cannot be captured.
-

User logo registration

Registers the images currently displayed as the user logo.

- 1** Displays the image that is to be registered as the user logo.
- 2** Press the [Menu] button and select [Capture]-[User's Logo Capture].
A confirmation screen will be displayed.

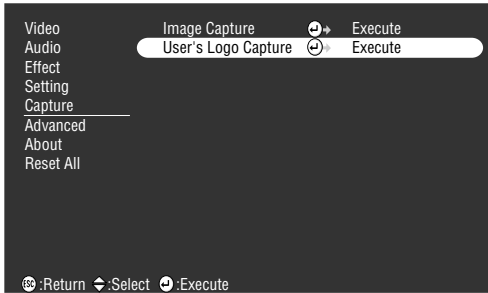

- 3** Select [Yes] and then press the [Enter].
A screen to save will be displayed.



- 4** Adjust the position of the image then press the [Enter].
A confirmation screen will be displayed.



5 Select [Yes] and then press the [Enter].

The enlargement/reduction screen will be displayed.

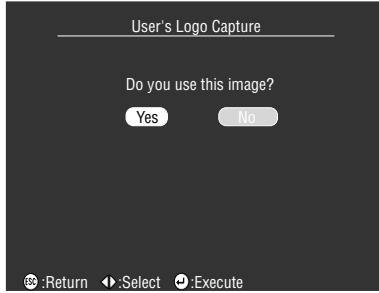

6 Select the enlargement/reduction rate and then press the [Enter].

A screen to confirm saving will be displayed.

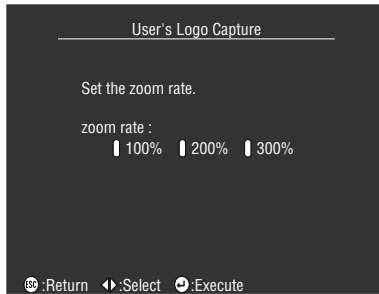

7 Select [Yes] and then press the [Enter].

The image will be saved. Wait for a moment until the saving completion screen is displayed.

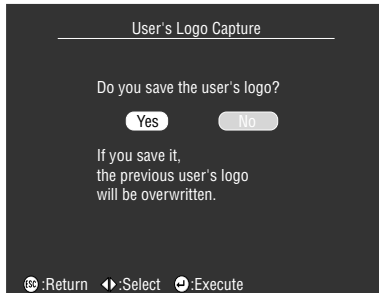

Point

- A certain amount of time is required for the saving process. Do not operate the projector or connected equipment while saving is in progress. Failure to observe this may result in defects.
- The image size that can be registered is 400 x 300 dots.
- The display size will be amended when the video image is being projected.
- It is not possible to return the user logo to the default settings once it has been registered.

Troubleshooting

This section provides explanations on potential problems and the methods of taking care of them.

■ Troubleshooting

When you think you have a problem, first of all check the Indicators on the projector.

The projector is fitted with Operation Indicator, Lamp Indicator and Temperature Indicator to advise the user of the projector's status.

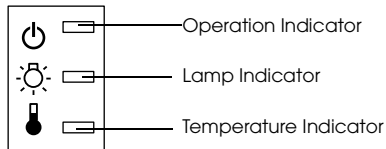

Operation Indicator

Indicator Status	Cause	Recovery or Status	Reference Page
Illuminated in Orange	Stand-by status	(Not an error) Projection will be started when the [Power] button is pressed.	31
Blinking in Orange	Cool-down procedure in progress	(Not an error) · Wait for a moment. The amount of time for the projector to cool down (cooling the lamp) will depend on the external temperature, etc. · The [Power] button cannot be used during the cool-down period. This will be illuminated in orange once the cool-down process has been completed, so press the button once more then.	35
Illuminated in Green	Projection in progress	(Not an error)	32
Blinking in Green	Warm-up in progress	(Not an error) · Wait for a moment. · The green lamp will stop blinking and become illuminated once the warm-up procedure has been completed.	32

Indicator Status	Cause	Recovery or Status	Reference Page
Blinking in Red	Internal error	Cease operations, remove the Power Plug from the socket and contact your dealer or nearest address provided at "International Warranty Conditions in "Safety Instructions/World-Wide Warranty Terms" included in the package and request repairs.	
Extinguished	The power is not switched on	The power is not switched on. · Check the power cord connection. · Check the power supply to the socket.	<u>31</u>

Lamp Indicator

Indicator Status	Cause	Recovery and Status	Reference Page
Illuminated in Red	Time to replace the lamp.	Replace the lamp with a new one (ELPLP14).	
Blinking in Red	Lamp error	· First, remove the lamp and check to see if it is broken (be careful not injure yourself on broken glass if the lamp is broken). If the lamp is not broken reset it. Next, plug in the power plug and turn on the main unit's power. If the problem still persists or the lamp is broken, contact your dealer or nearest address provided at "International Warranty Conditions" in "Safety Instructions/World-Wide Warranty Terms" included in the package (images cannot be projected unless the lamp is replaced). · Check to ensure that the lamp or fan are correctly attached if the lamp has been replaced. If the lamp or fan are not correctly attached, the projector will assume the same status as if the power has not been switched on.	<u>83</u>
Blinking in Orange	Nearing the time for replacing the lamp	Prepare a new lamp. It is recommended that the lamp is replaced as soon as possible, as there are cases where the time for replacement is earlier than stated in the conditions of usage.	<u>83</u>
Extinguished		(Not an error) The power has not been switched on or normal projection is in progress.	

Temperature Indicator

Indicator Status	Cause	Recovery and Status	Reference Page
Illuminated in Red	Excessive internal temperature (overheating)	<p>The lamp goes off automatically and projection becomes impossible. Wait for approximately 5 minutes with the projector in that state. After 5 minutes has passed, pull out the power plug once, then insert it again.</p> <p>If the projector overheats, check the following 2 points and make the necessary improvements.</p> <ul style="list-style-type: none"> · Is the projector installed in a place with good ventilation? · Make sure the air intake and exhaust vents are not covered, and that it is not placed up against the wall. · Has dust accumulated in the air filter? · If the air filter is dirty, clean it. <p>When the power plug is reinserted, the projector will recover to the normal state, so press the power button and turn on the power again. If the projector overheats again even when the above measures have been taken, and when an error is displayed in the indicator when the power is turned on again, discontinue use, pull the power plug out of the receptacle and request repairs by the retail shop where you purchased it, or by the service office at the nearest address provided at "International Warranty Conditions in "Safety Instructions /World-Wide Warranty Terms" included in the package.</p>	<p><u>17</u></p> <p><u>81</u></p>
Blinking in Red	Internal error	<p>Cease operations, remove the Power Plug from the socket and contact your dealer or nearest address provided at "International Warranty Conditions in "Safety Instructions /World-Wide Warranty Terms" included in the package and request repairs.</p>	
Blinking in Orange	High-temperature cooling in progress	<p>(This is not an error, but the projector will automatically cease operating if the temperature increases any further.)</p> <ul style="list-style-type: none"> · Use the projector within the permissible temperature range of between 5 degrees Celsius and 40 degrees Celsius. · Install the projector in a well-ventilated place and ensure that the ventilation inlet and outlet are not blocked. · Clean the Air Filter. 	<p><u>17</u></p> <p><u>81</u></p>
Extinguished		<p>(Not an error) The power has not been switched on or normal projection is in progress.</p>	

Point

- Refer to the section on [When the Indicators Provide No Help] on the following page if the Indicators appear normal but the projected image is defective.
- If an Indicator status not covered by the above table is apparent, contact your dealer or nearest address provided at "International Warranty Conditions in "Safety Instructions /World-Wide Warranty Terms" included in the package.

■ When the Indicators Provide No Help

Refer to each relevant item if the following situations arise but the indicators provide no help.

- The image is not projected [page 71](#)
- The image is unclear [page 75](#)
- The image is cut up (Large)/Small [page 76](#)
- The image color is bad [page 77](#)
- The image is dark [page 77](#)
- No sound [page 78](#)
- The remote control will not work [page 78](#)
- Cannot end [page 79](#)

The image is not projected

● Nothing is displayed



Nothing is displayed

- **Is the Lens Cover still in place?**
[see page 30](#)
- **Has the power been switched off and then on immediately?**
The [Power] button will not operate after projection has been finished (during the cooling down procedure). The [Power] button will work again after the cooling down process. Projection lamp (cooling operations: the operation indicator is illuminated in orange) has been completed.
[see page 35](#)
- **Is the Sleep Mode set at ON?**
When the sleep mode has been set at [ON], the lamp will be automatically extinguished if no operations occur and no signals are input for a period of thirty minutes.
[see page 62](#)
- **Did you press the [Power] button?**
[see page 32](#)
- **Has the brightness of the image been correctly adjusted?**
[see page 60](#)
- **Is the system in the [A/V Mute] mode?**
[see page 46](#)
Perform the reset procedure.
[see page 63](#)
- **Is the input image completely black?**
There are cases where input images will become completely black owing to screen saves, etc.
- **Are image signals being input?**
No message will be displayed when the [Menu] - [Settings] and [No Signal Display] parameter is set at [OFF]. Set either black or blue to display the message. Refer to each relevant item when the message is displayed.
[see page 72](#)
- **Perform the reset procedure.**
[see page 63](#)

● Messages



[Not Supported]
will be displayed

- **Is the resolution of the image signal output from the computer higher than UXGA (1,600 x 1,200)?**
[see page 21](#)
- **Check to ensure that the mode supports the frequency of the image signals output from the computer.**
Refer to the computer's instruction manual to discover how to amend the resolution and frequency of the image signals output from the computer.
[see page 21](#)



[No Signal]
will be displayed

- **Have the cables been connected correctly?**
[see page 20](#)
- **Has the correct image input port been selected for the connection?**
Press the [Source] buttons on the projector ([Comp], [S-Video], [Video] on the remote control) to switch the image.
[see page 33](#)
- **Has the power supply to the connected computer or video equipment been switched on?**
[see page 34](#)
- **Note-type and liquid crystal type computers must output image signals to the projector.**
Image signals are not output externally simply because they are output to the LCD screen under normal conditions, so the setting must be switched to external output.
There are models for which image signals are not output to the LCD screen when output externally.
[see page 20](#)



A message stating
[Error discovered
in the EasyMP
system] will be
displayed.

- **It is necessary to restart the system.**
Unplug the power cord from the socket, plug it in again and then switch on the power supply. If the same problem occurs again, unplug the power cord from the socket and contact your dealer or "International Warranty Conditions in "Safety Instructions/World-Wide Warranty Terms" included in the package.



A message stating
[No memory card]
will be displayed.

- **Has the memory card been inserted?**
Insert the memory card in the card slot (on the projector.)



A message stating
[No displayable
files] will be
displayed.

- **Have displayable files be saved onto the memory card?**

The files that can be displayed with EasyMP are scenario files (.sit), jpeg files (.jpg) and bitmap files (.bmp). Other files will not be recognized.

- Although files with a log extension of .jpeg are recognized on the Windows platform as jpeg files, they are not recognized by EasyMP. Amend the log extension to .JPG or .jpg.



A message stating
[No files] will be
displayed.

- **Has the specified file been deleted?**

There are cases where the list of files displayed differs from the actual contents of the memory card when memory cards have been overwritten by a PC with a USB connection. Press the [EasyMP] button to update the file display.



A message stating
[Display not
possible] will be
displayed.

- **Has a grayscale jpeg image been specified?**

Grayscale jpegs images cannot be displayed with EasyMP.

- **Has a progressive JPEG image been specified?**

Progressive JPEGs cannot be displayed with EasyMP.

- **Is the specified file damaged?**

There is a possibility that the contents of the jpeg file or bitmap file are incorrect. There are also cases where images taken with certain digital cameras or processed with certain software cannot be displayed.



A message stating
[This size cannot be
displayed] will be
displayed.

- **Has a jpeg image with a resolution exceeding SXGA (1280 x 1024) been specified?**

Jpeg and bitmap files with a resolution that exceeds SXGA (1280 x 1024) cannot be displayed. Adjust the resolution with the EMP SlideMaker.



A message stating
[Insufficient image
file colors] will be
displayed.

- **Has a bitmap with a color count other than 24-bit color been specified?**

Bitmap with a color count other than 24-bit color (256 colors, 16 color, etc.) cannot be displayed. Amend the bitmap to 24-bit color.



A message stating
[File cannot be
saved] will be
displayed.

- **Is the memory card full?**

If there is no more space left to save files, increase the capacity of the memory card by deleting other files.



A message stating
[Capture failed]
will be displayed.

- **Was an image captured while the computer was connected with a USB connection?**

It is not possible to capture images when a USB connection is in use. Disconnect the USB cable.

The image is unclear

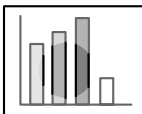

- The screen is blurred.
- Focus can only be attained in certain areas.

- **Has the lens been stored in the projector?**
Images will be out of focus if the position of the zoom lever is outside of the [W] to [T] range. Ensure that the lever is set within the [W] to [T] range.
- **Has the focus been set correctly?**
[see page 41](#)
- **Has the projection angle been increased by adjusting the feet?**
There are cases where the vertical focus is difficult to align if the projection angle is too large.
- **Is the projection distance suitable?**
The recommended projection distance range is between 1.1m and 13.9m. Locate the projector within this distance range.
[see page 18](#)
- **Is the projection light shining at right angles onto the screen?**
[see page 19](#)
- **Is the lens soiled?**
[see page 81](#)
- **Is the lens fogged?**
Condensation will form on the surface of the lens when the projector is suddenly brought into a warm room from a cold room, and this may lead to the image seeming blurred. In this event, switch the power off and leave the unit to stand for a while.
- **Has the [Sync., Tracking and Position] been adjusted?**
The image can be adjusted by regulating the [Tracking] and [Sync] buttons on the projector while monitoring the image on screen. Adjustments can also be made by opening the [Menu].
[see page 42, 60](#)
- **Has the signal format setting for the image been set correctly?**
Set the signal format with [Menu] – [Video] – [Video Signal]. There are cases where the image signals being input cannot be determined in the [Auto] mode.
[see page 60](#)
- **Do the input signals match the connected equipment?**
Set the signal type with the [Menu] - [Video] - [Input Signal] parameter. Set [RGB] for computer signals, and [YCbCr] or [YPbPr] (depending on the equipment signals) for component video signals.

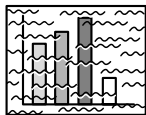

- The image is disturbed.
- Noise appears

- **Has the cable been connected correctly?**
see page 20, 27
- **Is the selected resolution correct?**
Align the computer with the signals supported by the projector. Refer to the computer's instruction manual for details on how to amend the signals.
see page 21
- **Have the [Synchronization *, Tracking *, Display Position] settings been correctly adjusted.**
Press the [Auto] button to make the adjustments.
The [Menu] will be displayed to enable adjustment to be made.
see page 42, 60
- **Has the cable length been extended?**
There are cases where noise will occur if the cable length is extended. Either use the cable supplied or connect amplification equipment, etc, and confirm the situation.
- **Has the signal format setting for the image been set correctly?**
Select the video signal format with [Menu] – [Video] – [Video Signal Format]. There are cases where the video image signals being input cannot be determined in the [Auto] mode.
see page 62
- **Do the input signals match the connected equipment?**
Set the signal type with the [Menu] - [Video] - [Input Signal] parameter. Set [RGB] for computer signals, and [YCbCr] or [YPbPr] (depending on the equipment signals) for component video signals.
see page 60

The image is cut up (Large)/Small

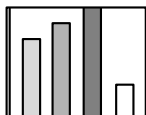

- The image is cut up
- The image is small

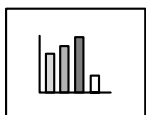

- **There is a possibility that the [Resize] setting has not been correctly selected.**
Press the [Resize] button.
see page 47
- **Has the [Display Position] been correctly adjusted?**
Adjust with [Menu] – [Video] – [Position].
see page 60
- **Is the selected resolution correct?**
Align the computer with the signals supported by the projector. Refer to the computer's instruction manual for details on how to amend the signals.
see page 21
- **Amend the resolution for note-type and liquid crystal type computers.**
Either amend the resolution so that the display fills the entire screen, or set the image signals so that only external output is possible.
see page 20
- **Has the system been set for dual display?**
Only half of the computer screen's image will be displayed with the projector if dual display has been set with [Display Properties] on the control panel. Cancel the dual display setting to display the entire computer screen image. Refer to the video driver manual supplied with the computer in use for further details.

The image color is bad

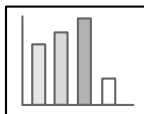

- **Has the image brightness been correctly adjusted?**
[see page 60](#)
- **Have the cables been connected correctly?**
[see page 20, 27](#)
- **Has the contrast been correctly adjusted?**
[see page 60](#)
- **Has the color setting been correctly adjusted?**
[see page 63](#)
- **Have the color density and tint been correctly adjusted?**
(The display on the computer monitor or the liquid crystal screen will not always match up with the tint of the image, but this is not an abnormality.)
[see page 60](#)
- **Is it time to replace the lamp?**
If the Lamp Indicator is blinking, it means that the time to replace the lamp is drawing near. When the time to replace the lamp draws near, the image will appear dark and the tint will deteriorate. In this event, replace the lamp with a new one.
[see page 83](#)
- **Do the input signals match the connected equipment?**
Set the signal type with the [Menu] - [Video] - [Input Signal] parameter. Set [RGB] for computer signals, and [YCbCr] or [YPbPr] (depending on the equipment signals) for component video signals.

The image is dark

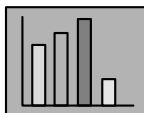

- **Is it time to replace the lamp?**
If the Lamp Indicator is blinking, it means that the time to replace the lamp is drawing near. When the time to replace the lamp draws near, the image will appear dark and the tint will deteriorate. In this event, replace the lamp with a new one.
[see page 83](#)
- **Has the image brightness been correctly adjusted?**
[see page 60](#)
- **Has the contrast been correctly adjusted?**
[see page 60](#)

No sound



- **Has the sound input been connected correctly?**
[see page 23, 27](#)
- **Has the image for which sound is required been selected?**
[see page 33](#)
- **Has the volume been set to the minimum?**
[see page 55](#)
- **Is sound being emitted from connected equipment?**
Confirm the sound from connected equipment, etc.
Has the volume been turned right down?
- **Has the [A/V Mute] function been left on?**
There is a possibility that the [A/V Mute] mode is in effect.
Press the [A/V Mute] button, adjust the volume, or display the menu to cancel the [A/V Mute] status.
[see page 46](#)
- **Is the sound being output to external speakers?**
Sound will not be output from the projector's speaker if a stereo mini-jack has been connected to the Audio Out port.

The remote control will not work



- **Is the [R/C ON OFF] switch on the remote control on?**
[see page 32](#)
- **Is the remote control being aimed in the correct direction?**
The operable range of the remote control unit is 30° to the left and right, and 15° up and down.
[see page 15](#)
- **Is the distance between the remote control and the projector too great?**
The operable distance of the remote control unit is approximately 10m.
[see page 15](#)
- **Is the light-receiving area on the remote control blocked?**
- **Has the remote control light-receiving area been subject to direct sunlight, fluorescent light or any other strong light source?**
- **Have the batteries been mounted in place?**
[see page 16](#)
- **Have the batteries run out?**
- **Have the batteries been mounted back to front?**
[see page 16](#)

The projector will not switch off (after the [Power] button has been pressed)



- **Is the Operation Indicator illuminated in orange?**

The projector has been designed so that the Operation Indicator is not extinguished even when the power has been switched off.

The Operation Indicator will be extinguished when the Power Plug has been disconnected from the socket.

- **The fan will not cease operations.**

The cool-down process (to allow the projector lamp to cool down; the operation indicator will blink in orange) will be performed after the power has been switch off by pressing the [Power] button. The operation indicator will be illuminated in orange when this has been completed, so remove the power plug from the socket at this point.

*The amount of time required for the cool-down process will depend on the external temperature.

Maintenance

This section provides explanations on taking care of the projector, replacing consumable items and other maintenance procedures.

■ Cleaning the Projector, Cleaning the Lens, Cleaning the Air Filter

Clean the projector if it becomes soiled or if the quality of the projected images deteriorate. Please clean the air filter about every 100 hours of operation.

Warning

- Personnel other than qualified servicemen must never open the projector. Many high-voltage parts are contained inside the cover that may cause electric shocks. Contact your dealer or your nearest address provided at "International Warranty Conditions in "Safety Instructions/World-Wide Warranty Terms" included in the package to request internal inspections, repairs, adjustments, cleaning and other tasks.
- Exercise caution when handling the Power Plug and Power Connector. Mishandling may result in the outbreak of fire and electric shocks. Observe the following when handling the Power Plug.
 - Do not connect plugs or connectors that have become dirty or have foreign matter adhering to them.
 - Ensure that the plugs and connectors are firmly inserted in the relevant sockets as far as they will go.
 - Never attempt to connect plugs and connectors with wet hands.

Caution

- Never attempt to remove the lamp immediately after use. Failure to observe this may result in burns and other injuries caused by heat. Wait for approximately one hour after the power has been cut off to allow the lamp sufficient time to cool.
- Disconnect the Power Plug and Power Connector from their sockets when carrying out maintenance tasks. Failure to observe this may result in electric shocks.

Switch off the power supply and disconnect the Power Cord prior to cleaning any part of the projector.

Cleaning the projector

- Gently wipe the soiled parts of the projector with a soft cloth.
 - When the soiling is severe, wipe the area with a cloth moistened with a medium-strength cleaning agent diluted with water, and then gently wipe it with a dry cloth.
- Never use wax, Benzene, thinner or other active agents. Failure to observe this may result in damage or paint peeling from the casing.

Cleaning the lens

Clean the lens with an air-blower (available on the open market) and special lens cleaning paper. The surface of the lens is easily damaged, so exercise extreme caution and avoid using anything other than soft materials.

Cleaning the Air Filter

Air ventilation will deteriorate and the internal temperature of the projector will rise if the Air Filter becomes blocked with dirt and dust, and this may result in damage.

Ensure that the projector is stood on its end and the Air Filter cleaned with a vacuum cleaner to prevent the dirt and dust from penetrating inside.

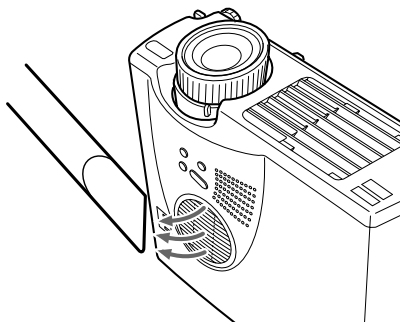

Point

- If it is no longer possible to remove the dirt from the Air Filter or it begins to crack, it is time to replace it. Contact your dealer in this event.
 - A replacement air filter is packaged with the replacement lamp. Replace the Air Filter at the same time as replacing the lamp.
-

■ Replacing the Air Filter

Replacement method

1 Switch off the power supply, allow the projector to cool down, and then disconnect the Power Cord.

The amount of time required for the projector to cool down will depend on the surrounding temperature.

2 Raise the air filter with a screwdriver or similar object to remove it.

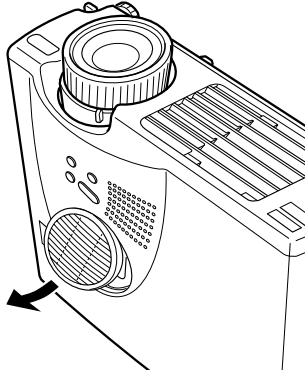

Point

Ensure that the projector is stood on its end when replacing the Air Filter to prevent the dirt and dust from penetrating inside.

3 Set a new Air Filter in place.

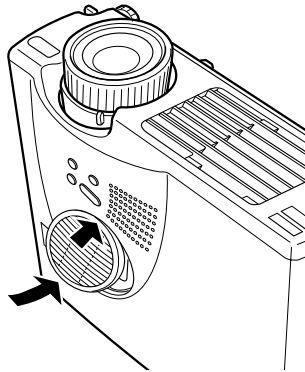

Point

- Slip the clip in place first, and then press the other side to set it in place.
- Dispose of used air filters in accordance with local disposal regulations.

■ Replacing the Lamp

Replace the lamp at the following times (model number: ELPLP14).

When a message stating [Lamp Replace] is displayed for thirty seconds after the start of projection

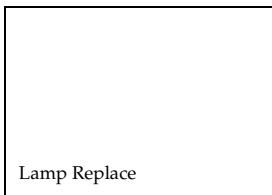

When the lamp indicator is blinking in orange

The lamp indicator will blink in orange.

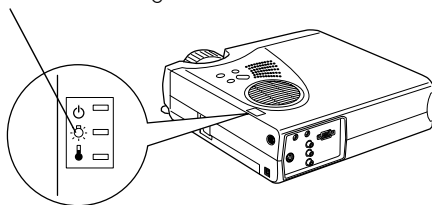

When the brightness and picture quality has deteriorated below the initial levels

Point

- Replace the lamp as quickly as possible after the message has been displayed to maintain the initial brightness levels and picture quality.
 - The replacement message has been set at approximately 900 hours of use in order to maintain the initial brightness levels and picture quality. If you continue to use the lamp after this period, the possibility of the lamp breaking becomes greater. When the lamp replacement message appears, replace the lamp with a new one as soon as possible, even if it is still working.
 - Although the replacement message is displayed after approximately 900 hours of use, there are cases where the individual characteristics of each lamp and other usage conditions result in it not lighting up before this 900 hours has elapsed. For this reason, always prepare a replacement lamp well in advance.
 - Contact your dealer for a spare lamp.
-

Replacement method

- 1** Switch off the power supply, allow the projector to cool down*, and then disconnect the Power Cord.

The amount of time required for the projector to cool down will depend on the surrounding temperature.

- 2** Wait until the lamp has cooled down sufficiently, and then remove the lamp cover.

- Approximately one hour is required for the lamp to cool down sufficiently.
- Loosen and remove the screw holding the fan in place.

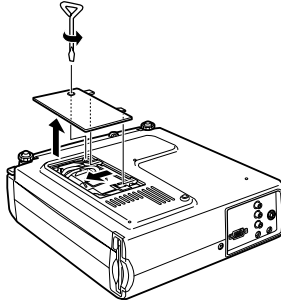

- 3** Withdraw the lamp.

Loosen the two screws holding the lamp in place, and then pull the lamp out towards you.

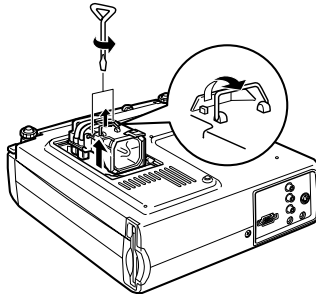

- 4** Attach a new lamp.

Align the direction, push the lamp in as far as it will go, and then secure it in place with the two screws.

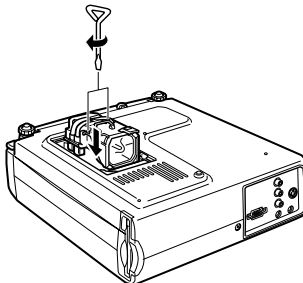

5 Attach the lamp cover.

Align the direction, insert the fan, and then secure it in place with the one screw.

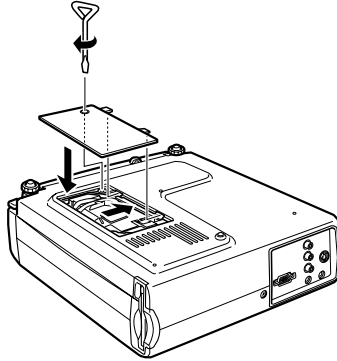

Point

- Attach the lamp firmly. A safety mechanism on the projector switches off the power automatically when the lamp cover has been removed. The power will not be reinstated unless the lamp and lamp cover are set firmly in place.
 - A replacement Air Filter is packaged with the replacement lamp. Replace the Air Filter at the same time as replacing the lamp.
 - The illumination time will be automatically reset when the lamp has been replaced with a new one.
-

Others

This section provides explanations on optional items and after service care, as well as providing details on specifications, terminology and other technical information.

■ Optional Parts

The following optional parts are available for purchase in accordance with your needs.

MAC Adapter Set	ELPAP01
Image Presentation Camera (XGA)	ELPDC02
Image Presentation Camera (PAL/NTSC)	ELPDC03
Computer Cable	ELPKC02
VGA-HD15 PC Cable (3.0m)	ELPKC09
VGA-HD15 Extension Computer Cable (20m)	ELPKC10
Component Video Cable (3.0m)	ELPKC19
Soft Carrying Case (for PC) Soft Carrying Case	ELPKS16 ELPKS24
Spare Lamp	ELPLP14
Portable Screen (50")	ELPSC06
60" Screen	ELPSC07
80" Screen	ELPSC08
Ceiling Mount (Silver)*	ELPMB09

* A special technique is necessary to suspend the projector from the ceiling.
Please consult with your dealer if you are planning to suspend the projector from the ceiling when you use it.

■ Terminology

This section provides simple explanations for the terminology used within the manual, items for which explanations are not available, and other complex processes.

A/V Mute	Temporarily erases the image and sound. The sound and image can be muted by pressing the [A/V Mute] button on the projector. Press the [A/V Mute] button once again or adjust the volume or display the menu to cancel the mute mode.
Contrast	By strengthening or weakening the tone of the colors, it is possible to project characters and pictures more clearly and attain a softer tint. This is known as contrast adjustment.
Color differential signal	Video equipment transmits signals through three cables as Red-Bright (R-Y), Yellow-Bright (Y) and Blue-Bright (B-Y). This enables the composite signals (the red, green and blue signals and their brightness signals are transmitted along one cable) to be projected more clearly.
Color temperature	The temperature of the subject that emits light. A blue hue is attained when the color temperature is high, and a red hue is attained when the color temperature is low.
Cool-down	A lamp cooling procedure continues to operate even after the power supply has been switched off and the lamp extinguished. The cooling fan will begin to operate when the lamp is extinguished, and button operations will no longer be possible. This period is known as the cooling down period. The amount of time required for the cooling down procedure will differ in accordance with the surrounding temperature.
D output port	The output port for digital tuners that support the new digital broadcasts within Japan.
Operating system	The software necessary to operate the computer.
SVGA	IBM PC/AT compatible (DOS/V equipment) signals with 800 horizontal pixels and 600 vertical pixels.
SXGA	IBM PC/AT compatible (DOS/V equipment) signals with 1,280 horizontal pixels and 1,024 vertical pixels.
Sync(synchronization)	Outputs computer signals at a pre-determined frequency. The image will not be projected clearly unless this frequency is aligned with the frequency of the projector. Aligning the signal phasing is known as synchronization. Projected images will be subject to disturbance, blurring and horizontal noise if not synchronized.
Tracking	Outputs computer signals at a pre-determined frequency. The image will not be projected clearly unless this frequency is aligned with the frequency of the projector. Aligning the signal frequency is known as tracking. Projected images will be subject to disturbance, blurring and horizontal noise if not synchronized.
USB	An abbreviation for Universal Serial Bus. This is an interface for connecting comparatively low frequency equipment to the computer.
UXGA	IBM PC/AT compatible (DOS/V equipment) signals with 1,600 horizontal pixels and 1,200 vertical pixels.
VGA	IBM PC/AT compatible (DOS/V equipment) signals with 640 horizontal pixels and 480 vertical pixels.

XGA

IBM PC/AT compatible (DOS/V equipment) signals with 1,024 horizontal pixels and 768 vertical pixels.

■ Specifications

Product Name	Multi-Media Projector	
Model	EMP-715/505	
External Dimensions	Width 267 × Height 72 × Depth 213 mm(excluding the lens and feet)	
Panel Size	0.9-inch (Width 18.5mm × Height 13.9mm × Corner-to-corner 23.1 mm)	
Display Emthod	Poly-silicone TFT	
Drive Method	Full-line 12-phase block sequential writing	
Pixel Count	EMP-715 : 786,432 (Horizontal 1,024 × Vertical 768 pixels) × 3 EMP-505 : 480,000 (Horizontal 800 × Vertical 600 pixels) × 3	
Focus Adjust-ment	Manual	
Zoom Adjust-ment	Manual (approximately 1:1.2)	
Lamp (light source)	UHE lamp model: ELPLP14 rated 150W	
Maximum Sound Output	1W monaural	
Speakers	1	
Power Supply	100 - 240VAC 50/60 Hz Rated electrical consumption: 230W, 5W during standby.	
Temperature range during use	+5 to +35°C (with no condensation)	
Temperature range during storage	-10 to +60°C (with no condensation)	
Weight	Approximately 2.7kg	
Connection ports	Computer/Component Video	Single-system mini D-Sub 15pin(female)
	Audio In	Single-system Stereo mini-jack
	Audio Out	Single-system stereo mini-jack
	Video	Single-system RCA pin jack
	S-Video	Single-system mini DIN 4pin
	L-Audio-R (for video use)	Single-system RCA pin jack × (L, R)
	Mouse/Com	Single-system DIN 13pin
	USB	Single-system USB (Series B)
Card slot	PCMCIA TYPE II	
Card supplied (card adapter)	Supports CFA specification compact flash cards Conforms to ATA Standard	

* The USB port does not guarantee the operations of all equipment that supports USB.

■ Index

Numerics

13w3 23

A

A/V Mute 62
A/V Mute button 12
A/V Mute Function 46
About 63
About menu 57
Adjusting the Projection Position 38
Adjusting the Projection Size 39
Advanced 63
Advanced menu 57
Audio 61
Audio In Port 11
Audio menu 57
Auto adjustment 41
Auto button 13
Auto Setup 60

B

Bar 53, 61
Battery Cover 14, 16
Box 51, 61
Brightness 60

C

Cancelling effects 53
Capture 62
Capture menu 57
Ceiling 63
Cleaning the Air Filter 81
Cleaning the Projector, Cleaning the Lens,
Cleaning the Air Filter 80
Color 60
color differential 28
Color Setting 63
color temperature 63
Commencing projection 32
Comp button 33
component 28

composite image signals 27
Computer / Component
Video Port 11, 22
Connecting external monitors 20
Connecting the projector to a computer 20
Connecting video equipment 27
Contrast 60
cool-down 35, 68
Cursor 50
Cursor Speed 61
Cursor/Stamp 61

D

digital tuner's 29

E

Effect button 12, 61
Effect Function 50
Effect menu 57
Eligible computers 20
Ending 35
Ending images 35
Enlarging Images (zoom function) 49
Enter button 13
Esc button 13
Execute 63
E-Zoom button 12
E-zooming function 49

F

Feet adjustments 38
Focus 41
Focus Ring 8, 41
Foot Adjust Lever 8, 38
Freeze button 12
Freeze Function 46
frequency 21
Front Foot 8, 9, 36, 38
Functions 43

G

Gamma 60

H

Help button 10
Help Function 44

I

I/O Terminal 9
Image capture 62
image signals 28
Indicator 12
Installation Procedure 17

K

Keystone (Keystone adjustment) 62
Keystone button 10

L

Lamp Cover 9
Lamp Indicator 8, 69
Language 63
Left click 26
Lens Cover 8, 30, 37
Light button 12

M

Maximum Sound Output 89
Menu button 58
Menu Configuration 56
Menu Operations 58
mini D-Sub 15 pin 22
Mouse/Com Port 11, 25

N

No-Signal Msg 62

O

Operable distance 15
Operable range 15
Operation Indicator 8, 31, 68
Operation Panel 8, 10
Optional Parts 86
overheating 70

P

P in P button 13, 62
Parts, Names and Operations 8
Picture in Picture Function 54
Picture Quality Adjustment 41
Position 60
Power button 10, 12, 32
Power Cord 31
Power Inlet 9, 31
Projection 30
Projection angles 19
Projection Cutting 46
projection distance 18
Prompt 62

R

R/C ON OFF switch 12, 32, 36
Rear Foot 9
Rear Proj. 63
Remote Control 12, 15
Remote Control Light-receiving Area 8
Remote control transmitter 12
Replacing the Air Filter 82
Replacing the Lamp 83
Reset 60, 61, 62, 63
Reset all 63
Reset All menu 57
Resize button 13
resolution 21
Right click 26

S

S image signals 27
Screen size 18
Setting 62
Setting menu 57
Sharpness 60
Sleep Mode 62, 71
Sound connection 23
Source 33
Speaker 8
Specifications 89
Spotlight 52, 61
Stamp 50
Startup Screen 63

- sub menus 56
- S-Video button 13
- S-Video Port 11
- S-Video port 27
- Symbol displays 7
- Sync. 60
- Synchronization 42

T

- Temperature Indicator 8, 70
- Temperature range during storage 89
- Temperature range during use 89
- Terminology 87
- Tint 60
- Tone 61
- top menus 56
- Tracking 42, 60
- Trapezoid adjustment 40
- Troubleshooting 68

U

- User's Logo Capture 62
- Using this manual 7

V

- Video 33, 60
- Video menu 56
- Video Port 11, 27
- Volume 55, 61
- Volume Adjustment 55
- Volume button 13

W

- window display 47
- Window resizing 47

Z

- Zoom 39

DECLARATION of CONFORMITY

according to ISO/IEC Guide 22 and EN 45014

Manufacturer : SEIKO EPSON CORPORATION
Address : 3-5, Owa 3-chome, Suwa-shi,
Nagano-ken 392-8502 Japan
Representative : EPSON EUROPE B. V.
Address : Entrada 701, 1096 EJ AMSTERDAM,
The Netherlands

Declares that the Product

Kind of Equipment : LCD Projector

Model : ELP-715/505 / EMP-715/505

Conforms to the following Directives and Norm(s)

Directive 89/336/EEC

: EN 55022

: EN 55024

: EN61000-3-2

: EN61000-3-3

Directive 73/23/EEC

: EN 60950

DECLARATION of CONFORMITY

According to 47CFR, Part 2 and 15 for

**Class B Personal Computers and Peripherals; and/or
CPU Boards and Power Supplies used with Class B
Personal Computers**

We : EPSON AMERICA, INC.
Located at : MS: 3-13
3840 Kilroy Airport Way
Long Beach, CA 90806-2469
Telephone : (562) 290- 5254

Declare under sole responsibility that the product identified herein, complies with 47CFR Part 2 and 15 of the FCC rules as a Class B digital device. Each product marketed, is identical to the representative unit tested and found to be compliant with the standards. Records maintained continue to reflect the equipment being produced can be expected to be within the variation accepted, due to quantity production and testing on a statistical basis as required by 47CFR 2.909. Operation is subject to the following two conditions : (1) this device may not cause harmful interference, and (2) this device must accept any interference received, including interference that may cause undesired operation.

Trade Name : EPSON
Type of Product : LCD Projector
Model : EMP-715/505 / ELP-715/505

FCC Compliance Statement For United States Users

This equipment has been tested and found to comply with the limits for a Class B digital device, pursuant to Part 15 of the FCC Rules. These limits are designed to provide reasonable protection against harmful interference in a residential installation. This equipment generates, uses, and can radiate radio frequency energy and, if not installed and used in accordance with the instructions, may cause harmful interference to radio or television reception. However, there is no guarantee that interference will not occur in a particular installation. If this equipment does cause interference to radio and television reception, which can be determined by turning the equipment off and on, the user is encouraged to try to correct the interference by one or more of the following measures.

- Reorient or relocate the receiving antenna.
- Increase the separation between the equipment and receiver.
- Connect the equipment into an outlet on a circuit different from that to which the receiver is connected.
- Consult the dealer or an experienced radio/TV technician for help.

WARNING

The connection of a non-shielded equipment interface cable to this equipment will invalidate the FCC Certification or Declaration of this device and may cause interference levels which exceed the limits established by the FCC for this equipment. It is the responsibility of the user to obtain and use a shielded equipment interface cable with this device. If this equipment has more than one interface connector, do not leave cables connected to unused interfaces. Changes or modifications not expressly approved by the manufacturer could void the user's authority to operate the equipment.

For Canadian Users

This digital apparatus does not exceed the Class B limits for radio noise emissions from digital apparatus as set out in the radio interference regulations of the Canadian Department of Communications.

Le présent appareil numérique n'émet pas de bruits radioélectriques dépassant les limites applicables aux appareils numériques de Classe B prescrites dans le règlement sur le brouillage radioélectrique édicté par le Ministère des Communications du Canada.

All rights reserved. No part of this publication may be reproduced, stored in a retrieval system, or transmitted in any form or by any means, electronic, mechanical, photocopying, recording, or otherwise, without the prior written permission of SEIKO EPSON CORPORATION. No patent liability is assumed with respect to the use of the information contained herein. Neither is any liability assumed for damages resulting from the use of the information contained herein.

Neither SEIKO EPSON CORPORATION nor its affiliates shall be liable to the purchaser of this product or third parties for damages, losses, costs, or expenses incurred by purchaser or third parties as a result of: accident, misuse, or abuse of this product or unauthorized modifications, repairs, or alterations to this product, or (excluding the U.S.) failure to strictly comply with SEIKO EPSON CORPORATION's operating and maintenance instructions.

SEIKO EPSON CORPORATION shall not be liable against any damages or problems arising from the use of any options or any consumable products other than those designated as Original EPSON Products or EPSON Approved Products by SEIKO EPSON CORPORATION.

EPSON is a registered trademark and PowerLite is a trademark of SEIKO EPSON CORPORATION.

General Notice: The following trademarks and registered trademarks are the property of their respective owners and are used in this publication for identification purposes only.

- EPSON/Seiko Epson Corp.
- Macintosh, PowerBook/Apple Computer Corp.
- IBM/International Business Machines, Inc.
- Windows/Microsoft Corp.

Other product names used herein are also for identification purposes only and may be trademarks of their respective owners. EPSON disclaims any and all rights in those marks.

EPSON®



Printed on 100% recycled paper.



Printed in Japan
402119400
(90010657)
01.12-.5A(C01)