

EPSON®

**EMP-7300
7200
5300™**

Owner's Manual

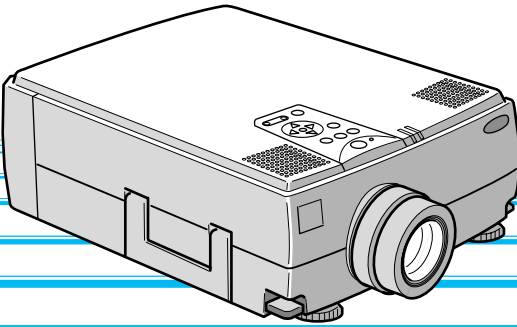

ULTIA
EDIA
M
PROJECTOR

Important Information

Please read the following important information about your projector.

Important Safety Information

Warning: *Never look into the projector lens when the lamp is switched on as the bright light can damage your eyes. Never let children look into the lens when it is on.*

Warning: *Never open any covers on the projector except the lamp and filter covers. Dangerous electrical voltages inside the projector can cause severe injury. Except as specifically directed in this Owner's Manual, do not attempt to service this product yourself. Refer all servicing to qualified service personnel.*

Warning: *Keep the plastic bags for the projector, accessories and optional parts out of the reach of children. Children covering their heads with bags may result in death by suffocation. Be particularly careful around small children.*

Caution: *When you replace the lamp, never touch the new bulb with your bare hands. The invisible residue left by the oil on your hands may be shorten the bulb life. Use a cloth or gloves to handle the new bulb.*

QUICK START

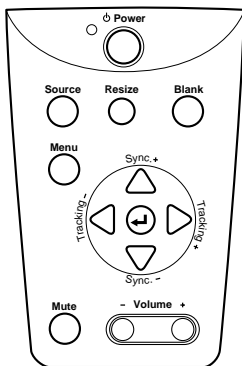
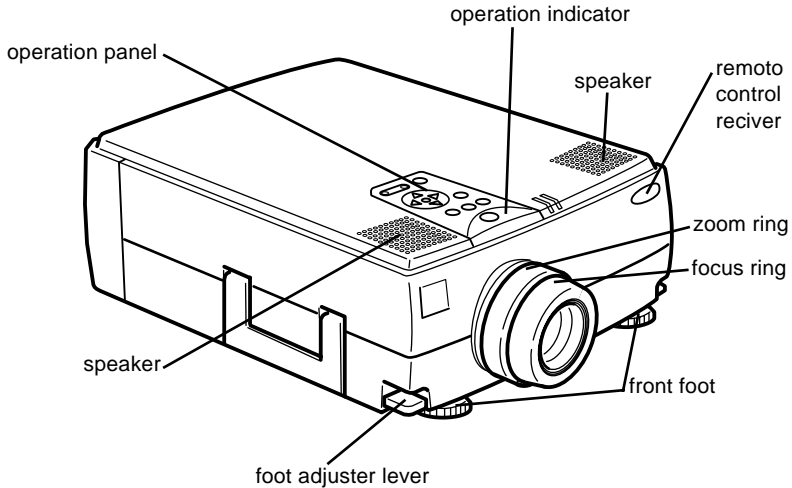

Operation Panel

Button	Function
Power	Starts or stops projection.
Source	Switches to Computer 1 , Computer 2, or Video.
Menu	Displays or hides the menu.
Up, down arrows (Sync+/Sync-)	Synchronizes the computer's graphic signal. Use these buttons to adjust an overall image that is fuzzy or streaked, or to select menu items during menu operations.
Left, right arrows (tracking-/tracking+)	Matches the projector's internal clock to various computer graphic signals (tracking adjustment). Use these buttons to adjust an image with vertical fuzzy lines, or to change numeric settings during menu operations.
Enter key	Registers a menu selection.
Resize	Switches the display dot mode and resize mode (for VGA, SVGA, and SXGA input).
Mute	Cuts off audio.
- Volume +	Adjusts the volume.

QUICK START

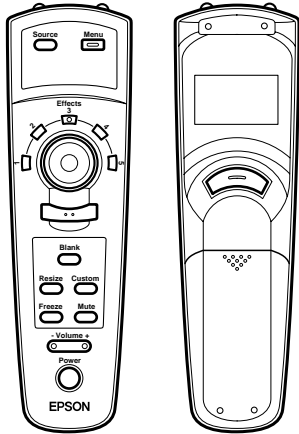

Remote control

Button	Function
Menu	Displays or hides the menu.
Source	Switches to Computer 1 , Computer 2*, or Video.
Pointer button	Use the pointer button to navigate the menus or use the remote as a mouse pointer when the projector is connected to the computer with all cables came with the EMP-7300/7200/5300.
Effects buttons	Use to display special effects in conjunction with the projector software.
Top multi-purpose button	Acts as a right mouse click, registers a menu selection, and selects other custom functions.
Bottom multi-purpose button	Acts as a left mouse click, registers a menu selection, and selects other custom functions.
Blank	Clears the screen of special effects and switches to a black, a blue or user logo display.
Resize	Switches the display dot mode and resize mode (for VGA, SVGA and SXGA input).
Custom	Use to assign functions to the Effects keys using the projector software.
Freeze	Keeps the current computer or video image on the screen.
Mute	Cuts off audio.
- Volume +	Adjusts the volume.
Power	Starts or stops the projector.

Connecting to a PC laptop computer

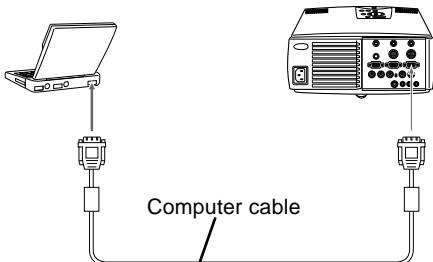

Connecting to a Macintosh PowerBook

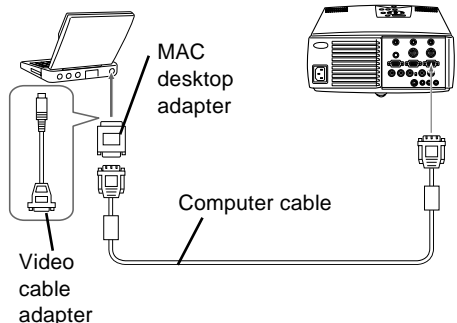

EPSON®

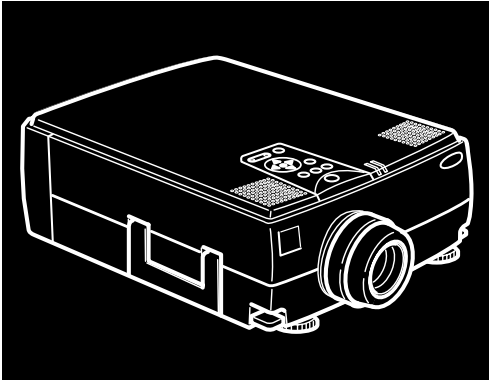

EMP-7300/7200/5300™

DATA/VIDEO PROJECTOR

Owner's Manual

All rights reserved. No part of this publication may be reproduced, stored in a retrieval system, or transmitted in any form or by any means, electronic, mechanical, photocopying, recording, or otherwise, without the prior written permission of SEIKO EPSON CORPORATION. No patent liability is assumed with respect to the use of the information contained herein. Neither is any liability assumed for damages resulting from the use of the information contained herein.

Neither SEIKO EPSON CORPORATION nor its affiliates shall be liable to the purchaser of this product or third parties for damages, losses, costs, or expenses incurred by purchaser or third parties as a result of: accident, misuse, or abuse of this product or unauthorized modifications, repairs, or alterations to this product, or (excluding the U.S.) failure to strictly comply with SEIKO EPSON CORPORATION's operating and maintenance instructions.

SEIKO EPSON CORPORATION shall not be liable against any damages or problems arising from the use of any options or any consumable products other than those designated as Original EPSON Products or EPSON Approved Products by SEIKO EPSON CORPORATION.

EPSON is a registered trademark and PowerLite is a trademark of SEIKO EPSON CORPORATION.

General Notice: The following trademarks and registered trademarks are the property of their respective owners and are used in this publication for identification purposes only.

- EPSON/Seiko Epson Corp.
- Macintosh, Macintosh OS System 7, Macintosh OS System 7.5, PowerBook, Quadra, Centris, Power Mac/Apple Computer Corp.
- IBM/International Business Machines, Inc.
- Windows 3.x, Windows 95, Windows NT4.0, WindowsNT3.51/Microsoft Corp.

Other product names used herein are also for identification purposes only and may be trademarks of their respective owners. EPSON disclaims any and all rights in those marks.

Adobe, Acrobat Reader/Adobe Systems Incorporated.

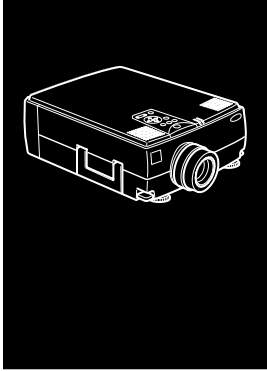

Contents

Contents	iii
Introduction	vii
Getting the Most Out of Your Projector	ix
Remote control	ix
Sleep mode.....	ix
Control Panel.....	ix
Optional Accessories.....	x
About This Manual.....	xi
Safety Instructions	xii
Where to Get Help	xiv
World Wide Web site.....	xv
Transporting your projector.....	xv
Installation	1
Unpacking the Projector.....	2
Additional Items.....	3
Setting Up the Projector.....	4
Connecting to a Computer	7
Connecting to a PC desktop computer	8
Connecting to a PC laptop computer.....	12
Connecting to a Macintosh desktop computer	16
Connecting to a Macintosh PowerBook.....	20
Connecting to a Video Source	24
Connecting to an External Speaker or PA System.....	26

Connecting to a Workstation (only available for the EMP-7300/7200).....	28
--	----

Using the Projector 43

Turning the Equipment On and Off	31
Turning the Projector On and Off	31
Sleep Mode	32
Focusing and Positioning the Screen Image	33
Resize Button.....	35
Controlling the Projector.....	36
Using the Remote Control	37
Using the Control Panel.....	39
Projector Status Indicators.....	41
Operation Indicator.....	41
Lamp Indicator.....	42
Temperature Indicator.....	42

Using the Projector Menus 43

Accessing the Main Menu	44
Changing a Menu Setting.....	44
Menu Options	47
Video Menu (Image source = Computer)	47
Video Menu (Image source = Video)	50
Audio Menu.....	51
Options Menu.....	52
Custom Menu	54
About Menu.....	57
RESET ALL Menu.....	57

Using the Projector Software 59

Presentation support function	60
Projector setting function	60
System requirements.....	60
Projector Software CD-ROM	62
Connecting the Cables.....	63
Connecting to your PC	63

Connecting to your Macintosh	64
Installing the Projector Software on Your PC	65
Installing ELP Link III V2.0 on your PC	67
Installing the Projector Software on Your Macintosh.....	69
Accessing the Projector Software.....	71
For Windows 95 and NT 4.0 users	71
For Windows 3.1 and NT 3.51 users	71
For Macintosh users	72
Installing or Accessing the Projector Software on the CD-ROM Directly.....	73
For Windows users	73
For Macintosh users	74
Maintenance	75
Cleaning the Lens.....	76
Cleaning the Projector Case.....	76
Cleaning the Air Filter	77
Replacing the Lamp.....	78
Troubleshooting	81
Problems with the Projector.....	82
Problems with the Image or Sound.....	84
Technical Specifications	87
Supported Monitor Displays	89
Monitor and Computer In 1/2 connector pin assignments ...	91
Glossary	93
Index	95





Introduction

The compact, lightweight EPSON EMP-7300/7200/5300 Projector allows you to project XGA, full-color images and video onto a large screen for presentations. The projector can connect simultaneously to two image sources: one PC or Apple® Macintosh® computer image sources plus one video source such as a video tape deck, camcorder, or digital camera. Audio can also be connected for each image source.

Images are displayed in true XGA full color (16,670,000 colors) at a resolution of 1024 x 768 pixels. The projector produces bright images that can be easily seen in rooms with enough light to take notes. Audio can be produced from the projector's 1W+1W stereo, which employ a built-in SRS 3D sound® for output that is rich and powerful. An external speaker can also be connected when further amplification is required.

A totally new AVTSS™ (Automatic Video Tracking and Synchronization Sensing, patent pending) provides automatic set-up of image from a computer.

The projector can be controlled using a hand-held remote control unit, with menus being provided for image source switching and image adjustment. The remote control can also be used as a wireless mouse to control mouse operations on the computer screen during presentations. The projector software provides a number of add-on features that are designed to make presentations more effective.

The projector also features a new patented BIS CUIT (Balanced Image Size Conversion UnIT) chip which supports XGA computer output, as well as VGA and SXGA output. Whichever type of computer output is used, the result is a full-size video image of outstanding clarity.

The EMP-7300/7200/5300 Projector supports IBM-compatible PCs and laptops, as well as Apple® Macintosh®, Power Macintosh and PowerBook computers. The video source can be NTSC, PAL or SECAM in composite video, S-Video format.

Getting the Most Out of Your Projector

The projector comes with a full set of features that allow you to control the settings for the image display, video and audio. To get the most out of your projector read this section for a quick summary of the important features.

Remote control

The buttons on the remote control allow you to turn the projector on and off, and provide direct access to auto set-up, blank, freeze, volume, mute and image source switching. Remote control buttons can also be used for custom functions and to access the projector's menu system. The remote control can even be used instead of your computer's mouse to control your computer.

Sleep mode

The sleep mode conserves electricity by automatically turning off the lamp if the projector does not receive video input signal for specified period (default is 30 minutes). In the sleep mode, the projector remains on but the lamp is turned off, conserving electricity, cooling the projector and extending the life of the lamp.

Use the Power button to turn the projector on and off.

Control Panel

The control panel buttons on the projector duplicate the remote control buttons and let you perform additional functions, such as adjusting the tracking and sync for computer images.

Optional Accessories

To enhance your use of the projector, EPSON provides the following accessories:

- Spare lamp ELPLP05
- Computer cable ELPKC02
- Multi View ELPDC01
- Mac Adaptor Set ELPAP01
- Ceiling Mount ELPMB02
- Ceiling Plate ELPFC01
- Flange ELPFL01
- Pipe 370 ELPFP01
- Pipe 570 ELPFP02
- Pipe 770 ELPFP03
- Soft Carrying Case ELPKS10
- Hard Travel Case ELPKS09
- Hard Travel Case ELPKS12
- Long Throw Zoom Lens ELPLL01

You can purchase these accessories from your EMP-7300/7200/5300 dealer.

About This Manual

Chapter 1, “Installation”, gives step-by-step instructions on how to set-up the projector and connect it to your computer, video source, or other external speaker or PA system. Read the installation procedures that apply to your environment.

Chapter 2, “Using the Projector”, tells you how to switch the projector on/off and control simple projector settings.

Chapter 3, “Using the Menu”, describes how to use the menus to adjust the color and image settings, change the display of the projected image and modify audio settings such as bass and treble.

Chapter 4, “Using the Projector Software”, describes how to use the projector software which supports the presentation function and controls the projector with the computer you connected.

Chapter 5, “Maintenance”, describes how to maintain the projector.

Chapter 6, “Troubleshooting”, tells you how to interpret the projector’s indicator lights and gives helpful information for avoiding errors, optimizing image quality and solving problems.

Chapter 7, “Technical Specifications,” lists the technical specifications for your EMP-7300/7200/5300 projector.

Safety Instructions

Always follow these safety instructions when setting up and using the projector:

1. Do not place the projector on an unstable trolley, stand or table.
2. Do not use the projector near water or sources of heat.
3. Use attachments only as recommended.
4. Use the type of power source indicated on the projector. If you are not sure of the type of power available, consult your dealer or local electricity company.
5. Place the projector near a wall outlet where the plug can be easily unplugged.
6. Insert the projector's three-pin earthed plug into a properly earthed socket. If you have a two-pin socket, contact an electrician to replace it. Do not handle the plug with wet hands.
7. Always take the following precautions when handling the plug. Failure to do so may result in sparks or fire.
 - Ensure the plug is free of dust before inserting it into a socket.
 - Ensure that the plug is inserted into the socket securely.
8. Do not overload wall sockets, extension leads or multi-way plug boards as this may cause fire or electric shock.
9. Do not place the projector where the cord can be stepped on as this may result in fraying or damage to the lead or the plug.
10. Unplug the projector from the wall socket before cleaning. Use a damp cloth for cleaning. Do not use liquid or aerosol cleaners.

-
11. Do not block the slots and openings in the projector case. They provide ventilation and prevent the projector from overheating. Do not place the projector on a sofa, rug or other soft surface or in a built-in installation unless proper ventilation is provided.
 12. Never push objects of any kind through cabinet slots. Never allow liquid of any kind to spill into the projector.
 13. Except as specifically instructed in this Owner's Manual, do not attempt to service this product yourself. Opening or removing covers may expose you to dangerous voltages and other hazards. Refer all servicing to qualified service personnel.
 14. Unplug the projector during thunder storms or if it is not going to be used for an extended period. Do not place the projector or remote control on top of heat-emitting equipment or heated objects such as a car, etc.
 15. Do not place the projector and remote control on top of heat-producing equipment or in a heated place, such as a car.
 16. In the following situations unplug the projector from the wall outlet and refer servicing to qualified service personnel:
 - If the power cable or plug becomes damaged or frayed.
 - If liquid has been spilled into it or it has been exposed to rain or water.
 - If it does not operate normally when the operating instructions are followed or if it exhibits a clear change in performance indicating the need for servicing.
 - If it has been dropped or the cabinet has been damaged.

Where to Get Help

SEIKO EPSON CORPORATION provides local customer support and service through a nationwide network of authorized EPSON dealers and Service Centres.

- Fax-on-Demand access to EPSON's technical information library
- Literature on current and new products
- The location of your nearest Authorized EPSON Reseller or Customer Care Center
- Technical information on installation, configuration, and operation of EPSON products
- Customer relations

For inquiries please contact the appropriate representative listed in the section entitled "After sales service contact addresses" at the end of this manual.

When you call for technical assistance, be ready to identify your system and its configuration.

If you need help with any software program you are using, please refer to the documentation that came with the programs for technical support.

World Wide Web site

If you are connected to the Internet and have a Web browser, you can access EPSON's World Wide Web site at <http://www.epson.com>. EPSON's home page links users to What's New, EPSON Products, EPSON Connection, Corporate Info and EPSON Contacts. Link to the EPSON Connection for the latest drivers and FAQ's (Frequently Asked Questions) and the EPSON Chart area. To get in touch with EPSON around the world, EPSON Contacts includes Contact Information for local EPSON subsidiaries.

Transporting your projector

The projector contains many glass parts and precision parts. To prevent shock damages while transporting, handle as the following.

When transport to maker due to troubleshooting

- Use the original packing.
- If you don't have the original packaging use the equivalent, put cushioning around the projector.

When frequently transport for business use

- First, put the projector in a hard travel case (optional accessories : ELPKS09), then pack it in a firm box, using cushioning. Be sure to ask to the delivery company that treats a precision device.
- EPSON shall not be liable against any damages arose during the transportation.

When carry by hands

- Use a hard travel case (optional accessories : ELPKS12) or a soft carrying case (optional accessorise : ELPKS10).

When traveling by an airplane

- Bring the projector with you when traveling by an airplane.
- When transporting the projector as baggage on an aircraft, first put the projector in a hard travel case (ELPKS09) to avoid any damages.

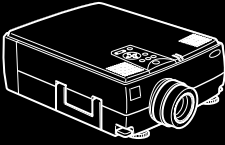

1

Installation

This chapter tells you how to unpack and set up your projector and connect it to other equipment. The projector must be connected to a computer or a video source such as a video tape deck, camcorder, digital camera or laser disk player. For example, you may want to connect the projector to both your computer and a video source, or set up the projector for one or more of the following:

- Connect the mouse cable to use the remote control as a wireless mouse.
- Provide audio for one or both image sources. The audio source can be the computer, video source, or another device such as a stereo.
- Connect to an external speaker or PA system to amplify the audio.

Unpacking the Projector

When you unpack the projector, make sure you have all these components:

- Projector
- Remote control
- 2 AA batteries
- Power cord
- Computer cable
- Audio cable
- Video/ audio cable
- MAC Desktop adapter
- MAC Monitor adapter
- Main cable
- PS/2 mouse cable
- Serial mouse cable
- MAC mouse cable
- PC serial cable
- MAC serial cable
- Projector Software

All of the above items may not be required for your particular computer system

Save all packaging materials in case you need to ship the projector in the future. It should always be transported in its original packaging or the equivalent.

Additional Items

The following items may also be required, depending upon how you plan to use the projector.

- S-Video cable for S-Video signal input
A separate cable is required for each video source.
- Macintosh PowerBook output cable

This cable is normally provided with PowerBook models with video output capabilities. Contact your Macintosh dealer if you need to purchase one.

- Special connector, cable or components for connecting the mouse cable to your computer

These items should be available from your computer dealer. Note that the mouse cable cannot be used with a computer that does not have a mouse connector.

- ◆ **Note:** *The hole on the right side of the projector accepts the connection of the Kensington MicroSaver anti-theft device, which can be purchased at your local computer dealer.*
- ◆ **CAUTION:** *Use of Projector parts or options, such as cables, other than the ones originally enclosed in the product package or designated by Seiko EPSON in the product manual may violate the EPSON confirmed quality level and may violate the legal requirements defined by EC Directives such as EMC directives of the CE Marking.*

Seiko EPSON recommends the use of the original or designated articles with all products. Customers should be aware that the use of non-recommended products may damage the product, cause the product to malfunction, compromise safety features and or may invalidate the product warranty.

Setting Up the Projector

1. Place the projector on a sturdy, level surface within five feet of the computer or video source.

◆ **Caution:** *Do not hold the projector by the lens. This can damage the lens.*

2. Place the projector the correct distance from the screen.

The distance between the projector and the screen determines the actual image size. Use the general guidelines below to determine the correct distance.

The distance above is a standard. Adjust to the correct distance as referring to the guidelines.

Screen size	Horizontal distance from projector to screen
300 inches (610x460cm)	488.2 inches (12.4 m) ~ 653.5 inches (16.6 m)
200 inches (410x300cm)	326.7 inches (8.3 m) ~ 433.0 inches (11.0 m)
100 inches (200x150cm)	161.4 inches (4.1 m) ~ 216.5 inches (5.5 m)
80 inches (160x120cm)	130.0 inches (3.3 m) ~ 169.2 inches (4.3 m)
60 inches (120x90cm)	98.4 inches (2.5 m) ~ 125.9 inches (3.2 m)
40 inches (81x61cm)	63.0 inches (1.6 m) ~ 82.6 inches (2.1 m)
30 inches (61x46cm)	47.2 inches (1.2 m) ~ 63.0 inches (1.6 m)
23 inches (47x35cm)	47.2 inches (1.2 m)

3. Turn the projector so that the lens is at right angles to the screen. If the projector is not angled correctly the screen image will be crooked.
4. Connect one end of the power cable to the projector's power connector. Connect the other end to an earthed electrical socket.
The projector should be in sleep mode, indicated by an orange power indicator.

◆ **Warning:** *Never look into the lens when the projector is on. There is a risk that the projector might come on suddenly even though it is not in use. The light from the lamp can damage your eyes. It is especially important that children should not be allowed to look into the lens.*

-
5. To insert the batteries in the remote control device, slide off the battery compartment cover as shown below.

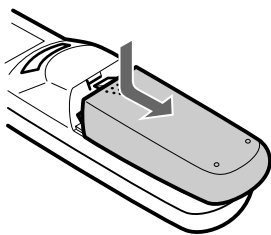

6. Insert the two AA batteries included with the projector. Make sure the polarity of the batteries is correct.

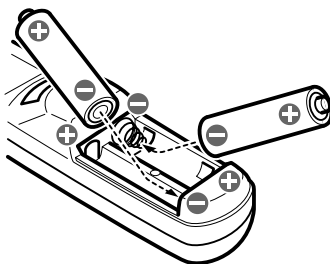

7. Replace the battery compartment cover.

When replacing batteries, take the following precautions:

- Do not recharge used batteries or expose batteries to fire or water.
- Replace batteries as soon as they run out. If the batteries leak, wipe away the fluid with a soft cloth. If battery fluid gets onto your hands wash them immediately.
- Remove the batteries if you will not be using the projector for a long period.

Connecting to a Computer

You can connect the projector to a computer capable of SVGA, VGA, SXGA, and XGA output. Resizing is supported for VGA, SVGA and SXGA output. Below a list may be found of the types of computers supported by this projector.

- IBM desktop PC or compatible
- IBM laptop or compatible
- Apple Macintosh desktop computer, including Macintosh Quadra®, Macintosh Centris®, and Power Macintosh
- Any Apple PowerBook with video-out capability, including all 160, 165, 180 and 500 series PowerBooks

See the section that applies to your computer.

Connecting to a PC desktop computer

Before beginning, make sure that the projector and computer are both turned off.

1. Connect the computer cable.

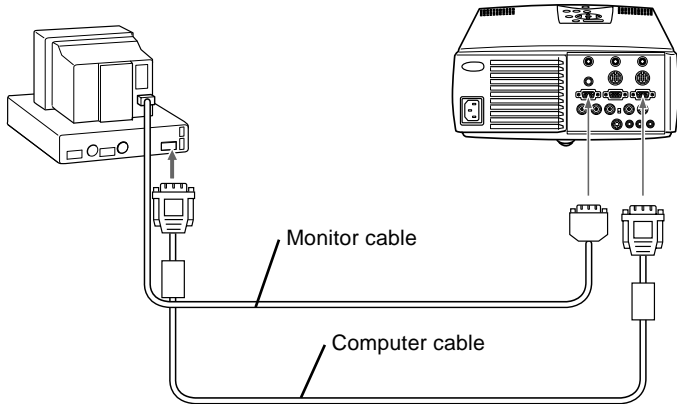

- ◆ **Note:** *Computer configurations vary. See your computer manual for the location of the ports needed to connect your EMP-7300/7200/5300 projector.*
 - a. Connect either end of the computer cable to the projector's Computer 1 port. The Computer 2 port is used when connecting a second computer.
 - b. Disconnect the monitor cable from the computer and connect it to the other end of the computer cable.

-
- c. If necessary, connect the monitor cable of the computer monitor to the projector's Computer out.
 - d. Tighten the screws on all connectors.

2. Connect the main cable. The main cable connects the mouse cable (needed to use the remote control as a mouse) and serial cable (needed to use the projector software and the Effects buttons on the remote control) from your computer to the projector.

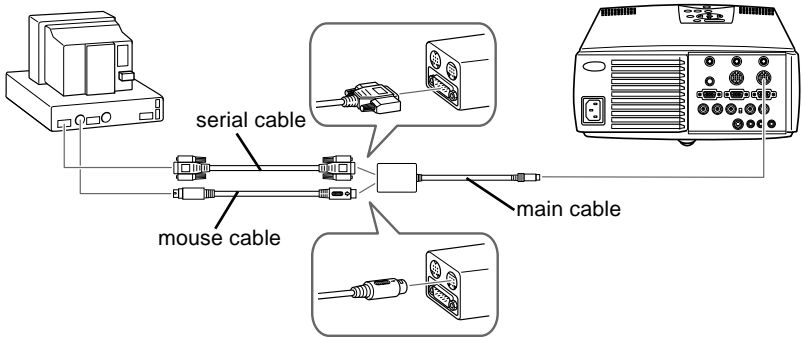

-
- a. Connect the small end of the main cable to the projector's Mouse/Com 1 port. The Mouse/Com 2 port is used when you are connecting a second computer.
 - b. Connect the PS/2 mouse cable (9-pin) to the mouse terminal on the large end of the main cable.
 - c. Disconnect the computer's mouse cable from the mouse port on the back of your computer and connect the mouse connector (6-pin) of the PS/2 mouse cable to the mouse port.
 - d. If your system uses a serial mouse, use the serial mouse cable instead of the PS/2 mouse cable.
 - e. If you are planning to use the projector software, connect either end of a PC serial cable to the PC serial terminal on the large end of the main cable.

◆ **Note:** *You will not be able to use the projector software if your system does not have two serial ports.*

- f. Connect the other end of the PC serial cable to the serial port on the back of your computer.
- g. Tighten all connector screws to ensure secure connections.

3. Connect the audio cable if needed.

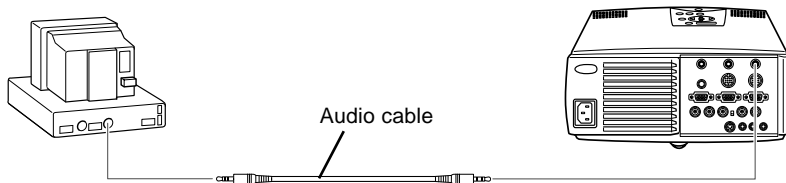

- a. Connect one end of the audio cable to the Audio 1 jack on the projector. (Use the Audio 2 jack if you are connecting a second computer).
- b. Connect the other end of the audio cable to the audio out port on a sound card in the computer.

Connecting to a PC laptop computer

Before beginning, make sure that the projector and computer are both turned off.

1. Connect the computer cable.

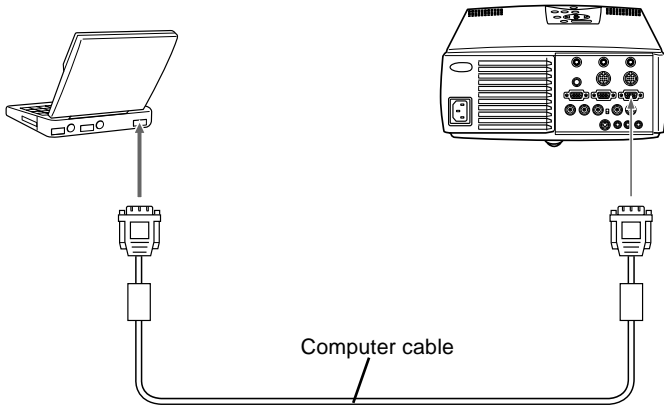

- ◆ **Note:** *Laptop configurations vary. See your computer manual for the location of the ports needed to connect your EMP-7300/7200/5300 projector.*
 - a. Connect either end of the computer cable to the projector's Computer 1 port. The Computer 2 port is used when connecting a second computer.
 - b. Connect the other end of the computer cable to the laptop's video (monitor) port.
 - c. Tighten the screws on all connectors to make sure they are fastened securely.

2. Connect the main cable. The main cable connects the mouse cable (needed to use the remote control as a mouse) and serial cable (needed to use the projector software and the Effects buttons on the remote control) to the projector.

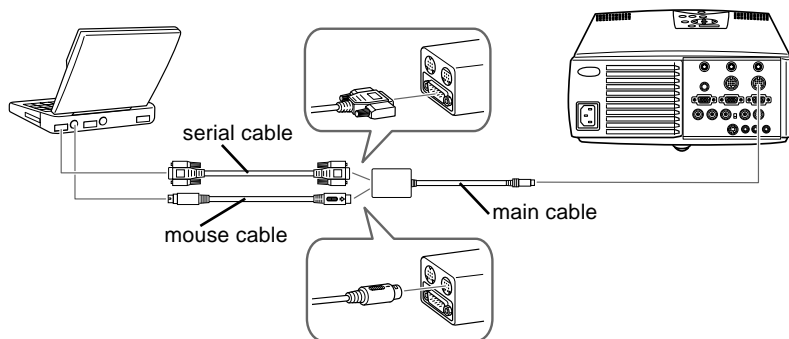

- a. Connect the small end of the main cable to the projector's Mouse/Com 1 port. The Mouse/Com 2 port is used when you are connecting a second computer.
- b. Connect the PS/2 mouse cable (9-pin) to the mouse terminal on the large end of the main cable.
- c. Disconnect the computer's mouse cable from the mouse port on the back of the computer and connect the mouse connector of the PS/2 mouse cable (6-pin) to the mouse port on the back of your laptop.
- d. If your system uses a serial mouse, use the serial mouse cable instead of the PS/2 mouse cable.

-
- e. If you are planning to use the projector software, connect either end of a PC serial cable to the PC SERIAL terminal on the large end of the main cable.
 - f. Connect the other end of the PC serial cable to the serial port on the back of your laptop.

◆ **Note:** *You will not be able to use the projector software if your system does not have two serial ports.*

- g. Tighten all connector screws to ensure secure connections.
- h. Configure your laptop to work with an external mouse.

3. Connect the audio cable.

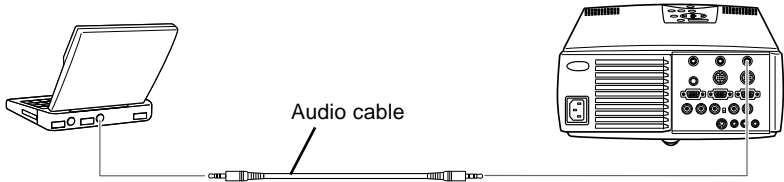

- a. Connect one end of the audio cable to the Audio 1 jack on the projector. (Use the Audio 2 jack if you are connecting a second computer).
- b. Connect the other end of the audio cable to your laptop.

Connecting to a Macintosh desktop computer

Before beginning, make sure that the projector and computer are both turned off.

1. Connect the computer cables.

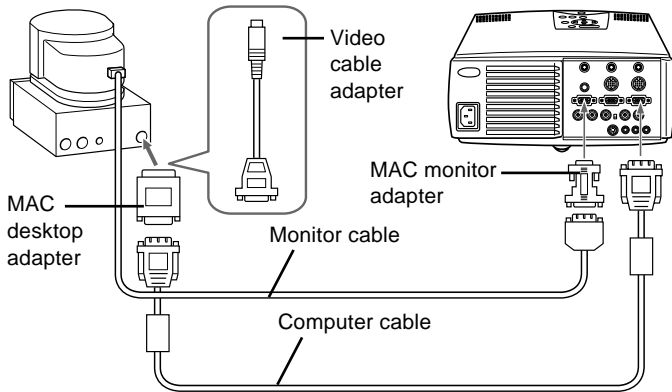

- ◆ **Note:** *Macintosh computer configurations vary. See your computer manual for the location of the ports needed to connect your EMP-7300/7200/5300 projector.*
 - a. Connect either end of the computer cable to the projector's Computer 1 port. The Computer 2 port is used when connecting a second computer.
 - b. Set the DIP switches of the Mac desktop adapter in accordance with the resolutions you want to use (i.e. 16" mode).
 - c. Connect either end of the computer cable to the small terminal of the desktop adapter.
 - d. Disconnect the monitor cable from the computer and connect it to the large terminal (D-sub 15 pin) of the desktop adapter.

-
- e. Tighten fixed screws for the desktop adapter.
 - f. If necessary, attach the Mac monitor adapter to the monitor cable and connect the cable with the adapter to the projector's Computer out.

2. Connect the main cable. The main cable connects the mouse cable (needed to use the remote control as a mouse) and serial cable (needed to use the projector software) from your Macintosh to the projector.

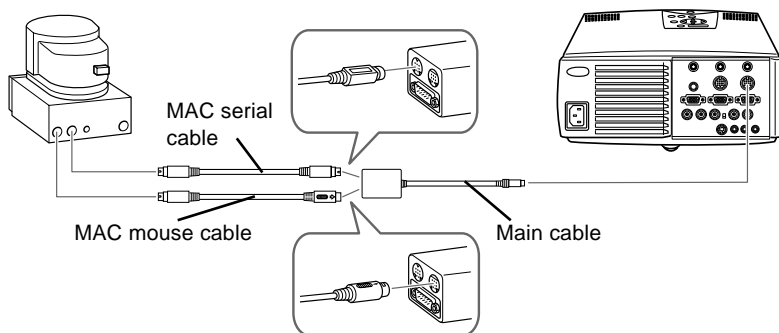

- a. Connect the small end of the main cable to the projector's Mouse/Com 1 port. The Mouse/Com 2 port is used when you are connecting a second computer.
- b. Connect the MAC mouse cable (9-pin) to the mouse terminal on the other end of the main cable.
- c. Disconnect the mouse cable from the Mouse port of the Macintosh and connect the mouse connector of the MAC mouse cable to it.
- d. If you are planning to use the projector software, connect either end of a MAC serial cable to the MAC serial terminal at the large end of the main cable. Connect the other end of the MAC serial cable to the printer port or modem port on the back of your Macintosh.

3. Connect the audio cable.

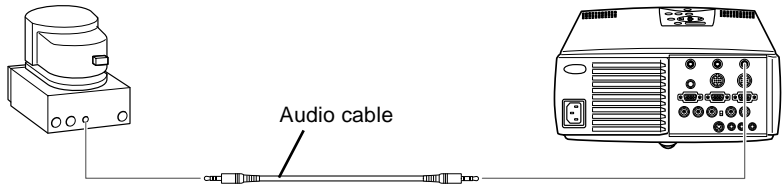

- a. Connect one end of the audio cable to the Audio 1 jack on the projector. (Use the Audio 2 jack if you are connecting a second computer.)
- b. Connect the other end of the audio cable to your computer.

Connecting to a Macintosh PowerBook

Remember that you can only use a PowerBook model that have video-out capability. See page 7 for more information.

Before beginning, make sure that the projector and PowerBook are both turned off.

1. Connect the computer cable.

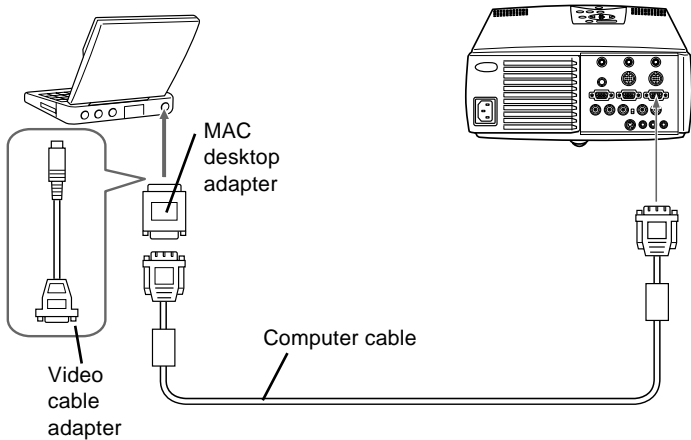

- ◆ **Note:** *PowerBook configurations vary. See your computer manual for the location of the ports needed to connect your EMP -7300/7200/5300 projector.*
 - a. Connect the other end of the computer cable to the projector's Computer 1 port. The Computer 2 port is used when connecting a second computer.
 - b. Set the DIP switches of the MAC desktop adapter in accordance with the resolutions you want to use (i.e. 16" mode).
 - c. Connect an adapter (which came with the computer or your own) such as a converter for a D-Sub 15 terminal to the video output port of your PowerBook.

-
- d. Connect the big connector (D-Sub15) of the MAC desktop adapter to the video output port converted in step c.
 - e. Connect either end of the computer cable to the small connector (D-Sub 15 Mini) of the MAC desktop adapter which you connected in the previous steps.
 - f. Tighten the fixed screws for the MAC desktop adapter and the converter.

2. Connect the main cable. The main cable connects the mouse cable (needed to use the remote control as a mouse) and serial cable (needed to use the projector software) to the projector.

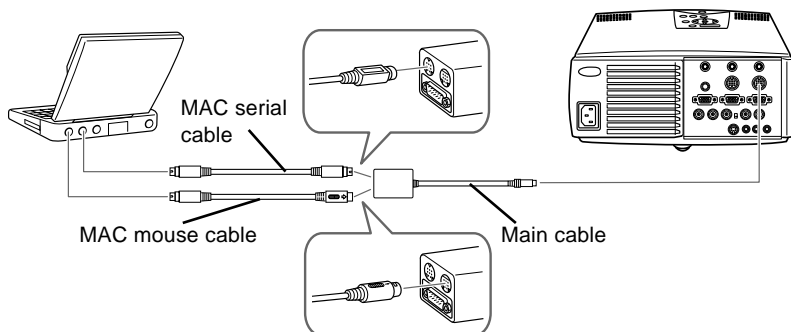

- a. Connect the small end of the main cable to the projector's Mouse/Com 1 port. The Mouse/Com 2 port is used when connecting a second computer.
- b. Connect the MAC mouse cable (9-pin) to the MOUSE terminal on the large end of the main cable.
- c. Disconnect the mouse from the computer port, and connect the MAC mouse cable (4-pin) to this port.
- d. If you are planning to use the projector software, connect either end of a MAC serial cable to the MAC SERIAL terminal on the large end of the main cable. Connect the other end of the MAC serial cable to the Printer port or Modem port on the back of your PowerBook.
- e. Tighten the screws on all connectors to make sure they are fastened securely.

3. Connect the audio cable.

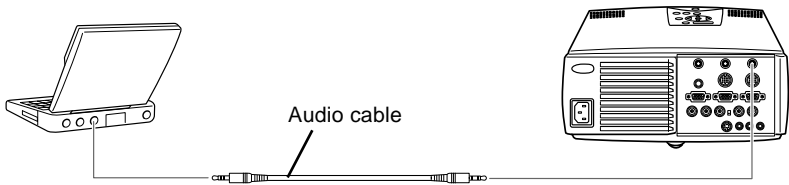

- a. Connect one end of the audio cable to the Audio 1 jack on the projector. (Use the Audio 2 jack if you are connecting a second computer.)
- b. Connect the other end of the audio cable to your computer.

Connecting to a Video Source

You can use this connection procedure to connect a video tape deck, a camcorder, a laser disc player or any other compatible video image source to the projector. The projector can receive composite video or S-Video signals. If your video source has a one-pin RCA video jack you have a composite video. If your video source has a four-pin video jack, you have a S-Video. If your video source has a three-pin video jack, you have a component video (Y/Video, C/R-Y, and B-Y).

- ◆ **Note:** *The projector is not compatible with a cable TV-style F connector.*

You can connect to both a S-Video and a composite video source at the same time. However, the projector automatically selects the S-Video source. To display the composite video, you must disconnect the S-Video source.

The projector supports NTSC, PAL and SECAM video formats. By default, it automatically detects and identifies the video format. However, you can set it to detect a single broadcast format. (See “Video menu” in Chapter 3.) Note that the projector will then be able to detect only one type of video signal.

The type of cable you need to connect the video source to the projector depends on whether you have a composite video, S-Video or a component video (Y/Video, C/R-Y, and B-Y). For composite video, use the video/ audio cable supplied with the projector. For S-Video, use the S-Video cable and audio cable supplied with your video device or obtain one from your computer dealer. For a component video (Y/Video, C/R-Y, and B-Y), use the BNC type cable came with your video source.

To connect a video source to the projector:

1. Switch off the projector and video source if they are on.
2. If your composite video uses an RCA-type composite video connector, you will need the audio/video cable supplied with the EMP-7300/7200/5300. If your video uses a S-Video or BNC type connector, you will need to provide YOUR OWN S-Video or BNC type cable, or use the S-Video or BNC type cable that came with your video source.
3. For composite video, connect the yellow RCA plug at one end of the video/audio cable to the projector's Video jack. Connect the other yellow RCA plug to the video-out jack on the video source.

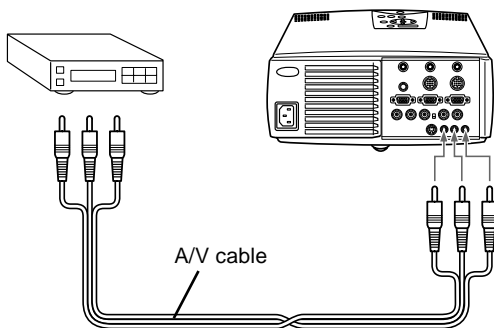

4. Connect the other plugs on the audio/visual cable to the Audio jacks of the projector: insert the white plug into the L jack and the red plug into the R jack. Connect the plug at the other end of the audio/visual cable to the audio output jacks of the video source.

5. For S-Video, insert one end of the S-Video cable into the projector's S-Video jack. Insert the other end in the S-Video Out jack on your S-Video source.

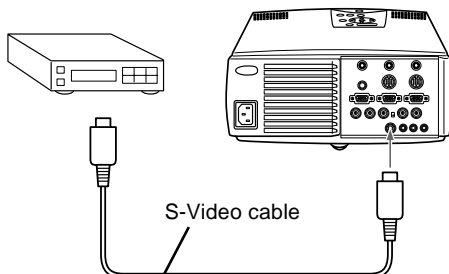

6. For G Sync-Video (BNC type), insert the end of the G Sync-Video cable into the projector's R/R-Y, G/Y and B/B-Y jack. Insert the other end in the jack on your G Sync-Video source.

Connecting to an External Speaker or PA System

Though the projector's internal speakers are enough for most small-size or medium-size rooms, an external speaker can be connected to achieve the best results for large room presentations.

A commercially available RCA-to-3.5 mm stereo mini audio cable or 3.5 mm stereo mini audio cable is required to connect the projector's 3.5 mm stereo mini jack to an external speaker or a PA system. These items can be obtained from your computer dealer.

1. Check to ensure that both the projector and all sources are turned off.

-
2. Connect the cable's 3.5 mm stereo mini-plug to the projector's Audio Out jack.

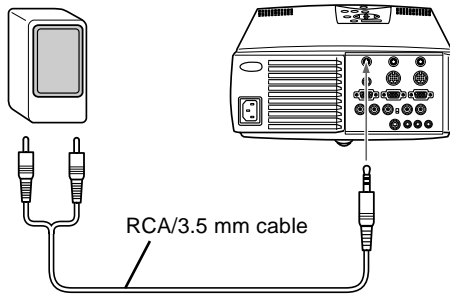

3. Connect the other end of the cable to the external speaker or PA system. Ensure you to connect the red RCA plug to the right channel and the white RCA plug to the left channel.

Connecting to a Workstation (only available for the EMP-7300/7200)

You can not use any kind of workstations. Before connecting, make sure the type of your workstation. If you are not sure of the type of workstation, consult your dealer or local workstation company.

The following workstations are available:

- If your workstation output is 13W3, use a 13W3(male)↔HD D-Sub15(male) cable.
(Epson recommended, MS8158CA (1.8m) 6ft, MS8128CA (0.9m) 3ft)

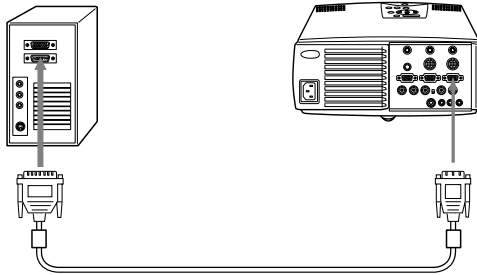

- If your workstation output is 5BNC, use a 5BNC(male)↔HD D-Sub15(male) cable
(Epson recommended, MS8102CA (1.8m) 6ft)

* You need to turn the Computer2/5BNC switch on the back of the projector to 5BNC.

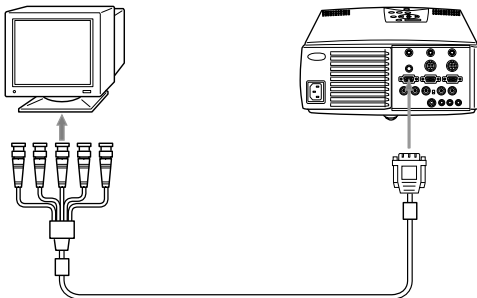

◆ **Note:** If your computer contains the workstation function, refer the section of "Connecting to a Computer" to connect.

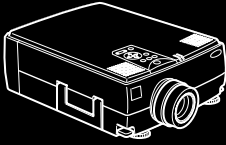

2

Using the Projector

This chapter provides the following information about using your projector:

- Turning equipment on and off
- Adjusting the screen image
- Controlling the projector
- Checking the status of the projector

The illustration below identifies the parts of your projector.

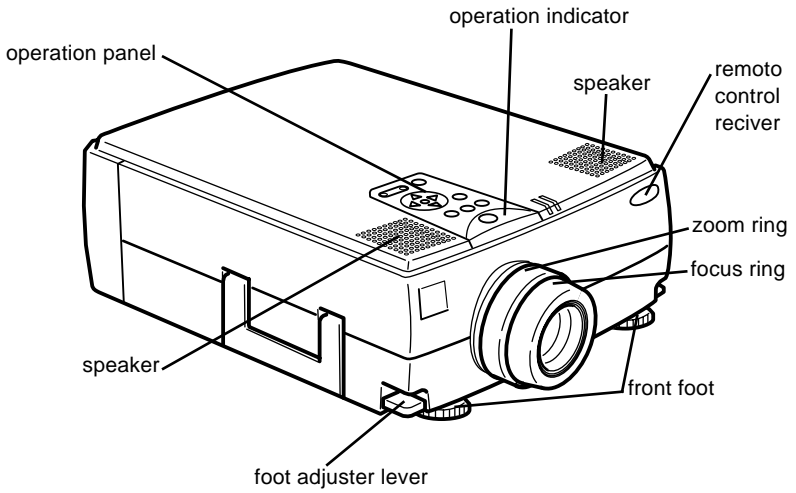

Turning the Equipment On and Off

Always turn on the projector and its attached equipment in the following order.

1. Video source
2. Audio source (if different than computer or video source)
3. Projector
4. External speaker or PA system
5. Computer

Turning the Projector On and Off

1. Remove the projector lens cap.
2. Press the Power button on the remote control or control panel. The green power indicator comes on.

If computer or video equipment is attached, the computer or video signal is projected.

Allow about 30 seconds for full illumination.

- ◆ **Warning:** *Never look into the lens when the lamp is on. This can damage your eyes. It is especially important that children are not allowed to look into the lens.*

Reverse the order shown above to turn off the projector and other equipment. After you press the Power button to turn off the projector, the fan will remain on and the operation indicator will flash orange for about one minute as the projector cools.

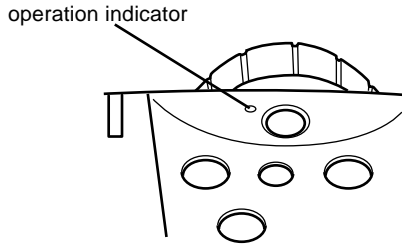

The indicator stops blinking (and remains lit in orange) when the cooling operation is complete.

- ◆ **Note:** *The projector is designed so that it cannot be turned back on while the power indicator is flashing green. Before pressing the Power button again, wait until the lamp has cooled and the operation indicator is orange.*

Sleep Mode

Sleep mode conserves electricity by automatically turning off the lamp after the projector has not been used for 30 minutes. In sleep mode, the projector's operation indicator is orange and only a minimum amount of the projector's circuitry remains on. This conserves electricity, cools the projector, and extends the life of the lamp. When the projector is in sleep mode, you can press the Power button to start projecting images, or you can unplug the projector's power cord.

Focusing and Positioning the Screen Image

After an image appears on the screen, check to see if it is in focus and whether it fits properly on the screen.

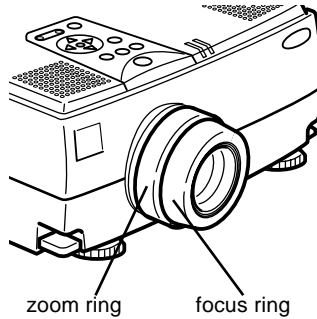

- To adjust the focus of the image, rotate the focus ring, which is the outer ring on the projector's lens.
- To adjust the size of the image, rotate the inner zoom ring. Rotate the zoom ring clockwise to make the image larger, and counterclockwise to make it smaller.

If you need to raise or lower the image on the screen, extend or retract the two feet at the bottom of the projector as follows.

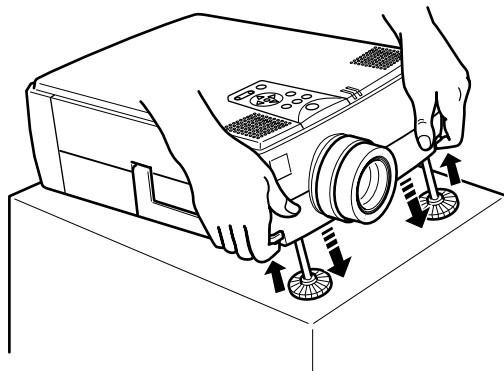

1. Stand behind the projector and support the front of it while you lift the foot adjuster lever located above the feet. This unlocks the feet so they can move up and down freely. Do not let the projector drop.

◆ **Caution:** Do not hold the projector by the lens as you may damage it.

2. While lifting the foot adjuster lever, raise or lower the projector until the screen image is positioned correctly.
3. Release the lever to lock the feet in their new position.
4. To fine-tune the height of the projector, turn the feet clockwise to raise the height or anti-clockwise to lower it.

Resize Button

The Resize button allows you to select the projection screen mode for certain types of image input signals from a computer.

EMP-7300/7200

With images up to XGA size(1024x768 pixels), you can choose from two projection methods. Either display the image in the center of the projection area(Window display) or display the image full size(Resize display).

You can also choose from two projection methods with images greater than XGA size. Either project a portion of the image or project the entire image in a compressed format. The projector automatically reduces the image size to the projector's maximum resolution. The Resize button cannot be used with XGA

EMP-5300

With images up to SVGA(800x600 pixels), you can choose from two projection methods. Either display the image in the center of the projection area(Window display) or display the image full size(Resize display).

You can also choose from two projection methods with images greater than SVGA size. Either project a portion of the image or project the entire image in a compressed format. The projector automatically reduces the image size to the projector's maximum resolution. The Resize button cannot be used with SVGA.

Controlling the Projector

Normally you control the projector using the remote control. The buttons on the remote control allow you to do the following:

- Switch power on and off.
- Auto-set-up of the computer image screen.
- Switch between input images (Computer 1, Computer 2, video-computer).
- Access menu for adjustment of image, audio, video, and display settings.
- Control resizing.
- Control display freeze.
- Control display blanking.
- Adjust and mute audio output.
- Control custom functions.
- Move the pointer.

Using the Remote Control

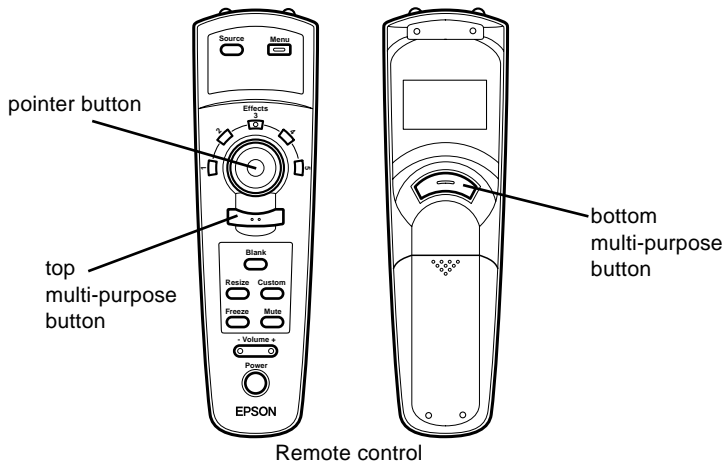

When using the remote control, always point it towards the remote control receivers located at the front and at the back of the projector.

To be able to use the remote control as a cordless mouse connect the projector to your computer with all cables came with the EMP-7300/7200/5300.

To use the remote control, always point it towards the remote control receivers located at the front of the projector.

You can use the remote control up to 10 metres (33 feet) from the projector.

- ◆ **Note:** *The projector may not respond to remote control commands in these conditions: ambient light is too bright; a certain type of fluorescent light is present; a strong light source (such as direct sunlight) shines into the infrared receiver; or other equipment emitting infrared energy is present (such as a radiant room heater). Remove these conditions to use the remote control or control the projector from a computer.*

In addition to the remote control, you can also control the projector by using the buttons on the projector's operation panel located on top of the projector.

This table summarizes the functions on the remote control.

Button	Function
Menu	Displays or hides the menu.
Source	Switches to Computer 1 , Computer 2* , or Video.
Pointer button	Use the pointer button to navigate the menus or use the remote as a mouse pointer when the projector is connected to the computer with all cables came with the EMP-7300/7200/5300.
Effects buttons	Use to display special effects in conjunction with the projector software.
Top multi-purpose button	Acts as a right mouse click, registers a menu selection, and selects other custom functions.
Bottom multi-purpose button	Acts as a left mouse click, registers a menu selection, and selects other custom functions.
Blank	Clears the screen of special effects and switches to a black, a blue or user logo display.
Resize	Switches the display dot mode and resize mode (for VGA, SVGA and SXGA input).
Custom	Use to assign functions to the Effects keys using the projector software.
Freeze	Keeps the current computer or video image on the screen.
Mute	Cuts off audio.
– Volume +	Adjusts the volume.
Power	Starts or stops the projector.

* When the computer 2/5 BNC switch on the back of the projector is turned to 5 BNC, the source is switch to 5 BNC.

Using the Control Panel

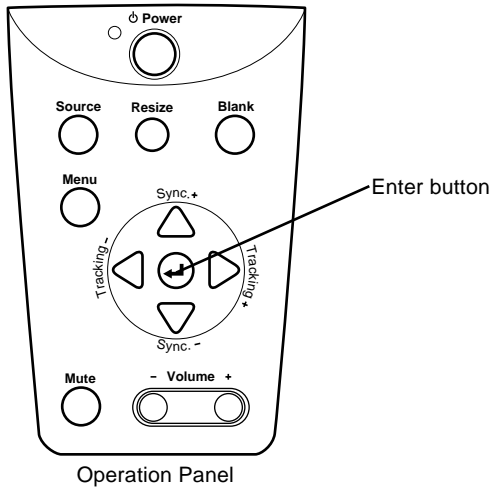

You can use the control panel to control the printer instead of the remote control. However, you can program and access the custom features only when you are using the remote control.

The following table summarizes the functions on the control panel.

Button	Function
Power	Starts or stops projection.
Source	Switches to Computer 1 , Computer 2*, or Video.
Menu	Displays or hides the menu.
Up, down arrows (Sync+/Sync-)	Synchronizes the computer's graphic signal. Use these buttons to adjust an overall image that is fuzzy or streaked, or to select menu items during menu operations.
Left, right arrows(tracking-/ tracking+)	Matches the projector's internal clock to various computer graphic signals (tracking adjustment). Use these buttons to adjust an image with vertical fuzzy lines, or to change numeric settings during menu operations.
Enter key	Registers a menu selection.
Resize	Switches the display dot mode and resize mode (for VGA, SVGA, and SXGA input).
Mute	Cuts off audio.
- Volume +	Adjusts the volume.

* When the computer 2/5 BNC switch on the back of the projector is turned to 5 BNC, the source is switch to 5 BNC.

Projector Status Indicators

The power and lamp indicators at the top of the projector tell you the projector's operating status.

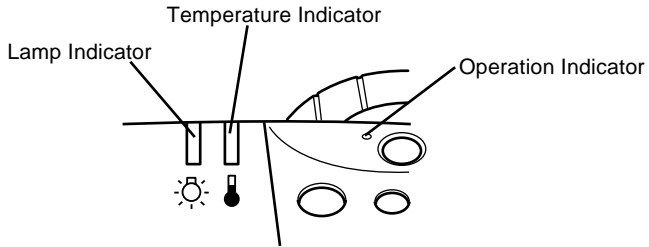

- ◆ **Caution:** A red indicator warns you if a serious problem occurs. See Chapter 6, "Troubleshooting," for what to do if a warning light comes on.

Operation Indicator

Displays machine condition.

Color	Status	Meaning
Orange	Lit	Sleep mode.
Green	Flashing	Projection lamp is warming up for 30 sec.. After that, the indicator will turn to lit to start projecting.
Green	Lit	The projector is projecting and providing the maximum of brightness.
Orange	Flashing	Projection lamp is off, the projector is cooling down for one minute. While cooling, operations can not work.
-	Off	The projector has internal projector problem and turned off.

Lamp Indicator

Displays lamp condition.

This indicator is off when the projector is in a normal condition.

Color	Status	Meaning
-	Off	The projector is in a normal condition.
Orange and Red	Flashing	Projection lamp is reaching the end of its life and should be replaced with a new one.
Red	Lit	Projection lamp has reached the end of its life and will not longer project images. Replace the projection lamp with a new one.
Red	Flashing	The projector has lamp or other problems around the lamp. Contact your nearest service provider.

Temperature Indicator

Displays the internal temperature condition.

This indicator is off when the projector is in a normal condition.

Color	Status	Meaning
-	Off	The projector is in a normal condition.
Orange	Flashing	The projector is in a hot condition.
Red	Lit	The projector is too hot and turned off.
Red	Flashing	The projector has a cooling fan or temperature sensor problem. Contact your nearest service provider.

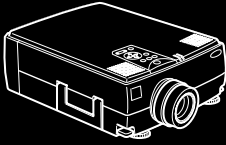

3

Using the Projector Menus

- The seven projector menus enable you to control your projector.
- The Computer menu controls the computer image, such as brightness and contrast, when the computer is the image source.
- The Video menu controls the video image, such as brightness and color saturation, when the image source is video, such as a VCR.
- The Audio menu controls audio features, such as the volume level, tone setting, and 3D sound.
- The Options menu enables you to set various projector options.
- The Custom menu assigns functions to the remote control's Custom button.
- The About Menu displays lamp hours, frequency and etc..
- The Reset All menu returns all settings to their factory defaults.

Accessing the Main Menu

The projector menus can be accessed using either the projector control panel or remote control.

To display the Main menu, press the Menu button. The Main menu appears:

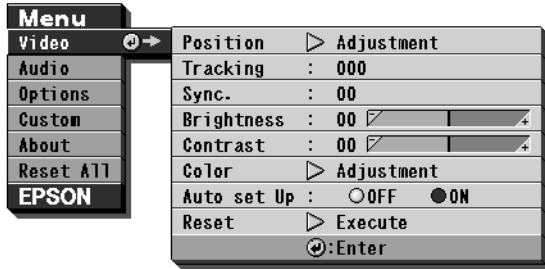

Press the Menu button again to hide the menu.

Changing a Menu Setting

To change a menu setting:

1. Press the Menu button on the control panel or remote control to display the Main menu.

2. Press the up or down arrows (control panel) or press the top or bottom of the pointer button (remote) to scroll through the menu choices.

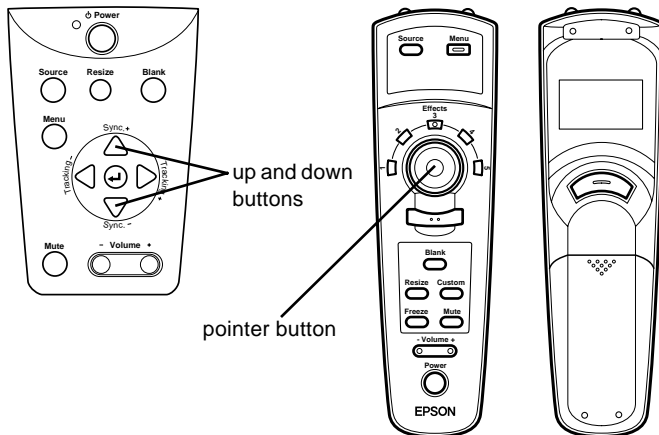

- Press either the Enter button (control panel) or the top or bottom multi-purpose button (remote) to display a submenu.

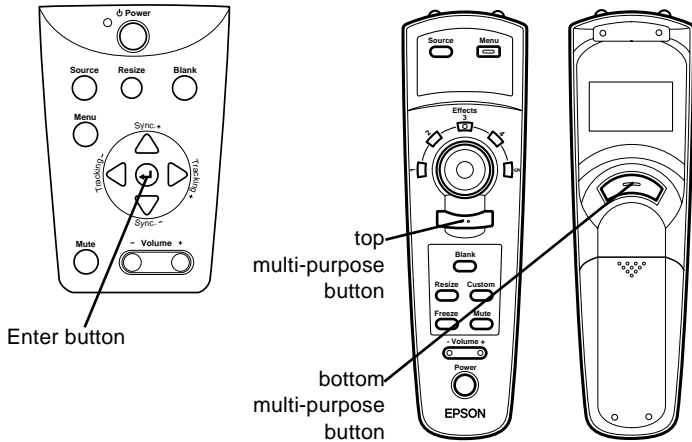

A sub-menu such as the following appears.

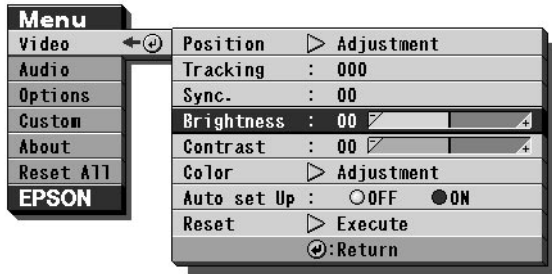

- ◆ **Note:** Sub-menus differ, depending on if the current image source is Computer or Video.

-
4. Press the up or down arrows (control panel) or the top or bottom of the pointer button (remote) to scroll through the menu choices.
 5. Press either the left or right arrow buttons (control panel) or the right or left sides of the pointer button (remote) to change the setting.
 6. When you are finished changing settings, press the Menu button again to hide the menu, or press Enter to go back to the Main menu. The changes are saved automatically.

Menu Options

The following menus are described in this section:

- Video menu (Image source = Computer)
- Video menu (Image source = Video)
- Audio menu
- Options menu
- Custom menu
- About menu
- Reset All menu

Video Menu (Image source = Computer)

The Video menu enables you make adjustments to the projected image. The following options are available when the image source is Computer.

- ◆ **Note:** *The computer must be connected and operating, and the image source on the projector must be set to Computer for you to access these menu options.*

Menu item	Description
Brightness	Lightens or darkens the overall image. Increase brightness to make the image lighter, or decrease it to make the image darker.
Contrast	Adjusts the relative difference between light and dark areas. Increase contrast to make light areas lighter and dark areas darker, or decrease it to lessen the difference between the light areas and dark areas of the image.
Sync	Synchronizes with the tracking signal sent from the computer. Adjust this setting whenever the overall image is fuzzy or to remove streaks from the image.
Tracking	Matches the projector's internal clock to various computer graphic signals. Adjust this setting to remove vertical fuzzy lines from the image.
Color	Adjusts the color balance of the input source. Select this item and then press a Click button or the <Enter> button to enter the color adjustment mode. While in the color adjustment mode, use the pointing button or the <Up> and <Down> button to select a color. Next, use the pointing button or <Left> and <Right> buttons to adjust the selected color. Increasing a color's setting makes that color more intense on the screen, while a lower setting makes the color less intense. After you are finished, press a Click button or the <Enter> button to return to the Computer Menu.
Position	Select this item and then press a Click button or the <Enter> button to enter the screen position adjustment mode. While in the screen position adjustment mode, use the pointing button or the <Up>, <Down>, <Left> and <Right> buttons to move the screen position in the corresponding direction. After you are finished, press a Click button or the <Enter> button to return to the Computer Menu.

Menu item	Description
Auto	Pressing AUTO automatically adjusts the computer input signal to the current projector settings. Press the AUTO button while the image fills the entire screen of your computer, like a Windows screen. Certain computer input signals may not be totally compatible with AUTO button settings. In such cases, use the menus to make additional adjustments.
Reset	Returns all Computer Menu items to their factory defaults. Select this item and then press a Click button or the <Enter> button to display the confirmation screen. Next, select Yes and then press a Click button or the <Enter> button to reset the Computer Menu items. If you change your mind, select No and then press a Click button or the <Enter> button to clear the confirmation screen without changing any settings.



Video Menu (Image source = Video)

The Video menu enables you make adjustments to the projected image. The following options are available when the image source is Video.

- ◆ **Note:** *The video source (such as a VCR or camcorder) must be connected and operating, and the image source on the projector must be set to Video for you to access these menu options.*

Menu item	Description
Brightness	Lightens or darkens the overall image. Increase brightness to make the image lighter, or decrease it to make the image darker.
Contrast	Adjusts the relative difference between light and dark areas. Increase contrast to make light areas lighter and dark areas darker, or decrease it to lessen the difference between the light areas and dark areas of the image.
Sharpness	Adjusts screen sharpness. Increase sharpness to make screen images more sharp, or decrease it to make the images less sharp.
Saturation	Adjusts color density. Increase color density to make colors darker and more opaque, or decrease it to make colors lighter and less opaque.
Tint (NTSC only)	Adjust the red-green balance of the screen. Increase tint to add more green, or decrease it to add more red.
Auto	Specifies the video signal system. Normally this signal system setting should be left at AUTO for automatic detection of the video signal system. If automatic selection is not possible for some reason, use this menu to manually specify NTSC, NTSC 4.43, PAL, MPAL, NPAL, PAL (60Hz) or SECAM.

Options Menu

The Options menu enables you to adjust basic settings that normally do not need changing.

Menu item	Description
Prompt	Temporarily displays a prompt on the projector screen to identify which source (computer or video) is providing the image.
Color Temp.	Adjusts the whiteness of the screen. The H setting provides a cold white, M standard white, L a warm white, and U sets sub-brightness R, B. Selecting the User item and pressing a Click button or the <Enter> button displays a screen for more precise color temperature setting. Use the pointing button or the <Up> and <Down> buttons to select the color you want to adjust, and then use the pointing button of the <Left> and <Right> buttons to change the selected value. A high color temperature value enhances the selected color within the overall image, while a lower value weakens the color. Press a Click button or the <Enter> button to clear the setting screen and return to the Option Menu.
Rear Proj.	Mirrors the projected images horizontally (left-right). Selecting ON turns mirroring on, while OFF turns it off (for a normal image). Turn this option on when projecting from behind onto a transparent screen being viewed from the opposite side.
Ceiling	Mirrors the projected images vertically (top-bottom) and horizontally (left-right). Selecting ON turns mirroring on, while OFF turns it off (for a normal image). Turn this option on when hanging the projector upside-down from the ceiling.
Blank	Selects what should be projected when the projector's Blank button is pressed to blank the screen. You can select either a black screen, a blue screen or a user logo. A user logo can be created using the projector software that comes with the projector.

Menu item	Description
View Change	<p>Specifies the view change to use when the input source is changed.</p> <p>OFF: No visual effects, simply cut to new source.</p> <p>Diagonal : Original source screen shrinks from upper left to lower right, and new source screen expands from upper left to lower right.</p> <p>Left → Right : Original source screen shrinks from left to right, and new source screen expands from left to right.</p> <p>Fade : Original source screen shrinks from outside in, and new source screen expands from inside out.</p>
Language	<p>Selects the menu language in the sequence: Japanese, English, German, French, Italian, Spanish and Portuguese.</p>
Mouse /COM	<p>Locks and unlocks the Mouse/Com port.</p> <p>Select 1 to assign the wireless mouse control to the computer connected to the Mouse/Com 1 port. The wireless mouse controls the computer connected to Mouse/Com 1 only if the input source is switched to Computer 2.</p> <p>Select 2 to assign the wireless mouse control to the computer connected to the Mouse/Com 2 port.</p> <p>Selecting 1→2 tells the projector to automatically switch wireless mouse control whenever the input source computer is changed.</p>
BNC	<p>Specifies input image signal mode. User can select either RGB or R-Y,Y,B-Y.</p>
Reset	<p>Returns all Option Menu items to their factory defaults. Select this item and then press a Click button or the <Enter> button to display the confirmation screen. Next, select Yes and then press a Click button or the <Enter> button to reset the Option Menu items. If you change your mind, select No and then press a Click button of the <Enter> button to clear the confirmation screen without changing any settings.</p>

Custom Menu

The Custom menu allows you to select special features such as zoom, preview, or strobe effects. Unlike the other menus, which use the Enter button to select a menu option, the Custom menu requires that you use the Custom button to select a Custom menu option.

The Custom button is located on the lower part of the remote control.

To open the Custom menu, press the top multi-purpose button or select CUSTOM from the Main menu. ZOOM is highlighted and the words PRESENT SET are displayed after it. Refer to the table below for a description of the various zoom functions.

To change PREVIEW or STROBE settings, select the function you want, then press the top multi-purpose button.

The Custom menu functions are:

Menu item	Function	Description
Zoom		Press the bottom multi-purpose button then check if the value next to the Zoom menu is New Set or Present Set. If the value is New Set, press the bottom multi-purpose button to toggle the value. Press the Custom button to access the Zoom function. An indicator appears in the lower right of the screen while the zoom function is on. Zoom remains on until you press the Custom button again. The following remote control functions are available while the zoom function is on:
	Zoom In	Each press of the remote control's bottom multi-purpose button zooms in on the center of the displayed image, enlarging it +0.25 times.

Menu item	Function	Description
	Zoom Out	Each press of the remote control's top multi-purpose button zooms out on the center of the displayed image, reducing it +0.25 times.
	Zoom Screen Shift	Press the pointer button to zoom in on a portion of the enlarged display. You can move the image up, down, left, right, and diagonally to closely view any part of the display.
Preview		<p>Press the bottom multi-purpose button then check if the value next to the Preview menu is New Set or Present Set. If the value is New Set, press the bottom multi-purpose button to toggle the value.</p> <p>Press the Custom button to turn on the Preview function. The preview function remains on until you press the Custom button again, select an input source with the pointer button, or press the remote control's bottom multi-purpose button.</p>
Strobe		<p>Press the bottom multi-purpose button then check if the value next to the Strobe menu is New Set or Present Set. If the value is New Set, press the bottom multi-purpose button to toggle the value.</p> <p>Press the Custom button to turn on the strobe function. The strobe function remains on until you press the Custom button again. The screen is divided into four quadrants, each of which shows the image from the current input source.</p>



Menu item	Function	Description
	Number of Frames, Time	Press the top multi-purpose button while the strobe effect is running to display a screen specifying the number of frames flashed and the time interval between them. You can specify the number of frames as 4, 9, or 16, and the time interval from 0.1 to 1 second in 0.1 second increments. Press the top multi-purpose button again to clear the setting screen.

About Menu

The About menu displays the following information about your projector.

H/V Freq.	Displays H/V frequency of the current computer.
COMPUTER2 / 5BNC	Switches between computer2 and 5BNC.
LAMP	Displays the number of hours the current projector lamp has been used. The color of this display turns red when the projector lamp is near the end of its normal life. When this happens, replace the projector lamp with a new one as soon as possible.

RESET ALL Menu

Executing this command resets the settings in all menus to their factory defaults.

While executing this command, the OSD menu disappears from a screen and "RESET ALL" will be flashing on the center of the screen.

Select this item and then press a Click button or the <Enter> button to display the confirmation screen.

Next, select Yes and then press a Click button or the <Enter> button to reset all menu items.

If you change your mind, select No and then press a Click button or the <Enter> button to clear the confirmation screen without changing any settings.



4

Using the Projector Software

The Link Set package includes materials necessary to use the ELP Link III V2.0 utility. This utility runs on your computer to control projector features and to configure buttons on the remote control. ELP Link III V2.0 has two functions related to your EPSON projector.

Presentation support function

The presentation support function allows you to perform real-time presentation effectively by a remote control shipped with the projector.

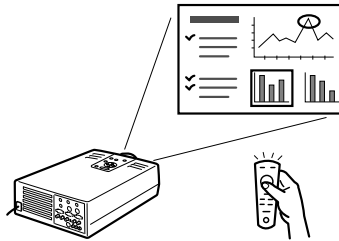

Projector setting function

The projector setting function allows you to control the projector from your computer.

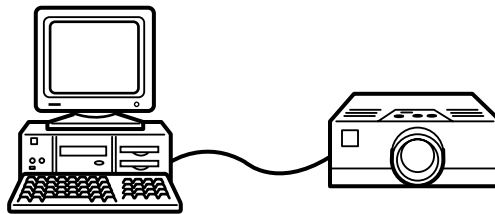

- ◆ **Note:** See the *ELP Link III V2.0 demonstration* included in the *Projector Software CD-ROM*.

System requirements

To use the ELP Link III V2.0 utility and to look at the PDF User's Guide and demonstration, the following system requirements must be met.

Using a PC

- IBM compatible PC with Pentium or higher processor
- Microsoft Windows 95 or Windows NT 4.0, 3.51, or Windows 3.1
- At least 16MB of RAM for ELP Link III V2.0 to work
- 16MB to be added for Acrobat Reader to work)
- At least 2MB of free hard disk space for ELP Link III V2.0 installation (8MB to be added for Acrobat Reader and 3MB for User's Guide installation, 8MB for the ELP Link III V2.0 demonstration)
- Double-speed CD-ROM drive (Quad-speed or faster recommended)
- VGA or better monitor

Using a Macintosh

- 68000 series or PowerPC processor
- System 7.5 or later
- At least 16MB of RAM for ELP Link III V2.0 to work
- 6MB to be added for Acrobat Reader to work)
- At least 2MB of free hard disk space for ELP Link III V2.0 installation (8MB to be added for Acrobat Reader and 3MB for User's Guide installation, 8MB for the ELP Link III V2.0 demonstration).
- Double-speed CD-ROM drive (Quad-speed or faster recommended)
- Color monitor, 640 x 480 screen resolution (832 x 624 or higher recommended), and 256 colors (32,000 colors or more recommended)

Projector Software CD-ROM

The following software is enclosed.

ELP Link III V2.0 utility

Offers a lot of advantages to your presentation in using a cursor, bar, or stamps with the remote control shipped with your projector. And you can control the brightness and size of the screen, and the sound from your computer.

ELP Link III V2.0 User's Guide

Provides you with detailed information and instructions to use ELP Link III V2.0. The User's Guide is provided in a PDF (Portable Document Format) file. To read this manual, Adobe Acrobat Reader must be installed.

- ◆ **Note:** *A Portuguese User's Guide is not provided.*

Adobe Acrobat Reader

Acrobat Reader is the program provided by Adobe Systems Incorporated that you need to read PDF files. To install Acrobat Reader, always see the license agreement and follow the instructions. For more information about Acrobat Reader, see Online Help or Adobe's home page. (<http://www.adobe.com>)

- ◆ **Note:** *There is no Portuguese version of Adobe Acrobat Reader.*

ELP Link III V2.0 Demonstration

Shows examples using the ELP Link III V2.0 utility. This program is not installed on the hard drive. To view this demonstration, insert the CD-ROM in the CD-ROM drive. Then click the View Demonstration button in the Install Program main window. See page 71.

Connecting the Cables

When you are using the following EPSON projector, follow the instructions below. If not, please see the User's Guide packed with your projector.

- ◆ **Caution:** Before connecting the cables to your computer, make sure that the computer and projector are turned off and unplugged from any power source; otherwise damage may occur.

Connecting to your PC

Using the PS/2 mouse

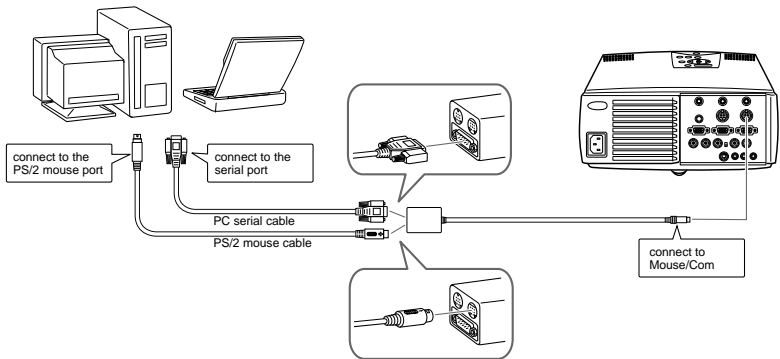

Using the serial mouse

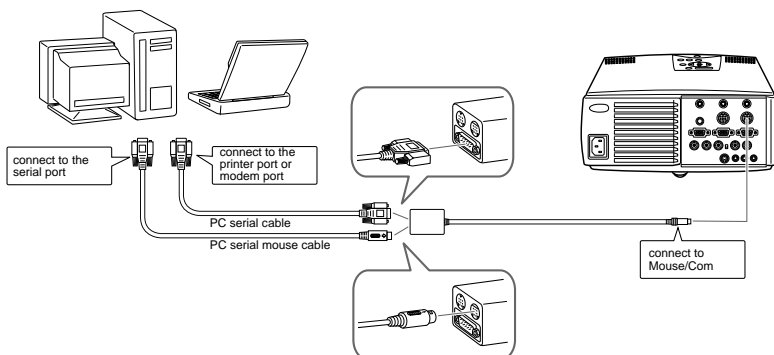

Connecting to your Macintosh

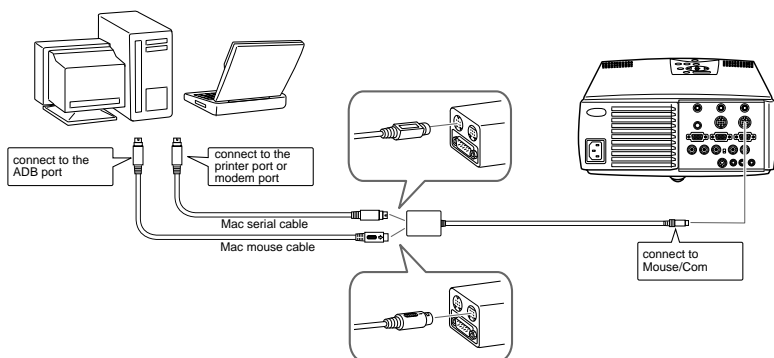

Installing the Projector Software on Your PC

After connecting the projector to your PC, install the Windows-based projector software as described below.

1. Turn on the computer and start Windows.
2. Insert the EPSON Projector Software CD-ROM into the CD-ROM drive. The following dialog box appears.

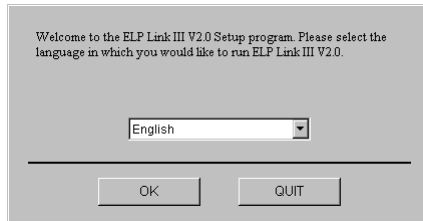

- ◆ **Note:** *If the dialog box does not appear, follow the steps below.*

For Windows 95 or NT 4.0 users:

Double-click the My Computer icon, then double-click the CD-ROM drive icon. Double-click Setup.exe.

For Windows 3.1 or NT 3.51 users:

Open the File Manager, then double-click CD-ROM drive. Double-click Setup.exe.

3. Select language from the list box. Then click OK.

4. When you see the following dialog box, click the Install ELP Link III V2.0 button.

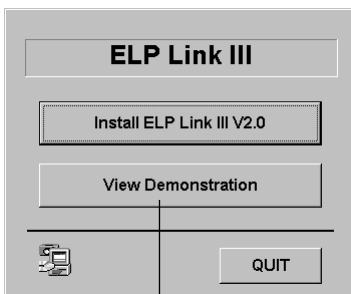

To view the ELP Link III V2.0 demonstration, click the View Demonstration button.

5. When you see the following dialog box, select items you wish to install. Then click Install.

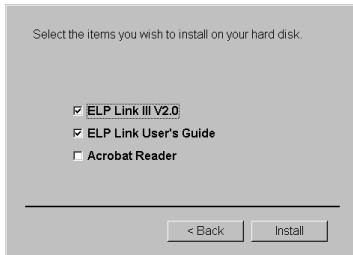

6. The setup program starts the installation procedure for each software component. Follow the on-screen instructions.

Installing ELP Link III V2.0 on your PC

For Macintosh users:

ELP Link III V2.0 installs directly from the setup program main window; there is no separate installation program.

The ELP Link III V2.0 installation program starts with the following dialog box. Follow the steps below.

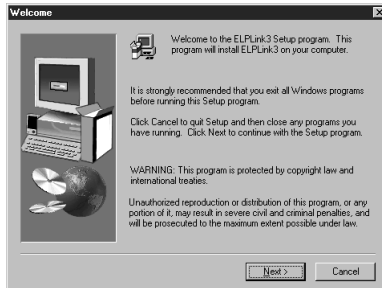

◆ **Note:** *The dialog boxes used here are for Windows 95. Dialog boxes may differ depending on your platform.*

1. Click Next. Then read the license agreement. If you agree with it, click Yes.

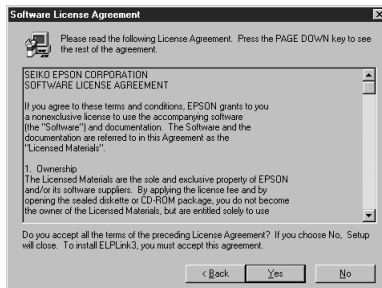

2. A dialog box appears. Read the information, then click Next.



3. Choose a Destination Folder. Your software will be installed into this folder. Click Next.



4. Follow the on-screen instructions. When the installation is complete, click Finish.

Installing the Projector Software on Your Macintosh

After connecting the projector to your Macintosh, install the Macintosh-based projector software as described below.

1. Turn on your Macintosh, then insert the EPSON Projector Software CD-ROM in the CD-ROM drive.
2. Double-click the Installer icon. The following dialog box appears.

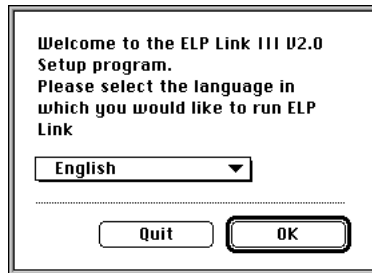

3. Select language from the pop-up menu. Then click OK.
4. When you see the following dialog box, click the Install ELP Link III V2.0 button.

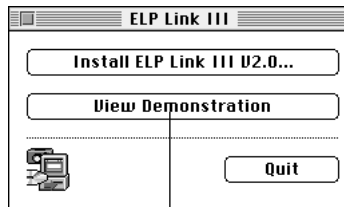

To view the ELP Link III V2.0 demonstration, click the View Demonstration button.

5. Read the license agreement. If you agree with it, click Accept.

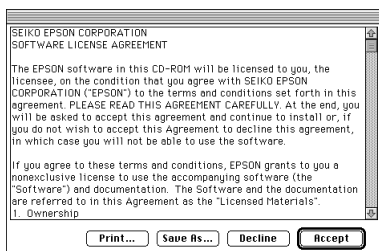

6. The following dialog box appears. If you want to install all of the software components contained on your projector software CD-ROM, make sure the disk where you want to install the software is displayed in the Install Location box, then click Install.

◆ **Note:** *If you are low on disk space, select Custom Install from the pop-up menu and select the software you want to install.*

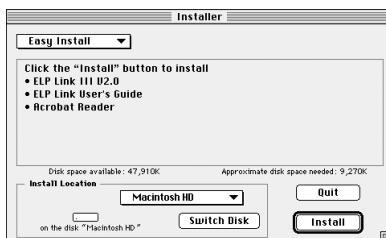

7. The setup program starts the installation procedure for each software component. Follow the on-screen instructions.

Accessing the Projector Software

To access the EPSON projector software, follow the steps below.

For Windows 95 and NT 4.0 users

ELP Link III V2.0

Click Start, point to Programs, and ELPLink3, then select ELPLink3.

User's Guide

Click Start, point to Programs, and ELPLink3, then select User's Guide.

- ◆ **Note:** *Make sure that Acrobat Reader is installed on your PC before accessing the User's Guide.*

Demonstration

Insert the CD-ROM into the CD-ROM drive and click the View Demonstration button in the Install Program main window.

For Windows 3.1 and NT 3.51 users

ELP Link III V2.0

Open the Program Manager and double-click the ELPLink3 group. Then double-click the ELP Link III V2.0 icon.



User's Guide

Open the Program Manager and double-click the ELPLink3 group. Then double-click the User's Guide icon.

- ◆ **Note:** *Make sure that Acrobat Reader is installed on your PC before accessing the User's Guide.*

Demonstration

Insert the CD-ROM into the CD-ROM drive and click the View Demonstration button in the Install Program main window.

For Macintosh users

ELP Link III V2.0

Open the ELPLink3 folder, then double-click the ELP Link 3 icon.

User's Guide

Open the ELPLink3 folder, then double-click the User's Guide icon.

- ◆ **Note:** *Make sure that Acrobat Reader is installed on your Macintosh before accessing the User's Guide.*

Demonstration

Insert the CD-ROM into the CD-ROM drive and click the View Demonstration button in the Install Program main window.

Installing or Accessing the Projector Software on the CD-ROM Directly

When you install or access the software on the CD-ROM directly, follow the instructions below.

For Windows users

ELP Link III V2.0

Open the DATA folder, then the ENGLISH folder. Open the ELPLink3 folder, then your OS folder. Double-click SETUP.EXE.

Acrobat Reader

Open the DATA folder, then the ENGLISH folder and AR folder. Then open the WIN31 folder and double-click AR16E301.EXE (for Windows 3.1), or WIN95 folder and double-click AR32E301.EXE (for Windows 95), or WINNT folder and double-click AR32E301.EXE (for Windows NT).

User's Guide (PDF)

Open the DATA folder, then the ENGLISH folder. Then open the PDF_File folder and double-click SETUP.EXE.

Demonstration

Open the DATA folder, then the DEMO folder. Then open the WIN16 folder, and double-click D_ELP31.EXE for Windows 3.1 or NT3.51. Or open the WIN32, and double-click D_ELP95.EXE for Windows 95 or NT 4.0.

For Macintosh users

ELP Link III V2.0

Open the DATA folder, then the English folder. Copy the ELPLink3 folder to your hard disk.

Acrobat Reader

Open the DATA folder, then the English folder. Open the PDF_FILE folder, then the AR folder. Double-click the Reader 3.01 Installer icon.

User's Guide (PDF)

Open the DATA folder, then the English folder. Open the PDF_FILE folder, then copy the User's Guide file to your hard disk.

Demonstration

Open the DATA folder, then the DEMO folder. Double-click the D_ELP icon.



5

Maintenance

The projector needs little maintenance. You should keep the lens clean because any dirt or stains will appear on the screen. You will also need to clean the air filter located at the bottom of the projector periodically. It is important to keep the air filter clean because a clogged air filter prevents proper ventilation which is necessary to cool the projector and prevent it from overheating.

The only parts you should replace yourself are the lamp and the air filter. If any other parts need replacing, contact your EMP-7300/7200/5300 dealer or qualified service personnel.

When cleaning any part of the projector, always switch off and unplug the projector first.

- ◆ **Warning:** *Never open any of the covers on the projector except the lamp and filter covers. Dangerous electrical voltages inside the projector can cause severe injury. Except as specifically indicated in this Owner's Manual, do not attempt to service this product yourself. Refer all servicing to qualified service personnel.*

Cleaning the Lens

Clean the lens whenever you notice dirt or dust on the surface. Wipe the lens surface gently with a soft, dry, lint-free cloth.

To remove dirt or stains on the lens, moisten a soft cloth with water and a neutral detergent and gently wipe the lens surface.

Cleaning the Projector Case

To clean the projector case, first unplug the power cable. To remove dirt or dust, wipe the casing with a soft, dry, lint-free cloth. To remove stubborn dirt or stains, moisten a soft cloth with water and a neutral detergent. Then wipe the casing.

Do not use alcohol, benzene, thinners or other chemical detergents as these can cause the casing to warp.

Cleaning the Air Filter

The air filter, which is located at the bottom of the projector, should be cleaned after every 100 hours of use. If it is not cleaned periodically, it can become clogged with dust and prevent the projector from being ventilated properly. This can cause overheating and damage the projector.

To clean the air filter:

1. Switch the projector off and unplug the power cable from the wall socket.
2. Stand the projector with the handle at the top so that the filter is easily accessible.

◆ **Caution:** *Stand the projector with the handle at the top to prevent dust from entering the projector.*

3. Lift the stopper of the filter cover with your fingers.

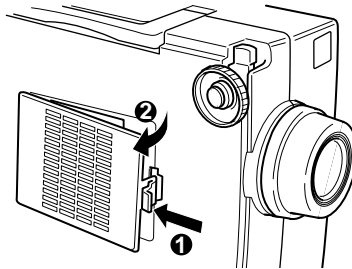

-
4. The air filter is attached to the inside of the projector. To clean the filter you are advised to use a small vacuum cleaner designed for computers and other office equipment. If you do not have one, use a dry, lint-free cloth.

If the dirt is difficult to remove or if the filter is torn, replace it.

An air filter come with replacement lamps.

Contact your EMP-7300/7200/5300 dealer or call an EPSON Service Centre.

Be sure to request part number. (ELPLP05)

5. Replace the filter cover.
6. Plug the power cable back into the wall socket.

Replacing the Lamp

The projector lamp typically lasts for about 2000 hours of use. It is time to replace the lamp when:

- The projected image gets darker or starts to deteriorate.
- The projection lamp indicator (orange and red, flashing alternately) is red.
- The message “LAMP REPLACE” appears on the screen when the projector lamp comes on.

Contact your local EPSON dealer for a replacement lamp. Use only replacement lamp part number. (ELPLP05)

◆ **Warning:** *Let the lamp cool before replacing it.*

1. Turn off the projector and unplug the power cable.
2. Turn the projector over so you can access the lamp cover.

3. Use a screwdriver, coin, or similar object to loosen the two retaining screws on the lamp cover. When the screws are loose, lift off the lamp cover. (You cannot remove these screws.)

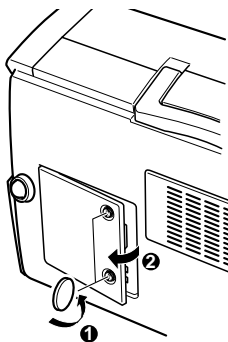

4. Use a screwdriver, coin, or similar object to loosen the two screws holding the lamp in position. (You cannot remove these screws.)
5. Lift up the handle and pull out the lamp.

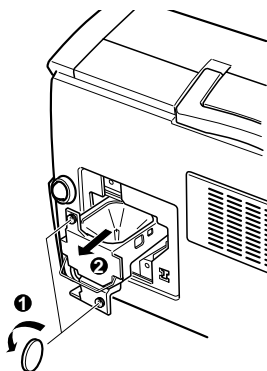

-
6. Gently insert the new lamp by lowering it into position. Make sure it is inserted securely.
 7. Tighten the screws you loosened in step 4.
 8. Replace the lamp cover and tighten the cover screws. (Make sure the lamp cover is securely fastened. The projector turns itself off if the lamp cover is open.)



6



Troubleshooting

This chapter describes the problems indicated by the status lights and provides information on what to do if you experience problems with the projector. It is divided into the following sections:

- General problems with the projector. Refer to this section if the projector is not working and to find out what the warning lights are indicating.
- Problems with the screen image. Refer to this section if you cannot project an image or if the quality of the screen image is poor.

If you have a problem, refer to the appropriate section and follow all the suggestions which apply to your problem. If none of the suggested solutions solves the problem, call your EMP-7300/7200/5300 dealer or call the EPSON Service Centre.

Problems with the Projector

If you have problems with the projector, first turn it off and unplug it. Then plug the power cord back in and turn on the projector. If this does not solve the problem, check the warning lights at the top of the projector. These lights alert you to problems with projector operation.

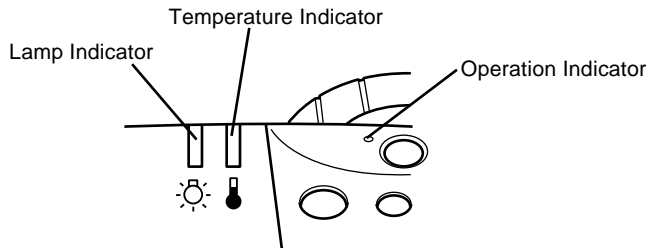

See the following pages for information on what to do when you see these warning lights or encounter other specific problems with the projector.

- The operation indicator is flashing orange and you cannot turn on the projector.**

The lamp is cooling down. Wait until the light turns off and then turn on the projector.

- The operation indicator does not come on.**

Turn off the projector, check that the power cable is connected securely both at the power outlet and the projector, and press the Power button again.

- Projected images get darker or start to deteriorate, or the lamp indicator is red.**

Replace the projector lamp as described on page 78.

□ **The temperature indicator is red.**

The projector is overheating, which turns the lamp off automatically. Let the projector cool for a few minutes, then turn it back on. Make sure nothing is blocking the ventilation vents.

The air filter may be clogged. Clean it as described in Chapter 5 and then let the projector cool for a while.

If the projector continues to overheat after you clean the air filter, the problem may be caused by damage to the cooling fan or internal circuits. Contact a qualified service person.

- ◆ **Warning:** *Except as specifically explained in this User's Guide, do not attempt to service this product yourself.*

Problems with the Image or Sound

❑ **An image does not appear on the screen.**

Check that the power light is on and the lens cover is off. Also make sure the cables are installed correctly, as described in Chapter 1.

The correct image source may not be selected. Press the Source button on the remote control or the control panel to choose another image source.

❑ **Only part of the computer image is displayed.**

If the computer's output resolution setting is higher than 1024 x 768, the projector resizes the image. If the computer output is not compatible with this resizing, choose a different display setting on the computer. In Windows 3.x, use Windows Setup in the Main program group. For a Macintosh, choose Control Panels under the Apple menu and then choose Monitors. In the Monitors screen, choose Options and make sure Macintosh Hi-Res Display or another 1024 x 768 display is selected. For supported display settings, see page "Supported Monitor Displays" on page 89, 90.

You also may need to modify existing presentation files if you created them for a different resolution. See your software manual for specific information.

❑ **The message NO SIGNAL is displayed.**

An image source not connected to the projector is selected, the signal is not being output from the computer, or the signal is not reaching the projector. Make sure the connectors are securely attached to both the projector and the image source. Then check that the image source is selected correctly. When NO SIGNAL is displayed, you cannot access the source (computer/video) menu.

❑ A blank screen is displayed.

The computer signal cannot be interpreted by the projector. Verify the display format (see page 89, 90). When you see a blank screen, you cannot access the projector menus.

❑ The image or parts of the image are blurred or not in focus.

Adjust the Brightness and Contrast settings on the Video main menu. If you're viewing a computer image, also try adjusting the Comp Tracking and Comp Sync buttons on the projector's control panel.

There may be dirt or smears on the lens. Clean the lens as described in Chapter 5, "Maintenance."

❑ The colors of the image are not right.

The color balance may be incorrect. If you're displaying a computer image, adjust the red, green, and blue settings in the Video menu. If you're displaying video, adjust the color and tint (NTSC only) settings on the Video menu.

❑ There is no sound.

First check that the volume setting is not turned all the way down and that the audio/visual cable is securely attached to both the projector and the audio source.

The wrong source is selected. Press either the Computer or Video button on the remote control or control panel to select the proper source.



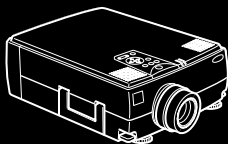

7

Technical Specifications

General

Type of display	Poly-silicon TFT
Size of liquid crystal panels	1.3 inches (33.1 mm)
Resolution	EMP-7300/7200:1024 (horizontal) x 768 (vertical) pixels EMP-5300: 800 (horizontal) x 600 (vertical) pixels
Image size	23 - 300 inches (0.6 - 7 meters)
Projection distance	5.03 - 54.08 feet (1.59 - 16.7 meters)
Remote control range	32.8 feet (10 meters)
Internal speaker system	3W x 2 stereo
Optical aspect ratio	4 : 3 (horizontal : vertical)
Zoom ratio	1:1.3

Projector Lamp

Type	UHE Lamp (Ultra High Efficiency Lamp)
Power	120 W
Part number	ELPLP05

Mechanical

Height	5.1 inches (129 mm) Maximum dimension
--------	--

Mechanical

Width	11.8 inches (300 mm) Maximum dimension
Depth	15.8 inches (400 mm) Maximum dimension
Weight	13.8 lb (6.2 kg)

Electrical

Voltage	100 - 120 VAC and 200 - 240 VAC \pm 10%
Rated frequency	50/60 Hz
Power supply	100 - 120 VAC, 2.4 A, 50/60 Hz 200 - 240 VAC, 1.2 A, 50/60 Hz

Environmental

Temperature	Operation: 41 - 104° F (5 - 40° C), non-condensing Storage: 14 - 140° F (-10 - 60° C), non-condensing
Humidity	Operation: 20 - 80% RH, non-condensing Storage: 10 - 90% RH, non-condensing

Supported Monitor Displays

The projector displays images at a resolution of 1024×768 pixels. To display a higher resolution image, the projector compresses it to 1024×768 . The following table lists the display formats supported by the projector:

	Format	Hor Pix [Pixels]	Ver Pix [Lines]	H. Freq [KHz]	V. Freq [Hz]
PC98	PC98	640	400	24.8	56.42
PC/AT	VGA60	640	480	31.5	59.94
DOS/V	VESA72	↑	480	37.9	72.81
	VESA75	↑	↑	37.5	75.00
	VESA85	↑	↑	43.3	85.01
	VGAEGA	↑	350	31.5	70.00
	SVGA56	800	600	35.2	56.25
	SVGA60	↑	↑	37.9	60.32
	SVGA72	↑	↑	48.1	72.19
	SVGA75	↑	↑	46.9	75.00
	SVGA85	↑	↑	53.7	85.06
	XGA43i	1,024	768	35.5	43.48
	XGA60	↑	↑	48.4	60.00
	XGA70	↑	↑	56.5	70.07
	XGA75	↑	↑	60.0	75.03
	XGA85	↑	↑	68.7	85.00
	SXGA70	1,152	864	63.9	70.01
	SXGA75	↑	↑	67.5	75.00
SXGA85	↑	↑	77.1	85.00	
SXGA60	1,280	960	60.0	60.00	
SXGA75	↑	↑	75.0	75.00	
SXGA85	↑	↑	85.9	85.00	
SXGA43i	1,280	1,024	46.4	43.44	
SXGA60	↑	↑	64.0	60.02	
SXGA75	↑	↑	80.0	75.03	
Mac	MAC13"	640	480	35.0	66.67
	MAC16"	832	624	49.7	74.60
	MAC19"	1,024	768	60.2	74.93

Format	Hor Pix [Pixels]	Ver Pix [Lines]	H. Freq [KHz]	V. Freq [Hz]
MAC1960"	↑	↑	48.2	59.28
MAC21"	1,152	870	68.7	75.06

	Format	Hor Pix [Pixels]	Ver Pix [Lines]	Subcarrier frequency
Video	NTSC	640	480	3.58 MHz
	NTSC 4.43	↑	↑	4.43 MHz
	PAL	768	576	↑
	PAL N	↑	↑	3.58 MHz
	PAL M	640	480	↑
	PAL 60Hz	↑	↑	4.43 MHz
	SECAM	768	576	↑

* The projector uses a patent-pending technology to resize the image to 1024 × 768.

- ◆ **Note:** *The frequencies of some computers may not allow the image to be displayed correctly.*
- ◆ **Note:** *This projector is compatible with DDC-capable graphic sub-systems and boards only.*

Monitor and Computer In 1/2 connector pin assignments

The Monitor and Computer In 1/2 connectors are female video RGB, 15-pin micro-D-style connectors. The pin assignments are:

Input pin	Signal
1	Red analogue input
2	Green analogue input
3	Blue analogue input
4	GND
5	GND
6	Red GND
7	Green GND
8	Blue GND
9	Reserved
10	Sync GND
11	GND
12	SDA
13	Horizontal sync/composite sync input
14	Vertical sync input
15	SCL



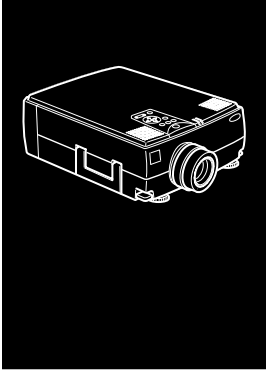

Glossary

Brightness. The balance of light and dark shades in an image.

Composite video. A type of video signal that encodes colours, luminance and synchronization information so it can be carried in one signal.

Contrast. A measure of the luminance differences between the highlights and shadows of an image. In a high-contrast image, light areas are very bright and dark areas are very dark.

NTSC. A 525-line video broadcast format developed by the National Television Standards Committee. NTSC is widely used in North America, Mexico and Japan.

PAL (Phase Alternation by Line). A 625-line video broadcast format used in Western Europe, India, China, Australia, New Zealand and parts of Africa.

Resolution. A measure of the amount of detail contained in an image. Resolution can be measured in dots per inch or in pixels. Image sharpness and clarity improve as resolution increases.

RGB. Red Green Blue

S-Video. A type of video signal which transmits luminance and colour separately.

SECAM (Système Electronique pour Couleur Avec Mémoire). A 625-line TV system used in France, Eastern Europe, Russia and parts of Africa.

Serial. A type of communication interface that transmits data over a single wire.

Sleep mode. The power cable is connected but the projector is switched off. In this mode the power LED lights up orange. If the projector is not used for 30 minutes the lamp switches itself off and after 30 seconds the projector goes into sleep mode.



Index

Numerics

3D Sound 51

A

About Menu 57
Adobe Acrobat Reader 62
Air Filter 77
anti-theft device 3
Audio cable 2
Audio Menu 51
Auto 49
AVTSS vii

B

Bass 51
BIS CUIT viii
Blank 52
BNC 53
Brightness 48, 93

C

Ceiling 52
COLOR TEMP 52

Composite video 93
Computer cable 2
COMPUTER2 / 5BNC 57
Contrast 48, 93
Control Panel ix
cooling 82
Custom Menu 54

E

ELP Link III V2.0 Demonstration 62
ELP Link III V2.0 User's Guide 62
ELP Link III V2.0 utility 59, 62
external speaker 1

F

Format 89, 90

G

Glossary 93

H

H/V Freq. 57

I

Image 84
Installing ELP Link III V2.0 67
Installing the Projector Software 65



L

LAMP 57
Language 53

M

MAC Desktop adapter 2
MAC Monitor adapter 2
MAC mouse cable 2
MAC serial cable 2
Main cable 2
Mouse /COM 53

N

NTSC viii, 93

O

Optional Accessories x
Options Menu 52

P

PA system 1
PAL viii, 93
PC serial cable 2
pin assignments 91
Power cord 2
Preview 55
Projector ix
Projector Software CD-ROM 60
Prompt 52
PS/2 mouse cable 2

R

REAR PROJ 52
Remote control ix
replacement lamp 78
Reset 49
RESET ALL Menu 57
Resolution 93
resolution 84
RGB 93

S

Saturation 50
SECAM viii, 93
Serial 94
Serial mouse cable 2
Sleep mode ix, 94
Sound 84
SRS 3D sound vii
Strobe 55
S-Video viii, 93
SXGA viii

T

Technical Specifications 87
Tint 50
Treble 51
Troubleshooting 81
true SVGA vii

V

VGA viii
video source vii
Video/ audio cable 2

View Change 53
Volume 51

W

wireless mouse 1
World Wide Web xv

Z

Zoom 54
Zoom In 54
Zoom Out 55
Zoom Screen Shift 55

After sales service contact addresses

EPSON (UK) LIMITED
(01442) 61144
Campus 100
Maylands Avenue
Hemel Hempstead
Herts. HP2 7TJ
United Kingdom

EPSON HONG KONG LIMITED
(852) 2585 4300
Rooms 4706-10 47 th Floor
China Resources Building
26 Harbour Road Wanchai
Hong Kong

EPSON FRANCE S.A.
16 (1) 47.37.47.47
68 Bis Rue Marjolin
92305 Levallois Perret
France

EPSON ELECTRONICS TRADING
LTD. (TAIWAN BRANCH)
(02) 7177360
10F, No. 287 Nanking E.Road, Sec.3,
Taipei, Taiwan R.O.C.

EPSON DEUTSCHLAND GMBH
0211/56030
Zülpicher Straße 6,
40549 Düsseldorf
F.R. Germany

EPSON SINGAPORE PTE LTD
337-7911
No.1, Temasek Avenue
#36-00, Millenia Tower
Singapore 039192
Singapore

EPSON ITALIA S.P.A
0039-2-26233-1
V.le Casiraghi 427
20099 Sesto S. Giovanni (MI)
Italy

EPSON AUSTRALIA PTY
LIMITED
(02) 415 9000
70 Gibbes Street
Chatswood NSW 2067
Australia

EPSON IBERICA, S.A.
(93) 5821500
Av. Roma, 18-26
08290 Cerdanyola del Vallès
(Barcelona)
Spain