

myprojectorlamps.com

**The most trusted, dependable name
in projector lamp sales.**



<http://www.myprojectorlamps.com>



<http://www.myprojectorlamps.ca>



<http://www.myprojectorlamps.eu>

The following projector manual has not been modified or altered in any way.

EPSON®

Multipurpose
Entertainment Projector

User's Guide

EMP-30



About the Manuals and Notations Used

Types of Manual

The documentation for your EPSON projector is divided into the following four manuals. Refer to the manuals in the order given below.

① Unpacking and Installation Guide

This manual contains information on the procedures from unpacking the projector through to starting to use the projector, and also describes the included accessories.

② Safety Instructions/World-Wide Warranty Terms

This manual contains information on using the projector safely, and also includes safety instructions, world-wide warranty terms and a troubleshooting check sheet.

Be sure to read this manual thoroughly before using the projector.

③ Setup Guide





This manual describes the preparations required in order to start using the projector (such as remote control preparation and connecting video equipment or a computer).

④ User's Guide (this manual)

This *User's Guide* contains information on basic operation, using the configuration menus, troubleshooting and maintenance.

Notations Used in This User's Guide

General information

	Indicates procedures where personal injury or damage to the projector may occur if the procedures are not followed correctly.
	Indicates additional information and points which may be useful to know regarding a topic.
	Indicates that an explanation of the underlined word or words in front of this symbol appears in the glossary of terms. Refer to the "Glossary" in the "Appendices". (p.59)
	Indicates operating methods and the order of operations. The procedure indicated should be carried out in the order of the numbers.

Meaning of "unit" and "projector"

When "unit" or "projector" appears in the text of this *User's Guide*, it may refer to items which are accessories or optional equipment in addition to the main projector unit itself.

Contents

Features of the Projector	2
Basic Operations	
Turning On the Projector.....	6
Connecting the Power Cable.....	6
Turning On the Power and Projecting Images	7
Turning Off the Projector.....	9
Adjusting the Screen Image.....	11
Adjusting the Image Size.....	11
Focusing the Screen Image	11
Adjusting the Image Angle	12
Correcting Keystone Distortion	13
Adjusting the Image Quality.....	14
Using the EPSON Cinema Filter	14
Selecting the Colour Mode	15
Wide-screen Projection of Component Video and Video Images (Changing the Aspect Ratio)	15
Adjusting Computer Images	16
Settings and Useful Functions	
Using the Configuration Menu Functions.....	20
"Video" Menu	20
"Audio" Menu	23
"Setting" Menu.....	23
"Advanced" Menu.....	24
"About" Menu	25
"Reset All" Menu	26
Using the Configuration Menus.....	27
Useful Functions When a Computer is Connected.....	29
A/V Mute	29
Freeze.....	29
E-Zoom	30
Troubleshooting	
Using the Help	32
When Having Some Trouble	33
⚠ (Warning) Indicator.....	33
Power Indicator	34
When the Indicators Provide No Help.....	35
Appendices	
Maintenance	44
Cleaning	44
Replacing Consumables.....	45
Optional Accessories.....	50
List of Supported Monitor Displays	51
Component Video Input/RGB Video Input.....	51
Composite Video/S-Video Input	51
Computer	51
Specifications.....	52
Appearance	54
Part Names and Functions	55
Front/Top.....	55
Control Panel	56
Left Side.....	56
Rear	57
Base.....	57
Remote Control.....	58
Glossary	59
Index	61

Basic Operations →

Settings and Useful Functions →

Troubleshooting →

Appendices →

Features of the Projector

EPSON cinema filter function

You can boost the quality of films by attaching the EPSON cinema filter that is supplied with the projector and then changing the "EPSON Cinema Filter" setting in the "Video" menu to "ON". This automatically causes video images such as films to be projected at the optimum tint.

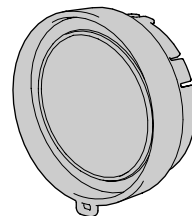

Colour mode function

The optimum images can be projected simply by selecting the image quality from the following six preset settings according to the projection environment being used. No other troublesome colour adjustments are necessary. (p.15)

- sRGB ▶▶
- Normal
- Meeting
- Presentation
- Theatre
- Game

Brilliant, attractive images

Despite its compact size, the projector can display images at high resolutions with a high degree of luminance, providing beautifully clear images even in bright environments.

Keystone correction function

Keystone distortion in projected images can be corrected easily. This makes images appear correctly even when the projector has been set up on a tilted vertical angle. (p.13)

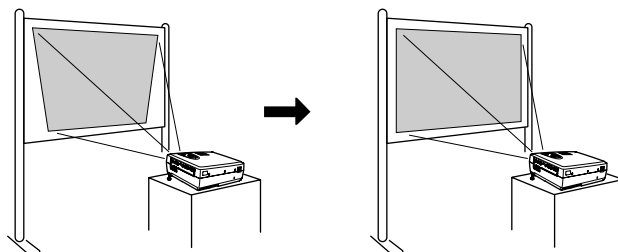

Automatic setup function

When projecting computer images, the signals from the connected computer are detected automatically and adjusted so that the optimum images are projected. Even if several people are giving presentations using the same projector, the optimum picture quality can be obtained simply by disconnecting and reconnecting the computers. Each individual setting can also be adjusted manually. (p.16)

Easy to operate

The accessory remote control can be used for operations such as pausing projection (see "Freeze" on p.29) and zooming in on important areas of an image (see "E-Zoom" on p.30).

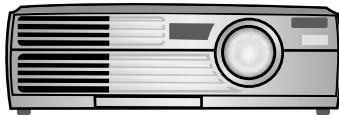
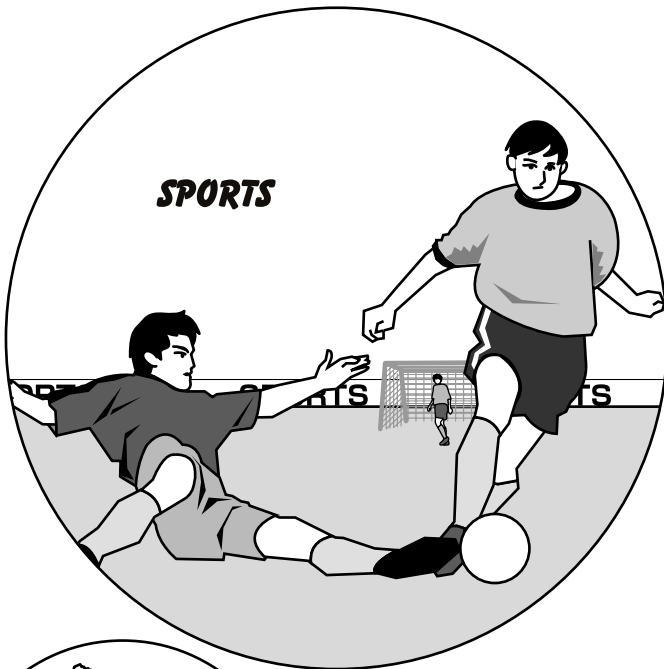

Basic Operations

This chapter describes basic operations such as turning projection on and off and adjusting the projected images.

Turning On the Projector	6
• Connecting the Power Cable	6
• Turning On the Power and Projecting Images.....	7
Turning Off the Projector	9
Adjusting the Screen Image.....	11
• Adjusting the Image Size	11
• Focusing the Screen Image	11
• Adjusting the Image Angle	12
• Correcting Keystone Distortion	13
Adjusting the Image Quality.....	14
• Using the EPSON Cinema Filter.....	14
• Selecting the Colour Mode.....	15
• Wide-screen Projection of Component Video and Video Images (Changing the Aspect Ratio).....	15
• Adjusting Computer Images	16
• Automatic Setup	16
• Adjusting the Tracking	17
• Adjusting the Sync.....	18

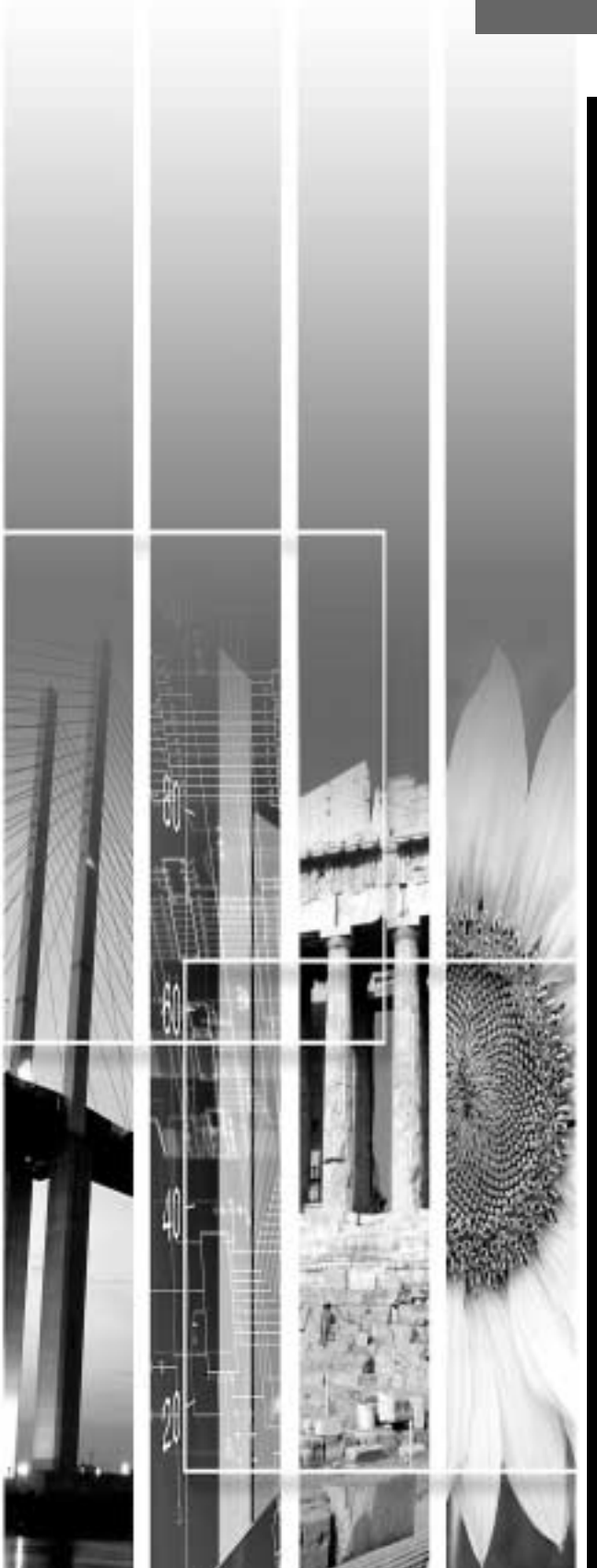

Turning On the Projector

This section describes the procedure from turning on the power to projecting images.



Be sure to read the separate *Safety Instructions/World-Wide Warranty Terms* before projecting images.

Connecting the Power Cable

Procedure

1

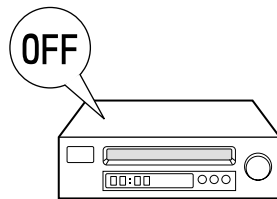

Check that the power is turned off for the projector and all components connected to the projector.

2

Connect the video source or computer to the projector. (*Setup Guide*)

3

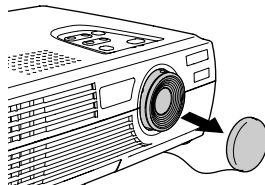

Remove the lens cover.

4

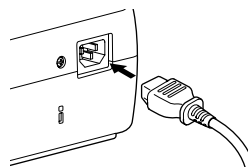

Connect the accessory power cable to the projector.

Check that the power cable connector is facing the same way as the power inlet on the projector, and then insert the power cable connector securely into the projector.

5

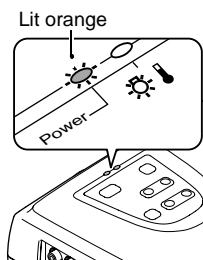

Connect the other end of the power cable to an earthed electrical outlet.

Wait until the Power indicator lights orange.



The projector's control panel and remote control buttons cannot be operated while the Power indicator is flashing orange.

Turning On the Power and Projecting Images

Procedure

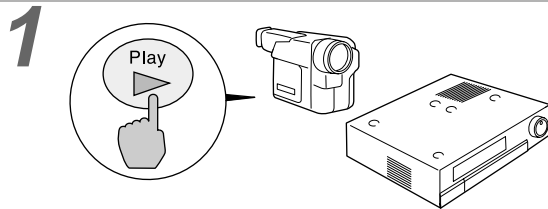

1 Turn on the power for all equipment connected to the projector.

For a video source, press the [Play] button at the video source to start playback if necessary. Check that the Power indicator has stopped flashing and is lit orange.

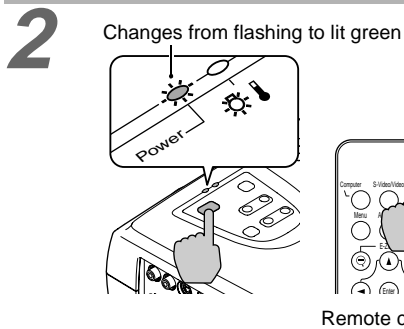

2 Press the [Power] button on either the projector's control panel or the remote control to turn on the power for the projector.

The Power indicator flashes green, and after a short period it stops flashing and projection starts. Wait until the Power indicator lights green (it normally takes about 40 seconds to change).

 The projector's control panel and remote control buttons cannot be operated while the Power indicator is flashing green. Depending on the settings, the message "No-Signal." may appear. See "Setting" - "No-Signal Msg." (p.23)

3 If more than one signal source has been connected, use the projector's control panel or the remote control buttons to select the port which the signal source that you would like to use is connected to, while referring to the following table.

Port	Button to press		Display at top-right of screen
	Projector	Remote control	
Computer/ Component Video	The image source changes each time [Source] is pressed.	[Computer]	Computer * YCbCr▶▶ * YPbPr ▶▶ *
S-Video		[S-Video/Video]	S-Video
Video			Video

*The items selected using the "Input Signal" command in the "Video" menu will appear.



- If only one signal source has been connected, the signals from that source will be projected without needing to press one of the buttons from the previous table.
- If the "No-Signal." message does not disappear, check the connections again.
- If a laptop computer or a computer with an LCD screen has been connected to the projector, the images may not be projected straight away. After making the connections, check that the computer has been set up to output signals externally. The following table shows examples of how to toggle output settings. For details, refer to the section of the documentation provided with your computer under a heading such as "External output", "Connecting an external monitor" or similar.

NEC	Panasonic	Toshiba	IBM	Sony	Fujitsu	Macintosh
[Fn]+[F3]	[Fn]+[F3]	[Fn]+[F5]	[Fn]+[F7]	[Fn]+[F7]	[Fn]+[F10]	After startup, change the Control Panel adjustments so that Mirroring is active

- If the same still picture is projected for a long period of time, the projected image may become burned in on the computer screen. You should avoid leaving the same image displayed for long periods.

Turning Off the Projector

Follow the procedure below to turn off the power for the projector.

Procedure

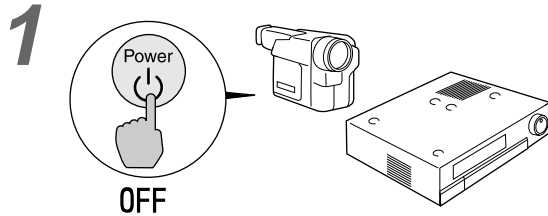

Turn off the power for the signal sources that are connected to the projector.

Check that the power for all connected components has been turned off.

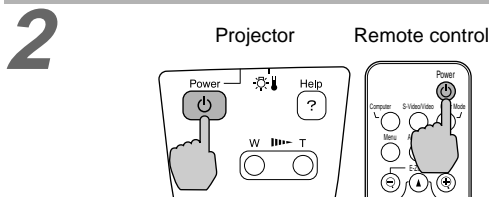

Press the [Power] button on either the projector's control panel or the remote control.

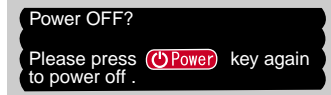

The confirmation message shown left will appear. If you do not want to turn off the power, press any button except the [Power] button. If you do not press any button, the message will disappear automatically after seven seconds. (The power will not turn off at this time.)

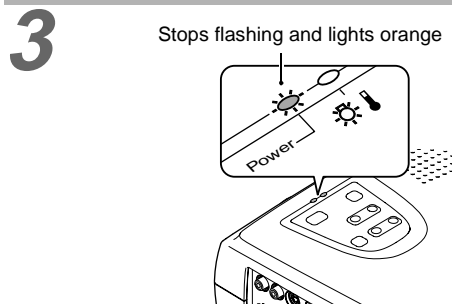

Press the [Power] button once more.

The lamp will switch off. The Power indicator will flash orange and **cool-down** will start. The cool-down period lasts for about 20 seconds. (This varies depending on factors such as the ambient air temperature.)

When cool-down is complete, the Power indicator lights orange.

 The projector's control panel and remote control buttons cannot be operated while the Power indicator is flashing orange. Wait until it lights steadily.

4

Unplug the power cable from the electrical outlet.



Do not disconnect the power cable from the outlet while the Power indicator is still flashing orange, otherwise it may result in errors in projector operation and reduce the lamp unit operating life.

5

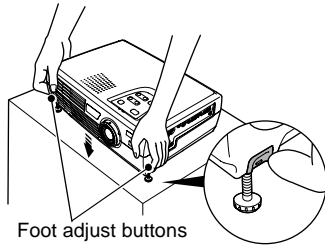

Retract the front adjustable feet if they are extended.

Gently push down on the projector while simultaneously pressing the two foot adjust buttons.

6

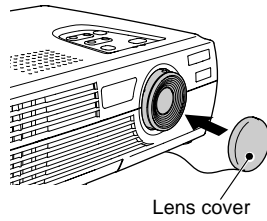

Attach the lens cover.

Attach the lens cover to the lens when not using the projector, in order to stop the lens from getting dusty or dirty.

Adjusting the Screen Image

You can correct and adjust the screen image in order to obtain the best possible picture.

Adjusting the Image Size

The size of the projected image is basically determined by the distance from the projector to the screen. (*Setup Guide*)

If further minor adjustment is required, press the [Zoom] button on the projector's control panel to make the adjustment. Minor adjustments can be made to the image size to between a zoom ratio of approximately 1.0 to 1.2 in 33 steps.



The E-Zoom function lets you enlarge parts of the image. (p.30)

Procedure

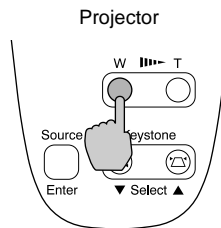
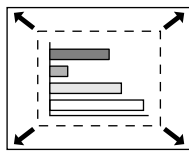

Press the [Zoom] button on the projector's control panel.

When pressed to the [W] side, the images become larger.

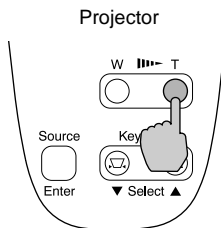
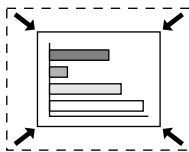

When pressed to the [T] side, the images become smaller.

Focusing the Screen Image

Procedure

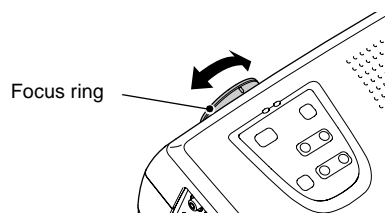

Turn the focus ring to adjust the image focus.



- If the surface of the lens is dirty or misted over as a result of condensation, it may not be possible to adjust the focus correctly. If this happens, clean or de-mist the lens. (p.36, 44)
- If the projector is positioned outside the normal projecting range of 0.9–11.3 m (2.9–37.0 ft.), it may not be possible to obtain the correct focus. If you have trouble obtaining the correct focus, check the projection distance.

Adjusting the Image Angle

The projector should be set up so that it is as perpendicular to the screen as possible.

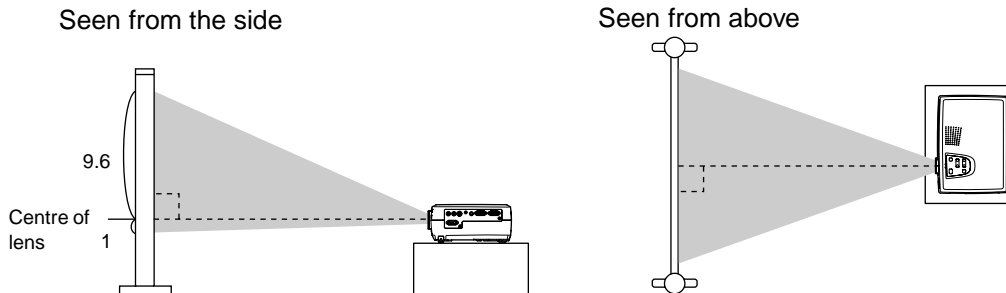

If it is not possible to set up the projector so that it is perpendicular to the screen, it can be set up at a slight vertical angle instead. You can extend or retract the front adjustable feet to adjust the projection angle within a maximum range of 10°.

Procedure

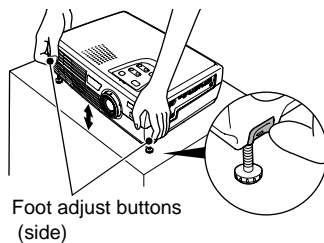

While pressing the two foot adjust buttons at either side, lift up the front of the projector so that the front adjustable feet can extend.

Extend the front adjustable feet until the desired angle is obtained, and then release the foot adjust buttons.

To retract the front adjustable feet, gently push down on the projector while pressing the two foot adjust buttons.



- When the foot is adjusted, it may cause the projected images to become distorted. Use the keystone correction function to adjust this distortion. (p.13)
- If the projector is tilted horizontally, turn the bases of the front adjustable feet to adjust the angle.

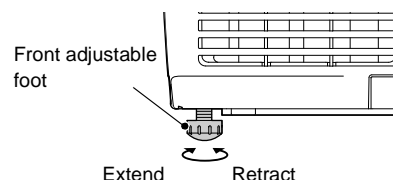

Front adjustable foot

Extend Retract

Correcting Keystone Distortion

When the projector is tilted, it will cause keystone distortion to appear in the image, but this distortion can be corrected using the keystone correction function as long as the vertical angle of tilt is within a range of approximately 15°.

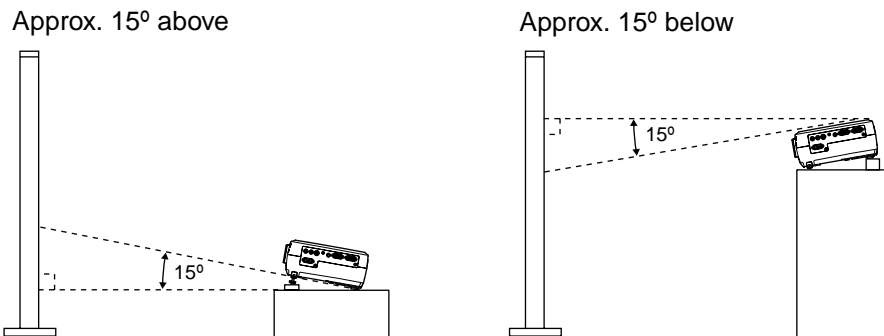

Procedure

Keystone correction can be carried out using either the projector's control panel or the configuration menu. The following explanation describes how to correct keystone distortion using the projector's control panel. For adjustment using the configuration menu: "Setting" - "Keystone" (p.23)

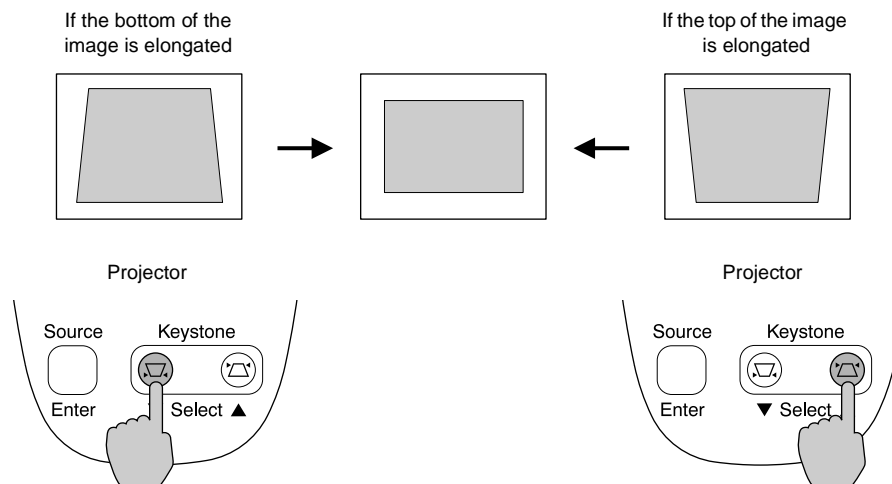

- When keystone correction is carried out, the projected image will become smaller.
- The keystone correction settings are memorised. If you change the position or angle of the projector, you may need to readjust the keystone correction settings.
- If the images become uneven in appearance after keystone correction is carried out, decrease the sharpness setting. (p.21, 22)
- If the value displayed in the gauge on the screen stops changing when keystone correction is being carried out, it indicates that the limit for keystone correction has been exceeded. Check that the projector has not been set up at an angle which exceeds the proper limit.

Adjusting the Image Quality

The quality of the screen images can be adjusted as follows.

Using the EPSON Cinema Filter

When the accessory EPSON cinema filter is attached to the projector and the "EPSON Cinema Filter" command is set to "ON", the images are adjusted to the optimum tint for movie theatre images.

If a computer is connected and the projector is being used for a presentation at such times, images will appear darker than normal, so remove the EPSON cinema filter and change the "EPSON Cinema Filter" setting to "OFF".

Procedure

1

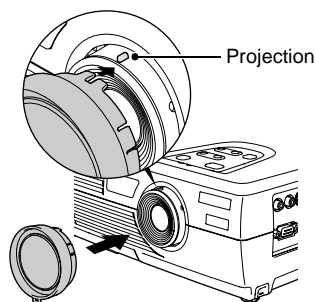

Attach the accessory EPSON cinema filter.

Align the projection on the focus ring with the notch in the EPSON cinema filter and attach the EPSON cinema filter.



- The EPSON cinema filter should always be installed so that the notch is aligned with the projection on the focus ring. If the EPSON cinema filter is not installed correctly, unevenness or lack of focus may occur in the projected images.
- Do not touch the glass surfaces of the EPSON cinema filter or the projector's lens when attaching the EPSON cinema filter. If fingerprints or smears get on the glass surfaces, it will reduce the clarity of projection.

2

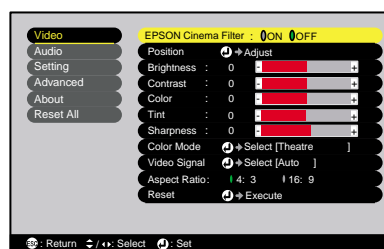

Press the [Menu] button on the remote control, and then select "EPSON Cinema Filter" from the "Video" menu.

For details on this operation, refer to "Using the Configuration Menus". (p.27)

3

Select "ON" and then press the [Enter] button.

4

After changing the setting, press the [Menu] button to exit the configuration menu.

Selecting the Colour Mode

The following six preset colour modes are available for use depending on the characteristics of the images that are being projected. You can easily obtain the optimum image quality simply by selecting the colour mode that corresponds to the projected images. The brightness of the images will vary depending on which colour mode is selected.

Mode	Application
<u>sRGB</u> ▶▶	Images conform to the sRGB colour standard. If the connected source has an sRGB mode, set both the projector and the connected signal source to sRGB.
Normal	Brightness is emphasised. For presentation in bright rooms.
Meeting	Images are modulated using their original tints, with no colour enhancement.
Presentation	For presentations in dark rooms.
Theatre	Movie images are optimised using natural tints.
Game	Brightness is emphasised. Ideal for playing video games in bright rooms.

Procedure

Remote control

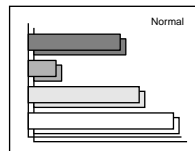
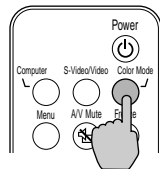

The colour mode changes as follows each time the [Color Mode] button on the remote control is pressed.

Normal → Meeting → Presentation → Theatre
→ Game → sRGB ...

The current setting appears in the top-right corner of the screen each time the colour mode is changed.

The default colour mode setting is "Normal" when computer image signals are being input, and "Theatre" when component video▶▶ or video signals are being input.



The colour mode can also be set using the "Color Mode" command in the "Video" menu. (p.21, 22)

Wide-screen Projection of Component Video and Video Images (Changing the Aspect Ratio)

This function changes the aspect ratio▶▶ of images from 4:3 to 16:9 when component video images (YCbCr and YPbPr) or video images (S-Video or composite video) are being projected. Images which have been recorded in digital video or onto DVDs can be viewed in 16:9 wide-screen format.

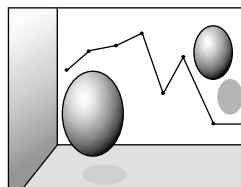

When images in squeeze mode are projected at 4:3

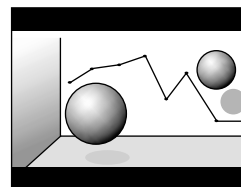

When images in squeeze mode are projected at 16:9

Procedure

1

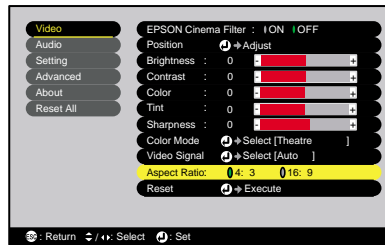

Press the [Menu] button on the remote control, and then select "Aspect Ratio" from the "Video" menu.

For details on this operation, refer to "Using the Configuration Menus". (p.27)

2

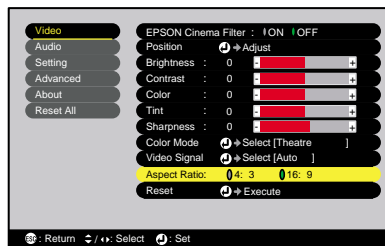

Press the [◀] and [▶] buttons to set the aspect ratio to either "4:3" or "16:9", and then press the [Enter] button.

3

After making the adjustment, press the [Menu] button to exit the configuration menu.

Adjusting Computer Images

Automatic Setup

Automatic setup detects the status of the signals coming from the connected computer, and automatically adjusts these signals so that the optimum images can be obtained. It involves adjustment of the following three items: Tracking▶▶, Position and Sync▶▶.



- If "Auto Setup" in the "Video" menu is set to "OFF" (the default setting for this item is "ON"), automatic setup is not carried out. If you press the [Auto] button on the remote control while computer signals are being projected, adjustment will then be carried out.

Remote control

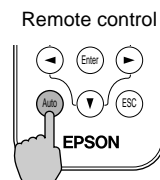

- If you press the [Auto] button while the E-Zoom or Freeze function is being used or while a configuration menu or help menu is being displayed, the function will be cancelled when you press the [Auto] button, and then the adjustment will be carried out.
- Sometimes the signals may not be adjusted correctly depending on the type of signals being output by the computer. In such cases, use the configuration menu commands to adjust the tracking and sync settings manually. (p.17, 18)

Adjusting the Tracking

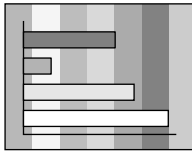

If vertical stripes appear in the projected images, and this cannot be fixed using automatic setup, you will need to adjust the **tracking** manually using the following procedure.

Procedure

1

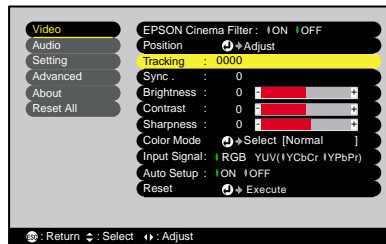

Press the [Menu] button on the remote control, and then select "Tracking" from the "Video" menu.

For details on this operation, refer to "Using the Configuration Menus". (p.27)

2

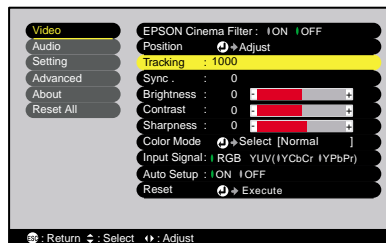

Press the [◀] and [▶] buttons to set the tracking value.

The tracking value increases or decreases each time a button is pressed.

3

After making the adjustment, press the [Menu] button to exit the configuration menu.



The image will flash when continuous tracking adjustment is carried out, but this is normal.

Adjusting the Sync

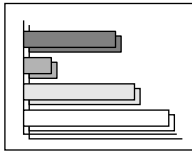

If flickering, fuzziness or interference appear in images that are input from the computer, and this cannot be fixed using automatic setup, you will need to adjust the sync manually using the following procedure.

Procedure

1

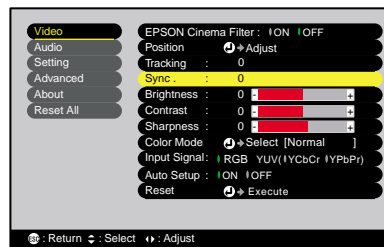

Press the [Menu] button on the remote control, and then select "Sync." from the "Video" menu.

For details on this operation, refer to "Using the Configuration Menus". (p.27)

2

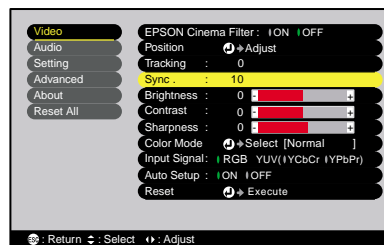

Press the [◀] and [▶] buttons to set the sync value.

The sync value increases or decreases each time a button is pressed.

3

After making the adjustment, press the [Menu] button to exit the configuration menu.



- If you adjust the sync without adjusting the tracking first, it will not be possible to get the best adjustment results. Incorrect tracking adjustment may not be noticeable with some types of picture. However, pictures with lots of lines and shading will tend to show incorrect tracking adjustments more clearly, so be sure to check the tracking adjustment first.
- It may also be possible to fix flickering and fuzziness by adjusting the brightness, contrast, sharpness and keystone correction settings.

Settings and Useful Functions

This chapter describes the configuration menus and useful functions that can be used when a computer is connected.

Using the Configuration Menu Functions..... 20

- "Video" Menu..... 20
 - Video.....20
 - Computer/RGB video22
- "Audio" Menu 23
- "Setting" Menu..... 23
- "Advanced" Menu..... 24
- "About" Menu 25
- "Reset All" Menu 26
- Using the Configuration Menus 27

Useful Functions When a Computer is Connected 29

- A/V Mute 29
- Freeze..... 29
- E-Zoom 30

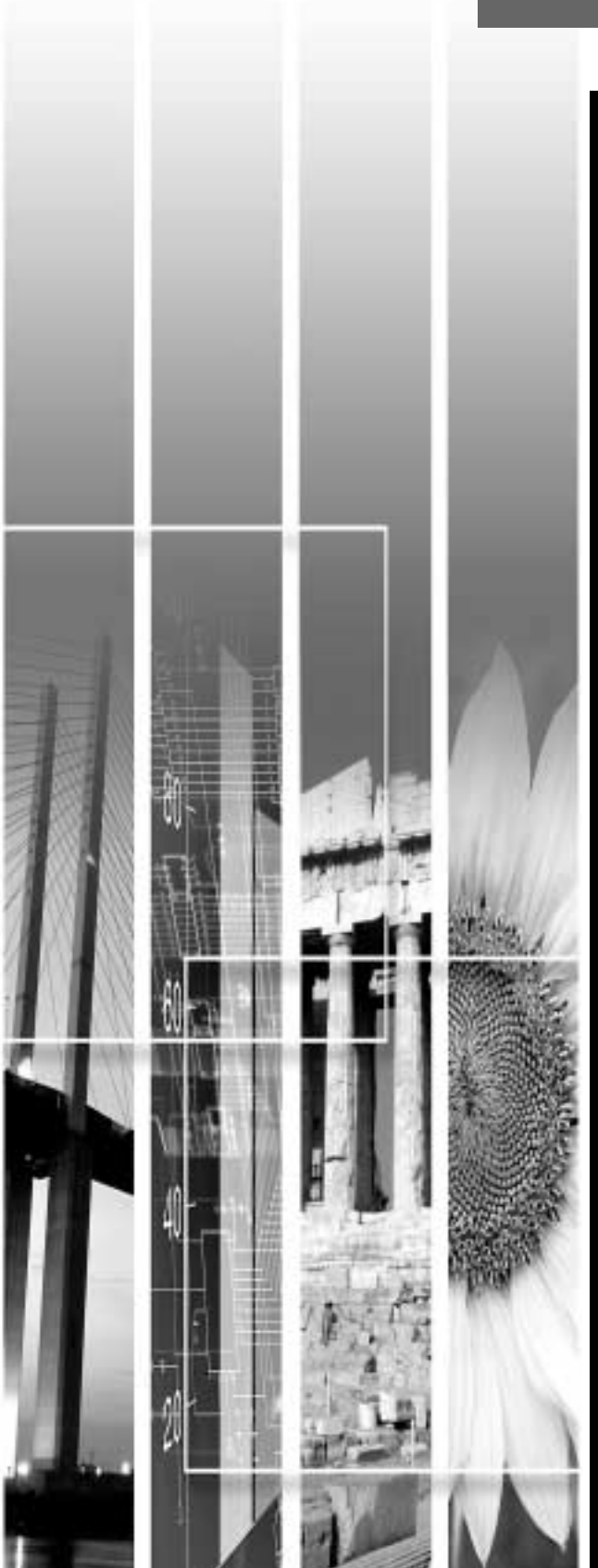

Using the Configuration Menu Functions

The configuration menus can be used to carry out a variety of settings and adjustments.

The menus have a hierarchical structure, with a main menu that is divided into sub-menus, which are further divided into other sub-menus.

The remote control is used to operate the menus. Refer to "Using the Configuration Menus" (p.27) for details on using the menus.

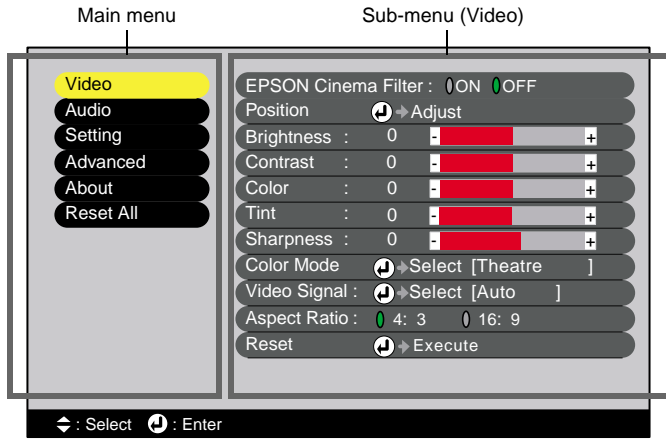

"Video" Menu

- The functions in the "Video" menu apart from "EPSON Cinema Filter", "Input Signal", "Auto Setup" and "Video Signal" cannot be adjusted while no image signal is being input.
- The functions which appear in the "Video" menu will change depending on the type of input source being used for the image signal. Functions which are not available in the "Video" menu for a particular input source cannot be adjusted.

Video (S-Video, Composite video, Component)

Video (S-Video, Composite video)

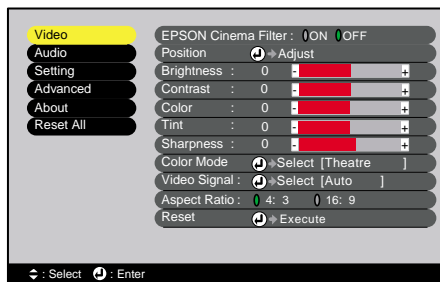

Component (YCbCr, YPbPr)

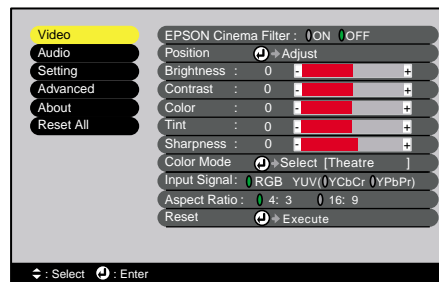

"Video" Menu

Sub-menu	Function	Default
EPSON Cinema Filter	This turns the function for automatically adjusting signals to the optimum tint for movie images on and off. When set to "ON", the proper effect will not be obtained unless the accessory EPSON cinema filter is attached to the lens of the projector. (p.14)	OFF
Position	Moves the image display position vertically and horizontally. • Press the [Enter] button and make the adjustment using the display position adjustment sub-menu that appears.	Depends on connection
Brightness	Adjusts the image brightness.	Median value (0)
Contrast	Adjusts the difference between light and shade in the images.	Median value (0)
Color	(Not available for RGB video) Adjusts the colour intensity for the images.	Median value (0)



Sub-menu	Function	Default
Tint	(Not available for RGB video) (Adjustment is only possible when <u>component video</u> or NTSC signals are being input.) Adjust the image tint.	Median value (0)
Sharpness	Adjusts the image sharpness.	Median value (0)
Color Mode	Corrects the vividness of the image colour. The settings can be saved separately for each type of source (video source or computer). You can select from six different quality settings depending on the surroundings. <ul style="list-style-type: none"> •sRGB : Images conform to the sRGB standard.* •Normal : Brightness is emphasised. For presentation in bright rooms. •Meeting : Images are modulated using their original tints, with no colour enhancement. •Presentation: For presentations in dark rooms. •Theatre : Movie images are optimised using natural tints. The black & white extension function operates so that differences in colour gradations (darkness and lightness of colours) are accentuated even for images that are very dark or very bright, to make them easier to view. •Game : Brightness is emphasised. Ideal for playing video games in bright rooms. 	Theatre
Video Signal	(Adjustment is only possible when composite video/S-Video signals are being input.) Sets the video signal format. <ul style="list-style-type: none"> •Press the [Enter] button, and choose the setting from the video signal format selection sub-menu which appears. •When set to "Auto", the video signal format is set automatically. 	Auto
Input Signal	(Adjustment is only possible when component video signals are being input.) Selects the input source to be used.	Depends on connection
<u>Aspect Ratio</u>	Sets the aspect ratio for projected images.	Depends on connection
Reset	Resets all adjustment values for the "Video" menu functions except for the "EPSON Cinema Filter", "Input Signal" and "Video Signal" setting to their default settings. <ul style="list-style-type: none"> •Press the [Enter] button to display the confirmation screen, and select "Yes". •Select "Reset All" to return all menu settings to their default settings. (p.26) 	-

* If set to sRGB, the colour temperature for the "Color Adjustment" command in the "Advanced" menu will be set to 6500K.

Computer (Analogue-RGB)/RGB video

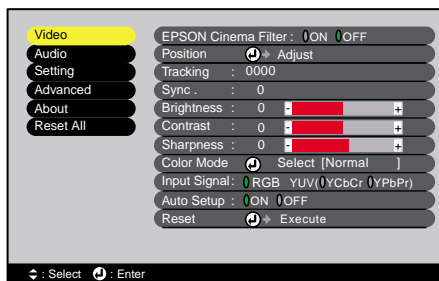

"Video" Menu

Sub-menu	Function	Default
EPSON Cinema Filter	This turns the function for automatically adjusting signals to the optimum tint for movie images on and off. When set to "ON", the proper effect will not be obtained unless the accessory EPSON cinema filter is attached to the lens of the projector. (p.14)	OFF
Position	Moves the image display position vertically and horizontally. • Press the [Enter] button and make the adjustment using the display position adjustment sub-menu that appears.	Depends on connection
Tracking▶▶	Adjusts computer images when vertical stripes appear in the images.	Depends on connection
Sync▶▶	Adjusts computer images when flickering, fuzziness or interference appear in the images. • Flickering and fuzziness may also appear when the brightness, <u>contrast▶▶</u> , sharpness or keystone settings are adjusted. • You can obtain the best results if you adjust the tracking first and then adjust the sync.	Depends on connection
Brightness	Adjusts the image brightness.	Median value (0)
Contrast▶▶	Adjusts the difference between light and shade in the images.	Median value (0)
Sharpness	Adjusts the image sharpness.	Median value (0)
Color Mode	Corrects the vividness of the image colour. The settings can be saved separately for each type of source (video source or computer). You can select from six different quality settings depending on the surroundings. • <u>sRGB▶▶</u> : Images conform to the sRGB standard.* • Normal : Brightness is emphasised. For presentation in bright rooms. • Meeting : Images are modulated using their original tints, with no colour enhancement. • Presentation: For presentations in dark rooms. • Theatre : Movie images are optimised using natural tints. • Game : Brightness is emphasised. Ideal for playing video games in bright rooms.	Normal
Input Signal	Selects the input source to be used. • Select "RGB" when projecting computer images or RGB video images.	Depends on connection
Auto Setup	Selects whether the automatic adjustment function for automatically optimising images when the input source is changed is turned ON or OFF.	ON
Reset	Resets all adjustment values for the "Video" menu functions except for the "EPSON Cinema Filter" and "Input Signal" setting to their default settings. • Press the [Enter] button to display the confirmation screen, and select "Yes". • Select "Reset All" to return all menu settings to their default settings. (p.26)	-

* If set to sRGB, the colour temperature for the "Color Adjustment" command in the "Advanced" menu will be set to 6500K.



"Audio" Menu

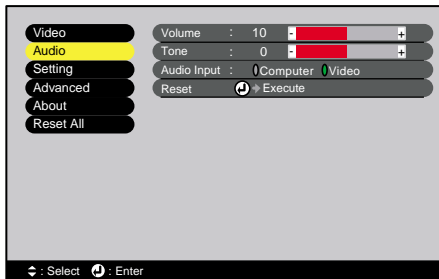

Sub-menu	Function	Default
Volume	Adjusts the volume.	Median value (10)
Tone	Adjusts the tone.	Median value (0)
Audio Input	<p>Selects the input source for audio signals.</p> <p>The default setting varies depending on the type of signal being input (for component video, RGB video and computer input signals: Computer; for video input signals: Video). Therefore, if audio signals are being input to a different port from the default port, you will need to select the audio signal input source.</p> <ul style="list-style-type: none"> •Computer : Audio signals will be input to the stereo mini jack (left side). •Video : Audio signals will be input to the RCA pin jack (left side). 	Depends on connection
Reset	<p>Resets all adjustment values for the "Audio" menu functions to their default settings.</p> <ul style="list-style-type: none"> •Press the [Enter] button to display the confirmation screen, and select "Yes". •Select "Reset All" to return all menu settings to their default settings. (p.26) 	-



The "Audio" menu settings are saved individually for each input signal source.

"Setting" Menu

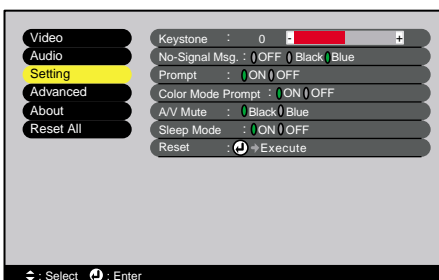

Sub-menu	Function	Default
Keystone	<p>Corrects vertical keystone distortion in images.</p> <ul style="list-style-type: none"> •When keystone correction is carried out, the projected image will become smaller. •If the images become uneven in appearance after keystone correction is carried out, decrease the sharpness setting. 	Median value (0)
No-Signal Msg.	<p>Sets the message status and background colour at times such as when no image signal is being input.</p> <p>When set to "OFF", the background colour becomes black and no message is displayed.</p>	Blue

Sub-menu	Function	Default
Prompt	Sets whether the input signal name is displayed on the screen or not when the input signal is changed.	ON
Color Mode Prompt	Sets whether the colour mode prompt is displayed on the screen or not when the colour mode is changed.	ON
A/V Mute	Sets the screen status when the [A/V Mute] button on the remote control is pressed.	Black
Sleep Mode	<p>Sets the energy saving operation when no signal is being input.</p> <ul style="list-style-type: none"> When set to "ON", projection stops automatically and then after the <u>cool-down</u> period is finished, the projector changes to sleep mode if no operations are carried out for 30 minutes while the "No-Signal." message is being displayed. (The Power indicator lights orange.) Projection starts again when the [Power] button on the projector's control panel or the remote control is pressed. 	ON
Reset	<p>Resets all adjustment values for the "Setting" menu functions to their default settings.</p> <ul style="list-style-type: none"> Press the [Enter] button to display the confirmation screen, and select "Yes". Select "Reset All" to return all menu settings—including settings for the "Video" and "Audio" menus—to their default settings. (p.26) 	-

"Advanced" Menu

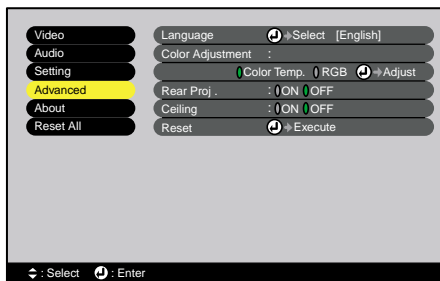

Sub-menu	Function	Default
Language	<p>Sets the language for message displays.</p> <ul style="list-style-type: none"> Press the [Enter] button and select the language from the selection menu that appears. 	English
Color Adjustment	<p>Adjusts the <u>colour temperature</u> and intensity of each RGB colour for each input source.</p> <ul style="list-style-type: none"> Color Temp. : Lets you adjust bright colours within a range from reddish tinges to bluish tinges. <ul style="list-style-type: none"> If the colour temperature is lower, colours appear reddish and colour tones appear softer. If the colour temperature is higher, colours appear bluish and colour tones appear sharper. Press the [Enter] button and make the adjustment in the colour adjustment sub-menu that appears. RGB : Sets the colour intensity for each RGB (red/green/blue) colour in the image. <ul style="list-style-type: none"> Press the [Enter] button, select "R" (red), "G" (green) or "B" (blue) and make the adjustment in the colour adjustment sub-menu that appears. You can adjust the colours while viewing the results on the screen. (This item cannot be selected if "sRGB" has been selected as the "Color Mode" setting in the "Video" menu.) 	Color Temp.: Depends on connection

Sub-menu	Function	Default
Rear Proj.	Use when projecting images from behind a translucent screen. When set to "ON", the projected images are horizontally reversed.	OFF
Ceiling	Use when installing the projector to a ceiling. When set to "ON", the projected images are horizontally and vertically reversed.	OFF
Reset	Resets all adjustment values for the "Advanced" menu functions except for the "Language" setting to their default settings. • Press the [Enter] button to display the confirmation screen, and select "Yes". • Select "Reset All" to return all menu settings including settings for the "Video" and "Audio" menus to their default settings. (p.26)	-

"About" Menu

- The "About" menu shows the setting details for the current image source.
- The "Lamp" item appears as 0H for 0–10 hours, and after that, it appears in units of 1 hour.

Video (S-Video, Composite video)

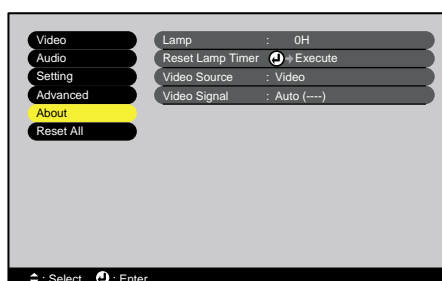

Computer/RGB video/Component video
 (Analogue-RGB, YCbCr, YPbPr)

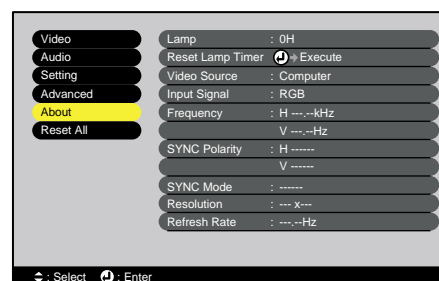

Sub-menu	Function	Default
Lamp	Displays the cumulative lamp operating time. • When the lamp warning period is reached, the display characters appear in red.	0H
Reset Lamp Timer	Initialises the lamp operating time. When this command is selected, the cumulative lamp operating time is reset to the initial default value.	-
Video Source	Displays the input source which is currently being projected.	
Video Signal	Shows the video signal format. (Does not appear when the input source is component video, RGB video or computer.)	-
Input Signal	Displays the input signal settings. (Does not appear when the input source is composite video or S-Video.)	
Frequency	Displays the horizontal and vertical scanning frequencies. (Does not appear when the input source is composite video or S-Video.)	-
SYNC Polarity	Displays the sync polarity. (Does not appear when the input source is composite video or S-Video.)	-
SYNC Mode	Displays the sync attributes. (Does not appear when the input source is composite video or S-Video.)	-
Resolution	Displays the input resolution. (Does not appear when the input source is composite video or S-Video.)	-
Refresh Rate	Displays the refresh rate. (Does not appear when the input source is composite video or S-Video.)	-

"Reset All" Menu

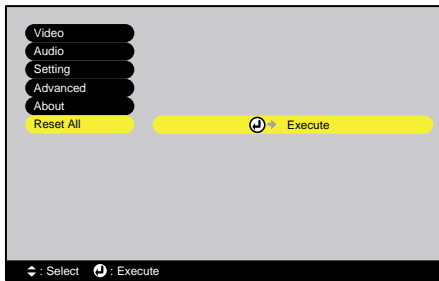

Sub-menu	Function	Default
Execute	Resets all items in all menus to their default settings. <ul style="list-style-type: none"> ● Press the [Enter] button to display the confirmation screen, and select "Yes". ● Select "Reset" in an individual menu to reset only the settings for the items in each sub-menu. ● The "EPSON Cinema Filter", "Input Signal", "Video Signal", "Lamp" and "Language" settings will not return to their default settings. 	-

Using the Configuration Menus

The configuration menus can be operated using the remote control only.

Procedure

1

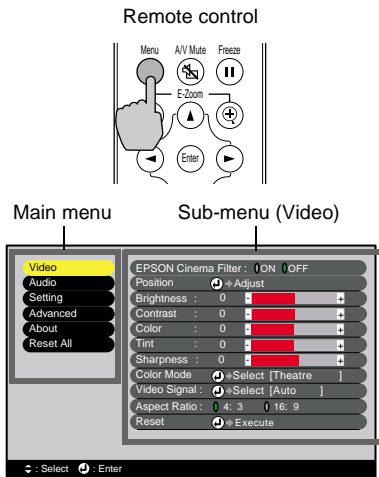

Press the [Menu] button on the remote control.

The configuration menu appears. The configuration menu consists of a main menu and sub-menus. The sub-menu that corresponds to the currently-selected item in the main menu (displayed in yellow) appears.

2

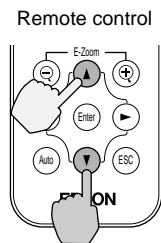

Select a menu item.

Press the [▲] or [▼] button to move to an item to be selected.

3

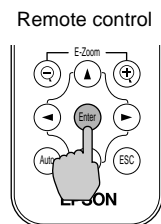

Confirm the selection.

Press the [Enter] button to confirm the selection of a menu item.

The sub-menu that corresponds to the currently-selected item in the main menu appears.

4

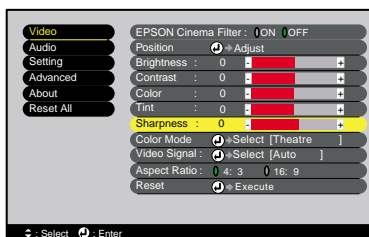

Select a sub-menu item.

Press the [▲] or [▼] button to move to an item to be selected.

The items appearing in the "Video" menu and the "About" menu will vary depending on the type of input source being projected.

Using the Configuration Menu Functions

5

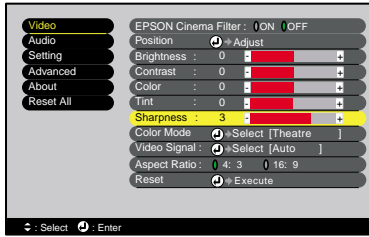

Select a setting value.

Press the [◀] and [▶] buttons to change the setting value.
 For commands which have ON/OFF settings, use the [◀] and [▶] buttons to select the desired setting, and then press the [Enter] button.



- Sub-menu items which cause another sub-menu to be displayed when they are selected have Ⓢ after them. If you select such menu items and press the [Enter] button, you can then change the settings in the next sub-menu which appears.
- Refer to list of functions for details on the functions of each menu item. (p.20)

6

Select other menu items in the same way.

Repeat steps 2 to 5 to change the setting for other menu items. To return to a previous menu, press the [ESC] button.

7

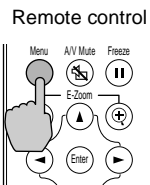

Close the menu.

Press the [Menu] button.

Useful Functions When a Computer is Connected

This section describes the various useful functions that can be used to enhance presentations.

A/V Mute

This function momentarily pauses the image and sound.

For example, it can be used when you do not want to show viewers details of operations such as selecting different files while computer images are being projected.

However, if you use this function when projecting moving images, the images and sound will still continue to be played back by the source, and you cannot return to the point where the mute function was activated.

Procedure

Remote control

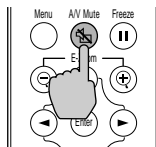

Press the [A/V Mute] button on the remote control.

The image and sound will then be paused.

Press the [A/V Mute] button on the remote control to continue normal projection.

Solid black

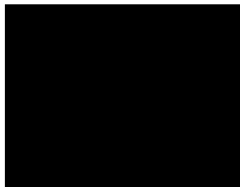

Default setting

Solid blue



When the images and sound have been momentarily paused, one of the following two types of display appears depending on the "A/V Mute" setting in the "Setting" menu. (p.24)

Freeze

This function pauses only the projected images. The sound keeps playing without pausing.

The image source will still be playing back the images even while projection is paused, and so it will not be possible to resume projection from the point where it was paused.

Procedure

Remote control

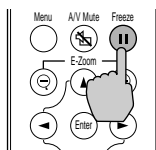

Press the [Freeze] button on the remote control.

The images will then be paused.

To continue projecting the images, either press the [Freeze] button again or press the [ESC] button.



- Pressing the [Freeze] button also clears menu displays and help messages.
- The Freeze function still works while the E-Zoom function is being used. However, in this case the Freeze function can only be cancelled by pressing the [Freeze] button.

E-Zoom

This function lets you enlarge and reduce a part of projected images such as graphs and tables.

Procedure**1**

Remote control

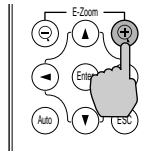

Press the [E-Zoom ⊕] button on the remote control.

A cursor (cross) indicating the centre point for the area to be enlarged will appear on the screen.

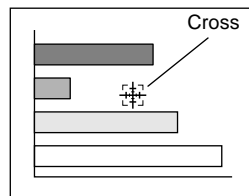
2

Move the cross to the area of the image that is to be enlarged or reduced.

Press the [▲], [▼], [◀] and [▶] buttons on the remote control to move the cross.

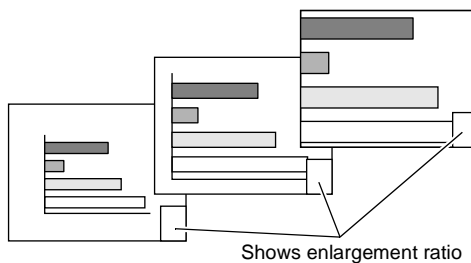
3

When [⊕] is pressed, the image is enlarged with the cross as its centre. When [⊖] is pressed, the enlarged picture is then reduced.

The enlargement ratio will appear at the bottom-right of the screen.

You can scroll around the image by pressing the [▲], [▼], [◀] and [▶] buttons.

To cancel the E-Zoom, press the [ESC] button.



The selected area can be enlarged to between 1– 4 times, in 25 steps of x0.125.

Troubleshooting

This section describes how to identify problems and what to do if a problem is found.

Using the Help	32
When Having Some Trouble	33
• ⚠ (Warning) Indicator	33
• Power Indicator	34
When the Indicators Provide No Help	35

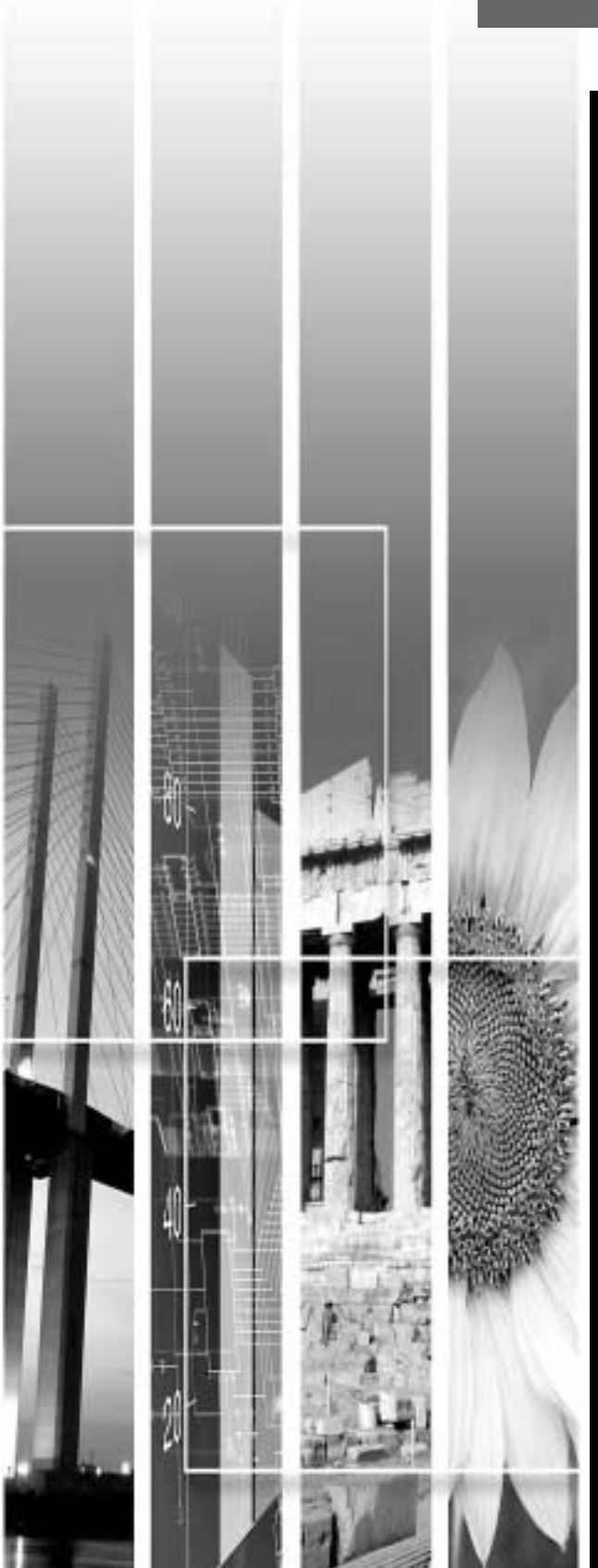

Using the Help

If a problem occurs with the projector, the Help function uses on-screen displays to assist you in solving the problem. It uses a series of menus in a question and answer format. The questions vary depending on the type of image source.

Procedure

1

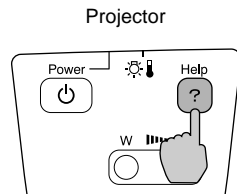

Press the [Help] button on the projector's control panel.

The help menu will be displayed.

2

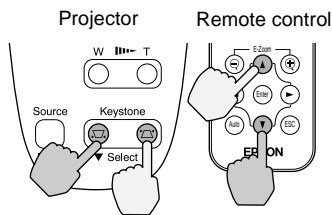

Select a menu item.

If using the control panel, the [▼ Select ▲] buttons function as the up and down keys.

If using the remote control, press the [▲] and [▼] buttons to select an item.

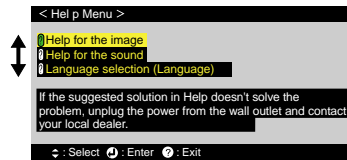

3

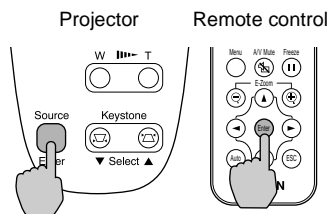

Confirm the selection.

Press the [Enter] button to confirm the selection of a menu item.

4

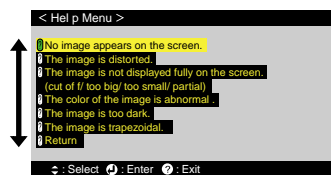

Repeat the operations in steps 2 and 3 to proceed through the menu to more detailed items.

You can exit the help menu at any time by pressing the [Help] button.



If the Help function does not provide a solution to the problem, refer to "When Having Some Trouble" (p.33) or "When the Indicators Provide No Help" (p.35).

When Having Some Trouble

 (Warning) Indicator

Power Indicator

If you are having a problem with the projector, first check the projector's indicators. The projector is provided with the following two indicators. These indicators alert you to problems with projector operation.

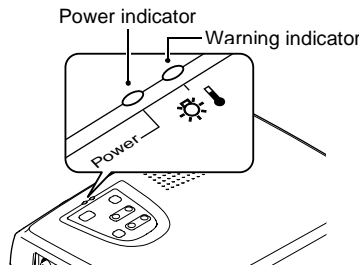



The following tables show what the indicators mean and how to remedy problems that they indicate.

(Warning) Indicator



● : lit  : flashing

Status	Cause	Remedy or Status	See Page
Red ●	High internal temperature (overheating)	The lamp will turn off automatically and projection will stop. Wait for about 5 minutes without operating the projector. After about 5 minutes have elapsed, unplug the power cable and then check the following two points. <ul style="list-style-type: none"> • Check that the air inlet and air outlet are clear, and that the projector is not positioned against a wall. • If the air filter is dirty, it should be cleaned. When the power cable is plugged back in, the projector will return to its previous state, so press the [Power] button on either the projector's control panel or the remote control to turn it back on. If the projector continues to overheat even after the above points have been checked, or if the indicators show a problem when the power is turned back on, stop using the projector, disconnect the power cable from the electrical outlet, and contact your dealer or the nearest address provided at "International Warranty Conditions" in <i>Safety Instructions/World-Wide Warranty Terms</i> .	<i>Setup Guide</i> p.44
Red  (0.5-second intervals)	Problem with lamp	Disconnect the power cable from the electrical outlet and then remove the lamp and check if it is broken. If the lamp is not broken, reinstall it. Then reconnect the power cable and press the [Power] button on either the projector's control panel or the remote control to turn the power back on. If the indicators still show a problem, stop using the projector, disconnect the power cable from the electrical outlet, and contact your dealer or the nearest address provided at "International Warranty Conditions" in <i>Safety Instructions/World-Wide Warranty Terms</i> .	p.46
		If the lamp is broken replace by a new lamp, or contact your local dealer for further advise. If replacing the lamp yourself, be careful to avoid pieces of broken glass. (Projection cannot be carried out until the lamp is replaced.)	p.46
		Check that the lamp and the lamp cover are securely installed. If the lamp or lamp cover is not securely installed, the lamp will not switch on.	p.46

Status	Cause	Remedy or Status	See Page
Red  (1-second intervals)	Internal problem	Stop using the projector, disconnect the power cable from the electrical outlet, and contact your dealer or the nearest address provided at "International Warranty Conditions" in <i>Safety Instructions/World-Wide Warranty Terms</i> .	
Orange 	High-speed cooling in progress	(This is not an abnormality, but if the temperature rises too high again, projection will stop automatically.) <ul style="list-style-type: none"> •Set the projector up in a place which is well-ventilated, and so that the air filter and exhaust vents are clear. •Clean the air filter. 	<i>Setup Guide</i> p.44

Power Indicator

● : lit  : flashing

Status	Cause	Remedy or Status	See Page
Orange ●	Standby status	(Not abnormal) The power cable should only be disconnected when the projector is in this condition. Press the [Power] button to start projection.	p.6
Orange 	Cool-down in progress	(Not abnormal) <ul style="list-style-type: none"> •Please wait. The <u>cool-down</u>  period lasts for about 20 seconds. •The [Power] button does not work during cool-down. Press the button again after cool-down ends. 	p.9
Green ●	Projection in progress	(Not abnormal)	p.7
Green 	Warm-up in progress	(Not abnormal) Please wait. Warm-up time is approximately 40 seconds. After warm-up is complete, the flashing green indicator changes to steady green.	p.7



- If the projector is not operating properly even though the indicators are all showing normal, refer to "When the Indicators Provide No Help" on the following page.
- If an indicator is showing a status which does not appear in the previous tables, contact your dealer or the nearest address provided at "International Warranty Conditions" in *Safety Instructions/World-Wide Warranty Terms*.

When the Indicators Provide No Help

If any of the following problems occur and the indicators do not offer a solution, refer to the pages given for each problem.

No images appear	p.35	Images appear dark	p.39
Poor image quality (out of focus or distorted)	p.36	Images appear greenish	p.39
Only part of the image is displayed (Large/small)	p.37	Images appear purplish	
The image colours are not right	p.38	No sound can be heard	p.39
		The remote control does not work	p.40
		The power does not turn off	p.40

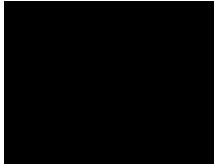
	Condition No images appear (Nothing at all appears)
---	--

Probable cause	Remedy
Was the power turned off and then straight back on again? After the power is turned off (during cool-down), the [Power] buttons on the projector's control panel and the remote control will not work.	→ Wait until cool-down has finished. You can then use the [Power] buttons. (p.9)
Is sleep mode active? When sleep mode has been set to "ON", the lamp turns off automatically if no operations are carried out for 30 minutes while no image signal is being input. The Power indicator lights orange at this time.	→ Turn the projector power back on. To cancel the sleep mode setting, set "Sleep Mode" to "OFF". "Setting" - "Sleep Mode" (p.24)
Have you pressed the [Power] button?	→ Press the [Power] button on either the projector's control panel or the remote control to turn on the power for the projector. (p.7)
Has the image brightness been adjusted correctly?	→ Use the "Brightness" command to adjust. "Video" - "Brightness" (p.20, 22)
Is A/V Mute mode active?	→ Press the [A/V Mute] button on the remote control to cancel the A/V Mute mode. (p.29)
Is the projected image completely black? Some input images, such as screen savers, may be completely black.	→ Cancel the screen saver, or re-check the images being input.
Is an image signal being input? If "No-Signal Msg." has been set to "OFF", no messages will be displayed.	→ Change the "No-Signal Msg." setting to "Black" or "Blue" for messages to be displayed. "Setting" - "No-Signal Msg." (p.23) If a message is displayed, refer to the item indicated.
Try resetting all of the current settings.	→ "Reset All" - "Execute" (p.26)

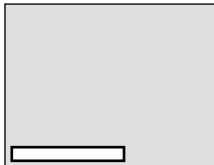
	Condition No images appear (Messages do appear) "Not Supported." is displayed. "No-Signal." is displayed.
---	--

Probable cause	Remedy
Are the cables connected correctly?	→ Check that all cables that are required for projection are connected correctly. (Setup Guide)

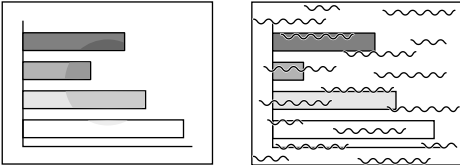

Probable cause	Remedy
Does the input signal match the connected source?	→ Use the [Source] button on the projector's control panel (or the [Computer] or [S-Video/Video] button on the remote control) to select the correct signal source. (p.7)
Is the power for the video source or computer turned on?	→ Turn on the power. (p.7)
If a laptop computer or a computer with a LCD screen has been connected to the projector, it is necessary to output the image signals to the projector rather than to the screen.	→ Normally image signals are output to only the computer's LCD screen, so you need to change the output to an external destination. For some computer models, when the image signals are output externally, they no longer appear on the LCD screen. For details, refer to the section of the documentation provided with your computer under a heading such as "External output", "Connecting an external monitor" or similar. (p.8)
Check the mode which corresponds to the frequency of the image signals being output from the computer.	→ Refer to the documentation provided with your computer for details on changing the resolution and frequency of the image signals being output from the computer. (p.51)

	<p>Condition</p> <p>Poor image quality (out of focus or distorted)</p> <ul style="list-style-type: none"> • The image is fuzzy • Part of the image is out of focus • The whole image is out of focus • Image is distorted • Image contains interference
--	--

Probable cause	Remedy
Has the focus been adjusted correctly?	→ Adjust the focus. (p.11)
Is the lens cover still attached?	→ Remove the lens cover. (p.6)
Has the front adjustable feet been adjusted so that the image angle is too big? If the image angle is too big, the image will be out of focus vertically.	→ Adjust the front adjustable feet to reduce the angle of tilt to 10° or less. (p.12)
Is the projector at the correct distance?	→ The recommended distance from the projector to the screen is within 0.9–11.3 m (2.9–37.0 ft.). Set up the projector so that the projection distance is within this range. (<i>Setup Guide</i>)
Is the projector beam perpendicular to the screen?	→ Adjust the projection angle so that the projector beam is perpendicular to the screen. (p.12)
Is the lens dirty?	→ Clean the lens. (p.44)
Has condensation formed on the lens? If the projector is suddenly taken from a cold environment to a warm environment, condensation may form on the surface of the lens, and this may cause the images to appear fuzzy.	→ Set the projector up in the room approximately one hour before it is to be used. If condensation forms on the lens, turn off the power and wait for the condensation to disappear.
Is the EPSON cinema filter attached correctly? If it is not attached correctly, the images may appear uneven or out of focus.	→ Remove the EPSON cinema filter and reattach it. (p.14)

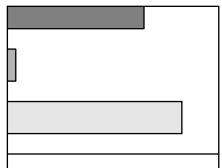

Probable cause	Remedy
Are the image signal format settings correct?	→ If a <u>component video</u> ▶▶, RGB video or computer source is connected to the projector, use the "Input Signal" command to select the signal format which matches the signal connected source. "Video" - "Input Signal" (p.21, 22) If a <u>composite video</u> ▶▶ or <u>S-Video</u> ▶▶ source is connected to the projector, use the "Video Signal" command to select the video signal format. "Video" - "Video Signal" (p.21)
Are the cables connected correctly?	→ Check that all cables that are required for projection are connected correctly. (<i>Setup Guide</i>)
Is an extension cable being used? If an extension cable is used, electrical interference may affect the signals.	→ Use the accessory cables and check if this helps.
Have the "Sync.▶▶", "Tracking▶▶" and "Position" been adjusted correctly? (When connected to a computer)	→ If the "Auto Setup" command in the "Video" menu is set to "OFF", press the [Auto] button on the remote control to adjust these settings. If the images have not been correctly adjusted after using the automatic setup function and after pressing the [Auto] button, adjust the settings manually using the respective menus. (p.16, 22)
Has the correct resolution been selected? (When connected to a computer)	→ Set the computer so that the signals that are output are compatible with this projector. Refer to the documentation provided with your computer for details on changing the settings. (p.51)

		<p>Condition</p> <ul style="list-style-type: none"> • Image is too large (Only part of the image is displayed) • Image is too small
---	---	---

Probable cause	Remedy
Is the [Zoom] button setting correct?	→ Use the [Zoom] button to adjust the size of the image. (p.11)
Has the "Aspect Ratio▶▶" setting been selected correctly?	→ Use the "Aspect Ratio" command to set the aspect ratio to "4:3". "Video" - "Aspect Ratio" (p.21)
Is the E-Zoom function being used to enlarge the image?	→ Press the [ESC] button on the remote control to cancel E-Zoom. (p.30)
Has the "Position" setting been adjusted correctly?	→ Use the "Position" command to adjust. "Video" - "Position" (p.20, 22)
Has the correct resolution been selected? (When connected to a computer)	→ Set the computer so that the signals that are output are compatible with this projector. Refer to the documentation provided with your computer for details on changing the settings. (p.51)
Change the resolution for the laptop computer or computer with a LCD screen. (When connected to a computer)	→ Change the resolution so that the image is displayed in the whole of the projection area, or set the image signal to external output only. (p.8)

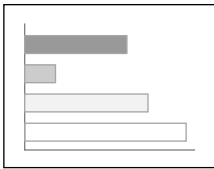

Probable cause	Remedy
Has the computer been set for dual display? (When connected to a computer)	➔ If dual display has been activated in the Display Properties of the connected computer's Control Panel, the projector will only display about half of the image on the computer screen. To display the whole of the image on the computer screen, turn off the dual display setting. Refer to the video driver manual for the computer's monitor for further details.

	<p>Condition</p> <p>The image colours are not right</p>
---	---

Probable cause	Remedy
Has the image brightness been adjusted correctly?	➔ Use the "Brightness" command to adjust. "Video" - "Brightness" (p.20, 22)
Are the cables connected correctly?	➔ Check that all cables that are required for projection are connected correctly. (<i>Setup Guide</i>)
Are the image signal format settings correct? If the "Input Signal" menu command is set to "YCbCr" or "YPbPr" when a computer is connected, the projected images will appear purplish. If the "Input Signal" command is set to "RGB" when a component video signal source is connected to the projector, the images will appear greenish.	➔ If a <u>component video</u> ▶▶, RGB video or computer source is connected to the projector, use the "Input Signal" command to select the signal format which matches the signal connected source. "Video" - "Input Signal" (p.21, 22) If a <u>composite video</u> ▶▶ or <u>S-Video</u> ▶▶ source is connected to the projector, use the "Video Signal" command to select the video signal format. "Video" - "Video Signal" (p.21)
Has the image <u>contrast</u> ▶▶ been adjusted correctly?	➔ Use the "Contrast" command to adjust. "Video" - "Contrast" (p.20, 22)
Has the colour been adjusted correctly?	➔ Use the "Color Adjustment" command to adjust the contrast. "Advanced" - "Color Adjustment" (p.24)
Have the colour intensity and tint been adjusted correctly? (The colours may not exactly match the colours in the image on the computer screen or LCD screen, but this is normal and is not the sign of a problem.)	➔ Use the Video menu to adjust the Color and Tint settings. "Video" - "Color", "Tint" (p.20, 21)
Is the lamp due for replacement? When the lamp is nearly due for replacement, the image will become darker and the colour quality will become poorer.	➔ When this happens, the lamp should be replaced with a new one. (p.46)
The accessory EPSON cinema filter has been removed from the lens, but the "EPSON Cinema Filter" command in the "Video" menu is still set to "ON".	➔ Change the "EPSON Cinema Filter" setting in the "Video" menu to "OFF". "Video" - "EPSON Cinema Filter" (p.20, 22)



	<p>Condition</p> <p>Images appear dark</p>
--	--

Probable cause	Remedy
<p>Is the lamp due for replacement? When the lamp is nearly due for replacement, the image will become darker and the colour quality will become poorer.</p>	<p>→ When this happens, the lamp should be replaced with a new one. (p.46)</p>
<p>Has the image brightness been adjusted correctly?</p>	<p>→ Use the "Brightness" command to adjust. "Video" - "Brightness" (p.20, 22)</p>
<p>Is the accessory EPSON cinema filter still attached to the projector's lens?</p>	<p>→ If connecting a computer to the projector to give presentations, remove the EPSON cinema filter and set the "EPSON Cinema Filter" command to "OFF". "Video" - "EPSON Cinema Filter" (p.20, 22)</p>
<p>Has the image <u>contrast</u>▶▶ been adjusted correctly?</p>	<p>→ Use the "Contrast" command to adjust. "Video" - "Contrast" (p.20, 22)</p>

	<p>Condition</p> <p>Images appear greenish Images appear purplish</p>
--	---

Probable cause	Remedy
<p>Are the image signal format settings correct? If the "Input Signal" menu command is set to "YCbCr" or "YPbPr" when a computer is connected, the projected images will appear purplish. If the "Input Signal" command is set to "RGB" when a component video signal source is connected to the projector, the images will appear greenish.</p>	<p>→ If a <u>component video</u>▶▶, RGB video or computer source is connected to the projector, use the "Input Signal" command to select the signal format which matches the signal connected source. "Video" - "Input Signal" (p.21, 22) If a <u>composite video</u>▶▶ or <u>S-Video</u>▶▶ source is connected to the projector, use the "Video Signal" command to select the video signal format. "Video" - "Video Signal" (p.21)</p>

	<p>Condition</p> <p>No sound can be heard.</p>
--	--

Probable cause	Remedy
<p>Is the audio source connected correctly?</p>	<p>→ Check that the cable being used matches the input port. (Setup Guide)</p>
<p>Has the correct audio input port been selected?</p>	<p>→ Use the "Audio Input" menu command to select the port to use for audio input. "Audio" - "Audio Input" (p.23)</p>
<p>Is sound being output from the audio source?</p>	<p>→ Check the volume for the audio source.</p>

Probable cause	Remedy
Has the volume been adjusted to the minimum setting?	→ Adjust the volume so that the sound is audible. "Audio" - "Volume" (p.23)
Is A/V Mute mode active?	→ Press the [A/V Mute] button on the remote control to cancel the A/V Mute mode. (p.29)

	<p>Condition</p> <p>The remote control does not work</p>
---	--

Probable cause	Remedy
Is the remote control light-emitting area facing towards the remote control light-receiving area when it is operated?	→ The operating angle for the remote control is approximately $\pm 30^\circ$ horizontally and approximately $\pm 15^\circ$ vertically. Use the remote control within these ranges. (<i>Setup Guide</i>)
Is the remote control too far from the projector?	→ The operating distance for the remote control is approximately 6 m (20 ft.). Use the remote control within this distance. (<i>Setup Guide</i>)
Is direct sunlight or strong light from fluorescent lamps shining onto the remote control light-receiving area?	→ Avoid using projector in places where the remote control light-receiving area is exposed to strong light.
Has the battery insulating tape been removed?	→ When using the remote control for the first time, pull out the insulating tape that is protruding from the battery holder. (<i>Setup Guide</i>)
Is the battery inserted?	→ Insert the battery. (p.45)
Is the battery spent?	→ Replace the battery with a new one. (p.45)
Is the battery inserted incorrectly?	→ Reinsert the battery so that it faces correctly. (p.45)

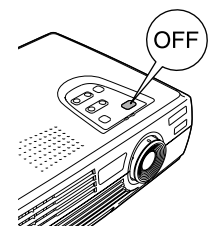
	<p>Condition</p> <p>The power does not turn off (after the [Power] button is pressed)</p>
---	---

Probable cause	Remedy
The Power indicator remains orange. This projector is designed so that the Power indicator remains lit even when after the power has been turned off.	→ The Power indicator will switch off when the power cable is disconnected from the electrical outlet.

Probable cause	Remedy
<p>The cooling fan does not stop. After the [Power] button is pressed to turn off the power, the <u>cool-down</u>▶▶ period starts.</p>	<p>➔ After the cool-down period is complete, the Power indicator changes to a steady orange, and you can then disconnect the power cable from the electrical outlet.</p> <p>* The cool-down period lasts for about 20 seconds. The actual time will vary depending on the external air temperature.</p>

Appendices

This chapter provides information on maintenance procedures to ensure the best level of performance for the projector for a long time.

Maintenance	44
• Cleaning.....	44
• Cleaning the Projector Case.....	44
• Cleaning the Lens and EPSON Cinema Filter.....	44
• Cleaning the Air Filter	44
• Replacing Consumables	45
• Inserting the Battery.....	45
• Lamp Replacement Period.....	46
• Replacing the Lamp	46
• Resetting the Lamp Operating Time.....	48
• Replacing the Air Filter	49
Optional Accessories	50
List of Supported Monitor Displays	51
• Component Video Input/RGB Video Input	51
• Composite Video/S-Video Input.....	51
• Computer	51
Specifications.....	52
Appearance	54
Part Names and Functions.....	55
• Front/Top.....	55
• Control Panel	56
• Left Side.....	56
• Rear.....	57
• Base	57
• Remote Control.....	58
Glossary.....	59
Index.....	61



Maintenance

This section describes maintenance tasks such as cleaning the projector and replacing consumable parts.

Cleaning

You should clean the projector if it becomes dirty or if the quality of projected images starts to deteriorate.



Be sure to read the separate *Safety Instructions/World-Wide Warranty Terms* before cleaning.

Cleaning the Projector Case

Clean the projector case by wiping it gently with a soft cloth.

If the projector is particularly dirty, moisten the cloth with water containing a small amount of neutral detergent, and then firmly wring the cloth dry before using it to wipe the projector case. Then wipe the case again with a soft, dry cloth.



Do not use volatile substances such as wax, alcohol or thinner to clean the projector case. These can cause the case to warp and make the coating finish peel off.

Cleaning the Lens and EPSON Cinema Filter

Use a commercially-available air blower, or use lens cleaning paper to gently wipe the lens and the EPSON cinema filter.



Do not rub the lens or the EPSON cinema filter with harsh materials or subject them to shocks, as they can easily become damaged.

Cleaning the Air Filter

If the air filter becomes clogged with dust, it can cause overheating and damage the projector.

Turn the projector upside down and use a vacuum cleaner to remove the dust from the air filter

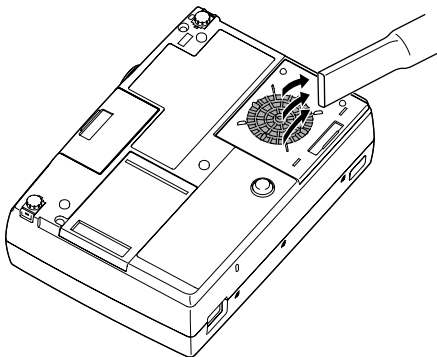

- If the air filter is difficult to clean or if it is broken, it should be replaced. Contact your dealer for a spare air filter.
- Spare lamps are provided with a spare air filter. The air filter should also be replaced when the lamp is replaced. (p.50)

Replacing Consumables

This section describes how to replace the remote control battery, the lamp and the air filter.

Inserting the Battery

Use the following type of battery as a replacement.

1 CR2025 lithium battery



Be sure to read the *Safety Instructions/World-Wide Warranty Terms* before handling the battery.

Procedure

1

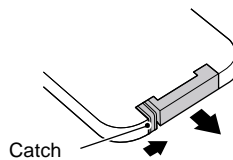

Remove the battery holder.

While pushing the catch of the battery holder inwards, pull the battery holder out.

2

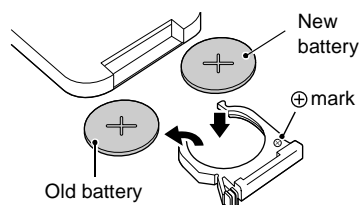

Remove the old battery and insert the new battery.

Check the position of the (+) mark inside the battery holder to ensure that that battery is inserted the correct way.

3

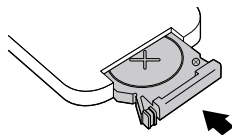

Insert the battery holder into the remote control.

Push the battery holder in until it clicks.



Dispose of used batteries in accordance with local waste disposal regulations.

Lamp Replacement Period

It is time to replace the lamp when:

- The message "Lamp Replace" appears on the screen when projection starts.

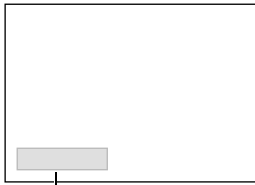

A message will be displayed.

The message appears for 30 seconds, and disappears again after 30 seconds have passed.

- When the ⚠ (Warning) indicator is flashing red at 0.5-second intervals

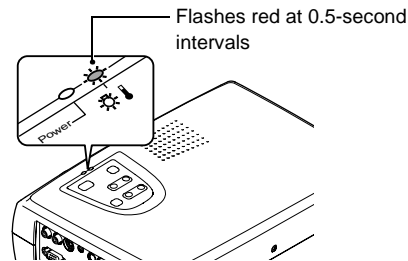

- The projected image gets darker or starts to deteriorate



- The replacement warning message is set to appear after about 1400 hours of lamp use in order to maintain the brightness and quality of the projected images. If you continue to use the lamp after this period, the possibility of the lamp breaking becomes greater. When the lamp replacement message appears, replace the lamp with a new one as soon as possible, even if it is still working.
- The warning message appears after about 1400 hours of use, but the actual life of each individual lamp will vary depending on the characteristics of the lamp and on the way it has been used. Some lamps may stop operating before 1400 hours of use, so you should always have a spare lamp ready in case.
- Contact your dealer for a spare lamp.

Replacing the Lamp



- If the lamp stops working and needs to be replaced, there is the danger that the lamp may break when handled. If replacing the lamp of a projector that has been installed to the ceiling, you should always assume that the lamp is broken and remove the lamp cover very carefully.
- Wait until the lamp has cooled down sufficiently before opening the lamp cover. It takes a further one hour after the cool-down period has finished for the lamp to be cool enough.

Procedure

1

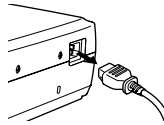

Turn off the projector power, wait for the cool-down period to end, and then disconnect the power cable.

The cool-down period lasts for about 20 seconds. The actual time will vary depending on the external air temperature.

2

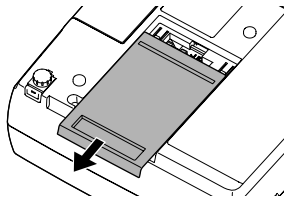

Wait until the lamp has cooled down, and then remove the lamp cover from the base of the projector.

It takes approximately one hour for the lamp to cool down by itself after the cool-down period has finished.

Put your finger into the recess, and pull straight out to remove the lamp cover.

3

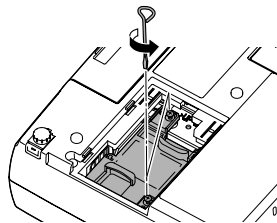

Loosen the two lamp fixing screws.

Use the screwdriver that is supplied with the spare lamp or a Phillips screwdriver to loosen the two lamp fixing screws that are securing the lamp to the projector.

4

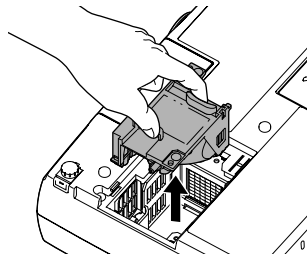

Take out the lamp.

Hold the lamp by the two tabs to lift it up and out from the projector.

If the lamp is broken replace by a new lamp, or contact your local dealer for further advise. If replacing the lamp yourself, be careful to avoid pieces of broken glass.

(Projection cannot be carried out until the lamp is replaced.)

5

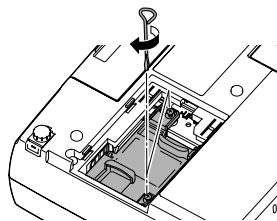

Install the new lamp.

Hold the lamp so that it faces the correct way to fit into the projector, and then insert the lamp and tighten the two lamp fixing screws.

6

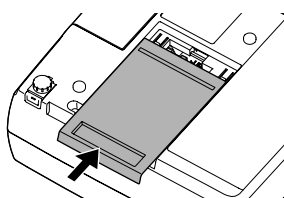

Install the lamp cover.

Slide the cover in from the outside, and then push it in until it clicks into place.

- Install the lamp securely. If the lamp cover is removed, the lamp turns off automatically as a safety precaution. Moreover, the lamp will not turn on if the lamp or the lamp cover is not installed correctly.
- Spare lamps are provided with a spare air filter. The air filter should also be replaced when the lamp is replaced. (p.49)
- Dispose of used lamps properly in accordance with your local regulations.

Resetting the Lamp Operating Time

The projector has a built-in counter which keeps track of the lamp operating time. When the cumulative operating time reaches a certain point, it causes the replacement warning message to be displayed. Therefore, the counter needs to be reset after the lamp has been replaced with a new one. You can do this using the configuration menu.

Do not reset the lamp operating time except after the lamp has been replaced, otherwise the lamp replacement period will not be indicated correctly.

Procedure

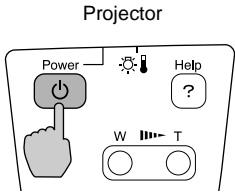
- 

1 Projector

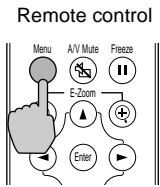
Connect the power cable, and then press the [Power] button on either the projector's control panel or the remote control to turn on the power for the projector.
- 

2 Remote control

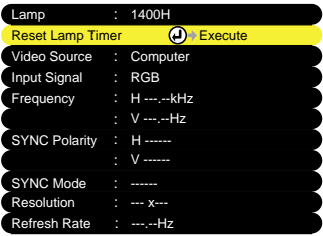
Press the [Menu] button on the remote control. The configuration menu will be displayed.
- 

3

Select "Reset Lamp Timer" from the "About" menu and then press the [Enter] button.
- 

4

Select "Yes" and then press the [Enter] button. The lamp operating time will then be reset.

Replacing the Air Filter

Procedure

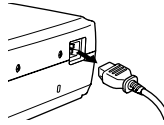
1

Turn off the projector power, wait for the **cool-down** period to end, and then **disconnect the power cable**.

The cool-down period lasts for about 20 seconds. The actual time will vary depending on the external air temperature.

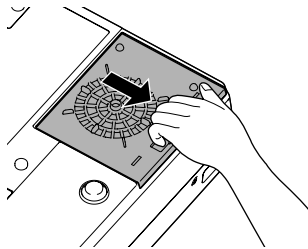
2

Put your finger into the recess, and pull straight out to remove the air filter.

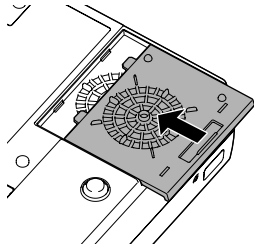
3

Install the new air filter.

Slide the cover in from the outside, and then push it in until it clicks into place.



Dispose of used air filters properly in accordance with your local regulations.

Optional Accessories

The following optional accessories are available for purchase if required. This list of optional accessories is current as of August 2002. Details of accessories are subject to change without notice.

Spare lamp (Silver model)	ELPLP19	VGA-HD15 PC cable	ELPKC02
Spare lamp (Blue model)	ELPLP19C	(1.8 m (6 ft.) - for mini D-Sub 15-pin/mini D-Sub 15-pin)	
Use as a replacement for spent lamps. The colour of the air filter that is included with the spare lamp should match the colour of the projector.		VGA-HD15 PC cable	ELPKC09
50" portable screen	ELPSC06	(3 m (9.8 ft.) - for mini D-Sub 15-pin/mini D-Sub 15-pin)	
A compact screen which can be carried easily. (Aspect ratio 4:3▶▶)		VGA-HD15 PC cable	ELPKC10
60" screen	ELPSC07	(20 m (65.6 ft.) - for mini D-Sub 15-pin/mini D-Sub 15-pin)	
80" screen	ELPSC08	Use to connect the projector to a computer.	
100" screen	ELPSC10	Remote control unit	ELPST07
A portable roll-type screen. (Aspect ratio 4:3)		This is the same remote control as the projector's accessory remote control.	
Component video cable	ELPKC19	Soft carry case	ELPKS16
(3 m (9.8 ft.) - for mini D-Sub 15-pin/RCA male x 3)		Use this case if you need to carry the projector by hand.	
Use to connect a <u>component video</u> ▶▶ source.		Image presentation camera	ELPDC02 ELPDC03 ELPDC04
		Use when projecting books, OHP films and slides.	

List of Supported Monitor Displays

Component Video Input/RGB Video Input

Signal	Refresh rate▶▶ (Hz)	Aspect ratio▶▶ 4:3 Resolutions(dots)	Aspect ratio 16:9 Resolutions(dots)
<u>SDTV▶▶</u> (525i) (D1)	60	800 × 600	800 × 450
SDTV (625i)	50	800 × 600	800 × 450
SDTV (525p) (D2)		800 × 600	800 × 450
<u>HDTV▶▶</u> (750p) 16:9 (D4)		800 × 600	800 × 450
HDTV(1125i) 16:9 (D3)		800 × 600	800 × 450

Composite Video/S-Video Input

Signal	Refresh rate▶▶ (Hz)	Aspect ratio▶▶ 4:3 Resolutions(dots)	Aspect ratio 16:9 Resolutions(dots)
TV (NTSC)		800 × 600	800 × 450
TV (PAL, SECAM)		800 × 600	800 × 450

Computer

Signal	Refresh rate▶▶ (Hz)	Resolution (dots)	Resolutions for resized display▶▶ (dots)
PC98		640×400	800×500
EGA		640×350	800×438
<u>VGA▶▶</u>	60	640×480	800×600
VGACGA		640×400	800×500
VGAEGA		640×350	800×438
VGA text		720×400	800×444
		720×350	800×388
VESA	60/72/75/85,iMac*	640×480	800×600
<u>SVGA▶▶</u>	56/60/72/75/85,iMac*	800×600	800×600
<u>XGA▶▶</u>	43i/60/70/75/85,iMac*	1024×768	800×600
MAC13"		640×480	800×600
MAC16"		832×624	800×600
MAC19"		1024×768	800×600
MAC21"		1152×870	800×600
NTSC		640×480	800×600
PAL/SECAM		720×540	800×600
<u>HDTV▶▶</u> (525i)			800×600
HDTV(525p)			800×600
HDTV(750p)	60	1280×720	800×450
HDTV(1125i)	60	1920×1080	800×450

* Connection is not possible if the equipment does not have a VGA output port.

It may be possible to project signals which are not listed in the above table. However, not all functions may be supportable with such signals.

Specifications

Product name	Multipurpose Entertainment Projector EMP-30		
Dimensions	309 (W) x 93 (H) x 219 (D) mm (12.2 (W) x 3.7 (H) x 8.6 (D) in.) (not including feet and lens)		
Panel size	0.5 in.		
Display method	Polysilicon TFT active matrix		
Drive method	Full-line 6-phase block sequential writing		
Resolution	<u>SVGA</u> ▶▶ 480,000 pixels (800 (W) x 600 (H) dots) x 3		
Focus adjustment	Manual		
Zoom adjustment	Electronic (approx. 1 : 1.2)		
Lamp (light source)	UHE lamp, 130 W, Model No.: ELPLP19 (Silver model) / ELPLP19C (Blue model)		
Max. audio output	1W monaural		
Speaker	1		
Power supply	100–120 V AC, 2.2A 200–240 V AC, 1.0A 50/60 Hz		
Operating temperature	+5°–+35°C (41°–95°F) (No condensation)		
Storage temperature	-10°–+60°C (14°–140°F) (No condensation)		
Weight	Approx. 2.9 kg (6.4 lbs)		
Connectors	Computer/Component Video:	1	Mini D-Sub 15-pin (female) Blue
	Monitor Out :	1	Mini D-Sub 15-pin (female) Black
	Audio:	1	Stereo mini jack
	Video:	1	RCA pin jack
	S-Video:	1	Mini DIN 4-pin
	Audio:	1	RCA pin jack
	Control (RS-232C) :	1	D-Sub 9-pin (male)

Safety

USA

UL1950 3rd Edition

Canada

CSA C22.2 No.950-95 (cUL)

European Community

The Low Voltage Directive (73/23/EEC)

IEC60950 2nd Edition, +Amd.1, +Amd.2, +Amd.3, +Amd.4

EMC

USA

FCC 47CFR Part15B Class B (DoC)

Canada

ICES-003 Class B

European Community

The EMC Directive (89/336/EEC)

EN55022, 1998 Class B

EN55024, 1998

IEC61000-4-2, IEC61000-4-3, IEC61000-4-4, IEC61000-4-5,

IEC61000-4-6, IEC61000-4-8, IEC61000-4-11,

IEC61000-3-2, IEC61000-3-3

Australia/New Zealand

AS/NZS 3548:1995, A1:1997, A2:1997 Class B

CISPR Pub.22:1993, A1:1995, A2:1996, Class B

Appearance

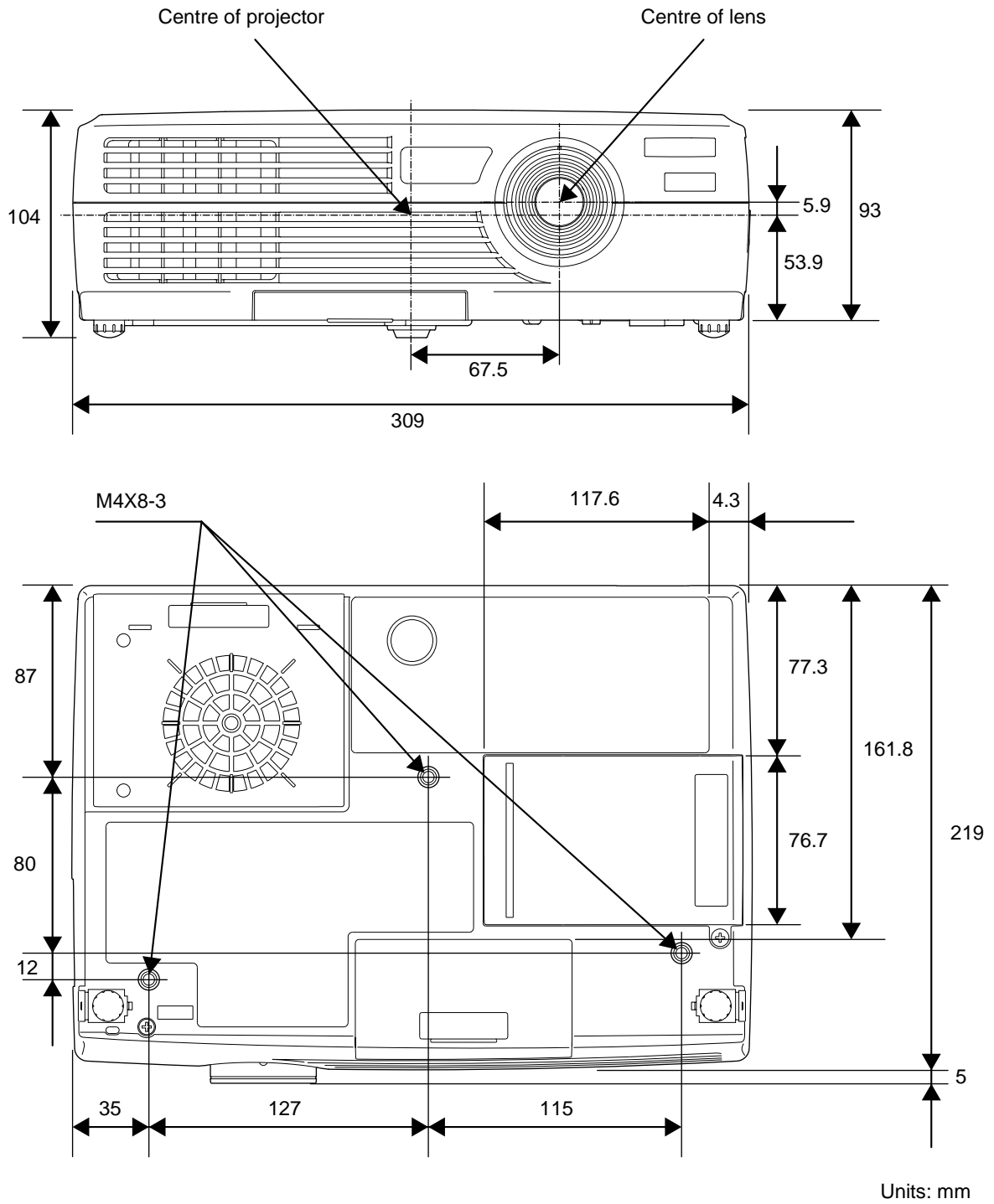

Part Names and Functions

Front/Top

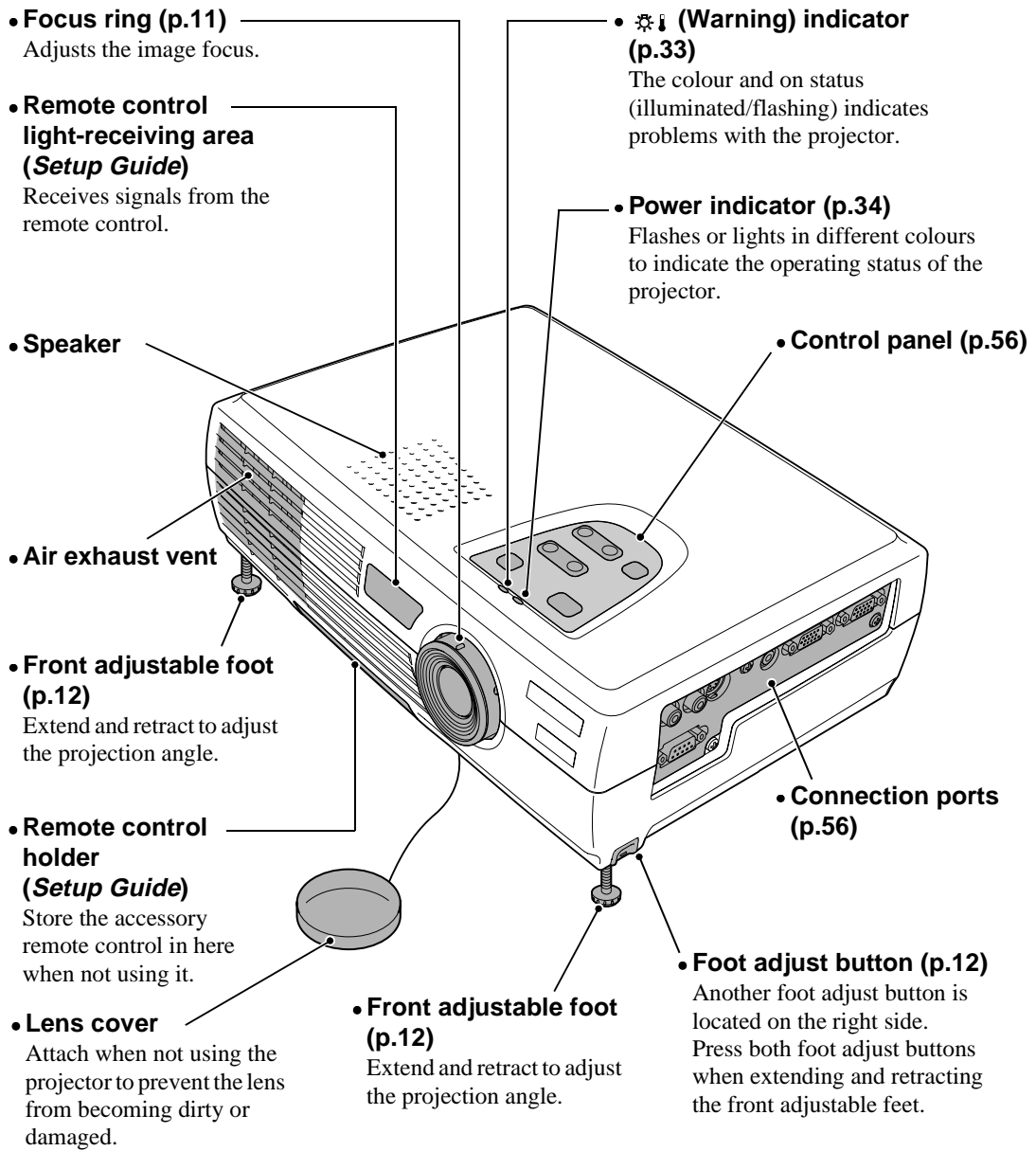

Control Panel

- **[Power] button (p.7, 9)**

Turns the projector power on and off.

- **[Help] button (p.32)**

Displays the online help menu to assist you if you have a problem.

- **[Source] button (p.7)**

Switches the input source between the Computer/Component Video port, S-Video port and Video port each time the button is pressed.

When pressed while a help menu is being displayed, it accepts the menu item that is currently selected. (p.32)

- **Zoom button (p.11)**

Press to adjust the size of the projected images. When pressed to the "W" side, the images become larger. When pressed to the "T" side, the images become smaller.

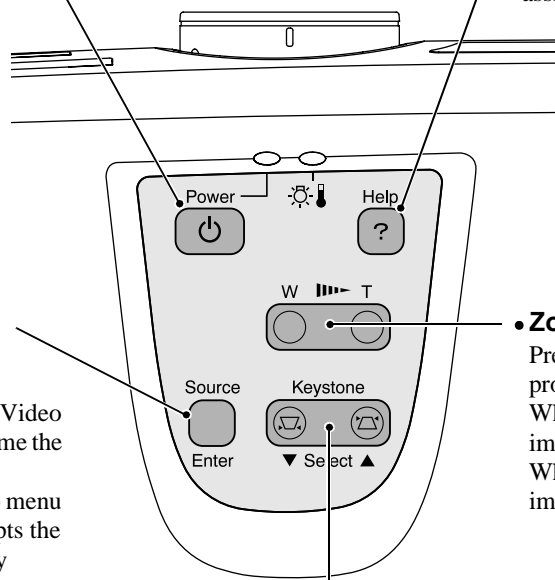

- **[Keystone] button (p.13)**

Press to correct keystone distortion in images. When pressed while a help menu is being displayed, it selects items in the menu. (p.32)

Left Side

- **S-Video port (Setup Guide)**

Inputs S-Video signals to the projector from other video sources.

- **Video port (Setup Guide)**

Inputs composite video signals to the projector from other video sources. Use the RCA video cable for this connection.

- **Audio port (Setup Guide)**

Inputs audio signals from a video source. Connect using an RCA audio cable.

- **Audio port (Setup Guide)**

Inputs audio signals from a component video or computer equipment. Connect using a stereo mini jack.

- **Computer/Component Video port (Setup Guide)**

Inputs analogue video signals from a computer and component video signals from other video sources. The connection surface is coloured blue.

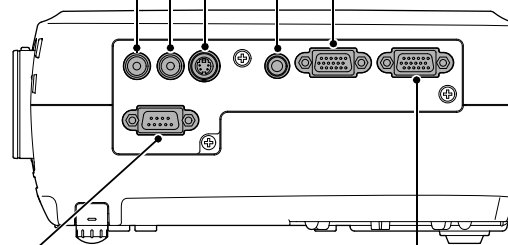

- **Control (RS-232C) port**

Connects the projector to a computer using an RS-232C cable. This port is for service use and should not be used by the customer.

- **Monitor Out port (Setup Guide)**

Outputs the projected analogue video signal from a computer to an external monitor. This feature is not available for video equipment signals. The connection surface is coloured black.



Rear

- **Remote control light-receiving area (Setup Guide)**

Receives signals from the remote control.

- **Power inlet (p.6)**

Connects the power cable.

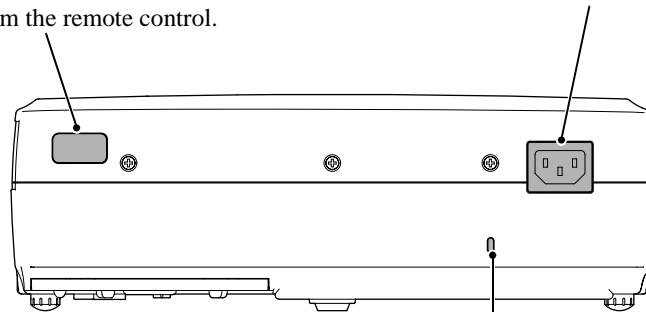

- **Security lock (A) (p.59)**

Base

- **Fixing screw holes**

These holes are for the fixing screws that are used to secure the projector.

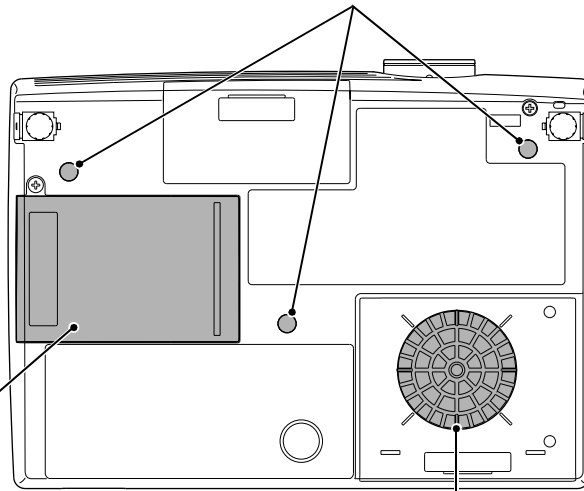

- **Lamp cover (p.46)**

Open this cover when replacing the lamp inside the projector.

- **Air filter (air intake vent) (p.44, 49)**

Prevents dust and other foreign particles from being drawn into the projector. When replacing the lamp, replace the air filter also.

Remote Control

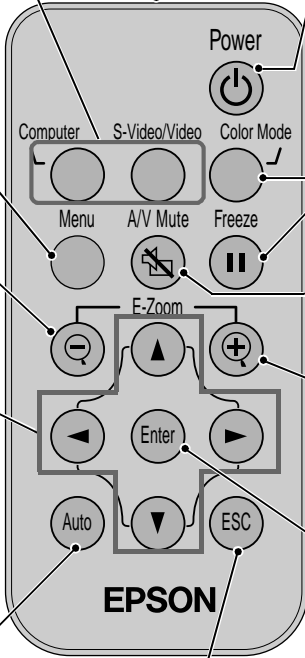
- 
- The diagram shows a grey remote control with various buttons. Callouts point to the following features:
- Input select buttons (p.7)**
 - [Computer]: Switches the signal source to the images being input from the Computer/Component Video port.
 - [S-Video/Video]: Switches the signal source being input from the S-Video port and the Video port.
 - [Menu] button (p.27)**
 - Displays or hides the configuration menus.
 - [E-Zoom] button (⊖) (p.30)**
 - Reduces the part of images that have been enlarged using the [⊕] button.
 - [▲][▼][◀][▶] buttons (p.27, 32)**
 - When a configuration menu or help menu is displayed, these buttons select menu items and setting values.
 - When using the E-Zoom function, these buttons move the cross around the screen and scroll the image.
 - [Auto] button (p.16)**
 - Use this button to automatically adjust computer images to the optimum images when automatic setup has been set to "OFF".
 - Remote control light-emitting area (Setup Guide)**
 - Outputs remote control signals.
 - [Power] button (p.7, 9)**
 - Turns the projector power on and off.
 - [Color Mode] button (p.15)**
 - Selects the colour mode. The colour mode changes in the order of Normal, Meeting, Presentation, Theatre, Game and sRGB▶▶ each time the button is pressed.
 - [Freeze] button (p.29)**
 - Keeps the current video or computer image on the screen.
 - [A/V Mute] button (p.29)**
 - Momentarily turns off the audio and video.
 - [E-Zoom] button (⊕) (p.30)**
 - Enlarges the part of images without changing the size of the projection area.
 - [Enter] button (p.27, 32)**
 - Accepts a menu item or displays the next screen or menu while viewing a configuration menu or help menu.
 - [ESC] button (p.28)**
 - Stops the current function.
 - Displays the previous screen or menu while viewing a configuration menu.

Glossary

Following is an explanation of some of the terms used in this guide which may be unfamiliar or which were not explained in the text of this guide itself. Further information can be obtained by referring to other commercially-available publications.

Aspect ratio	The ratio between an image's length and its height. HDTV images have an aspect ratio of 16:9 and appear elongated. The aspect ratio for standard images is 4:3.
Colour temperature	The temperature of an object which is emitting light. If the colour temperature is high, the colours tend to take on a bluish tinge. If the colour temperature is lower, the colours tend to take on a reddish tinge.
Component video	Video signals which have the video brightness signals and colour signals separated, in order to provide better image quality. In high-definition TV (HDTV), it refers to images which consist of three independent signals: Y (luminance signal), and Pb and Pr (colour difference signals).
Composite video	Video signals which have the video brightness signals and colour signals mixed together. The type of signals commonly used by household video equipment (NTSC, PAL and SECAM formats). The carrier signal Y (luminance signal) and chroma (colour) signal which are contained in the colour bar are overlapped to form a single signal.
Contrast	The relative brightness of the light and dark areas of an image can be increased or decreased in order to make text and graphics stand out more clearly, or to make them appear softer. Adjusting this particular property of an image is called "contrast adjustment".
Cool-down	The cooling process for the projector's lamp unit continues even after the [Power] button on the projector's control panel or the remote control has been pressed to turn off the lamp. After the lamp turns off, the cooling fan continues operating, but all button operations are disabled. The length of time that this is happening is called the "cool-down period". The cool-down period lasts for about 20 seconds. The actual time will vary depending on the external air temperature.
Dolby Digital	A sound format developed by Dolby Laboratories. Normal stereo is a 2-channel format which uses two speakers. Dolby Digital is a 6-channel (5.1-channel) system which adds to this a centre speaker, two rear speakers and a sub-woofer.
HDTV	An abbreviation for High-Definition Television. It refers to high-definition systems which satisfy the following conditions. Vertical resolution of 750p or 1125i or greater (p = <u>progressive scanning</u> , i = <u>interlaced scanning</u>) Screen <u>aspect ratio</u> of 16:9 <u>Dolby Digital</u> audio reception and playback (or output)
Interlaced scanning	A method of image scanning whereby the image data is divided into fine horizontal lines which are displayed in sequence starting from left to right and then from the top to the bottom of the screen. The even-numbered lines and odd-numbered lines are displayed alternately.
Progressive scanning	A method of image scanning whereby the image data from a single image is scanned sequentially from top to bottom to create a single image.
Refresh rate	The light-emitting element of a display maintains the same luminosity and colour for an extremely short time. Because of this, the image must be scanned many times per second in order to refresh the light-emitting element. The number of refresh operations per second is called the "refresh rate", and is expressed in hertz (Hz).
Resize display	This function is used to project computer images that have a resolution or more than or less than the projector's panel resolution to be projected so that they fill the whole of the projection area.
SDTV	An abbreviation for Standard Definition Television. It refers to standard television systems which do not satisfy the conditions for High-Definition Television.
Security lock	A device consisting of a projector case with a hole in it that a commercially-available theft-prevention cable can be passed through in order to secure the device to a table or pillar. This projector is compatible with the Microsaver Security System manufactured by Kensington.

sRGB	An international standard for colour intervals that was formulated so that colours which are reproduced by video equipment can be handled easily by computer operating systems (OS) and the Internet.
SVGA	A type of video signal with a resolution of 800 (horizontal) x 600 (vertical) dots which is used by IBM PC/AT-compatible computers.
S-Video	A video signal which has the luminance component and colour component separated in order to provide better image quality. It refers to images which consist of two independent signals: Y (luminance signal), and C (colour signal).
Sync. (Synchronisation)	The signals output from computers have a specific frequency. If the projector frequency does not match this frequency, the resulting images will not be of a good quality. The process of matching the phases of these signals (the relative position of the crests and troughs in the signal) is called "synchronisation". If the signals are not synchronized, problems such as flickering, blurriness and horizontal interference can occur.
Tracking	The signals output from computers have a specific frequency. If the projector frequency does not match this frequency, the resulting images will not be of a good quality. The process of matching the frequency of these signals (the number of crests in the signal) is called "tracking". If tracking is not carried out correctly, wide vertical stripes will appear in the projected images.
VGA	A type of video signal with a resolution of 640 (horizontal) x 480 (vertical) dots which is used by IBM PC/AT-compatible computers.
XGA	A type of video signal with a resolution of 1024 (horizontal) x 768 (vertical) dots which is used by IBM PC/AT-compatible computers.
YCbCr	The carrier signal which is contained in the colour bar signal used in modern TV transmissions. The name comes from the Y (luminance) signal and the CbCr (chroma (colour)) signals.
YPbPr	The carrier signal which is contained in the colour bar signal used in high-definition TV (HDTV) transmissions. The name comes from the Y (luminance) signal and the PbPr (colour difference) signals.

Index



General Terms

A

A/V Mute	24, 29
"About" Menu	25
"Advanced" Menu	24
Air exhaust vent	55
Air filter	57
Air intake vent	57
Analogue-RGB	23, 25
Aspect ratio	15
"Audio" Menu	23
Audio port	56, <i>Setup Guide</i>
Auto Setup	16, 22

B

Battery holder	45
Brightness	20, 22

C

Ceiling	25
Cleaning the Air Filter	44
Cleaning the EPSON Cinema Filter	44
Cleaning the Lens	44
Cleaning the Projector Case	44
Color	20
Color Adjustment	24
Color Mode	15, 21, 22
Color Mode Prompt	24
Colour temperature	24
Component video	<i>Setup Guide</i>
Composite video	<i>Setup Guide</i>
Computer/Component Video port	56
Connecting to a Computer	<i>Setup Guide</i>
Connecting to a Video Source	<i>Setup Guide</i>
Contrast	20, 22
Control (RS-232C) port	56
Control panel	56
Cool-down	9, 34
Correcting Keystone Distortion	13
Cross	30

E

Eligible computers	<i>Setup Guide</i>
EPSON cinema filter	14, 20, 22
E-Zoom	30

F

Fixing screw holes	57
--------------------------	----

Focus	11
Focus ring	55
Foot adjustment	12
Freeze	29
Frequency	25
Front adjustable foot	55

G

Glossary	59
----------------	----

H

HDTV	51
Help function	32

I

Image size	11, <i>Setup Guide</i>
Indicators	33, 55
Input Signal	21, 22, 25
Inserting the Battery	45

K

Keystone	13, 23
----------------	--------

L

Lamp	25
Lamp cover	57
Lamp replacement period	46
Language	24
Lens cover	55

M

Main menu	20
Menu	20
Monitor Out port	56

N

No-Signal Msg.	23
----------------------	----

O

Operating distance (Remote control)	<i>Setup Guide</i>
Operating range (Remote control)	<i>Setup Guide</i>
Operating temperature	52
Optional accessories	50
Overheating	33

P

Part Names and Functions	55
Port	7, 56
Position	16, 20, 22
Power cable	6
Power indicator	55

Power inlet	57
Projection.....	7
Projection angle.....	12
Projection distance.....	<i>Setup Guide</i>
Prompt	24

R

RCA video cable.....	<i>Setup Guide</i>
Rear Proj.....	25, <i>Setup Guide</i>
Refresh Rate	25
Remote control	58, <i>Setup Guide</i>
Remote control light-emitting area.....	58
Remote control light-receiving area	55, 57
Replacing the Air Filter	49
Replacing the Lamp.....	46, 47
"Reset All" Menu	26
Reset Lamp Timer	25, 48
Resized display	51
Resolution.....	25
RGB.....	24

S

Screen size	<i>Setup Guide</i>
Security lock.....	57
"Setting" Menu	23
Setting Up the Projector	<i>Setup Guide</i>
Sharpness.....	21, 22
Sleep mode	24
Speaker	55, <i>Setup Guide</i>
Specifications.....	52
Squeeze mode.....	15
sRGB	15, 21, 22
Stereo mini jack audio cable.....	<i>Setup Guide</i>
Storage temperature.....	52
Sub-menu.....	20
Supported Monitor Displays.....	51
S-Video	20, 25, <i>Setup Guide</i>
Sync	16, 18
SYNC Mode	25
SYNC Polarity.....	25

T

Tint.....	21
Tone	23
Tracking.....	16, 17
Translucent screen	<i>Setup Guide</i>
Turning off.....	9

U

Using the Configuration Menu Functions	20
--	----

V

Video.....	20, 25
"Video" Menu	20
Video port	56
Video Signal.....	21, 25
Video Source.....	25
Volume	23

W

Warning indicator.....	55
When Having Some Trouble.....	33
Wide-screen Projection.....	15

Y

YCbCr.....	7, 20, 25
YPbPr.....	7, 20, 25

Z

Zoom.....	11
-----------	----

DECLARATION of CONFORMITY

According to 47CFR, Part 2 and 15
Class B Personal Computers and Peripherals; and/or
CPU Boards and Power Supplies used with Class B
Personal Computers

We : EPSON AMERICA, INC.
Located at : 3840 Kilroy Airport Way
MS: 3-13
Long Beach, CA 90806
Tel : 562-290-5254

Declare under sole responsibility that the product identified herein, complies with 47CFR Part 2 and 15 of the FCC rules as a Class B digital device. Each product marketed, is identical to the representative unit tested and found to be compliant with the standards. Records maintained continue to reflect the equipment being produced can be expected to be within the variation accepted, due to quantity production and testing on a statistical basis as required by 47CFR 2.909. Operation is subject to the following two conditions : (1) this device may not cause harmful interference, and (2) this device must accept any interference received, including interference that may cause undesired operation.

Trade Name : EPSON
Type of Product : Projector
Model : EMP-30 / ELP-30

FCC Compliance Statement For United States Users

This equipment has been tested and found to comply with the limits for a Class B digital device, pursuant to Part 15 of the FCC Rules. These limits are designed to provide reasonable protection against harmful interference in a residential installation. This equipment generates, uses, and can radiate radio frequency energy and, if not installed and used in accordance with the instructions, may cause harmful interference to radio or television reception. However, there is no guarantee that interference will not occur in a particular installation. If this equipment does cause interference to radio and television reception, which can be determined by turning the equipment off and on, the user is encouraged to try to correct the interference by one or more of the following measures.

- Reorient or relocate the receiving antenna.
- Increase the separation between the equipment and receiver.
- Connect the equipment into an outlet on a circuit different from that to which the receiver is connected.
- Consult the dealer or an experienced radio/TV technician for help.

WARNING

The connection of a non-shielded equipment interface cable to this equipment will invalidate the FCC Certification or Declaration of this device and may cause interference levels which exceed the limits established by the FCC for this equipment. It is the responsibility of the user to obtain and use a shielded equipment interface cable with this device. If this equipment has more than one interface connector, do not leave cables connected to unused interfaces. Changes or modifications not expressly approved by the manufacturer could void the user's authority to operate the equipment.

All rights reserved. No part of this publication may be reproduced, stored in a retrieval system, or transmitted in any form or by any means, electronic, mechanical, photocopying, recording, or otherwise, without the prior written permission of SEIKO EPSON CORPORATION. No patent liability is assumed with respect to the use of the information contained herein. Neither is any liability assumed for damages resulting from the use of the information contained herein.

Neither SEIKO EPSON CORPORATION nor its affiliates shall be liable to the purchaser of this product or third parties for damages, losses, costs, or expenses incurred by purchaser or third parties as a result of: accident, misuse, or abuse of this product or unauthorized modifications, repairs, or alterations to this product, or (excluding the U.S.) failure to strictly comply with SEIKO EPSON CORPORATION's operating and maintenance instructions.

SEIKO EPSON CORPORATION shall not be liable against any damages or problems arising from the use of any options or any consumable products other than those designated as Original EPSON Products or EPSON Approved Products by SEIKO EPSON CORPORATION.

General Notice: The following trademarks and registered trademarks are the property of their respective owners and are used in this publication for identification purposes only.

- EPSON/SEIKO EPSON CORPORATION
- Macintosh, Mac, iMac/Apple Computer, Inc.
- IBM/International Business Machine Corp.
- Windows, Windows NT/Microsoft Corporation

Other product names used herein are also for identification purposes only and may be trademarks of their respective owners. EPSON disclaims any and all rights in those marks.

EPSON®

E



Printed on 100% recycled paper.



Printed in Japan
404003503
02.09-2.4A(C05)