

EPSON
EXCEED YOUR VISION

User's Guide

Multimedia Projector

EB-W6

EB-X6



EB-S6







■ Safety Indications

So that you can use the projector safely and correctly, symbols are applied in the documentation and on the projector to indicate possible harm to the user or to others and the risk of damage to property.

The indications and their meaning are as follows. Make sure you understand them properly before reading the guide.

 Warning	Indicates the possibility of death or serious injury if this symbol is ignored or if sufficient care is not taken.
 Caution	Indicates the possibility of injury or damage to property if this symbol is ignored or if sufficient care is not taken.

■ General Information Indications

Attention	Indicates procedures which may result in damage or injury if sufficient care is not taken.
	Indicates additional information and points which may be useful to know regarding a topic.
	Indicates a page where detailed information regarding a topic can be found.
	Indicates that an explanation of the underlined word or words in front of this symbol appears in the glossary of terms. See the "Glossary" section of the "Appendices".  p.98
Procedure	Indicates operating methods and the order of operations. The procedure indicated should be carried out in the order of the numbered steps.
[(Name)]	Indicates the name of the buttons on the remote control or the control panel. Example: [Esc] button
"(Menu Name)"	Indicates configuration menu items. Example: "Image" - "Brightness"

Projector Features	5
Part Names and Functions	6
Front/Top.....	6
Rear (EB-W6 only).....	7
Rear (EB-X6/S6 only).....	8
Control Panel (EB-W6/X6 only).....	9
Control Panel (EB-S6 only).....	10
Remote Control (EB-W6 only).....	11
Remote Control (EB-X6/S6 only)	13
Base.....	15

Useful Functions

Changing the Projected Image	17
Switching by Automatic Detection of Input Signal (Source Search).....	17
Direct Switching by Remote Control (EB-W6 only).....	18
Functions for Enhancing Projection	19
Selecting the Projection Quality (Selecting Color Mode)	19
Setting Auto Iris.....	21
Hiding the Image and Sound Temporarily (A/V Mute)	22
Freezing the Image (Freeze).....	23
Changing the Aspect Ratio	24
Enlarging Part of the Image (E-Zoom)	29
Security Functions	31
Managing Users (Password Protect)	31
Restricting Operation (Control Panel Lock).....	34
Anti-Theft Lock.....	35

Configuration Menu

Using the Configuration Menu (For EB-W6)	37
Using the Configuration Menu (For EB-X6)	38
Using the Configuration Menu (For EB-S6)	39
List of Functions	40
Image Menu	40
Signal Menu	41
Settings Menu	43
Extended Menu	44
Info Menu (Display only)	46
Reset Menu.....	47

Troubleshooting

Using the Help	49
Problem Solving	51
Reading the Indicators.....	51
When the Indicators Provide No Help.....	55

Appendices

Installation Methods	64
Cleaning	65
Cleaning the Projector's Surface	65
Cleaning the Lens.....	65
Cleaning the Air Filter and Air Intake Vent.....	65
Replacing Consumables	66
Replacing the Remote Control Batteries	66
Replacing the Lamp.....	67
Replacing the Air Filter	71
Saving a User's Logo	72
Screen Size and Distance	75
EB-W6	75
EB-X6	76
EB-S6	77
Connecting to External Equipment	78
Connecting to an External Monitor (EB-X6/S6 only).....	78
Connecting and Removing a USB Device (EB-W6 only)	79
Connecting a USB Device	79
Reading the Indicators.....	79
Removing a USB Device	79
Inserting and Ejecting a SD Card (EB-W6 only)	80
Inserting a SD Card	80
Reading the SD Card Access Lamp	80
Ejecting a SD Card	81
Connecting with USB Cable for Projection (USB Display)	82
How to Connect (For EB-W6)	82
How to Connect (For EB-X6/S6).....	83
Connecting a USB Cable	86
Page Up/Down by Remote Control.....	86
Operating the Mouse Pointer by Remote Control (Wireless Mouse function) ...	87



Using Slideshow (EB-W6 only)90
 Image Files that can be Projected in a Slideshow 90
 Basic Slideshow Operations 90
 Setting Image File Display and Slideshow 95

Optional Accessories and Consumables97

Glossary98

ESC/VP21 Commands100
 Command List 100
 Cable Layouts 100
 USB Connection Setup 101

List of Supported Monitor Displays102
 EB-W6 102
 EB-X6 105
 EB-S6 107

Specifications109
 Specifications 109
 Operating Requirements of Supplied Software 112

Appearance113

Index114

Ease of use

■ The A/V mute slide makes it easy to project and store

You can stop and resume projection easily by opening and closing the A/V mute slide which makes giving clear presentations easier.

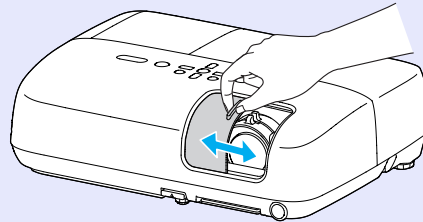

■ A single foot design means you do not have to make any difficult levelling adjustments

You can easily make height adjustments with one hand.

☛ *Quick Start Guide*

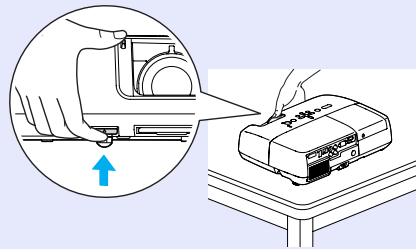

■ Connecting with USB cable for projection (USB Display)

You can project what's on the computer screen simply by connecting a Windows computer with a USB cable.

☛ *Quick Start Guide*

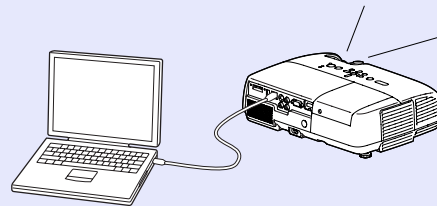

■ Projecting images from a USB storage device or SD card without using a computer (EB-W6 only)

Connect the USB storage device or SD card to the projector, and you can project JPEG images of photographs shot with a digital camera and so on, as a slideshow. This makes projection easy, since it is not necessary to connect a computer. ☛ [p.90](#)

Enhanced security functions

■ Password Protect to restrict and manage users

By setting a password you can restrict who can use the projector. ☛ [p.31](#)

■ Control Panel Lock restricts button operation on the control panel

You can prevent people from changing the settings on the projector without permission. ☛ [p.34](#)

■ Equipped with various anti-theft devices

The projector is equipped with the following security devices. ☛ [p.35](#)

- Security slot
- Security cable installation point

Easy to handle

■ Direct power On/Off

In places where power is managed centrally, such as in a conference room, the projector can be set to power on and off automatically when the power source to which the projector is connected is switched on or off.

■ No cool down delay

After turning the projector's power off, you can disconnect the projector's power cable without having to wait for the projector to cool down first.

Front/Top

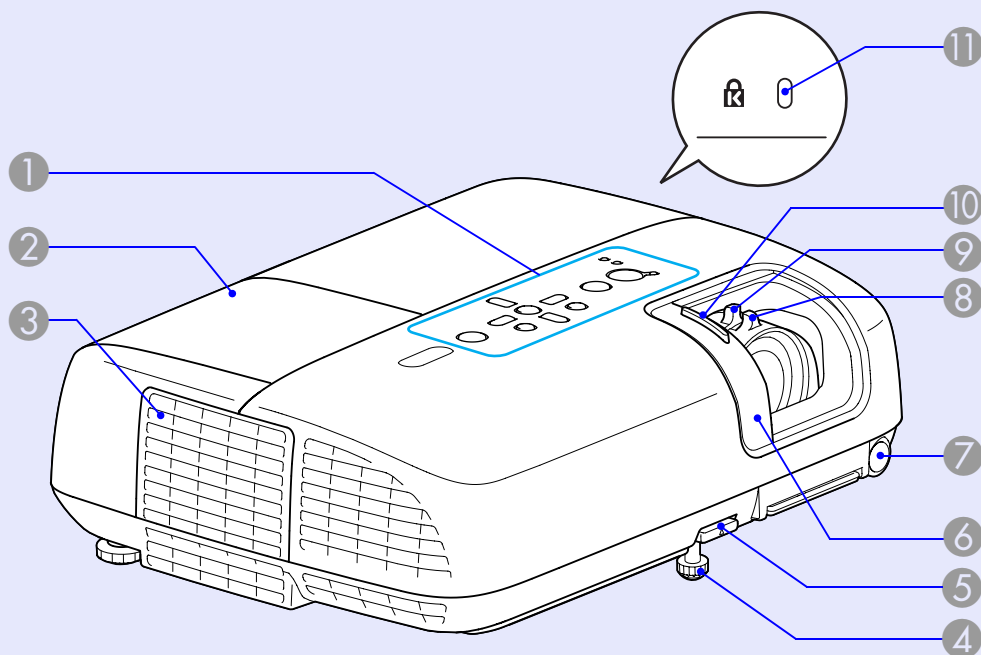

Name	Function
① Control panel	☞ p.9
② Lamp cover	Open this cover when replacing the projector's lamp. ☞ p.68
③ Air exhaust vent	<p>⚠ Caution</p> <p>Do not place objects that may become warped or otherwise affected by heat near the air exhaust vent and do not put your face or hands near the air exhaust vent while projection is in progress.</p>

Name	Function
④ Front adjustable feet	Extend and adjust the position of the projected image when the projector is placed on a surface such as a desk. ☞ Quick Start Guide
⑤ Foot adjust lever	Pull out the foot lever to extend and retract the front foot. ☞ Quick Start Guide
⑥ A/V mute slide	Slide shut when not using the projector to protect the lens. By closing during projection you can hide the image and the sound (A/V Mute). ☞ Quick Start Guide, p.22
⑦ Remote receiver	Receives signals from the remote control. ☞ Quick Start Guide
⑧ Focus ring	Adjusts the image focus. ☞ Quick Start Guide
⑨ Zoom ring (EB-W6/X6 only)	Adjusts the image size. ☞ Quick Start Guide
⑩ A/V mute slide knob	Slide the knob to open and close the A/V mute slide.
⑪ Security slot (🔒)	The security slot is compatible with the Microsaver Security System manufactured by Kensington. ☞ p.35

Rear (EB-W6 only)

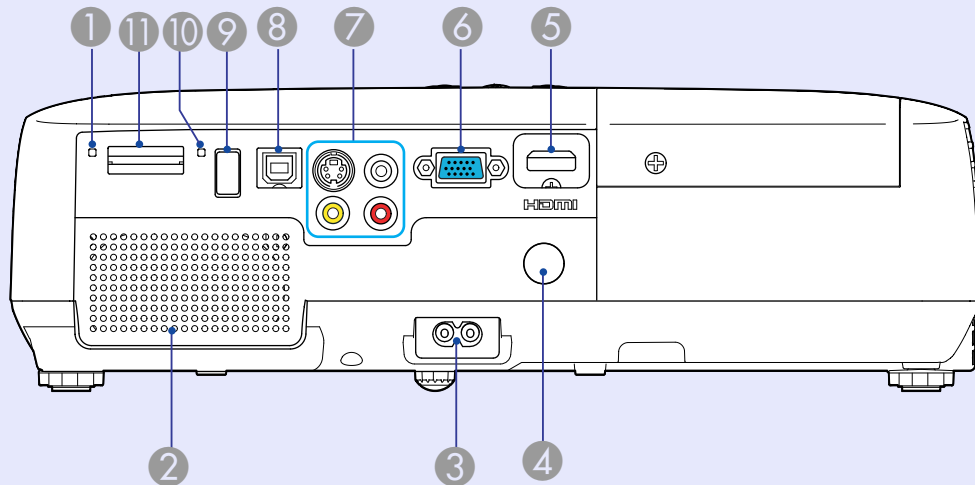

Name	Function
1 SD Card Access Lamp	Displays SD card access status. p.80
2 Speaker	
3 Power inlet	Connects to the power cable. Quick Start Guide
4 Remote receiver	Receives signals from the remote control. Quick Start Guide
5 HDMI input port	For signals from a computer or HDMI-compatible video sources. Quick Start Guide
6 Computer input port	For video signals from a computer and <u>component video</u> signals from other video sources.

Name	Function
7 S-Video input port	For <u>S-video</u> signals from video sources.
Video input port	For <u>composite video</u> signals from video sources.
Audio input port	Connects to the audio output port of the equipment you want to project from and inputs the audio. Quick Start Guide
8 USB port (Type B)	You can use a number of functions by connecting a computer via a USB cable and making connection settings. <ul style="list-style-type: none"> • Connect to a computer by USB cable to project images from the computer. p.82 • You can Page Up/Down and operate a mouse pointer using the remote control. You can also use this port to control the projector from a computer. p.86
9 USB port (Type A)	Connect a digital camera or USB storage device to project a slideshow of images stored on the device. p.79, 90
10 USB indicator	Indicates the status of USB port (Type A) by flashing or being lit. p.79
11 SD card slot	Insert an SD card, and project a stored image file as a slideshow. p.80, 90

Rear (EB-X6/S6 only)

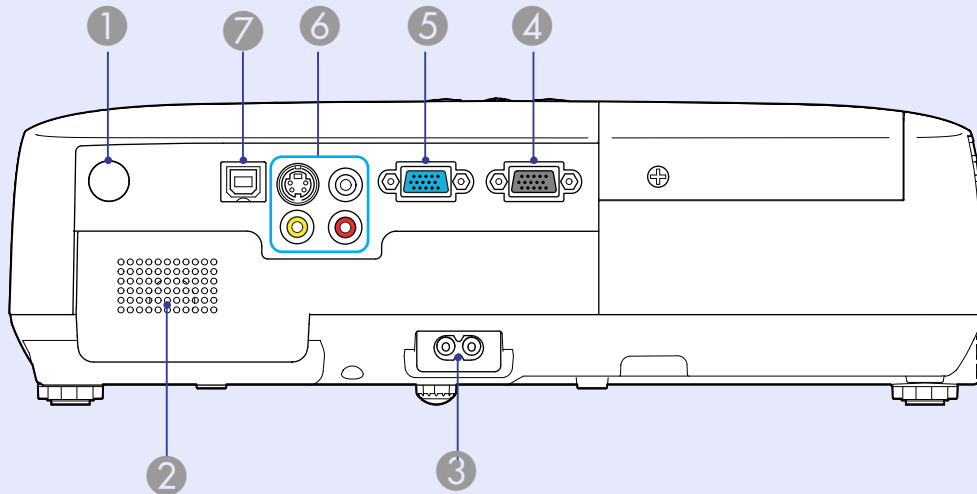







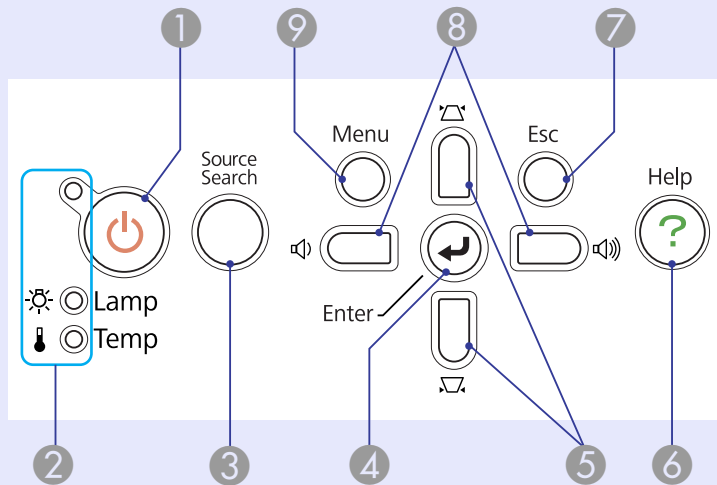









Name	Function
① Remote receiver	Receives signals from the remote control. ☛ Quick Start Guide
② Speaker	
③ Power inlet	Connects to the power cable. ☛ Quick Start Guide
④ Monitor Out port	Outputs the image signal from the computer connected to the Computer input port to an external monitor. This is not available for <u>component video</u> signals or other signals being input to any port other than the Computer input port.

Name	Function
⑤ Computer input port	For video signals from a computer and <u>component video</u> signals from other video sources.
⑥ S-Video input port	For <u>S-video</u> signals from video sources.
Video input port	For <u>composite video</u> signals from video sources.
Audio input port	Connects to the audio output port of the equipment you want to project from and inputs the audio. ☛ Quick Start Guide
⑦ USB port (Type B)	You can use a number of functions by connecting a computer via a USB cable and making connection settings. <ul style="list-style-type: none"> • Connect to a computer by USB cable to project images from the computer. ☛ p.82 • You can Page Up/Down and operate a mouse pointer using the remote control. You can also use this port to control the projector from a computer. ☛ p.86

Control Panel (EB-W6/X6 only)









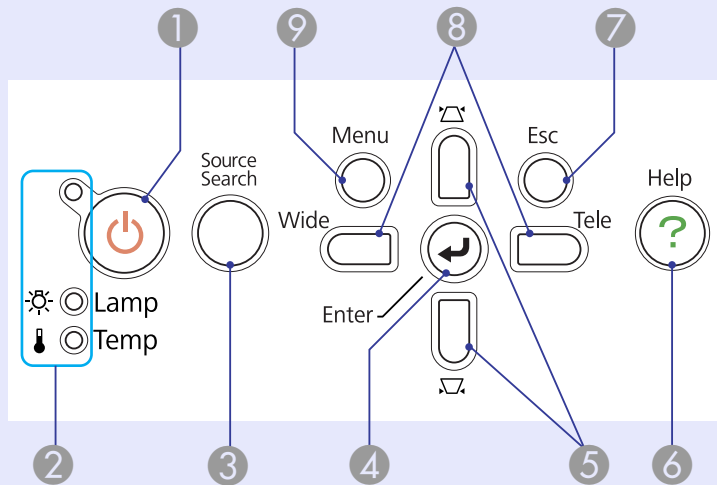

Name	Function
1 [Power] button	Turns the projector power on or off.  Quick Start Guide
2 Status indicators	The color of the indicators and whether they are flashing or lit indicates the status of the projector.  p.51
3 [Source Search] button	Changes to the next input source that is connected to the projector and is sending an image.  p.17

Name	Function
4 [Enter] button	If pressed during projection of computer signal images, it automatically adjusts the tracking, synchronization, and position to project the optimum image. When a configuration menu or a help screen is displayed, it accepts and enters the current selection and moves to the next level. EB-W6  p.37 , EB-X6  p.38
5 [Up] [Down] buttons	Corrects keystone distortion. If pressed when a configuration menu or a help screen is displayed, these buttons select menu items and setting values.  Quick Start Guide , EB-W6  p.37 , EB-X6  p.38
6 [Help] button	Displays and closes the help screen which shows you how to deal with problems if they occur.  p.49
7 [Esc] button	Stops the current function. If pressed when a configuration menu is displayed, it moves to the previous menu level. EB-W6  p.37 , EB-X6  p.38
8 [Left] [Right] buttons	Press to adjust the volume. If pressed when a configuration menu or a help screen is displayed, these buttons select menu items and setting values.  Quick Start Guide , EB-W6  p.37 , EB-X6  p.38
9 [Menu] button	Displays and closes the configuration menu. EB-W6  p.37 , EB-X6  p.38

Control Panel (EB-S6 only)









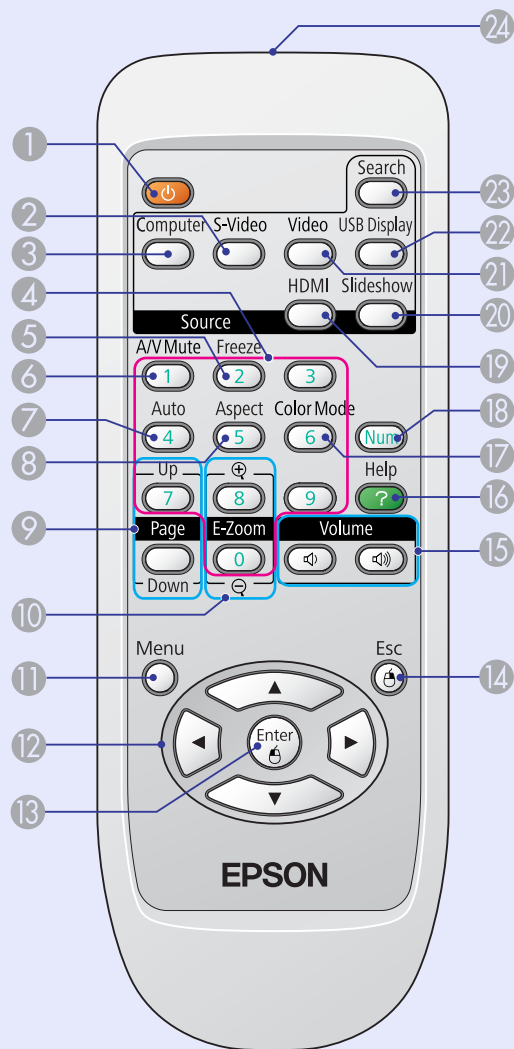





















Name	Function
1 [Power] button	Turns the projector power on or off.  Quick Start Guide
2 Status indicators	The color of the indicators and whether they are flashing or lit indicates the status of the projector.  p.51
3 [Source Search] button	Changes to the next input source that is connected to the projector and is sending an image.  p.17
4 [Enter] button	If pressed during projection of computer signal images, it automatically adjusts the tracking, synchronization, and position to project the optimum image. When a configuration menu or a help screen is displayed, it accepts and enters the current selection and moves to the next level.  p.39







Name	Function
5 [Left Arrow] [Right Arrow] buttons	Corrects keystone distortion. If pressed when a configuration menu or a help screen is displayed, these buttons select menu items and setting values.  Quick Start Guide, p.39
6 [Help] button	Displays and closes the help screen which shows you how to deal with problems if they occur.  p.49
7 [Esc] button	Stops the current function. If pressed when a configuration menu is displayed, it moves to the previous menu level.  p.39
8 [Wide] [Tele] buttons	Press to adjust Tele/Wide. Press [Tele] to make the projected image size smaller, and press [Wide] to make it larger. If pressed when a configuration menu or a help screen is displayed, these buttons select menu items and setting values.  Quick Start Guide, p.39
9 [Menu] button	Displays and closes the configuration menu.  p.39

Remote Control (EB-W6 only)











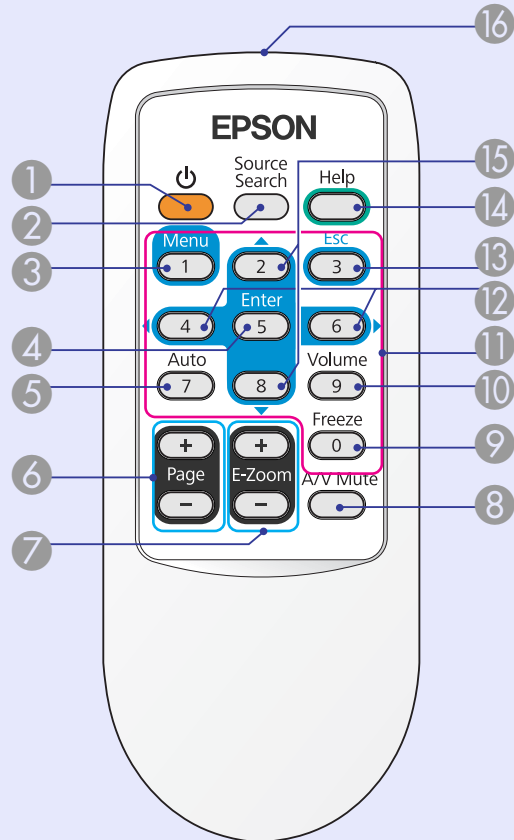





Name	Function
① [Power] button	Turns the projector power on or off.  Quick Start Guide
② [S-Video] button	Changes to images from the S-Video input port.  p.18
③ [Computer] button	Changes to images from the Computer input port.  p.18
④ Numeric buttons	Use these buttons when entering a password.  p.31
⑤ [Freeze] button	Images are paused or unpaused.  p.23
⑥ [A/V Mute] button	Turns the video and audio on or off.  p.22
⑦ [Auto Setup] button	If pressed during projection of computer signal images, it automatically adjusts the tracking, synchronization, and position to project the optimum image.
⑧ [Aspect] button	The <u>aspect ratio</u>  changes each time the button is pressed.  p.24
⑨ [Page] buttons (+) (-)	You can Page Up/Down between pages projected by USB display.  p.82 <ul style="list-style-type: none"> • Page Up/Down between slides of a slideshow can be made.  p.90 • Page Up/Down is enabled when the projector is connected to a computer with a USB cable.  p.86
⑩ [E-Zoom] buttons (+) (-)	(+) Enlarges the image without changing the projection size. (-) Reduces parts of the image that have been enlarged using the [+]  p.29













Name	Function
11 [Menu] button	Displays and closes the configuration menu.  p.37
12  button	If pressed when a configuration menu or a help screen is displayed, these buttons select menu items and setting values.  p.37, 49 Select an item or photograph during slideshow projection.  p.90 When using the Wireless Mouse function, the mouse pointer moves in the direction you press the button.  p.87
13 [Enter] button	When a configuration menu or a help screen is displayed, it accepts and enters the current selection and moves to the next level.  p.37, 49 When using the Wireless Mouse function, this functions as the left mouse button.  p.87
14 [Esc] button	Stops the current function. If pressed when a configuration menu is displayed, it moves to the previous level.  p.37, 49 When using the Wireless Mouse function, this functions as the right mouse button.  p.87
15 [Volume] buttons  	 Lowers the volume.  Raises the volume.  Quick Start Guide
16 [Help] button	Displays and closes the help screen which shows you how to deal with problems if they occur.  p.49
17 [Color Mode] button	Each time the button is pressed, the color mode changes.  p.19

Name	Function
18 [Num] button	Use these buttons when entering a password.  p.31
19 [HDMI] button	Changes to images from the HDMI input port.  p.18
20 [Slideshow] button	Changes to slideshow images.  p.18
21 [Video] button	Changes to images from the Video input port.  p.18
22 [USB Display] button	Changes to USB Display images.  p.18
23 [Source Search] button	Changes to the next input source that is connected to the projector and is sending an image.  p.17
24 Remote control light-emitting area	Outputs remote control signals.  Quick Start Guide

Remote Control (EB-X6/S6 only)



Name	Function
1 [Power] button	Turns the projector power on or off.  Quick Start Guide
2 [Source Search] button	Changes to the next input source that is connected to the projector and is sending an image.  p.17
3 [Menu] button	Displays and closes the configuration menu. EB-X6  p.38 , EB-S6  p.39
4 [Enter] button	When a configuration menu or a help screen is displayed, it accepts and enters the current selection and moves to the next level. EB-X6  p.38 , EB-S6  p.39 When using the Wireless Mouse function, this functions as the left mouse button.  p.87
5 [Auto Setup] button	If pressed during projection of computer signal images, it automatically adjusts the tracking, synchronization, and position to project the optimum image.  p.41
6 [Page] buttons (+) (-)	You can Page Up/Down between pages projected by USB Display.  p.82 Page Up/Down is enabled when the projector is connected to a computer with a USB cable.  p.86
7 [E-Zoom] button (+) (-)	(+) Enlarges the image without changing the projection size. (-) Reduces parts of the image that have been enlarged using the [+] button.  p.29
8 [A/V Mute] button	Turns the video and audio on or off.  p.22
9 [Freeze] button	Images are paused or unpaused.  p.23

Name	Function
⑩ [Volume] button	The volume adjustment screen is displayed. You can adjust the volume by pressing the [◀]/[▶] buttons.
⑪ Numeric buttons	Use these buttons when entering a password.  p.32
⑫ [◀] [▶] buttons	If pressed when a configuration menu or a help screen is displayed, these buttons select menu items and setting values.  Quick Start Guide , EB-X6  p.38 , EB-S6  p.39 When using the Wireless Mouse function, the mouse pointer moves in the direction you press the button.  p.87
⑬ [Esc] button	Stops the current function. If pressed when a configuration menu is displayed, it moves to the previous level. EB-X6  p.38 , EB-S6  p.39 When using the Wireless Mouse function, this functions as the right mouse button.  p.87
⑭ [Help] button	Displays and closes the help screen which shows you how to deal with problems if they occur.  p.49
⑮ [▲] [▼] button	If pressed when a configuration menu or a help screen is displayed, these buttons select menu items and setting values. EB-X6  p.38 , EB-S6  p.39 When using the Wireless Mouse function, the mouse pointer moves in the direction you press the button.  p.87

Name	Function
⑯ Remote control light-emitting area	Outputs remote control signals.  Quick Start Guide

Base

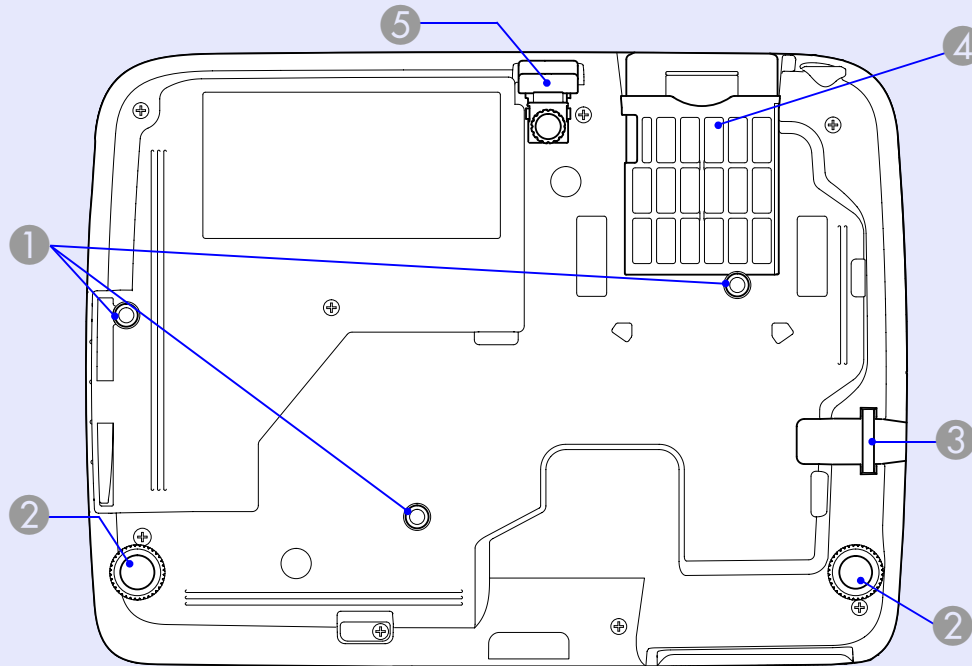

Name	Function
4 Air filter (Air intake vent)	This prevents dust and other foreign particles from getting inside the projector when air is drawn in. The projector displays a warning message when it is time to clean or replace the air filter. p.65, 71
5 Front adjustable feet	p.6

Name	Function
1 Suspension bracket fixing points (3 points)	Attach the optional ceiling mount here when suspending the projector from a ceiling. p.64, 97
2 Rear foot (2 points)	Turn to extend and retract to adjust the horizontal tilt. Quick Start Guide
3 Security cable installation point	Pass a commercially available anti-theft wire lock through here when you want to secure the projector to a fixed object. p.35



Useful Functions

This chapter explains useful functions for giving presentations and so on, and the security functions.

Changing the Projected Image 17

- **Switching by Automatic Detection of Input Signal (Source Search)17**
- **Direct Switching by Remote Control (EB-W6 only).....18**

Functions for Enhancing Projection 19

- **Selecting the Projection Quality (Selecting Color Mode)19**
 - Changing color mode by remote control (EB-W6 only)..... 19
 - Changing color mode with the configuration menu20
- **Setting Auto Iris21**
- **Hiding the Image and Sound Temporarily (A/V Mute)22**
- **Freezing the Image (Freeze).....23**

• **Changing the Aspect Ratio 24**

- Switching methods 24
- Changing the aspect ratio of video equipment images 25
- Changing the aspect of computer images (For EB-X6/S6) 26
- Changing the aspect of computer image/HDMI image (For EB-W6) 27

• **Enlarging Part of the Image (E-Zoom) 29**

Security Functions31

- **Managing Users (Password Protect)..... 31**
 - Type of Password Protect 31
 - Setting Password Protect..... 31
 - Entering the Password..... 33
- **Restricting Operation (Control Panel Lock) 34**
- **Anti-Theft Lock 35**
 - Installing the wire lock..... 35

Use the following methods to switch images for projection.

- Switching by source search
The projector automatically detects signals being input from connected equipment, and the image being input from the equipment is projected.
- Direct switching (EB-W6 only)
Switch by pressing the button for the target input port on the remote control.

Switching by Automatic Detection of Input Signal (Source Search)

You can project the target image quickly because the [Source Search] button skips input ports where no image is being input.

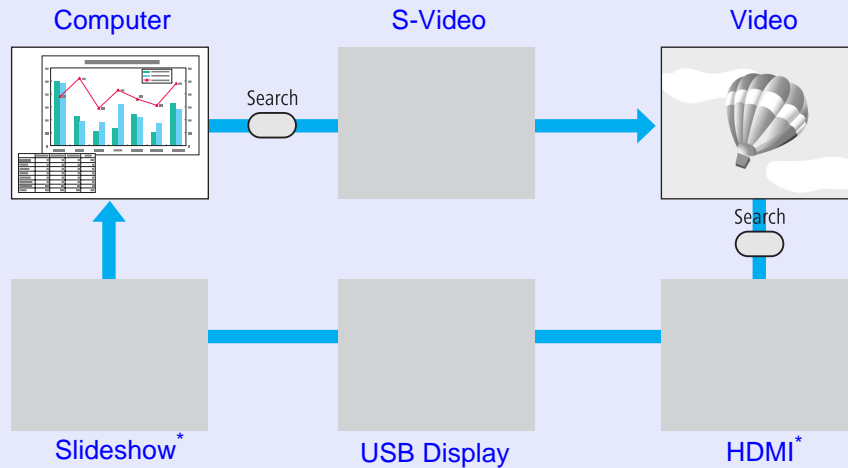

* Switching to HDMI and Slideshow are only available with EB-W6.

Procedure

When your video equipment is connected, start playback before beginning this operation.

Using the remote control

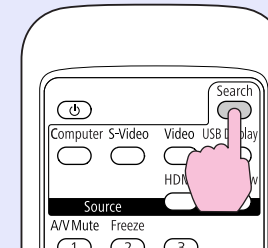

EB-W6

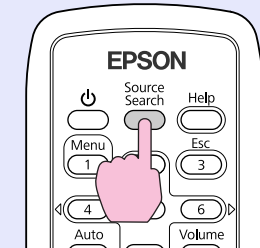

EB-X6/S6

Using the control panel

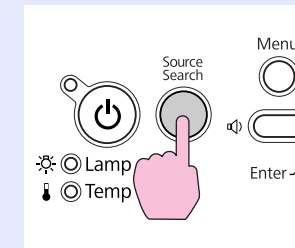

EB-W6/X6

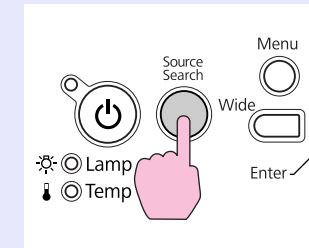

EB-S6

When two or more pieces of equipment are connected, press the [Source Search] button until the target image is projected.



The following screen showing the status of image signals is displayed when only the image that the projector is currently displaying is available, or when no image signal can be found. You can select the input port where the connected equipment you want to use is projecting. If no operation is performed after about 10 seconds, the screen closes.

EB-W6

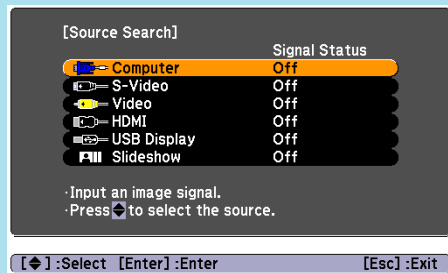

Direct Switching by Remote Control (EB-W6 only)

You can switch directly to the targeted source by pressing a button on the remote control.

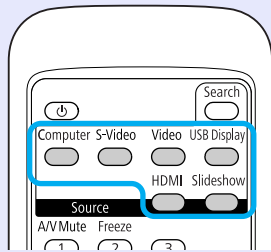

Refer to the following for button operation. [p.11](#)

Selecting the Projection Quality (Selecting Color Mode)

You can easily obtain the optimum image quality simply by selecting the setting that best corresponds to your surroundings when projecting. The brightness of the image varies depending on the mode selected.

Mode	Application
Game	Ideal for use in a bright room. This is the brightest mode and reproduces shadow tones well.
Presentation	Ideal for making presentations using color materials in a bright room.
Text	Ideal for making presentations using black-and-white materials in a bright room.
Theater	Ideal for watching films in a dark room. This gives images a natural tone.
Photo ^{*1}	Ideal for projecting still pictures, such as photos, in a bright room. This makes images vivid and brings them into contrast.
Sports ^{*2}	Ideal for watching TV programmes in a bright room. This makes images vivid and brings them to life.
sRGB ^{▶▶}	Ideal for images that conform to the sRGB color standard.
Blackboard	Even if you are projecting onto a blackboard (greenboard), this setting gives your images a natural tint, just like when projecting onto a screen.

*1 Selectable only with the following signal inputs.
Computer, HDMI Digital-RGB (EB-W6 only), USB Display, Slideshow (EB-W6 only)

*2 Selectable only with the following signal inputs.
Component video, S-Video, composite video, HDMI component (EB-W6 only)

■ Changing color mode by remote control (EB-W6 only)

Procedure

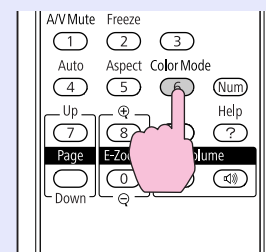

Each time you press the button, the color mode name is displayed on the screen and the color mode changes.

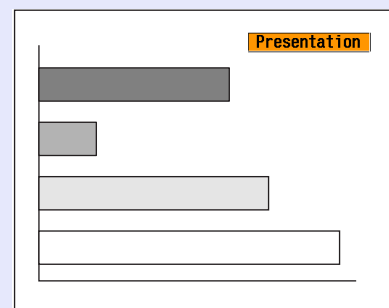

If you press the button while the color mode name is displayed on the screen, it changes to the next color mode.

■ Changing color mode with the configuration menu

Procedure

1 Press the [Menu] button and select "Image" - "Color Mode" in the configuration menu.

- EB-W6 p.37
- EB-X6 p.38
- EB-S6 p.39

2 Select a Color Mode name.

3 Press the [Menu] button to close the configuration menu.

Using the remote control

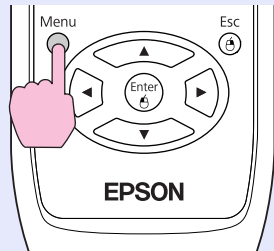

EB-W6

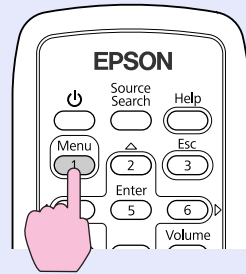

EB-X6/S6

Using the control panel

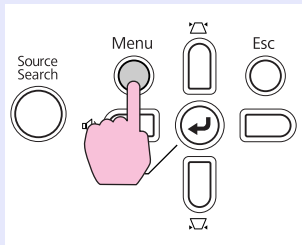

EB-W6/X6

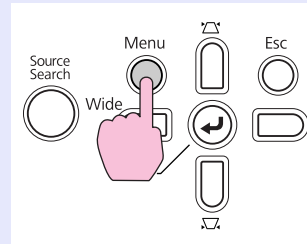

EB-S6

Setting Auto Iris

By automatically setting the luminance according to the brightness of the displayed image, it lets you enjoy deep and rich images.

Procedure

- 1 Press the [Menu] button and select "Image" - "Auto Iris" in the configuration menu.

EB-W6 p.37

EB-X6 p.38

EB-S6 p.39

Using the remote control

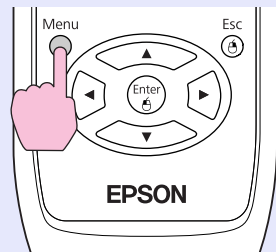

EB-W6

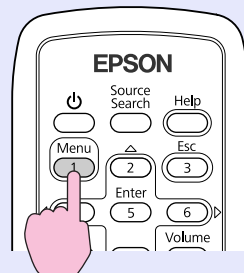

EB-X6/S6

Using the control panel

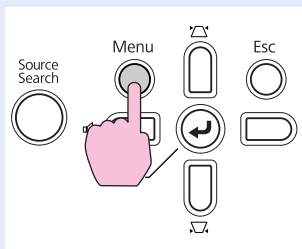

EB-W6/X6

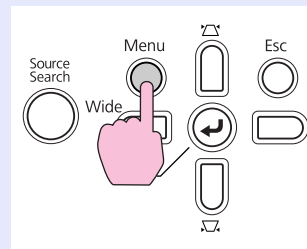

EB-S6



- 2 Select "On".

The set value is stored for each color mode.



- 3 Press the [Menu] button to close the configuration menu.



This item can be selected only when "Game" or "Theater" is selected as the "Color Mode" setting in the "Image" menu.

Hiding the Image and Sound Temporarily (A/V Mute)

You can use this when you want to focus the audience's attention on what you are saying, or if you do not want to show details such as when you are changing between files during presentations from a computer.

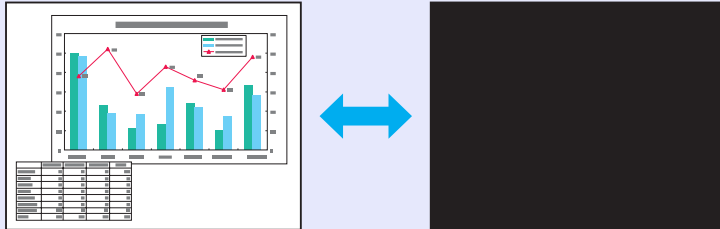

Procedure

Remote control

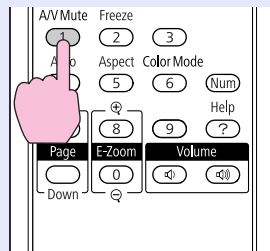

EB-W6

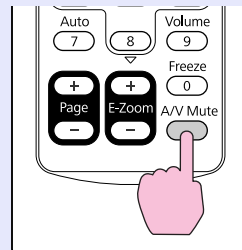

EB-X6/S6

Projector

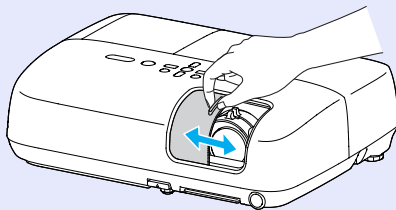

Each time you press the button, or the A/V mute slide is opened or closed, A/V Mute turns on or off.



- *If you use this function when projecting moving images, the images and sound continue to be played back by the source, and you cannot return to the point where A/V Mute was activated.*
- *From the remote control you can choose to display black, blue, or logo as the A/V mute display using the "Extended" - "Display" - "A/V Mute" setting in the configuration menu. [p.44](#)*
- *When the A/V mute slide is closed and A/V Mute begins, the power supply can be set to automatically turn off after about 30 minutes by setting "Extended" - "Operation" - "Lens Cover Timer" in the configuration menu. [p.45](#)*

Freezing the Image (Freeze)

When the moving image on the screen is frozen, the image continues to project, so you can project a moving image one frame at a time like a still photo. Also, you can perform operations such as changing between files during presentations from a computer without projecting any images if the Freeze function is activated beforehand.

Procedure

Remote control

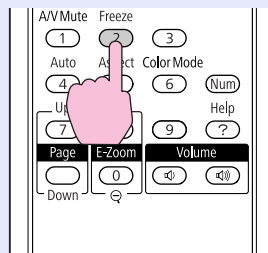

EB-W6

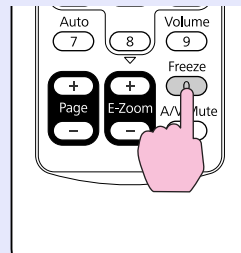

EB-X6/S6



Each time you press the button, Freeze turns on or off.



- **Audio does not stop.**
- **The image source continues to play back the moving images even while the screen is frozen, so it is not possible to resume projection from the point where it was paused.**
- **If the [Freeze] button is pressed while the configuration menu or a help screen is displayed, the menu or help screen being displayed is cleared.**
- **Freeze still works while E-Zoom is being used.**

Changing the Aspect Ratio

When you connect video equipment and project images that have been recorded in digital video or onto DVDs in 16:9 wide-screen format, change the aspect ratio. Changing the aspect ratio is also required when you want to project computer images at full size.

Switching methods and types of aspect ratio are as follows.

Switching methods

Procedure

EB-W6

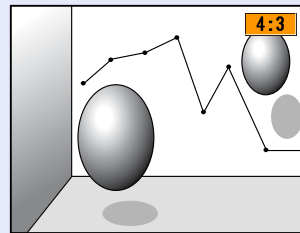
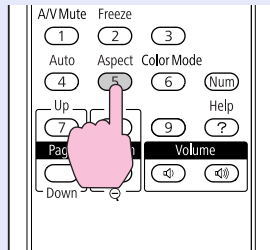

Each time you press the button, the aspect name is displayed on the screen and the aspect changes.

If you press the button while the aspect name is displayed on the screen, it changes to the next aspect mode.



This can also be set using "Aspect" from the "Signal" menu in the configuration menu. p.41

EB-X6/S6



Press the [Menu] button and select "Signal" - "Aspect" from the configuration menu.

EB-X6 p.38

EB-S6 p.39

Using the remote control

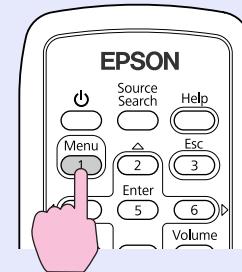

Using the control panel

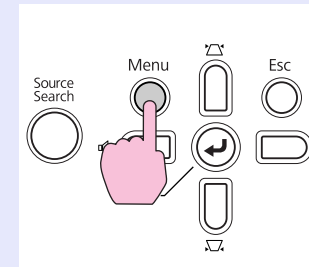

EB-X6

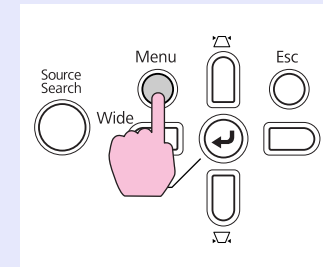

EB-S6

2 Press the [Enter] button to display the "Aspect" screen.

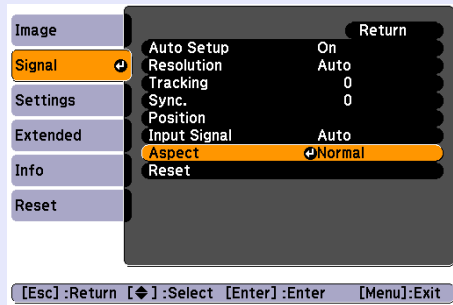

3 Select the aspect ratio and press the [Enter] button.

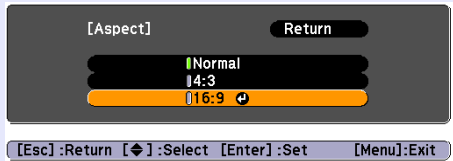

Your selected aspect is set.

■ Changing the aspect ratio of video equipment images

EB-X6/S6

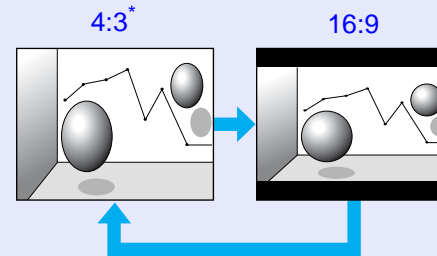

* During 720p/1080i signal input, the display has a zoom ratio of 4:3 (display of image with left and right cut off).

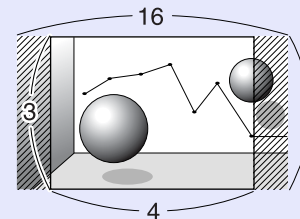

EB-W6

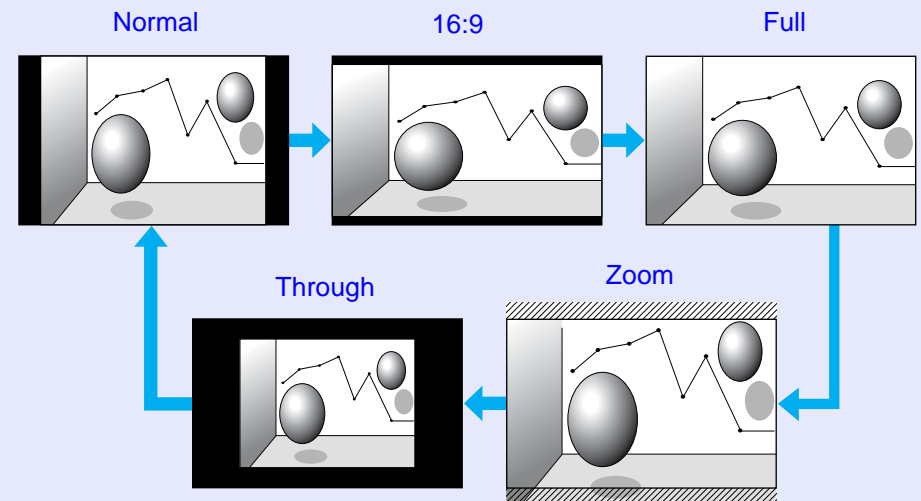

■ **Changing the aspect of computer images (For EB-X6/S6)**

When projecting input images from the Computer Input port, the aspect ratio can be changed as follows.

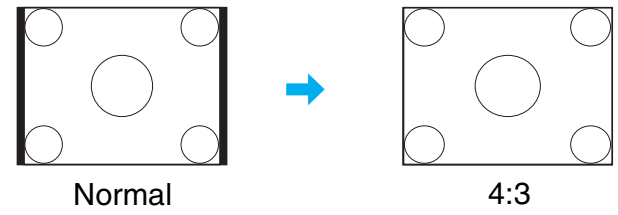
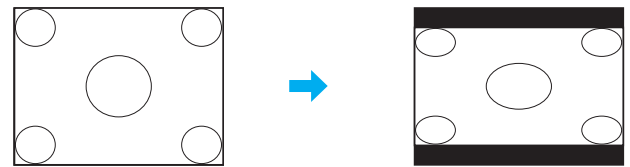
Setting		Explanation	Projection example
Normal	During image input from Computer Input port	Projects to the full projection size retaining the aspect of the input image.	
4:3		Projects to the full projection size at an aspect of 4:3. Apply when you want to project images with a 5:4 aspect ratio (1280 × 1024, etc.) at full projection size.	During 1280 × 1024 signal input 
16:9		Projects at aspect ratio 16:9. Apply when you want to project a full screen on a 16:9 screen.	During 1280 × 1024 signal input 



When some portions of an image are missing or not all of the image can be projected during computer image projection, set "Resolution" in the configuration menu to "Wide" or "Normal" according to the panel size of the computer. [p.41](#)

■ **Changing the aspect of computer image/HDMI image (For EB-W6)**

When projecting input images from the Computer input port or HDMI input port, the aspect ratio can be changed as follows. For EB-W6 the projection size is 1280 x 800 dots (aspect ratio 16:10) due to WXGA panel resolution. When projecting on to 16:9 screens, set the aspect to "16:9".

Setting		Explanation	Projection example
Normal	During image input from Computer input port	Projects to the full projection size retaining the aspect of the input image.	During 1024 × 768 signal input
Auto	During image input from HDMI input port	Projects in an appropriate aspect based on information from the signal being input.	During 1280 × 800 signal input
16:9		Projects to the full projection size at an aspect of 16:9.	During 1024 × 768 signal input
Full		Projects to full projection size.	During 1024 × 768 signal input

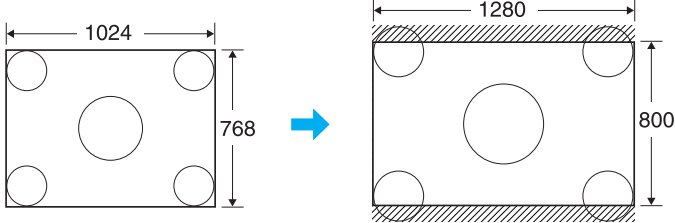
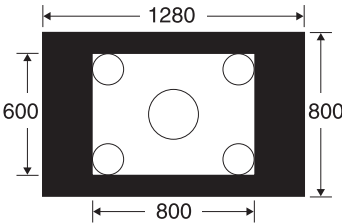
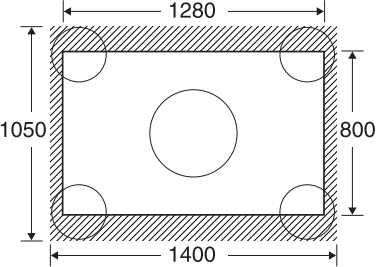
Setting	Explanation	Projection example	
Zoom	Projects to full projection size in the lateral direction retaining the aspect ratio of input image. Parts that extend beyond the projection size are not projected.	During 1024 × 768 signal input 	
Through	Projects at the resolution of the input image size to the center of the screen. This is ideal for clearer projection. When image resolution is above 1280 × 800, the periphery of the image is not projected.	During 800 × 600 signal input 	During 1400 × 1050 signal input 



When some portions of an image are missing or not all of the image can be projected during computer image projection, set "Resolution" in the configuration menu to "Wide" or "Normal" according to the panel size of the computer. [p.41](#)

Enlarging Part of the Image (E-Zoom)

This is useful when you want to expand images such as graphs and tables to see them in greater detail.

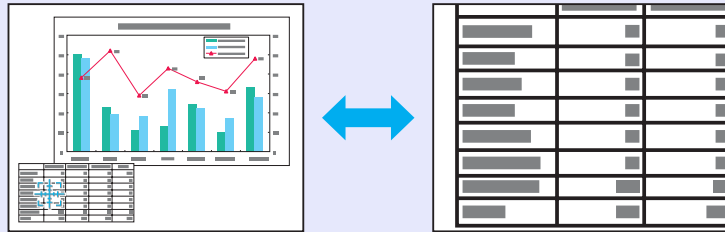

Procedure

- 1 Start E-Zoom.

Remote control

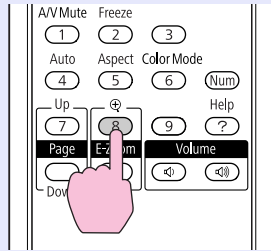

EB-W6

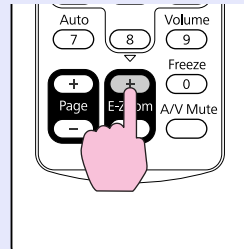

EB-X6/S6

- 2 Move the cross to the area of the image that you want to enlarge.

Remote control

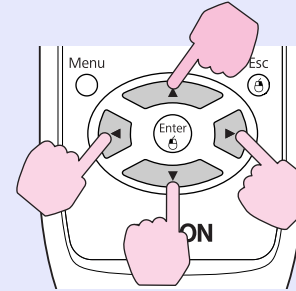

EB-W6

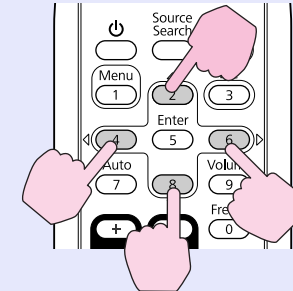

EB-X6/S6

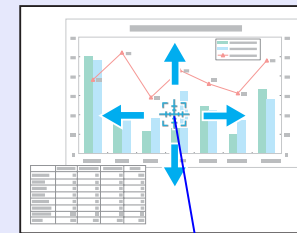

Cross

3 Enlarge.

Remote control

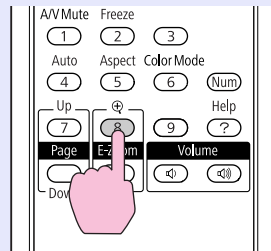

EB-W6

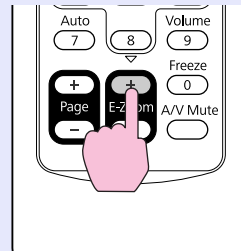

EB-X6/S6

Each time the button is pressed, the area is enlarged. You can enlarge quickly by holding the button down. You can reduce the enlarged image by pressing the [-] button. Press the [Esc] button to cancel.



- *The enlargement ratio appears on the screen. The selected area can be enlarged to between 1 to 4 times in 25 incremental steps.*
- *Hold down the [▲][▼][◀][▶] button to scroll the image.*

The projector has the following enhanced security functions.

- Password protect
You can limit who can use the projector.
- Control Panel Lock
You can prevent people from changing the settings on the projector without permission.
- Anti-Theft Lock
The projector is equipped with various types of anti-theft security devices.

Managing Users (Password Protect)

When the Password Protect function is activated, people who do not know the password cannot use the projector to project images even if the projector power is on. Furthermore, the user's logo that is displayed when you turn on the projector cannot be changed. This acts as an anti-theft device as the projector cannot be used even if it is stolen. At the time of purchase the Password Protect function is not activated.

■ Type of Password Protect

The following two kinds of password protect settings can be made according to how the projector is being used.

1. "Power On Protect"

When "Power On Protect" is "On", the password must be entered whenever the projector is turned on after it has been disconnected from the power supply to which it was connected the last time the password was entered. If the correct password is not entered, projection does not start.

2. "User's Logo Protect"

Even if someone tries to change the user's logo set by the owner of the projector, it cannot be changed. When "User's Logo Protect" is set to "On" the following setting changes are prohibited.

- Capturing a user's logo
- Changing settings of "Display Background", "Startup Screen", and "A/V Mute" in the "Display" setting in the configuration menu.

■ Setting Password Protect

Use the following procedure to set Password Protect.

Procedure



Hold down the [Freeze] button for about five seconds.

The password protect setting menu is displayed.

Remote control

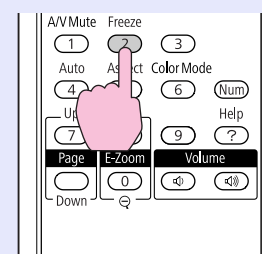

EB-W6

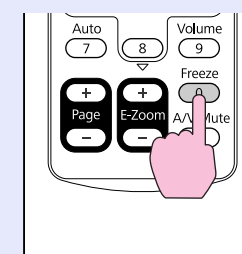

EB-X6/S6

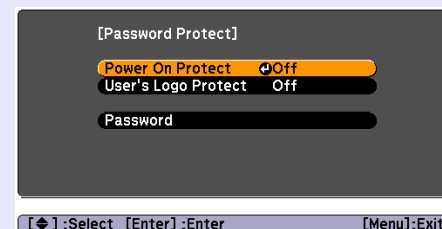

- **If Password Protect is already activated, you must enter the password.**
If the password is entered correctly, the password protect setting menu is displayed.  **"Entering the Password" p.33**
- **When the password is set, stick the password protect sticker in a visible position on the projector as a further theft deterrent.**

2 Turn on "Power On Protect".

- (1) Select "Power On Protect", and then press the [Enter] button.
- (2) Select "On", and then press the [Enter] button.
- (3) Press the [Esc] button.

3 Turn on "User's Logo Protect".

- (1) Select "User's Logo Protect", and then press the [Enter] button.
- (2) Select "On", and then press the [Enter] button.
- (3) Press the [Esc] button.

4 Set the password.

- (1) Select "Password", and then press the [Enter] button.
- (2) When the message "Change the password?" is displayed, select "Yes" and then press the [Enter] button. The default setting for the password is "0000". Change this to your own desired password. If you select "No", the screen shown in step 1 is displayed again.

- (3) Enter a four digit number using the numeric buttons. (With the EB-W6, enter the digit while holding down the [Num] button.) The number entered is displayed as "* * * *". When you enter the fourth digit, the confirmation screen is displayed.

Remote control

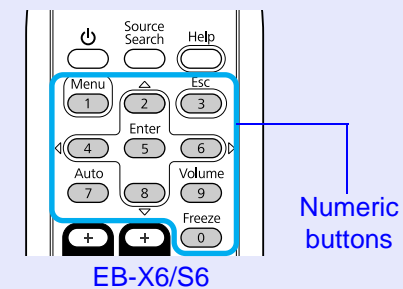
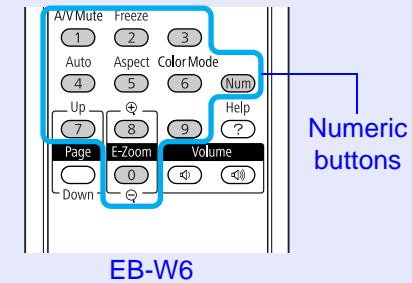

- (4) Re-enter the password. The message "Password accepted." is displayed. If you enter the password incorrectly, a message is displayed prompting you to re-enter the password.

■ Entering the Password

When the password entry screen is displayed, enter the password using the numeric buttons on the remote control.

Procedure

**Enter the password by using the numeric buttons.
(With the EB-W6, enter the digit while holding down the [Num] button.)**

When you enter the correct password, projection begins.

Attention

- *If an incorrect password is entered three times in succession, the message "The projector's operation will be locked." is displayed for about five minutes, and then the projector switches to standby condition. If this happens, disconnect the power plug from the electrical outlet and then reinsert it and turn the projector's power back on. The projector displays the password entry screen again so that you can enter the correct password.*
- *If you have forgotten the password, make a note of the "Request Code: xxxxx" number that appears on the screen and contact the nearest address provided in the Support and Service Guide.*
☞ [Epson Projector Contact List](#)
- *If you continue to repeat the above operation and input the wrong password thirty times in succession, the following message is displayed and the projector does not accept any more password entries. "The projector's operation will be locked. Contact Epson as described in your documentation." ☞ [Epson Projector Contact List](#)*

Restricting Operation (Control Panel Lock)

Do one of the following to lock the operation buttons on the control panel.

- Full lock
All of the buttons on the control panel are locked. You cannot perform any operations from the control panel, including turning the power on or off.
- Partial lock
All of the buttons on the control panel, except for the [⏻] button, are locked.

This is useful at events or shows when you want to deactivate all buttons and only project, or at schools when you want to limit button operation. The projector can still be operated using the remote control.

Procedure

- 1 Press the [Menu] button and select "Settings" - "Control Panel Lock" in the configuration menu.

- EB-W6 p.37
- EB-X6 p.38
- EB-S6 p.39

Using the remote control

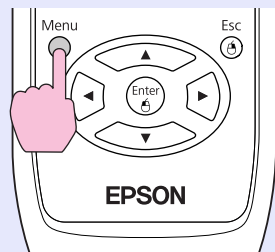

EB-W6

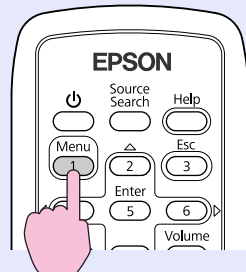

EB-X6/S6

Using the control panel

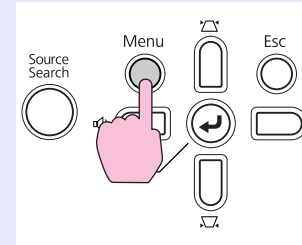

EB-W6/X6

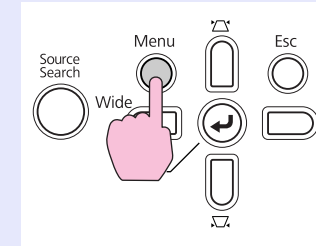

EB-S6

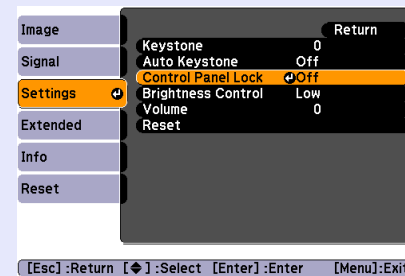

EB-W6/X6

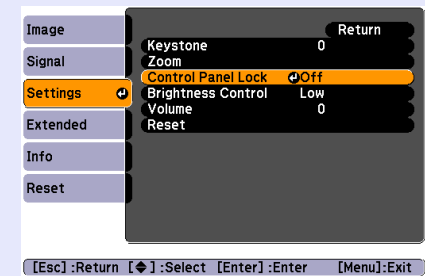

EB-S6

Check the buttons you can use and the operations they perform in the guide under the menu.

- 2 Select either "Full Lock" or "Partial Lock".

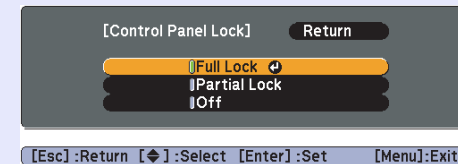

[Esc]:Return [↵]:Select [Enter]:Set [Menu]:Exit

3

Select "Yes" when the confirmation message is displayed.

The control panel buttons are locked according to the setting you chose.



You can release the control panel lock by one of the following two methods.

- *From the remote control, select "Off" from "Settings" - "Control Panel Lock" in the configuration menu.*
- *When you press and hold down the [Enter] button on the control panel for about seven seconds, a message is displayed and the lock is released.*

Anti-Theft Lock

As the projector is often setup on ceiling mounts and left in rooms unattended, it is possible that someone may try and take the projector, so the projector includes the following security devices.

- Security slot
The security slot is compatible with the Microsaver Security System manufactured by Kensington. You can find details about the Microsaver Security System on the Kensington homepage <http://www.kensington.com/>
- Security cable installation point
A commercially available theft-prevention wire lock can be passed through the installation point to secure the projector to a desk or pillar.

■ Installing the wire lock

Pass an anti-theft wire lock through the installation point. See the documentation supplied with the wire lock for locking instructions.

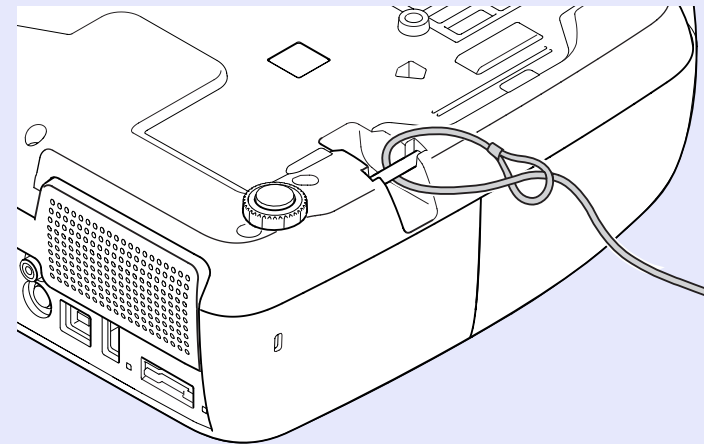



Configuration Menu

This chapter explains how to use the configuration menu and its functions.

Using the Configuration Menu (For EB-W6).....	37
Using the Configuration Menu (For EB-X6).....	38
Using the Configuration Menu (For EB-S6).....	39
List of Functions	40
• Image Menu	40
• Signal Menu	41
• Settings Menu	43
• Extended Menu	44
• Info Menu (Display only).....	46
• Reset Menu	47

- 1 Selecting from the top menu
- 2 Selecting from the sub menu
- 3 Changing the selected item
- 4 Exit

Top menu

Image	Color Mode	Photo	Return
Signal	Brightness	0	
Settings	Contrast	0	
Extended	Sharpness	0	
Info	Color Temp.	High	
Reset	Color Adjustment	Off	
	Auto Iris	Off	
	Reset		

[Left Arrow]:Select [Enter]:Enter [Menu]:Exit

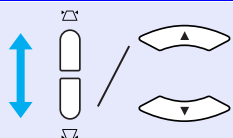

Image	Keystone	0	Return
Signal	Auto Keystone	Off	
Settings	Control Panel Lock	Full Lock	
Extended	Brightness Control	High	
Info	Volume	0	
Reset	Reset		

Enter / [Enter] / [Left Arrow] / [Right Arrow]

Esc / [Esc]

[Left Arrow]:Select [Enter]:Enter [Menu]:Exit

Sub menu (Settings)

Image	Keystone	0	Return
Signal	Auto Keystone	Off	
Settings	Control Panel Lock	Full Lock	
Extended	Brightness Control	High	
Info	Volume	0	
Reset	Reset		

Enter / [Enter] / [Left Arrow] / [Right Arrow]

Esc / [Esc]

[Esc]:Return [Left Arrow]:Select [Enter]:Enter [Menu]:Exit

[Settings]	Keystone	0	Return
------------	----------	---	--------

[Esc]:Return [Left Arrow]:Select [Right Arrow]:Adjust [Menu]:Exit

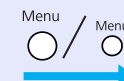
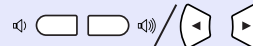

Buttons used

Using the control panel

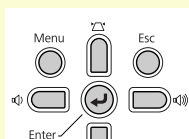

Using the remote control



Image	Keystone	0	Return
Signal	Auto Keystone	Off	
Settings	Control Panel Lock	Full Lock	
Extended	Brightness Control	High	
Info	Volume	0	
Reset	Reset		

Enter / [Enter] / [Left Arrow] / [Right Arrow]

Esc / [Esc]

[Esc]:Return [Left Arrow]:Select [Enter]:Enter [Menu]:Exit

[Brightness Control]	Return
High	
Low	

[Esc]:Return [Left Arrow]:Select [Enter]:Set [Menu]:Exit

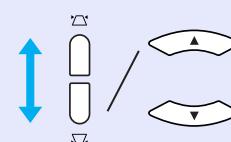

[Brightness Control]	Return
High	
Low	

[Esc]:Return [Left Arrow]:Select [Enter]:Set [Menu]:Exit



Select the setting to change



[Brightness Control]	Return
High	
Low	

[Esc]:Return [Left Arrow]:Select [Enter]:Set [Menu]:Exit

- 1 Selecting from the top menu
- 2 Selecting from the sub menu
- 3 Changing the selected item
- 4 Exit

Top menu

Image	Color Mode	Photo	Return
Signal	Brightness	0	
	Contrast	0	
Settings	Sharpness		
	Color Temp.	High	
Extended	Color Adjustment		
	Auto Iris	Off	
Info	Reset		
Reset			

[Left Arrow]:Select [Enter]:Enter [Menu]:Exit

Sub menu (Settings)

Image	Keystone	0	Return
Signal	Auto Keystone	Off	
Settings	Control Panel Lock	Full Lock	
	Brightness Control	High	
Extended	Volume	0	
Info	Reset		
Reset			

[Enter]:Enter [5] [Esc]:Esc [3]



Image	Keystone	0	Return
Signal	Auto Keystone	Off	
Settings	Control Panel Lock	Full Lock	
	Brightness Control	High	
Extended	Volume	0	
Info	Reset		
Reset			

[Esc]:Return [Left Arrow]:Select [Enter]:Enter [Menu]:Exit



[Settings] Keystone 0 [Return]

[Esc]:Return [Left Arrow]:Select [Right Arrow]:Adjust [Menu]:Exit

Volume icons: [Left Arrow] [4] [6] [Right Arrow]

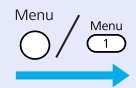

[Brightness Control] Return

High Low

[Esc]:Return [Left Arrow]:Select [Enter]:Set [Menu]:Exit

Select the setting to change

Image	Keystone	0	Return
Signal	Auto Keystone	Off	
Settings	Control Panel Lock	Full Lock	
	Brightness Control	High	
Extended	Volume	0	
Info	Reset		
Reset			

[Esc]:Return [Left Arrow]:Select [Enter]:Enter [Menu]:Exit

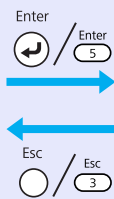

[Brightness Control] Return

High Low

[Esc]:Return [Left Arrow]:Select [Enter]:Set [Menu]:Exit

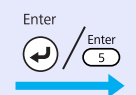

[Brightness Control] Return

High Low

[Esc]:Return [Left Arrow]:Select [Enter]:Set [Menu]:Exit

Buttons used

Using the control panel

Using the remote control

Using the Configuration Menu (For EB-S6)



- 1 Selecting from the top menu
- 2 Selecting from the sub menu
- 3 Changing the selected item
- 4 Exit

Top menu

Image	Color Mode	Photo	Return
Signal	Brightness	0	
Settings	Contrast	0	
Extended	Sharpness	0	
Info	Color Temp.	High	
Reset	Color Adjustment	Off	
	Auto Iris	Off	
	Reset		

Guide

[Left Arrow]:Select [Enter]:Enter [Menu]:Exit

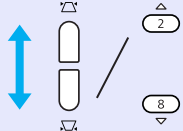

Image	Keystone	0	Return
Signal	Zoom		
Settings	Control Panel Lock	Full Lock	
Extended	Brightness Control	High	
Info	Volume	0	
Reset	Reset		

[Left Arrow]:Select [Enter]:Enter [Menu]:Exit



Sub menu (Settings)

Image	Keystone	0	Return
Signal	Zoom		
Settings	Control Panel Lock	Off	
Extended	Brightness Control	High	
Info	Volume	0	
Reset	Reset		

[Esc]:Return [Left Arrow]:Select [Enter]:Enter [Menu]:Exit

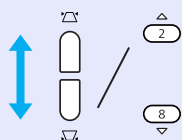
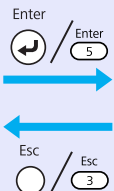

Image	Keystone	0	Return
Signal	Zoom		
Settings	Control Panel Lock	Off	
Extended	Brightness Control	High	
Info	Volume	0	
Reset	Reset		

[Esc]:Return [Left Arrow]:Select [Enter]:Enter [Menu]:Exit



[Settings] Keystone 0 Return

[Esc]:Return [Left Arrow]:Select [Right Arrow]:Adjust [Menu]:Exit

Wide [] [] Tele / < 4 6 >



[Brightness Control] Return

[High] [] [Low]

Select the setting to change



[Brightness Control] Return

[High] [] [Low]

[Esc]:Return [Left Arrow]:Select [Enter]:Set [Menu]:Exit

[Brightness Control] Return

[High] [] [Low]

[Esc]:Return [Left Arrow]:Select [Enter]:Set [Menu]:Exit

Buttons used

Using the control panel

Using the remote control

Image Menu

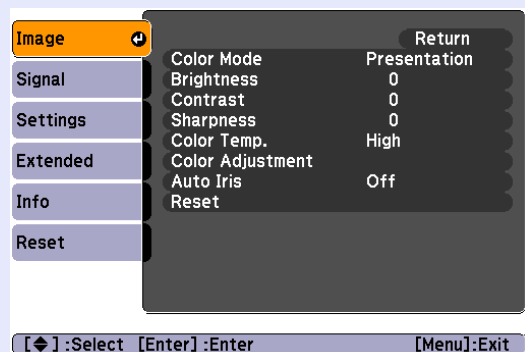

Items that can be set vary depending on the image signal currently being projected as shown in the following screen shots. Setting details are saved for each image signal.

Computer image

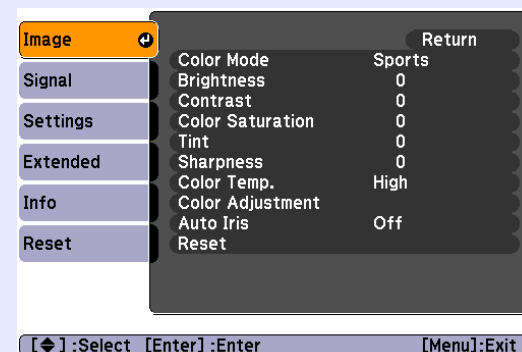

Component video»/Composite video»/S-video»



Sub Menu	Function
Color Mode	You can select the quality of the image to suit your surroundings.  p.19
Brightness	You can adjust the image brightness.
Contrast»	You can adjust the difference between light and shade in the images.
Color Saturation	You can adjust the color saturation for the images.
Tint	(Adjustment is only possible when NTSC signals are being input if you use composite video/S-video.) You can adjust the image tint.
Sharpness	You can adjust the image sharpness.
Color Temp.	You can adjust the overall tint of the image. When "High" is selected the image becomes tinged with blue, and when "Low" is selected the image becomes tinged with red. (This item cannot be selected if " sRGB» " is selected as the "Color Mode" setting in the "Image" menu.)
Color Adjustment	Red, Green, Blue: You can adjust the saturation of each color individually. (This item cannot be selected if " sRGB» " is selected as the "Color Mode" setting in the "Image" menu.)
Auto Iris	(This item can be selected only when "Game" or "Theater" is selected as the "Color Mode" setting in the "Image" menu.) Set to On/Off to adjust luminance according to the image.  p.21
Reset	You can reset all adjustment values in the "Image" menu to their default settings. To return all menu items to their default settings, see  p.47

Signal Menu

Items that can be set vary depending on the image signal currently being projected as shown in the following screen shots. Setting details are saved for each image signal.

Computer image

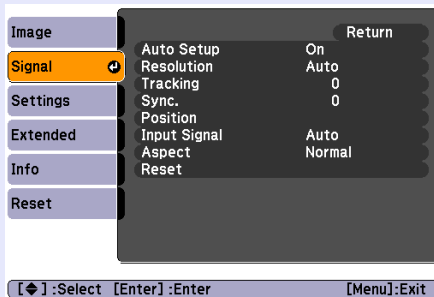

HDMI image (EB-W6 only)

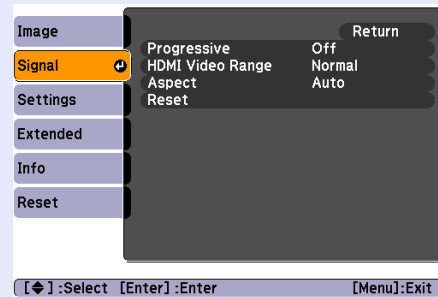



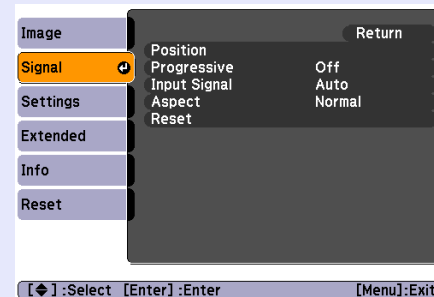

Component video

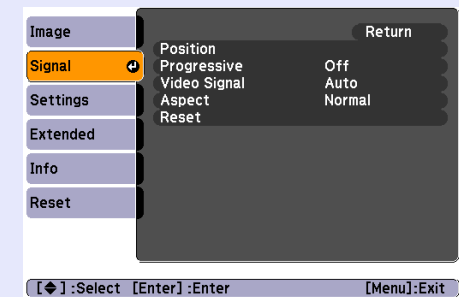

Composite video/S-video



Sub Menu	Function
Auto Setup	You can select whether the image is automatically adjusted to the optimum state (On) or not (Off) when the input signal changes.  p.58
Resolution	When set to "Auto", the resolution of the input signal is automatically identified. When set to "Auto", if parts of the projected image are missing, set "Wide" for a wide screen or "Normal" in case of a 4:3 or 5:4 screen depending on the size of the computer panel.
Tracking	You can adjust computer images when vertical stripes appear in the images.  p.58
Sync.	You can adjust computer images when flickering, fuzziness, or interference appear in the images.  p.58
Position	You can adjust the display position up, down, left, and right so that all of the image is projected if a part of the image is missing.
Progressive	(Component video and HDMI can be set only during 480i/576i signal input) Off: IP conversion is carried out for each field in the screen. This is ideal for viewing images with a large amount of movement. On: <u>interlace</u> (i) signals are converted into <u>progressive</u> (p) signals. This is ideal for viewing still images.
HDMI Video Range (EB-W6 only)	(This cannot be set when a digital RGB signal is input) When the projector's HDMI input port is connected to a DVD player and so on, the projector's video range can be set according to the DVD player's video range setting.
Input Signal	You can select the input signal from the Computer input port. If set to "Auto" the input signal is set automatically according to the connected equipment. If colors do not appear correctly when set to "Auto", select the appropriate signal according to the connected equipment.
Video Signal	If set to "Auto", video signals are recognized automatically. If interference appears in the image or a problem occurs such as no image is being projected when set to "Auto", select the appropriate signal according to the connected equipment.
Aspect	You can set the <u>aspect ratio</u> for projected images.  p.24



Sub Menu	Function
Reset	You can reset all adjustment values in the "Signal" menu to their default settings, except for "Input Signal". To return all menu items to their default settings, see  p.47

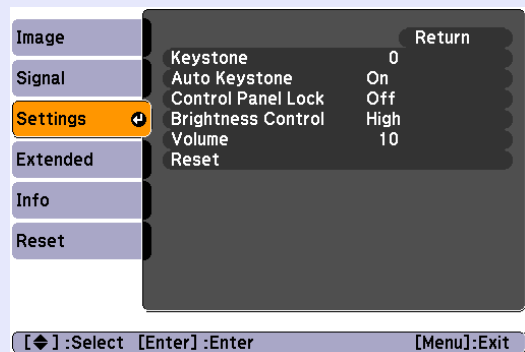

Settings Menu

EB-W6/X6



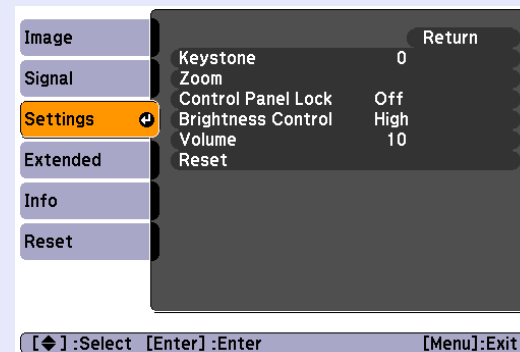

EB-S6





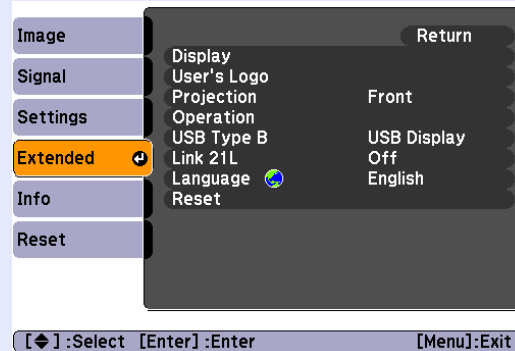

Sub Menu	Function
Keystone	You can correct vertical keystone distortion in images.  Quick Start Guide
Auto Keystone (EB-W6/X6 only)	Performs automatic keystone correction. (This can only be specified when "Front" is selected from "Extended" - "Projection".)
Zoom (EB-S6 only)	Set Tele/Wide. (“Tele” makes the projected image size smaller, “Wide” makes it larger.)
Control Panel Lock	You can use this to restrict operation of the projector's control panel.  p.34
Brightness Control	You can set the lamp brightness to one of two settings. Select "Low" if the images being projected are too bright such as when projecting images in a dark room or onto a small screen. When "Low" is selected, the amount of electricity consumed and the lamp's operating life are changed as follows, and fan rotation noise during projection is reduced. Electrical consumption: about a 40 W decrease, lamp life: about 1.3 times longer
Volume	You can adjust the volume.
Reset	You can reset all adjustment values in the "Settings" menu to their default settings. To return all menu items to their default settings, see  p.47

Extended Menu



Sub Menu	Function
Display	<p>You can make settings related to the projector's display.</p> <p>Messages: You can set whether to display (On) or not display (Off) the source name when you change the input source, the color mode name when you change the Color Mode, a message when no image signal is input, and so on.</p> <p>Display Background^{*1}: You can set the screen status for when no image signal is available to "Black", "Blue", or "Logo".</p> <p>Startup Screen^{*1}: You can set whether the startup screen (the image projected when starting the projector) is displayed (On) or not (Off).</p> <p>A/V Mute^{*1}: You can set the screen displayed during A/V Mute as "Black", "Blue", or "Logo".</p>
User's logo	You can change the user's logo that is displayed as a background and displayed during A/V Mute.  p.72
Projection	<p>You can choose one of the following settings according to the way the projector is setup.  p.64</p> <p>"Front" "Front/Ceiling" "Rear" "Rear/Ceiling"</p> <p>You can change the setting as follows by pressing down the [A/V Mute] button on the remote control for about five seconds.</p> <p>"Front" ↔ "Front/Ceiling"</p> <p>"Rear" ↔ "Rear/Ceiling"</p>

Sub Menu	Function
Operation	<p>Direct Power On: You can set whether Direct Power On is enabled (On) or disabled (Off). When it is set to "On" and the projector power cable is connected to an electrical outlet, be aware that sudden surges of electricity may cause the projector to turn on automatically.</p> <p>Sleep Mode: When set to "On", this turns off the power automatically when no image signal is input and no operations are performed.</p> <p>Sleep Mode Timer: When Sleep Mode is set to "On", you can set how long the projector should wait before turning off the power from 1 to 30 minutes.</p> <p>Lens Cover Timer: When set to "On", this turns off the power automatically 30 minutes after the lens cover is closed.</p> <p>High Altitude Mode: Set this to "On" when using the projector above an altitude of 1500 m.</p>
USB Type B	<p>Connect the projector to a computer with a USB cable, and set to "USB Display" to project the image on the computer.  p.82</p> <p>Set to "Wireless Mouse" to operate the mouse pointer by remote control.  p.87</p> <p>Set to "Page Up/Down" to page up/down by remote control.  p.86</p>
<u>Link 21L</u> ▶▶	<p>You can set whether to use the utility software EMP Link 21L (On) or not (Off). Set this to "On" and use it after installing the USB communication driver.</p>
Language	<p>You can set the language for message displays.</p>
Reset	<p>You can reset "Display ^{*1}" and "Operation ^{*2}" in the "Extended" menu to their default settings. To return all menu items to their default settings, see  p.47</p>

*1 When "User's Logo Protect" is set to "On" in "Password Protect", settings concerning user's logo cannot be changed. You can make changes after setting "User's Logo Protect" to "Off".  [p.31](#)

*2 Except for "High Altitude Mode".

Info Menu (Display only)

Lets you check the status of the image signals being projected and the status of the projector. Items displayed vary depending on the image signal currently being projected as shown in the following screen shots.

Signal from the computer image/component video»/HDMI image (EB-W6 only)

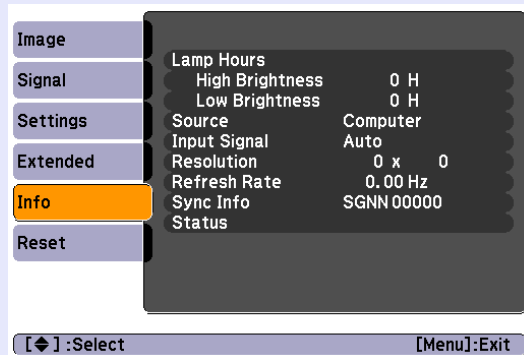

Composite video»/S-video

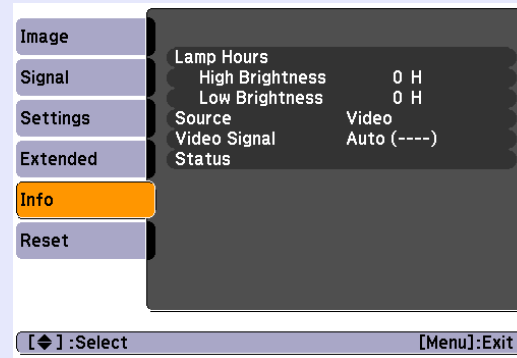

USB Display/Slideshow (EB-W6 only)

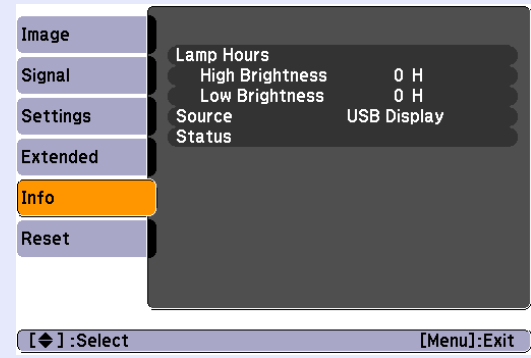

Sub Menu	Function
Lamp Hours	You can display the cumulative lamp operating time*. When it reaches the lamp warning time, the characters are displayed in yellow.
Source	You can display the input port name for the connected equipment currently being projected.
Input Signal	Displays the "Input Signal" setting from the "Signal" menu according to "Source".
Resolution	You can display the input resolution.
Video Signal	You can display the content of "Video Signal" set in the "Signal" menu.
Refresh Rate»	You can display the refresh rate.
Sync» Info	You can display the image signal information. This information may be needed if service is required.
Status	This is information about problems that have occurred on the projector. This information may be needed if service is required.

* The cumulative use time is displayed as "0H" for the first 10 hours. After 10 hours or more, one hour is added for each subsequent hour.

Reset Menu

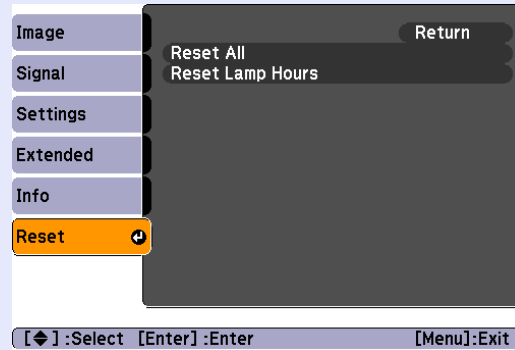

Sub Menu	Function
Reset All	You can reset all items in all menus to their default settings. The following items are not reset to their defaults: "Input Signal", "User's Logo", "Lamp Hours", and "Language".
Reset Lamp Hours	You can clear the cumulative Lamp Hours use time, and return it to "0H". Reset it when you replace the lamp.



Troubleshooting

This chapter describes how to identify problems and what to do if a problem is found.

Using the Help	49
Problem Solving	51
• Reading the Indicators	51
⏻ Power indicator lights red	52
☀ · 📵 Indicator is lit or flashing orange.....	54
• When the Indicators Provide No Help	55
Problems relating to images	56
Problems when projection starts.....	60
Other problems	61

If a problem occurs with the projector, Help uses on-screen displays to assist you in solving the problem. By answering the questions, you can make the correct settings.

Procedure

- 1 Press the [Help] button.**
The help screen is displayed.

Using the remote control

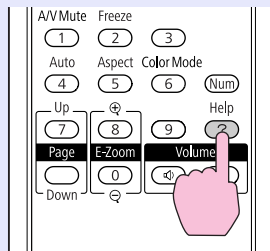

EB-W6

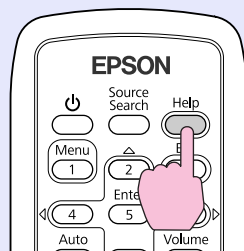

EB-X6/S6

Using the control panel

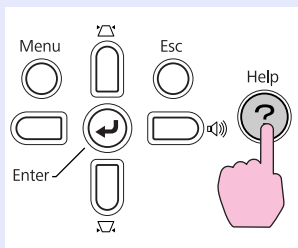

EB-W6/X6

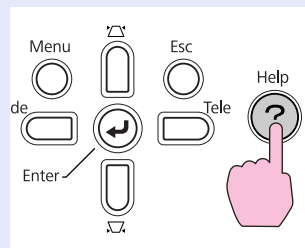

EB-S6

- 2 Select a menu item.**

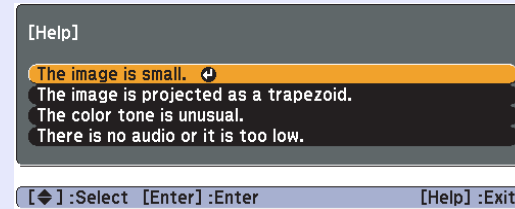

Using the remote control

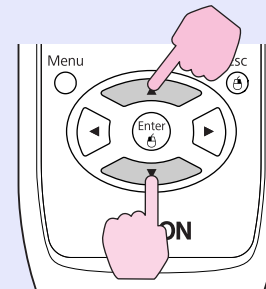

EB-W6

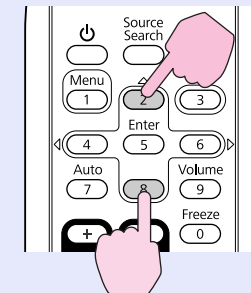

EB-X6/S6

Using the control panel

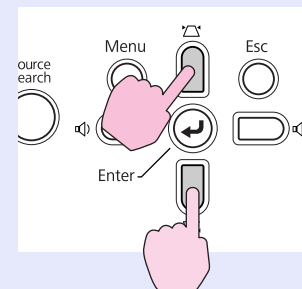

EB-W6/X6

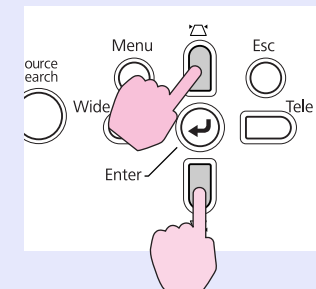

EB-S6

3 Confirm the selection.

Using the remote control

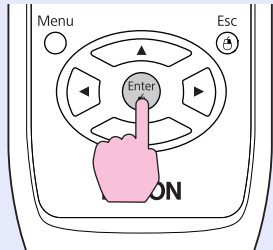

EB-W6

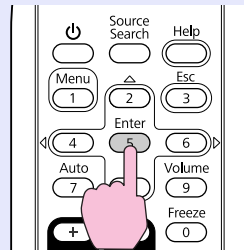

EB-X6/S6

Using the control panel

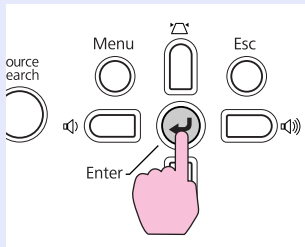

EB-W6/X6

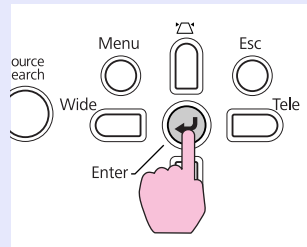

EB-S6

Questions and solutions are displayed as shown on the screen below.

Press the [Help] button to exit Help.

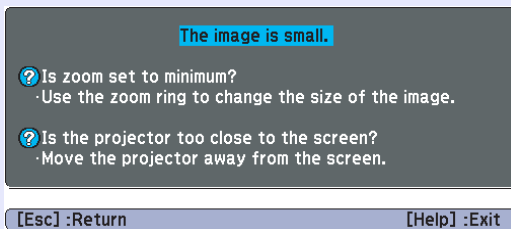

- *If Help does not provide a solution to the problem, refer to "Problem Solving".* p.51
- *Displayed help contents differ with the model of projector.*

If you are having a problem with the projector, first check the projector's indicators and refer to "Reading the Indicators" below. If the indicators do not show clearly what the problem might be, refer to "When the Indicators Provide No Help".  [p.55](#)

Reading the Indicators

The projector is provided with the following three indicators that indicate the operating status of the projector.

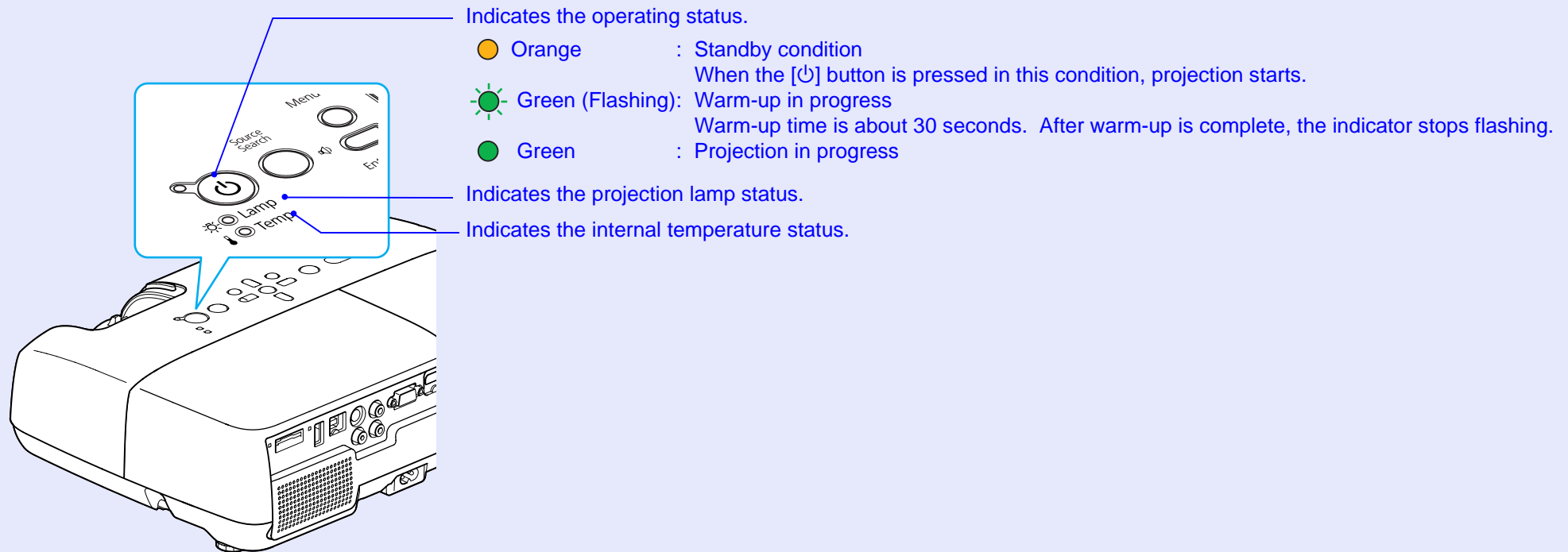

Refer to the following table to see what the indicators mean and how to remedy problems that they indicate.

If all indicators are off, check that the power cable is connected correctly and that the power is being supplied normally.









Sometimes, when the power cable is unplugged, the ⏻ indicator remains lit for a short period which is not a fault.

■ Power indicator lights red **Problem**

: Lit : Flashing: : Off

Status	Cause	Remedy or Status
Red Red Red	Internal Error	Stop using the projector, disconnect the power cable from the electrical outlet, and contact your local dealer or the nearest address provided in the <i>Support and Service Guide</i> . Epson Projector Contact List
Red Red	Fan Error Sensor Error	Stop using the projector, disconnect the power cable from the electrical outlet, and contact your local dealer or the nearest address provided in the <i>Support and Service Guide</i> . Epson Projector Contact List
Red Red Red	Auto Iris error	Stop using the projector, disconnect the power cable from the electrical outlet, and contact your local dealer or the nearest address provided in the <i>Support and Service Guide</i> . Epson Projector Contact List
Red Red	High Temp Error (overheating)	The lamp turns off automatically and projection stops. Wait for about five minutes. After about five minutes the projector switches to standby condition, so check the following two points. <ul style="list-style-type: none"> • Check that the air filter and air exhaust vent are clear, and that the projector is not positioned against a wall. • If the air filter is clogged, clean or replace it. p.65, 71 If the error continues after checking the points above, stop using the projector, disconnect the power cable from the electrical outlet, and contact your local dealer or the nearest address provided in the <i>Support and Service Guide</i> . Epson Projector Contact List
		When using at an altitude of 1500 m or more, set "High Altitude Mode" to "On". p.45

● : Lit ☀ : Flashing: ○ : Off

Status	Cause	Remedy or Status
 ● Red  ☀ Red  ○	Lamp Error Lamp Failure Lamp Cover Open	<p>Check the following two points.</p> <ul style="list-style-type: none"> • Take out the lamp and check if it is cracked.  p.68 • Clean the air filter.  p.65 <p>If it is not cracked - Re-fit the lamp and turn on the power. If the error continues - Replace the lamp with a new lamp and turn on the power. If the error continues - Stop using the projector, disconnect the power cable from the electrical outlet, and contact your local dealer or the nearest address provided in the <i>Support and Service Guide</i>.  Epson Projector Contact List</p> <p>If it is cracked - Replace it with a new lamp, or contact your local dealer for further advice. If replacing the lamp yourself, be careful to avoid pieces of broken glass (you cannot continue projecting until the lamp is replaced).  Epson Projector Contact List</p> <p>Check that the lamp cover and the lamp are securely installed.  p.68 If the lamp cover or the lamp is not securely installed, the lamp does not switch on.</p> <p>When using at an altitude of 1500 m or more, set "High Altitude Mode" to "On".  p.45</p>

■ Indicator is lit or flashing orange **Warning**

● : Lit : Flashing ○ : Off ◐ : Varies according to the projector status

Status	Cause	Remedy or Status
● Red ○ Orange	High Temp Warning	(This is not a problem. However, if the temperature rises too high again, projection stops automatically.) <ul style="list-style-type: none"> • Check that the air filter and air exhaust vent are clear, and that the projector is not positioned against a wall. • If the air filter is clogged, clean or replace it. p.65, 71
◐ Orange ○	Replace Lamp	Replace it with a new lamp. p.68 If you continue to use the lamp after the replacement period has passed, the possibility that the lamp may explode increases. Replace it with a new lamp as soon as possible.













- *If the projector is not operating properly, even though the indicators are all showing normal, refer to "When the Indicators Provide No Help". [p.55](#)*
- *If an indicator is displaying a status not described in the tables, stop using the projector, disconnect the power cable from the electrical outlet, and contact your local dealer or the nearest address provided in the Support and Service Guide. [Epson Projector Contact List](#)*

When the Indicators Provide No Help

If any of the following problems occur and the indicators do not offer a solution, refer to the pages given for each problem.



Problems relating to images

- **No images appear**  [p.56](#)
Projection does not start, the projection area is completely black, the projection area is completely blue, and so on.
- **Moving images are not displayed**  [p.56](#)
Moving images being projected from a computer appear black and nothing is projected.
- **Projection stops automatically**  [p.56](#)
- **The message "Not supported." is displayed**  [p.57](#)
- **The message "No Signal." is displayed**  [p.57](#)
- **Images are fuzzy or out of focus**  [p.57](#)
- **Interference or distortion appears in images**  [p.58](#)
Problems such as interference, distortion, or black & white checked patterns appear.
- **The image is truncated (large) or small, or the aspect is not suitable**  [p.58](#)
Only part of the image is displayed, or the height and width ratios of the image are not correct, and so on.
- **Image colors are not right**  [p.59](#)
The whole image appears purplish or greenish, images are black & white, colors appear dull, and so on.
(Computer monitors and LCD screens have different color reproduction performance, so the colors projected by the projector and the colors appearing on the monitor may not necessarily match, but this is not a sign of a problem.)
- **Images appear dark**  [p.59](#)
- **Nothing appears on the external monitor (EB-X6/S6 only)**
 [p.59](#)

Problems when projection starts

- **Power does not turn on**  [p.60](#)

Other problems

- **No sound can be heard or the sound is faint**  [p.61](#)
- **The remote control does not work**
 [p.61](#)

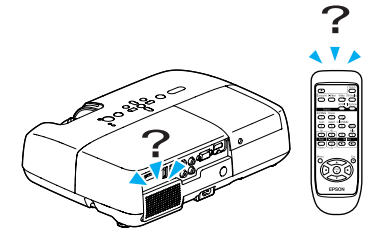

■ Problems relating to images

■ No images appear

Check	Remedy
Did you press the [⏻] button?	Press the [⏻] button to turn the power on.
Are the indicators switched off?	The power cable is not connected correctly or power is not being supplied normally. Connect the projector's power cable correctly. 🖱️ <i>Quick Start Guide</i> Check that your electrical outlet or power source is functioning correctly.
Is A/V Mute active?	Press the [A/V Mute] button on the remote control to cancel A/V Mute. 🖱️ p.22
Is the A/V mute slide closed?	Open the A/V mute slide.
Are the configuration menu settings correct?	Reset all of the settings. 🖱️ "Reset" - "Reset All" p.47
Is the projected image completely black? Only when projecting computer images	Some input images, such as screen savers, may be completely black.
Is the image signal format setting correct? Only when projecting images from a video source	Change the setting according to the signal for the connected equipment. 🖱️ "Signal" - "Video Signal" p.41

■ Moving images are not displayed

Check	Remedy
Is the computer's image signal being output to the LCD and the monitor? Only when projecting images from a laptop computer or a computer with a built-in LCD screen	Change the image signal to external output only. 🖱️ Computer's documentation

■ Projection stops automatically

Check	Remedy
Is "Sleep Mode" set to "On"?	Press the [⏻] button to turn the power on. If you do not want to use "Sleep Mode", change the setting to "Off". 🖱️ "Extended" - "Operation" - "Sleep Mode" p.45

■ The message "Not supported." is displayed

Check	Remedy
Is the image signal format setting correct? Only when projecting images from a video source	Change the setting according to the signal for the connected equipment. 🖱️ "Signal" - "Video Signal" p.41
Do the image signal resolution and the refresh rate correspond to the mode? Only when projecting computer images	Refer to the computer's documentation for how to change the image signal resolution and the refresh rate output from the computer. 🖱️ "List of Supported Monitor Displays" p.102





■ The message "No Signal." is displayed

Check	Remedy
Are the cables connected correctly?	Check that all the cables required for projection are securely connected. 🖱️ <i>Quick Start Guide</i>
Is the correct input port selected?	Change the image by pressing the [Source Search] button on the remote control or the control panel. 🖱️ p.17
Is the power for the computer or video source turned on?	Turn the power on for the equipment.
Are the image signals being output to the projector? Only when projecting images from a laptop computer or a computer with a built-in LCD screen	If the image signals are only being output to the computer's LCD monitor or to the accessory monitor, you need to change the output to an external destination as well as the computer's own monitor. For some computer models, when the image signals are output externally, they no longer appear on the LCD monitor or accessory monitor. 🖱️ Computer's documentation, under a title such as "External output" or "Connecting an external monitor". If the connection is made while the power of the projector or computer is already turned on, the function [Fn] key that changes the computer's image signal to external output may not work. Turn the power for the computer and the projector off and then back on again.







■ Images are fuzzy or out of focus

Check	Remedy
Is the focus adjusted correctly?	Turn the focus ring to adjust the focus. 🖱️ <i>Quick Start Guide</i>
Is the projector at the correct distance?	Is the projection distance outside the recommended range? Install within the recommended range. 🖱️ p.75
Is the Keystone adjustment value too large?	Lower the projection angle to reduce the amount of keystone correction.
Has condensation formed on the lens?	If the projector is suddenly taken from a cold environment to a warm environment, or if sudden ambient temperature changes occur, condensation may form on the surface of the lens, and this may cause the images to appear fuzzy. Set the projector up in the room about one hour before it is used. If condensation forms on the lens, turn the projector off and wait for the condensation to disappear.







■ Interference or distortion appear in images

Check	Remedy
Is the image signal format setting correct? Only when projecting images from a video source	Change the setting according to the signal for the connected equipment.  "Signal" - "Video Signal" p.41
Are the cables connected correctly?	Check that all the cables required for projection are securely connected.
Is an extension cable being used?	If an extension cable is used, electrical interference may affect the signals. Use the cables supplied with the projector to check if the cables you are using may be causing the problem.
Is the correct resolution selected? Only when projecting computer images	Set the computer so that the signals being output are compatible with the projector.  "List of Supported Monitor Displays" p.102  Computer documentation
Are the "Sync.▶▶" and "Tracking▶▶" settings adjusted correctly? Only when projecting computer images	Press the [Auto] button on the remote control or the [Enter] button on the control panel to perform automatic adjustment. If the images are not adjusted correctly after using automatic adjustment, you can make the adjustments from "Sync." and "Tracking" in the configuration menu.  "Signal" - "Tracking", "Sync." p.41





■ The image is truncated (large) or small, or the aspect is not suitable

Check	Remedy
Is a wide panel computer image being projected? Only when projecting computer images	Change the setting according to the signal for the connected equipment.  "Signal" - "Resolution" p.41
Is the image still being enlarged by E-Zoom?	Press the [Esc] button on the remote control to cancel E-Zoom.  p.29
Is "Position" adjusted correctly?	Press the [Auto] button on the remote control or the [Enter] button on the control panel to perform automatic adjustment of the computer image being projected. If the images are not adjusted correctly after using automatic adjustment, you can make the adjustments from "Position" in the configuration menu. Apart from computer image signals, you can adjust other signals while projecting by adjusting "Position" in the configuration menu.  "Signal" - "Position" p.41
Is the computer set for dual display? Only when projecting computer images	If dual display is activated in the "Display Properties" of the computer's control panel, only about half of the image on the computer screen is projected. To display the entire image on the computer screen, turn off the dual display setting.  Computer video driver documentation
Is the correct resolution selected? Only when projecting computer images	Set the computer so that the signals being output are compatible with the projector.  "List of Supported Monitor Displays" p.102  Computer documentation

■ Image colors are not right

Check	Remedy
Do the input signal settings match the signals from the connected device?	Change the following settings according to the signal for the connected equipment. When projecting images from equipment connected to Computer Input port, see  "Signal" - "Input Signal" p.41 When projecting images from equipment connected to Video or S-Video, see  "Signal" - "Video Signal" p.41
Is the image brightness adjusted correctly?	Adjust the "Brightness" setting in the configuration menu.  "Image" - "Brightness" p.40
Are the cables connected correctly?	Check that all the cables required for projection are securely connected.
Is the " <u>Contrast</u> 	Adjust the "Contrast" setting in the configuration menu.  "Image" - "Contrast" p.40
Is the color adjusted correctly?	Adjust the "Color Adjustment" setting in the configuration menu.  "Image" - "Color Adjustment" p.40
Are the color saturation and tint adjusted correctly?	Adjust the "Color Saturation" and "Tint" settings in the configuration menu.  "Image" - "Color Saturation", "Tint" p.40
Only when projecting images from a video source	

■ Images appear dark



Check	Remedy
Are the image brightness and luminance adjusted correctly?	Adjust the "Brightness" and "Brightness Control" settings in the configuration menu.  "Image" - "Brightness" p.40  "Settings" - "Brightness Control" p.43
Is the " <u>Contrast</u> 	Adjust the "Contrast" setting in the configuration menu.  "Image" - "Contrast" p.40
Is the lamp due for replacement?	When the lamp is nearly ready for replacement, the images become darker and the color quality becomes poorer. When this happens, replace the lamp with a new lamp.  p.67

■ Nothing appears on the external monitor (EB-X6/S6 only)

Check	Remedy
Are images from a port other than the Computer Input port being projected?	The only images that can be displayed on an external monitor are computer images from the Computer Input port.  p.78

■ Problems when projection starts

■ Power does not turn on

Check	Remedy
Did you press the [⏻] button?	Press the [⏻] button to turn the power on.
Are the indicators switched off?	The power cable is not connected correctly or power is not being supplied normally. Connect the projector's power cable correctly. Check that your electrical outlet or power source is functioning correctly.
Do the indicators turn on and off when the power cable is touched?	There is probably a poor contact in the power cable, or the power cable may be defective. Reinsert the power cable. If this does not solve the problem, stop using the projector, disconnect the power cable from the electrical outlet, and contact your local dealer or the nearest address provided in the <i>Support and Service Guide</i> .  Epson Projector Contact List
Is the control panel lock set to "Full Lock"?	When you press and hold down the [Enter] button on the control panel for about seven seconds, a message is displayed and the lock is released.  p.34
Was the power cable plugged back in immediately after Direct Power Off, or is the breaker turned off?	When the operation to the left is performed when "Direct Power On" is set to "On", the power may not turn back on. Press the [⏻] button to turn the power back on.

■ Other problems

■ There is no audio or the audio is too low

Check	Remedy
Is the audio source connected correctly?	Check that the cable is connected to the Audio port.
Is the volume adjusted to the minimum setting?	Adjust the volume so that sound can be heard.
Is A/V Mute active?	Press the [A/V Mute] button on the remote control to cancel A/V Mute.  p.22
Is the audio cable's specification "No resistance"?	When using a commercially available audio cable, make sure it is labelled "No resistance".

■ The remote control does not work

Check	Remedy
Is the remote control light-emitting area pointing towards the remote receiver on the projector when it is operated?	Point the remote control towards the remote receiver. The operating angle for the remote control is about 30° horizontally, and about 15° vertically.
Is the remote control too far from the projector?	The operating range for the remote control is about 6 m.
Is direct sunlight or strong light from fluorescent lamps shining onto the remote receiver?	Set the projector up in a location where strong light does not shine onto the remote receiver.
Are the batteries dead or have the batteries been inserted correctly?	Make sure the batteries are inserted correctly or replace the batteries with new ones if necessary.  p.66
Was a remote control button pressed for more than 30 seconds?	If any of the buttons on the remote control are pressed down for more than 30 seconds, the remote control stops sending signals (remote control's sleep mode). When the button is released, normal remote control operation resumes. This can prevent the batteries from running down accidentally because Sleep Mode operates when the remote control is stored in a bag or if an object is placed on top of it.

Appendices



This chapter provides information on maintenance procedures to ensure the best level of performance from the projector for a long time to come.

Installation Methods	64	Connecting and Removing a USB Device (EB-W6 only).....	79
Cleaning.....	65	• Connecting a USB Device	79
• Cleaning the Projector's Surface	65	• Reading the Indicators.....	79
• Cleaning the Lens.....	65	• Removing a USB Device.....	79
• Cleaning the Air Filter and Air Intake Vent	65	Inserting and Ejecting a SD Card (EB-W6 only).....	80
Replacing Consumables	66	• Inserting a SD Card	80
• Replacing the Remote Control Batteries	66	• Reading the SD Card Access Lamp.....	80
• Replacing the Lamp	67	• Ejecting a SD Card.....	81
Lamp replacement period	67	Connecting with USB Cable for Projection (USB Display)	82
How to replace the lamp.....	68	• How to Connect (For EB-W6)	82
Resetting the lamp operating time.....	70	• How to Connect (For EB-X6/S6).....	83
• Replacing the Air Filter	71	When connecting for the first time	84
Air filter replacement period	71	From the second time.....	85
How to replace the air filter.....	71	Connecting a USB Cable	86
Saving a User's Logo	72	• Page Up/Down by Remote Control.....	86
Screen Size and Distance	75	• Operating the Mouse Pointer by Remote Control (Wireless Mouse function)	87
• EB-W6.....	75	Wireless mouse operation (EB-W6 only)	88
• EB-X6	76	Wireless Mouse operation (EB-X6/S6 only)	89
• EB-S6.....	77		
Connecting to External Equipment.....	78		
• Connecting to an External Monitor (EB-X6/S6 only)....	78		



Using Slideshow (EB-W6 only)..... 90

- **Image Files that can be Projected in a Slideshow90**
- **Basic Slideshow Operations90**
 - Starting Slideshow..... 90
 - Exiting Slideshow..... 91
 - Slideshow file browser screen..... 91
 - Playing individual images 93
 - Running Slideshow..... 94
 - Rotating images 95
- **Setting Image File Display and Slideshow.....95**

Optional Accessories and Consumables 97

- Optional accessories 97
- Consumables 97

Glossary 98

ESC/VP21 Commands 100

- **Command List.....100**
- **Cable Layouts.....100**
 - USB connection..... 100
- **USB Connection Setup.....101**

List of Supported Monitor Displays 102

- **EB-W6 102**
 - Computer images (analog RGB)..... 102
 - Component Video 103
 - Composite video/S-video..... 103
 - Input signal from HDMI input port 104
- **EB-X6 105**
 - Computer images (analog RGB)..... 105
 - Component Video 106
 - Composite video/S-video..... 106
- **EB-S6 107**
 - Computer images (analog RGB)..... 107
 - Component Video 108
 - Composite video/S-video..... 108

Specifications 109

- **Specifications 109**
- **Operating Requirements of Supplied Software..... 112**

Appearance..... 113

Index 114

The projector supports the following four different projection methods. Install according to the conditions of the installation location.

Warning

- *A special method of installation is required when suspending the projector from a ceiling (ceiling mount). If it is not installed correctly, it could fall causing an accident and injury.*
- *If you use adhesives on the ceiling mount to prevent the screws from loosening, or if you use things such as lubricants or oils on the projector, the projector case may crack causing it to fall from its ceiling mount. This could cause serious injury to anyone under the ceiling mount and could damage the projector. When installing or adjusting the ceiling mount, do not use adhesives to prevent the screws from loosening and do not use oils or lubricants and so on.*

Attention

Do not use the projector on its side. This may cause malfunctions to occur.

- *Project images from front of the screen. (Front projection)*

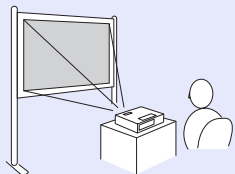

- *Project images from behind a translucent screen. (Rear projection)*

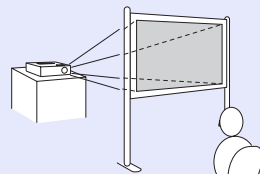

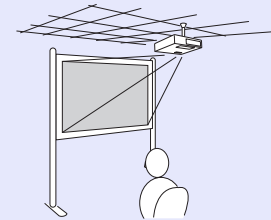

- *Suspend the projector from the ceiling and project images from front of the screen. (Front/Ceiling projection)*

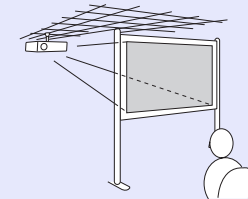

- *Suspend the projector from the ceiling and project images from behind a translucent screen. (Rear/Ceiling projection)*



- *An optional ceiling mount is required when suspending the projector from a ceiling.  p.97*
- *You can change the setting as follows by pressing down the [A/V Mute] button on the remote control for about five seconds.
"Front" ↔ "Front/Ceiling"
Set "Rear" or "Rear/Ceiling" in the configuration menu.
 p.44*

You should clean the projector if it becomes dirty or if the quality of projected images starts to deteriorate.

Cleaning the Projector's Surface

Clean the projector's surface by wiping it gently with a soft cloth. If the projector is particularly dirty, moisten the cloth with water containing a small amount of neutral detergent, and then firmly wring the cloth dry before using it to wipe the projector's surface.

Attention

Do not use volatile substances such as wax, alcohol, or thinner to clean the projector's surface. The quality of the case may change or become discolored.

Cleaning the Lens

Use a commercially available cloth for cleaning glasses to gently wipe the lens.

Attention

Do not rub the lens with harsh materials or subject the lens to shocks, as it can easily become damaged.

Cleaning the Air Filter and Air Intake Vent

Clean the air filter and the air intake vent when the following message is displayed.

"The projector is overheating. Make sure nothing is blocking the air vent, and clean or replace the air filter"  "How to replace the air filter" [p.71](#)

Attention

If dust collects on the air filter it can cause the internal temperature of the projector to rise, and this can lead to problems with operation and shorten the optical engine's service life. Clean the air filter immediately when the message is displayed.

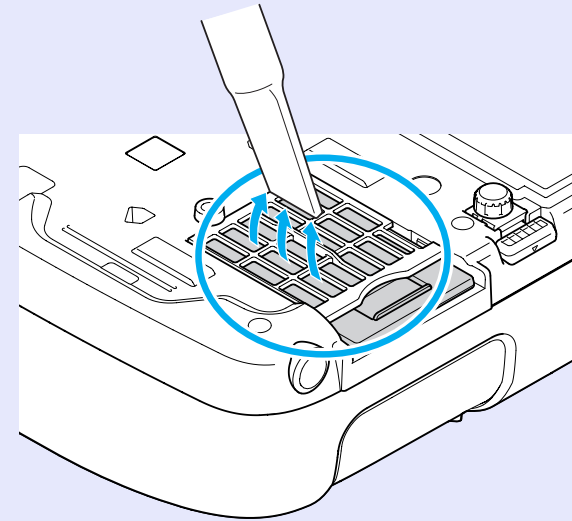

- *If a message is frequently displayed, even after cleaning, it is time to replace the air filter. Replace it with a new air filter.  [p.71](#)*
- *It is recommended that you clean these parts at least once every three months. Clean them more often than this if using the projector in a particularly dusty environment.*

This section explains how to replace the remote control batteries, the lamp, and the air filter.

Replacing the Remote Control Batteries

If delays in the responsiveness of the remote control occur or if it does not operate after it has been used for some time, it probably means that the batteries are becoming flat. When this happens, replace them with new batteries. Have two spare AA-size alkaline or manganese dry batteries ready to use. You can only use AA-size alkaline or manganese dry batteries.

Attention

Make sure you read the Safety Instructions/Support and Service Guide before handling the batteries.  *Safety Instructions*

Procedure

1 Remove the battery cover.

While pushing the battery cover catch, lift the cover up.

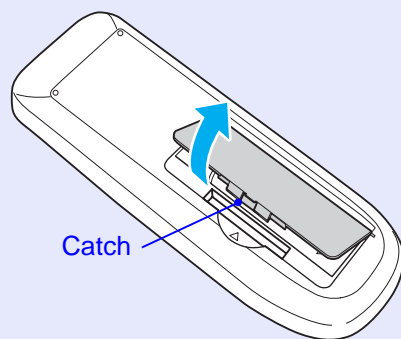

EB-W6

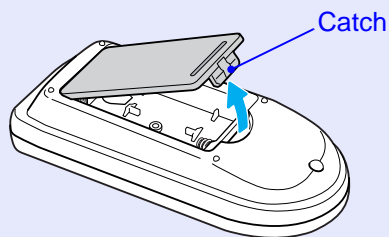

EB-X6/S6

2

2 Replace the old batteries with new batteries.

Caution

Check the positions of the (+) and (-) marks inside the battery holder to ensure the batteries are inserted the correct way.

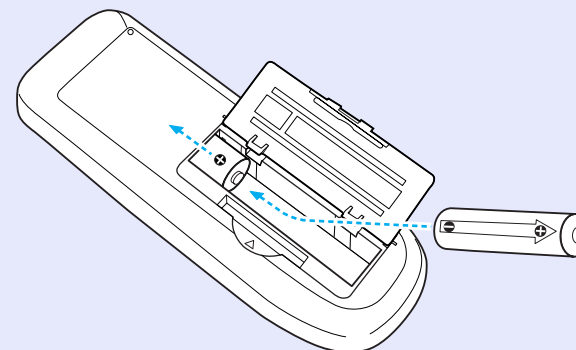

EB-W6

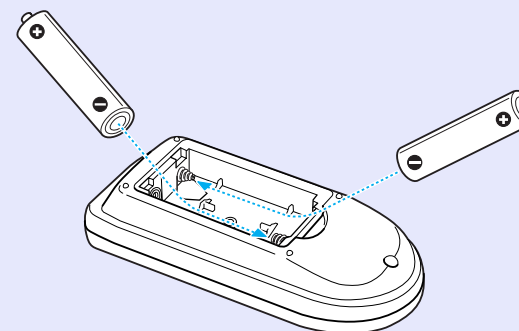

EB-X6/S6

3 Replace the battery cover.

Press the battery cover until it clicks into place.

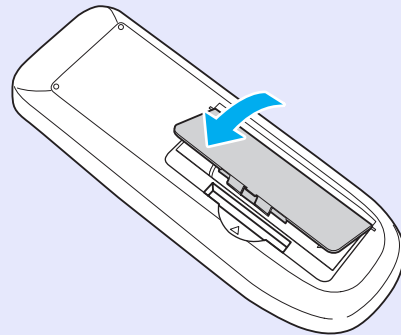

EB-W6

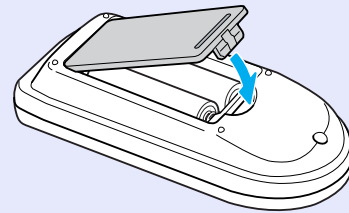

EB-X6/S6

Replacing the Lamp

■ **Lamp replacement period**

It is time to replace the lamp when:

- The message "Replace the lamp." is displayed.

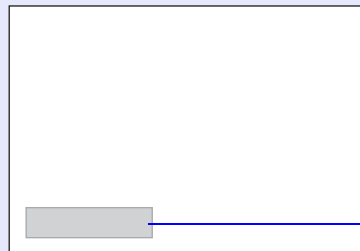

A message is displayed.

- The lamp indicator flashes orange.

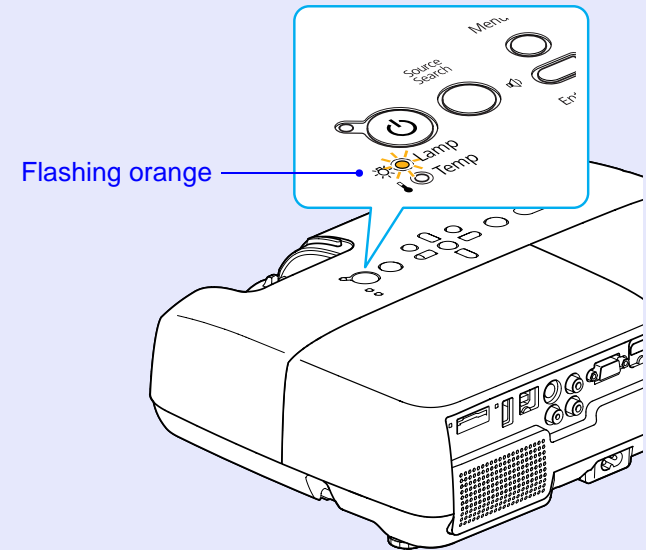

The illustration is of the EB-W6.

- The projected image gets darker or starts to deteriorate.

Attention

- *The lamp replacement message is set to appear after the following time periods in order to maintain the initial brightness and quality of the projected images.  "Brightness Control" p.43*
 - *When used continually at high brightness: About 2900 hours*
 - *When used continually at low brightness: About 3900 hours*
- *If you continue to use the lamp after the replacement period has passed, the possibility that the lamp may explode increases. When the lamp replacement message appears, replace the lamp with a new one as soon as possible, even if it is still working.*
- *Depending on the characteristics of the lamp and the way it has been used, the lamp may become darker or stop working before the lamp warning message appears. You should always have a spare lamp ready in case it is needed.*

■ How to replace the lamp

Warning

When replacing the lamp because it has stopped illuminating, there is a possibility that the lamp may be broken. If replacing the lamp of a projector which has been installed on the ceiling, you should always assume that the lamp is broken, and you should stand to the side of the lamp cover, not underneath it. Remove the lamp cover gently. Small pieces of glass may fall out when the lamp cover is opened. If pieces of glass get into your eyes or mouth, seek medical advice immediately.

Caution

Wait until the lamp has cooled down sufficiently before removing the lamp cover. If the lamp is still hot, burns or other injuries may result. It takes about one hour after the power has been turned off for the lamp to be cool enough.

Procedure

1 After you turn off the projector's power and the confirmation buzzer beeps twice, disconnect the power cable.

2 Wait until the lamp has cooled down, then remove the lamp cover.

Loosen the lamp cover fixing screw with the screwdriver supplied with the new lamp or a + head screwdriver. Then slide the lamp cover straight forward and lift it to remove.

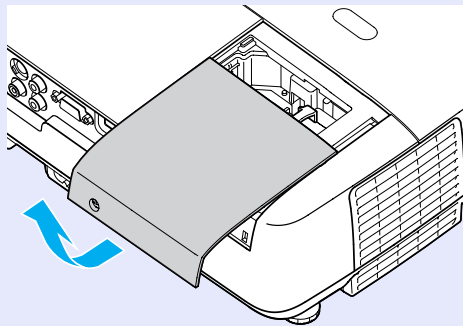
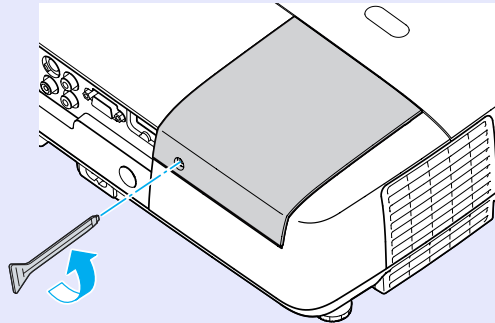

3 Loosen the two lamp fixing screws.

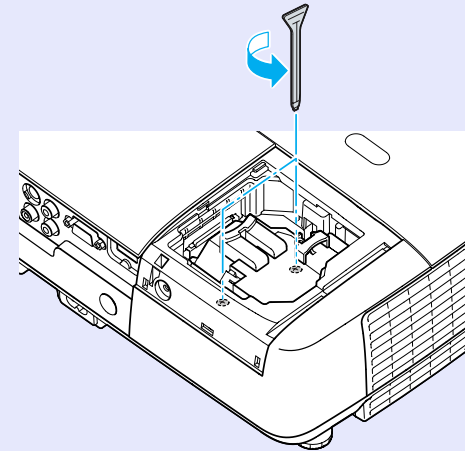

4 Take out the old lamp.

If the lamp is cracked, replace it with a new lamp, or contact your local dealer for further advice. [Epson Projector Contact List](#)

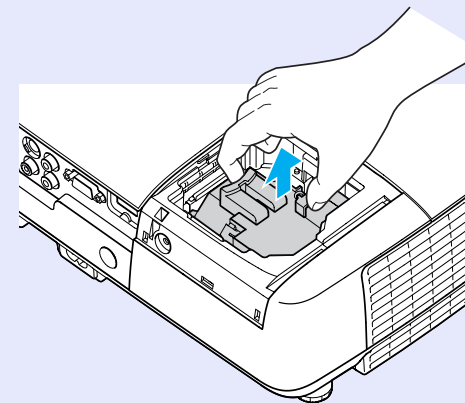

5 Install the new lamp.

Insert the new lamp along the guide rail in the correct direction so that it fits in place, push down firmly at the location marked "PUSH", and once it is fully inserted tighten the two screws.

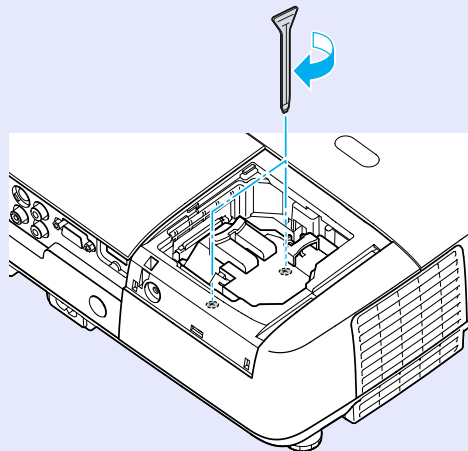
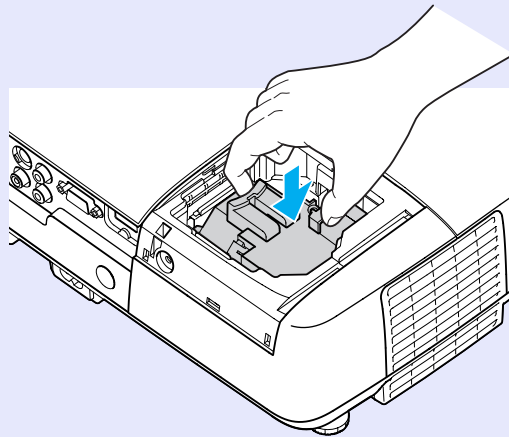

6 Replace the lamp cover.

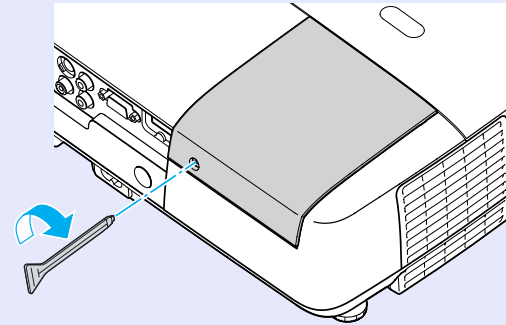

Attention

- *Make sure you install the lamp securely. If the lamp cover is removed, the lamp turns off automatically as a safety precaution. If the lamp or the lamp cover is not installed correctly, the lamp does not turn on.*
- *This product includes a lamp component that contains mercury (Hg). Please consult your local regulations regarding disposal or recycling. Do not dispose of it with normal waste.*

■ **Resetting the lamp operating time**

The projector records how long the lamp is turned on and a message and indicator notify you when it is time to replace the lamp. After replacing the lamp, make sure you reset the lamp hours in the configuration menu.

[p.47](#)



Only reset the lamp operating time after the lamp has been replaced. Otherwise the lamp replacement period is not indicated correctly.

Replacing the Air Filter

Air filter replacement period

It is time to replace the air filter when:

- The air filter is ripped.
- The message is displayed even though the air filter has been cleaned.

How to replace the air filter

The air filter can be replaced even when the projector is suspended from a ceiling.

Procedure

1 After you turn off the projector's power and the confirmation buzzer beeps twice, disconnect the power cable.

2 Remove the air filter.
Put your finger into the recess of the air filter and slide it forward to remove it.

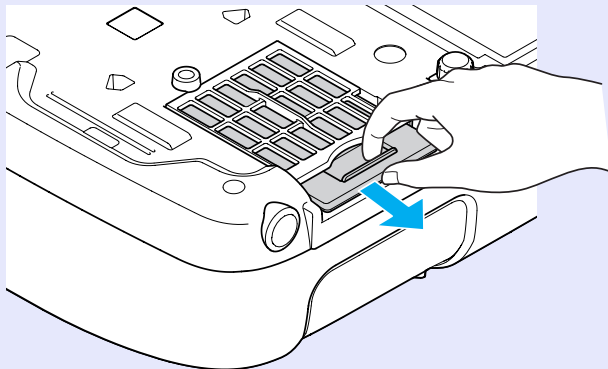

3 Install the new air filter.

Slide the air filter in from the outside and push until it clicks into place.

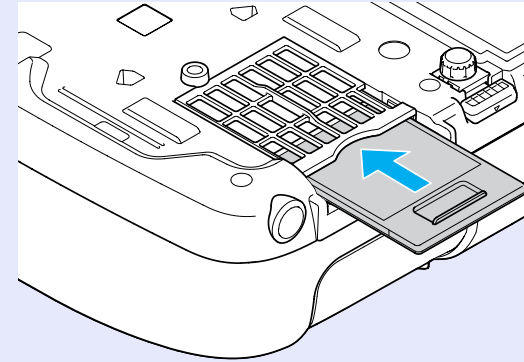

Dispose of used air filters properly in accordance with your local regulations.

Material quality of the frame section: Polycarbonate, ABS resin

Material quality of the filter section: Polyurethane form

You can save the image that is currently being projected as a user's logo.



When registering a user logo, the current user logo is erased and the default setting is not resumed.

Procedure

1

Project the image you want to use as the user's logo, and then press the [Menu] button.

Using the remote control

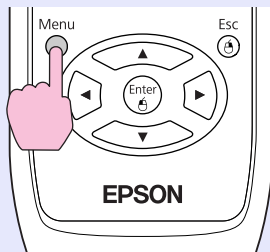

EB-W6

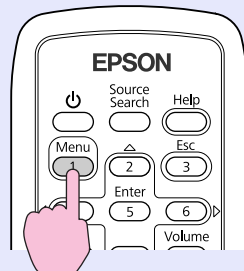

EB-X6/S6

Using the control panel

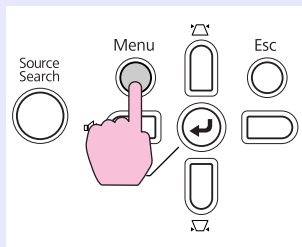

EB-W6/X6

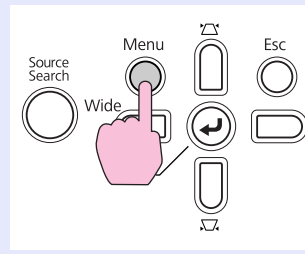

EB-S6

2

From the configuration menu, select "Extended" - "User's Logo".

EB-W6 p.37

EB-X6 p.38

EB-S6 p.39

Check the buttons you can use and the operations they perform in the guide under the menu.

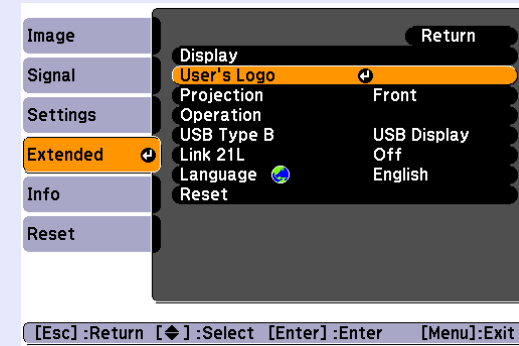

- If "User's Logo Protect" from "Password Protect" is set to "On", a message is displayed and the user's logo cannot be changed. You can make changes after setting "User's Logo Protect" to "Off". p.31
- If "User's Logo" is selected when Keystone, E-Zoom, or Aspect are being performed, the function currently being performed is cancelled.

- When "Choose this image as the User's Logo?" is displayed, select "Yes".



When you press the [Enter] button on the remote control or the control panel, the screen size may change as it changes to the resolution of the image signal.

- Move the box to select the part of the image to use as the user's logo.

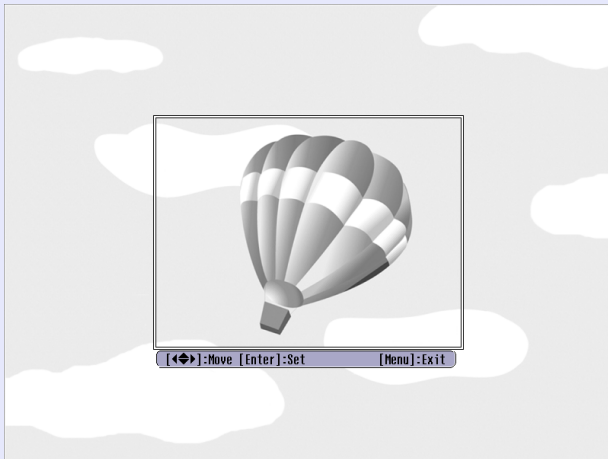

Using the remote control

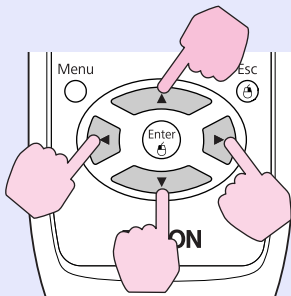

EB-W6

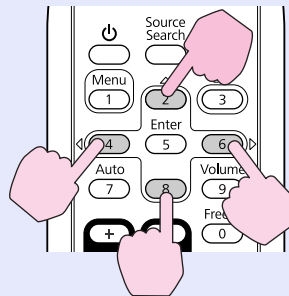

EB-X6/S6

Using the control panel

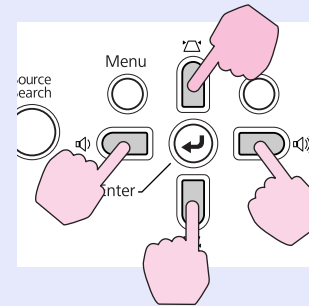

EB-W6/X6

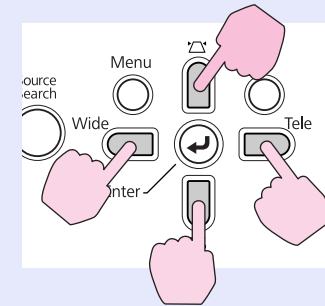

EB-S6



You can save at up to 400 × 300 dots in size.

- When "Select this image?" is displayed, select "Yes".
- Select the zoom factor from the zoom setting screen.

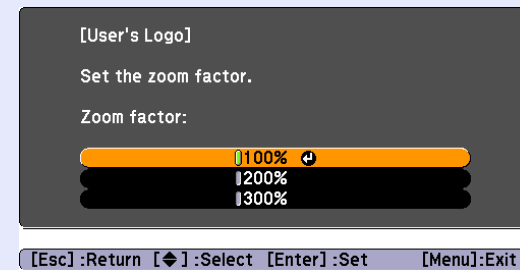



When the message "Save this image as the User's Logo?" is displayed, select "Yes".

The image is saved. After the image has been saved, the message "Completed" is displayed.



Saving the user's logo may take about 15 seconds. Do not use the projector or any connected equipment while it is saving. This may cause malfunctions to occur.

See the following table to choose the best position for your projector. The values are only a guide.

EB-W6

Units: cm (in.)

16:10 Screen Size		Projection Distance A	B
		Minimum (Wide) to Maximum (Tele)	
30"	65 × 40 (26 × 16)	94 to 113 (37 to 45)	0 (0)
40"	86 × 54 (34 × 21)	126 to 152 (50 to 60)	0 (0)
50"	110 × 67 (43 × 26)	158 to 191 (62 to 75)	0 (0)
60"	130 × 81 (51 × 32)	191 to 230 (75 to 90)	0 (0)
80"	170 × 110 (67 × 43)	255 to 307 (101 to 121)	0 (0)
100"	220 × 130 (87 × 51)	320 to 385 (126 to 152)	0 (0)
120"	260 × 160 (102 × 63)	385 to 463 (152 to 182)	0 (0)
150"	320 × 200 (126 × 79)	482 to 579 (190 to 228)	0 (0)
200"	430 × 270 (169 × 106)	644 to 774 (253 to 305)	0 (0)
250"	540 × 340 (213 × 134)	806 to 968 (317 to 381)	0 (0)

Units: cm (in.)

4:3 Screen Size		Projection Distance A	B
		Minimum (Wide) to Maximum (Tele)	
30"	61 × 46 (24 × 18)	106 to 129 (42 to 51)	0 (0)
40"	81 × 61 (32 × 24)	143 to 173 (56 to 68)	0 (0)
50"	100 × 76 (39 × 30)	180 to 217 (71 to 85)	0 (0)
60"	120 × 91 (47 × 36)	216 to 260 (85 to 103)	0 (0)
70"	140 × 110 (55 × 43)	253 to 304 (100 to 120)	0 (0)
80"	160 × 120 (63 × 47)	290 to 348 (114 to 137)	0 (0)
100"	200 × 150 (79 × 59)	363 to 436 (143 to 172)	0 (0)
150"	300 × 230 (118 × 91)	546 to 656 (215 to 258)	0 (0)
200"	410 × 300 (161 × 118)	729 to 876 (287 to 345)	0 (0)
235"	480 × 360 (189 × 142)	857 to 1030 (338 to 406)	0 (0)

Units: cm (in.)

16:9 Screen Size		Projection Distance A	B
		Minimum (Wide) to Maximum (Tele)	
30"	66 × 37 (26 × 15)	96 to 116 (38 to 46)	+2 (+0.8)
40"	89 × 50 (35 × 20)	130 to 156 (51 to 62)	+3 (+1.1)
50"	110 × 62 (43 × 24)	163 to 196 (64 to 77)	+3 (+1.4)
60"	130 × 75 (51 × 30)	196 to 236 (77 to 93)	+4 (+1.6)
70"	150 × 87 (59 × 34)	229 to 276 (90 to 109)	+5 (+1.9)
80"	180 × 100 (71 × 39)	263 to 316 (103 to 124)	+6 (+2.2)
100"	220 × 120 (87 × 47)	329 to 396 (130 to 156)	+7 (+2.7)
150"	330 × 190 (130 × 75)	495 to 596 (195 to 234)	+10 (+4.1)
200"	440 × 250 (173 × 98)	662 to 795 (261 to 313)	+14 (+5.5)
260"	580 × 320 (228 × 126)	861 to 1035 (339 to 407)	+18 (+7.1)

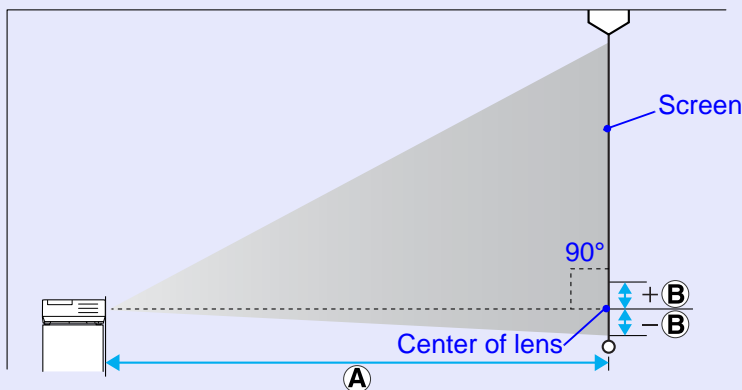

B is the distance from the lens center to the bottom of the screen (top of the screen when hung from the ceiling).

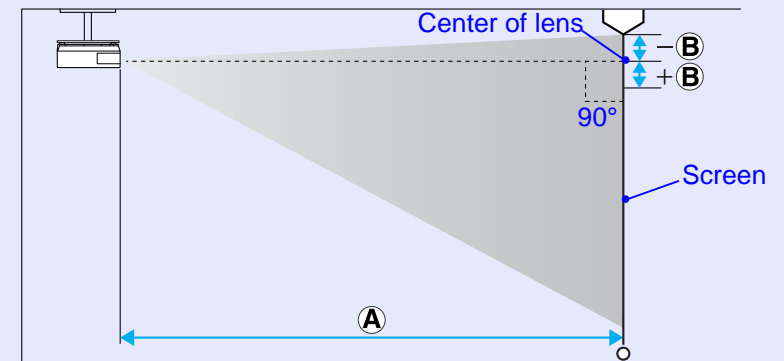

EB-X6

Units: cm (in.)

4:3 Screen Size		Projection Distance A	
		Minimum (Wide) to Maximum (Tele)	B
30"	61 × 46 (24 × 18)	84 to 101 (33 to 40)	-5 (-1.9)
40"	81 × 61 (32 × 24)	113 to 136 (44 to 53)	-6 (-2.5)
50"	100 × 76 (39 × 30)	142 to 171 (56 to 67)	-8 (-3.1)
60"	120 × 91 (47 × 36)	171 to 206 (67 to 81)	-10 (-3.8)
80"	160 × 120 (63 × 47)	229 to 275 (90 to 108)	-13 (-5)
100"	200 × 150 (79 × 59)	287 to 345 (113 to 136)	-16 (-6.3)
150"	300 × 230 (118 × 91)	432 to 519 (170 to 204)	-24 (-9.4)
200"	410 × 300 (161 × 118)	577 to 693 (227 to 273)	-32 (-12.5)
250"	510 × 380 (201 × 150)	722 to 867 (284 to 341)	-40 (-15.6)
300"	610 × 460 (240 × 181)	867 to 1041 (341 to 410)	-48 (-18.8)

Units: cm (in.)

16:9 Screen Size		Projection Distance A	
		Minimum (Wide) to Maximum (Tele)	B
30"	66 × 37 (26 × 15)	91 to 110 (36 to 43)	+1 (+0.4)
40"	89 × 50 (35 × 20)	123 to 148 (48 to 58)	+1 (+0.5)
50"	110 × 62 (43 × 24)	155 to 186 (61 to 73)	+2 (+0.7)
60"	130 × 75 (51 × 30)	186 to 224 (73 to 88)	+2 (+0.8)
80"	180 × 100 (71 × 39)	249 to 300 (98 to 118)	+3 (+1.1)
100"	220 × 120 (87 × 47)	313 to 376 (123 to 148)	+3 (+1.4)
150"	330 × 190 (130 × 75)	471 to 566 (185 to 223)	+5 (+2)
200"	440 × 250 (173 × 98)	629 to 755 (247 to 297)	+7 (+2.7)
250"	550 × 310 (217 × 122)	787 to 945 (310 to 372)	+9 (+3.4)
275"	610 × 340 (240 × 134)	866 to 1040 (341 to 409)	+10 (+3.7)

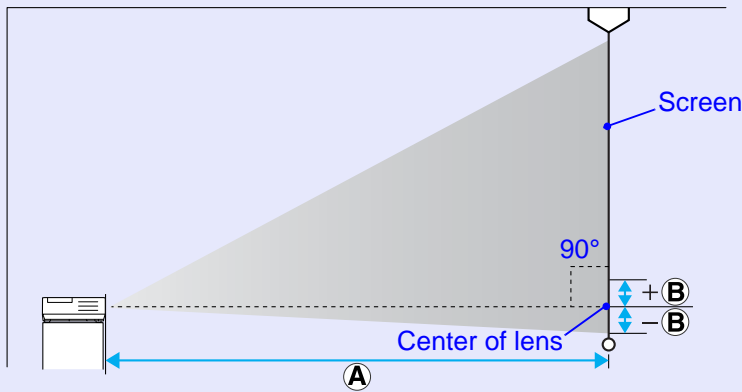

B is the distance from the lens center to the bottom of the screen (top of the screen when hung from the ceiling).

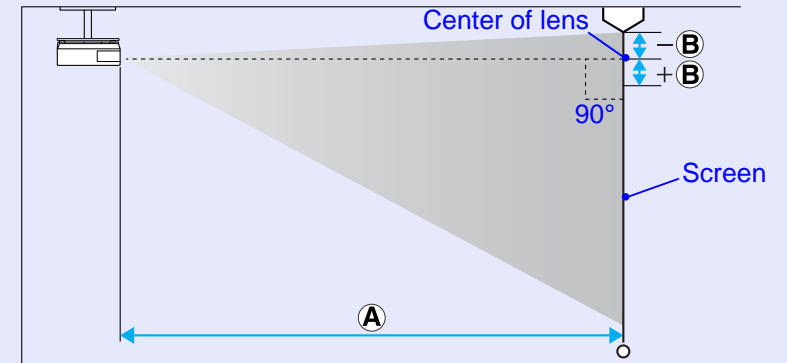

EB-S6

Units: cm (in.)

4:3 Screen Size		Projection Distance A	B
		Minimum (Wide) to Maximum (Tele)	Minimum (Wide) to Maximum (Tele)
30"	61 × 46 (24 × 18)	87 to 119 (34 to 47)	-4 to +2 (-1.7 to +0.9)
50"	100 × 76 (39 × 30)	147 to 200 (58 to 79)	-7 to +4 (-2.8 to +1.4)
60"	120 × 91 (47 × 36)	177 to 240 (70 to 95)	-9 to +4 (-3.4 to +1.7)
70"	140 × 110 (55 × 43)	207 to 281 (82 to 110)	-10 to +5 (-4 to +2)
80"	160 × 120 (63 × 47)	237 to 321 (93 to 126)	-11 to +6 (-4.5 to +2.3)
100"	200 × 150 (79 × 59)	297 to 402 (117 to 158)	-14 to +7 (-5.7 to +2.9)
150"	300 × 230 (118 × 91)	447 to 605 (176 to 238)	-22 to +11 (-8.5 to +4.3)
200"	410 × 300 (161 × 118)	597 to 807 (235 to 318)	-29 to +15 (-11.3 to +5.7)
300"	610 × 460 (240 × 181)	897 (353)	-43 (-17)
350"	710 × 530 (280 × 209)	1047 (412)	-50 (-19.8)

Units: cm (in.)

16:9 Screen Size		Projection Distance A	B
		Minimum (Wide) to Maximum (Tele)	Minimum (Wide) to Maximum (Tele)
30"	66 × 37 (26 × 15)	95 to 130 (37 to 51)	+2 to +9 (+0.6 to +3.4)
50"	110 × 62 (43 × 24)	161 to 218 (63 to 86)	+3 to +14 (+1 to +5.6)
60"	130 × 75 (51 × 30)	193 to 262 (76 to 103)	+3 to +17 (+1.2 to +6.8)
70"	150 × 87 (59 × 34)	226 to 306 (89 to 120)	+4 to +20 (+1.4 to +7.9)
80"	180 × 100 (71 × 39)	259 to 350 (102 to 138)	+4 to +23 (+1.6 to +9)
100"	220 × 120 (87 × 47)	324 to 438 (128 to 173)	+5 to +29 (+2 to +11.3)
150"	330 × 190 (130 × 75)	487 to 659 (192 to 259)	+8 to +43 (+3 to +16.9)
200"	440 × 250 (173 × 98)	651 to 880 (256 to 346)	+10 to +57 (+4 to +22.6)
300"	660 × 370 (260 × 146)	978 (385)	+15 (+6)
320"	710 × 400 (280 × 157)	1043 (411)	+16 (+6.4)

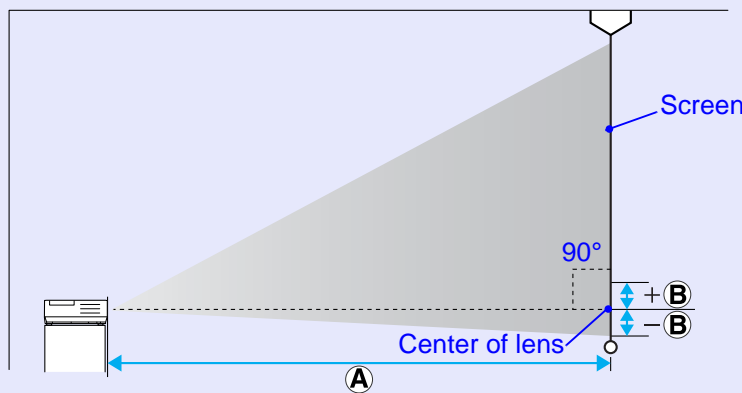

B is the distance from the lens center to the bottom of the screen (top of the screen when hung from the ceiling).

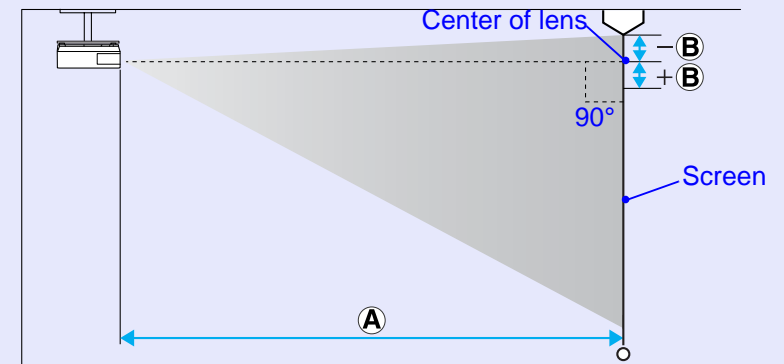

Connecting to an External Monitor (EB-X6/S6 only)

Computer images being input the Computer Input port can be displayed on an external monitor and the screen at the same time when connected to the projector. This means that you can check projected images on an external monitor when giving presentations even if you cannot see the screen.

Connect to an external monitor using the cable supplied with the monitor.

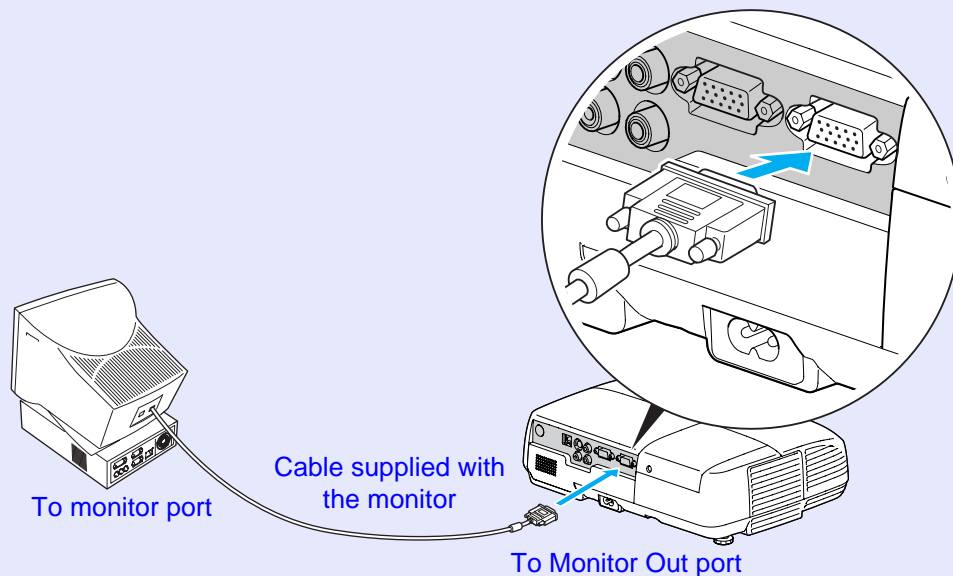

- ***Component video signals and images from equipment connected to the Video port and S-Video port cannot be output to an external monitor.***
- ***The setting gauge for Keystone, the configuration and help screen, and so on are not output to an external monitor.***

You can connect a digital camera, hard disk drive and USB memory compatible with USB 2.0 or 1.1. You can project image files from a connected digital camera or USB storage device in Slideshow.

p.90

Connecting a USB Device

This section explains how to connect USB devices using the digital camera as an example.

Connect with a specified USB cable or one supplied with the digital camera.



Use a USB cable of up to 3 meters in length. If the cable length is over 3 meters, the slideshow may not operate normally.

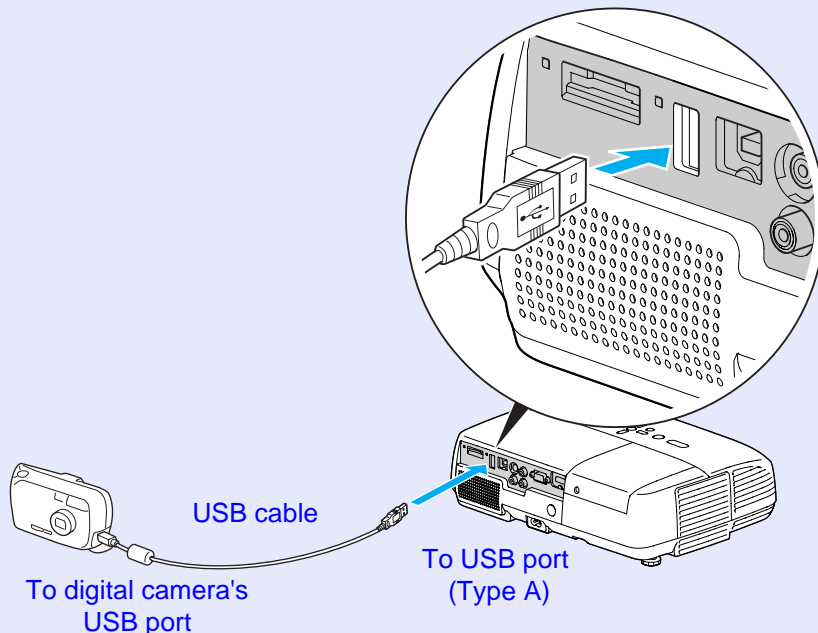

Attention

- *Normal operation is not possible when using a USB hub. Connect the projector directly to a digital camera or USB storage device.*
- *When connecting a USB compatible hard disk drive, be sure to use the hard disk drive's accessory AC adaptor.*

Reading the Indicators

The USB indicator colors are lit as follows to indicate the status of the USB device connected to the projector.

: Lit : Off

Indicators	Status
<input checked="" type="checkbox"/> (orange)	A USB device is connected.
<input checked="" type="checkbox"/> (green)	A Slideshow of images from the connected device is being played.
<input type="checkbox"/>	A USB device is not connected.

Removing a USB Device

After finishing projecting, use the following procedure to remove USB devices from the projector.

Procedure

- 1 Turn off power for the digital camera or USB device.
- 2 Remove from the projector's USB port (Type A).

You can project image files from a inserted SD card or SDHC (SD High Capacity) card in Slideshow.  p.90
From here on these are referred to as SD cards.
The following explains how to insert and eject SD cards.

Inserting a SD Card

Attention

Insert the SD card so that it faces the correct direction. Inserting a card in the wrong direction may result in malfunction or damage.

Procedure

Insert the SD card into the card slot with its top surface facing up.

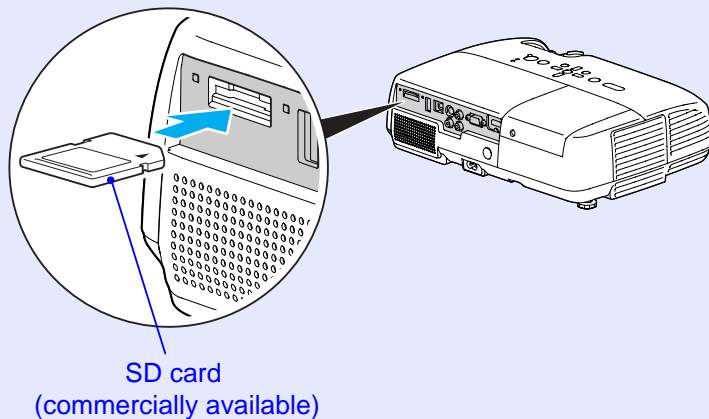

Firmly insert the card as far as it can go.



Reading the SD Card Access Lamp

The SD card access lamp is lit or flashing as follows to indicate the access status of the SD card.

: Flashing : Lit : Off

Lamp	Status
	Reading data from the SD card.
	SD card is standing by.
	SD card is not being accessed.

Ejecting a SD Card

Attention

Do not remove the card while its access lamp is flashing. You may damage the card or projector.

Procedure

- 1** Lightly press the SD card.
The SD card ejects.

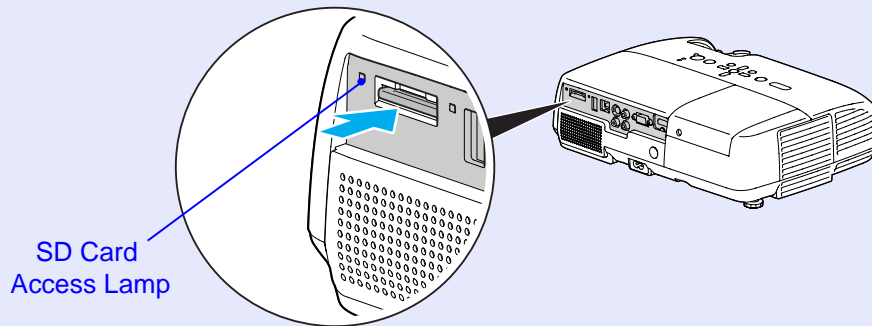

- 2** Grip the SD card and pull it straight out.

The projector can project computer images when connected via the supplied USB cable to a Windows computer. This function is called USB Display. Computer images can quickly be projected simply by connecting with a USB cable.

Attention

Do not connect via a USB hub: connect the projector directly to the computer.

How to Connect (For EB-W6)

Procedure

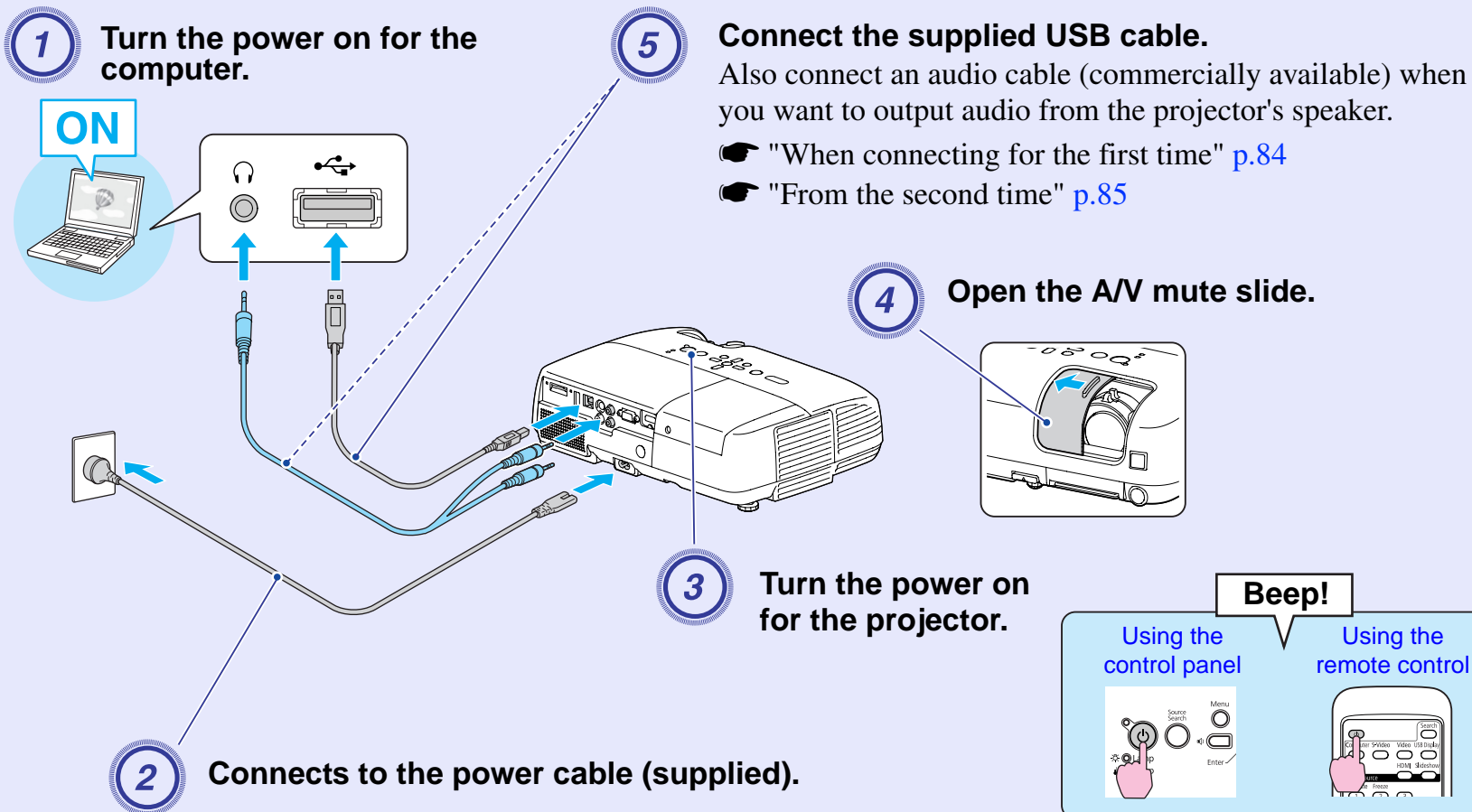

How to Connect (For EB-X6/S6)

Procedure

- 1** Turn the power on for the computer.

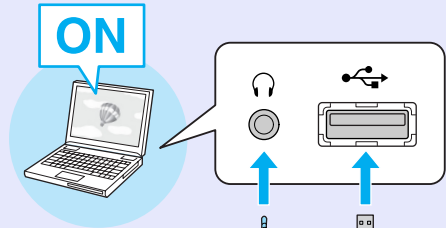

- 5** Connect the supplied USB cable.
 Also connect an audio cable (commercially available) when you want to output audio from the projector's speaker.
- ☛ "When connecting for the first time" [p.84](#)
 - ☛ "From the second time" [p.85](#)

- 4** Open the A/V mute slide.

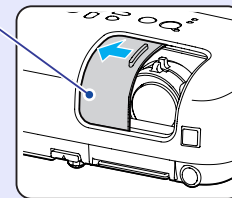

- 3** Turn the power on for the projector.

- 2** Connects to the power cable (supplied).

Beep!

Using the control panel

EB-X6 EB-S6

Using the remote control

■ When connecting for the first time

When you are using Windows 2000, double-click "My Computer" - "EPSON_PJ_UD" - "EMP_UDSE.EXE", on your computer.

1 Driver installation starts automatically.

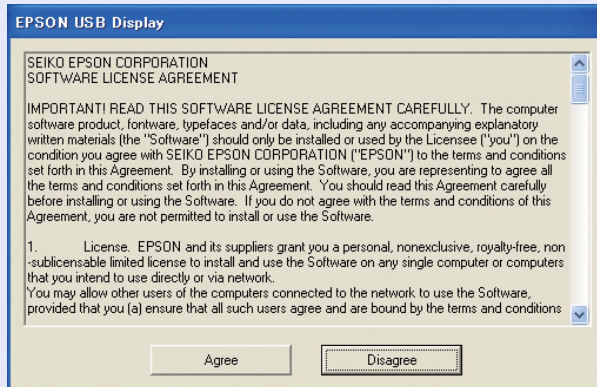

When using user authorization with a Windows 2000 computer, a Windows error message may be displayed and installation may not be possible. In this case, update Windows to the latest status and then reconnect. For more details, contact the nearest address provided in the *Support and Service Guide*. [Epson Projector Contact List](#)

2 Select "Agree".

You cannot run USB Display if the driver is not installed. Be sure to select "Agree". If you want to cancel installation, select "Disagree".

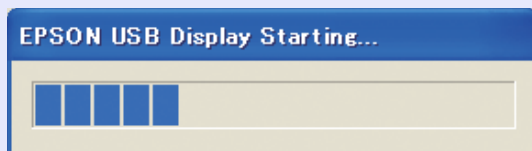

3 Computer images are projected.

It may take a little time before computer images are projected. Until computer images are projected, leave the equipment as it is and do not disconnect the USB cable or turn off the power to the projector.

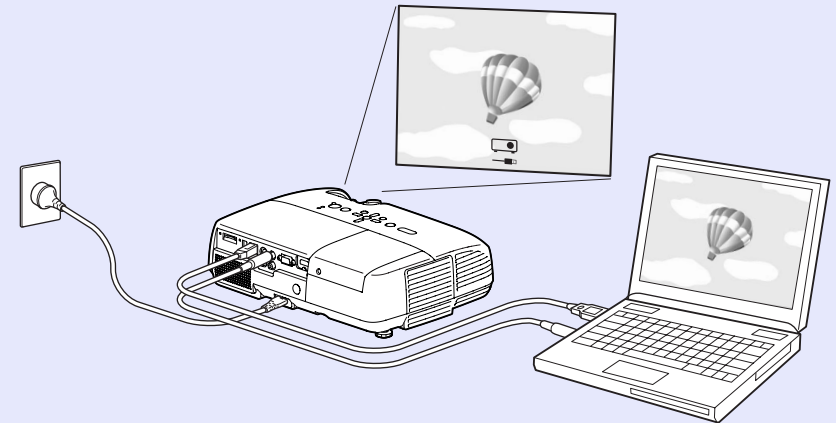

- **When images are not projected, click "All Programs" - "EPSON Projector" - "EPSON USB Display" - "EPSON USB Display Vx.x".**
- **When automatic installation is not performed, double-click "EMP_UDSE.EXE" under "My Computer" - "EPSON_PJ_UD".**
- **To uninstall the driver, click "Change/Remove" under "Start" - "Control Panel" - "Add or Remove Programs" - "EPSON USB Display".**
- **Disconnecting**
The projector can be disconnected simply by disconnecting the USB cable. There is no need to use the "Safely Remove Hardware" feature in Windows.





■ From the second time

Computer images are projected.

It may take a little time before computer images are projected. Leave the equipment as it is during this period.

Connect the computer's USB port and the USB port (Type B) on the rear of the projector with a supplied USB cable to use functions other than those available with USB Display. Refer to the pages indicated for method of use. Further, these functions cannot be used simultaneously with USB Display.



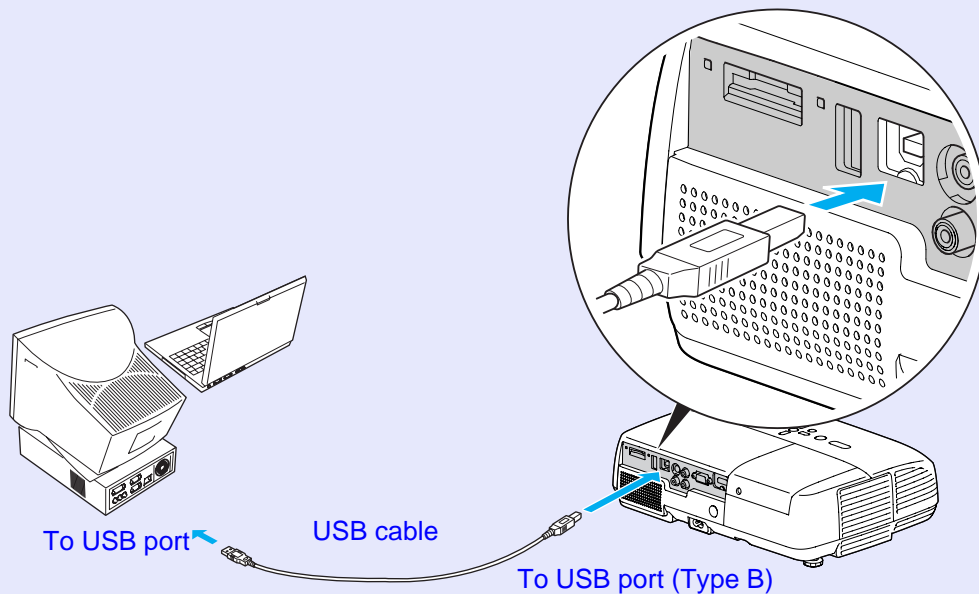

- Use the [Page] (+)/(-) buttons on the remote control to Page Up/Down.  p.86
- Operating the mouse pointer by remote control.  p.87
- Control by sending commands from the computer to the projector.  p.100



Page Up/Down by Remote Control

When projecting a computer screen image, you can operate Page Up/Down with the supplied remote control if the computer is not nearby.

Procedure

- 1 Connect the computer to the projector by USB cable.**
 - EB-W6  p.82
 - EB-X6/S6  p.83
- 2 Set "Extended" - "USB Type B" to "Page Up/Down" under the configuration menu.**
 - When using USB Display, set "Extended" - "USB Type B" to "USB Display" under the configuration menu.  p.82
 - You cannot use the Page Up/Down function and the Wireless Mouse function simultaneously.  p.87

Compatible computer

Windows 98/98SE/2000/Me/XP Home Edition/XP Professional
Vista Home Basic/Vista Home Premium/Vista Business/Vista Enterprise/Vista Ultimate
Mac OS X 10.3 to 10.5

Example of Use: When showing a slideshow in PowerPoint, the previous and next slides are displayed as follows.

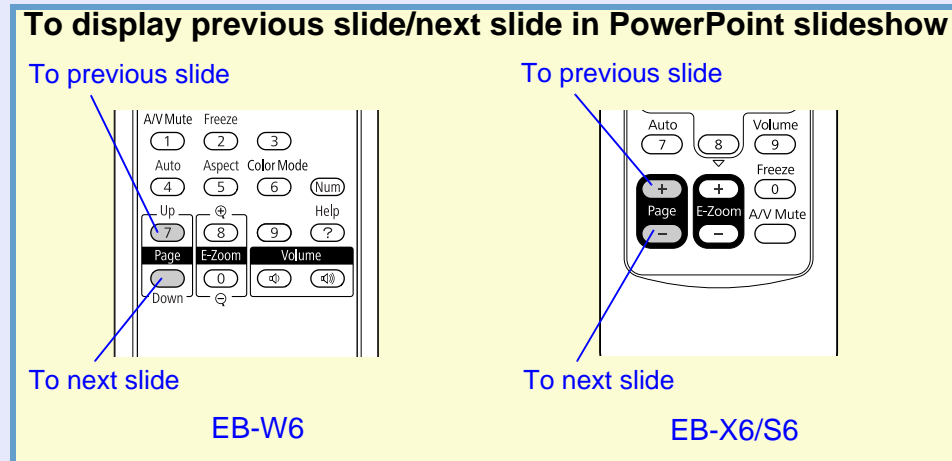

Operating the Mouse Pointer by Remote Control (Wireless Mouse function)

The supplied remote control has a mouse pointer operation function. This function is called Wireless Mouse function.



You can use this when the current input source is the computer or HDMI (EB-W6 only).



- You cannot use the *Wireless Mouse function* during use of *USB Display*.
- You cannot use the *Wireless Mouse function* and *Page Up/Down* simultaneously.

Procedure

- 1** Connect the computer to the projector by USB cable.

EB-W6  p.82
EB-X6/S6  p.83
- 2** Set "Extended" - "USB Type B" to "Wireless Mouse" under the configuration menu.

Compatible computer

Windows 98/98SE/2000/Me/XP Home Edition/XP Professional
Vista Home Basic/Vista Home Premium/Vista Business/Vista Enterprise/Vista Ultimate
Mac OS X 10.3 to 10.5



- *You may not be able to use the Wireless Mouse function depending on your version of the Windows or Macintosh operating system.*
- *You may need to make settings on the computer side to use the mouse. Refer to the computer's documentation for more detailed information.*

After connecting, you can use the mouse pointer in the following ways.

■ **Wireless mouse operation (EB-W6 only)**

Moving mouse pointer

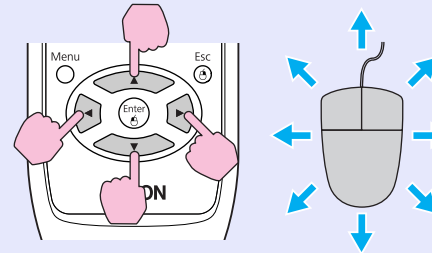

Mouse click operation

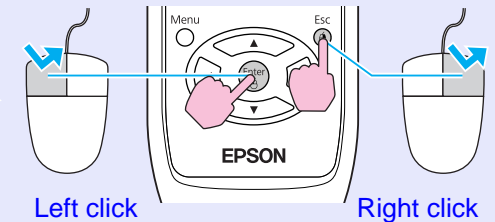

Drag and drop

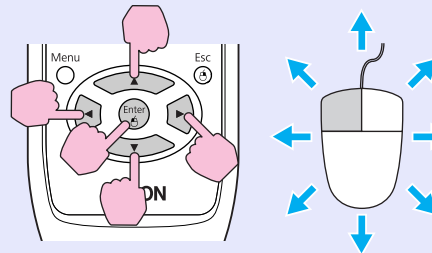

- (1) Hold down [Enter] and press [Left button] to drag.
- (2) Release [Enter] at any position to drop.

■ Wireless Mouse operation (EB-X6/S6 only)

Moving mouse pointer

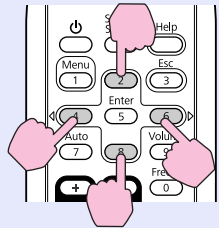

Mouse click operation

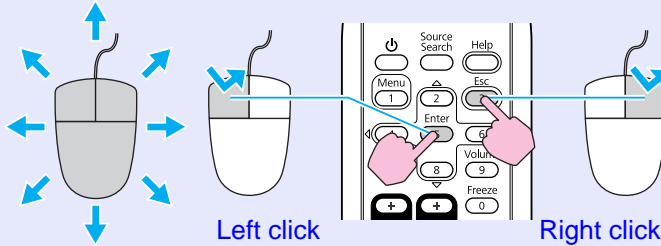

Double click: Press the button rapidly twice.

Drag and drop

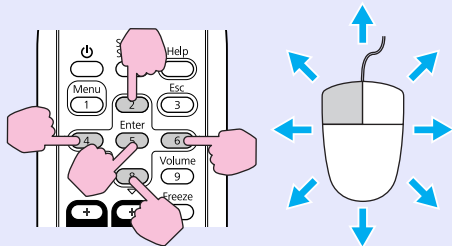

- (1) Hold down [Enter] and press [▲▶▼◀] to drag.
- (2) Release [Enter] at any position to drop.



- *When the left and right mouse buttons are set oppositely on your computer, the remote control operations are also reversed.*
- *You cannot use the Wireless Mouse function when using the following functions.*
 - *Using the Configuration Menu*
 - *Using the Help Menu*
 - *Using E-Zoom*
 - *Capturing a user's logo*
 - *Adjusting the volume*

You can make presentations by connecting the projector to a digital camera, USB storage device or SD card. The image files stored on these devices can be projected directly. This makes projection easy, since it is not necessary to connect a computer.

Image Files that can be Projected in a Slideshow

The image files that can be projected in a slideshow are as follows.

Type	File type (extension)	Comment
Still images only	.jpg	Shall be JPEG files that support the Exif standard. Images with a resolution above 8176 x 6144 cannot be projected. The horizontal/vertical pixel count of the image shall be multiples of 8.



- **USB storage devices that have a security function cannot be used.**
- **Due to the characteristics of JPEG files, if the compression ratio is high the image may not be projected properly.**
- **Movie files cannot be projected.**

Basic Slideshow Operations

The following explains the basic operating method for Slideshow. The following operations are all performed by remote control. Therefore the button names refer to buttons on the remote control.

Starting Slideshow

Procedure

Slideshow starts automatically when the projector is connected to a USB storage device or SD card.

Refer to the following for how to connect a USB storage device or SD card.

Connecting a USB storage device:  p.79

Connecting a SD card:  p.80



During projection of images from another source, the projector will switch to the device you connect as soon as you press the [Slideshow] button.

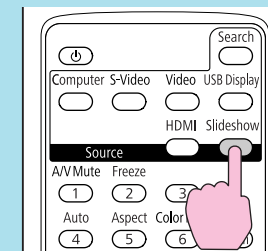

■ Exiting Slideshow

Procedure

To end a slideshow, remove the connected USB storage device or SD card.

Refer to the following for how to remove a USB storage device or SD card.

Removing a USB storage device:  p.79

Removing a SD card:  p.81

■ Slideshow file browser screen

The following kind of screen is displayed when the slideshow begins. This screen is called the file browser screen.



When the projector is connected to multiple storage devices, the following kind of drive selection screen is displayed containing icons that indicate the type of storage. In this case, press the  button, and after selecting the drive for the content you want to display, press the [Enter] button.

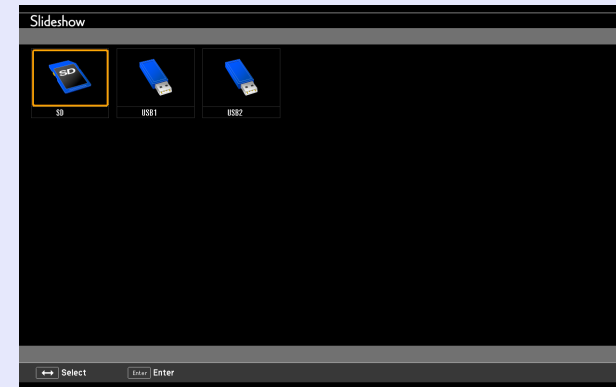

You can connect up to 5 storage devices simultaneously: 1 SD card and 4 USB storage devices.

The following explains the file browser screen.



The following table explains about each menu item and content of the file browser screen and how they work when selected and accepted with the [Enter] button.

Item names	Function
Status display	This lets you check the drive, folder, current page being displayed and total number of pages.
Control panel (top)	Back to Top: Moves to one level upper folder. Previous page: Displays the previous page when there is a previous page. Select drive: Move to a drive selection screen.

Item names	Function
Contents screen	Displays folder and thumbnails of image files. <ul style="list-style-type: none"> • Press the [Enter] button, and select a folder or thumbnail image file. The selected folder and image file are surrounded by a colored border (cursor). • The contents screen runs to multiple pages according to the number of folders and image files. • When you select an image file and press the [Enter] button, the selected image file is played. • When you select a folder and press the [Enter] button, the contents of the folder are displayed. • When you select the "Back to Top" icon and press the [Enter] button, the content display switches to one level upper folder. When displaying a folder in the top level, this icon is not displayed. • JPEG images, which cannot be displayed in thumbnails are indicated by an icon as shown. 
Control panel (bottom)	Option: Displays the option screen. Next page: Displays the next page when there is a next page. Slideshow: Starts Slideshow.
Operation guide	Operation guide is displayed according to the item selected. Can operate with the button concerned.



When contents cover several pages, change page displays by pressing [Page] (+) / (-).

■ Playing individual images

Procedure

- 1 Press the [F5] button, and position the cursor on the image file you want to project.



- 2 Press the [Enter] button.
The selected image file is played.

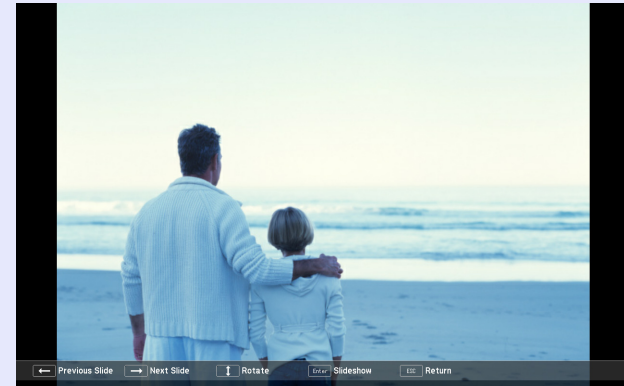

- Position the cursor on the image file, press the [Esc] button, and the following sub-menu is displayed. In this state, you can also play the image file by pressing the [Enter] button.





- During play, press the [F5] button to switch between image files.

■ Running Slideshow

You can play image files in a folder one by one in sequence. This function is known as Slideshow. Run Slideshow by the following procedure. The following explains how to run a slideshow on the contents screen being displayed.

Procedure

- 1 In the file browser screen, display the folder you want to run Slideshow.
- 2 Press the  button and position the cursor over "SlideShow" at the control panel (bottom).
- 3 Press the [Enter] button.
The slideshow runs and images in the folder are projected sequentially one by one.
When the last image is projected in the slideshow, the file browser screen is automatically displayed again. When "Continuous Play" on the option screen is set to "On", the slideshow is automatically repeated.  p.95



- *When you want to start a slideshow from a particular image file, play the file and press the [Enter] button.*
- *When you want to play a slideshow of image files in a particular folder, position the cursor on the folder in the browser and press the [Esc] button. Select "Slideshow" from the displayed submenu, and press the [Enter] button.*

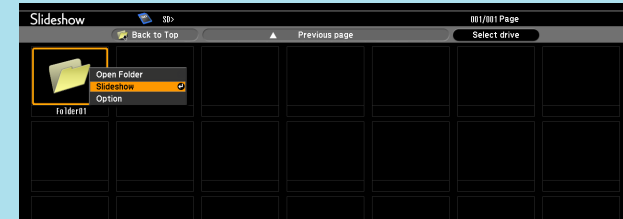

- *You can set conditions such as projecting repeatedly and adding transition effects between images. To change image files automatically when running a slideshow, set the screen switching time in the option menu to other than "No". (When the screen switching time is set to "No", you must change slides manually.)  p.95*

Rotating images

You can rotate the image being played in 90° units. You can also rotate images being played in a slideshow. Use the following procedure to rotate images.

Procedure

- 1 Display a single image file or run a slideshow.
- 2 When an image is displayed, press the [] button or [] button.

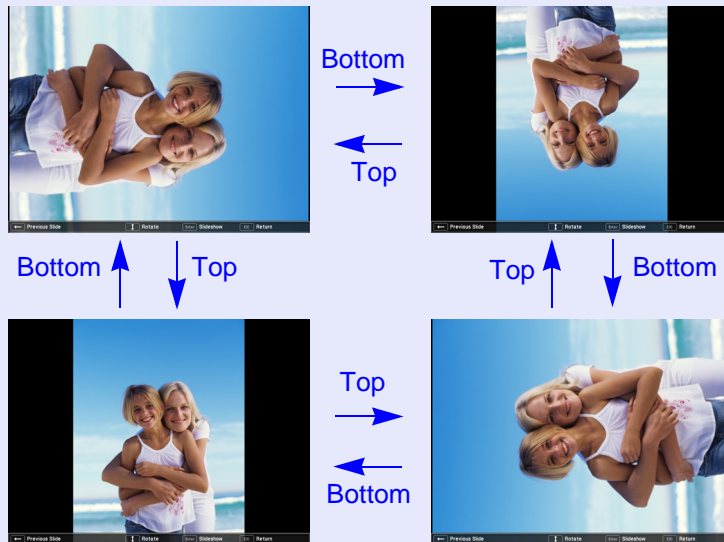

Setting Image File Display and Slideshow.

To set the browser's image display order and set Slideshow, display the option menu.

Procedure

- 1 Press the [] button on the file browser screen, position the cursor over "Option" at the control panel (bottom), and press the [Enter] button. The option screen is displayed.

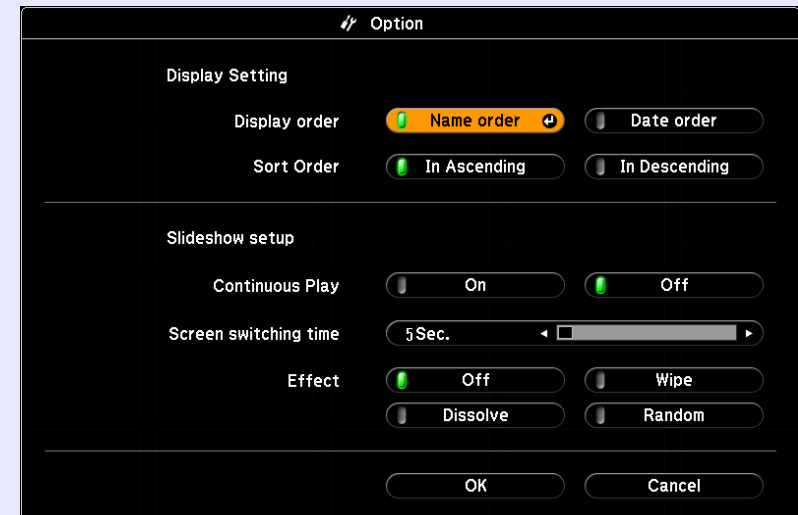

- 2** Position the cursor over the item you want to change, press the [Enter] button, and the setting becomes effective.

Refer to the following table for details of each item.

Item	Function
Display Setting	Sets the order of files for display. Files can be selected in order of name or ascending order of update.
Continuous Play	Sets whether to play Slideshow repeatedly.
Screen switching time	Sets the display time for one file in a slideshow. You can set "No" or "1 to 60 sec". If you set "No", images are not switched automatically.
Effect	Sets transition effects between images.

- 3** Press the  button, position the cursor on "OK", and then press the [Enter] button.

Prepare the following options and consumables. Purchase depending on usage. The following list of optional accessories and consumables is current as of: 2008.07. Details of accessories are subject to change without notice and availability may vary depending on the country of purchase.

■ Optional accessories

Soft carrying case ELPKS16B Use this case if you need to travel with the projector.
60" portable screen ELPSC07
80" portable screen ELPSC08
100" screen ELPSC10
Portable roll-type screens (Aspect ratio ▶▶ 4:3)
50" portable screen ELPSC06 A compact screen that can be carried easily. (Aspect ratio 4:3)
HD-15 cable ELPKC02 (1.8m - for mini D-Sub15-pin/mini D-Sub 15pin) This is the same as the computer cable supplied with the projector.
HD-15 cable ELPKC09 (3m - for mini D-Sub15-pin/mini D-Sub 15pin)
HD-15 PC cable ELPKC10 (20 m - for mini D-Sub15-pin/mini D-Sub 15pin) Use one of these longer cables if the computer cable bundled with the product is too short.
Component video cable ELPKC19 (3 m - for mini D-Sub 15-pin/RCA male×3) Use to connect a component video ▶▶ source

Ceiling plate* ELPFC03
Pipe 370 (370 mm silver)* ELPFP04
Pipe 570 (570 mm silver)* ELPFP05
Pipe 770 (770 mm silver)* ELPFP06

Ceiling mount (For use with the ceiling plate)* ELPMB18 Use when installing the projector on a ceiling.
--

* A special method of installation is required to suspend the projector from a ceiling. Contact your dealer or the nearest address provided in the *Support and Service Guide* if you want to use this installation method.  [Epson Projector Contact List](#)

■ Consumables

Lamp unit ELPLP41 Use as a replacement for used lamps.
Air filter (by 2) ELPAF13 Use as a replacement for used air filters.

This section briefly explains terms that are used with the projector and difficult terms that are not explained in the text of this guide. For details, refer to other commercially available publications.

Aspect ratio	The width-to-height ratio of a projected image or screen. When the width-to-height ratio is 16:9 or 16:10, the elongated screen is known as wide-screen. The aspect ratio for standard images is 4:3.
Component Video	A video signal which has the luminance component and color component separated to provide better image quality. Refers to images that consist of three independent signals: Y (luminance signal), Pb and Pr (color difference signals).
Composite video	Video signals that have the video brightness signals and color signals mixed together. The type of signals commonly used by household video equipment (NTSC, PAL, and SECAM formats). The carrier signal Y (luminance signal) and chroma (color) signal that are contained in the color bar are overlapped to form a single signal.
Contrast	The relative brightness of the light and dark areas of an image can be increased or decreased to make text and graphics stand out more clearly, or to make them appear softer. Adjusting this particular property of an image is called "contrast adjustment".
Dolby Digital	A sound format developed by Dolby Laboratories. Normal stereo is a 2-channel format that uses two speakers. Dolby Digital is a 6-channel (5.1-channel) system which adds to this a center speaker, two rear speakers, and a sub-woofer.
HDTV	An abbreviation for High-Definition Television that refers to high-definition systems which satisfy the following conditions. <ul style="list-style-type: none"> • Vertical resolution of 720p or 1080i or greater (p = <u>progressive</u>, i = <u>interlace</u>) • Screen <u>aspect ratio</u> of 16:9 <u>Dolby Digital</u> audio reception and playback (or output)
Interlace	A method of image scanning whereby the image data is divided into fine horizontal lines that are displayed in sequence starting from left to right and then from top to bottom. The even-numbered lines and odd-numbered lines are displayed alternately.
Progressive	A method of image scanning whereby the image data from a single image is scanned sequentially from top to bottom to create a single image.
Refresh rate	The light-emitting element of a display maintains the same luminosity and color for an extremely short time. Because of this, the image must be scanned many times per second to refresh the light-emitting element. The number of refresh operations per second is called the Refresh rate and is expressed in hertz (Hz).
SDTV	An abbreviation for Standard Definition Television that refers to standard television systems which do not satisfy the conditions for <u>HDTV</u> High-Definition Television.
Squeeze mode	In this mode, wide-screen images in 16:9 mode are compressed in the horizontal direction so that they are stored on the recording medium as 4:3 images. When these images are played back by the projector in squeeze mode, they are restored to their original 16:9 format.
sRGB	An international standard for color intervals that was formulated so that colors that are reproduced by video equipment can be handled easily by computer operating systems (OS) and the Internet. If the connected source has an sRGB mode, set both the projector and the connected signal source to sRGB.
SVGA	A type of video signal with a resolution of 800 (horizontal) × 600 (vertical) dots that is used by IBM PC/AT-compatible computers.
S-Video	A video signal which has the luminance component and color component separated to provide better image quality. Refers to images that consist of two independent signals: Y (luminance signal) and C (color signal).

SXGA	A type of video signal with a resolution of 1280 (horizontal) × 1024 (vertical) dots that is used by IBM PC/AT-compatible computers.
Synchronization	The signals output from computers have a specific frequency. If the projector frequency does not match this frequency, the resulting images are not of a good quality. The process of matching the phases of these signals (the relative position of the crests and the troughs in the signal) is called Synchronization. If the signals are not synchronized, flickering, blurriness, and horizontal interference occur.
Tracking	The signals output from computers have a specific frequency. If the projector frequency does not match this frequency, the resulting images are not of a good quality. The process of matching the frequency of these signals (the number of crests in the signal) is called Tracking. If tracking is not carried out correctly, wide vertical stripes appear in the signal.
VGA	A type of video signal with a resolution of 640 (horizontal) × 480 (vertical) dots that is used by IBM PC/AT-compatible computers.
XGA	A type of video signal with a resolution of 1024 (horizontal) × 768 (vertical) dots that is used by IBM PC/AT-compatible computers.

Command List

The ESC and VP21 commands are commands sent from the computer to control the projector.

When the power ON command is transmitted to the projector, the power turns on and it enters warm-up mode. When the projector's power has turned on, a colon ":" (3Ah) is returned.

When a command is input, the projector executes the command and returns a ":", and then accepts the next command.

If the command being processed terminates due to a problem, an error message is output and a ":" is returned.

Item		Command
Power ON/OFF	ON	PWR ON
	OFF	PWR OFF
Signal selection	Video	SOURCE 41
	S-Video	SOURCE 42
	HDMI (EB-W6 only)	SOURCE 30
	USB Display	SOURCE 51
	Slideshow (EB-W6 only)	SOURCE 52
A/V Mute ON/OFF	ON	MUTE ON
	OFF	MUTE OFF
A/V Mute selection	Black	MSEL 00
	Blue	MSEL 01
	Logo	MSEL 02
Item		Command
Signal selection	Computer (Auto)	SOURCE 1F
	Computer	SOURCE 11

* Add a Carriage Return (CR) code (0Dh) to the end of each command and transmit.

Cable Layouts

■ USB connection

Connector shape: USB (Type B)

<At the projector>

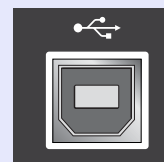

(Type B)

<At the computer>

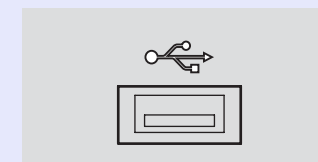

USB Connection Setup

To control the projector with ESC/VP21 commands using communication via USB connection, it is necessary to set "Extended" - "USB Type B" from the configuration menu to something other than "USB Display". In addition to that, the following preparations are required.

Procedure

- 1 Download the USB driver (USB-COM Driver) from the Epson Web site to your computer.**
Go to <http://www.epson.com> and select the support section of your local Epson Web site.
- 2 Install the downloaded USB driver onto your computer.**
Read the instructions displayed on the download screen.
- 3 Set "Extended" - "Link 21L" to "On" from the projector's configuration menu.**

EB-W6

■ Computer images (analog RGB)

Signal	Refresh Rate [▶] (Hz)	Resolution (dots)	Aspect Mode				
			Normal	16:9	Full	Zoom	Through
VGAEGA	70	640×350	1280×700	1280×720	1280×800	1280×700	640×350
<u>VGA</u> ^{▶▶}	60/72/75/85, iMac ^{*1}	640×480/640×360 ^{*2}	1066×800	1280×720	1280×800	1280×800	640×480
<u>SVGA</u> ^{▶▶}	56/60/72/75/85, iMac ^{*1}	800×600/800×450 ^{*2}	1066×800	1280×720	1280×800	1280×800	800×600
<u>XGA</u> ^{▶▶}	60/70/75/85, iMac ^{*1}	1024×768/1024×576 ^{*2}	1066×800	1280×720	1280×800	1280×800	1024×768
WXGA	60	1280×768	1280×768	1280×720	1280×800	1280×768	1280×768
	60	1360×768	1280×722	1280×720	1280×800	1280×722	1280×768
	60/75/85	1280×800	1280×800	1280×720	1280×800	1280×800	1280×800
WXGA+	60/75/85	1440×900	1280×800	1280×720	1280×800	1280×800	1280×800
WSXGA+ ^{*3}	60	1680×1050	1280×800	1280×720	1280×800	1280×800	1280×800
<u>SXGA</u> ^{▶▶}	70/75/85	1152×864	1066×800	1280×720	1280×800	1280×800	1280×800
	60/75/85	1280×1024	1000×800	1280×720	1280×800	1280×800	1280×800
	60/75/85	1280×960	1066×800	1280×720	1280×800	1280×800	1280×800
SXGA+	60/75/85	1400×1050	1066×800	1280×720	1280×800	1280×800	1280×800
UXGA	60	1600×1200	1066×800	1280×720	1280×800	1280×800	1280×800
MAC13"	67	640×480	1066×800	1280×720	1280×800	1280×800	640×480
MAC16"	75	832×624	1066×800	1280×720	1280×800	1280×800	832×624
MAC19"	75	1024×768	1066×800	1280×720	1280×800	1280×800	1024×768
	60	1024×768	1066×800	1280×720	1280×800	1280×800	1024×768
MAC21"	75	1152×870	1059×800	1280×720	1280×800	1280×800	1152×800

*1 Connection is not possible if the equipment does not have a VGA output port.

*2 Letterbox signal

*3 This is limited to selection of "Wide" from "Resolution" on the configuration menu.

Even when signals other than those mentioned above are input, it is likely that the image can be projected. However, not all functions may be supported.

■ Component Video

Units: dots

Signal	Refresh rate ^{▶▶} (Hz)	Resolution	Aspect Mode				
			Normal	16:9	Full	Zoom	Through
<u>SDTV</u> ^{▶▶} (480i)	60	720×480/720×360*	1066×800	1280×720	1280×800	1280×800	640×480
SDTV(576i)	50	720×576/720×432*	1066×800	1280×720	1280×800	1280×800	768×576
SDTV(480p)	60	720×480/720×360*	1066×800	1280×720	1280×800	1280×800	640×480
SDTV(576p)	50	720×576/720×432*	1066×800	1280×720	1280×800	1280×800	768×576
<u>HDTV</u> ^{▶▶} (720p)	50/60	1280×720	1280×720	1280×720	1280×800	1280×720	1280×720
HDTV(1080i)	50/60	1920×1080	1280×720	1280×720	1280×800	1280×720	1280×800

* Letterbox signal

■ Composite video/S-video

Units: dots

Signal	Refresh rate ^{▶▶} (Hz)	Resolution	Aspect Mode				
			Normal	16:9	Full	Zoom	Through
TV (NTSC)	60	720×480/720×360*	1066×800	1280×720	1280×800	1280×800	640×480
TV(PAL, SECAM)	50	720×576/720×432*	1066×800	1280×720	1280×800	1280×800	768×576

* Letterbox signal

■ Input signal from HDMI input port

Units: dots

Signal	Refresh rate ^{▶▶} (Hz)	Resolution	Aspect Mode			
			16:9	Full	Zoom	Through
<u>VGA</u> ^{▶▶}	60	640×480/640×360*	1280×720	1280×800	1280×800	640×480
<u>SVGA</u> ^{▶▶}	60	800×600	1280×720	1280×800	1280×800	800×600
<u>XGA</u> ^{▶▶}	60	1024×768	1280×720	1280×800	1280×800	1024×768
<u>SXGA</u> ^{▶▶}	60	1280×960	1280×720	1280×800	1280×800	1280×800
	60	1280×1024	1280×720	1280×800	1280×800	1280×800
SXGA+	60	1400×1050	1280×720	1280×800	1280×800	1280×800
UXGA	60	1600×1200	1280×720	1280×800	1280×800	1280×800
<u>SDTV</u> ^{▶▶} (480i)	60	720×480/720×360*	1280×720	1280×800	1280×800	640×480
SDTV(480p)	60	720×480/720×360*	1280×720	1280×800	1280×800	640×480
SDTV(576i)	50	720×576/720×432*	1280×720	1280×800	1280×800	768×576
SDTV(576p)	50	720×576/720×432*	1280×720	1280×800	1280×800	768×576
<u>HDTV</u> ^{▶▶} (720p)	50/60	1280×720	1280×720	1280×800	1280×720	1280×720
HDTV(1080i)	50/60	1920×1080	1280×720	1280×800	1280×720	1280×800
HDTV(1080p)	50/60	1920×1080	1280×720	1280×800	1280×720	1280×800

* Letterbox signal

EB-X6

■ Computer images (analog RGB)

Units: dots

Signal	Refresh rate ^{▶▶} (Hz)	Resolution	Aspect Mode		
			Normal	4:3	16:9
VGAEGA	70	640×350	1024×560	1024×768	1024×576
<u>VGA</u> ^{▶▶}	60/72/75/85/iMac ^{*1}	640×480/640×360 ^{*2}	1024×768	1024×768	1024×576
<u>SVGA</u> ^{▶▶}	56/60/72/75/85/ iMac ^{*1}	800×600/800×450 ^{*2}	1024×768	1024×768	1024×576
<u>XGA</u> ^{▶▶}	60/70/75/85/iMac ^{*1}	1024×768/1024×576 ^{*2}	1024×768	1024×768	1024×576
WXGA	60	1280×768	1024×614	1024×768	1024×576
	60	1360×768	1024×578	1024×768	1024×576
	60/75	1280×800	1024×640	1024×768	1024×576
WXGA+	60	1440×900	1024×640	1024×768	1024×576
<u>SXGA</u> ^{▶▶}	70/75	1152×864	1024×768	1024×768	1024×576
	60	1280×1024	960×768	1024×768	1024×576
	60	1280×960	1024×768	1024×768	1024×576
SXGA+	60	1400×1050	1024×768	1024×768	1024×576
MAC13"	67	640×480	1024×768	1024×768	1024×576
MAC16"	75	832×624	1024×768	1024×768	1024×576
MAC19"	75	1024×768	1024×768	1024×768	1024×576
	60	1024×768	1024×768	1024×768	1024×576
MAC21"	75	1152×870	1016×768	1024×768	1024×576

*1 Connection is not possible if the equipment does not have a VGA output port.

*2 Letterbox signal

Even when signals other than those mentioned above are input, it is likely that the image can be projected. However, not all functions may be supported.

■ Component Video

Units: dots

Signal	Refresh rate [▶] (Hz)	Resolution	Aspect Mode	
			4:3	16:9
<u>SDTV</u> [▶] (480i)	60	720×480/720×360*	1024×768	1024×576
SDTV(576i)	50	720×576/720×432*	1024×768	1024×576
SDTV(480p)	60	720×480/720×360*	1024×768	1024×576
SDTV(576p)	50	720×576/720×432*	1024×768	1024×576
<u>HDTV</u> [▶] (720p)	50/60	1280×720	1024×768	1024×576
HDTV(1080i)	50/60	1920×1080	1024×768	1024×576

* Letterbox signal

■ Composite video/S-video

Units: dots

Signal	Refresh rate [▶] (Hz)	Resolution	Aspect Mode	
			4:3	16:9
TV (NTSC)	60	720×480/720×360*	1024×768	1024×576
TV(PAL, SECAM)	50	720×576/720×432*	1024×768	1024×576

* Letterbox signal

EB-S6

■ Computer images (analog RGB)

Units: dots

Signal	Refresh rate ^{▶▶} (Hz)	Resolution	Aspect Mode		
			Normal	4:3	16:9
VGAEGA	70	640×350	800×438	800×600	800×450
<u>VGA</u> ^{▶▶}	60/72/75/85/iMac ^{*1}	640×480/640×360 ^{*2}	800×600	800×600	800×450
<u>SVGA</u> ^{▶▶}	56/60/72/75/85/ iMac ^{*1}	800×600/800×450 ^{*2}	800×600	800×600	800×450
<u>XGA</u> ^{▶▶}	60/70/75/85/iMac ^{*1}	1024×768/1024×576 ^{*2}	800×600	800×600	800×450
WXGA	60	1280×768	800×480	800×600	800×450
	60	1360×768	800×451	800×600	800×450
	60/75	1280×800	800×500	800×600	800×450
WXGA+	60	1440×900	800×500	800×600	800×450
<u>SXGA</u> ^{▶▶}	70/75	1152×864	800×600	800×600	800×450
	60	1280×1024	750×600	800×600	800×450
	60	1280×960	800×600	800×600	800×450
SXGA+	60	1400×1050	800×600	800×600	800×450
MAC13"	67	640×480	800×600	800×600	800×450
MAC16"	75	832×624	800×600	800×600	800×450
MAC19"	75	1024×768	800×600	800×600	800×450
	60	1024×768	800×600	800×600	800×450
MAC21"	75	1152×870	794×600	800×600	800×450

*1 Connection is not possible if the equipment does not have a VGA output port.

*2 Letterbox signal

Even when signals other than those mentioned above are input, it is likely that the image can be projected. However, not all functions may be supported.

■ Component Video

Units: dots

Signal	Refresh rate [▶] (Hz)	Resolution	Aspect Mode	
			4:3	16:9
<u>SDTV</u> [▶] (480i)	60	720×480/720×360*	800×600	800×450
SDTV(576i)	50	720×576/720×432*	800×600	800×450
SDTV(480p)	60	720×480/720×360*	800×600	800×450
SDTV(576p)	50	720×576/720×432*	800×600	800×450
<u>HDTV</u> [▶] (720p)	50/60	1280×720	800×600	800×450
HDTV(1080i)	50/60	1920×1080	800×600	800×450

* Letterbox signal

■ Composite video/S-video

Units: dots

Signal	Refresh rate [▶] (Hz)	Resolution	Aspect Mode	
			4:3	16:9
TV (NTSC)	60	720×480/720×360*	800×600	800×450
TV(PAL, SECAM)	50	720×576/720×432*	800×600	800×450

* Letterbox signal

Specifications

Product name	EB-W6		EB-X6		EB-S6	
Dimensions	327 (W) × 92 (H) × 245 (D) mm					
Panel size	0.56"		0.63"		0.55"	
Display method	Polysilicon TFT active matrix					
Resolution	1,024,000 pixels WXGA (1280 (W) × 800 (H) dots) × 3		786,432 pixels XGA (1024 (W) × 768 (H) dots) × 3		480,000 pixels SVGA (800 (W) × 600 (H) dots) × 3	
Focus adjustment	Manual					
Zoom adjustment	Manual (1 to 1.2)				Digital (1.0 to 1.35)	
Lamp	UHE lamp 170 W, Model No.: ELPLP41					
Max. audio output	7 W monaural		1 W monaural			
Speaker	1					
Power supply	100 to 240 V AC ±10%, 50/60 Hz 2.8 to 1.5 A					
Power consumption	100 to 120 V area		Operating: 246 W Standby power consumption: 3.0 W			
	220 to 240 V area		Operating: 231 W Standby power consumption: 4.3 W			
Operating altitude	Altitude 0 to 2286m (0 ft to 7500 ft)					
Operating temperature	5 to +35°C (No condensation)					
Storage temperature	-10 to +60°C (No condensation)					
Mass	Approx. 2.8 kg		Approx. 2.8 kg		Approx. 2.7 kg	

Product name			EB-W6	EB-X6	EB-S6
Connectors	Computer input port	1	Mini D-Sub15-pin (female) blue		
	Audio input port	1	RCA pin jack		
	S-Video input port	1	Mini DIN 4-pin		
	Video input port	1	RCA pin jack		
	Audio input port	1	RCA pin jack		
	HDMI input port	1	HDMI	-	
	Monitor Out port	1	-	Mini D-Sub15-pin (female) black	
	USB port (Type A) ^{*1*3}	1	USB connector (Type A)	-	
	USB port (Type B) ^{*2*3}	1	USB connector (Type B)		
	Card slot	1	SD card x 1	-	

*1 USB Type A supports USB1.1.

*2 USB Type B supports USB2.0.

*3 USB ports are not guaranteed to operate all devices that support USB.

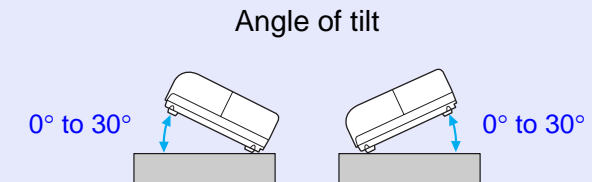

If you use the projector tilted at an angle of more than 30° it could be damaged and cause an accident.



SDHC logo is a trademark.

DECLARATION of CONFORMITY

According to 47CFR, Part 2 and 15
Class B Personal Computers and Peripherals; and/or
CPU Boards and Power Supplies used with Class B
Personal Computers

We: Epson America, Inc.
Located at: 3840 Kilroy Airport Way
MS: 3-13
Long Beach, CA 90806
Tel: 562-290-5254

Declare under sole responsibility that the product identified herein, complies with 47CFR Part 2 and 15 of the FCC rules as a Class B digital device. Each product marketed, is identical to the representative unit tested and found to be compliant with the standards. Records maintained continue to reflect the equipment being produced can be expected to be within the variation accepted, due to quantity production and testing on a statistical basis as required by 47CFR 2.909. Operation is subject to the following two conditions : (1) this device may not cause harmful interference, and (2) this device must accept any interference received, including interference that may cause undesired operation.

Trade Name: EPSON

Type of Product: Projector

Model: H285C/H284C/H283C

**FCC Compliance Statement
For United States Users**

This equipment has been tested and found to comply with the limits for a Class B digital device, pursuant to Part 15 of the FCC Rules. These limits are designed to provide reasonable protection against harmful interference in a residential installation. This equipment generates, uses, and can radiate radio frequency energy and, if not installed and used in accordance with the instructions, may cause harmful interference to radio or television reception. However, there is no guarantee that interference will not occur in a particular installation. If this equipment does cause interference to radio and television reception, which can be determined by turning the equipment off and on, the user is encouraged to try to correct the interference by one or more of the following measures.

- Reorient or relocate the receiving antenna.
- Increase the separation between the equipment and receiver.
- Connect the equipment into an outlet on a circuit different from that to which the receiver is connected.
- Consult the dealer or an experienced radio/TV technician for help.

WARNING

The connection of a non-shielded equipment interface cable to this equipment will invalidate the FCC Certification or Declaration of this device and may cause interference levels which exceed the limits established by the FCC for this equipment. It is the responsibility of the user to obtain and use a shielded equipment interface cable with this device. If this equipment has more than one interface connector, do not leave cables connected to unused interfaces. Changes or modifications not expressly approved by the manufacturer could void the user's authority to operate the equipment.

Operating Requirements of Supplied Software

The following computer requirements must be satisfied to operate USB Display supplied with this projector.

	Requirements
OS	Windows 2000 SP4 Windows XP SP1 Windows XP SP2 Windows Vista Windows Vista SP1
CPU	Mobile Pentium III 1.2GHz or greater Recommended: Pentium M 1.6 GHz or greater
Memory capacity	256 MB or greater Recommended: 512 MB or greater
Hard disk space	256 MB or greater
Display	XGA(1024 × 768) or greater resolution 16 bit color or greater display color Approx. 32,000 color display

External dimensions are the same for the EB-W6/X6/S6, but the EB-S6 differs only in the distance from the lens center to the ceiling mount. The illustration is of the EB-W6.

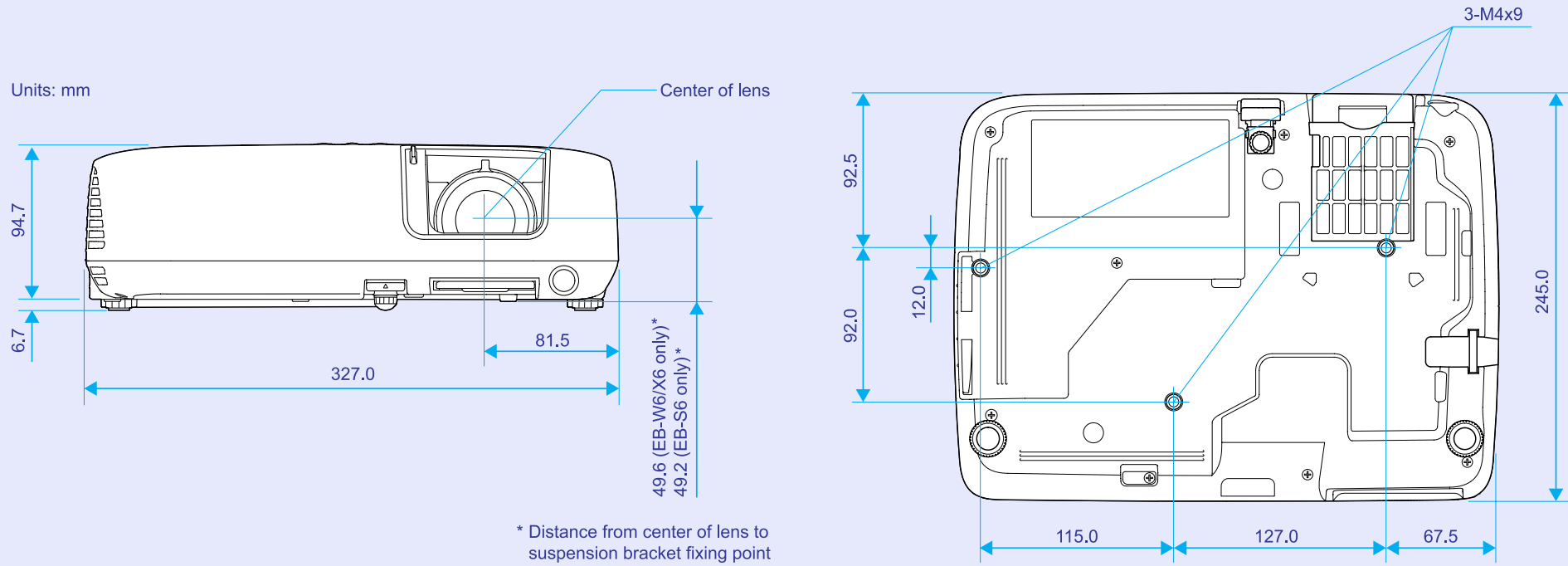

A

A/V Mute	22
A/V mute slide	6
Air exhaust vent	6
Air filter	15
Air filter replacement period	71
Air intake vent	15
Angle of tilt	110
Audio input port	7, 8
Auto Setup	41

B

Blackboard	19
Brightness	40
Brightness Control	43

C

Ceiling	44
Cleaning the air filter and air intake vent	65
Cleaning the projector's surface	65
Color Adjustment	40
Color Mode	19, 40
Color Saturation	40
Computer input port	7, 8
Configuration menu	37
Connecting a USB Cable	86
Connecting a USB Device	79
Consumables	97
Contrast	40
Control panel	9
Control Panel Lock	34, 43
Cross	29

D

Direct Power On	45
Display	44
Display Background	44

E

ESC/VP21	100
Extended menu	44
External dimension diagram	113
External monitor	78
E-zoom	29

F

Focus ring	6
Freeze	23
Front	44
Front adjustable feet	6
Full lock	34

G

Game	19
Glossary	98

H

Help function	49
High Altitude Mode:	45
How to replace the air filter	71
How to replace the lamp	68

I

Image menu	40
Indicators	51
Info menu	46
Input Signal	41, 46

K

Keystone	43
----------------	----

L

Lamp cover	6
Lamp Hours	46
Lamp indicator	51
Lamp replacement period	67
Language	45
Low brightness	43

M

Menu	37, 38, 39
Messages	44
Monitor Out port	8
Mouse pointer	88

N

Numeric buttons	11, 14
-----------------------	--------

O

Operating temperature	109
Operation	45
Optional accessories	97
Overheating	52

P

Part names and functions	6
Password protect	31
Password protect sticker	31
Photo	19
Position	41
Power indicator	51
Power inlet	7, 8
Presentation	19
Problem solving	51
Progressive	41
Projection	44
Projection distance	75

R

Rear	44
Rear foot	15
Rear screen	64
Refresh rate	46
Remote control	13
Remote control light-emitting area	12, 14
Remote receiver	6, 7, 8
Replacing batteries	66
Request code	33
Reset All	47
Reset menu	47
Resetting the lamp operating time	47, 70
Resolution	41, 46, 102

S

Screen size	75
SD card	80
Settings menu	43
Sharpness	40
Sleep Mode	45
Source	46
Source Search	9, 10, 13
Specifications	109
Sports	19
sRGB	19
Startup Screen	44
Storage temperature	109
Sub Menu	37, 38, 39
Supported monitor displays	102
Suspension bracket fixing points	15
S-video port	7, 8
Sync Info	46
Synchronization	41

T

Temp indicator	51
Theater	19
Tint	40
Top menu	37, 38, 39
Tracking	41

U

USB port	8
User's logo	72
User's logo protect	31

V

Video port	7, 8
Video Signal	41, 46
Volume	43

Z

Zoom ring	6
-----------	---

All rights reserved. No part of this publication may be reproduced, stored in a retrieval system, or transmitted in any form or by any means, electronic, mechanical, photocopying, recording, or otherwise, without the prior written permission of Seiko Epson Corporation. No patent liability is assumed with respect to the use of the information contained herein. Neither is any liability assumed for damages resulting from the use of the information contained herein.

Neither Seiko Epson Corporation nor its affiliates shall be liable to the purchaser of this product or third parties for damages, losses, costs, or expenses incurred by the purchaser or third parties as a result of: accident, misuse, or abuse of this product or unauthorized modifications, repairs, or alterations to this product, or (excluding the U.S.) failure to strictly comply with Seiko Epson Corporation's operating and maintenance instructions.

Seiko Epson Corporation shall not be liable against any damages or problems arising from the use of any options or any consumable products other than those designated as Original Epson Products or Epson Approved Products by Seiko Epson Corporation.

The contents of this guide may be changed or updated without further notice.

Illustrations in this guide and the actual projector may differ.

General Notice:

Macintosh, Mac, and iMac are registered trademarks of Apple Computer, Inc.

IBM is a registered trademark of International Business Machines Corporation.

Windows, Windows NT, and PowerPoint are either registered trademarks or trademarks of Microsoft Corporation in the U.S. and/or other countries. Dolby is a trademark of Dolby Laboratories.

HDMI and High-Definition Multimedia Interface are trademarks or registered trademarks of HDMI Licensing LLC. 

Other product names used herein are also for identification purposes only and may be trademarks of their respective owners. Epson disclaims any and all rights in those marks.

This product uses open source software.