



BrightLink™ 450Wi Interactive Projector

User's Guide

Important Safety Information

WARNING: Never look into the projector lens when the lamp is turned on; the bright light can damage your eyes. Never let children look into the lens when it is on. Never open any cover on the projector, except the lamp and filter covers. Dangerous electrical voltages inside the projector can severely injure you. Except as specifically explained in this *User's Guide*, do not attempt to service this product yourself. Refer all servicing to qualified service personnel.

WARNING: The projector and its accessories come packaged in plastic bags. Keep plastic bags away from small children to avoid any risk of suffocation.

Caution: When you replace the lamp, never touch the new lamp with your bare hands; the invisible residue left by the oil on your hands may shorten the lamp life. Use a cloth or glove to handle the new lamp.

Copyright Notice

All rights reserved. No part of this publication may be reproduced, stored in a retrieval system, or transmitted in any form or by any means, electronic, mechanical, photocopying, recording, or otherwise, without the prior written permission of Seiko Epson Corporation. The information contained herein is designed only for use with this Epson product. Epson is not responsible for any use of this information as applied to other products.

Neither Seiko Epson Corporation nor its affiliates shall be liable to the purchaser of this product or third parties for damages, losses, costs, or expenses incurred by purchaser or third parties as a result of: accident, misuse, or abuse of this product or unauthorized modifications, repairs, or alterations to this product, or (excluding the U.S.) failure to strictly comply with Seiko Epson Corporation's operating and maintenance instructions.

Seiko Epson Corporation shall not be liable for any damages or problems arising from the use of any options or any consumable products other than those designated as Original Epson Products or Epson Approved Products by Seiko Epson Corporation.

Trademarks

Epson and Instant Off are registered trademarks, and Epson Exceed Your Vision is a registered logomark of Seiko Epson Corporation.

E-TORL is a registered trademark, BrightLink and SizeWise are trademarks, and PrivateLine and Extra Care are service marks of Epson America, Inc.

Pixelworks, DNX, and the DNX logo are trademarks of Pixelworks, Inc.

General Notice: Other product names used herein are for identification purposes only and may be trademarks of their respective owners. Epson disclaims any and all rights in those marks.

This information is subject to change without notice.

C

Contents

| | |
|---------------------------------------|----|
| <i>Welcome</i> | 9 |
| Using Your Documentation | 10 |
| Getting More Information | 10 |
| Registration and Warranty | 11 |
| Unpacking the Projector | 12 |
| Unpacking the Mounting Hardware | 13 |
| Projector Parts | 14 |
| Base | 15 |
| Connection Panel | 15 |
| Projector Control Panel | 16 |
| Interactive Pens | 16 |
| Remote Control | 17 |
| Projector Dimensions | 18 |
| Additional Components | 20 |
| Optional Accessories | 20 |

| | |
|--|----|
| 1 <i>Connecting to Computers, USB Devices, and Other Equipment</i> | 23 |
| Connecting to a Computer | 24 |
| Connecting to the VGA Computer Port | 24 |
| Connecting to the USB Port | 25 |
| Connecting the USB Cable for the Interactive Pens or Remote Mouse Control | 27 |
| Connecting an External Monitor | 28 |
| Connecting to Video Equipment | 29 |
| Connecting a Composite Video Source | 29 |
| Connecting an S-Video Source | 30 |
| Connecting a Component Video Source | 31 |
| Connecting an RGB Video Source | 32 |

| | |
|--|----|
| Playing Sound Through the Projector | 33 |
| Playing Computer Audio | 33 |
| Playing Sound from Video Equipment | 34 |
| Connecting a Microphone | 35 |
| Connecting External Speakers | 36 |
| Connecting a Document Camera or Other USB Device | 37 |

| | |
|--|----|
| 2 <i>Displaying and Adjusting the Image</i> | 39 |
| Turning the Projector On and Off | 40 |
| Using the Direct Power On Function | 41 |
| Shutting Down the Projector | 42 |
| Selecting an Image Source | 43 |
| Adjusting the Image | 43 |
| Focusing the Image | 44 |
| Selecting the Color Mode | 45 |
| Resizing Video Images | 46 |

| | |
|--|----|
| 3 <i>Using the Interactive Pens</i> | 47 |
| Using the Easy Interactive Pen Driver | 48 |
| Calibrating the Projector | 49 |
| Using the Pens | 51 |
| Using the Easy Interactive Tools for Windows | 52 |

| | |
|--|----|
| 4 <i>Presenting With the Remote Control</i> | 59 |
| Using the Remote Control | 60 |
| Controlling the Picture and Sound | 60 |
| Turning Off the Picture and Sound | 60 |
| Stopping Action | 61 |
| Zooming In on Your Image | 61 |
| Controlling the Volume | 62 |
| Displaying Patterns | 62 |
| Assigning a Pattern to the User Button | 63 |
| Creating Your Own Pattern | 63 |
| Operating Your Computer With the Remote Control | 64 |
| Highlighting Your Presentation | 65 |
| Using the Pointer Tool | 65 |
| Customizing the Pointer Tool | 66 |

| | |
|---|----|
| Presenting a Slideshow | 66 |
| Starting a Slideshow | 66 |
| Selecting Slideshow Display Options | 68 |

| | |
|---|----|
| 5 <i>Using the Projector Menus</i> | 69 |
| Using the Menu System | 70 |
| Restoring the Default Settings | 71 |
| Adjusting the Image | 71 |
| Adjusting Signal Settings | 73 |
| Customizing Projector Features | 75 |
| Customizing Power and Operation. | 77 |
| Using the Projector Security Features | 79 |
| Enabling Password Protection | 79 |
| Creating Your Own Startup Screen | 81 |
| Disabling the Projector's Buttons | 83 |
| Using Security Locking | 84 |

| | |
|--|-----|
| 6 <i>Using the Projector on a Network</i> | 85 |
| Connecting to a Wired Network | 86 |
| Installing the Optional Wireless LAN Module | 89 |
| Using Quick Wireless Connection | 91 |
| Configuring Basic Settings | 91 |
| Configuring a Wireless Connection | 93 |
| Configuring the Projector | 94 |
| Selecting Wireless Network Settings in Windows. | 96 |
| Selecting Wireless Network Settings in Mac OS. | 96 |
| Using Wireless Security Options. | 97 |
| Enabling WEP Encryption. | 97 |
| Enabling WPA Security | 99 |
| Enabling Data Encryption from EasyMP Network Projection | 100 |
| Using the EasyMP Software | 101 |
| Using Projector E-mail Alerts | 101 |
| Using SNMP to Monitor the Projector. | 103 |
| Using a Browser to Control the Projector. | 104 |
| Using Web Remote Control. | 106 |

| | | |
|----------|---|-----|
| 7 | <i>Maintaining the Projector</i> | 109 |
| | Cleaning the Projection Window..... | 110 |
| | Cleaning the Projector Case..... | 110 |
| | Cleaning the Air Filter..... | 111 |
| | Replacing the Air Filter..... | 111 |
| | Replacing the Lamp..... | 113 |
| | Resetting the Lamp Timer..... | 117 |
| | Checking Lamp Usage..... | 117 |
| | Replacing the Pen Batteries..... | 118 |
| | Replacing the Remote Control Batteries..... | 119 |
| | Transporting the Projector..... | 120 |

| | | |
|----------|---|-----|
| 8 | <i>Solving Problems</i> | 121 |
| | Using On-Screen Help..... | 122 |
| | Checking Projector Status..... | 123 |
| | What To Do When the Lights Flash..... | 123 |
| | Solving Projector Operation Problems..... | 125 |
| | Solving Problems With the Image or Sound..... | 126 |
| | Solving Problems With the Interactive Pens..... | 134 |
| | Solving Password Problems..... | 136 |
| | Solving Network Problems..... | 136 |
| | Solving Problems With the Remote Control..... | 139 |
| | Where To Get Help..... | 140 |
| | Internet Support..... | 140 |
| | Speak to a Support Representative..... | 140 |
| | Software Technical Support..... | 141 |
| | Purchase Supplies and Accessories..... | 141 |

| | | |
|----------|---------------------------------------|-----|
| A | <i>Technical Specifications</i> | 143 |
|----------|---------------------------------------|-----|

B *Notices* 149
Important Safety Instructions 149
FCC Compliance Statement 152
Software Notices 153

Index 181

W

Welcome

The BrightLink™ 450Wi is an easy-to-use, ultra short-throw projector that turns any wall into an interactive whiteboard. The projector can be wall-mounted above a whiteboard or other surface and project an image up to 96 inches (diagonal) in native WXGA format. You can use the interactive pens to operate your computer or write and draw on a virtual whiteboard.

The projector offers up to 2500 lumens of white and color light output (brightness). You can connect it to a wide range of computers, interactive whiteboards, and video sources. You can also project from a document camera, USB storage device, or over your network. With the optional wireless LAN module, you can project over a wireless network.

The BrightLink 450Wi includes these additional features:

- Wall bracket (setting plate) and built-in slide plate for easy and inexpensive wall mounting
- Battery-operated pens and software that turns any wall into an interactive whiteboard
- 8.5-second startup time and Instant Off® feature for fast setup and shut down
- Closed captioning
- 10 watt speaker and microphone input
- USB display for easy setup of Windows® and Macintosh® computers

Using Your Documentation

This manual contains all the information you need to set up and use your projector. Please follow these guidelines as you read through it:

- **Warnings** must be followed carefully to avoid bodily injury.
- **Cautions** must be observed to avoid damage to your equipment.
- **Notes** contain important information about your projector.
- **Tips** contain additional projection hints.

Getting More Information

Need quick steps for setting up your projector? Here's where you can look for help:

- **Installation Guide**
Provides detailed instructions on installing the projector using the wall mounting hardware included in the box.
- **Quick Guide**
Provides all the information you need to install the software, use the interactive pens, and solve basic problems.
- **EasyMP Network Projection Operation Guide**
Provides detailed instructions on using your projector in a network environment (PDF installed along with this manual from the projector CD).
- **EasyMP Monitor Operation Guide**
Provides instructions on using the EasyMP Monitor software to manage projectors on a network (PDF installed along with this manual from the projector CD).
- **Built-in help system**
Provides assistance for common problems. Available from the ? Help button on the projector or the remote control. See page 122 for details.
- **epson.com/support**
Download FAQs and e-mail your questions to Epson support.

■ PrivateLine® support

If you still need help after checking this *User's Guide* and the sources listed in this section, you can use the Epson PrivateLine Support service to get help fast. Call (800) 637-7661 and enter the PIN on the PrivateLine card. Or take advantage of Epson's automated support services 24 hours a day. See page 140 for more information.

Registration and Warranty

Your projector comes with a basic warranty that lets you project with confidence. For details, see the warranty in the *Quick Guide*.

In addition, Epson offers free Extra CareSM Road Service. In the unlikely event of an equipment failure, you won't have to wait for your unit to be repaired. Instead, Epson will ship you a replacement unit anywhere in the United States or Canada. See the brochure included with your projector for details.

You can register using the included CD, or you can register online at epson.com/webreg. Registering also lets you receive special updates on new accessories, products, and service.

Unpacking the Projector

After unpacking the projector, make sure you have all these parts:

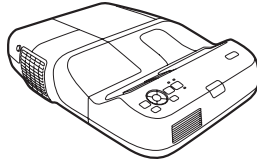

Projector

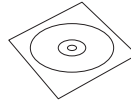

BrightLink
450Wi CD

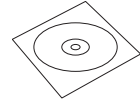

Epson Projector
Software for Meeting
and Monitoring CD

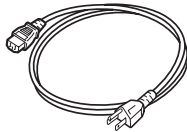

Power cord

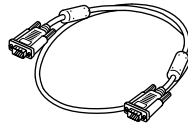

VGA computer cable

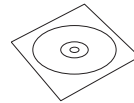

Epson Projector
Software for Easy
Interactive Function CD

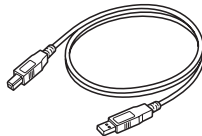

USB cable



Remote control



2 AA batteries
(for remote control)



Security sticker

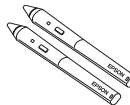

Interactive pens*



4 AAA batteries
(for interactive pens)*

*Extra pen and battery set are included in the U.S. and Canada only.

Unpacking the Mounting Hardware

After unpacking the setting plate and mounting hardware, make sure you have all these parts:

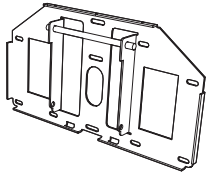

Wall plate

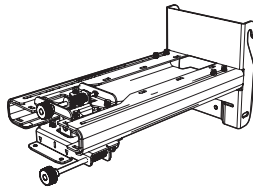

Wall mount (setting plate)

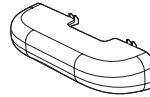

End cap

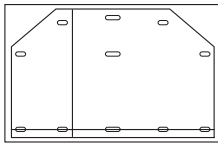

Installation template

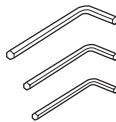

Hex wrenches

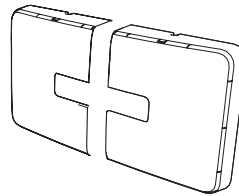

Wall plate cover



Bolts

See the *Installation Guide* for instructions on mounting the projector on a wall. Save all packaging in case you need to ship the projector. Always use the original packaging (or the equivalent) when you need to send the projector to another location. See page 120 for transportation instructions.

Projector Parts

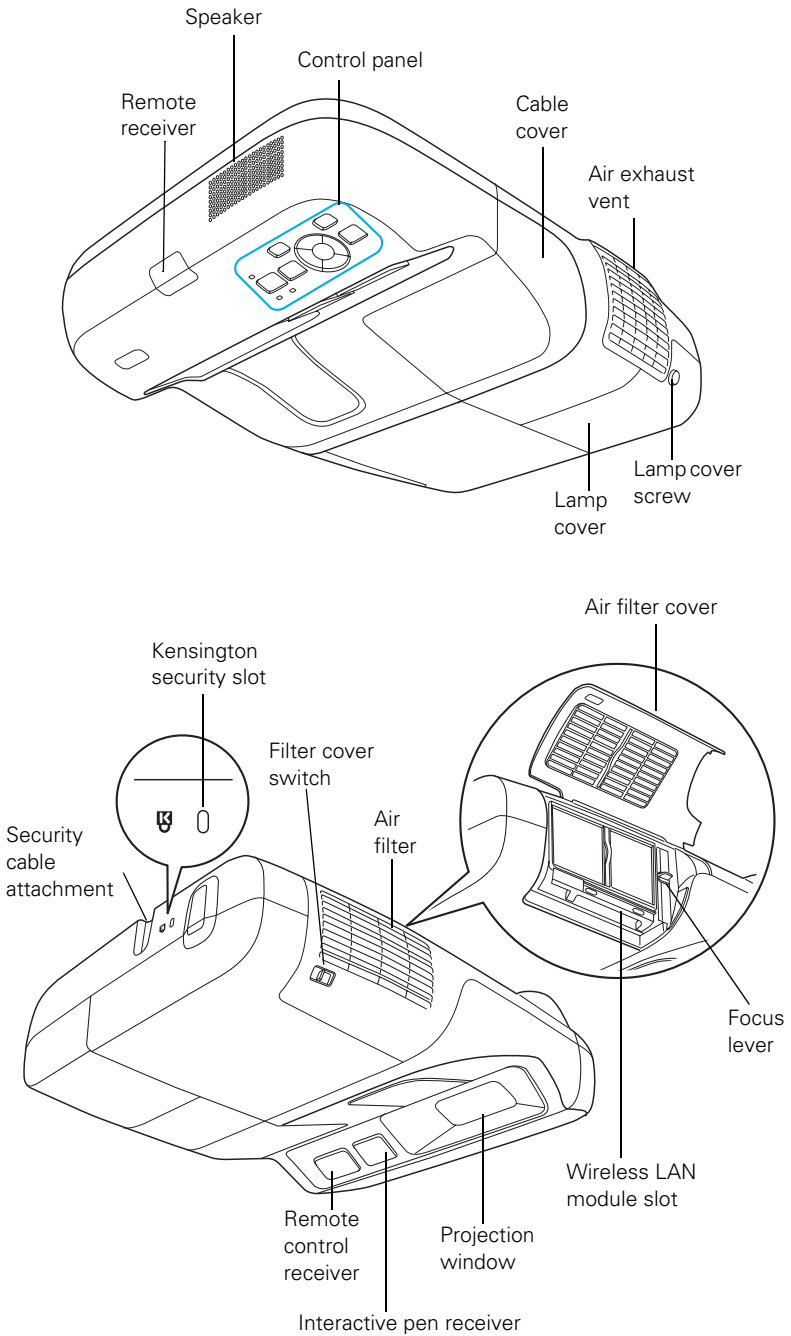

Base

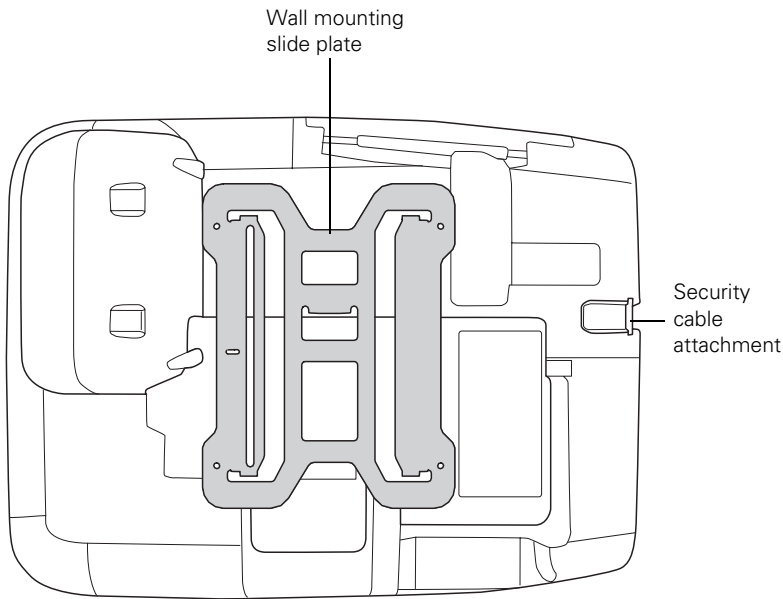

Connection Panel

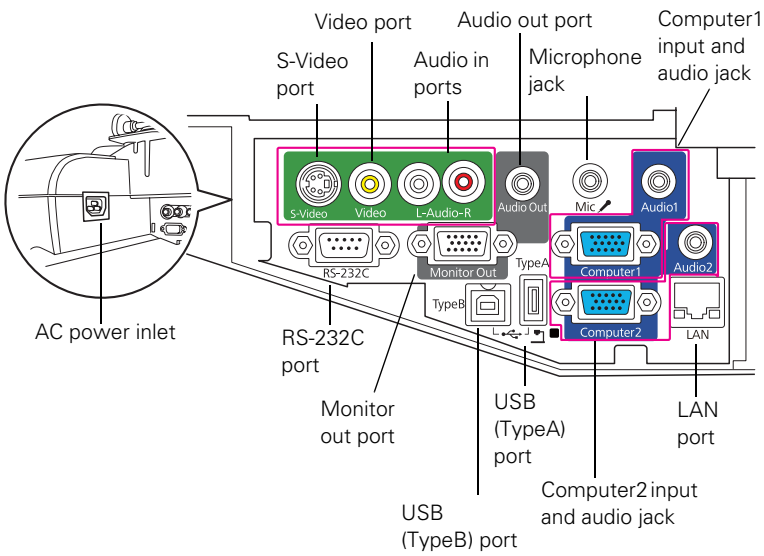

Projector Control Panel

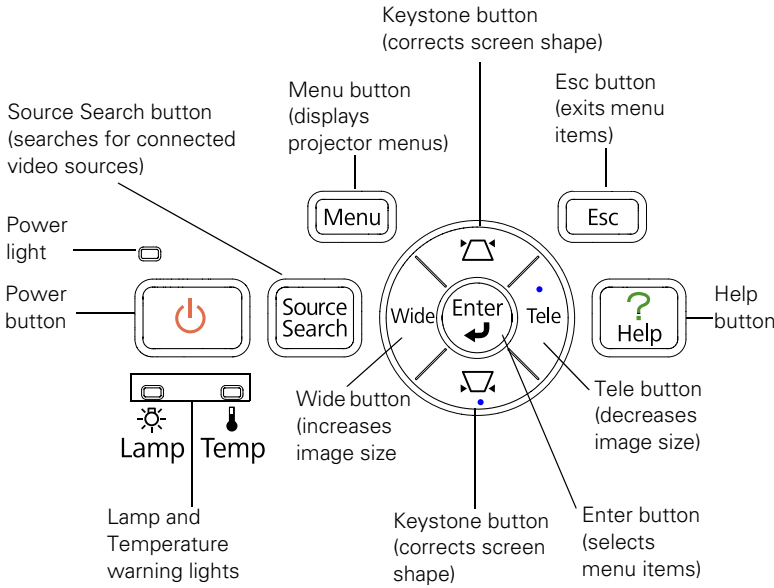

Interactive Pens

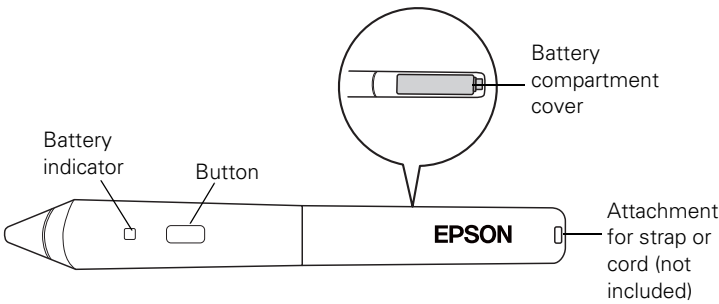

Remote Control

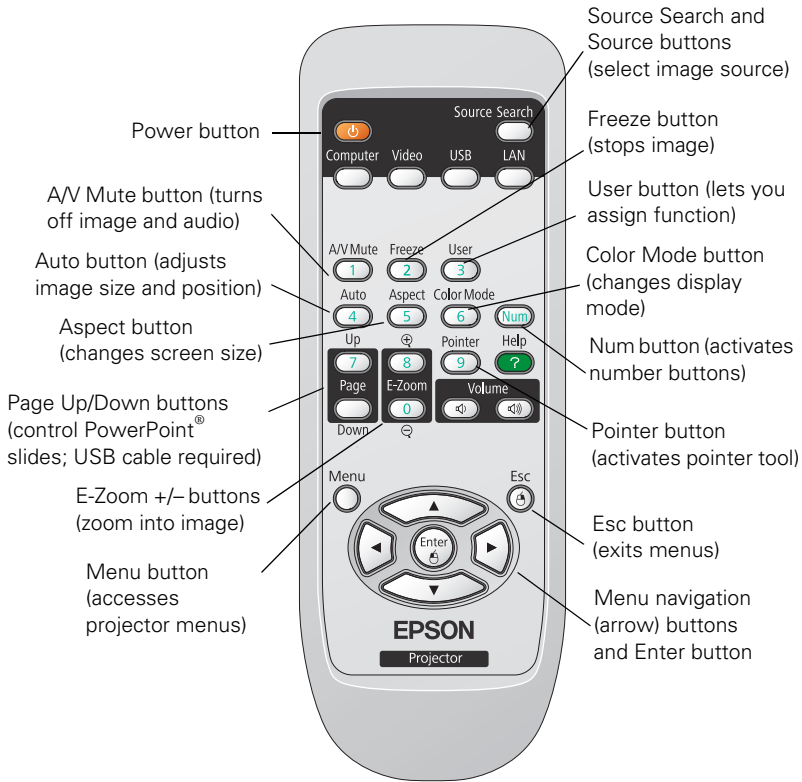

Projector Dimensions

Use the dimensions below to guide you in placing or installing the projector.

With side plate

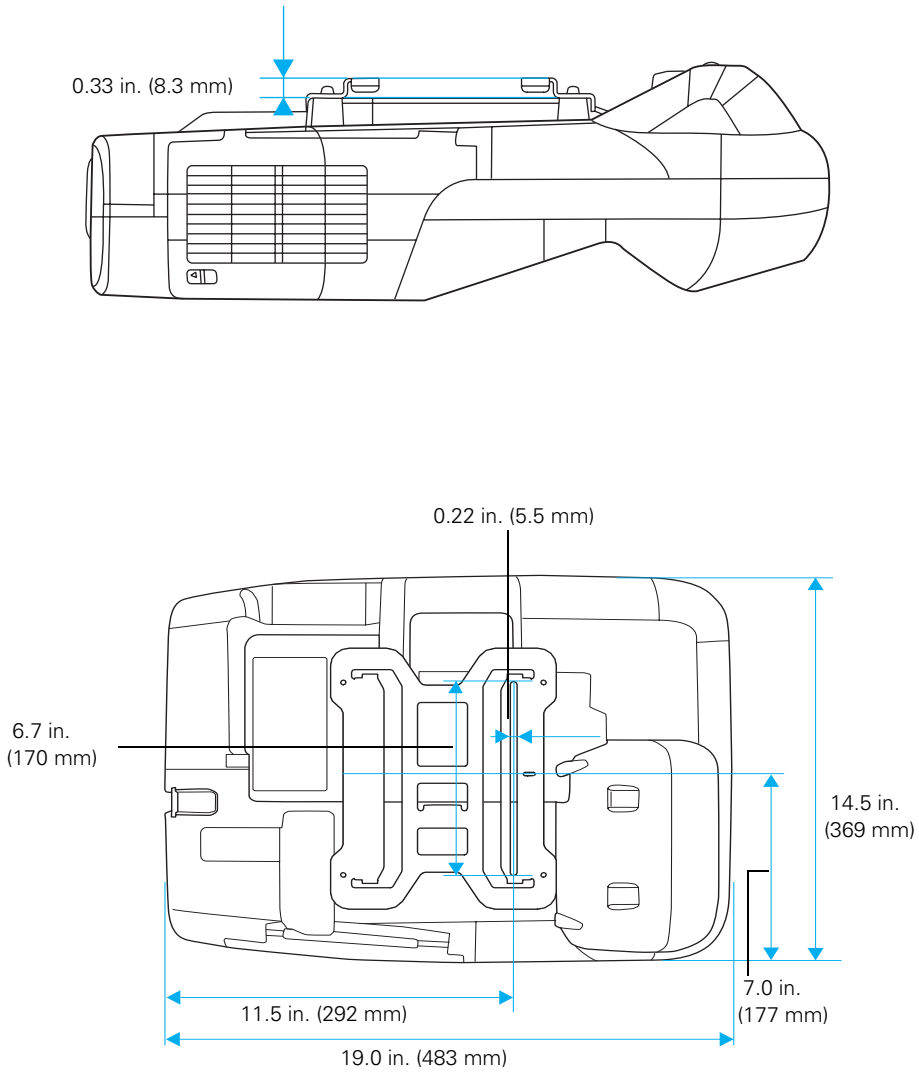

Without slide plate

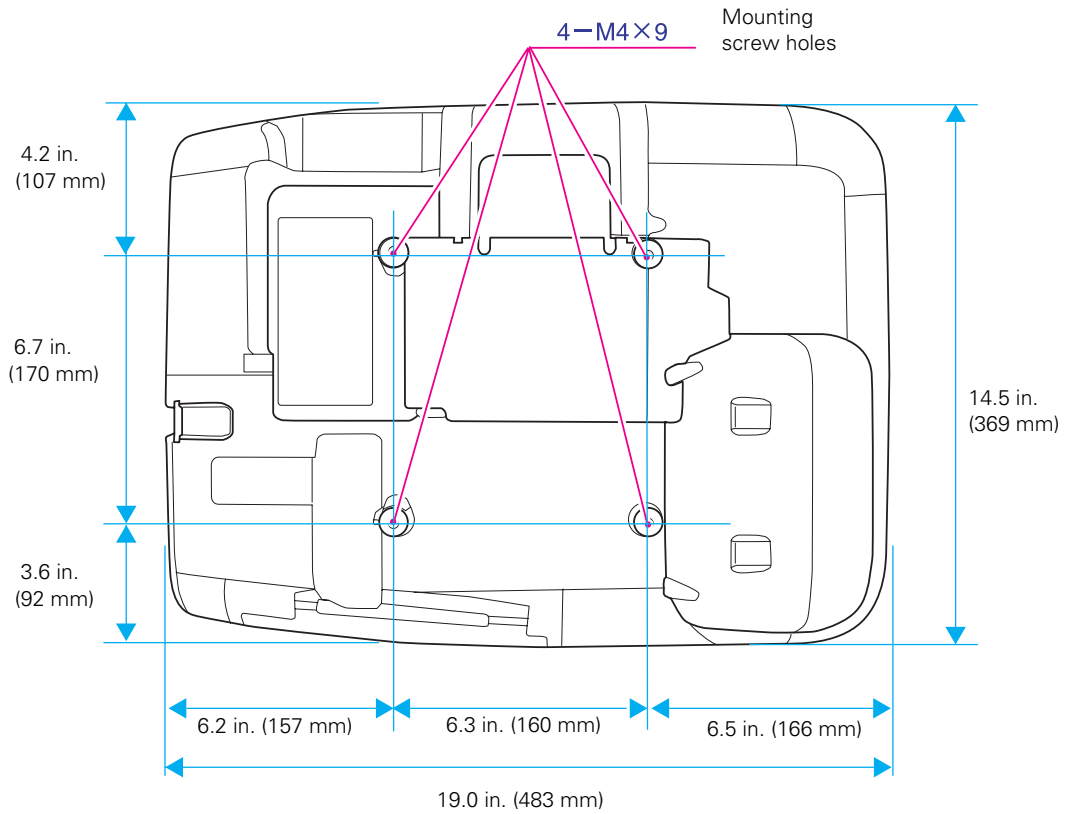
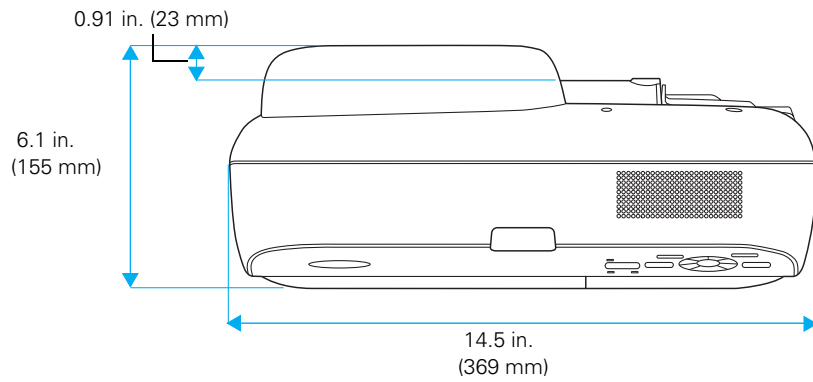

Additional Components

Depending on how you plan to use the projector, you may need additional components:

- To receive a component video signal from a DVD player or other video device, you'll need a component-to-VGA video cable. One may be included with your video equipment, or you can purchase the ELPKC19 cable from Epson. See "Optional Accessories" below.
- To receive an S-Video signal, you'll need an S-Video cable. One may be included with your video equipment, or you can purchase one from Epson. See "Optional Accessories" below.
- To receive an audio signal, you'll need an RCA-type audio cable with two male plugs, or a stereo mini-jack audio adapter cable (with red and white jacks on one end).

Optional Accessories

To enhance your use of the projector, Epson offers the following optional accessories:

| Product | Part number |
|---|------------------------|
| Additional interactive pen | V12H387001 |
| Replacement lamp | V13H010L57 |
| Replacement air filter set | V13H134A27 |
| Wireless LAN module* | V12H306P11 |
| Quick Wireless Connection USB key | V12H005M05 |
| Kensington security lock | ELPSL01 |
| DC-06 document camera (ELPDC06) DC-10s document camera | V12H321001 ELPDC10S |
| Component-to-VGA video cable S-Video cable | ELPKC19 ELPSV01 |

* Requires USB cable for interactive use.

You can purchase accessories from an Epson authorized reseller. To find the nearest reseller, call 800-GO-EPSON (800-463-7766). Or you can purchase online at www.epsonstore.com (U.S. sales) or www.epson.ca (Canadian sales).

1

Connecting to Computers, USB Devices, and Other Equipment

This chapter tells you how to connect the projector to a notebook or desktop computer or to video equipment, such as a VCR, DVD player, or video camera.

You can also connect the projector to a USB storage device or document camera.

Follow the instructions in this chapter on:

- Connecting to a computer
- Connecting an external monitor
- Connecting to video equipment
- Playing sound through the projector
- Connecting to a document camera or other USB device

Connecting to a Computer

You can connect the projector to any computer that has a standard video output (monitor) port. This connection is recommended for use with the interactive pens. See the next section for instructions.

note

If you have an iBook with an RCA video-out port, follow the instructions for connecting to a video device on page 29.

You can also connect the projector to a computer using the projector's TypeB  (square) USB port, including desktop models, PC notebook computers, Macintosh PowerBook® and iBook® computers, and other devices.

To play sound through the projector, connect an audio cable (see page 33).

You may be able to use your remote control as a wireless mouse when projecting from a computer (see page 64).

Connecting to the VGA Computer Port

You can connect to the projector using the VGA computer cable that came with it (the monitor port on your computer must be a D-sub 15-pin port). This is the best type of connection for use with the interactive pens.

1. Connect one end of the VGA computer cable to the projector's Computer1 or Computer2 port and the other end to your computer's monitor port.

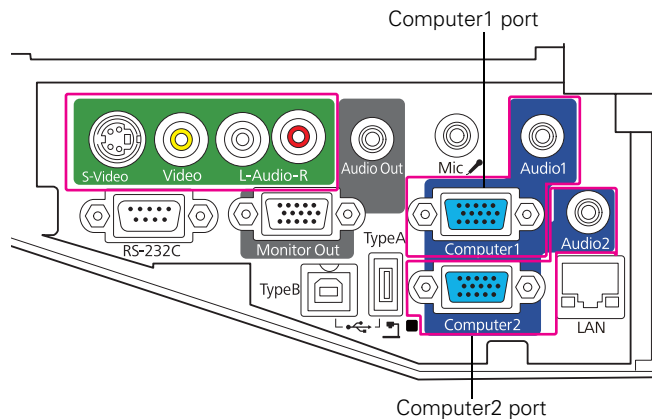

caution

Don't try to force a connector to fit a port with a different shape or number of pins. You may damage the port or connector, or the device you are trying to connect.

2. You may need to change the **Input Signal** setting in the projector's **Signal** menu to **RGB** or **Auto** (see page 74).
3. You can connect an optional stereo mini-jack audio cable to play sound through the projector (see page 33) or connect a microphone (see page 35).
4. You may also be able to use the remote control as a wireless mouse (see page 64).

When you've finished making connections, see page 40 for instructions on turning on the projector and page 43 for instructions on displaying and adjusting the image. For instructions on using the interactive pens, see page 47.

Connecting to the USB Port

You can connect a Windows or Macintosh computer to the projector's **TypeB**  (square) USB port and project your computer's display. This feature supports the following operating systems: 32-bit versions of Windows 7, Windows Vista®, Windows XP, Windows 2000 (SP4), or Mac OS® 10.5.1 or later.

A USB 2.0 connection (recommended) provides better picture quality and response than USB 1.1.

The first time you connect a computer to the projector's USB port, software from the projector is installed on your computer.

1. Follow the instructions beginning on page 40 to turn on the projector.
2. Make sure the **USB Type B** setting on the **Extended** menu is set to **USB Display** (see page 77).
3. Turn on your computer.

4. Connect the square end of the USB cable to the projector's TypeB  (square) USB port.

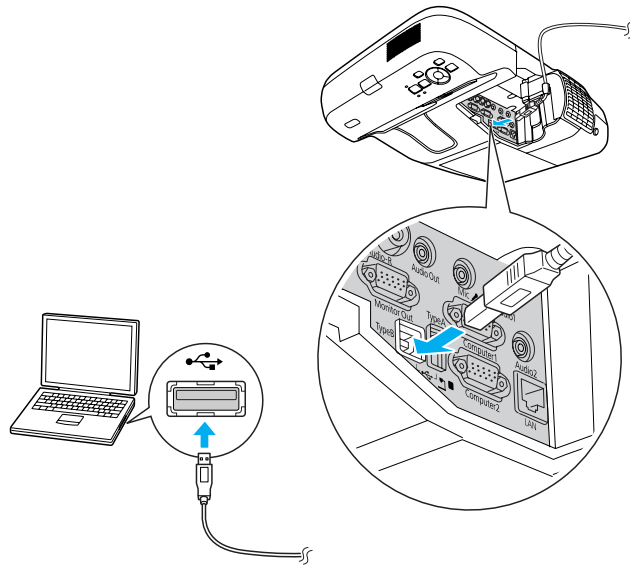

5. Connect the flat end of the cable to any available USB port on your notebook or desktop computer.

Messages appear on your computer screen as the projector is recognized and the software is installed automatically.

6. In Windows, if the AutoPlay window appears, click **EMP UD_s.exe**.

On Mac OS, double-click the **USB Display Installer** icon to install the software.

7. Follow the instructions on the screen to install the Epson USB Display software. If you see a “Digital Signature Warning,” select **Continue** or **Continue Anyway**. (You see these instructions only the first time you connect.)

After the software is installed, you see your computer's current desktop displayed by the projector. You can switch the projector to other image sources using the **Source Search** button on the remote control or the projector.

note

If the software does not install automatically, you can install it manually. See page 125 for instructions.

8. You can connect an optional audio cable if you want to play sound through the projector (see page 33).

When you've finished making connections, see page 43 for instructions on displaying and adjusting the image.

9. When you're done projecting, do one of the following:

Windows: simply disconnect the USB cable.

Mac OS: click the USB Display icon on the Dock and drag it to the trash, then remove the USB cable.

Connecting the USB Cable for the Interactive Pens or Remote Mouse Control

In order to use the interactive pens, you must connect the USB cable to the projector and your computer.

Connecting the USB cable also lets you use the projector's remote control as a wireless mouse. You can control your computer and click through slideshow-style presentations, such as PowerPoint, from up to 19.7 feet (6 meters) away (see page 64 for more information).

1. Connect the square end of the USB cable to the projector's Type B  (square) USB port.

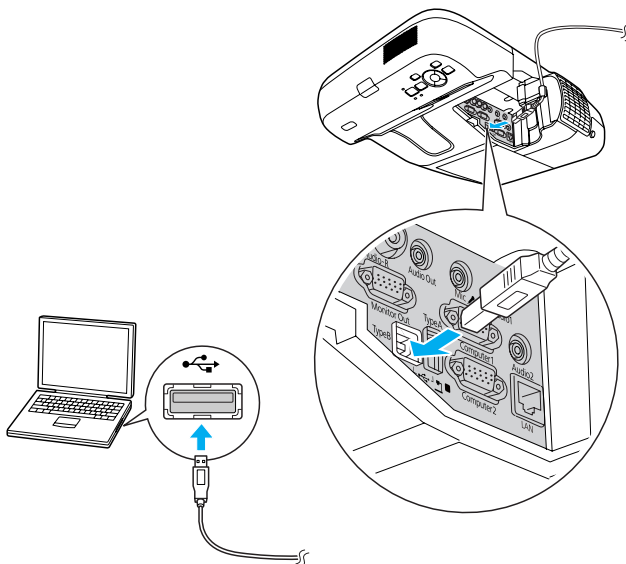

2. Connect the flat end of the cable to any available USB port on your notebook or desktop computer. A USB 2.0 port is recommended for the best performance.
3. Set the **USB Type B** setting in the projector's Extended menu to **Wireless Mouse** (see page 78).
4. Press the **Computer** button on the remote control to select your computer as the source. (The wireless mouse function doesn't work when other sources are selected.)
5. If necessary, configure your computer to work with a USB mouse. See your computer documentation for details.

note

Some LCD monitors may not be able to display the image correctly. If you have trouble displaying the image, connect a multiscan monitor. If you're projecting computer images, make sure the computer's refresh rate is set to 65 Hz or greater.

The projector must be turned on for the Monitor Out port to send a signal to the monitor (though it may be in standby mode). Make sure Standby Mode is set to Communication On in the Extended menu. See page 77.

Connecting an External Monitor

If you want to view your computer presentation close-up (on a monitor) as well as on the screen, you can connect an external monitor. You can use it to check on your presentation even if you've pressed the **A/V Mute** button or switched to a different picture source. Only computer images will appear on the external monitor, not video images.

First make sure your computer's VGA cable is connected to the projector's **Computer1** port (see page 27). Then connect your monitor to the projector's **Monitor Out** port, as shown:

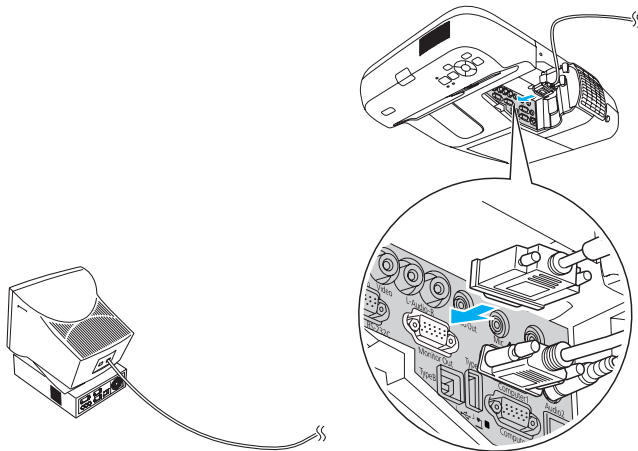

Connecting to Video Equipment

You can connect several video sources to the projector at the same time. Before starting, look at your video equipment to determine its available video output connections:

- If your video player has a yellow RCA video output connector, see “Connecting a Composite Video Source” on page 29.
- If your video player has an S-Video connector, see “Connecting an S-Video Source” on page 30.
- If your video player has a component video port (three connectors labeled either Y/Cb/Cr or Y/Pb/Pr), see “Connecting a Component Video Source” on page 31.
- If your video player has an RGB video port, see “Connecting an RGB Video Source” on page 32.

After connecting video cables, you may also want to connect an optional audio cable to play sound through the projector; see page 33.

Connecting a Composite Video Source

1. If your video cable has an RCA connector, connect it to the yellow video output connector on your player and the yellow Video port on the projector.

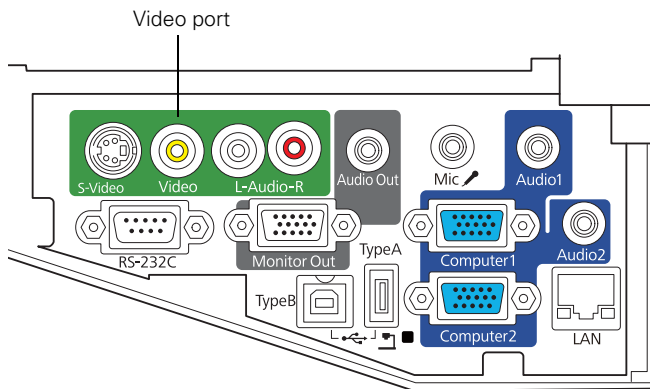

2. If you want to play sound through the projector, see page 33 for instructions on connecting an audio cable.

note

If the video cable was not provided with your video device, you can purchase one from an electronics dealer.

3. When you've finished making connections, see page 40 for instructions on turning on the projector and page 43 for instructions on displaying and adjusting the image.

Once the projector is turned on, select the image source by pressing the **Source Search** button on the projector or remote control.

note

If the S-Video cable was not provided with your video device, you can purchase one from Epson; see page 20.

Connecting an S-Video Source

1. Connect the S-Video cable to the S-Video connector on your player and the S-Video port on the projector.

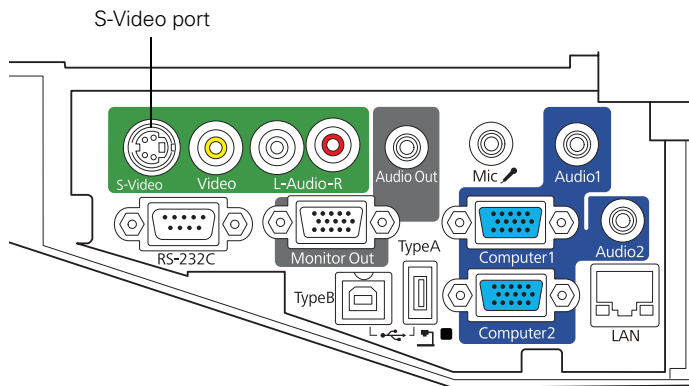

2. If you want to play sound through the projector, see page 33 for instructions on connecting an audio cable.
3. When you've finished making connections, see page 40 for instructions on turning on the projector and page 43 for instructions on displaying and adjusting the image.

Once the projector is turned on, select the image source by pressing the **Source Search** button on the projector or remote control.

Connecting a Component Video Source

If your video equipment has component video connectors (three connectors labeled either Y/Cb/Cr or Y/Pb/Pr), you will need a component-to-VGA video cable or a component video cable and adapter. You can order the component-to-VGA cable (ELPKC19) from Epson (see page 20) or an electronics dealer.

1. Connect the component end of the cable (3 male RCA) to the color-coded Y/Cb/Cr (or Y/Pb/Pr) connectors on your player.
2. Connect the other end of the cable (HD15 male) to the blue **Computer1** or **Computer2** port on the projector.

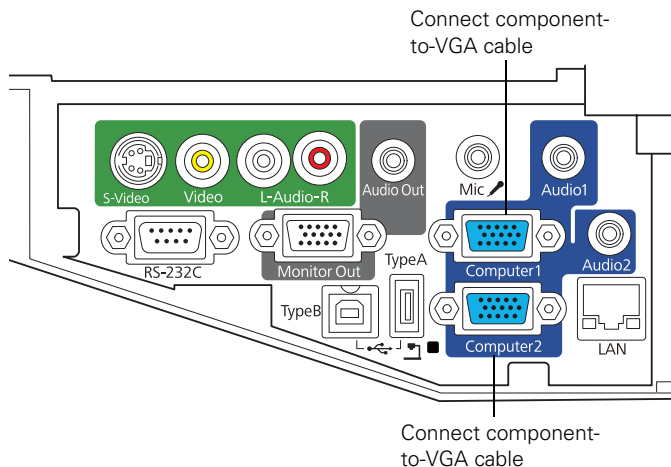
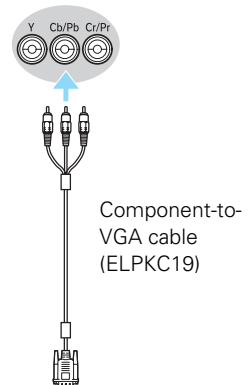

3. You may need to change the **Input Signal** setting in the projector's **Signal** menu to **Auto** (see page 74).
4. If you want to play sound through the projector, see page 33 for instructions on connecting an audio cable.
5. When you've finished making connections, see page 40 for instructions on turning on the projector and page 43 for instructions on displaying and adjusting the image.

Once the projector is turned on, select the image source by pressing the **Source Search** button on the projector or remote control.

Connecting an RGB Video Source

You can connect to an RGB video source using the VGA computer cable provided with the projector.

1. Connect the cable to the RGB video port on your player and the **Computer1** or **Computer2** port on the projector.

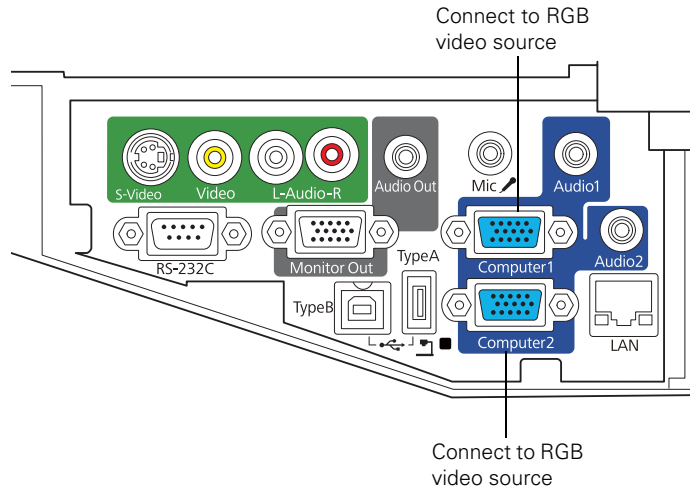



2. You may need to change the **Input Signal** setting in the projector's **Signal** menu to **RGB** (see page 74).
3. If you want to play sound through the projector, see page 33 for instructions on connecting audio cables.
4. When you've finished making connections, see page 40 for instructions on turning on the projector and page 43 for instructions on displaying and adjusting the image.

Once the projector is turned on, select the image source by pressing the **Source Search** button on the projector or remote control.

Playing Sound Through the Projector

You can play sound through the projector's speaker system or attach an external speaker system. You can also connect a microphone and output sound through the projector.



You can use the  or  Volume buttons on the remote control to adjust the volume.

Playing Computer Audio

For laptop and most desktop computers, use a 3.5 mm stereo mini-jack cable, which you can purchase from a computer or electronics store.

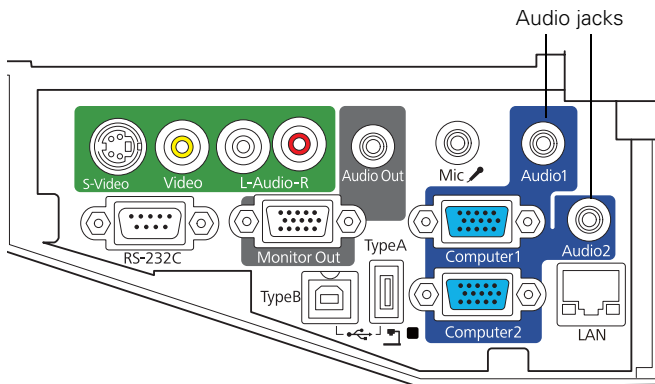
1. Connect one end of the cable to the **Audio1** or **Audio2** jack on the projector.



2. Connect the other end to your laptop's  headphone jack or  audio-out jack, or your computer's speaker or audio-out port.

Playing Sound from Video Equipment

For video equipment, use an RCA-style audio cable, which you can purchase from an electronics store.

note

If you are using a component-to-VGA cable, you will need to connect an audio adapter to use the Audio1 or Audio2 jack.

1. Connect the red and white plugs on one end of the cable to the L and R Audio jacks on the projector.

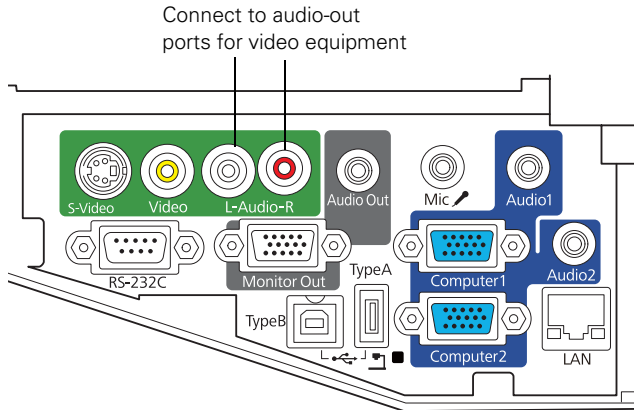

2. Connect the red and white plugs on the other end to the corresponding color-coded audio output jacks on your video source.

Connecting a Microphone

You can connect a dynamic microphone to the projector's **Mic** port, using a 3.5 mm mini-jack cable as shown below.

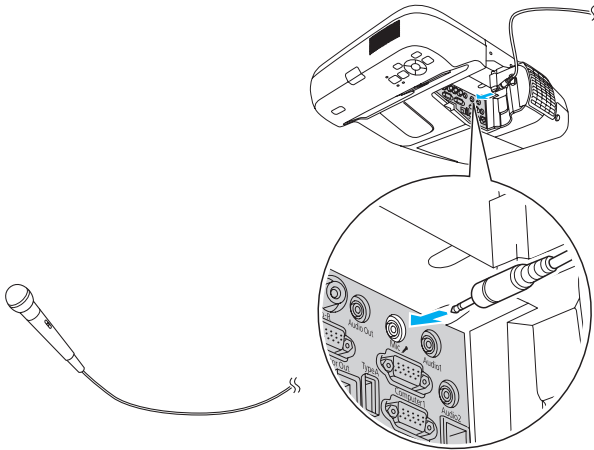

Use the **Mic Input Level** option on the Settings menu to adjust the volume. See page 76 for more information.

Connecting External Speakers

You can output sound from the projector to external speakers with a built-in amplifier.

1. Locate the appropriate cable to connect your speakers.

Depending on your speakers, you may be able to use a standard audio cable with a stereo mini-jack connector on one end and pin jacks on the other end. For some speakers, you may need a special cable or adapter.

2. Connect the stereo mini-jack end of the audio cable to the **Audio Out** port on the projector.

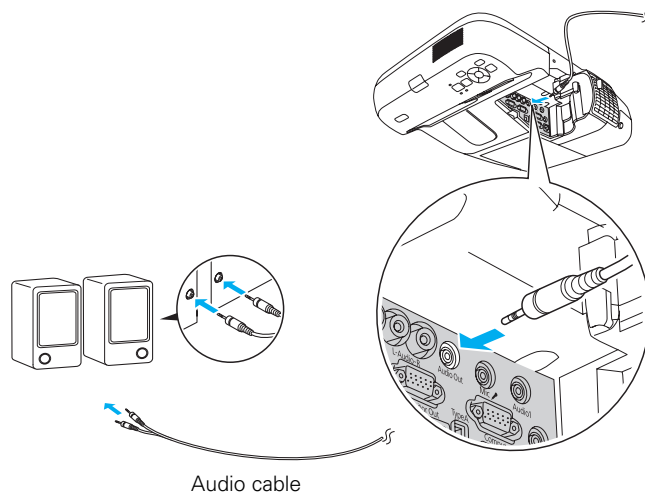

3. Connect the other end of the cable to your speakers.

The projector's internal speaker system is disabled while sound is output to external speakers.

Connecting a Document Camera or Other USB Device

You can connect an interactive whiteboard, document camera, USB thumb (flash memory) drive, USB hard drive, or multimedia storage viewer, such as the Epson P-7000. You can use the projector's Slideshow function to display JPEG images or a presentation. See page 66 for details.

Use the USB cable specified for your device.

1. Follow the instructions beginning on page 40 to turn on the projector.
2. Connect the USB drive or the flat end of the USB cable to the Type A  (flat) USB port on the projector, as shown.

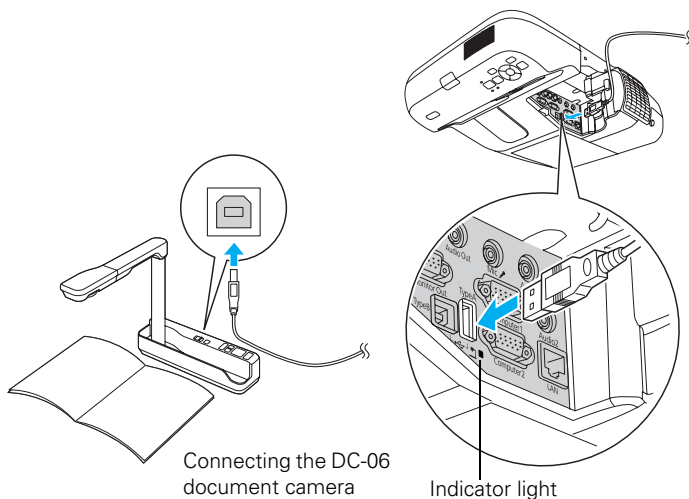

3. Connect the other end of the cable to your camera or other device, if necessary.

The indicator light on the projector turns orange and then green when a USB device is connected.

4. If the projector is connected to a storage device (and not connected to another image source), the Slideshow program appears.

note

Use a cable less than 10 feet (3 meters) long and connect the camera or other device directly to the projector.

Your projector may not function correctly if you use a longer cable or connect to a USB hub.

If you connect a USB hard drive, make sure you use the AC adapter to power the hard drive. Make sure the file format is FAT 16/32. Some USB hard drives may not be supported.

If you are connected to another image source, press the **USB** button on the remote control to go to the Slideshow program.

5. See page 66 for instructions on controlling the slideshow.
6. When you're finished, press **Esc** and select **Exit** to exit the Slideshow before turning off or removing the USB device.

Be sure to turn off your USB device (if necessary) before you remove the device or cable from the projector. Failure to do so may damage the device and/or the projector.

2

Displaying and Adjusting the Image

Whether you're projecting from a computer or video equipment, you need to follow some basic steps to display your image on the screen.

Follow the guidelines in this chapter for:

- Turning the projector on and off
- Selecting the image source
- Adjusting the image

Turning the Projector On and Off

Turn on any connected computer or video equipment before starting the projector so it can automatically detect and display the image source. If you turn on the projector first, or have multiple pieces of connected equipment, you may have to select the image source manually (see page 43).

Follow these steps to turn on the projector:

1. Make sure the power cord is connected and the projector is plugged into an electrical outlet.

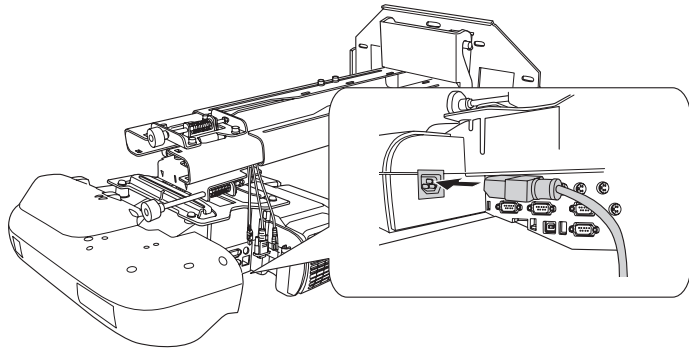

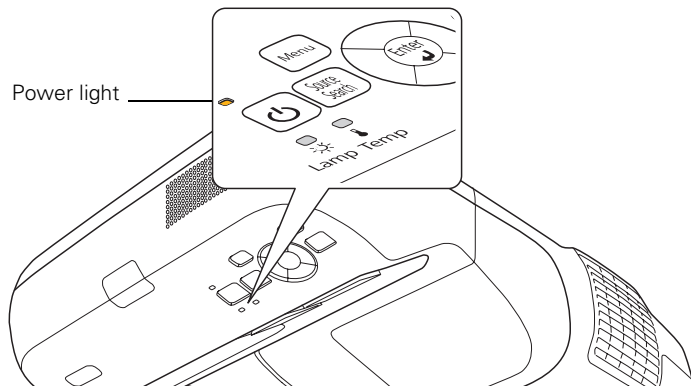

The  power light should be orange.

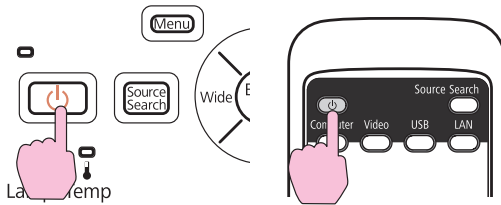

- Press the  power button on the projector or on the remote control.



The projector beeps once and the  power light flashes green as the projector warms up, then an image begins to appear. When the  power light stops flashing and remains green, the projector is ready for use.

- If you are prompted to enter a password, see page 80.

Using the Direct Power On Function

The Direct Power On function enables faster setup. The projector starts up automatically when you plug it in or turn it on with a wall switch. You don't have to press the  power button.

Follow these steps to enable Direct Power On:

- Press the **Menu** button on the remote control or projector, then select the **Extended** menu and press **Enter**.
- Choose **Operation** and press **Enter**.
- Choose **Direct Power On** and press **Enter**.

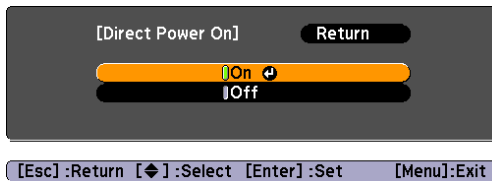

- Highlight **On** and press **Enter**.
- Press **Menu** to exit. The setting will take effect the next time you plug the projector into a power outlet or turn it on with a wall switch.

warning

Never look into the lens when the lamp is on. This can damage your eyes, and is especially dangerous for children.

note

If a power outage occurs when Direct Power On is enabled and the projector is plugged in, the projector will restart when the power is restored.

note

Lamp life will vary depending upon mode selected, environmental conditions, and usage.

Turn off this product when not in use to prolong the life of the projector.

You can set the projector to automatically turn off the lamp and enter “sleep mode” when it has not received any signals for 1 to 30 minutes (see page 78). This conserves electricity, cools the projector, and extends the life of the lamp. If you want to start projecting again, press the ⏻ power button.

Shutting Down the Projector

This projector incorporates Instant Off technology. To turn it off, you can press its ⏻ power button as described below, unplug it, or turn off a power switch that supplies power to the projector. You don't have to wait for the projector to cool down first.

1. To turn off the projector, press the ⏻ power button on the remote control or projector.

You see a confirmation message.
(If you don't want to turn it off, press any other button.)

Power Off?

Yes: Press ⏻ button
No : Press any other button

2. Press the ⏻ power button again. The projection lamp turns off and the projector beeps twice. You can then unplug the power cord.

If you want to turn the projector on again, make sure the orange ⏻ power light is not flashing, then press the ⏻ power button.

Selecting an Image Source

You may need to select the image source if you have multiple image sources connected to the projector (such as a computer or DVD player). Selecting the image source lets you switch between images input from different pieces of connected equipment.

If you don't see the image you want, press the **Source Search** button on the remote control or the projector until you see the image you want to project. Or, press one of the Source buttons on the remote control (**Computer**, **Video**, **USB**, or **LAN**).

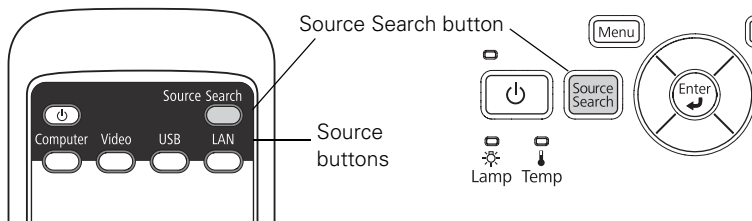

If you still can't see an image or can't project the same image that is on your notebook or computer screen, see page 126 for solutions.

Select **USB** to project from a USB device or **LAN** to project over a network. See page 66 for instructions.

Adjusting the Image

Once you see your image, you may need to make certain adjustments:

- To focus the image, see page 44.
- To quickly adjust the color, brightness, or contrast, see page 45.
- To change the image aspect ratio, see page 46.
- If you need to fine-tune the image and/or sound, see "Using the Projector Menus" on page 69.

Focusing the Image

Focusing the projector is part of the installation process. If necessary, you can re-adjust the focus at any time using the focus lever next to the air filter on the side of the projector.

1. Slide the switch to open the air filter cover on the side of the projector.
2. Raise or lower the focus lever to sharpen the image.

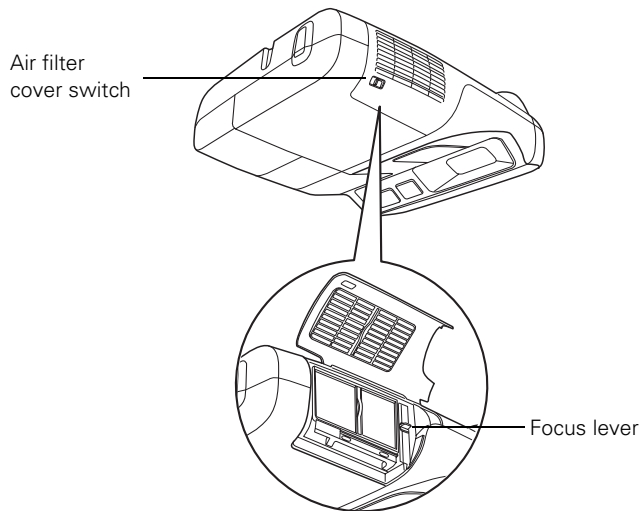

Selecting the Color Mode

The Color Mode adjusts the brightness, contrast, and color for various common viewing environments. Use this setting to quickly obtain a good picture.

Press the **Color Mode** button on the remote control to select an option. Press it until the option you want is projected in the upper right corner.

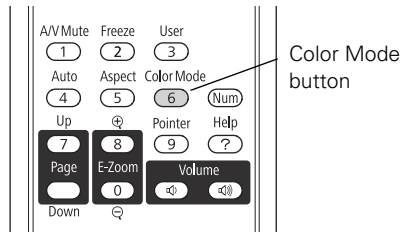

Select from one of these **Color Mode** options:

- **Dynamic:** Brightest mode; for video games or TV in a bright room.
- **Presentation:** For color presentations in a bright room (default setting).
- **Theatre:** For natural-toned movies in a darkened room.
- **Photo:** For vivid, high-contrast still images in a bright room (only available when the source is set to **LAN** or **USB**).
- **Sports:** For vivid TV images in a bright room (only available for component video, S-Video, or composite video sources).
- **sRGB:** Matches the color palette of standard sRGB computer displays.
- **Blackboard:** Projects accurate colors on a green chalkboard (adjusts the white point).
- **Whiteboard:** For computer presentations in a bright room with black-and-white text and graphics.

note

You cannot change the aspect ratio when displaying from a computer using the USB TypeB port or from a USB device using the USB source.

Resizing Video Images

You can resize your images by changing the aspect (width to height) ratio (depending on your input signal).

Press the **Aspect** button on the remote control. Press the **Aspect** button repeatedly to cycle through the available options.

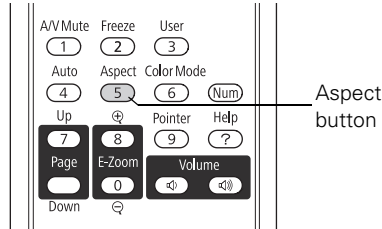

Select from one of these **Aspect** options:

- **Normal:** Displays images using the full projection area and maintains the aspect ratio of the image. Choose this setting to automatically resize the image and make the best use of the display area.
- **16:9:** Converts the aspect ratio of the image to 16:9. 4:3 ratio images are elongated horizontally to fit.
- **Full:** Displays images using the full width of the projection area, but does not retain the aspect ratio. 4:3 ratio images are elongated horizontally.
- **Zoom:** Displays images using the full width of the projection area and maintains the aspect ratio of the image. The image may be cut off on the top and bottom depending on its aspect ratio.
- **Native:** Displays images as is (aspect ratio and resolution are maintained). Black bands may appear or images may be cut off, depending on the resolution.

If you are using the interactive pens, you will have to recalibrate after changing the projector's aspect setting.

3

Using the Interactive Pens

The interactive pens included with your projector turn almost any wall into an interactive whiteboard. This chapter tells you how to use the Easy Interactive Driver software, calibrate the projector, and use the pens to annotate presentations or write and draw on a virtual whiteboard.

Follow the instructions in this chapter on:

- Using the Easy Interactive Pen Driver
- Calibrating the projector
- Using the pens
- Using the Easy Interactive Tools for Windows

Periodically, it's a good idea to check Epson's support website in the [U.S.](#) or [Canada](#) for free updates to your Easy Interactive software.

Using the Easy Interactive Pen Driver

The Easy Interactive Driver software is included on the CD labeled “Epson Projector Software for Easy Interactive Function.” Note the following system requirements:

- Microsoft® Windows 2000, Windows XP, Windows Vista or Windows 7 (32-bit versions for Windows Vista and Windows 7)
or
Mac OS X 10.3 or above
 - USB 1.1 port (minimum) or USB 2.0 port (recommended)
1. Connect the VGA computer cable and USB cable to the projector and computer, as described on pages 24 and 27.
 2. Turn on your computer.
 3. Make sure the driver software is installed on your computer, as described in the *Quick Guide*.
 4. Turn on the projector, as described on page 40.

You should see your computer desktop displayed. If you see a blank screen or the **No signal** message, check the following:

- Make sure the power light on the projector is green and not flashing.
- Press the **Computer** button on the remote control.
- If you’re using a Windows laptop, press the function key on your keyboard that lets you display on an external monitor. It may be labelled **CRT/LCD** or have an icon such as . You may need to hold down the **Fn** key while pressing it.

If you need more help, see page 127.

5. Check the connection status.

Windows: you should see the  pen icon in the system tray on your taskbar (lower right corner of your screen).

Mac OS: you should see the  pen icon in the Dock.

You may need to wait a minute for the icon to appear after you turn on the computer and projector.

If a red X appears on the icon, the computer and projector are not connected correctly. Try removing and reconnecting the USB cable.

If you don't see the icon, do one of the following:

Windows: select  or **Start > All Programs or Programs > Epson Projector > Easy Interactive Driver.**

Mac OS: open the Application folder, then select the **Easy Interactive Driver** icon.

If you need more help, see page 134.

When the computer and projector are connected and the Easy Interactive Driver icon is displayed, you're ready to calibrate. See the next section for instructions.

note

Do not select Exit or Quit from the Easy Interactive Driver menu. If you do, you will have to open the driver as described here the next time you want to use the interactive pen.

Calibrating the Projector

Calibration sets up the connection between your computer and the interactive pens. This simple process ensures that your computer can accurately detect the position of the pen on the projection surface.

You need to calibrate before using the pens for the first time, or if you change the resolution on your computer or connect a different computer. You can use either pen for calibration.

Two types of calibration are available:



- Normal, which is faster and appropriate for most situations (25 calibration points)
- Advanced, which is recommended when you need higher accuracy (49 calibration points)

You may need to recalibrate if you change the projector's aspect ratio using the remote control, or if you change the following settings in the projector's menu system:

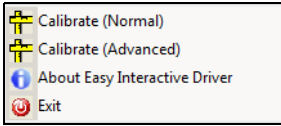
- Settings menu: **Keystone** or **Zoom**. See page 75 for more information.



- Signal menu: Auto Setup, Resolution, Tracking, Sync, Position, or Aspect. See page 73 for more information.

1. To start calibration, do one of the following:
 - In Windows, click the  pen icon in the system tray on your taskbar (lower right corner of your screen), then select **Calibrate (Normal)** or **Calibrate (Advanced)**.
 - In Mac OS, click the  pen icon in the Dock, select **Calibrate** from the menu bar, then select **Calibrate (Normal)** or **Calibrate (Advanced)**.
2. After you read the message about calibration, click **OK**.

You see a flashing green circle in the upper left corner of your projected image.
3. Touch the center of the circle with the tip of the pen.

The circle stops flashing and turns black. You see another circle on the right.

note

For the most accurate calibration, make sure you hold the pen at an angle to the projection surface and touch the center of the circle.

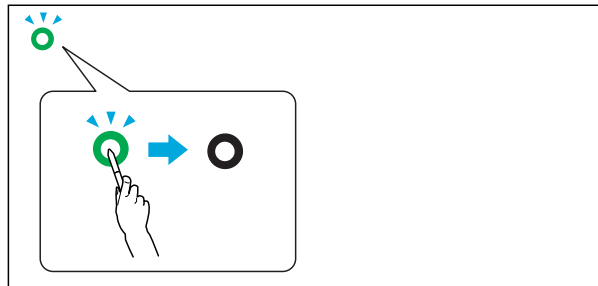

4. Touch the center of the next circle, then repeat. When you get to the end of the row, the next circle appears at the left edge of a new row.

Make sure you are not blocking the signal between the pen and the interactive receiver (next to the projection window on the projector)

Don't press the button on the pen while calibrating.

If you make a mistake, press **Esc** on your computer keyboard and restart the calibration process.

5. Continue until all of the circles are black.

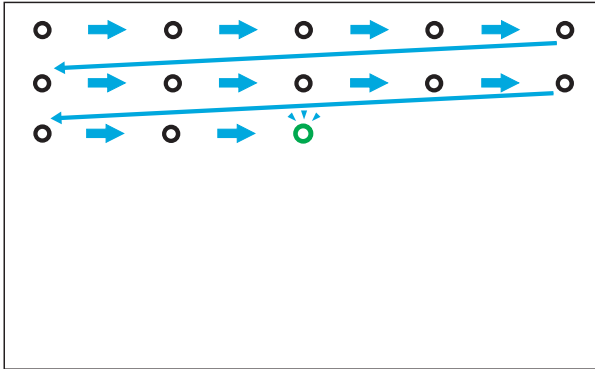

After you have finished calibration, you can use either pen as a mouse on the projection board or wall. With additional software, you can also use the pens to write or draw on the projected image. See the next section for more information.

Using the Pens

The Easy Interactive Driver allows you to use the pen as a mouse. If you installed interactive whiteboard software such as RM Easiteach or the Easy Interactive Tools, you can also use the pens to write or draw on the projected image.

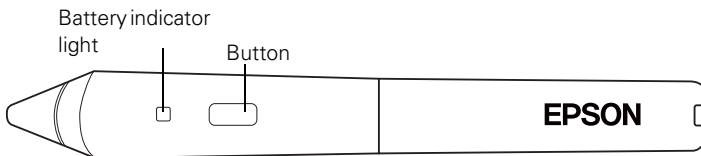

Press the button on the pen to test the battery. If the indicator light is green, the battery has enough power.

Follow these tips to use the pen as a mouse:

- For best performance, hold the pen at an angle, rather than perpendicular to the board.
- To left-click, tap on the board.

- To double-click, tap twice.
- To right-click, tap while pressing the button on the pen.
- To click and drag, tap and drag with the pen.

To use the pen for writing or drawing on the board, you need to install interactive whiteboard software, such as RM Easiteach. You can use your own interactive whiteboard software or Easy Interactive Tools. To download and install Easy Interactive Tools, double-click the Download Easy Interactive Tools link on your desktop.

Using the Easy Interactive Tools for Windows

With Easy Interactive Tools, you can use the pen to write or draw on the projection surface. Make sure you installed the software, as described in the *Quick Guide*.

note



The Easy Interactive Tools are not required for using the interactive features of the projector. You can use RM Easiteach or any other interactive whiteboard software.

1. To start Easy Interactive Tools, select  or **Start > All Programs or Programs > Epson Projector > Easy Interactive Tools**.

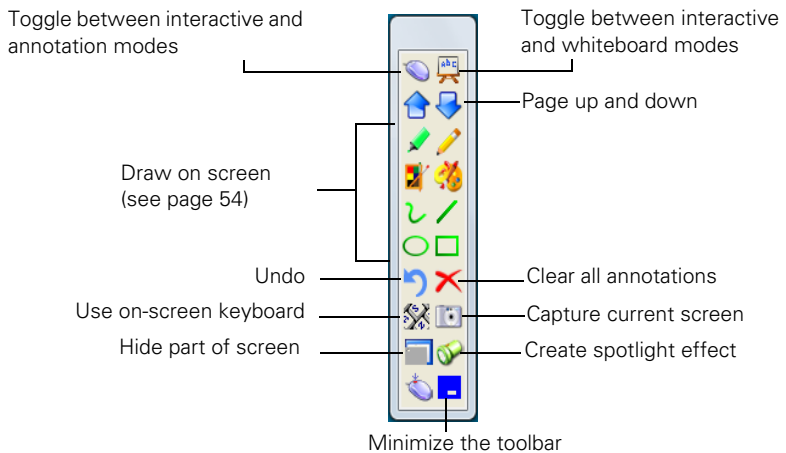
You see the tools on your desktop. When you first open Easy Interactive Tools, you are in interactive mode, as indicated by the mouse icon in the upper left corner of the toolbar.



In interactive mode, you can use the pen to operate your computer, as described on page 51.





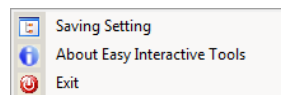



- To switch to annotation mode, select any of the drawing tools described on page 54. Or, select the  mouse icon in the upper left corner.
- To switch to whiteboard mode, select the  whiteboard icon in the upper right corner. Your screen changes to a blank white surface, and new tools are available, as described on page 55.

2. To exit Easy Interactive Tools, select the  Easy Interactive Tools icon on the Windows taskbar and select **Exit**.













Following are lists of the interactive and drawing tools:

Interactive tools

| Icon | Description |
|---|--|
|  | Page up or down in a browser or other software program. |
|  | Use an on-screen keyboard to enter text on a website or in a browser or other software program. |
|  | Capture the current screen and save it as an image file. See page 56 for more information. |
|  | Hide part of the screen. You can use the yellow arrows to adjust the hidden area. |
|  | Create a spotlight effect for highlighting and shading part of the screen. You can move the spotlight, and change its shape, color, and transparency. |
|  | Use the pen to right-click without pressing the button. |
|  | Minimize the toolbar. When the toolbar is minimized, you can restore it by selecting the  Easy Interactive Tools icon on the Windows taskbar. |

Drawing tools

| Icon | Description |
|---|--|
|  | Write or draw with a semi-transparent highlighter. You can select the color and pen width. |
|  | Toggle between writing/drawing and erasing. You can select the color and pen width. In the erase mode, you can select a free-form, straight line, circle, or rectangle eraser. |
|  | Select pen width and color (basic/fast). |
|  | Customize pen width and color (advanced/accurate). |
|  | Draw free-form lines (or use free-form eraser). |
|  | Draw straight lines (or use straight-line eraser) |
|  | Draw circles or ellipses (or use circle eraser). |
|  | Draw rectangles or squares (or use rectangle eraser). |
|  | Undo the last annotation. |
|  | Clear all annotations. |

Using Whiteboard Mode





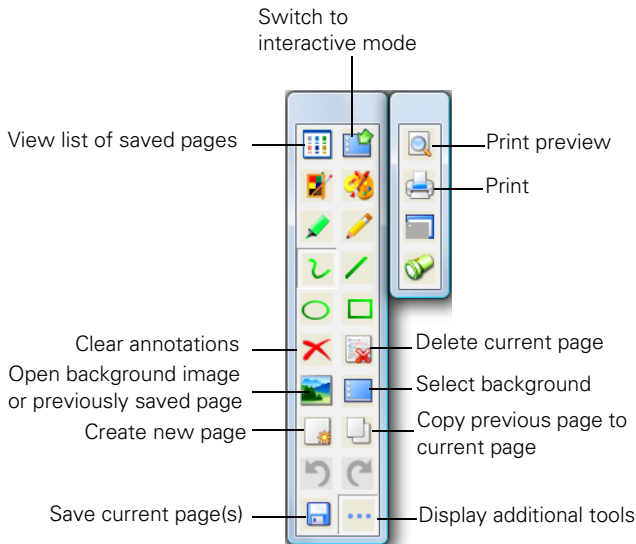

To switch to a white screen that you can use as an interactive whiteboard, select the  whiteboard icon.

You see the whiteboard tools, as shown below. Select the  icon to display additional tools.









Some of the tools are the same as those available in interactive mode. Following is a list of the tools that are unique to whiteboard mode:

Whiteboard tools

| | |
|---|---|
|  | View a list of saved pages in the current folder. |
|  | Switch back to interactive mode. |
|  | Delete the current page and display the previously saved page. |
|  | Insert a picture as the whiteboard background or open a previously saved page. You can select any image file in the JPEG or BMP format. |
|  | Select a background. Tap the button repeatedly to choose from six solid colors, two styles of writing lines, or music staves. |
|  | Create a new page on the whiteboard. |

Whiteboard tools

| | |
|---|--|
|  | Copy the contents of the previously displayed page and paste it on the current page. |
|  | Undo the last operation. |
|  | Redo the last operation. |
|  | Save the current page as an image file. See the next section for more information. |
|  | Display additional tools. |
|  | Print preview. |
|  | Print all whiteboard pages in the current folder. |

Saving Your Pages

You can save both whiteboard pages and computer screen images with annotations. You can also decide where you want to save your pages and in what format.

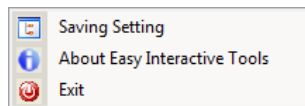

1. Select the  icon in your taskbar (lower right-hand corner of the screen) to open the Easy Interactive Tools menu:

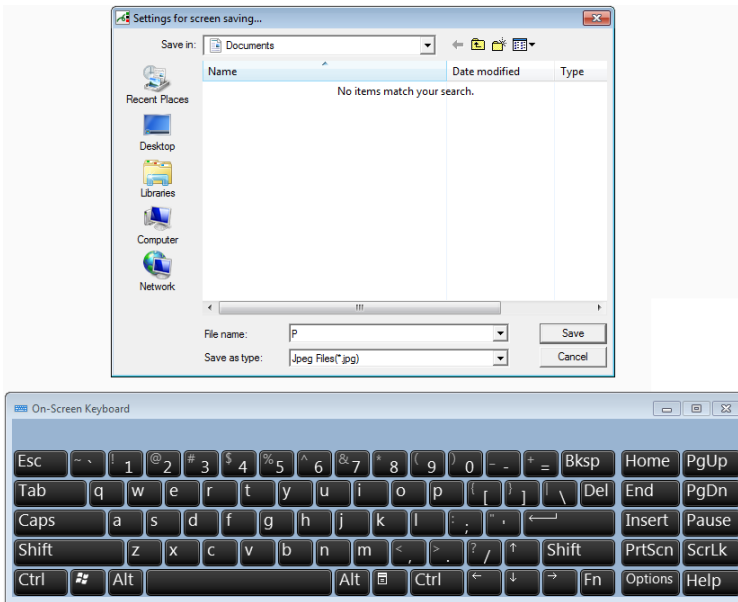

2. Select **Saving Setting**.

You see the on-screen keyboard and a file saving window:



3. Select the folder where you want to save your pages. You can use the on-screen keyboard to enter a file name prefix and select either Jpeg or BMP as the file type.
4. Select **Save**. You return to Easy Interactive Tools.
5. Do one of the following to save your pages:
 - In interactive mode, select the  camera icon to capture the current screen and annotations. You see a message confirming that the screen is saved. Easy Interactive Tools adds the time and date to the file name prefix you selected.
 - In whiteboard mode, select the  save icon. The on-screen keyboard appears and a Save as window opens. You can select a location for saving and enter a name to create a new folder. Your pages are automatically saved as numbered images.

4

Presenting With the Remote Control

The projector includes a number of tools to enhance your presentation. All of them can be accessed using the remote control, which lets you operate the projector from anywhere in the room—up to 19.7 feet (6 meters) away.

This chapter covers:

- Using the remote control
- Controlling the picture and sound
- Displaying Patterns
- Operating your computer with the remote control
- Highlighting your presentation
- Presenting a slideshow from a USB device

note

If a button is stuck down for longer than 30 seconds, the remote control stops operating to conserve battery power. When you release the button, normal operation resumes.

Using the remote control under bright fluorescent lamps or in direct sunlight may affect projector response.

Using the Remote Control

Make sure batteries are installed as described on page 119. Follow these tips for using the remote control:

- Point the remote control at the projector or at the screen.
- Stand within 19.7 feet (6 meters) of the projector.
- Aim the remote control within 30° to the side of, or 15° above or below, the remote control receivers on the projector.

Controlling the Picture and Sound

You can use the remote control to temporarily turn off the picture and sound, freeze the action, zoom in on the picture, and adjust the volume.

Turning Off the Picture and Sound

Press the A/V Mute button on the remote control to turn off the image and sound, and darken your screen. This is useful if you want to temporarily re-direct your audience's attention without the distraction of a bright screen.

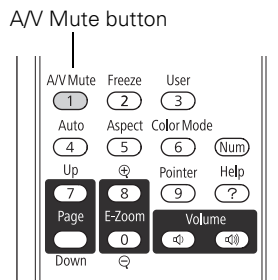

To turn the image and sound back on, press the button again.

You can create an image, such as a company logo or picture, to display on the screen whenever you press the A/V Mute button. (See page 81 for more information.)

Stopping Action

Press the **Freeze** button on the remote control to stop the action in your video or computer image. The image freezes but the sound continues.

To restart the action, press the **Freeze** button again.

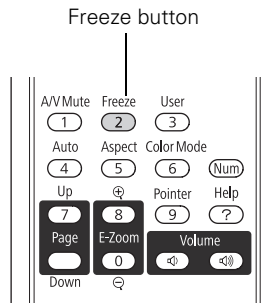

note

The Freeze function pauses the image, not the sound. Because the source continues to transmit signals, it will not resume at the same point.

Zooming In on Your Image

You can zoom in on a portion of the image using the **E-Zoom** buttons on the remote control.

If you are using one of the interactive pens, the pen position and mouse position will not match when you press the **E-Zoom** buttons.

1. Press the **E-Zoom +** button on the remote control.

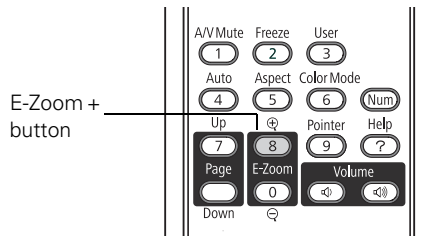

You see a crosshair indicating the center of the zoom-in area.



2. Use the arrow (menu navigation) buttons to position the crosshair.
3. Continue pressing the **E-Zoom +** button to enlarge the selected area up to 4 times.

note

You cannot use the Progressive feature (see page 73) while you are using E-Zoom.

4. While the image is enlarged, you can:
 - Use the arrow buttons to move around the screen.
 - Press the E-Zoom – button to zoom out.
5. Press the ESC button to return the image to its original size.

Controlling the Volume

To change the volume on the projector, press the  or  button on the remote control.

note

To temporarily shut off the sound and picture, press the A/V Mute button.

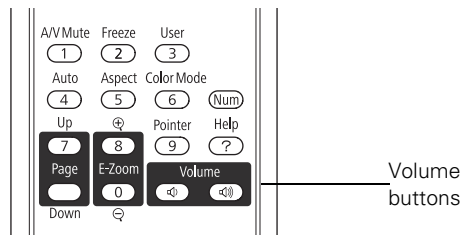

You can also adjust the volume using the projector's menu system. See page 75.

Displaying Patterns

You can display a test pattern or one of the following 4 patterns for use on a whiteboard or chalkboard:



Pattern 1



Pattern 2



Pattern 3



Pattern 4

1. Press the **Menu** button on the remote control, then select the **Settings** menu and press **Enter**.
2. Highlight **Pattern** and press **Enter**.
3. Highlight **Pattern Type** and press **Enter**.

4. Select one of the patterns shown on page 62, or choose **Test Pattern**. If you want to create your own pattern, choose **User Pattern**. See below for more information.
5. Press **Enter** to select the pattern you want, then press **Esc**.
6. Choose **Pattern Display** to display the pattern.
7. Press **Esc** when you're finished displaying the pattern.

Assigning a Pattern to the User Button

You can assign any of the available patterns to the **User** button on the remote control, and then display it by simply pressing the **User** button.

1. In the Settings menu, select the **Pattern Type** as described on page 62.
2. Highlight **User Button** and press **Enter**.
3. Highlight **Pattern Display** and press **Enter**.
4. Press **Menu** to exit.

Creating Your Own Pattern

You can transfer any image from your computer or video source to the projector and then use it as a pattern. If you assign it to the **User** button as described above, you can display it any time you want by simply pressing the **User** button on the remote control.

Start by displaying the image you want to use from a computer or other source. Then follow these steps to capture the image and transfer it to the projector:

1. In the Settings menu, highlight **Pattern** and press **Enter**.
2. Select **User Pattern** and press **Enter**.
3. When you see a message asking if you want to use the current image as the pattern, select **Yes** and press **Enter**.
4. Press **Enter** again.

note

When you choose an image for the user pattern, it erases any previously used image.

- When you see a confirmation message, select **Yes** and press **Enter**. Saving the image may take a few moments. Do not use your projector, remote control, or video source while the pattern is being saved.
- When you see a message that saving is complete, press **Menu** to exit.

Operating Your Computer With the Remote Control

note

You can use the remote control as a wireless mouse only when projecting from the Computer1 or Computer2 ports.

You may need to select specific settings on your computer to use the remote control as a mouse. See your computer documentation for details.

You can use the remote control in place of your computer's mouse so you won't have to stand next to the computer to control the presentation.

Before you can use the remote control to operate your computer, you must connect a USB cable to the **TypeB** (square) USB port on the projector (see page 25) and select **Wireless Mouse** as the **USB Type B** setting on the Extended menu (see page 77).

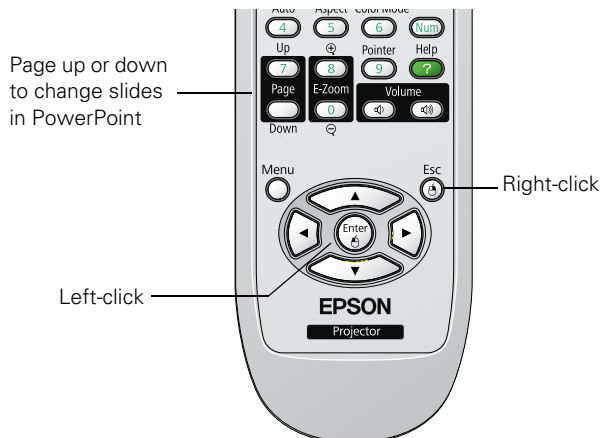

Then you can control your computer as follows:

- Use the remote control's **Page Up** or **Page Down** buttons to move through presentation slides.
- Use the arrow buttons to move the cursor on the screen.
- Press the **Enter** button once to left-click, or twice to double-click. Press the **Esc** button to right-click.
- To drag-and-drop, hold down the **Enter** button. Then use the arrow buttons to drag the object. When it's where you want it, release the **Enter** button.

note

You can use the Page Up/Page Down feature with USB Display.

Highlighting Your Presentation

You can display a pointer to call out important information on the screen. If you want to customize the pointer tool, you can choose from three alternative shapes.

Using the Pointer Tool

1. To activate the pointer tool, press the **Pointer** button on the remote control. A pointer appears on the screen.

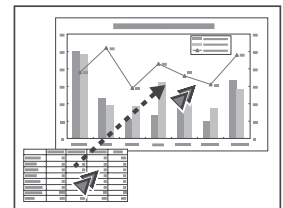
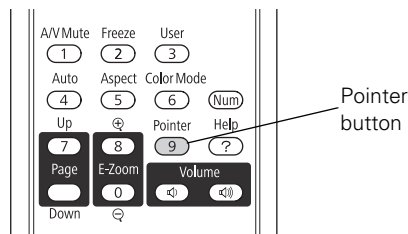

If you prefer to use a different style of pointer, see the instructions in the next section.

2. Use the arrow buttons on the remote control to position the pointer on the screen.
3. When you're done using the pointer, press the **Pointer** or **Esc** button to clear the screen.

Customizing the Pointer Tool

You can change the appearance of the pointer by choosing from three alternative shapes.



1. Press the **Menu** button on the remote control, highlight the **Settings** menu, highlight **Pointer Shape**, and press **Enter**. You can select one of the pointer shapes shown at the left.
2. Select the shape you want and press **Enter**.
3. Press **Menu** to exit from the menu system.

Presenting a Slideshow

You can use your projector's Slideshow feature whenever you connect a USB device that contains image files having a .JPG filename extension. This lets you quickly and easily display individual images, or start a slideshow of all the images in a folder. You can control your slideshow using the projector remote control.

For an instant PowerPoint presentation, convert your PowerPoint slides to individual .JPG files (save as *.jpg) and store them in a folder. Copy that folder to a USB flash memory drive (thumb drive), or other USB device. Then connect the device to the projector and begin your presentation.

You can switch the display from the device displaying the slideshow to another source using the **Source Search** button or one of the specific source buttons on the remote control. To return to the Slideshow source, press **Source Search** and select **USB**, or simply press the **USB** button.

Starting a Slideshow

1. Connect a USB device to the projector's TypeA  (flat) USB port (see page 37).
2. If you are connected to another image source, press the **USB** button on the remote control to go to the Slideshow program.

note

You can project .JPG files in resolutions up to 4608 × 3072, with pixel counts incrementing in multiples of 8.

If a .JPG file is highly compressed, your projector may not be able to display it correctly. The projector can't display progressive or CMYK .JPG files.

You cannot project movie files using the Slideshow feature.

If you are not connected to another image source, the Slideshow program appears automatically.



Files for images that have been scanned or modified will display an icon, rather than a thumbnail image.

If necessary, press the arrow buttons on the remote control to highlight the device you want to present from, then press the Enter button.

3. If you need to select a subfolder on your device, press the arrow buttons to highlight the folder and press Enter.
4. To display an individual image, press the arrow buttons to highlight it and press Enter. To display additional image files, press the ◀ or ▶ arrow button.
5. To display a slideshow of all the images in the current folder, use the arrow buttons to highlight **Slideshow** on the bottom of the Slideshow screen and press Enter. The images display sequentially one time through. At the end, you see the folder display again.

Select the following as necessary to control your display or slideshow:

- To move back up a folder level, highlight **Back to Top** at the top of the Slideshow screen and press Enter.
- To select a different device, highlight **Select drive** in the upper right corner of the screen, press Enter, and select the device.

note

To rotate a displayed image, press the ▲ or ▼ button on the remote control until it is displayed correctly.

note

*To display a slideshow from a folder that is not open, highlight the folder and press the Esc button on the remote control. Then select **Slideshow** from the menu that appears and press Enter.*

To begin a slideshow from a particular image, use the arrow buttons to highlight that image, press Enter, then press Enter again.

- If all the images in a folder do not fit on the Slideshow screen, highlight **Next page** at the bottom of the screen and press **Enter** to display the next screen full of images. Select **Previous page** at the top of the screen to select the previous screen.
- To exit the slideshow, press **Esc**, select **Exit**, and press **Enter**.

Selecting Slideshow Display Options

1. Highlight **Option** at the bottom left corner of the slideshow screen and press **Enter**. You see this screen:



2. Highlight the options you want to use, and press **Enter**.

| Option | Available settings |
|-----------------------|---|
| Display order | Name order displays files in name order Date order displays files in date order |
| Sort order | In Ascending sorts the files first to last In Descending sorts the files last to first |
| Continuous play | On displays a slideshow continuously Off displays a slideshow one time through |
| Screen switching time | No does not switch file display automatically 1Sec. to 60Sec. displays files for the selected time and switches them automatically |

3. When you are finished, highlight **OK** at the bottom of the screen and press **Enter**. (Highlight **Cancel** and press **Enter** to cancel.)

5 *Using the Projector Menus*

You can use the projector's on-screen menus to adjust the image, sound, and other features. This chapter covers the following information:

- Using the menu system
- Adjusting the image
- Adjusting signal settings
- Customizing projector features
- Customizing power and operation
- Using the projector security features

Using the Menu System

You can use the remote control or the projector's control panel to access the menus and change settings. Follow these steps:

1. To display the menu screen, press the **Menu** button on the remote control or on the projector. You see a menu screen similar to the one below:

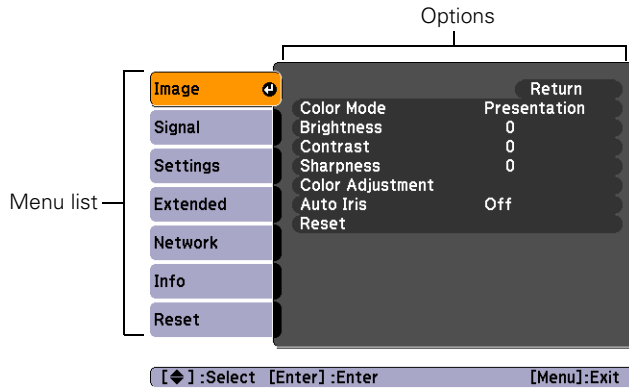

The menus are listed on the left and the options available for the highlighted menu are shown on the right.

2. Use the arrow buttons on the remote control or the projector to scroll through the menu list. When you've highlighted the desired menu, press the **Enter** button to select it.
3. Once you've selected the menu, use the arrow buttons to scroll through the list of options. (Some of the options may be grayed out or unavailable, depending on the selected source.)
4. After highlighting the option you want to adjust, use the arrow buttons to change the setting. In some cases, you may have to press the **Enter** button to view a sub-screen.



- Press the left or right arrow button to adjust a slider bar.
- To select from two or more settings, press the up or down arrow button to highlight the setting and press **Enter**.

- After changing the settings, press the **Esc** button to save your changes and return to the previous menu (or press it again to exit the menu system). You can also press the **Menu** button to exit.

Restoring the Default Settings

You can use the **Reset** option on any menu to restore the factory-default settings for the settings in that menu.

To restore all the projector settings to their factory-default values, select the **Reset** menu, highlight **Reset All**, press **Enter**, and select **Yes** to confirm.



note

*When you select **Reset All** in the **Reset** menu, it does not reset the **Input Signal**, **User's Logo**, **Language**, or **Lamp Hours** settings.*

Adjusting the Image

You can use the **Image** menu to adjust the brightness, sharpness, color, tint, contrast, and **Auto Iris** settings.

- Press the **Menu** button on the projector or remote control and select the **Image** menu. You see a screen similar to one of these:

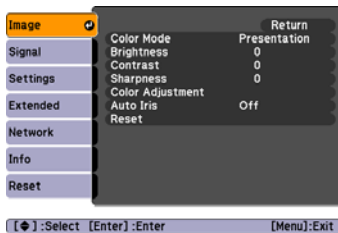

Computer/USB/USB Display/LAN

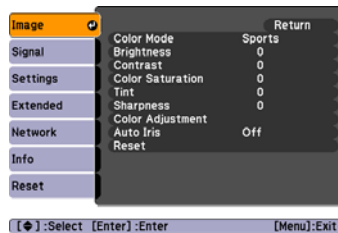

Component video/
Composite video/
S-Video

note

The available settings vary depending on the input source selected.

The Brightness setting changes the opacity of the projector's LCD panels. You can also change the lamp's brightness. Select Power Consumption in the Settings menu, then choose Normal or ECO (the default setting is Normal).

2. Adjust the desired options as needed:
 - **Color Mode**
Lets you quickly adjust the color and brightness for various environments. You can save a different setting for each source. See page 45 for a description of each color mode.
 - **Brightness**
Lightens or darkens the overall image.
 - **Contrast**
Adjusts the difference between light and dark areas.
 - **Color Saturation**
Adjusts the color depth of the image.
 - **Tint**
Adjusts the balance of green to magenta in the image.
 - **Sharpness**
Adjusts the sharpness of the image.
 - **Color Adjustment**
Adjusts the color values. Select **Abs. Color Temp.** to adjust the overall value from 5000 °K (red) to 10000 °K (blue). Select **Red**, **Green**, **Blue** to adjust red, green, and blue hue and saturation values. (Not available if **sRGB** is selected as the Color Mode setting.)
 - **Auto Iris**
Automatically adjusts the projected luminance according to the brightness of the image. (Available only when **Dynamic** or **Theater** is selected as the Color Mode for the current input source.)

Adjusting Signal Settings

Although the projector normally detects and optimizes the input signal automatically, you can use the Signal menu to make manual adjustments. In addition to changing the position of the projected image, you can correct tracking and sync for computer images, or change the aspect ratio.

1. Press the **Menu** button and select the **Signal** menu. You see a screen similar to one of those below. (The settings will be different depending on the source you are projecting from.)

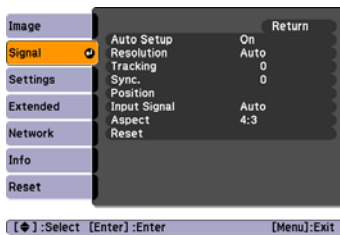

Computer

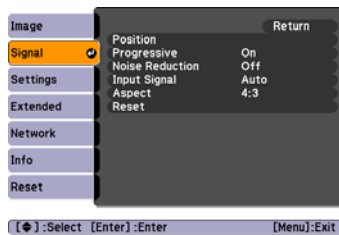

Component video

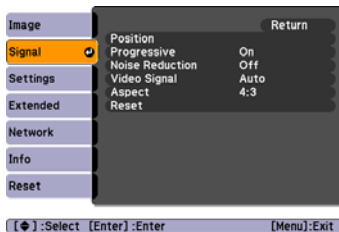

Composite video/S-Video

2. Adjust the desired options as needed:

- **Auto Setup**

Leave this setting **On** to automatically optimize computer images. Turn it off if you want to save adjustments you have made to the Tracking, Sync, and Position settings.

- **Resolution**

Set to **Auto** to have the projector automatically identify the resolution of the input signal. If necessary, select **Wide** (for widescreen images) or **Normal** (for 4:3 or 5:4 ratio images).

note

If you are using the interactive pens, you will have to recalibrate if you change any of these settings: Auto Setup, Resolution, Tracking, Sync, Position, or Aspect.

note

You can also use the remote control's **Auto** button to automatically reset the projector's *Tracking*, *Sync*, and *Position* settings. See page 132 for details.

- **Tracking**
Adjust this value to eliminate vertical stripes in computer images.
- **Sync**
Adjust this value if computer images appear blurry or flicker.
- **Position**
If the image is slightly cut off on one or more sides, it may not be centered exactly. Select this setting and use the arrow buttons to center it.
- **Progressive**
For composite video, S-Video, and component video. Turn this setting on to convert interlaced signals into progressive signals (best for moving images). Leave the setting **Off** for still images.
- **Noise Reduction**
Smooths out rough images. You may need to experiment to select the best setting for your image. Select **Off** when viewing low-noise image sources, such as DVDs.
- **Input Signal**
If the colors don't look right on the **Auto** setting, select the setting for the type of equipment you've connected to the **Computer1** or **Computer2** port. Choose **RGB** for a computer or RGB-video connection, or **Auto** for a video player that outputs a component video signal (with connectors labeled Y/Cb/Cr or Y/Pb/Pr).
- **Video Signal** (composite or S-Video signals only)
Select the setting for the type of equipment you've connected to the **Video** port. Leave this setting at **Auto** unless you are using a 60-Hz PAL system (then select **PAL60**).
- **Aspect**
Sets the image's aspect ratio (ratio of width to height). See page 46 for more information.

Customizing Projector Features

You can use the Settings menu to lock the buttons on the projector, adjust audio volume, and customize several other features.

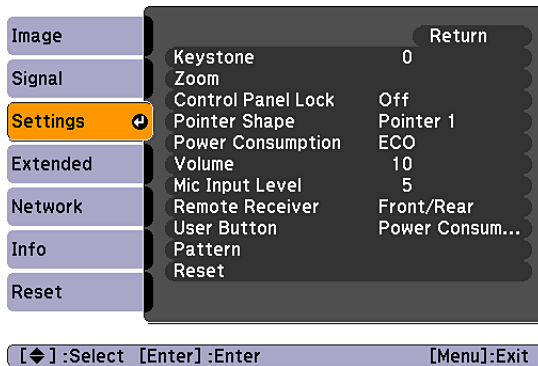

- **Keystone**
Adjusts the shape of the image if the projector has been tilted upward or downward. If you notice that lines or edge look jagged after adjustment, decrease the **Sharpness** setting (see page 71).
- **Zoom**
Adjusts the image size from **Wide** (larger) to **Tele** (smaller).
- **Control Panel Lock**
Lets you disable all of the buttons on the projector, or all of the buttons except the  power button. See page 83 for more information.
- **Pointer Shape**
Lets you choose from three alternative pointer shapes. See page 65 for more information.
- **Power Consumption**
Lets you select from two levels of brightness. The **ECO** setting reduces power consumption and projector noise, and extends the lamp's operating life.
- **Volume**
Raises or lowers the volume of the projector's speaker.

note

If you are using the interactive pens and you change the Keystone or Zoom settings, you will have to recalibrate.

- **Mic Input Level**
Adjusts the microphone volume.
- **Remote Receiver**
Deactivates the projector's front and/or rear sensors that detect signals from the remote control. Use this setting to prevent use of the remote control or to stop interference from bright fluorescent lights. Restart the projector for this setting to take effect.
- **User Button**
Lets you create a shortcut to one of the following menu items: , Power Consumption, Info, Progressive, Closed Caption, Test Pattern, Resolution, Mic Input Level, or Pattern Display. When you press the User button on the remote control, the assigned menu item is displayed.
- **Pattern**
Lets you select one of the following:

Pattern Display to display one of the available patterns.

Pattern Type to select from the following 4 patterns, or select a user-defined pattern:



Pattern 1



Pattern 2



Pattern 3



Pattern 4

User Pattern to capture a customized pattern. See page 63 for more information.

Test Pattern to display a pattern that you can use for adjusting the projector without connecting it (for a 16:10 image). You can use the pattern to adjust the zoom, focus, and other settings. To cancel the test pattern, press the **Esc** button on the remote control.

Customizing Power and Operation

You can use the Extended menu to customize the way the projector displays images, enable Direct Power On, use closed captioning, turn sleep mode on or off, and customize other projector operations.

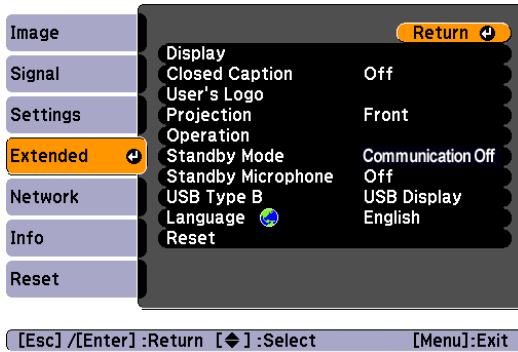

■ Display

Messages: Lets you turn screen messages on or off.

Display Background: Sets the screen background to **Black**, **Blue**, or **Logo** when no image signal is available.

Startup Screen: Enables or disables display of the startup (User's Logo) screen when the projector is turned on.

A/V Mute: Sets the screen background to **Black**, **Blue**, or **Logo** when the A/V Mute button is pressed.

■ Closed Caption

Lets you display closed captioning for content that provides it.

■ User's Logo

Create a custom startup screen, as described on page 81.

■ Projection

Select **Front/Ceiling** to project onto the front of a screen when the projector is mounted upside-down or **Rear/Ceiling** to project from behind onto a transparent screen when the projector is mounted upside-down.

note

If **Direct Power On** is enabled, the power cord is connected, and a power outage occurs, the projector will start when the power is restored.

note

Do not use the projector at altitudes above 7,500 feet (2,286 meters).

■ Operation

Direct Power On: Enable if you want to be able to start the projector when you connect the power cord (without pressing the  power button).

Sleep Mode: Enable if you want the projector to turn off automatically if it is idle and no signal is received for 1 to 30 minutes (you can adjust the amount of time using the next setting).

Sleep Mode Timer: When Sleep Mode is on, you can set the period of time before the projector turns off automatically, from 1 to 30 minutes.

High Altitude Mode: Enable when you are using the projector above 4,900 feet (1,500 meters) to ensure that the temperature is regulated properly. Turn this setting off for lower elevations.

■ Standby Mode

Select **Communication On** to enable the projector to be monitored and controlled from a computer when it is in standby mode (the power light is orange). This setting also allows you to use a microphone connected to the projector when the projector is in standby mode.

■ USB Type B

Select how you want to use the **Type B**  (square) USB port. Select **USB Display** to use the USB port to project computer images. Select **Wireless Mouse** to use the remote control buttons like a wireless mouse. See page 64 for restrictions and details.

■ Language

Select a language to use for the projector menus and messages. To change the language, press the **Menu** button on the remote control, highlight **Extended** and press **Enter**, select **Language** and press **Enter**, then select your language and press **Enter**.

Using the Projector Security Features

To prevent unauthorized use of the projector, you can:

- Assign a password. You can use the password to prevent the projector from being turned on and prevent your custom startup screen from being changed. See the next section.
- Create a custom screen that is displayed at startup and/or when the A/V Mute button is pressed. The screen can be locked with a password to discourage theft and provides a way to identify the projector should it be stolen. See page 81.
- Disable the projector's buttons; this is useful, for example, in a classroom when you want to ensure that no one touches the projector's buttons while you're using the remote control. See page 83.
- Secure the projector to prevent theft using a cable locking system. See page 84.

Enabling Password Protection

The default setting for the password is 0000. Follow these steps to create a new password:

1. Press the **Freeze** button on the remote control for five to seven seconds. You see this screen:

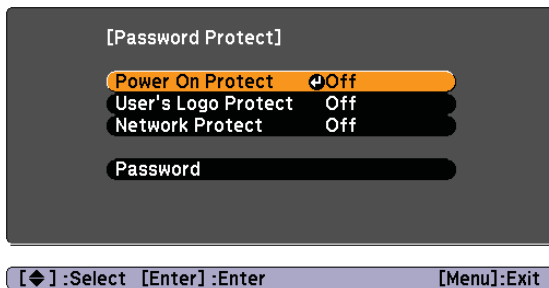

2. Select the type(s) of password protection you want to use:

caution

If you lose the remote control, you will not be able to enter the password. Keep the remote control in a safe place at all times. Also, it's a good idea to write down your password.

- **Power On Protect:** Prevents unauthorized use of the projector. After the projector is plugged in and turned on, you must enter a password to use the projector. Select **On**, press **Enter**, then press **Esc** to return to the Password Protect screen.
- **User's Logo Protect:** Prevents your custom screen (see page 81), display, and User's Logo settings in the Extended menu from being changed. Select **On**, press **Enter**, then press **Esc** to return to the Password Protect screen.
- **Network Protect:** Prevents any of the network settings from being changed. Select **On**, press **Enter**, then press **Esc** to return to the Password Protect screen.

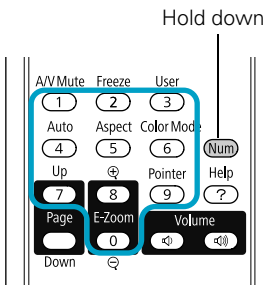

3. Use the arrow buttons to select **Password** and press **Enter**.
4. When you see a message asking if you want to change the password, select **Yes** and press **Enter**.
5. Hold down the **Num** button and use the numeric keypad to enter a four digit password.
6. When you see a confirmation message, re-enter the password.
7. Press the **Menu** button, then press **Enter** to exit the screen.
8. Turn off and unplug the projector.

Starting the Projector With a Password

When the password function is enabled, you see this screen when you plug in and turn on the projector:

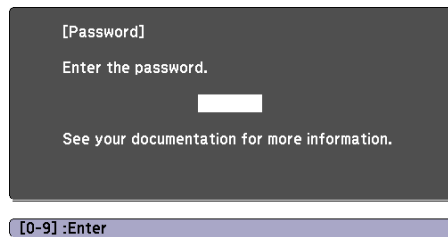

Hold down the **Num** button and use the numeric keypad to enter the four digit password.

note

If you leave the projector plugged in, the Password screen will not appear. It appears only if you unplug and reconnect the power cord.

The password screen closes and projection begins.

If projection does not begin, check the following:

- If the password is not correct, you see a message prompting you to re-enter the password. If you enter an incorrect password three times in succession, you see an error code with the message **The projector's operation will be locked** and the projector switches to standby mode. Write down the error code, then disconnect the projector's power cord from the electrical outlet, reconnect it, and turn the projector back on. Try entering the correct password again.
- If you have forgotten the password, contact Epson with the request code number that appears in the Password screen for assistance. See "Where To Get Help" on page 140.
- If you enter an incorrect password 30 times in succession, the projector remains locked and you must contact Epson to arrange for service.

Creating Your Own Startup Screen

You can transfer any image from your computer or video source to the projector and then use it as your startup screen. You can also use it as the screen displayed when the projector is not receiving a signal or when you press the A/V Mute button. The image can be a company logo, slogan, photograph, or any other image you want to use.

Capturing the Image

Start by displaying the image you want to use from either a computer or video source, such as a DVD player or digital camera. Then follow these steps to capture the image and transfer it to the projector:

note

When you choose an image for the user's logo, it erases any previously used image. You can save an image up to 300 × 400 pixels in size. Once you have saved a new user's logo, you cannot return to the factory default logo.

1. Press the Menu button on the remote control, highlight the Extended menu, and press Enter.

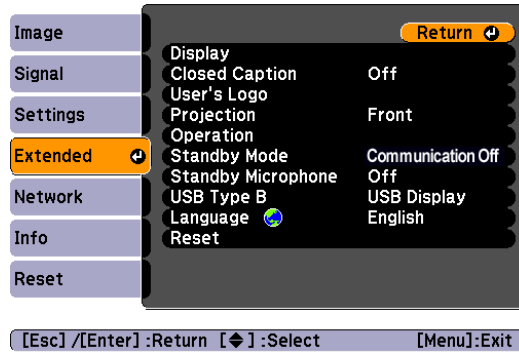

2. Highlight User's Logo and press Enter.
3. When you see a message asking Choose this image as the User's Logo?, select Yes and press Enter. A selection box displays over the image.
4. Use the arrow buttons to select the area of the image you want to use. Then press Enter.
5. When you see the message Select this image?, highlight Yes and press Enter.
6. Use the arrow buttons to select a zoom factor (display size) and press Enter.
7. When the message Save this image as the User's Logo? appears, select Yes and press Enter. Saving the logo may take a few moments. Do not use your projector, remote control, or video source while the logo is being saved.
8. When you see the message Completed, press Menu to exit.

Choosing When to Display the Image

After your image is saved, you can set it to display as the startup screen, the screen you see when there's no signal, or the screen you see when you press the A/V Mute button (see page 60).

1. Press the **Menu** button, highlight the **Extended** menu, and press **Enter**.
2. Select **Display** and press **Enter**.
3. Choose from these display options:
 - Set **Display Background** to **Logo** to display your image when there is no signal.
 - Set **Startup Screen** to **On** to display your image when the projector is warming up.
 - Set **A/V Mute** to **Logo** to display your image when you press the **A/V Mute** button.
4. When you're finished, press **Menu** to exit.

note

You can lock these settings to prevent them from being changed without a password (see page 79).

Disabling the Projector's Buttons

When you enable the Control Panel Lock function, you can lock all of the projector's buttons, or all of the buttons except the **⏻** power button. The remote control can still be used to operate the projector.

1. Press the **Menu** button, highlight the **Settings** menu, and press **Enter**.
2. Select **Control Panel Lock** and press the **Enter** button.
3. Select **Full Lock** (to lock all projector buttons) or **Partial Lock** (to lock all buttons except the **⏻** power button) and press **Enter**.

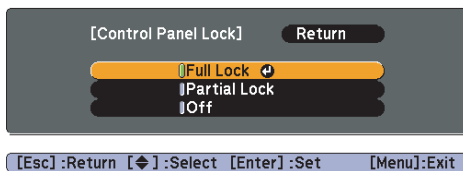

4. Select **Yes** and press **Enter** to confirm the setting.

5. Press the **Menu** button to exit.

To disable the Control Panel Lock function, select **Off** in the Control Panel Lock menu. Or press and hold the **Enter** button on the projector's control panel for seven seconds. A message is displayed and the lock is released.

Using Security Locking

The projector includes two security locking points to prevent its theft when installed or used in public locations:

- **Security cable attachment.** You can attach a commercially available security cable as shown below to secure the projector to the wall mount (setting plate).

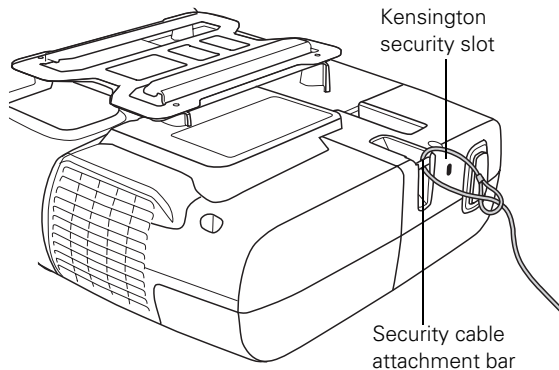

- **Kensington security slot.** The security slot (located on the side of the projector) is compatible with the MicroSaver security systems manufactured by Kensington. You can purchase this lock from Epson (see page 20).

6

Using the Projector on a Network

This chapter tells you how to prepare to send images to your projector through a wired or wireless network.

note

If you want to use the interactive pens while projecting through a wired or wireless network, you must connect the USB cable from the projector to your computer.

Using EasyMP Network Projection, you can project images shown on your computer screen—including text, graphics, and video—directly to your audience. See the *EasyMP Network Projection Operation Guide* for information on features and use.

You can use EasyMP Monitor (available for Windows only) to monitor and control your projector through the network. For information on installing and using EasyMP Monitor, see the *EasyMP Monitor Operation Guide*.

You'll find instructions in this chapter on:

- Connecting the projector to a wired LAN
- Installing the optional wireless LAN module
- Using Quick Wireless Connection
- Configuring projector and network settings
- Using wireless security options
- Sending e-mail alerts and monitoring the projector
- Using a browser to control the projector

For wireless connection, make sure you've installed the optional wireless LAN module, as described on page 89. Then follow the steps in this chapter to use Quick Wireless Connection (Windows only) or configure your projector and network. See the *EasyMP Network*

Projection Operation Guide for instructions on installing the software. The guide also contains instructions on using the software to project over the network.

If you want to use the interactive pens while projecting through a wired or wireless network, you must set the **USB Type B** option to **Wireless Mouse** in the Extended menu. See page 78 for more information.

Connecting to a Wired Network

With a shielded, Category-5 Ethernet cable, you can connect the projector to your network and configure it with an IP address. You can then project from multiple computers on your network without changing any cables.

1. Connect the projector to your network using a commercially available 100BaseTX or 10BaseT network cable. Connect the cable to the LAN port on the projector as shown.

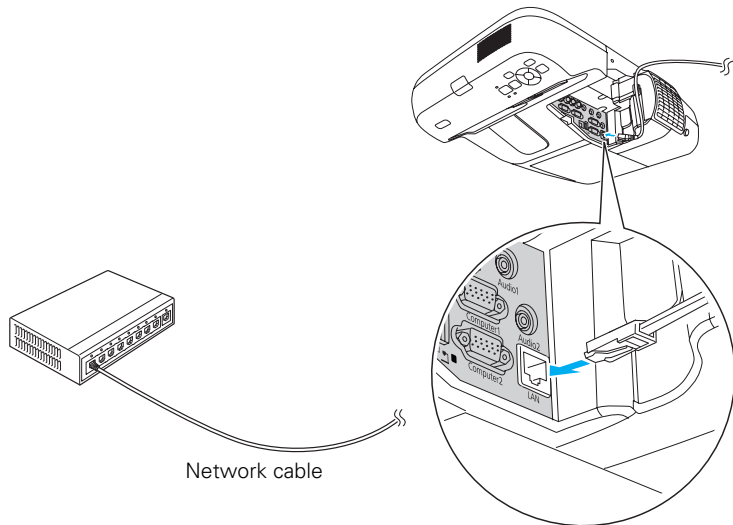

2. Connect the other end to your Ethernet hub or router.
3. Point the remote control at the projector and press the  power button.

4. Press the LAN button on the remote control to select network as the source.
5. Press the Menu button on the remote control, select the Network menu, then press Enter.

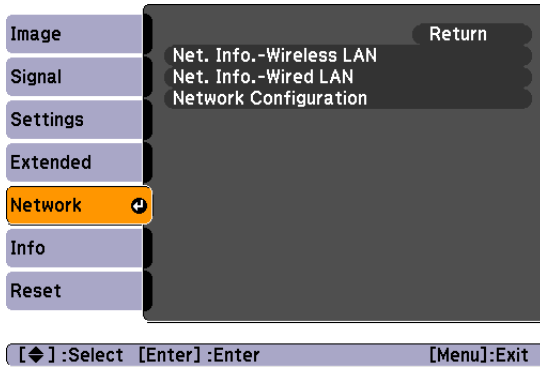

6. Choose Network Configuration and press Enter.
7. Select the Wired LAN menu and press Enter.
8. Choose IP Settings and press Enter. You see a screen like the following:

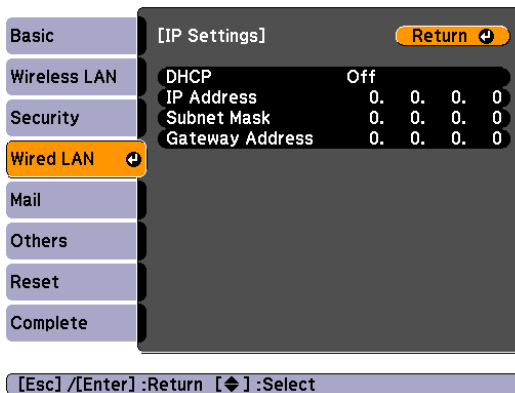

9. Do one of the following:
 - If your network assigns addresses automatically, turn on the DHCP setting.

- If your network does not assign addresses automatically, turn off **DHCP** and enter the projector's **IP Address**, **Subnet Mask**, and **Gateway Address**, as needed.

To enter numbers, use the arrow buttons on the remote control to select each number on the screen, then press the **Enter** button. When you're finished entering an address in the network menu, highlight **Finish**, then press the **Enter** button.

10. Press **Esc** to return to the previous menu.
11. To prevent the IP address from appearing on the standby screen, set the **IP Address Display** setting to **Off**.
12. When you're done making these changes, press **Esc**, select **Complete** and press **Enter**. Then select **Yes** and press **Enter** again to save your settings.

Press **Menu** to exit the menu system.

Installing the Optional Wireless LAN Module

Make sure you have the optional Wireless LAN Module. Turn off the projector and disconnect the power cord before you install the module.

1. Open the air filter cover by sliding the switch and lifting the cover.

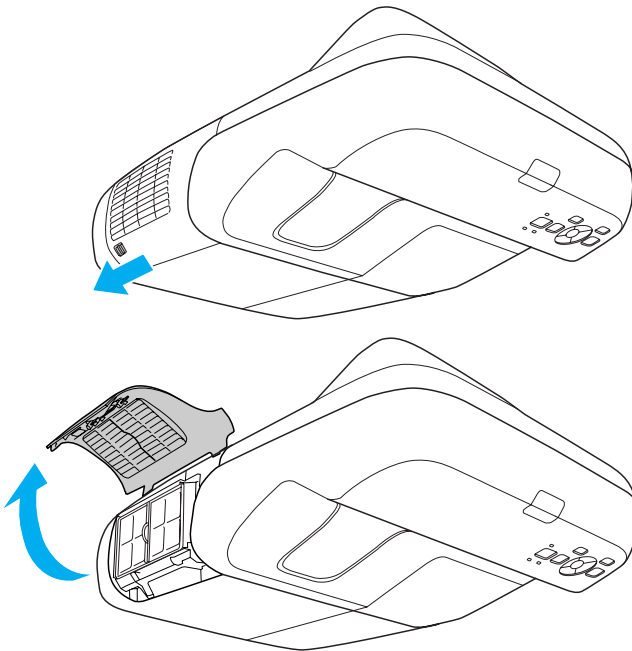

2. Insert the wireless LAN module as shown.

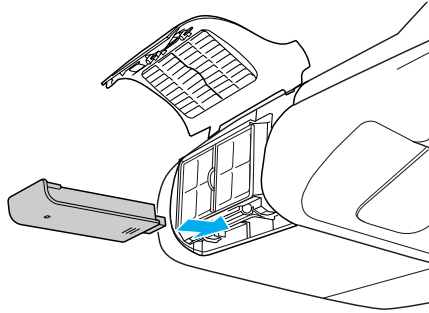

3. As a security feature, you can fasten the module using the screw that came with it.

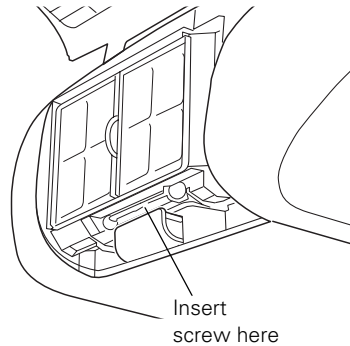

4. Close the air filter cover.

If you have the optional Quick Wireless Connection USB key (V12H005M005), you can use Quick Wireless connection as described in the next section (Windows only). Or, you can configure your connection manually as described on page 91.

Using Quick Wireless Connection

Using the optional Quick Wireless Connection USB key, you can connect the projector to a Windows computer wirelessly without any configuration.

First, make sure you have installed the wireless module as described on page 89 and turned on the projector.

1. Connect the USB key to the projector's TypeA (flat)  USB port.
2. When you see a projected message that the network information update is complete, remove the USB key.
3. Connect the USB key to a USB port on your computer or notebook.

In Windows 7 or Windows Vista, if you see the AutoPlay window, select **Run LaunchU3.exe**. When you see the User Account Control screen, click **Allow**.

4. Follow the instructions on the screen to install the Quick Wireless Connection driver.

If you see a Windows Firewall message, click **Yes** to disable the firewall.

After a few moments, your computer image will be displayed through the projector. If not, try restarting your computer.

5. When you're done with your presentation, remove the USB key. You may need to restart your computer to reactivate your wireless interface.

Configuring Basic Settings

You can give your projector a unique name, enable a projector keyword, or create a password for controlling the projector over the Web.

1. Press the **Menu** button, then choose **Network** and press **Enter**.
2. Choose **Network Configuration** and press **Enter**.

note

Do not attempt to write to the USB key or use it as a flash memory drive.

note

The Quick Wireless Connection utility will disable any other wireless sessions and adapter programs. Make sure you leave the USB key in your computer for your entire Quick Wireless Connection session.

3. Choose **Basic** and press **Enter**. You see the following screen:

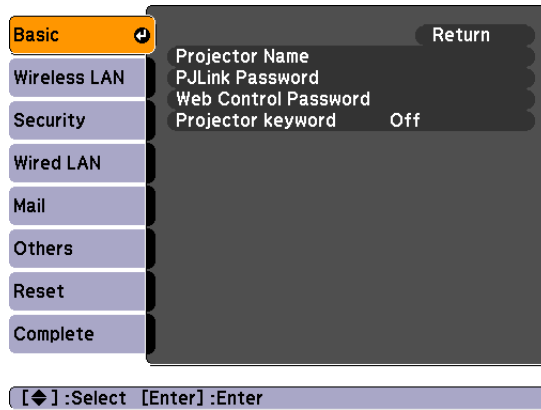

4. Make sure the projector has a unique name, so you can identify it on your network.

If you need to rename it, highlight the **Projector name** text box then press **Enter**.

5. Use the arrow buttons on the remote control to select individual letters; then press **Enter** to input a character. To add a blank space or to navigate backward and forward through the input text, highlight the arrows and press **Enter**. To toggle symbol settings or capital letters, highlight the option and press **Enter**. When you're done, highlight **Finish** and press **Enter**.

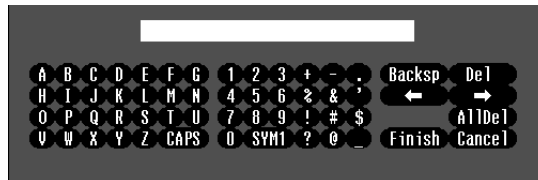

6. If you want to create a password for using PJLink to control the projector, highlight **PJLink Password**, press **Enter**, and enter a password of up to 8 alphanumeric characters. When you're done, highlight **Finish** and press **Enter**.

7. If you want to create a password for remote access to the projector, highlight **Web Control Password**, press **Enter**, and enter a password of up to 8 alphanumeric characters. When you're done, highlight **Finish** and press **Enter**.
8. If you want to set up a security keyword so that only people who are in the same room as the projector can access it, turn **Projector keyword** on. Then when you want to connect to the projector, it displays a randomized four-digit number or "keyword" on the screen. If you're using EasyMP Network Projection, you can enter the keyword on your computer to connect (see the *EasyMP Network Projection Operation Guide* for details).
9. When you're done making these settings, press **Esc**, choose **Complete** and press **Enter**, then choose **Yes** and press **Enter** to save your settings.

Configuring a Wireless Connection

After you install the optional wireless LAN module, you can use the EasyMP Network Projection software to connect to the projector and send images wirelessly in two modes: Ad Hoc mode or Access Point mode.

- **Ad Hoc mode** (computer-to-computer mode) lets you connect just one computer to the projector at a time; it's easy to set up, and the only equipment you need is a computer with a wireless (802.11g, 802.11b, or 802.11a) network card or adapter, or a Macintosh with an AirPort® or AirPort Extreme card. When you connect with this mode, any connection to other wireless networks is broken; you can connect to the projector only.
- **Access Point mode** (infrastructure mode) lets multiple computers access the projector at the same time and easily trade off control over the projector. To use Access Point mode, you need a wireless (802.11g, 802.11b, or 802.11a) access point or an AirPort Extreme (or AirPort) base station, and one or more computers with wireless network cards or adapters.

note

Make sure you've installed the EasyMP Network Projection software as described in the EasyMP Network Projection Operation Guide.

To connect to the projector over a wireless network, your computer must be running Windows 2000, XP, Vista, or Windows 7. Your Mac must be running Mac OS X 10.3 to 10.6.

Access Point mode (infrastructure mode) is required to achieve transfer speeds up to 54MB/sec on an 802.11g network. Ad Hoc mode (computer-to-computer mode) limits network connections to 11MB/sec. This is a standard specification of 802.11g networking.

Configuring the Projector

1. Press the Menu button, then choose **Network** and press **Enter**.
2. Choose **Network Configuration** and press **Enter**.
3. Choose **Wireless LAN** and press **Enter**. You see this screen:

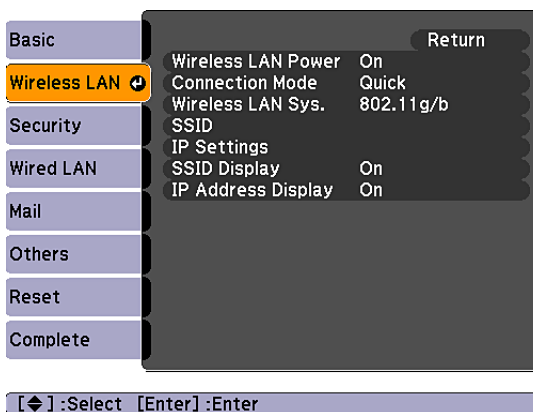

4. Make sure **Wireless LAN Power** is set to **On**. You can turn it off to prevent unauthorized access.
5. Select one of the following connection modes:
 - **Quick mode** lets you easily connect one computer to the projector at a time. You can also select this setting when you're using the optional Epson Quick Wireless Connection USB key.
 - **Advanced mode** lets multiple computers access the projector at the same time and easily trade off control of the projector. This method requires a wireless network access point or an AirPort Extreme (or AirPort) base station.
6. If your network is using 802.11a, use the arrow buttons on the remote control to highlight **802.11a**, then press **Enter** to select it. Press **Esc** to return to the previous menu.

7. Highlight **SSID**, press **Enter**, and enter the name you want to assign to the projector (Quick mode), or the name of your existing wireless network (Advanced mode):

Use the arrow buttons to select individual letters; then press **Enter** to input a character. To add a blank space or to navigate backward and forward through the input text, highlight the arrows and press **Enter**. To toggle symbol settings or capital letters, highlight the option and press **Enter**. When you're done, highlight **Finish** and press **Enter**.

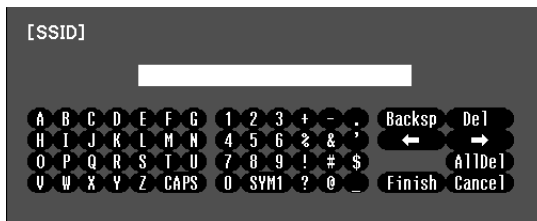

Note that the SSID is case-sensitive (if you enter the name in uppercase on the projector, you must type it the same way on the computer connecting to the projector).

8. Select **IP Settings** and do one of the following:
 - If your network assigns addresses automatically, turn on the **DHCP** setting.
 - If your network does not assign addresses automatically, turn off **DHCP** and enter the projector's **IP Address**, **Subnet Mask**, and **Gateway Address**, as needed.

To enter numbers, use the arrow buttons on the remote control to select each number on the screen, then press the **Enter** button. When you're finished entering an address in the network menu, highlight **Finish**, then press the **Enter** button.

9. If you want to prevent the SSID from being displayed on the standby screen, set the **SSID Display** option to **Off**.
10. To prevent the IP address from appearing on the standby screen, set the **IP Address Display** setting to **Off**. Press **Esc** to return to the previous menu.

note

For specific details about your network, please consult your network administrator.

*If you're using AirPort, start the AirPort Admin utility, select your base station and click **Configure**. Then click the **Network** tab to see your base station's IP address.*

11. When you're done making these settings, press **Esc**. Choose **Complete** and press **Enter**, then choose **Yes** and press **Enter** to save your settings.

Now you're ready to select the wireless network your computer, as described below.

Selecting Wireless Network Settings in Windows

Before connecting to the projector, select the correct wireless network on your computer.

1. To access your wireless utility software, double-click the network icon on the Windows taskbar.
2. Do one of the following:
 - If your projector is set up on an existing network (Advanced mode), select the network name (SSID).
 - If your projector is configured for Quick mode, select the SSID you assigned to the projector.
3. Click **Connect**.

Now you're ready to connect to the projector. See the *EasyMP Network Projection Operation Guide* for details.

Selecting Wireless Network Settings in Mac OS

Before connecting to the projector, select the correct wireless network on your computer.

1. Click the AirPort icon on the menu bar at the top of the screen.
2. Make sure AirPort is turned on, then do one of the following:
 - If your projector is set up on an existing network (Advanced mode), select the network name (SSID).
 - If your projector is configured for Quick mode, select the SSID you assigned to the projector.

note

Settings may vary, depending on your wireless network adapter. See the documentation for your adapter for more information.

Using Wireless Security Options

The projector includes WEP and WPA data encryption security options which you can enable for network projection.

Make sure the settings you select match the ones used by your network; follow the directions from your network administrator.

See the following sections to enable security options on your projector:

- “Enabling WEP Encryption” below
- “Enabling WPA Security” on page 99

You also need to enable security settings from EasyMP Network Projection (see page 100).

Enabling WEP Encryption

1. Press **Menu** on the projector remote. Highlight **Network** and then press **Enter**.
2. Choose **Network Configuration** and press **Enter**.
3. Highlight **Security**, then press **Enter**. You see the following screen:



4. Press **Enter** to select **Security**, then select **WEP** and press **Enter**. Press **Esc** to return to the previous menu.

note

The authentication and firewall features are only effective when the access point for the connection destination supports the same functions.

5. For the WEP encryption setting, select **128Bit** or **64Bit** and press **Enter**. Press **Esc** to return to the previous menu.
6. For Format, highlight **ASCII** to enable text input or **HEX** to enable hexadecimal input, then press **Enter**. Press **Esc** to return to the previous menu.
7. If you chose **64Bit** as WEP Encryption, choose **Encryption key** 1, 2, 3, or 4. Press **Esc** to return to the previous menu.

note

Text input for WEP encryption varies with different access points; check with your network administrator. Try ASCII first. If that doesn't work, try Text2 and then Text3.

Highlight the **Encryption key** that corresponds to the Key ID you selected, then press **Enter**. Use the arrow buttons to select individual letters; then press **Enter** to input a character. To add a blank space or to navigate backward and forward through the input text, highlight the arrows and press **Enter**. To toggle symbol settings or capital letters, highlight the option and press **Enter**. When you're done, highlight **Finish** and press **Enter**.

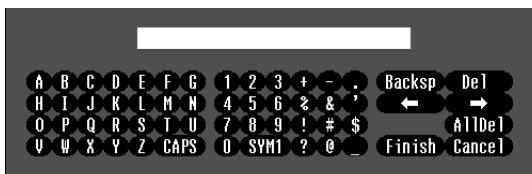

8. Check with your network administrator for directions on entering a key for your network, and follow these general guidelines:
 - For 128 bit WEP encryption with hexadecimal input, enter 26 characters, from 0 to 9 and from A to F.
 - For 64 bit WEP encryption with hexadecimal input, enter 10 characters, from 0 to 9 and from A to F.
 - For 128 bit WEP encryption with ASCII or text input, enter 13 alphanumeric characters.
 - For 64 bit WEP encryption with ASCII or text input, enter 5 alphanumeric characters.
9. For Authentication Type, select **Open** or **Shared**, depending on the setting your network uses. Press **Esc** to return to the previous menu.

- When you're done making these settings, press **Esc**. Choose **Complete** and press **Enter**, then choose **Yes** and press **Enter** to save your settings.

Enabling WPA Security

- Press **Menu**. Highlight **Network** and then press **Enter**.
- Choose **Network Configuration** and press **Enter**.
- Highlight **Security**, then press **Enter**. You see the following screen:



- Press **Enter** to show the menu, then choose one of the following and press **Enter**.
 - WPA-PSK (TKIP)
 - WPA-PSK (AES)
 - WPA2-PSK (TKIP)
 - WPA2-PSK (AES)
- Press **Esc** to return to the previous screen.
- Highlight the **PSK** (pre-shared key) and press **Enter**. Use the arrow buttons to select individual letters; then press **Enter** to input a character. To add a blank space or to navigate backward and forward through the input text, highlight the arrows and

note

If the password is longer than 32 characters, enter it by accessing the projector from a web browser. This lets you enter up to 63 characters. See page 104 for details.

press **Enter**. To toggle symbol settings or capital letters, highlight the option and press **Enter**. When you're done, highlight **Finish** and press **Enter**.

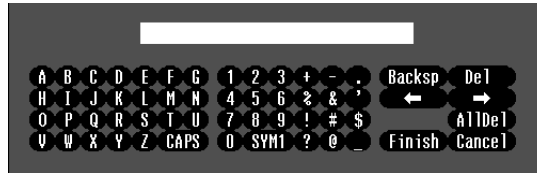

7. When you're done making these settings, press **Esc**. Choose **Complete** and press **Enter**, then choose **Yes** and press **Enter** to save your settings.

Enabling Data Encryption from EasyMP Network Projection

When using the EasyMP Network Projection software, follow these steps to enable data encryption.

1. Click **Set options** on the main screen.
2. Click the **General Settings** tab.
3. Select the **Encrypt communications** checkbox.
4. Click **OK**.

For more information, see the *EasyMP Network Projection Operation Guide*.

Using the EasyMP Software

Once you've set up your projector and computer for network projection, see the *EasyMP Network Projection Operation Guide* for instructions on the following EasyMP features:

- Starting EasyMP Network Projection
- Projecting over the network (content over IP)
- Multi-screen projection
- Using Presentation mode
- Connecting to a projector on a different subnet

Using Projector E-mail Alerts

When this feature is enabled, the projector sends you an e-mail alert if it has any problems.

1. Press the **Menu** button on the remote control, select the **Network** menu, then press **Enter**.
2. Choose **Network Configuration** and press **Enter**.
3. Choose **Mail**, then press **Enter**. You see the following screen:

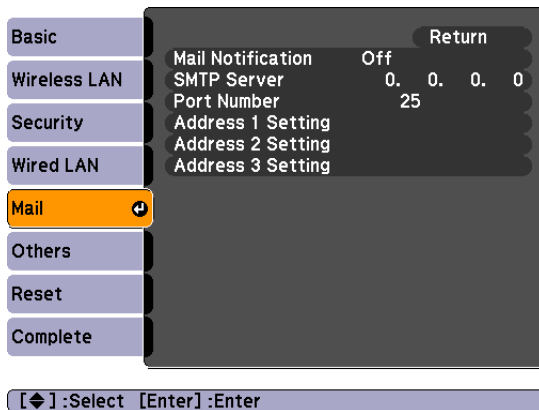

4. Highlight **On** to receive email notifications, then press **Enter**. Press **Esc** to return to the previous menu.

note

If a critical problem develops with a projector which causes it to suddenly stop working, it may not be possible for the projector to send a message.

If Standby Mode is set to Communication ON in the Extended menu, the projector can still be monitored even if the projector is in standby mode (when the power is off).

5. Enter the IP address for the SMTP server for the projector.

You can enter a number from 0 to 255 in each field of the address. However, the following IP addresses cannot be used: 127.x.x.x, 224.0.0.0 to 255.255.255.255 (where x is a number from 0 to 255).

To enter numbers, use the arrow buttons on the remote control to select each number on the screen, then press the **Enter** button. When you're finished entering an address in the network menu, highlight **Finish**, then press the **Enter** button.

6. Enter the SMTP server's port number. The default value is 25. You can enter a numeric value from 1 to 65535.
7. Choose one of the **Address** fields and press **Enter**. Then enter the e-mail address and the contents of the message that you will receive when a problem or warning occurs. You can register up to three addresses. You can enter up to 32 alphanumeric characters for the e-mail address.
8. When you're done making these settings, press **Esc**. Choose **Complete** and press **Enter**, then choose **Yes** and press **Enter** to save your settings.

When the selected problem or warning occurs, an e-mail message is sent to the specified notification addresses. The subject line of the e-mail is **EPSON Projector**.

The e-mail includes the following information:

- Line 1: The name of the projector where the problem has occurred
- Line 2: The IP address of the projector where the problem has occurred
- Line 3: Details of the problem

Using SNMP to Monitor the Projector

Network administrators can use SNMP (Simple Network Management Protocol) to monitor projectors.

1. Press the **Menu** button on the remote control, select the **Network** menu, then press **Enter**.
2. Choose **Network Configuration** and press **Enter**.
3. Choose **Others**, then press **Enter**. You see the following screen:

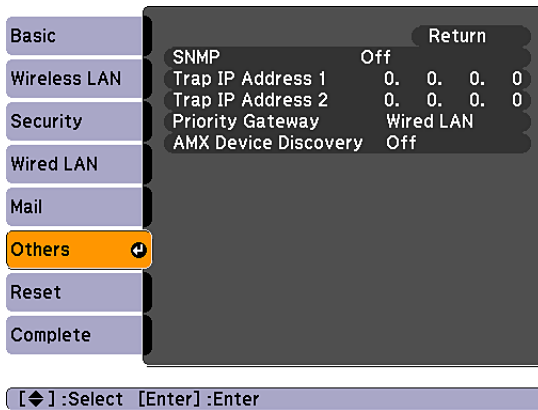

4. Turn on the SNMP setting.
5. Enter up to two IP addresses for notification in the Trap IP Address fields.

You can enter a number from 0 to 255 in each field of the address. However, the following IP addresses cannot be used: 127.x.x.x, 224.0.0.0 to 255.255.255.255 (where x is a number from 0 to 255).

To enter numbers, use the arrow buttons on the remote control to select each number on the screen, then press the **Enter** button. When you're finished entering an address in the network menu, highlight **Finish**, then press the **Enter** button.

6. For **Priority Gateway**, select **Wired** or **Wireless**. Press **Esc** to return to the previous screen.

note

If you're a network administrator, you can use the SNMP option to enter a trap IP address. This lets you receive trap alerts for the projectors you're monitoring.

7. If your network environment uses an AMX controller, select **ON** to allow the projector to be detected by AMX Device Discovery.
8. When you're done making these settings, press **Esc**. Choose **Complete** and press **Enter**, then choose **Yes** and press **Enter** to save your settings.

Using a Browser to Control the Projector

You can use a standard web browser to monitor and control the projector through the network. Because you can use your computer's keyboard, you may find it easier to make network settings using your browser than using the projector's remote control.

1. Make sure the projector is set up for your network, as described on page 86. (Standby Mode in the Extended menu should be set to **Communication On** to monitor the projector in standby mode.) When using a browser to access the projector, you cannot connect through a proxy server.
2. Open your web browser and enter the IP address of the projector you want to monitor in the browser window.

If you're not sure what the address of the projector is, turn the projector on and select **Net. Info.-Wired LAN** or **Net. Info.-Wireless LAN** from the Network menu to display the IP address of the projector. Do not enter the leading zeroes.

3. Press **Enter**, or, if you set a Web control password in the projector's Network menu, enter your user name and password, then press **Enter**. You see a screen like the following:

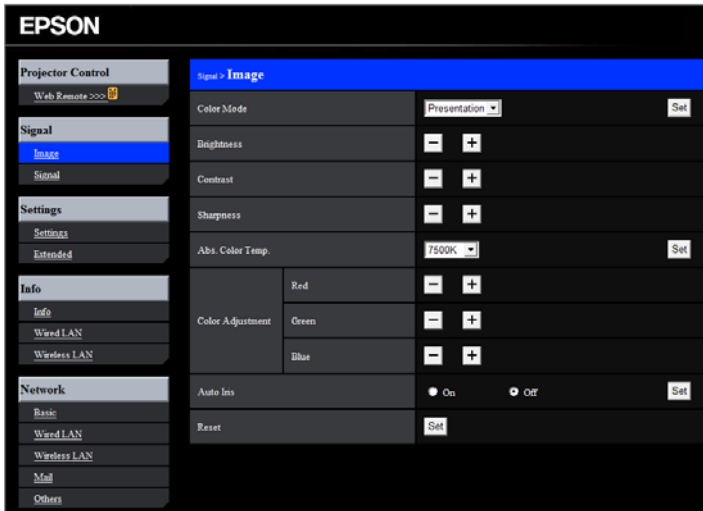

4. Select one of the menu options listed on the screen, then change any of the settings as needed. These settings correspond to those found in the projector's menu system.

You cannot change the following settings using a web browser:

- Pointer Shape, Pattern, or User Button in the Settings menu
- User's Logo, High Altitude Mode, and Language in the Extended menu
- Reset All and Reset Lamp Hours in the Reset menu
- Password protection

Using Web Remote Control

When you access the projector through your browser, you can display a “virtual remote control” on your computer screen. This lets you change sources and perform many of the same functions as you can with the physical remote control.

From the Projector Control menu, select **Web Remote**. You see the following screen:

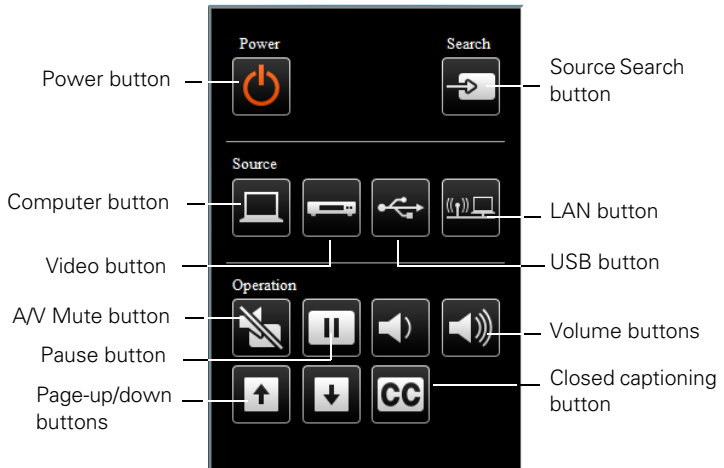

- The **Power** button turns the projector on and off.
- The **Search** button searches for signal sources (see page 43).
- The **Computer** button selects a computer signal (connected to the **Computer1** or **Computer2** port).
- The **Video** button selects a video signal (connected to the **Video** or **S-Video** port).
- The **LAN** button selects a network signal or wireless signal (using the optional wireless unit).
- The **USB** button selects USB computer display (see page 25) or a signal from equipment connected to the **TypeA**  (flat) **USB** port, such as a document camera (see page 37).
- The **Pause** button stops the image (see page 61).

- A/V Mute button temporarily turns off the picture and sound (see page 60).
- The Page Up/Down buttons control PowerPoint slides (requires USB cable. See page 64).
- The Volume buttons raise or lower the audio volume.
- The CC (Closed Captioning) button lets you display closed captioning for content that provides it.

7

Maintaining the Projector

Your projector needs little maintenance. All you have to do on a regular basis is clean the lens, and check that the air filter and vents are clean. A clogged air filter or vent can block ventilation needed to cool the projector.

warning

Before you clean any part of the projector, turn it off and unplug the power cord.

Never open any cover on the projector, except the lamp cover. Dangerous electrical voltages in the projector can injure you severely. Do not try to service this product yourself, except as specifically explained in this User's Guide. Refer all other servicing to qualified service personnel.

The only parts you should replace are the lamp and air filter. If any other part needs replacing, contact your dealer or a qualified servicer.

This chapter covers the following:

- Cleaning the projection window
- Cleaning the projector case
- Cleaning the air filter
- Replacing the air filter
- Replacing the lamp
- Replacing the pen batteries
- Replacing the remote control batteries
- Transporting the projector

Cleaning the Projection Window

Clean the projection window whenever you notice dirt or dust on the surface.

caution

Do not rub the projection window with harsh materials or subject it to shocks, or you may damage the window.

Do not use wax, alcohol, benzene, paint thinner, or other chemical detergents. These can damage the case.

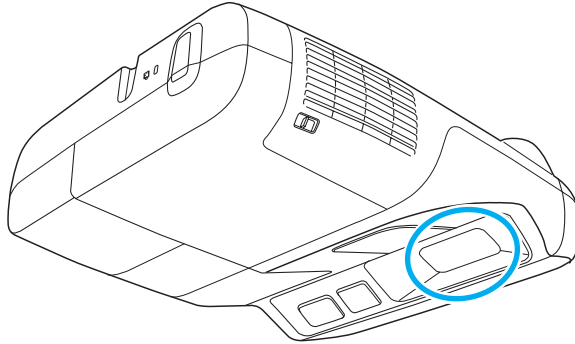

To remove dirt or smears on the window, use a commercially available cloth for cleaning glasses.

Cleaning the Projector Case

Before cleaning, turn off the projector and unplug the power cord.

- To remove dirt or dust, wipe the case with a soft, dry, lint-free cloth.
- To remove stubborn dirt or stains, moisten a soft cloth with water and a neutral detergent and firmly wring the cloth dry. Then wipe the case.

Cleaning the Air Filter

Your projector includes an air filter to ensure the best performance and help protect your equipment investment. If dust collects on the air filter, clean it as described here. Dust clogs prevent proper ventilation and can cause overheating, which can damage the projector.

1. Turn off the projector.
2. Remove dust from the air filter using a small vacuum cleaner designed for computer or office equipment, or gently clean the vent with a soft brush (such as an artist's paintbrush).

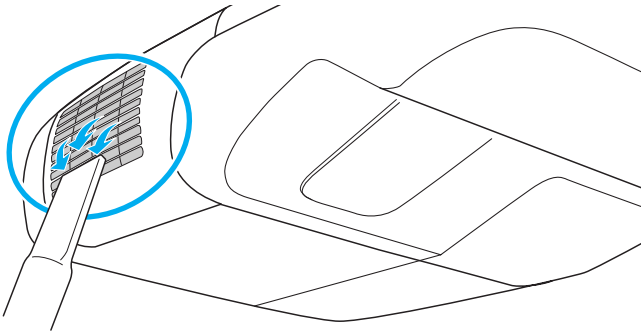

You can remove the air filter to clean both sides.

If the filter is too dirty or broken, replace the filter as described below.

Replacing the Air Filter

You need to replace the air filter if:

- You cannot remove the dust from it
- The air filter is damaged or torn
- You repeatedly see a projected message telling you to clean or replace it

note

To order replacement air filters, request part number V13H134A27. See page 20 for ordering information.

Contact your dealer or call Epson at 800-GO-EPSON (800-463-7766) to obtain a new air filter. Request part number V13H134A27.

1. Turn off the projector and unplug the power cord.
2. Slide the switch, then open the air filter cover on the side of the projector.

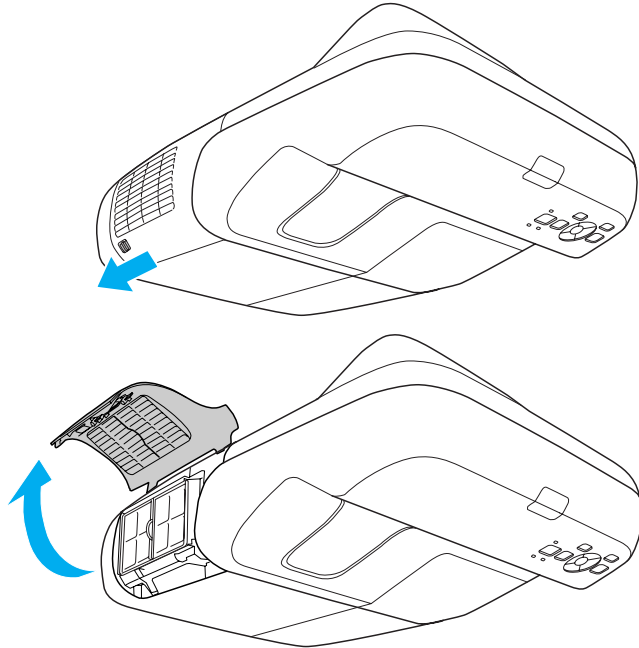

note

Air filters contain polycarbonate, ABS resin, and polyurethane foam. Dispose of used air filters according to local regulations.

3. Grasp the tab and pull the air filter straight out as shown.

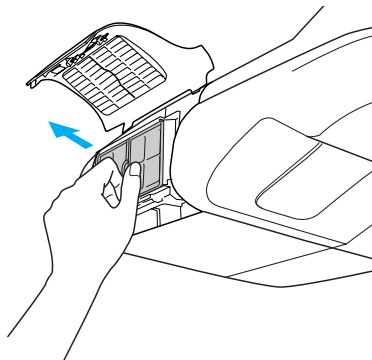

4. Press in the new air filter until it clicks into place.

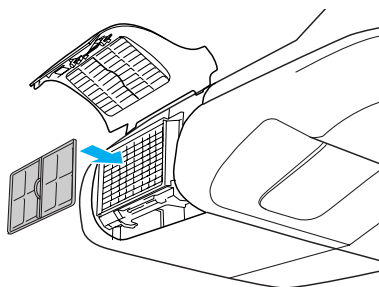

Replacing the Lamp

The life span of the projection lamp is about 2500 hours if **Power Consumption** in the Settings menu is **Normal** (default), and 3500 hours if this setting is **ECO**. See page 117 to check the lamp usage.

It is time to replace the lamp when:

- The projected image gets darker or starts to deteriorate.
- The message **Replace the lamp** appears on the screen and the  **Lamp** light flashes orange. To maintain projector brightness and image quality, replace the lamp as soon as possible.

You may also need to replace the lamp if the  **Lamp** light flashes red. See page 123.

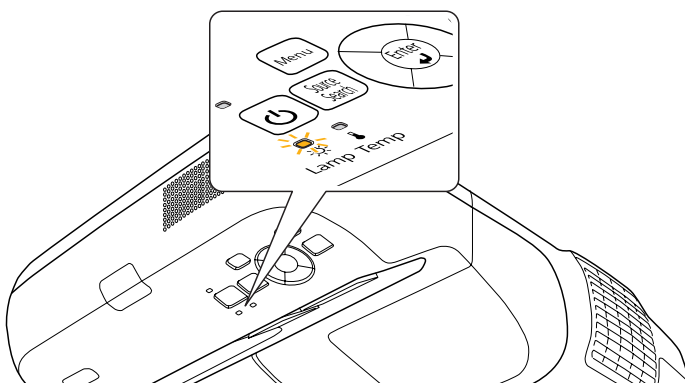

Contact your dealer or call Epson at 800-GO-EPSON (800-463-7766). Request part number V13H010L57.

note

Turn off this product when not in use to prolong the life of the projector.

warning

Let the lamp cool fully before replacing it.

In the unlikely event that the lamp has broken, small glass fragments may be present and should be removed carefully to avoid injury. If the projector has been installed on the ceiling, you should stand to the side of the lamp cover, not underneath it.

If the lamp is used after the replacement period has passed, the possibility that the lamp may break increases. When a lamp replacement message appears, replace the lamp with a new one as soon as possible, even if it is still working.

Follow these steps to replace the lamp:

1. Turn off the projector and unplug the power cord.
2. Let the projector cool for at least an hour (if it has been on). The lamp is extremely hot immediately after use.
3. Loosen the lamp cover screw (you cannot remove it). Then slide the lamp cover off.

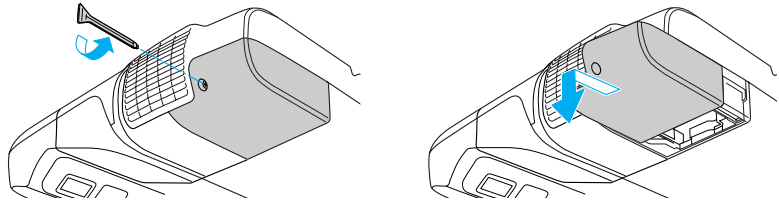

4. Loosen the two screws holding the lamp in place (you can't remove them).

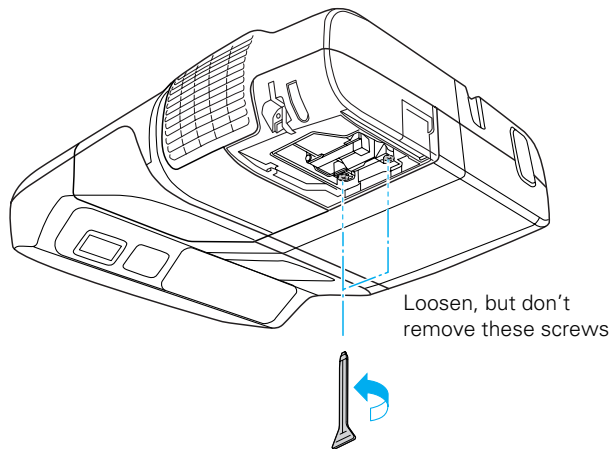

5. Grasp the lamp handle as shown and pull it straight out.

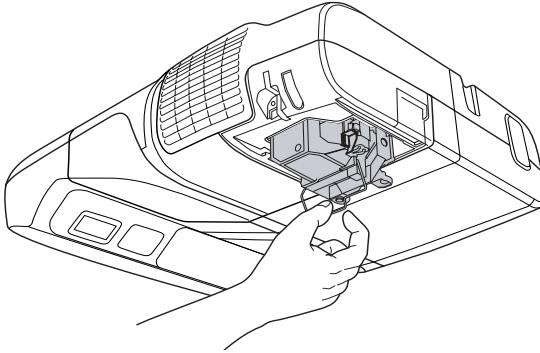

6. Gently insert the new lamp along the guide rail, then push it in place.

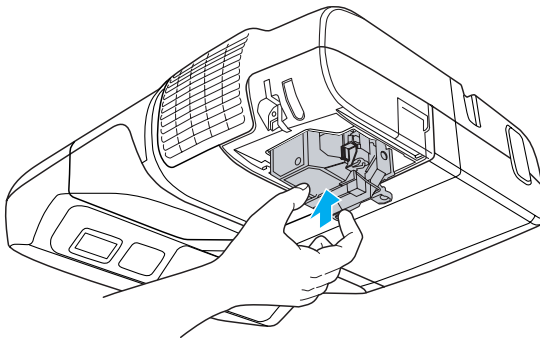

note

 The lamp(s) in this product contain mercury. Please consult your state and local regulations regarding disposal or recycling. Do not put in the trash.

7. Tighten its screws, then press it in by the handle until it clicks into place.

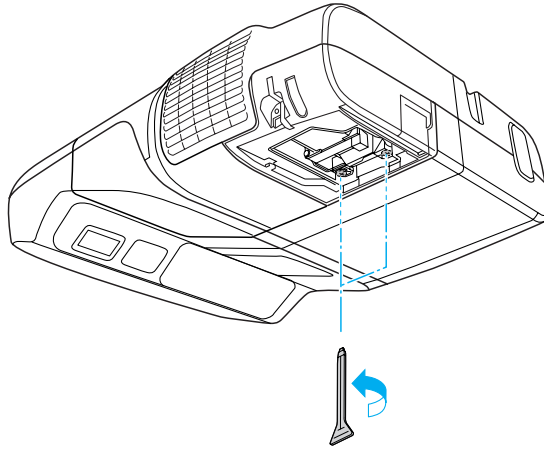

note

Tighten the lamp cover securely so you do not receive a lamp cover error when you turn the projector back on.

8. Replace the lamp cover, then tighten its screw.

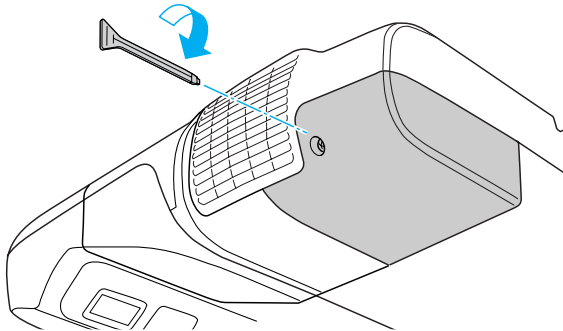

9. Reset the lamp timer as described in the next section.

Resetting the Lamp Timer

After you replace the lamp, you need to reset the lamp timer using the projector's menu system.

1. Press the **Menu** button on the remote control or on the projector's control panel. You see the main menu.
2. Select the **Reset** menu and press **Enter**. You see this screen:

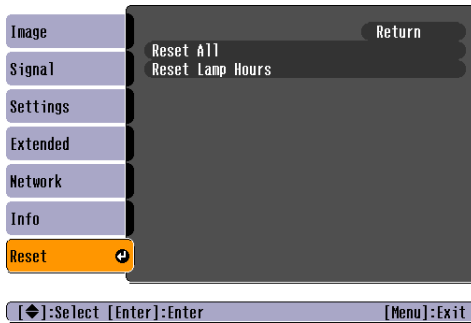

3. Select **Reset Lamp Hours** and press **Enter**.
4. When you see the prompt, select **Yes** and press **Enter**.
5. When you're finished, press **Menu** to exit.

Checking Lamp Usage

To check the number of hours the lamp has been used, press the **Menu** button and highlight the **Info** menu. You see a screen like this:

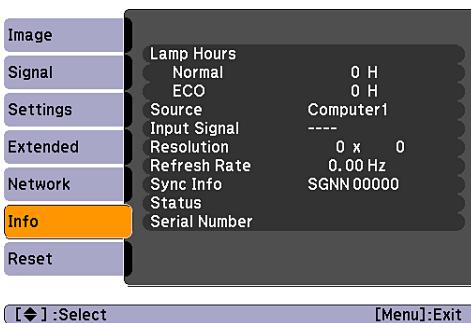

note

The information displayed depends on the input signal currently selected.

If you have used the projector for less than 10 hours, the hours are listed as 0H.

The life span of the lamp is about 2500 hours if **Power Consumption** in the Settings menu is **Normal** (default), and 3500 hours if this setting is **ECO**. Make sure you have a spare lamp handy if the usage hours on this menu are close to the life span of your lamp.

caution

When replacing batteries, take the following precautions:

- *Replace the batteries as soon as they run out. If the batteries leak, wipe away battery fluid with a soft cloth. If fluid gets on your hands, wash immediately.*
- *Do not expose batteries to heat or flame.*
- *Dispose of used batteries according to local regulations.*
- *Do not use batteries other than those specified in this User's Guide and do not use batteries of different types or mix old and new batteries.*
- *Keep these batteries out of the reach of children. Batteries are choking hazards and are very dangerous if swallowed.*

warning

If you have a battery charger, use the charger only with rechargeable batteries. To avoid injury, do not place regular alkaline batteries in a battery charger.

Replacing the Pen Batteries

To check the pen batteries, press the button. If the indicator light is green, the battery has enough power.

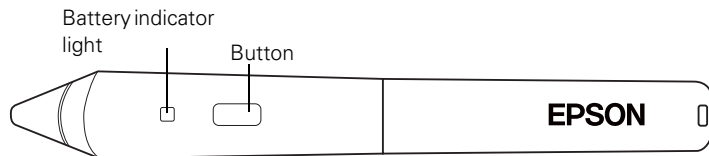

If you need to replace the batteries, use two alkaline AAA batteries. If you have a battery charger, you can also use rechargeable AAA batteries.

1. Press in the tab on the battery cover as you lift the cover off.

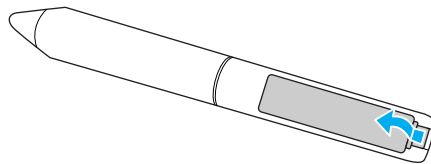

2. Install two batteries, inserting the + and - ends as shown.

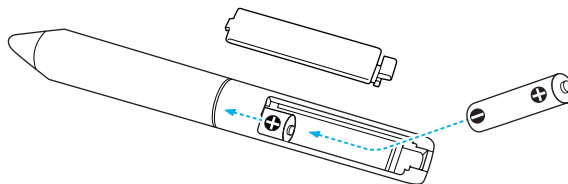

3. Replace the battery cover and press it down until it clicks into place.

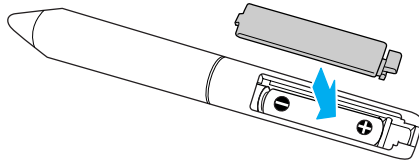

Replacing the Remote Control Batteries

Replace the batteries in the remote as described below:

1. Turn the remote control over.
2. Press in on the catch on the battery cover as you lift the cover off.

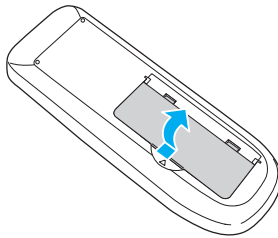

3. Install two AA alkaline batteries, inserting the + and – ends as shown.

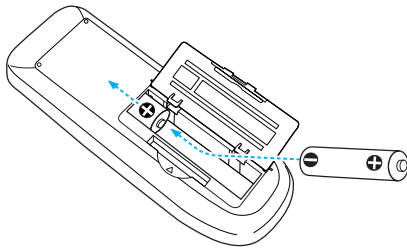

4. Replace the battery cover and press it down until it clicks into place.

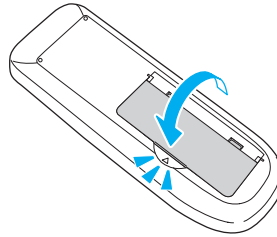

Transporting the Projector

The projector contains many glass and precision parts.

Follow these guidelines to prevent damage when transporting it:

- When shipping the projector for repairs, use the original packaging material if possible. If you do not have the original packaging, use equivalent materials, placing plenty of cushioning around the projector.
- When transporting the projector a long distance, first place it in a hard-shell shipping case, then pack it in a firm box with cushioning around the case.

note

Epson shall not be liable for any damages incurred during transportation.

8 *Solving Problems*

This chapter helps you solve problems with your projector and tells you how to contact technical support for problems you can't solve yourself. The following information is included:

- Using the projector's on-screen help system
- What to do when the projector's status lights flash
- Solving projector operation problems
- Solving problems with the image or sound
- Solving problems with the interactive pens
- Solving password problems
- Solving network problems
- Solving problems with the remote control
- Contacting technical support

Using On-Screen Help

If the image doesn't look right or your audio isn't working, you can get help by pressing the ? Help button on the projector or the remote control.

1. Press the ? Help button on the remote control or on the projector. You see the Help menu:

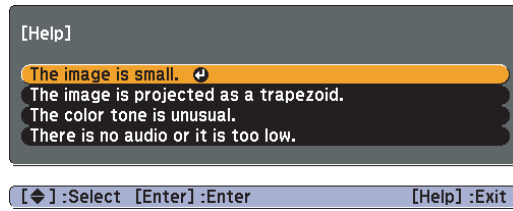

2. Use the arrow buttons on the remote control or the projector to highlight menu items.
3. Press the Enter button on the remote control or the projector to select the menu item and read the solutions.
4. To exit the help system, press the ? Help button or Esc button.

If none of the suggestions solve your problem, see additional solutions to problems in the following sections.

Checking Projector Status

If your projector isn't working correctly, first turn it off and unplug it. Then plug the power cord back in and turn on the projector. If this doesn't solve the problem, check the lights on top of the projector.

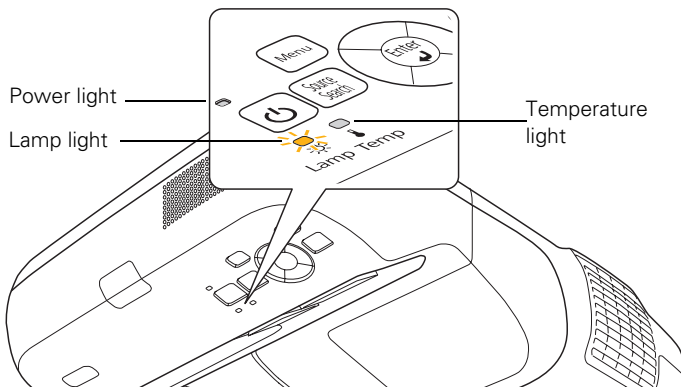

What To Do When the Lights Flash

The lights on top of the projector indicate the projector's status.























Refer to the following tables for a complete description of the projector's status lights:

Power light status



|  Power light status | Description |
|---|---|
| Flashing green | The projector is warming up. Wait for the image to appear. |
| Green | The projector is operating normally. |
| Orange | The projector is in sleep or standby mode. You can unplug it or press the  power button to turn it on. |
| Flashing orange | Preparing for network monitoring or cooling down. |
| Red or flashing red | There is a problem with the projector. Check the next table to diagnose the problem. |

Error light(s) status

| Error light(s) status | Description |
|---|--|
|  Green or orange  Flashing orange  Off | <p>It's time to replace the lamp. See page 113 for instructions. If you continue to use the lamp after the replacement warning, there is an increased possibility that the lamp may break.</p> |
|  Flashing red  Off  Flashing orange | <p>Rapid cooling is in progress. Although this is not an abnormal condition, projection will stop automatically if the temperature rises higher. Make sure there is plenty of space around and under the projector for ventilation, and that the air filter and vents are clean.</p> |
|  Red  Off  Red | <p>The projector is overheating, which turns the lamp off automatically. Wait until the projector switches to standby mode (about 5 minutes). Make sure there is plenty of space around and under the projector for ventilation.</p> <p>The air filter may be clogged. Clean or replace the air filter as described on pages 111 to 113.</p> <p>If you're using the projector above an altitude of 4,900 feet (1,500 meters), turn on High Altitude Mode in the Operation menu (see page 78).</p> <p>If the projector continues to overheat after you clean the air filter, stop using the projector, disconnect the power cord, and contact Epson for help as described on page 140.</p> <p>Warning: Except as specifically explained in this <i>User's Guide</i>, do not attempt to service this product yourself.</p> |
|  Flashing red  Red  Flashing red | <p>The projector has an internal problem. Stop using the projector, disconnect the power cord, and contact Epson for help, as described on page 140.</p> |
|  Red  Off  Flashing red | <p>There is a problem with the fan or temperature sensor. Stop using the projector, disconnect the power cord, and contact Epson as described on page 140.</p> |
|  Red  Flashing red  Off | <p>The lamp may be burnt out. First make sure the lamp cover is securely installed. If that's not the problem, the air filter may be clogged. Clean or replace the air filter as described on pages 111 to 113.</p> <p>If this does not resolve the problem, let the lamp cool and then remove it. If the lamp is cracked, replace it as described on page 113. If the lamp is not cracked, reinstall it. If reinstalling doesn't work, replace the lamp.</p> <p>If you're using the projector above an altitude of 4,921 feet (1,500 meters), turn on High Altitude Mode in the Operation menu (see page 78).</p> <p>If none of these suggestions resolves the problem, contact Epson as described on page 140.</p> |
|  Flashing red  Flashing red  Flashing red | <p>The projector has an Auto Iris error or power error. Stop using the projector, disconnect the power cord, and contact Epson for help, as described on page 140.</p> |

Solving Projector Operation Problems

The power doesn't turn on.

- If the projector doesn't turn on when you press the  power button, make sure the power cord is connected to the projector and plugged into a working electrical outlet.
- The power cord may be defective. Disconnect the cord from the outlet and contact Epson as described on page 140.
- If you're using the Direct Power On function and you immediately plug the power cord back in after unplugging it, the power may not turn back on. Press the  power button to turn the projector back on.

The buttons on the projector don't work.

If the Control Panel Lock function has been enabled, you can't use the buttons on the projector. Try using the remote control instead, or press and hold the projector's **Enter** button for seven seconds to release the lock (see page 83).

You are having trouble projecting through the USB cable connection.

- If the USB Display driver is not installed automatically the first time you connect the cable, do one of the following:

Windows: Double-click **Computer** or **My Computer** > **EPSON_PJ_UD** > **EMP_USDE.EXE**.

Mac OS: Double-click **EPSON_PJ_UD** > **USB Display Installer**.

- If nothing is projected after the drivers are installed, do one of the following:





Windows: Select  or Start > All Programs or Programs > EPSON Projector > EPSON USB Display > EPSON USB Display Vx.x.

Mac OS: Click the USB Display icon in the Dock. If you don't see it, open the USB Display folder in the Applications folder and run USB Display.

- Make sure USB Type B in the Extended menu is set to USB Display (see page 78).
- In Windows, if the mouse pointer flickers, select All Programs or Programs > EPSON Projector > EPSON USB Display > EPSON USB Display Vx.x., then clear the Transfer layered window checkbox.

Solving Problems With the Image or Sound

No image appears on the screen.

- Check that the  power light is green and not flashing. Also press the A/V Mute button on the remote control to make sure the picture has not been turned off temporarily.
- The projector may be in standby or sleep mode. If the  power light is orange, press the  power button to turn the projector on.
- If the power was switched off and then on again, the projector may be cooling down. Wait until the  power light stops flashing and remains orange; then press the  power button again.
- The attached computer may be in sleep mode or displaying a black screen saver. Try pressing a key on the computer.
- If you are projecting from a DVD player or other video source, make sure you turn it on and press its Play button.

- If you are projecting video from a laptop, you may need to set the laptop to external output only.
- If you are projecting from a composite or S-Video video source, make sure the Video Signal setting is correct (see page 73).
- You can also try resetting all of the menu settings (see page 71).
- If you're projecting through your computer's USB port, make sure the **USB Type B** setting in the Extended menu is set to **USB Display** (see page 78).

With Windows, you may need to install the USB display drivers manually by clicking **My Computer** or **Computer** > **EPSON_PJ_UD** > **EMP_UDSE.EXE**. If nothing is projected after the USB display drivers are installed, click **All Programs** or **Programs** > **EPSON Projector** > **EPSON USB Display** > **EPSON USB Display Vx.x** on your computer.

With Mac OS X, click the **USB Display** icon in the Dock. If there is no USB Display icon in the Dock, open the **USB Display** folder in the Applications folder and run **USB Display**.

- If you see a black screen and you are connected through your computer's USB port (or through your network), the application may be using DirectX drawing features, which are not supported.

You've connected a computer and see a blue screen with the message No Signal displayed.

- Make sure the cables are connected correctly, as described beginning on page 24.
- If you've connected a computer and one or more video sources, you may need to press the **Source Search** button to select the correct source. Allow a few seconds for the projector to sync up after pressing the button.
- Make sure the power for your connected equipment is turned on.

If you're using a PC notebook:

- Press the function key that lets you display on an external monitor. It may have an icon such as , or it may be labelled CRT/LCD. You may have to hold down the Fn key while pressing it. Allow a few seconds for the projector to sync up after changing the setting. Check your notebook's manual or online help for details.

On most systems, the  key lets you toggle between the LCD screen and the projector, or display on both at the same time.

- Depending on your computer's video card, you might need to use the Display utility in the Control Panel to make sure that both the LCD screen and external monitor port are enabled. See your computer's documentation or online help for details.

If you're using Mac OS X:

1. Open System Preferences.
2. Click Display or Displays.
3. Click Detect Displays.
4. Do one of the following:

Mac OS X 10.6: Click Show displays in menu bar.

Other versions of Mac OS X: Make sure the VGA Display or Color LCD dialog box is selected. Click the Arrangement or Arrange tab and make sure the Mirror Displays checkbox is selected.

The message Not Supported is displayed.

- Make sure the correct input signal is selected in the Signal menu (see page 73).
- Make sure your computer's resolution and frequency or refresh rate is supported by the projector (see page 145). If necessary, change your computer's settings.

The projector and notebook don't display the same image

If you're projecting from a notebook, and you can't see your image on the projection screen and on your computer at the same time, follow these guidelines.

If you're using a PC notebook:

- On most systems, there's a function key that lets you toggle between the LCD screen and the projector, or display on both at the same time. It may be labeled CRT/LCD or have an icon such as . You may have to hold down the Fn key while pressing it. Allow a few seconds for the projector to sync up after changing the setting.
- If the function key doesn't permit you to display simultaneously on both screens, you should check your monitor settings to make sure both the LCD screen and the external monitor port are enabled.

From the Control Panel, open the Display utility, select the **Settings** option, then select the **Advanced** option (in Windows Vista, right-click on the desktop, select **Personalize**, select **Display Settings**, then select **Advanced Settings**). The method for adjusting the settings varies by brand; you may need to click a **Monitor** tab, then make sure the external Monitor port is set as your primary display and/or enabled. See your computer's documentation or online help for details.

If you're using Mac OS X:

You may need to set up your system to display on the projector screen as well as the LCD screen. Make sure your projector is connected and follow these steps:

1. Open **System Preferences**.
2. Click **Display** or **Displays**.
3. Click **Detect Displays**.

4. Do one of the following:

Mac OS X 10.6.x: Click **Show displays** in menu bar.

Other versions of Mac OS X: Make sure the **VGA Display** or **Color LCD** dialog box is selected, click the **Arrangement** or **Arrange** tab, then make sure the **Mirror Displays** checkbox is selected.

Only part of the computer image is displayed.

- Press the **Auto** button on the remote control or the **Enter** button on the projector.
- Make sure the image **Position** setting is correct in the **Signal** menu. See page 74 for more information.
- Press the **Aspect** button on the remote control or select the correct **Aspect** setting from the **Signal** menu. See page 46 for details on the available options.
- Press the **Esc** button on the remote control to cancel the **E-Zoom** function.
- Make sure your computer's resolution setting is correct. See the compatible video formats listed on page 145.
- You also may need to modify existing presentation files if you created them for a different resolution. See your software documentation for specific information.
- If you're projecting a widescreen computer image, adjust the **Resolution** setting (see page 73), if necessary.
- If you're projecting an image from a computer with dual display activated, turn dual display off.

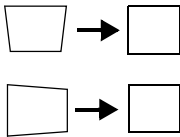

The image isn't square, but keystone-shaped.

If the image isn't evenly rectangular, adjust its shape using the **Keystone** setting on the **Settings** menu (see page 75).

The image contains static or noise.

- If you're using a computer cable longer than 6 feet (1.8 meters), or an extension cable, the image quality may be reduced.
- Keep your computer and video cables away from the power cord as much as possible to prevent interference.
- The video signal may be split between the computer and the projector. If you notice a decline in the projected image quality when the image is displayed simultaneously on your notebook computer and the projector, turn off the notebook's LCD display.
- Make sure the correct input signal is selected in the Signal menu (see page 74).
- If you're using a composite, S-Video, or component video source with 480i signals, turn on the **Progressive** setting on the Signal menu (see page 74).
- If you've used the Keystone adjustment, you may need to decrease the **Sharpness** setting in the Image menu (see page 72).
- If you're projecting from a computer, make sure its signal is compatible with the projector. See page 145.
- If you're projecting from a computer, press the **Auto** button on the remote control to reset the projector's Tracking, Sync, and Position settings.

The image is blurry.

- There may be dirt or smears on the projection window. Clean the window as described on page 110.
- Adjust the focus using the focus lever (see page 44).
- Lower the projection angle to reduce the amount of keystone correction required.
- If you're projecting from a computer, you may need to adjust the tracking and sync settings as described in the next section.

You see vertical bands or the image still looks blurry after trying the solutions in the previous section.

note

*You must be projecting an image for the **Auto** button to have any effect. It works only with computer images projected through the Computer (Component Video) port.*

- If you're projecting from a computer and displaying an image that contains a lot of fine detail, you may notice vertical bands or some of the characters may look heavy or blurred. Press the **Auto** button on the remote control or the **Enter** button on the projector to reset the projector's Tracking, Sync, and Position settings.
- If further adjustment is needed, you can fine-tune the **Tracking** and **Sync** settings manually using the **Signal** menu, as described on page 74.
 1. Fill the screen with an image containing fine detail, such as a pattern to appear as your desktop background, or try projecting black text on a white background.
 2. Adjust the **Tracking** to eliminate vertical bands.

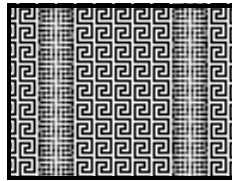

3. Adjust the **Sync** setting to increase the image sharpness.

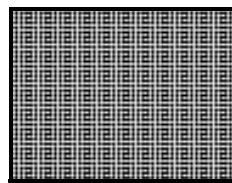

The image is too light or dark, or colors are incorrect.

- Press the **Color Mode** button or select a different **Color Mode** option in the **Image** menu. See page 45 for details on the available options.

note

Because of the different technologies used, your projected image may not exactly match the colors on your notebook or computer monitor.

- If you're displaying video, adjust the **Color Adjustment** and **Color Mode** settings on the Image menu. You can also try adjusting the **Color Saturation**, **Abs. Color Temp**, and **Tint** settings on the Image menu.
- Try adjusting the **Brightness** and **Contrast** settings on the Image menu.
- Try adjusting the **Power Consumption** setting (see page 75).
- Check your computer display settings to correct the color balance.
- The projector's lamp may need to be replaced. See page 113 for instructions.
- Make sure the correct input signal is selected in the Signal menu (see page 74).
- Make sure that all cables are connected to the proper ports and connected securely.

Nothing appears on an external monitor.

The only images that can be displayed on an external monitor are computer images connected through the **Computer1** or **Computer2** port (see page 24).

There is no sound, or the sound is not loud enough.

- Use the **Volume** buttons to adjust the volume (see page 62), or adjust the **Volume** setting in the Settings menu.
- Make sure you are using a “no resistance” audio cable.
- Make sure **A/V Mute** is not enabled. (Press the **A/V Mute** button to disable it.)
- If your presentation includes computer audio, make sure the volume control on your computer is not turned all the way down or muted. In Windows, you may be able to check this by clicking the volume control in your Windows system tray (lower right corner of the screen). On a Mac, you may be able to adjust the volume from your menu bar (top right corner of the screen) or via the volume control function keys.

- If you're using a DVD player or other video source, make sure the cables are connected correctly, as described on page 33.
- If you are using a microphone connected to the projector's Mic port, make sure the cable is connected securely and the Mic Input Volume on the Settings menu is adjusted correctly. See page 75 for more information.

Solving Problems With the Interactive Pens

You see the message “Hardware device not found” when you try to use the Easy Interactive Driver.

- Make sure the USB cable is securely connected to the projector and computer. Try disconnecting and reconnecting the cable to your computer.
- If you're using a laptop computer, make sure the battery has enough power.
- If an antivirus program is running, try disabling it and restarting the Easy Interactive Driver.

You don't see the Easy Interactive Driver on your computer.

If you don't see the  pen icon on your taskbar (Windows) or in the Dock (Mac OS), do one of the following:

- Make sure you install the driver from the CD labeled “Epson Projector Software for Easy Interactive Function.”
- In Windows, select All Programs or Programs > Epson Projector > Easy Interactive Driver.
- In Mac OS, open the Application folder, then select the Easy Interactive Driver icon.
- If the  pen icon has a red X on it, make sure the USB cable is securely connected to the projector and computer. Try disconnecting and reconnecting the cable to your computer.

The pen doesn't work.

- Make sure nothing is blocking the signal between the pen and the interactive pen receiver on the projector (see page 14).
- Make sure the cable cover is in place to keep cables from blocking the signal.
- Make sure the pen batteries have enough power. If the light on the pen doesn't turn green when you press the button, you need to replace the batteries.
- If you are projecting through a wired or wireless network, make sure the **USB Type B** option is set to **Wireless Mouse** in the Extended menu (see page 78).
- Dim the room lights and turn off any fluorescent lights. Make sure the projection surface and the pen receiver are not in direct sunlight or other sources of bright lighting.
- Make sure the USB cable is securely connected to the projector and computer. Try disconnecting and reconnecting the cable to your computer.

The pen is hard to use.

For easier operation, hold the pen at an angle to the projection surface.

The pen position is not accurate.

- If you use the **E-Zoom +** button on the remote control to enlarge the image, the pen position will not be accurate. When you return to the original size, the pen position should be correct.
- You may need to recalibrate (see page 49).
- Make sure the cable cover is in place to keep cables from blocking the signal.

You're having trouble calibrating.

- If the flashing circles don't appear, make sure the VGA cable and USB cable are securely connected to the computer. Try restarting the Easy Interactive Driver, as described on page 134.
- If the circles don't stop flashing and turn black (or they stop flashing and turn black automatically), dim or turn off any bright lights near the projection surface.

Solving Password Problems

If you cannot enter or remember a password, try the following solutions:

- You may have turned on password protection without first setting a password. Try entering 0000 using the remote control.
- If you have entered an incorrect password too many times and see a message displaying a request code, write down the code and contact Epson as described on page 140.

Solving Network Problems

You can't display an image using Quick Wireless Connection.

You may need to restart your computer to connect.

You can't connect to the projector using EasyMP Network Projection.

- Make sure the network cable is connected, as described on page 86.
- If you are using the optional wireless LAN module, make sure it is installed correctly in the projector, as shown on page 89.
- Restart your computer.

- Make sure your projector and computer are configured correctly; see page 94 (configuring the projector) or page 96 (configuring the computer).
- If you are using the optional wireless LAN module, make sure that you have sufficient wireless signal strength (above 50 percent). On a Mac, check the AirPort icon on the Mac menu bar. In Windows, see the documentation for your computer's wireless card or adapter for details.
- Make sure you aren't projecting one of the EasyMP Network Projection screens. (You should see a message that the projector is ready to connect.) If you have to exit a configuration screen, restart EasyMP Network Projection.
- If the projector is configured for Access Point mode and you're using DHCP, allow time for your projector to appear. It takes the server a little while to pick up the IP address.
- If you've changed any settings for your projector or network, or restarted your computer, allow a minute or two for the connection to appear. If you're using AirPort, try turning AirPort off and then on again.
- Make sure that you're trying to connect to the right network. In Windows, verify that you've enabled your computer's connection to the access point or that your wireless card or adapter is enabled and connected to the same SSID as the projector. On a Mac, click the AirPort icon at the top of your Mac desktop to make sure AirPort is turned on and the right network is selected.
- If you have an access point or AirPort base station and you're not using DHCP, check your projector's IP address on the Access Point mode advanced settings screen. The first three segments of the IP address should be identical to the first three segments of the IP address of your access point or base station. The last segment of the projector's IP address should be close, but not identical, to the last segment of the IP address of the access point or base station.

- If you're not using DHCP, check your projector's Gateway address on the projector's Access Point mode advanced settings screen. It should be identical to the IP address for your access point or AirPort base station.
- If you're using a projector keyword, it changes each time you turn the projector off and then on again. Check the projector's keyword on the LAN standby screen and enter it at the prompt.
- If you're using AirPort, check the configuration of your network. Start the AirPort Admin utility, select your base station, click **Configure** and click **Show All Settings**. Click the **Network** tab. If you set up your projector to connect in DHCP mode, turn on **Distribute IP Addresses** and **Share a Single IP Address**.
- If you're using AirPort and DHCP is turned off on your projector's Access Point mode advanced settings screen, make sure **Distribute IP Addresses** is off.
- If you're using Access Point mode and you're connecting to the wrong network, you may be experiencing signal interference from another network. Try resetting your access point or base station, then restart EasyMP Network Projection.
- If you're using AirPort, the projector's SSID should match the AirPort network name, not the name of the AirPort base station. To check the network name, start the AirPort Admin utility, select your base station, and click **Configure**. Then click **Show All Settings**. The network name appears on the AirPort tab.
- If you're prompted for a password when you connect, enter the WEP encryption key (if you're using WEP encryption).

You are not receiving mail when a projector problem occurs.

- Make sure the Mail settings are correct in the Network menu. For details, see page 101.
- To receive mail notification when the projector is in standby mode, you need to set **Standby Mode** to **Communication On** in the Extended menu. See page 78.

Solving Problems With the Remote Control

The projector doesn't respond to remote control commands.

- Point the remote control towards the projector's receiver. Make sure you are within 19.7 feet (6 meters) of the projector and within a 30° horizontal angle and a 15° vertical angle from the projector's front or back receiver.
- The remote control's batteries may not be installed correctly or may be low on power. To change the batteries, see page 119.
- Dim the room lights and turn off any fluorescent lights. Make sure the projector is not in direct sunlight. Strong lighting, especially fluorescent lights, may affect the projector's infrared receivers. Also, turn off any nearby equipment that emits infrared energy, such as a radiant room heater.
- If you can't adjust the room lighting, you can turn off one of the remote receivers by using the Settings menu. Make sure the receivers are not both turned off (see page 76).
- Check to see if a button on the remote control is stuck down, causing it to enter sleep mode. Release the button to wake the remote.
- If you want to use the remote control as a wireless mouse (or to move through presentation slides), make sure **USB Type B** in the Extended menu is set to Wireless Mouse (see page 78). Also, make sure you have connected the USB cable.

Where To Get Help

Epson provides these technical support services:

Internet Support

Visit Epson's support website in the [US](#) or [Canada](#) for solutions to common problems. You can download utilities and documentation, get FAQs and troubleshooting advice, or e-mail Epson with your questions.

Speak to a Support Representative

To use the Epson PrivateLine Support service, call (800) 637-7661 and enter the PIN on the included Epson PrivateLine Support card. This is the fastest way of speaking to a live representative, and it's free. This service is available 6 AM to 6 PM, Pacific Time, Monday through Friday, for the duration of your warranty period.

You may also speak with a projector support specialist by dialing one of these numbers:

- U.S.: (562) 276-4394, 6 AM to 6 PM, Pacific Time, Monday through Friday.
- Canada: (905) 709-3839, 6 AM to 6 PM, Pacific Time, Monday through Friday.

Days and hours of support are subject to change without notice. Toll or long distance charges may apply.

Before you call for support, please have the following information ready:

- Product name (BrightLink 450Wi)
- Product serial number (located on the bottom of the projector and on the Info menu)
- Proof of purchase (such as a store receipt) and date of purchase
- Computer or video configuration
- Description of the problem

Software Technical Support

If your projector included RM Easiteach and you need help, call (866) 728-6758 or visit the following support websites:

www.rmeducation.com/support/et.

www.rmeducation.com/easiteach

For all other software issues, please contact Epson as described on page 140.

Purchase Supplies and Accessories

You can purchase screens and other accessories from an Epson authorized reseller. To find the nearest reseller, call 800-GO-EPSON (800-463-7766). Or you can purchase online at www.epsonstore.com (U.S. sales) or www.epson.ca (Canadian sales).

A *Technical Specifications*

General

| | |
|-------------------------------------|---|
| Type of display | Poly-silicon TFT active matrix |
| Resolution (native format) | 1280 × 800 pixels (WXGA) |
| Color reproduction | 16.8 million colors |
| Light output (brightness) | Normal mode: White light output 2500 lumens (ISO 21118 standard) Color light output 2500 lumens ECO mode: White light output 1740 lumens (ISO 21118 standard) Color light output 1740 lumens |
| Contrast ratio | 2000:1 (Dynamic color mode, Normal Power Consumption, with Auto Iris setting turned on in the Image menu; see page 71) |
| Image size | 59 to 97 inches (149.8 to 246.4 cm) |
| Projection distance | 18.3 to 30.1 inches (.465 to .766 m), lens to projection surface |
| Projection methods | front or rear ceiling mount |
| Internal sound system (monaural) | 10 W |
| Optical aspect ratio | 16:10 (horizontal:vertical) |
| Zoom ratio | Digital 1:1.35 |

| | |
|---------------------|---|
| Noise level | 28 dB in ECO mode 35 dB in Normal mode |
| Keystone correction | ±5° |

Projection Lamp

| | |
|-------------------|---|
| Type | UHE (Ultra High Efficiency E-TORL®) |
| Power consumption | 230 W |
| Lamp life | Approx. 2500 hours (Normal mode) Approx. 3500 hours (ECO mode) |
| Part number | V13H010L57 |

Remote Control

| | |
|---------------|----------------------|
| Range | 19.7 feet (6 meters) |
| Batteries (2) | Alkaline AA |

Dimensions

| | |
|--------|---|
| Height | 6.1 inches (155 mm) |
| Width | 19 inches (481 mm) |
| Depth | 14.5 inches (369 mm) |
| Weight | Approximately 12.9 lb (5.8 kg) without slide plate Approximately 14.1 lb (6.3 kg) with slide plate |

Electrical

| | |
|-------------------|--|
| Rated frequency | 50/60 Hz AC |
| Power supply | 100 to 240 VAC ±10%, 3.4 A to 1.4 A |
| Power consumption | 268 W in ECO mode 363 W Normal mode 0.3 W Standby (Communication Off) 10 W Standby (Communication On) |

note

Lamp life will vary depending upon mode selected, environmental conditions, and usage. Brightness decreases over time.

Turn off this product when not in use to prolong the life of the projector.

| | |
|--------------|--|
| 220 to 240 V | 257 W in ECO mode 343 W Normal mode 0.3 W Standby (Communication Off) 12 W Standby (Communication On) |
|--------------|--|

Environmental

| | |
|------------------------------|--|
| Temperature | Operating: 41 to 95 °F (5 to 35 °C) Storage: 14 to 140 °F (-10 to 60 °C) |
| Humidity (non-condensing) | Operating: 20 to 80% RH |
| Operating altitude | 0 to 7500 ft (0 to 2286 m); over 4921 ft (1500 m), enable High Altitude mode in the Extended menu (see page 77) |

Safety and Approvals

| | |
|---------------|--|
| United States | FCC 47CFR Part 15B Class B (DoC) UL60950-1 Second Edition (cTUVus Mark) |
| Canada | ICES-003 Class B CSA C22.2 No. 60950-1-07 |



Pixelworks™ DNX™ ICs are used in this projector.

Compatible Video Formats

This projector supports the high definition video and computer display formats listed here.

To project images output from a computer, the computer's video card must be set at a refresh rate (vertical frequency) that's compatible with the projector. Some images are automatically resized using Epson's SizeWize™ technology to display in the projector's native format. The frequencies of some computers may not allow images to display correctly; see your computer's documentation for details.

Computer, component video, composite video, and S-Video

| Mode | Refresh rate (Hz) | Resolution |
|-------------|--------------------------|-------------------|
| VGA—60 | 60 | 640 × 480 |
| VESA—72 | 72 | 640 × 480 |
| VESA—75 | 75 | 640 × 480 |
| VESA—85 | 85 | 640 × 480 |
| SVGA—56 | 56 | 800 × 600 |
| SVGA—60 | 60 | 800 × 600 |
| SVGA—72 | 72 | 800 × 600 |
| SVGA—75 | 75 | 800 × 600 |
| SVGA—85 | 85 | 800 × 600 |
| XGA—60 | 60 | 1024 × 768 |
| XGA—70 | 70 | 1024 × 768 |
| XGA—75 | 75 | 1024 × 768 |
| XGA—85 | 85 | 1024 × 768 |
| SXGA1—70 | 70 | 1152 × 864 |
| SXGA1—75 | 75 | 1152 × 864 |
| SXGA1—85 | 85 | 1152 × 864 |
| WXGA—60 | 60 | 1280 × 800 |
| WXGA—75 | 75 | 1280 × 800 |
| WXGA—85 | 85 | 1280 × 800 |
| SXGA2—60 | 60 | 1280 × 960 |
| SXGA2—75 | 75 | 1280 × 960 |
| SXGA2—85 | 85 | 1280 × 960 |
| SXGA3—60 | 60 | 1280 × 1024 |
| SXGA3—75 | 75 | 1280 × 1024 |
| SXGA3—85 | 85 | 1280 × 1024 |
| WXGA1—60 | 60 | 1280 × 768 |
| WXGA2—60 | 60 | 1360 × 768 |
| WXGA+—60 | 60 | 1440 × 900 |
| WXGA+—75 | 75 | 1440 × 900 |
| WXGA+—85 | 85 | 1440 × 900 |
| SXGA+60 | 60 | 1400 × 1050 |
| SXGA+75 | 75 | 1400 × 1050 |
| UXGA—60 | 60 | 1600 × 1200 |
| WSXGA+—60* | 60 | 1680 × 1050 |

Computer, component video, composite video, and S-Video

| Mode | Refresh rate (Hz) | Resolution |
|--------------|--------------------------|-------------------|
| MAC13 | 67 | 640 × 480 |
| MAC16 | 75 | 832 × 624 |
| MAC19 | 75 | 1024 × 768 |
| MAC19-60 | 60 | 1024 × 768 |
| MAC21 | 75 | 1152 × 870 |
| NTSC | 60 | 720 × 480 |
| NTSC 4:43 | 60 | 720 × 480 |
| PAL | 50 | 720 × 576 |
| N-PAL | 50 | 720 × 576 |
| M-PAL | 60 | 720 × 576 |
| PAL—60 | 60 | 720 × 576 |
| SECAM | 50 | 720 × 576 |
| SDTV (480i) | 60 | 720 × 480 |
| SDTV (576i) | 50 | 720 × 576 |
| SDTV (480p) | 60 | 720 × 480 |
| SDTV (576p) | 50 | 720 × 576 |
| HDTV (720p) | 60/50 | 1280 × 720 |
| HDTV (1080i) | 60/50 | 1920 × 1080 |

* Available only when you select **Wide** as the Resolution setting

B Notices

This appendix includes safety instructions and other important information about your projector.

Important Safety Instructions

Follow these safety instructions when setting up and using the projector:

- Do not look into the lens when the projector is on. The bright light can damage your eyes.
- Do not operate the projector on its side, or while tilted to one side. Do not tilt the projector forward or back at a greater angle than that specified for keystone correction (see page 144).
- The projector should be installed by qualified technicians using mounting hardware designed for use with this projector.
- If you apply adhesives to the mount to prevent the screws from loosening, or if you use lubricants or oils on the projector, the projector case may crack and the projector may fall from its mount. This could cause serious injury to anyone under the mount and could damage the projector. When installing or adjusting the mount, do not use adhesives to prevent the screws from loosening and do not use oils or lubricants.
- Do not use the projector where it may be exposed to rain, water, or excessive humidity.
- Unplug the projector from the wall outlet before cleaning. Use a dry cloth (or, for stubborn dirt or stains, a moist cloth that has been wrung dry) for cleaning. Do not use liquid or aerosol cleaners.
- Never spill liquid of any kind into the projector.
- Do not use the projector where it may be exposed to excessive dust or smoke.
- Never push objects of any kind through the cabinet slots.
- Do not use or store the projector or remote control in a hot location, such as near a heater, in direct sunlight, or in a closed vehicle.

- Do not block the slots and openings in the projector case. They provide ventilation and prevent the projector from overheating. Do not operate the projector on a sofa, rug, or other soft surface, or set it on top of loose papers, which could block vents underneath your projector. If you are setting up the projector near a wall, leave at least 7.9 inches (20 cm) of space between the wall and the air exhaust vent.
- Do not operate the projector in a closed-in cabinet unless proper ventilation is provided.
- If you are using two or more projectors side-by-side, leave at least 2 feet (60 cm) of space between the projectors to allow for proper ventilation.
- You may need to clean the air filter and vent. A clogged air filter or vent can block ventilation needed to cool the projector.
- Do not store the projector outdoors for an extended length of time.
- Do not use the projector outside the required temperature range of 41 to 95 °F (5 to 35 °C). Doing so may cause an unstable display and could lead to projector damage.
- Do not store the projector outside the required temperature range of 14 to 140 °F (-10 to 60 °C) or in direct sunlight for long periods of time. Doing so may cause damage to the case.
- Do not touch the plug during an electrical storm. Otherwise, you may receive an electric shock.
- Unplug the projector when it will not be used for extended periods.
- Unplug the projector from the wall outlet and refer servicing to qualified service personnel under the following conditions: if it does not operate normally when you follow the operating instructions, or exhibits a distinct change in performance; if smoke, strange odors, or strange noises come from the projector; if the power cord or plug is damaged or frayed; if liquid or foreign objects get inside the projector, or if it has been exposed to rain or water; if it has been dropped or the housing has been damaged.
- Except as specifically explained in this *User's Guide*, do not attempt to service this product yourself. Refer all servicing to qualified personnel. Opening or removing covers may expose you to dangerous voltages and other hazards.
- Never open any covers on the projector except as specifically explained in this *User's Guide*. Never attempt to disassemble or modify the projector. Refer all repairs to qualified service personnel.
- Use the type of power source indicated on the projector. Use of a different power source may result in fire or electric shock. If you are not sure of the power available, consult your dealer or power company.

- If you use the projector in a country other than where you purchased it, use the correct power cord for that country.
- Do not overload wall outlets, extension cords, or power strips. Do not insert the plug into a dusty outlet. This can cause fire or electric shock.
- Take the following precautions when handling the plug: Do not hold the plug with wet hands. Do not insert the plug into an outlet with dust present. Insert the plug firmly into the outlet. Do not pull the power cord when disconnecting the plug; always be sure to hold the plug when disconnecting it. Failure to comply with these precautions could result in fire or electric shock.
- Do not place the projector where the cord can be walked on.
- (Hg) The lamp(s) in this product contain mercury. Please consult your state and local regulations regarding disposal or recycling. Do not put in the trash.
- Do not place anything that can become warped or damaged by heat near the exhaust vents. Do not bring your hands or face close to the vents while projection is in progress.
- Before you move the projector, make sure its power is turned off, the plug is disconnected from the outlet, and all cables are disconnected.
- Never try to remove the lamp immediately after use because it will be extremely hot. Before removing the lamp, turn off the power and wait at least an hour to allow the lamp to cool completely.
- Do not place the source of an open flame, such as a lit candle, on or near the projector.
- Do not modify the power cord. Do not place heavy objects on top of the power cord or bend, twist, or pull it excessively. Keep the power cord away from hot electrical appliances.
- If the lamp breaks, ventilate the room to prevent gases contained in the lamp from being inhaled or coming in contact with the eyes or mouth.
- If the projector is mounted overhead and the lamp breaks, be careful to prevent pieces of glass from falling into your eyes when you open the lamp cover.

WARNING: The cords included with this product contain chemicals, including lead, known to the State of California to cause birth defects or other reproductive harm. *Wash hands after handling.* (This notice is provided in accordance with Proposition 65 in Cal. Health & Safety Code §25249.5 and following.)

FCC Compliance Statement

For United States Users

This equipment has been tested and found to comply with the limits for a Class B digital device, pursuant to Part 15 of the FCC Rules. These limits are designed to provide reasonable protection against harmful interference in a residential installation. This equipment generates, uses, and can radiate radio frequency energy and, if not installed and used in accordance with the instructions, may cause harmful interference to radio or television reception. However, there is no guarantee that interference will not occur in a particular installation. If this equipment does cause interference to radio and television reception, which can be determined by turning the equipment off and on, the user is encouraged to try to correct the interference by one or more of the following measures:

- Reorient or relocate the receiving antenna.
- Increase the separation between the equipment and receiver.
- Connect the equipment into an outlet on a circuit different from that to which the receiver is connected.
- Consult the dealer or an experienced radio/TV technician for help.

WARNING

The connection of a non-shielded equipment interface cable to this equipment will invalidate the FCC Certification of this device and may cause interference levels which exceed the limits established by the FCC for this equipment. It is the responsibility of the user to obtain and use a shielded equipment interface cable with this device. If this equipment has more than one interface connector, do not leave cables connected to unused interfaces. Changes or modifications not expressly approved by the manufacturer could void the user's authority to operate the equipment.

For Canadian Users

This Class B digital apparatus meets all requirements of the Canadian Interference-Causing Equipment Regulations.

Cet appareil numérique de la classe B respecte toutes les exigences du Règlement sur le matériel brouilleur du Canada.

Software Notices

GNU GPL

This projector product includes the open source software programs which apply the GNU General Public License Version 2 or later version ("GPL Programs").

We provide the source code of the GPL Programs until five (5) years after the discontinuation of same model of this projector product.

If you desire to receive the source code of the GPL Programs, please contact the customer support of your region.

These GPL Programs are WITHOUT ANY WARRANTY; without even the implied warranty of MERCHANTABILITY AND FITNESS FOR A PARTICULAR PURPOSE. See the GNU General Public License for more details.

The list of GPL Programs is as follows and the names of author are described in the source code of the GPL Programs

The list of GPL Programs

busybox-1.7.2

libgcc1(gcc-4.2.3)

linux-2.6.20

patches

udhcp 0.9.8

uvc rev.219

wireless_tools 29

Pixelworks PWC950 SDK drivers

The GNU General Public License Version 2 is as follows. You also can see the GNU General Public License Version 2 at <http://www.gnu.org/licenses/>.

GNU GENERAL PUBLIC LICENSE

Version 2, June 1991

Copyright (C) 1989, 1991 Free Software Foundation, Inc., 51 Franklin Street, Fifth Floor, Boston, MA 02110-1301 USA Everyone is permitted to copy and distribute verbatim copies of this license document, but changing it is not allowed.

Preamble

The licenses for most software are designed to take away your freedom to share and change it. By contrast, the GNU General Public License is intended to guarantee your freedom to share and change free software—to make sure the software is free for all its users. This General Public License applies to most of the Free Software Foundation's software and to any other program whose authors commit to using it. (Some other Free Software Foundation software is covered by the GNU Lesser General Public License instead.) You can apply it to your programs, too.

When we speak of free software, we are referring to freedom, not price. Our General Public Licenses are designed to make sure that you have the freedom to distribute copies of free software (and charge for this service if you wish), that you receive source code or can get it if you want it, that you can change the software or use pieces of it in new free programs; and that you know you can do these things.

To protect your rights, we need to make restrictions that forbid anyone to deny you these rights or to ask you to surrender the rights. These restrictions translate to certain responsibilities for you if you distribute copies of the software, or if you modify it.

For example, if you distribute copies of such a program, whether gratis or for a fee, you must give the recipients all the rights that you have. You must make sure that they, too, receive or can get the source code. And you must show them these terms so they know their rights.

We protect your rights with two steps: (1) copyright the software, and (2) offer you this license which gives you legal permission to copy, distribute and/or modify the software.

Also, for each author's protection and ours, we want to make certain that everyone understands that there is no warranty for this free software. If the software is modified by someone else and passed on, we want its recipients to know that what they have is not the original, so that any problems introduced by others will not reflect on the original authors' reputations.

Finally, any free program is threatened constantly by software patents. We wish to avoid the danger that redistributors of a free program will individually obtain patent licenses, in effect making the program proprietary. To prevent this, we have made it clear that any patent must be licensed for everyone's free use or not licensed at all.

The precise terms and conditions for copying, distribution and modification follow.

GNU GENERAL PUBLIC LICENSE TERMS AND CONDITIONS FOR COPYING, DISTRIBUTION AND MODIFICATION

0. This License applies to any program or other work which contains a notice placed by the copyright holder saying it may be distributed under the terms of this General Public License. The "Program", below, refers to any such program or work, and a "work based on the Program" means either the Program or any derivative work under copyright law: that is to say, a work containing the Program or a portion of it, either verbatim or with modifications and/or translated into another language. (Hereinafter, translation is included without limitation in the term "modification".) Each licensee is addressed as "you".

Activities other than copying, distribution and modification are not covered by this License; they are outside its scope. The act of running the Program is not restricted, and the output from the Program is covered only if its contents constitute a work based on the Program (independent of having been made by running the Program). Whether that is true depends on what the Program does.

1. You may copy and distribute verbatim copies of the Program's source code as you receive it, in any medium, provided that you conspicuously and appropriately publish on each copy an appropriate copyright notice and disclaimer of warranty; keep intact all the notices that refer to this License and to the absence of any warranty; and give any other recipients of the Program a copy of this License along with the Program.

You may charge a fee for the physical act of transferring a copy, and you may at your option offer warranty protection in exchange for a fee.

2. You may modify your copy or copies of the Program or any portion of it, thus forming a work based on the Program, and copy and distribute such modifications or work under the terms of Section 1 above, provided that you also meet all of these conditions:
 - a) You must cause the modified files to carry prominent notices stating that you changed the files and the date of any change.
 - b) You must cause any work that you distribute or publish, that in whole or in part contains or is derived from the Program or any part thereof, to be licensed as a whole at no charge to all third parties under the terms of this License.
 - c) If the modified program normally reads commands interactively when run, you must cause it, when started running for such interactive use in the most ordinary way, to print or display an announcement including an appropriate copyright notice and a notice that there is no warranty (or else, saying that you provide a warranty) and that users may redistribute the program under these conditions, and telling the user how to view a copy of this License. (Exception: if the Program itself is interactive but does not normally print such an announcement, your work based on the Program is not required to print an announcement.)

These requirements apply to the modified work as a whole. If identifiable sections of that work are not derived from the Program, and can be reasonably considered independent and separate works in themselves, then this License, and its terms, do not apply to those sections when you distribute them as separate works. But when you distribute the same sections as part of a whole which is a work based on the Program, the distribution of the whole must be on the terms of this License, whose permissions for other licensees extend to the entire whole, and thus to each and every part regardless of who wrote it.

Thus, it is not the intent of this section to claim rights or contest your rights to work written entirely by you; rather, the intent is to exercise the right to control the distribution of derivative or collective works based on the Program.

In addition, mere aggregation of another work not based on the Program with the Program (or with a work based on the Program) on a volume of a storage or distribution medium does not bring the other work under the scope of this License.

3. You may copy and distribute the Program (or a work based on it, under Section 2) in object code or executable form under the terms of Sections 1 and 2 above provided that you also do one of the following:

- a) Accompany it with the complete corresponding machine-readable source code, which must be distributed under the terms of Sections 1 and 2 above on a medium customarily used for software interchange; or,
- b) Accompany it with a written offer, valid for at least three years, to give any third party, for a charge no more than your cost of physically performing source distribution, a complete machine-readable copy of the corresponding source code, to be distributed under the terms of Sections 1 and 2 above on a medium customarily used for software interchange; or,
- c) Accompany it with the information you received as to the offer to distribute corresponding source code. (This alternative is allowed only for noncommercial distribution and only if you received the program in object code or executable form with such an offer, in accord with Subsection b above.)

The source code for a work means the preferred form of the work for making modifications to it. For an executable work, complete source code means all the source code for all modules it contains, plus any associated interface definition files, plus the scripts used to control compilation and installation of the executable. However, as a special exception, the source code distributed need not include anything that is normally distributed (in either source or binary form) with the major components (compiler, kernel, and so on) of the operating system on which the executable runs, unless that component itself accompanies the executable.

If distribution of executable or object code is made by offering access to copy from a designated place, then offering equivalent access to copy the source code from the same place counts as distribution of the source code, even though third parties are not compelled to copy the source along with the object code.

- 4. You may not copy, modify, sublicense, or distribute the Program except as expressly provided under this License. Any attempt otherwise to copy, modify, sublicense or distribute the Program is void, and will automatically terminate your rights under this License. However, parties who have received copies, or rights, from you under this License will not have their licenses terminated so long as such parties remain in full compliance.
- 5. You are not required to accept this License, since you have not signed it. However, nothing else grants you permission to modify or distribute the Program or its derivative works. These actions are prohibited by law if you do not accept this License. Therefore, by modifying or distributing the Program (or any work based on the Program), you indicate your acceptance of this License to do so, and all its terms and conditions for copying, distributing or modifying the Program or works based on it.
- 6. Each time you redistribute the Program (or any work based on the Program), the recipient automatically receives a license from the original licensor to copy, distribute or modify the Program subject to these terms and conditions. You may not impose any further restrictions on the recipients' exercise of the rights granted herein. You are not responsible for enforcing compliance by third parties to this License.

7. If, as a consequence of a court judgment or allegation of patent infringement or for any other reason (not limited to patent issues), conditions are imposed on you (whether by court order, agreement or otherwise) that contradict the conditions of this License, they do not excuse you from the conditions of this License. If you cannot distribute so as to satisfy simultaneously your obligations under this License and any other pertinent obligations, then as a consequence you may not distribute the Program at all. For example, if a patent license would not permit royalty-free redistribution of the Program by all those who receive copies directly or indirectly through you, then the only way you could satisfy both it and this License would be to refrain entirely from distribution of the Program.

If any portion of this section is held invalid or unenforceable under any particular circumstance, the balance of the section is intended to apply and the section as a whole is intended to apply in other circumstances.

It is not the purpose of this section to induce you to infringe any patents or other property right claims or to contest validity of any such claims; this section has the sole purpose of protecting the integrity of the free software distribution system, which is implemented by public license practices. Many people have made generous contributions to the wide range of software distributed through that system in reliance on consistent application of that system; it is up to the author/donor to decide if he or she is willing to distribute software through any other system and a licensee cannot impose that choice.

This section is intended to make thoroughly clear what is believed to be a consequence of the rest of this License.

8. If the distribution and/or use of the Program is restricted in certain countries either by patents or by copyrighted interfaces, the original copyright holder who places the Program under this License may add an explicit geographical distribution limitation excluding those countries, so that distribution is permitted only in or among countries not thus excluded. In such case, this License incorporates the limitation as if written in the body of this License.
9. The Free Software Foundation may publish revised and/or new versions of the General Public License from time to time. Such new versions will be similar in spirit to the present version, but may differ in detail to address new problems or concerns.

Each version is given a distinguishing version number. If the Program specifies a version number of this License which applies to it and "any later version", you have the option of following the terms and conditions either of that version or of any later version published by the Free Software Foundation. If the Program does not specify a version number of this License, you may choose any version ever published by the Free Software Foundation.

10. If you wish to incorporate parts of the Program into other free programs whose distribution conditions are different, write to the author to ask for permission. For software which is copyrighted by the Free Software Foundation, write to the Free Software Foundation; we sometimes make exceptions for this. Our decision will be guided by the two goals of preserving the free status of all derivatives of our free software and of promoting the sharing and reuse of software generally.

NO WARRANTY

11. BECAUSE THE PROGRAM IS LICENSED FREE OF CHARGE, THERE IS NO WARRANTY FOR THE PROGRAM, TO THE EXTENT PERMITTED BY APPLICABLE LAW. EXCEPT WHEN OTHERWISE STATED IN WRITING THE COPYRIGHT HOLDERS AND/OR OTHER PARTIES PROVIDE THE PROGRAM "AS IS" WITHOUT WARRANTY OF ANY KIND, EITHER EXPRESSED OR IMPLIED, INCLUDING, BUT NOT LIMITED TO, THE IMPLIED WARRANTIES OF MERCHANTABILITY AND FITNESS FOR A PARTICULAR PURPOSE. THE ENTIRE RISK AS TO THE QUALITY AND PERFORMANCE OF THE PROGRAM IS WITH YOU. SHOULD THE PROGRAM PROVE DEFECTIVE, YOU ASSUME THE COST OF ALL NECESSARY SERVICING, REPAIR OR CORRECTION.
12. IN NO EVENT UNLESS REQUIRED BY APPLICABLE LAW OR AGREED TO IN WRITING WILL ANY COPYRIGHT HOLDER, OR ANY OTHER PARTY WHO MAY MODIFY AND/OR REDISTRIBUTE THE PROGRAM AS PERMITTED ABOVE, BE LIABLE TO YOU FOR DAMAGES, INCLUDING ANY GENERAL, SPECIAL, INCIDENTAL OR CONSEQUENTIAL DAMAGES ARISING OUT OF THE USE OR INABILITY TO USE THE PROGRAM (INCLUDING BUT NOT LIMITED TO LOSS OF DATA OR DATA BEING RENDERED INACCURATE OR LOSSES SUSTAINED BY YOU OR THIRD PARTIES OR A FAILURE OF THE PROGRAM TO OPERATE WITH ANY OTHER PROGRAMS), EVEN IF SUCH HOLDER OR OTHER PARTY HAS BEEN ADVISED OF THE POSSIBILITY OF SUCH DAMAGES.

END OF TERMS AND CONDITIONS

How to Apply These Terms to Your New Programs

If you develop a new program, and you want it to be of the greatest possible use to the public, the best way to achieve this is to make it free software which everyone can redistribute and change under these terms.

To do so, attach the following notices to the program. It is safest to attach them to the start of each source file to most effectively convey the exclusion of warranty; and each file should have at least the "copyright" line and a pointer to where the full notice is found.

<one line to give the program's name and a brief idea of what it does.>

Copyright (C) <year> <name of author>

This program is free software; you can redistribute it and/or modify it under the terms of the GNU General Public License as published by the Free Software Foundation; either version 2 of the License, or (at your option) any later version.

This program is distributed in the hope that it will be useful, but WITHOUT ANY WARRANTY; without even the implied warranty of MERCHANTABILITY or FITNESS FOR A PARTICULAR PURPOSE. See the GNU General Public License for more details.

You should have received a copy of the GNU General Public License along with this program; if not, write to the Free Software Foundation, Inc., 51 Franklin Street, Fifth Floor, Boston, MA 02110-1301 USA.

Also add information on how to contact you by electronic and paper mail.

If the program is interactive, make it output a short notice like this when it starts in an interactive mode:

```
Gnomovision version 69, Copyright (C) year name of author Gnomovision comes
with ABSOLUTELY NO WARRANTY; for details type `show w'. This is free
software, and you are welcome to redistribute it under certain conditions; type
`show c' for details.
```

The hypothetical commands ``show w'` and ``show c'` should show the appropriate parts of the General Public License. Of course, the commands you use may be called something other than ``show w'` and ``show c'`; they could even be mouse-clicks or menu items—whatever suits your program.

You should also get your employer (if you work as a programmer) or your school, if any, to sign a "copyright disclaimer" for the program, if necessary. Here is a sample; alter the names:

```
Yoyodyne, Inc., hereby disclaims all copyright interest in the program
`Gnomovision' (which makes passes at compilers) written by James Hacker.

<signature of Ty Coon>, 1 April 1989
Ty Coon, President of Vice
```

This General Public License does not permit incorporating your program into proprietary programs. If your program is a subroutine library, you may consider it more useful to permit linking proprietary applications with the library. If this is what you want to do, use the GNU Lesser General Public License instead of this License.

GNU LGPL

This projector product includes the open source software programs which apply the GNU Lesser General Public License Version 2 or later version ("LGPL Programs"). We provide the source code of the LGPL Programs until five (5) years after the discontinuation of same model of this projector product.

If you desire to receive the source code of the LGPL Programs, please contact the customer support of your region.

These LGPL Programs are WITHOUT ANY WARRANTY; without even the implied warranty of MERCHANTABILITY AND FITNESS FOR A PARTICULAR PURPOSE. See the GNU General Public License for more details.

The list of LGPL Programs is as follows and the names of author are described in the source code of the LGPL Programs.

LGPL Programs

uClibc-0.9.29

SDL-1.2.13

The GNU Lesser General Public License Version 2 is as follows. You also can see the GNU Lesser General Public License Version 2 at <http://www.gnu.org/licenses/>.

GNU LESSER GENERAL PUBLIC LICENSE

Version 2.1, February 1999

Copyright (C) 1991, 1999 Free Software Foundation, Inc. 51 Franklin Street, Fifth Floor, Boston, MA 02110-1301 USA Everyone is permitted to copy and distribute verbatim copies of this license document, but changing it is not allowed.

[This is the first released version of the Lesser GPL. It also counts as the successor of the GNU Library Public License, version 2, hence the version number 2.1.]

Preamble

The licenses for most software are designed to take away your freedom to share and change it. By contrast, the GNU General Public Licenses are intended to guarantee your freedom to share and change free software—to make sure the software is free for all its users.

This license, the Lesser General Public License, applies to some specially designated software packages—typically libraries—of the Free Software Foundation and other authors who decide to use it. You can use it too, but we suggest you first think carefully about whether this license or the ordinary General Public License is the better strategy to use in any particular case, based on the explanations below.

When we speak of free software, we are referring to freedom of use, not price. Our General Public Licenses are designed to make sure that you have the freedom to distribute copies of free software (and charge for this service if you wish); that you receive source code or can get it if you want it; that you can change the software and use pieces of it in new free programs; and that you are informed that you can do these things.

To protect your rights, we need to make restrictions that forbid distributors to deny you these rights or to ask you to surrender these rights. These restrictions translate to certain responsibilities for you if you distribute copies of the library or if you modify it.

For example, if you distribute copies of the library, whether gratis or for a fee, you must give the recipients all the rights that we gave you. You must make sure that they, too, receive or can get the source code. If you link other code with the library, you must provide complete object files to the recipients, so that they can relink them with the library after making changes to the library and recompiling it. And you must show them these terms so they know their rights.

We protect your rights with a two-step method: (1) we copyright the library, and (2) we offer you this license, which gives you legal permission to copy, distribute and/or modify the library.

To protect each distributor, we want to make it very clear that there is no warranty for the free library. Also, if the library is modified by someone else and passed on, the recipients should know that what they have is not the original version, so that the original author's reputation will not be affected by problems that might be introduced by others.

Finally, software patents pose a constant threat to the existence of any free program. We wish to make sure that a company cannot effectively restrict the users of a free program by obtaining a restrictive license from a patent holder. Therefore, we insist that any patent license obtained for a version of the library must be consistent with the full freedom of use specified in this license.

Most GNU software, including some libraries, is covered by the ordinary GNU General Public License. This license, the GNU Lesser General Public License, applies to certain designated libraries, and is quite different from the ordinary General Public License. We use this license for certain libraries in order to permit linking those libraries into non-free programs.

When a program is linked with a library, whether statically or using a shared library, the combination of the two is legally speaking a combined work, a derivative of the original library. The ordinary General Public License therefore permits such linking only if the entire combination fits its criteria of freedom. The Lesser General Public License permits more lax criteria for linking other code with the library.

We call this license the "Lesser" General Public License because it does Less to protect the user's freedom than the ordinary General Public License. It also provides other free software developers Less of an advantage over competing non-free programs. These disadvantages are the reason we use the ordinary General Public License for many libraries. However, the Lesser license provides advantages in certain special circumstances.

For example, on rare occasions, there may be a special need to encourage the widest possible use of a certain library, so that it becomes a de-facto standard. To achieve this, non-free programs must be allowed to use the library. A more frequent case is that a free library does the same job as widely used non-free libraries. In this case, there is little to gain by limiting the free library to free software only, so we use the Lesser General Public License.

In other cases, permission to use a particular library in non-free programs enables a greater number of people to use a large body of free software. For example, permission to use the GNU C Library in non-free programs enables many more people to use the whole GNU operating system, as well as its variant, the GNU/Linux operating system.

Although the Lesser General Public License is Less protective of the users' freedom, it does ensure that the user of a program that is linked with the Library has the freedom and the wherewithal to run that program using a modified version of the Library.

The precise terms and conditions for copying, distribution and modification follow. Pay close attention to the difference between a "work based on the library" and a "work that uses the library". The former contains code derived from the library, whereas the latter must be combined with the library in order to run.

GNU LESSER GENERAL PUBLIC LICENSE TERMS AND CONDITIONS FOR COPYING, DISTRIBUTION AND MODIFICATION

0. This License Agreement applies to any software library or other program which contains a notice placed by the copyright holder or other authorized party saying it may be distributed under the terms of this Lesser General Public License (also called "this License"). Each licensee is addressed as "you".

A "library" means a collection of software functions and/or data prepared so as to be conveniently linked with application programs (which use some of those functions and data) to form executables.

The "Library", below, refers to any such software library or work which has been distributed under these terms. A "work based on the Library" means either the Library or any derivative work under copyright law: that is to say, a work containing the Library or a portion of it, either verbatim or with modifications and/or translated straightforwardly into another language. (Hereinafter, translation is included without limitation in the term "modification".)

"Source code" for a work means the preferred form of the work for making modifications to it. For a library, complete source code means all the source code for all modules it contains, plus any associated interface definition files, plus the scripts used to control compilation and installation of the library.

Activities other than copying, distribution and modification are not covered by this License; they are outside its scope. The act of running a program using the Library is not restricted, and output from such a program is covered only if its contents constitute a work based on the Library (independent of the use of the Library in a tool for writing it). Whether that is true depends on what the Library does and what the program that uses the Library does.

1. You may copy and distribute verbatim copies of the Library's complete source code as you receive it, in any medium, provided that you conspicuously and appropriately publish on each copy an appropriate copyright notice and disclaimer of warranty; keep intact all the notices that refer to this License and to the absence of any warranty; and distribute a copy of this License along with the Library.

You may charge a fee for the physical act of transferring a copy, and you may at your option offer warranty protection in exchange for a fee.

2. You may modify your copy or copies of the Library or any portion of it, thus forming a work based on the Library, and copy and distribute such modifications or work under the terms of Section 1 above, provided that you also meet all of these conditions:
 - a) The modified work must itself be a software library.
 - b) You must cause the files modified to carry prominent notices stating that you changed the files and the date of any change.
 - c) You must cause the whole of the work to be licensed at no charge to all third parties under the terms of this License.
 - d) If a facility in the modified Library refers to a function or a table of data to be supplied by an application program that uses the facility, other than as an argument passed when the facility is invoked, then you must make a good faith effort to ensure that, in the event an application does not supply such function or table, the facility still operates, and performs whatever part of its purpose remains meaningful.

(For example, a function in a library to compute square roots has a purpose that is entirely well-defined independent of the application. Therefore, Subsection 2d requires that any application-supplied function or table used by this function must be optional: if the application does not supply it, the square root function must still compute square roots.)

These requirements apply to the modified work as a whole. If identifiable sections of that work are not derived from the Library, and can be reasonably considered independent and separate works in themselves, then this License, and its terms, do not apply to those sections when you distribute them as separate works. But when you distribute the same sections as part of a whole which is a work based on the Library, the distribution of the whole must be on the terms of this License, whose permissions for other licensees extend to the entire whole, and thus to each and every part regardless of who wrote it.

Thus, it is not the intent of this section to claim rights or contest your rights to work written entirely by you; rather, the intent is to exercise the right to control the distribution of derivative or collective works based on the Library.

In addition, mere aggregation of another work not based on the Library with the Library (or with a work based on the Library) on a volume of a storage or distribution medium does not bring the other work under the scope of this License.

3. You may opt to apply the terms of the ordinary GNU General Public License instead of this License to a given copy of the Library. To do this, you must alter all the notices that refer to this License, so that they refer to the ordinary GNU General Public License, version 2, instead of to this License. (If a newer version than version 2 of the ordinary GNU General Public License has appeared, then you can specify that version instead if you wish.) Do not make any other change in these notices.

Once this change is made in a given copy, it is irreversible for that copy, so the ordinary GNU General Public License applies to all subsequent copies and derivative works made from that copy.

This option is useful when you wish to copy part of the code of the Library into a program that is not a library.

4. You may copy and distribute the Library (or a portion or derivative of it, under Section 2) in object code or executable form under the terms of Sections 1 and 2 above provided that you accompany it with the complete corresponding machine-readable source code, which must be distributed under the terms of Sections 1 and 2 above on a medium customarily used for software interchange.

If distribution of object code is made by offering access to copy from a designated place, then offering equivalent access to copy the source code from the same place satisfies the requirement to distribute the source code, even though third parties are not compelled to copy the source along with the object code.

5. A program that contains no derivative of any portion of the Library, but is designed to work with the Library by being compiled or linked with it, is called a "work that uses the Library". Such a work, in isolation, is not a derivative work of the Library, and therefore falls outside the scope of this License.

However, linking a "work that uses the Library" with the Library creates an executable that is a derivative of the Library (because it contains portions of the Library), rather than a "work that uses the library". The executable is therefore covered by this License. Section 6 states terms for distribution of such executables.

When a "work that uses the Library" uses material from a header file that is part of the Library, the object code for the work may be a derivative work of the Library even though the source code is not. Whether this is true is especially significant if the work can be linked without the Library, or if the work is itself a library. The threshold for this to be true is not precisely defined by law.

If such an object file uses only numerical parameters, data structure layouts and accessors, and small macros and small inline functions (ten lines or less in length), then the use of the object file is unrestricted, regardless of whether it is legally a derivative work. (Executables containing this object code plus portions of the Library will still fall under Section 6.)

Otherwise, if the work is a derivative of the Library, you may distribute the object code for the work under the terms of Section 6. Any executables containing that work also fall under Section 6, whether or not they are linked directly with the Library itself.

6. As an exception to the Sections above, you may also combine or link a "work that uses the Library" with the Library to produce a work containing portions of the Library, and distribute that work under terms of your choice, provided that the terms permit modification of the work for the customer's own use and reverse engineering for debugging such modifications.

You must give prominent notice with each copy of the work that the Library is used in it and that the Library and its use are covered by this License. You must supply a copy of this License. If the work during execution displays copyright notices, you must include the copyright notice for the Library among them, as well as a reference directing the user to the copy of this License. Also, you must do one of these things:

- a) Accompany the work with the complete corresponding machine-readable source code for the Library including whatever changes were used in the work (which must be distributed under Sections 1 and 2 above); and, if the work is an executable linked with the Library, with the complete machine-readable "work that uses the Library", as object code and/or source code, so that the user can modify the Library and then relink to produce a modified executable containing the modified Library. (It is understood that the user who changes the contents of definitions files in the Library will not necessarily be able to recompile the application to use the modified definitions.)
- b) Use a suitable shared library mechanism for linking with the Library. A suitable mechanism is one that (1) uses at run time a copy of the library already present on the user's computer system, rather than copying library functions into the executable, and (2) will operate properly with a modified version of the library, if the user installs one, as long as the modified version is interface-compatible with the version that the work was made with.
- c) Accompany the work with a written offer, valid for at least three years, to give the same user the materials specified in Subsection 6a, above, for a charge no more than the cost of performing this distribution.
- d) If distribution of the work is made by offering access to copy from a designated place, offer equivalent access to copy the above specified materials from the same place.
- e) Verify that the user has already received a copy of these materials or that you have already sent this user a copy.

For an executable, the required form of the "work that uses the Library" must include any data and utility programs needed for reproducing the executable from it. However, as a special exception, the materials to be distributed need not include anything that is normally distributed (in either source or binary form) with the major components (compiler, kernel, and so on) of the operating system on which the executable runs, unless that component itself accompanies the executable.

It may happen that this requirement contradicts the license restrictions of other proprietary libraries that do not normally accompany the operating system. Such a contradiction means you cannot use both them and the Library together in an executable that you distribute.

7. You may place library facilities that are a work based on the Library side-by-side in a single library together with other library facilities not covered by this License, and distribute such a combined library, provided that the separate distribution of the work based on the Library and of the other library facilities is otherwise permitted, and provided that you do these two things:
 - a) Accompany the combined library with a copy of the same work based on the Library, uncombined with any other library facilities. This must be distributed under the terms of the Sections above.
 - b) Give prominent notice with the combined library of the fact that part of it is a work based on the Library, and explaining where to find the accompanying uncombined form of the same work.
8. You may not copy, modify, sublicense, link with, or distribute the Library except as expressly provided under this License. Any attempt otherwise to copy, modify, sublicense, link with, or distribute the Library is void, and will automatically terminate your rights under this License. However, parties who have received copies, or rights, from you under this License will not have their licenses terminated so long as such parties remain in full compliance.
9. You are not required to accept this License, since you have not signed it. However, nothing else grants you permission to modify or distribute the Library or its derivative works. These actions are prohibited by law if you do not accept this License. Therefore, by modifying or distributing the Library (or any work based on the Library), you indicate your acceptance of this License to do so, and all its terms and conditions for copying, distributing or modifying the Library or works based on it.
10. Each time you redistribute the Library (or any work based on the Library), the recipient automatically receives a license from the original licensor to copy, distribute, link with or modify the Library subject to these terms and conditions. You may not impose any further restrictions on the recipients' exercise of the rights granted herein. You are not responsible for enforcing compliance by third parties with this License.
11. If, as a consequence of a court judgment or allegation of patent infringement or for any other reason (not limited to patent issues), conditions are imposed on you (whether by court order, agreement or otherwise) that contradict the conditions of this License, they do not excuse you from the conditions of this License. If you cannot distribute so as to satisfy simultaneously your obligations under this License and any other pertinent obligations, then as a consequence you may not distribute the Library at all. For example, if a patent license would not permit royalty-free redistribution of the Library by all those who receive copies directly or indirectly through you, then the only way you could satisfy both it and this License would be to refrain entirely from distribution of the Library.

If any portion of this section is held invalid or unenforceable under any particular circumstance, the balance of the section is intended to apply, and the section as a whole is intended to apply in other circumstances.

It is not the purpose of this section to induce you to infringe any patents or other property right claims or to contest validity of any such claims; this section has the sole purpose of protecting the integrity of the free software distribution system which is implemented by public license practices. Many people have made generous contributions to the wide range of software distributed through that system in reliance on consistent application of that system; it is up to the author/donor to decide if he or she is willing to distribute software through any other system and a licensee cannot impose that choice.

This section is intended to make thoroughly clear what is believed to be a consequence of the rest of this License.

12. If the distribution and/or use of the Library is restricted in certain countries either by patents or by copyrighted interfaces, the original copyright holder who places the Library under this License may add an explicit geographical distribution limitation excluding those countries, so that distribution is permitted only in or among countries not thus excluded. In such case, this License incorporates the limitation as if written in the body of this License.
13. The Free Software Foundation may publish revised and/or new versions of the Lesser General Public License from time to time. Such new versions will be similar in spirit to the present version, but may differ in detail to address new problems or concerns.

Each version is given a distinguishing version number. If the Library specifies a version number of this License which applies to it and "any later version", you have the option of following the terms and conditions either of that version or of any later version published by the Free Software Foundation. If the Library does not specify a license version number, you may choose any version ever published by the Free Software Foundation.

14. If you wish to incorporate parts of the Library into other free programs whose distribution conditions are incompatible with these, write to the author to ask for permission. For software which is copyrighted by the Free Software Foundation, write to the Free Software Foundation; we sometimes make exceptions for this. Our decision will be guided by the two goals of preserving the free status of all derivatives of our free software and of promoting the sharing and reuse of software generally.

NO WARRANTY

15. BECAUSE THE LIBRARY IS LICENSED FREE OF CHARGE, THERE IS NO WARRANTY FOR THE LIBRARY, TO THE EXTENT PERMITTED BY APPLICABLE LAW. EXCEPT WHEN OTHERWISE STATED IN WRITING THE COPYRIGHT HOLDERS AND/OR OTHER PARTIES PROVIDE THE LIBRARY "AS IS" WITHOUT WARRANTY OF ANY KIND, EITHER EXPRESSED OR IMPLIED, INCLUDING, BUT NOT LIMITED TO, THE IMPLIED WARRANTIES OF MERCHANTABILITY AND FITNESS FOR A PARTICULAR PURPOSE. THE ENTIRE RISK AS TO THE QUALITY AND PERFORMANCE OF THE LIBRARY IS WITH YOU. SHOULD THE LIBRARY PROVE DEFECTIVE, YOU ASSUME THE COST OF ALL NECESSARY SERVICING, REPAIR OR CORRECTION.
16. IN NO EVENT UNLESS REQUIRED BY APPLICABLE LAW OR AGREED TO IN WRITING WILL ANY COPYRIGHT HOLDER, OR ANY OTHER PARTY WHO MAY MODIFY AND/OR REDISTRIBUTE THE LIBRARY AS PERMITTED ABOVE, BE LIABLE TO YOU FOR DAMAGES, INCLUDING ANY GENERAL, SPECIAL, INCIDENTAL OR CONSEQUENTIAL DAMAGES ARISING OUT OF THE USE OR INABILITY TO USE THE LIBRARY (INCLUDING BUT NOT LIMITED TO LOSS OF DATA OR DATA BEING RENDERED INACCURATE OR LOSSES SUSTAINED BY YOU OR THIRD PARTIES OR A FAILURE OF THE LIBRARY TO OPERATE WITH ANY OTHER SOFTWARE), EVEN IF SUCH HOLDER OR OTHER PARTY HAS BEEN ADVISED OF THE POSSIBILITY OF SUCH DAMAGES.

END OF TERMS AND CONDITIONS

How to Apply These Terms to Your New Libraries

If you develop a new library, and you want it to be of the greatest possible use to the public, we recommend making it free software that everyone can redistribute and change. You can do so by permitting redistribution under these terms (or, alternatively, under the terms of the ordinary General Public License).

To apply these terms, attach the following notices to the library. It is safest to attach them to the start of each source file to most effectively convey the exclusion of warranty; and each file should have at least the "copyright" line and a pointer to where the full notice is found.

<one line to give the library's name and a brief idea of what it does.>

Copyright (C) <year> <name of author>

This library is free software; you can redistribute it and/or modify it under the terms of the GNU Lesser General Public License as published by the Free Software Foundation; either version 2.1 of the License, or (at your option) any later version.

This library is distributed in the hope that it will be useful, but WITHOUT ANY WARRANTY; without even the implied warranty of MERCHANTABILITY or FITNESS FOR A PARTICULAR PURPOSE. See the GNU Lesser General Public License for more details.

You should have received a copy of the GNU Lesser General Public License along with this library; if not, write to the Free Software Foundation, Inc., 51 Franklin Street, Fifth Floor, Boston, MA 02110-1301 USA

Also add information on how to contact you by electronic and paper mail.

You should also get your employer (if you work as a programmer) or your school, if any, to sign a "copyright disclaimer" for the library, if necessary. Here is a sample; alter the names:

Yoyodyne, Inc., hereby disclaims all copyright interest in the library `Frob' (a library for tweaking knobs) written by James Random Hacker.

<signature of Ty Coon>, 1 April 1990

Ty Coon, President of Vice

That's all there is to it!

BSD License (Berkeley Software Distribution License)

This projector product includes the open source software program "University of California, Berkeley License (Berkeley Software Distribution License)" which applies the terms and conditions provided by owner of the copyright to the "BSD License".

The "BSD License" are WITHOUT ANY WARRANTY; without even the implied warranty of MERCHANTABILITY AND FITNESS FOR A PARTICULAR PURPOSE.

List of BSD License programs

busybox_1.7.2

License terms of conditions of each program which are provided by owner of the copyright to the "BSD License" are as follows.

Copyright (c) The Regents of the University of California. All rights reserved.

This code is derived from software contributed to Berkeley by Kenneth Almquist.

Redistribution and use in source and binary forms, with or without modification, are permitted provided that the following conditions are met:

1. Redistributions of source code must retain the above copyright notice, this list of conditions and the following disclaimer.
2. Redistributions in binary form must reproduce the above copyright notice, this list of conditions and the following disclaimer in the documentation and/or other materials provided with the distribution.
3. Neither the name of the University nor the names of its contributors may be used to endorse or promote products derived from this software without specific prior written permission.

THIS SOFTWARE IS PROVIDED BY THE REGENTS AND CONTRIBUTORS ``AS IS'' AND ANY EXPRESS OR IMPLIED WARRANTIES, INCLUDING, BUT NOT LIMITED TO, THE IMPLIED WARRANTIES OF MERCHANTABILITY AND FITNESS FOR A PARTICULAR PURPOSE ARE DISCLAIMED. IN NO EVENT SHALL THE REGENTS OR CONTRIBUTORS BE LIABLE FOR ANY DIRECT, INDIRECT, INCIDENTAL, SPECIAL, EXEMPLARY, OR CONSEQUENTIAL DAMAGES (INCLUDING, BUT NOT LIMITED TO, PROCUREMENT OF SUBSTITUTE GOODS OR SERVICES; LOSS OF USE, DATA, OR PROFITS; OR BUSINESS INTERRUPTION) HOWEVER CAUSED AND ON ANY THEORY OF LIABILITY, WHETHER IN CONTRACT, STRICT LIABILITY, OR TORT (INCLUDING NEGLIGENCE OR OTHERWISE) ARISING IN ANY WAY OUT OF THE USE OF THIS SOFTWARE, EVEN IF ADVISED OF THE POSSIBILITY OF SUCH DAMAGE.

libjpeg

This projector product includes the open source software program "libjpeg" which applies the terms and conditions provided by owner of the copyright to the "libjpeg".

The "libjpeg" are WITHOUT ANY WARRANTY; without even the implied warranty of MERCHANTABILITY AND FITNESS FOR A PARTICULAR PURPOSE.

List of libjpeg programs

libjpeg-6b

License terms of conditions of each program which are provided by owner of the copyright to the "libjpeg" are as follows.

Copyright (C) 1994-1997, Thomas G. Lane. This file is part of the Independent JPEG Group's software. For conditions of distribution and use, see the accompanying README file.

This distribution contains the sixth public release of the Independent JPEG Group's free JPEG software. You are welcome to redistribute this software and to use it for any purpose, subject to the conditions under LEGAL ISSUES, below.

LEGAL ISSUES

=====

In plain English:

1. We don't promise that this software works. (But if you find any bugs, please let us know!)
2. You can use this software for whatever you want. You don't have to pay us.
3. You may not pretend that you wrote this software. If you use it in a program, you must acknowledge somewhere in your documentation that you've used the IJG code.

In legalese:

The authors make NO WARRANTY or representation, either express or implied, with respect to this software, its quality, accuracy, merchantability, or fitness for a particular purpose. This software is provided "AS IS", and you, its user, assume the entire risk as to its quality and accuracy.

This software is copyright (C) 1991-1998, Thomas G. Lane. All Rights Reserved except as specified below.

Permission is hereby granted to use, copy, modify, and distribute this software (or portions thereof) for any purpose, without fee, subject to these conditions:

- (1) If any part of the source code for this software is distributed, then this README file must be included, with this copyright and no-warranty notice unaltered; and any additions, deletions, or changes to the original files must be clearly indicated in accompanying documentation.
- (2) If only executable code is distributed, then the accompanying documentation must state that "this software is based in part on the work of the Independent JPEG Group".
- (3) Permission for use of this software is granted only if the user accepts full responsibility for any undesirable consequences; the authors accept NO LIABILITY for damages of any kind.

These conditions apply to any software derived from or based on the IJG code, not just to the unmodified library. If you use our work, you ought to acknowledge us.

Permission is NOT granted for the use of any IJG author's name or company name in advertising or publicity relating to this software or products derived from it. This software may be referred to only as "the Independent JPEG Group's software".

We specifically permit and encourage the use of this software as the basis of commercial products, provided that all warranty or liability claims are assumed by the product vendor.

ansi2knr.c is included in this distribution by permission of L. Peter Deutsch, sole proprietor of its copyright holder, Aladdin Enterprises of Menlo Park, CA. ansi2knr.c is NOT covered by the above copyright and conditions, but instead by the usual distribution terms of the Free Software Foundation; principally, that you must include source code if you redistribute it. (See the file ansi2knr.c for full details.) However, since ansi2knr.c is not needed as part of any program generated from the IJG code, this does not limit you more than the foregoing paragraphs do.

The Unix configuration script "configure" was produced with GNU Autoconf. It is copyright by the Free Software Foundation but is freely distributable. The same holds for its supporting scripts (config.guess, config.sub, ltconfig, ltmain.sh). Another support script, install-sh, is copyright by M.I.T. but is also freely distributable.

It appears that the arithmetic coding option of the JPEG spec is covered by patents owned by IBM, AT&T, and Mitsubishi. Hence arithmetic coding cannot legally be used without obtaining one or more licenses. For this reason, support for arithmetic coding has been removed from the free JPEG software. (Since arithmetic coding provides only a marginal gain over the unpatented Huffman mode, it is unlikely that very many implementations will support it.) So far as we are aware, there are no patent restrictions on the remaining code.

The IJG distribution formerly included code to read and write GIF files. To avoid entanglement with the Unisys LZW patent, GIF reading support has been removed altogether, and the GIF writer has been simplified to produce "uncompressed GIFs". This technique does not use the LZW algorithm; the resulting GIF files are larger than usual, but are readable by all standard GIF decoders.

We are required to state that

"The Graphics Interchange Format(c) is the Copyright property of CompuServe Incorporated. GIF(sm) is a Service Mark property of CompuServe Incorporated."

libpng

This projector product includes the open source software program "libpng" which applies the terms and conditions provided by owner of the copyright to the "libpng".

The "libpng" are WITHOUT ANY WARRANTY; without even the implied warranty of MERCHANTABILITY AND FITNESS FOR A PARTICULAR PURPOSE.

List of libpng programs

libpng-1.2.7

License terms of conditions of each program which are provided by owner of the copyright to the "libpng" are as follows.

For conditions of distribution and use, see copyright notice in png.h Copyright (c) 1998-2004 Glenn Randers-Pehrson (Version 0.96 Copyright (c) 1996, 1997 Andreas Dilger) (Version 0.88 Copyright (c) 1995, 1996 Guy Eric Schalnat, Group 42, Inc.)

This copy of the libpng notices is provided for your convenience. In case of any discrepancy between this copy and the notices in the file png.h that is included in the libpng distribution, the latter shall prevail.

COPYRIGHT NOTICE, DISCLAIMER, and LICENSE:

If you modify libpng you may insert additional notices immediately following this sentence.

libpng version 1.2.6, September 12, 2004, is Copyright (c) 2004 Glenn Randers-Pehrson, and is distributed according to the same disclaimer and license as libpng-1.2.5 with the following individual added to the list of Contributing Authors

Cosmin Truta

libpng versions 1.0.7, July 1, 2000, through 1.2.5 - October 3, 2002, are Copyright (c) 2000-2002 Glenn Randers-Pehrson, and are distributed according to the same disclaimer and license as libpng-1.0.6 with the following individuals added to the list of Contributing Authors

Simon-Pierre Cadieux

Eric S. Raymond

Gilles Vollant

and with the following additions to the disclaimer:

There is no warranty against interference with your enjoyment of the library or against infringement. There is no warranty that our efforts or the library will fulfill any of your particular purposes or needs. This library is provided with all faults, and the entire risk of satisfactory quality, performance, accuracy, and effort is with the user.

libpng versions 0.97, January 1998, through 1.0.6, March 20, 2000, are Copyright (c) 1998, 1999 Glenn Randers-Pehrson, and are distributed according to the same disclaimer and license as libpng-0.96, with the following individuals added to the list of Contributing Authors:

Tom Lane
Glenn Randers-Pehrson
Willem van Schaik

libpng versions 0.89, June 1996, through 0.96, May 1997, are Copyright (c) 1996, 1997 Andreas Dilger Distributed according to the same disclaimer and license as libpng-0.88, with the following individuals added to the list of Contributing Authors:

John Bowler
Kevin BraceySam Bushell
Sam Bushell
Magnus Holmgren
Greg Roelofs
Tom Tanner

libpng versions 0.5, May 1995, through 0.88, January 1996, are Copyright (c) 1995, 1996 Guy Eric Schalnat, Group 42, Inc.

For the purposes of this copyright and license, "Contributing Authors" is defined as the following set of individuals:

Andreas Dilger
Dave Martindale
Guy Eric Schalnat
Paul Schmidt
Tim Wegner

The PNG Reference Library is supplied "AS IS". The Contributing Authors and Group 42, Inc. disclaim all warranties, expressed or implied, including, without limitation, the warranties of merchantability and of fitness for any purpose. The Contributing Authors and Group 42, Inc. assume no liability for direct, indirect, incidental, special, exemplary, or consequential damages, which may result from the use of the PNG Reference Library, even if advised of the possibility of such damage.

Permission is hereby granted to use, copy, modify, and distribute this source code, or portions hereof, for any purpose, without fee, subject to the following restrictions:

1. The origin of this source code must not be misrepresented.
2. Altered versions must be plainly marked as such and must not be misrepresented as being the original source.
3. This Copyright notice may not be removed or altered from any source or altered source distribution.

The Contributing Authors and Group 42, Inc. specifically permit, without fee, and encourage the use of this source code as a component to supporting the PNG file format in commercial products. If you use this source code in a product, acknowledgment is not required but would be appreciated.

A "png_get_copyright" function is available, for convenient use in "about" boxes and the like:

```
printf("%s",png_get_copyright(NULL));
```

Also, the PNG logo (in PNG format, of course) is supplied in the files "pngbar.png" and "pngbar.jpg (88x31) and "pngnow.png" (98x31).

Libpng is OSI Certified Open Source Software. OSI Certified Open Source is a certification mark of the Open Source Initiative.

Glenn Randers-Pehrson
glennrp@users.sourceforge.net
September 12, 2004

zlib

This projector product includes the open source software program "zlib" which applies the terms and conditions provided by owner of the copyright to the "zlib".

The "zlib" are WITHOUT ANY WARRANTY; without even the implied warranty of MERCHANTABILITY AND FITNESS FOR A PARTICULAR PURPOSE.

List of zlib programs

zlib-1.1.4

License terms of conditions of each program which are provided by owner of the copyright to the "zlib" are as follows.

Copyright notice:

(C) 1995-1998 Jean-loup Gailly and Mark Adler

This software is provided 'as-is', without any express or implied warranty. In no event will the authors be held liable for any damages arising from the use of this software.

Permission is granted to anyone to use this software for any purpose, including commercial applications, and to alter it and redistribute it freely, subject to the following restrictions:

1. The origin of this software must not be misrepresented; you must not claim that you wrote the original software. If you use this software in a product, an acknowledgment in the product documentation would be appreciated but is not required.
2. Altered source versions must be plainly marked as such, and must not be misrepresented as being the original software.
3. This notice may not be removed or altered from any source distribution.

Jean-loup Gailly
jloup@gzip.org

Mark Adler
madler@alumni.caltech.edu

If you use the zlib library in a product, we would appreciate *not* receiving lengthy legal documents to sign. The sources are provided for free but without warranty of any kind. The library has been entirely written by Jean-loup Gailly and Mark Adler; it does not include third-party code.

If you redistribute modified sources, we would appreciate that you include in the file ChangeLog history information documenting your changes.

libmd5-rfc

This projector product includes the open source software program "libmd5-rfc" which applies the terms and conditions provided by owner of the copyright to the "libmd5-rfc".

The "libmd5-rfc" are WITHOUT ANY WARRANTY; without even the implied warranty of MERCHANTABILITY AND FITNESS FOR A PARTICULAR PURPOSE.

List of libmd5-rfc programs

libmd5-rfc

License terms of conditions of each program which are provided by owner of the copyright to the "libmd5-rfc" are as follows.

Copyright (C) 1999, 2002 Aladdin Enterprises. All rights reserved.

This software is provided 'as-is', without any express or implied warranty. In no event will the authors be held liable for any damages arising from the use of this software.

Permission is granted to anyone to use this software for any purpose, including commercial applications, and to alter it and redistribute it freely, subject to the following restrictions:

1. The origin of this software must not be misrepresented; you must not claim that you wrote the original software. If you use this software in a product, an acknowledgment in the product documentation would be appreciated but is not required.
2. Altered source versions must be plainly marked as such, and must not be misrepresented as being the original software.
3. This notice may not be removed or altered from any source distribution.

L. Peter Deutsch ghost@aladdin.com

Independent implementation of MD5 (RFC 1321).

This code implements the MD5 Algorithm defined in RFC 1321, whose text is available at

<http://www.ietf.org/rfc/rfc1321.txt>

The code is derived from the text of the RFC, including the test suite (section A.5) but excluding the rest of Appendix A. It does not include any code or documentation that is identified in the RFC as being copyrighted.

The original and principal author of md5.h is L. Peter Deutsch <ghost@aladdin.com>. Other authors are noted in the change history that follows (in reverse chronological order):

- 2002-04-13 lpd Removed support for non-ANSI compilers; removed references to Ghostscript; clarified derivation from RFC 1321; now handles byte order either statically or dynamically.
- 1999-11-04 lpd Edited comments slightly for automatic TOC extraction.
- 1999-10-18 lpd Fixed typo in header comment (ansi2knr rather than md5); added conditionalization for C++ compilation from Martin Purschke <purschke@bnl.gov>.
- 1999-05-03 lpd Original version.

ncurses

This projector product includes the open source software program "ncurses" which applies the terms and conditions provided by owner of the copyright to the "ncurses".

The "ncurses" are WITHOUT ANY WARRANTY; without even the implied warranty of MERCHANTABILITY AND FITNESS FOR A PARTICULAR PURPOSE.

List of ncurses programs

ncurses-5.6

License terms of conditions of each program which are provided by owner of the copyright to the "ncurses" are as follows.

Copyright (c) 1998-2002,2003 Free Software Foundation, Inc.

Permission is hereby granted, free of charge, to any person obtaining a copy of this software and associated documentation files (the "Software"), to deal in the Software without restriction, including without limitation the rights to use, copy, modify, merge, publish, distribute, distribute with modifications, sublicense, and/or sell copies of the Software, and to permit persons to whom the Software is furnished to do so, subject to the following conditions:

The above copyright notice and this permission notice shall be included in all copies or substantial portions of the Software.

THE SOFTWARE IS PROVIDED "AS IS", WITHOUT WARRANTY OF ANY KIND, EXPRESS OR IMPLIED, INCLUDING BUT NOT LIMITED TO THE WARRANTIES OF MERCHANTABILITY, FITNESS FOR A PARTICULAR PURPOSE AND NONINFRINGEMENT. IN NO EVENT SHALL THE ABOVE COPYRIGHT HOLDERS BE LIABLE FOR ANY CLAIM, DAMAGES OR OTHER LIABILITY, WHETHER IN AN ACTION OF CONTRACT, TORT OR OTHERWISE, ARISING FROM, OUT OF OR IN CONNECTION WITH THE SOFTWARE OR THE USE OR OTHER DEALINGS IN THE SOFTWARE.

Except as contained in this notice, the name(s) of the above copyright holders shall not be used in advertising or otherwise to promote the sale, use or other dealings in this Software without prior written authorization.

mDNSResponder

This projector product includes the open source software program "mDNSResponder" which applies the following license terms "Apache License Version 2.0, January 2004".

List of "mDNSResponder"

mDNSResponder-107.6 (only mDNSResponderPosix is used)

License terms "Apache License Version 2.0, January 2004" are as follows.

Apache License

Version 2.0, January 2004

<http://www.apache.org/licenses/>

TERMS AND CONDITIONS FOR USE, REPRODUCTION, AND DISTRIBUTION

1. Definitions.

"License" shall mean the terms and conditions for use, reproduction, and distribution as defined by Sections 1 through 9 of this document.

"Licensor" shall mean the copyright owner or entity authorized by the copyright owner that is granting the License.

"Legal Entity" shall mean the union of the acting entity and all other entities that control, are controlled by, or are under common control with that entity. For the purposes of this definition, "control" means (i) the power, direct or indirect, to cause the direction or management of such entity, whether by contract or otherwise, or (ii) ownership of fifty percent (50%) or more of the outstanding shares, or (iii) beneficial ownership of such entity.

"You" (or "Your") shall mean an individual or Legal Entity exercising permissions granted by this License.

"Source" form shall mean the preferred form for making modifications, including but not limited to software source code, documentation source, and configuration files.

"Object" form shall mean any form resulting from mechanical transformation or translation of a Source form, including but not limited to compiled object code, generated documentation, and conversions to other media types.

"Work" shall mean the work of authorship, whether in Source or Object form, made available under the License, as indicated by a copyright notice that is included in or attached to the work (an example is provided in the Appendix below).

"Derivative Works" shall mean any work, whether in Source or Object form, that is based on (or derived from) the Work and for which the editorial revisions, annotations, elaborations, or other modifications represent, as a whole, an original work of authorship. For the purposes of this License, Derivative Works shall not include works that remain separable from, or merely link (or bind by name) to the interfaces of, the Work and Derivative Works thereof.

"Contribution" shall mean any work of authorship, including the original version of the Work and any modifications or additions to that Work or Derivative Works thereof, that is intentionally submitted to Licensor for inclusion in the Work by the copyright owner or by an individual or Legal Entity authorized to submit on behalf of the copyright owner. For the purposes of this definition, "submitted" means any form of electronic, verbal, or written communication sent to the Licensor or its representatives, including but not limited to communication on electronic mailing lists, source code control systems, and issue tracking systems that are managed by, or on behalf of, the Licensor for the purpose of discussing and improving the Work, but excluding communication that is conspicuously marked or otherwise designated in writing by the copyright owner as "Not a Contribution."

"Contributor" shall mean Licensor and any individual or Legal Entity on behalf of whom a Contribution has been received by Licensor and subsequently incorporated within the Work.

2. Grant of Copyright License. Subject to the terms and conditions of this License, each Contributor hereby grants to You a perpetual, worldwide, non-exclusive, no-charge, royalty-free, irrevocable copyright license to reproduce, prepare Derivative Works of, publicly display, publicly perform, sublicense, and distribute the Work and such Derivative Works in Source or Object form.
3. Grant of Patent License. Subject to the terms and conditions of this License, each Contributor hereby grants to You a perpetual, worldwide, non-exclusive, no-charge, royalty-free, irrevocable (except as stated in this section) patent license to make, have made, use, offer to sell, sell, import, and otherwise transfer the Work, where such license applies only to those patent claims licensable by such Contributor that are necessarily infringed by their Contribution(s) alone or by combination of their Contribution(s) with the Work to which such Contribution(s) was submitted. If You institute patent litigation against any entity (including a cross-claim or counterclaim in a lawsuit) alleging that the Work or a Contribution incorporated within the Work constitutes direct or contributory patent infringement, then any patent licenses granted to You under this License for that Work shall terminate as of the date such litigation is filed.
4. Redistribution. You may reproduce and distribute copies of the Work or Derivative Works thereof in any medium, with or without modifications, and in Source or Object form, provided that You meet the following conditions:
 - (a) You must give any other recipients of the Work or Derivative Works a copy of this License; and
 - (b) You must cause any modified files to carry prominent notices stating that You changed the files; and
 - (c) You must retain, in the Source form of any Derivative Works that You distribute, all copyright, patent, trademark, and attribution notices from the Source form of the Work, excluding those notices that do not pertain to any part of the Derivative Works; and

- (d) If the Work includes a "NOTICE" text file as part of its distribution, then any Derivative Works that You distribute must include a readable copy of the attribution notices contained within such NOTICE file, excluding those notices that do not pertain to any part of the Derivative Works, in at least one of the following places: within a NOTICE text file distributed as part of the Derivative Works; within the Source form or documentation, if provided along with the Derivative Works; or, within a display generated by the Derivative Works, if and wherever such third-party notices normally appear. The contents of the NOTICE file are for informational purposes only and do not modify the License. You may add Your own attribution notices within Derivative Works that You distribute, alongside or as an addendum to the NOTICE text from the Work, provided that such additional attribution notices cannot be construed as modifying the License.

You may add Your own copyright statement to Your modifications and may provide additional or different license terms and conditions for use, reproduction, or distribution of Your modifications, or for any such Derivative Works as a whole, provided Your use, reproduction, and distribution of the Work otherwise complies with the conditions stated in this License.

5. Submission of Contributions. Unless You explicitly state otherwise, any Contribution intentionally submitted for inclusion in the Work by You to the Licensor shall be under the terms and conditions of this License, without any additional terms or conditions.

Notwithstanding the above, nothing herein shall supersede or modify the terms of any separate license agreement you may have executed with Licensor regarding such Contributions.

6. Trademarks. This License does not grant permission to use the trade names, trademarks, service marks, or product names of the Licensor, except as required for reasonable and customary use in describing the origin of the Work and reproducing the content of the NOTICE file.
7. Disclaimer of Warranty. Unless required by applicable law or agreed to in writing, Licensor provides the Work (and each Contributor provides its Contributions) on an "AS IS" BASIS, WITHOUT WARRANTIES OR CONDITIONS OF ANY KIND, either express or implied, including, without limitation, any warranties or conditions of TITLE, NON-INFRINGEMENT, MERCHANTABILITY, or FITNESS FOR A PARTICULAR PURPOSE. You are solely responsible for determining the appropriateness of using or redistributing the Work and assume any risks associated with Your exercise of permissions under this License.
8. Limitation of Liability. In no event and under no legal theory, whether in tort (including negligence), contract, or otherwise, unless required by applicable law (such as deliberate and grossly negligent acts) or agreed to in writing, shall any Contributor be liable to You for damages, including any direct, indirect, special, incidental, or consequential damages of any character arising as a result of this License or out of the use or inability to use the Work (including but not limited to damages for loss of goodwill, work stoppage, computer failure or malfunction, or any and all other commercial damages or losses), even if such Contributor has been advised of the possibility of such damages.

9. Accepting Warranty or Additional Liability. While redistributing the Work or Derivative Works thereof, You may choose to offer, and charge a fee for, acceptance of support, warranty, indemnity, or other liability obligations and/or rights consistent with this License. However, in accepting such obligations, You may act only on Your own behalf and on Your sole responsibility, not on behalf of any other Contributor, and only if You agree to indemnify, defend, and hold each Contributor harmless for any liability incurred by, or claims asserted against, such Contributor by reason of your accepting any such warranty or additional liability.

END OF TERMS AND CONDITIONS

APPENDIX: How to apply the Apache License to your work.

To apply the Apache License to your work, attach the following boilerplate notice, with the fields enclosed by brackets "[]" replaced with your own identifying information. (Don't include the brackets!) The text should be enclosed in the appropriate comment syntax for the file format. We also recommend that a file or class name and description of purpose be included on the same "printed page" as the copyright notice for easier identification within third-party archives.

Copyright [yyyy][name of copyright owner]

Licensed under the Apache License, Version 2.0 (the "License");

you may not use this file except in compliance with the License.

You may obtain a copy of the License at

<http://www.apache.org/licenses/LICENSE-2.0>

Unless required by applicable law or agreed to in writing, software distributed under the License is distributed on an "AS IS" BASIS, WITHOUT WARRANTIES OR CONDITIONS OF ANY KIND, either express or implied.

See the License for the specific language governing permissions and limitations under the License.

Index

A

- A/V Mute
 - button, 60, 126
 - display settings, 77, 83
- Accessories, 20 to 21
- Adapter, audio, 34
- Air filter
 - cleaning, 111
 - ordering, 20
 - replacing, 112 to 113
- Altitude, 78, 124, 145
- Anti-theft device, 20, 84
- Aspect ratio, 46, 74, 143
- Audio
 - adapter, 34
 - cable, 33
 - connecting equipment, 33 to 36
 - controlling volume, 62
 - problems, troubleshooting, 133 to 134
 - turning off (using A/V Mute), 60
- Auto Iris setting, 72
- Auto Setup setting, 73

B

- Background screen settings, 77, 83
- Bands, vertical, 132
- Batteries, replacing, 118 to 120
- Blackboard color mode, 45
- Blurry image, 131
- Brightness, 143
- Brightness setting, 72
- Browser control, 104

C

- Cables
 - audio, 33
 - component-to-VGA, 20, 29, 31
 - composite, 29
 - Ethernet, 86
 - mouse, 27
 - ordering, 20 to 21
 - security, 84
 - S-Video, 20, 30
 - USB, 25 to 27, 37 to 38
 - VGA, 24, 32
- Calibrating, 49 to 51
- Capturing image, 82
- Chalkboard, projecting on, 45
- Cleaning
 - air filter, 111
 - projection window, 110
 - projector case, 110
- Closed captioning, 77
- Color
 - correcting, 45, 72
 - problems, 132 to 133
 - saturation, 72
 - settings, 72
- Color Mode, 45, 72
- Component-to-VGA video cable, 20, 29, 31
- Composite video cable, 29
- Computer
 - connecting to, 24 to 25
 - selecting source, 43
- Connecting projector
 - to audio equipment, 33 to 36
 - to computer, 24 to 25
 - to document camera, 37 to 38
 - to monitor, 28
 - to USB device, 37 to 38
 - to video equipment, 29 to 32
- Contrast ratio, 143
- Contrast setting, 72

Control Panel Lock setting, 75, 83 to 84, 125
Custom screen, *see* User's Logo

D

Data encryption, 100
Default settings, restoring, 71
DHCP, 138
Dimensions, projector, 18, 144
Direct Power On, 41
Distance from projector to screen, 143
Document camera
 connecting, 37 to 38
 ordering, 20
Documentation, 10
DVD player, connecting, 29 to 32
Dynamic color mode, 45

E

Easy Interactive Driver, 48 to 49
Easy Interactive Tools, 52 to 57
EasyMP Monitor, 85
EasyMP Network Projection
 creating password for, 93
 data encryption, 100
 features, 101
 network projection, 85 to 101
 problems, 136 to 138
Electrical specifications, 144
E-mail alerts, 101 to 102
Encryption, 97 to 98, 100
Environmental specifications, 145
Epson
 accessories, 20 to 21
 PrivateLine Support, 11
 technical support, 10, 140 to 141
 warranty, 11
Error status lights, 124
Ethernet cable, 86 to 88
Extended menu, 77 to 78
E-Zoom buttons, 61

F

FCC compliance statement, 152

Filter, *see* Air filter
Fn key, notebook, 128
Focusing image, 44
Freeze button, 61
Full aspect setting, 46

H

Help system, using, 122
Help, Epson, 10, 140 to 141
High Altitude mode, 78, 124, 145

I

iBook, connecting to, 24
Image
 adjusting, 43 to 46, 71 to 72
 blurry, 131
 capturing and saving in projector, 82
 correcting shape, 75, 130
 fitting on screen, 73, 130
 focusing, 44
 problems with, 126 to 133
 projecting on chalkboard, 45
 selecting source, 43
 size and projection distance, 143
 turning off (using A/V Mute), 60
 turning off temporarily, 60
 zooming, 61
Image menu, 71 to 72
Info menu, 117 to 118
Input Signal setting, 25, 31, 32, 74
Input signal, selecting, 43
Instant Off, 42
Interactive pens, *see* Pens, interactive

K

Kensington anti-theft device, 20, 84
Keystone correction, 75, 130, 144
Keyword, 93

L

- Lamp
 - number of hours used, 117 to 118
 - ordering, 20
 - replacing, 113 to 117
 - specifications, 144
 - status light, 113, 123 to 124
- Lamp timer, resetting, 117
- LAN button, 87
- Language setting, 78
- Laptop computer
 - connecting to, 24 to 25
 - display problems, 126 to 130
 - selecting source, 43
- Light output specifications, 143
- Lights, status, 123 to 124
- Locking
 - buttons, 83 to 84
 - projector, 84
- Logo, saving on projector, 81 to 83

M

- Macintosh
 - display problems, 128
 - selecting network settings, 96
- Manuals, 10
- Menus
 - changing settings, 70 to 71
 - default settings, restoring, 71
 - Extended, 77 to 78
 - Image, 71 to 72
 - Info, 117 to 118
 - Network, 87, 91
 - Reset, 71, 117
 - Settings, 75 to 76
 - Signal, 73 to 74
 - User's Logo, 82
- Mic Input Level setting, 76
- Microphone, connecting, 35
- Monitor, connecting external, 28

- Monitoring projector
 - EasyMP Monitor, 85
 - e-mail notifications, 101 to 102
 - SNMP, 103 to 104
 - using browser, 104

- Mouse
 - connecting cable for remote, 27 to 28
 - using pen as, 51 to 52
 - using remote control as, 64

N

- Network
 - managing projector remotely, 101 to 105
 - problems, 136 to 138
 - security, 97 to 100
 - settings, 86 to 104
 - wired, 86 to 88
 - wireless, 89 to 101
- No Signal message, 127 to 128
- Noise level, 144
- Normal aspect setting, 46
- Not Supported message, 128
- Notebook computer, *see* Laptop computer
- Num button, 80
- Numeric keypad, using, 80

O

- Optical aspect ratio, 46, 143
- Options for projector, 20 to 21

P

- Page Up (+)/Page Down (-) buttons, 64
- Page Up/Down setting, 64
- Password
 - Protect sticker, 12
 - protection, 79 to 81
 - remote access, 93
 - request code, 81
- Pattern
 - capturing and saving in projector, 63 to 64
 - displaying, 62 to 63
 - selecting, 76

- Pens, interactive
 - as mouse, 51 to 52
 - calibrating, 49 to 51
 - driver, 48 to 49
 - parts, 16
 - problems, 134 to 136
 - replacing batteries, 118
 - using, 47 to 57
- Photo color mode, 45
- Picture source, selecting, 43
- Picture, *see* Image
- Pointer tool, using, 65 to 66
- Position setting, 74, 130
- Power
 - button, 41
 - specifications, 144
 - status light, 41, 123 to 124
- Power Consumption setting, 75, 113, 118
- PowerPoint, 64, 66, 78
- Presentation color mode, 45
- Presentations
 - computer, 27 to 28
 - using the pointer tool, 65 to 66
 - wireless, 85 to 101
- PrivateLine Support, 11
- Problems
 - color, 132 to 133
 - connecting wirelessly, 136 to 138
 - image, 126 to 133
 - interactive pens, 134 to 136
 - network, 136 to 138
 - no signal, 127 to 128
 - remote control, 139
 - sound, 133 to 134
 - USB Display, 125
 - using on-screen help, 122
- Progressive format, 74
- Projection lamp, *see* Lamp
- Projection setting, 77
- Projection window, cleaning, 110
- Projector
 - cleaning, 110
 - dimensions, 18
 - disabling buttons, 83 to 84
 - distance from screen, 143
 - lamp specifications, 144
 - monitoring remotely, 101 to 105
 - options, 20 to 21
 - parts, 14
 - password protection, 79 to 81
 - ports, 15
 - resolution, 143
 - security features, 79 to 84
 - specifications, 143 to 145
 - transporting, 120
 - troubleshooting, 121 to 141
 - turning off, 42
 - turning on, 40 to 41
 - unpacking, 12 to 13
 - viewing information about, 117 to 118

Q

- Quick Wireless Connection
 - troubleshooting, 136
 - using, 91

R

- Rear-screen projection, 77
- Registration, 11

Remote control
A/V Mute button, 60
as wireless mouse, 64
batteries used, 144
batteries, replacing, 119 to 120
connecting cable for mouse, 27 to 28
correcting color, 45, 72
E-Zoom buttons, 61
Freeze button, 61
numeric keypad, using, 80
pointer tool, using, 65 to 66
problems, 139
range, 144
specifications, 144
troubleshooting, 139
USB button, 38, 43
using, 60
virtual over network, 106

Remote Receiver, deactivating, 76

Replacing lamp, 113 to 117

Request code, password, 81

Resetting lamp timer, 117

Resetting menu options, 71

Resize image, 46

Resolution, 46, 128, 143

Resolution setting, 73

S

Safety
instructions, 149 to 151
specifications, 145

Saturation setting, 72

Screen
distance from projector, 143
ordering, 21
startup screen, creating, 81 to 82

Screen image, *see* Image

Security
cables, 84
Control Panel Lock, 83 to 84
identifying logo, 82 to 83
Kensington lock, 20, 84
network, 97 to 100
password protection, 79 to 81

Settings menu, 75 to 76

Sharpness setting, 72

Signal menu, 73 to 74

Sleep mode, 42, 78, 123, 126

Slide plate, 15

Slideshow
options, 68
running, 66 to 68

SNMP, 103 to 104

Sound, troubleshooting, 133

Source, selecting, 43

Speaker, specifications, 143

Speakers, connecting, 36

Specifications
brightness, 143
dimensions, 144
electrical, 144
environmental, 145
general, 143
lamp, 144
remote control, 144
resolution, 143
safety, 145
speaker, 143
video formats, 145

Sports color mode, 45

sRGB color mode, 45

SSID, 95, 96

Startup screen
creating, 81 to 83
settings, 83
user's logo, *see* User's Logo

Status lights, 123 to 124

Support, *see* Technical support

S-Video cable, 20, 30

Switching picture source, 43

Sync, adjusting, 74, 132

T

Technical support, 10, 140 to 141

Temperature
requirements, 145
status light, 123 to 124

Test pattern, 76

- Theatre color mode, 45
- Through aspect setting, 46
- Tint setting, 72
- Tracking, adjusting, 74, 132
- Transporting projector, 120
- Troubleshooting
 - blank screen, 126 to 128
 - cut-off image, 130
 - image and sound problems, 126 to 134
 - network problems, 136 to 138
 - no signal, 127 to 128
 - projector problems, 121 to 141
 - remote control problems, 139
 - wireless projection problems, 136 to 138
- Turning off picture (using A/V Mute), 60
- Turning off projector, 42

U

- Unpacking projector, 12 to 13
- USB
 - button, 38, 43
 - cable, 25 to 27, 37 to 38
 - connecting external device, 37 to 38
 - connecting for display, 25 to 27
 - key, 91
 - selecting TypeB port usage, 64, 78
- USB Display, solving problems, 125
- User button, 76
- User's Logo
 - creating, 82
 - display settings, 83

V

- VCR, connecting, 29 to 32
- VGA video cable, 24, 32
- Video
 - cables, 12, 20 to 21, 29
 - connecting video equipment, 29 to 32
 - formats, supported, 145
 - selecting source, 43
- Video Signal setting, 74
- Volume, controlling, 62

W

- Warning lights, 123 to 124
- Warranty, 11
- Web browser control, 104
- Web Remote Control, 106
- WEP encryption, 97 to 98
- Whiteboard, 37 to 38
- Whiteboard color mode, 45
- Windows
 - display problems, 128
 - selecting network settings, 96
- Wired network, 86 to 88
- Wireless
 - module, 89 to 90
 - presentation, 85 to 101
 - problems, 136 to 138
 - Quick Wireless Connection, 91
 - security, 97 to 100
 - WEP encryption, 97 to 98
 - WPA security, 99 to 100
- Wireless mouse, 27 to 28, 64
- Wireless Mouse setting, 65, 78
- WPA security, 99 to 100

Z

- Zoom aspect setting, 46
- Zoom ratio, 143
- Zoom setting, 75
- Zooming image, 61