

myprojectorlamps.com

**The most trusted, dependable name
in projector lamp sales.**



<http://www.myprojectorlamps.com>



<http://www.myprojectorlamps.ca>



<http://www.myprojectorlamps.eu>

The following projector manual has not been modified or altered in any way.

EIKI

MULTIMEDIA PROJECTOR

MODEL LC-XG300/LC-XG250
LC-XG300L* /LC-XG250L*

(*Models without lens)

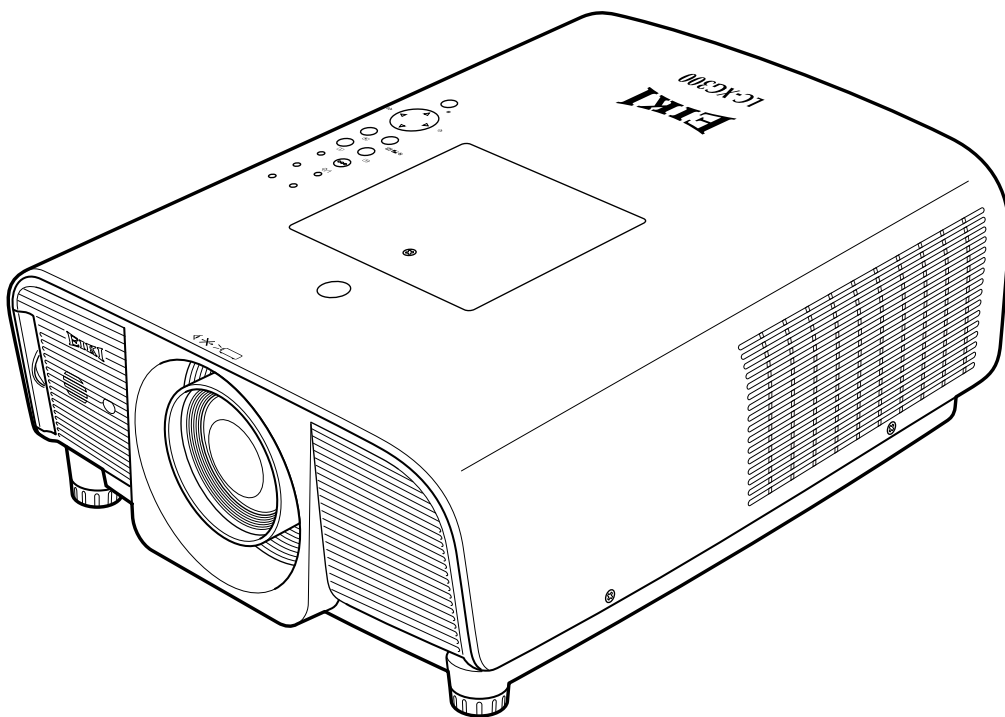

OWNER'S MANUAL

PJLink™

Features and Design

◆ **Compact Design**

This projector is designed compact in size and weight. It is easy to carry and installed anywhere you wish to use.

◆ **Functionally Rich**

This projector has many useful functions such as lens shifting, ceiling and rear projection, 360-degree projection, variety of lens options, etc.

◆ **Multi-use Remote Control**

Use the remote control as wired and wireless, or as a PC wireless mouse. Eight remote control codes and selectable pointer shapes are also available.

◆ **Simple Computer System Setting**

The projector has the Multi-scan system to conform to almost all computer output signals quickly (p.38). Up to UXGA resolution can be accepted.

◆ **Useful Functions for Presentation**

- Digital zoom function allows you to focus on the crucial information during a presentation (pp.15, 51).

◆ **Security Function**

The Security function helps you to ensure security of the projector. With the Key lock function, you can lock the operation on the top control or remote control (p.59). PIN code lock functions prevents unauthorized use of the projector (pp.59–61).

◆ **Lamp Control**

Brightness of the projection lamp can be selected (p.54).

◆ **Power Management**

The Power management function reduces power consumption and maintains lamp life (p.58).

◆ **Multilanguage Menu Display**

Operation menu is available in 12 languages; English, German, French, Italian, Spanish, Portuguese, Dutch, Swedish, Russian, Chinese, Korean, and Japanese (p.54).

◆ **Network-capable**

Through an optional Network Manager, you can operate and control the projector.

◆ **Logo Function**

The Logo function allows you to customize the screen logo (pp.55–56). You can capture an image for the screen logo and use it for the starting-up display or between presentations.

◆ **Helpful Maintenance Functions**

Lamp and filter maintenance functions provide for better and proper maintenance of the projector.

◆ **Multiple Interface Terminals**

The projector has several interface terminals that can support various types of equipment and signals (pp.11–12).

✓ **Notes:**

- The On-Screen Menu and figures in this manual may differ slightly from the product.
- The contents of this manual are subject to change without notice.

Table of Contents

Features and Design	2	Input Selection	33
Table of Contents	3	Input	34
To the Owner	4	Input Source Selection	35
Safety Instructions	5	Video System Selection	36
Air Circulation	6	Computer Adjustment	37
Installing the Projector in Proper Directions	7	Computer System Selection	38
Moving the Projector	8	Auto PC Adjustment	39
Cautions in Handling the Projector	8	Manual PC Adjustment	40
Compliance	9	Image Mode Selection	43
Part Names and Functions	10	Image Mode Selection	44
Front	10	Image Adjustment	45
Back	10	Image Adjustment	46
Bottom	10	Screen Adjustment	49
Rear Terminal	11	Screen Adjustment	50
Top Control	13	Screen Size Adjustment (Computer Signals)	51
Remote Control	14	Screen Size Adjustment (Video, Component Signals)	52
Laser Pointer Function	16	Setting	53
Pointer Function	16	Setting	54
Wireless Mouse Operation	17	Maintenance and Filter Cleaning	63
Remote Control Code	17	Cleaning the Filter	64
Remote Control Battery Installation	18	Resetting the Filter Counter	64
Remote Control Receivers and Operating Range	18	Lamp Replacement	65
Adjustable Feet	18	Resetting the Lamp Counter	66
Installation	19	Warning Indicator	67
Lens Installation	19	Cleaning the Projection Lens	68
Positioning the Projector	20	Cleaning the Projector Cabinet	68
Moving the Lens	20	Appendix	69
Connecting the AC Power Cord	21	Troubleshooting	69
Connecting to a Computer (Digital and Analog RGB)	22	Menu Tree	71
Connecting to Video Equipment (Video, S-Video)	23	Indicators and Projector Condition	73
Connecting to Video Equipment (Component and RGB Scart)	24	Compatible Computer Specifications	75
Basic Operation	25	Technical Specifications	77
Turning On the Projector	25	Optional Parts	78
Turning Off the Projector	26	PJ Link Notice	79
How to Operate the On-Screen Menu	27	Configurations of Terminals	80
Menu Bar	28	PIN Code Number Memo	81
Operating with Projector Control	29	Dimensions	82
Sound Adjustment	30		
Operating with Remote Control	31		

Trademarks

Each name of corporations or products in this book is either a registered trademark or a trademark of its respective corporation.





To the Owner

Before installing and operating the projector, read this manual thoroughly.

The projector provides many convenient features and functions. Operating the projector properly enables you to manage those features and maintains it in good condition for many years to come.

Improper operation may result in not only shortening the product life, but also malfunctions, fire hazard, or other accidents.

If your projector seems to operate improperly, read this manual again, check operations and cable connections and try the solutions in the "Troubleshooting" section in the back of this booklet. If the problem still persists, contact the dealer where you purchased the projector or the service center.

	CAUTION RISK OF ELECTRIC SHOCK DO NOT OPEN	
CAUTION: TO REDUCE THE RISK OF ELECTRIC SHOCK, DO NOT REMOVE COVER (OR BACK). NO USER-SERVICEABLE PARTS INSIDE EXCEPT LAMP REPLACEMENT. REFER SERVICING TO QUALIFIED SERVICE PERSONNEL.		
	THIS SYMBOL INDICATES THAT DANGEROUS VOLTAGE CONSTITUTING A RISK OF ELECTRIC SHOCK IS PRESENT WITHIN THIS UNIT.	
	THIS SYMBOL INDICATES THAT THERE ARE IMPORTANT OPERATING AND MAINTENANCE INSTRUCTIONS IN THE OWNER'S MANUAL WITH THIS UNIT.	

NOTE: This symbol and recycle system are applied only to EU countries and not applied to the countries in the other area of the world.



Your EIKI product is designed and manufactured with high quality materials and components which can be recycled and reused.

This symbol means that electrical and electronic equipment, at their end-of-life, should be disposed of separately from your household waste.

Please dispose of this equipment at your local community waste collection/recycling centre. In the European Union there are separate collection systems for used electrical and electronic products.

Please help us to conserve the environment we live in!

READ AND KEEP THIS OWNER'S MANUAL FOR LATER USE.

Safety Precaution

WARNING: TO REDUCE THE RISK OF FIRE OR ELECTRIC SHOCK, DO NOT EXPOSE THIS APPLIANCE TO RAIN OR MOISTURE.

- This projector produces intense light from the projection lens. Do not stare directly into the lens as much as possible, otherwise eye damage could result. Be especially careful that children do not stare directly into the beam.
- Install the projector in a proper position. Otherwise it may result in fire hazard.
- Allowing the proper amount of space on the top, sides, and rear of the projector cabinet is critical for proper air circulation and cooling of the unit. The dimension shown here indicate the minimum space required. If the projector is to be built into a compartment or similarly enclosed, these minimum distances must be maintained.
- Do not cover the ventilation slot on the projector. Heat build-up can reduce the service life of your projector, and can also be dangerous.

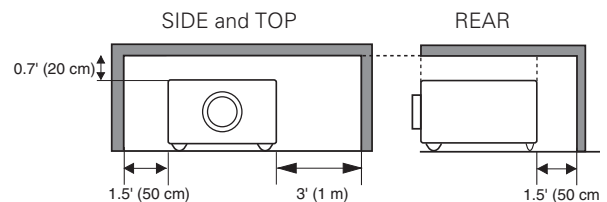

- If the projector is unused for an extended time, unplug the projector from the power outlet.

CAUTION ON HANGING FROM THE CEILING

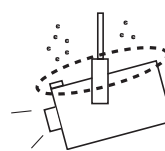

When hanging the projector from the ceiling, clean air intake vents, filters, or top of the projector periodically with a vacuum cleaner. If you leave the projector unclean for a long time, the cooling fans can be clogged with dust, and it may cause a breakdown or a disaster.

DO NOT SET THE PROJECTOR IN GREASY, WET, OR SMOKY CONDITIONS SUCH AS IN A KITCHEN TO PREVENT A BREAKDOWN OR A DISASTER. IF THE PROJECTOR COMES IN CONTACT WITH OIL OR CHEMICALS, IT MAY BECOME DETERIORATED.

CAUTION

Not for use in a computer room as defined in the Standard for the Protection of Electronic Computer/Data Processing Equipment, ANSI/NFPA 75.

Ne peut être utilisé dans une salle d'ordinateurs telle que définie dans la norme ANSI/NFPA 75 Standard for Protection of Electronic Computer/Data Processing Equipment

Safety Instructions

All the safety and operating instructions should be read before the product is operated.

Read all of the instructions given here and retain them for later use. Unplug this projector from AC power supply before cleaning. Do not use liquid or aerosol cleaners. Use a damp cloth for cleaning.

Follow all warnings and instructions marked on the projector.

For added protection to the projector during a lightning storm, or when it is left unattended and unused for long periods of time, unplug it from the wall outlet. This will prevent damage due to lightning and power line surges.

Do not expose this unit to rain or use near water... for example, in a wet basement, near a swimming pool, etc...

Do not use attachments not recommended by the manufacturer as they may cause hazards.

Do not place this projector on an unstable cart, stand, or table. The projector may fall, causing serious injury to a child or adult, and serious damage to the projector. Use only with a cart or stand recommended by the manufacturer, or sold with the projector. Wall or shelf mounting should follow the manufacturer's instructions, and should use a mounting kit approved by the manufacturers.

An appliance and cart combination should be moved with care. Quick stops, excessive force, and uneven surfaces may cause the appliance and cart combination to overturn.



Slots and openings in the back and bottom of the cabinet are provided for ventilation, to ensure reliable operation of the equipment and to protect it from overheating.

The openings should never be covered with cloth or other materials, and the bottom opening should not be blocked by placing the projector on a bed, sofa, rug, or other similar surface. This projector should never be placed near or over a radiator or heat register.

This projector should not be placed in a built-in installation such as a book case unless proper ventilation is provided.

Never push objects of any kind into this projector through cabinet slots as they may touch dangerous voltage points or short out parts that could result in a fire or electric shock. Never spill liquid of any kind on the projector.

Do not install the projector near the ventilation duct of air-conditioning equipment.

This projector should be operated only from the type of power source indicated on the marking label. If you are not sure of the type of power supplied, consult your authorized dealer or local power company.

Do not overload wall outlets and extension cords as this can result in fire or electric shock. Do not allow anything to rest on the power cord. Do not locate this projector where the cord may be damaged by persons walking on it.

Do not attempt to service this projector yourself as opening or removing covers may expose you to dangerous voltage or other hazards. Refer all servicing to qualified service personnel.

Unplug this projector from wall outlet and refer servicing to qualified service personnel under the following conditions:

- a. When the power cord or plug is damaged or frayed.
- b. If liquid has been spilled into the projector.
- c. If the projector has been exposed to rain or water.
- d. If the projector does not operate normally by following the operating instructions. Adjust only those controls that are covered by the operating instructions as improper adjustment of other controls may result in damage and will often require extensive work by a qualified technician to restore the projector to normal operation.
- e. If the projector has been dropped or the cabinet has been damaged.
- f. When the projector exhibits a distinct change in performance-this indicates a need for service.

When replacement parts are required, be sure the service technician has used replacement parts specified by the manufacturer that have the same characteristics as the original part. Unauthorized substitutions may result in fire, electric shock, or injury to persons.

Upon completion of any service or repairs to this projector, ask the service technician to perform routine safety checks to determine that the projector is in safe operating condition.



Voor de klanten in Nederland

Bij dit produkt zijn batterijen geleverd.

Wanneer deze leeg zijn, moet u ze niet weggooien maar inleveren als KCA.



Safety Instructions

Air Circulation

Openings in the cabinet are provided for ventilation. To ensure reliable operation of the product and to protect it from overheating, these openings must not be blocked or covered.

CAUTION

Hot air is exhausted from the exhaust vent. When using or installing the projector, the following precautions should be taken.

- Do not put any flammable object or spray can near the projector, hot air is exhausted from the air vents.
- Keep the exhaust vent at least 3' (1 m) away from any objects.
- Do not touch peripheral parts of the exhaust vent, especially screws and metallic parts. These areas will become hot while the projector is being used.
- Do not put anything on the cabinet. Objects put on the cabinet will not only get damaged but also may cause fire hazard by heat.

Cooling fans are provided to cool down the projector. The fans' running speed is changed according to the temperature inside the projector.

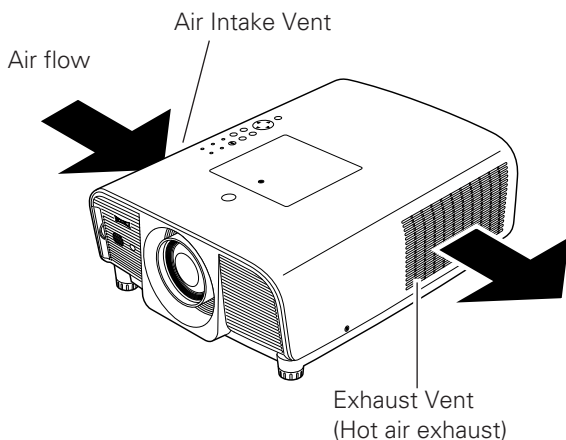

IMPORTANT!

Clean the Filter Regularly!!

The projector uses a lamp which generates significant heat. The cooling fans and air vents are provided to dissipate the heat by drawing air into the housing and the filter is located in the intake vents to prevent dust from getting inside of the projector.

In order to care for the projector appropriately, regular cleaning is required. Remove any dirt or dust that has accumulated on the projector and on or in the filter.

If the projector detects that the filter is clogged, a "Filter warning" icon (red) will appear on the screen and "WARNING FILTER" indicator on the top panel will blink (see below). Stop using the projector immediately and clean or replace the filter.

Blocking the air vents and leaving the projector uncleaned for a long time may not only damage the projector and may require costly repairs but may also cause accidents or fire.

For maintenance of the filter, refer to "Filter counter" on page 62 and "Maintenance and Filter Cleaning" on pages 63–64.

Damages to the projector caused by using an uncleaned filter or improper maintenance will void the warranty on the projector.

Top Control



Filter warning



Filter warning icon (red) appears on the screen when the projector detects filter clogging.

Installing the Projector in Proper Directions

Use the projector properly in specified positions. Improper positioning may reduce the lamp life and result in severe accident or fire hazard.

This projector can project the picture upward, downward, or backward, perpendicular to the plane of the screen as shown in the figure below.



CAUTION

Make sure that the Fan control settings are set properly when setting up the projector with upward/downward inclination of over 20 degrees to the horizontal plane. Set the Fan control function in the Setting menu (see page 59).

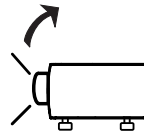

**Bottom
Downward
(Usual)**

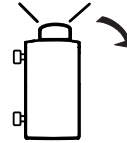

**Front
Upward**

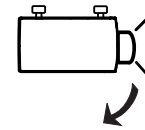

**Bottom
Upward**

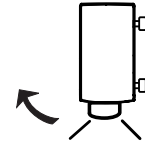

**Front
Downward**

Positioning Precautions

Avoid positioning the projector as described below when installing.

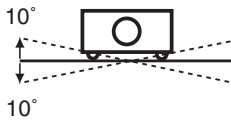

Do not tilt the projector more than 10 degrees from side to side.



Do not put the projector on either side to project an image.

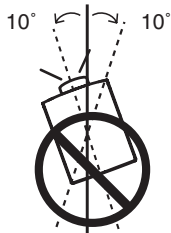

In upward projection, do not tilt the projector over 10 degrees right and left.

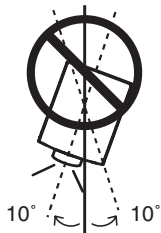

In downward projection, do not tilt the projector over 10 degrees right and left.

Safety Instructions

Moving the Projector

Use the hand grip when moving the projector.

Replace the lens cap and retract the adjustable feet to prevent damage to the lens and cabinet when carrying.

When the projector is not in use for an extended period, put it into a suitable case to protect the projector.

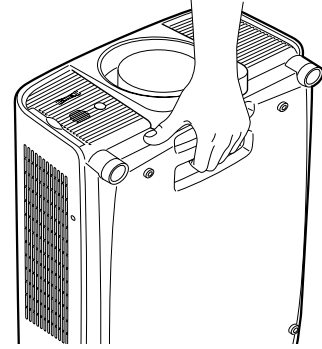

CAUTION IN CARRYING OR TRANSPORTING THE PROJECTOR

- Do not drop or bump the projector, otherwise damages or malfunctions may result.
- When carrying the projector, use a suitable carrying case.
- Do not transport the projector by courier or any other transport service in an unsuitable transport case. This may cause damage to the projector. For information about transporting the projector by courier or any other transport service, consult your dealer.
- Do not put the projector in a case before it is cooled enough.

Cautions in Handling the Projector

Do not hold the lens when lifting or moving the projector. Doing so may cause damage to the lens and the projector.

Care must be taken when handling the projector; do not drop, bump, subject it to strong forces, or put other things on the cabinet.

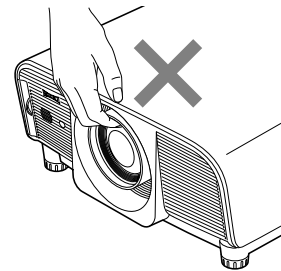

Do not hold the lens and the peripheral part.



CAUTION



This projector has a motorized lens. Please note the followings when using the projector.

- Do not touch the lens while it is moving as this could cause injury to the fingers.
- Never allow children to touch the lens.

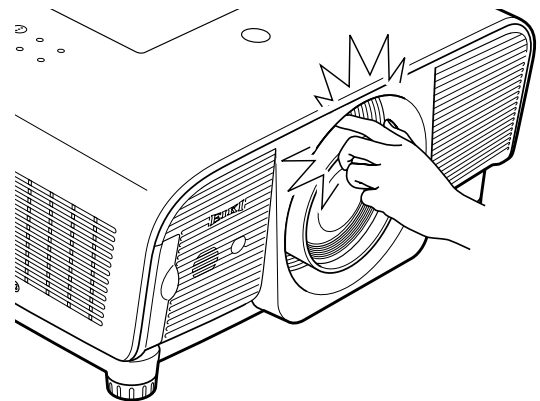

Compliance

Federal Communications Commission Notice

This equipment has been tested and found to comply with the limits for a Class B digital device, pursuant to Part 15 of the FCC Rules. These limits are designed to provide reasonable protection against harmful interference in a residential installation. This equipment generates, uses, and can radiate radio frequency energy and, if not installed and used in accordance with the instructions, may cause harmful interference to radio communications. However, there is no guarantee that interference will not occur in a particular installation. If this equipment does cause harmful interference to radio or television reception, which can be determined by turning the equipment off and on, the user is encouraged to try to correct the interference by one or more of the following measures:

- Reorient or relocate the receiving antenna.
- Increase the separation between the equipment and receiver.
- Connect the equipment into an outlet on a circuit different from that to which the receiver is connected.
- Consult the dealer or an experienced radio/TV technician for help.

Use of shielded cable is required to comply with class B limits in Subpart B of Part 15 of FCC Rules.

Do not make any changes or modifications to the equipment unless otherwise specified in the instructions. If such changes or modifications should be made, you could be required to stop operation of the equipment.

Model Number(s) : LC-XG300, LC-XG300L, LC-XG250, LC-XG250L
Trade Name : EIKI
Responsible party : EIKI International, Inc.
Address : 30251 Esperanza Rancho Santa Margarita CA 92688-2132, U.S.A.
Telephone No. : 800-242-3454 (949-457-0200)

AC Power Cord Requirement

The AC Power Cord supplied with this projector meets the requirement for use in the country you purchased it.

AC Power Cord for the United States and Canada:

AC Power Cord used in the United States and Canada is listed by the Underwriters Laboratories (UL) and certified by the Canadian Standard Association (CSA).

AC Power Cord has a grounding-type AC line plug. This is a safety feature to be sure that the plug will fit into the power outlet. Do not try to defeat this safety feature. Should you be unable to insert the plug into the outlet, contact your electrician.



THE SOCKET-OUTLET SHOULD BE INSTALLED NEAR THE EQUIPMENT AND EASILY ACCESSIBLE.

Part Names and Functions

Front

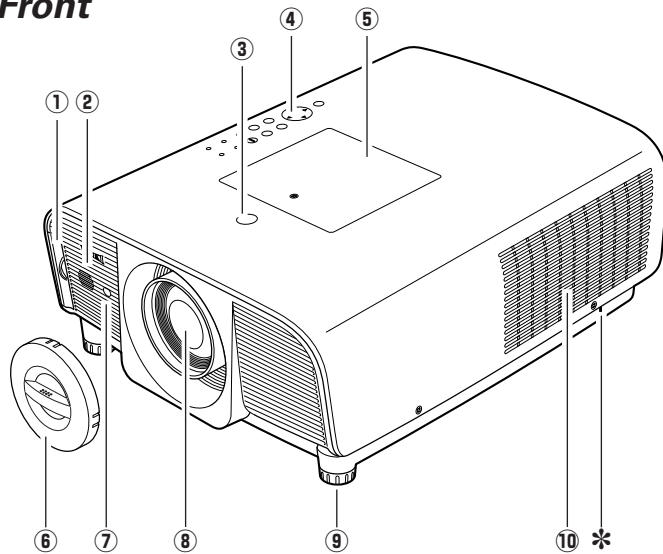

- ① Filter
- ② Speaker
- ③ Lens Release Button
- ④ Top Controls and Indicators
- ⑤ Maintenance Cover
- WARNING: FOR MAINTENANCE USE ONLY. DO NOT OPEN.**
- ⑥ Lens Cap (for LC-XG300/XG250)

⚠ CAUTION

Do not turn on the projector with the lens cap attached. High temperature from light beam may damage the lens cap and result in fire hazard.

- ⑦ Infrared Remote Receiver (Front)
- ⑧ Projection Lens (for LC-XG300/XG250)
- ⑨ Adjustable Feet
- ⑩ Exhaust Vent

Back

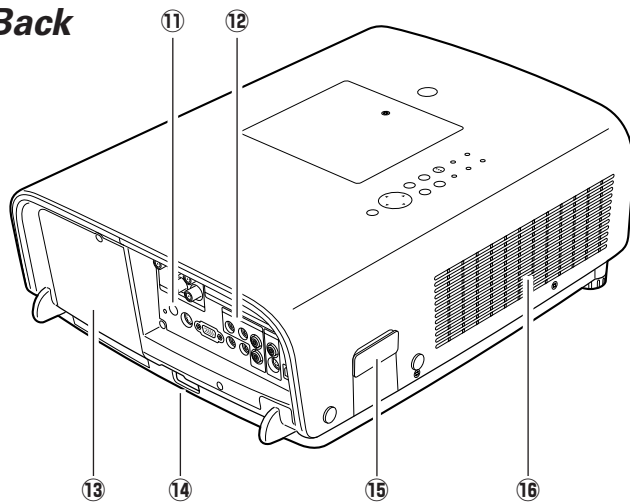

⚠ CAUTION

Hot air is exhausted from the exhaust vent. Do not put heat-sensitive objects near this side.

* Kensington Security Slot

This slot is for a Kensington lock used to deter theft of the projector.

*Kensington is a registered trademark of ACCO Brands Corporation.

- ⑪ Infrared Remote Receiver (Back)
- ⑫ Terminals and Connectors
- ⑬ Lamp Cover
- ⑭ Power Cord Connector
- ⑮ Optional Parts Attachment
- ⑯ Air Intake Vent
- ⑰ Hand Grip

Bottom

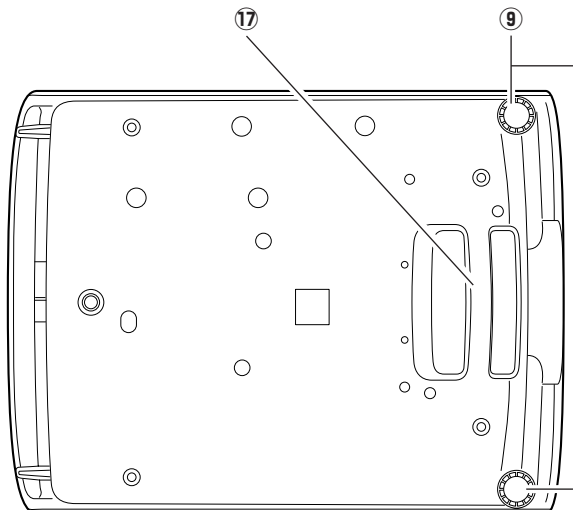

Rear Terminal

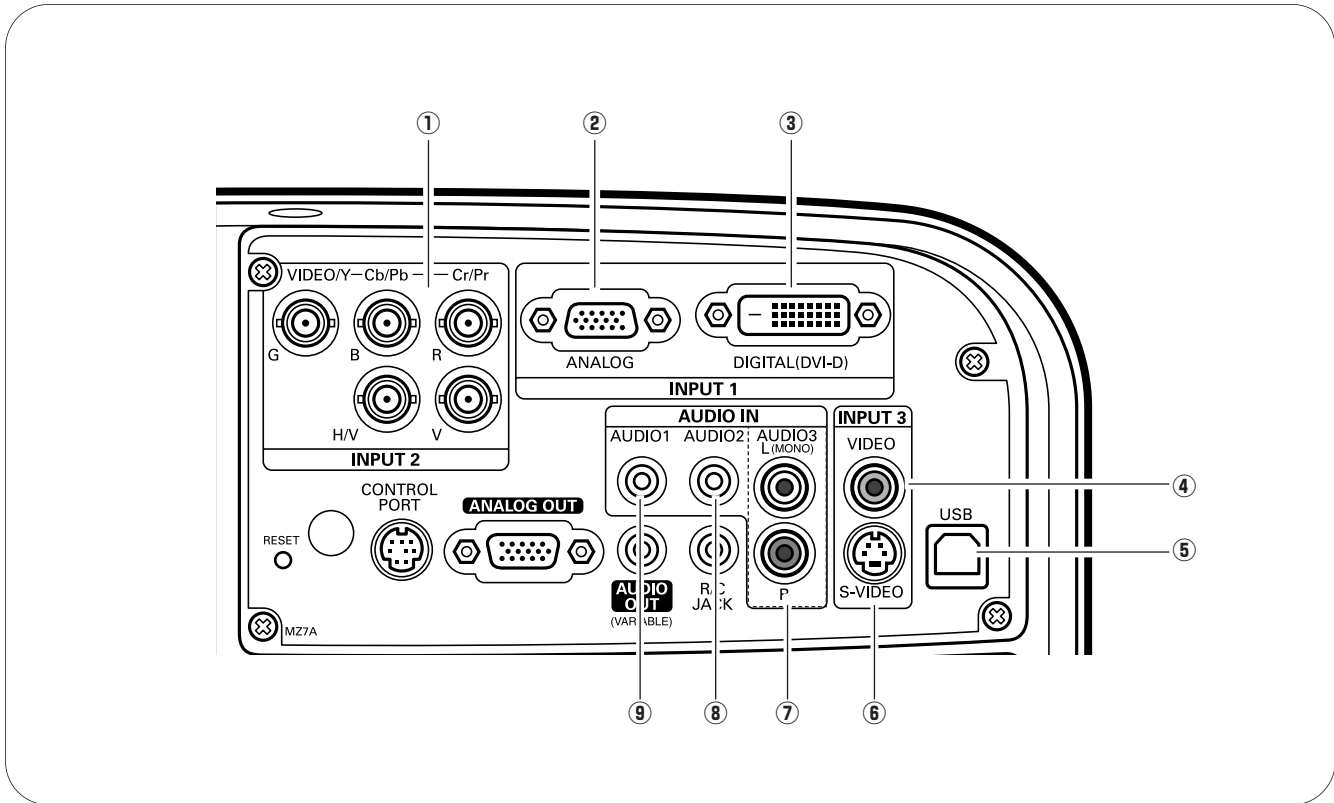

① 5 BNC INPUT JACKS

Connect the component or composite video output signal from video equipment to VIDEO/Y, Cb/Pb, and Cr/Pr jacks or connect the computer output signal (5 BNC Type [Green, Blue, Red, Horiz. Sync, and Vert. Sync.]) to G, B, R, H/V, and V jacks (pp.22–24).

② COMPUTER INPUT TERMINAL (ANALOG)

Connect the computer (or RGB scart) output signal to this terminal (pp.22, 24).

③ COMPUTER INPUT TERMINAL (DIGITAL)

Connect the computer output signal (Digital DVI-D type) to this terminal. The HD (HDCP compatible) signal can also be connected (pp.22, 24).

④ VIDEO INPUT JACK

Connect the composite video output signal from video equipment to this jack (p.23).

⑤ USB CONNECTOR (Series B)

Use this connector when controlling a computer with the remote control of the projector. Connect the USB terminal of your computer to this connector with the supplied USB cable (p.22).

⑥ S-VIDEO INPUT JACK

Connect the S-VIDEO output signal from video equipment to this jack (p.23).

⑦ AUDIO 3 JACKS (L(MONO)/R)

Connect the audio output signal from video equipment connected to ④ or ⑥ to these jacks (p.23). For a mono audio signal (a single audio jack), connect to the Mono input jack.

⑧ AUDIO 2 JACK

Connect the audio output (stereo) signal from a computer or video equipment connected to ① to this jack (pp.22–24).

⑨ AUDIO 1 JACK

Connect the audio output (stereo) signal from a computer or video equipment connected to ② or ③ to this jack (pp.22, 24).

Rear Terminal

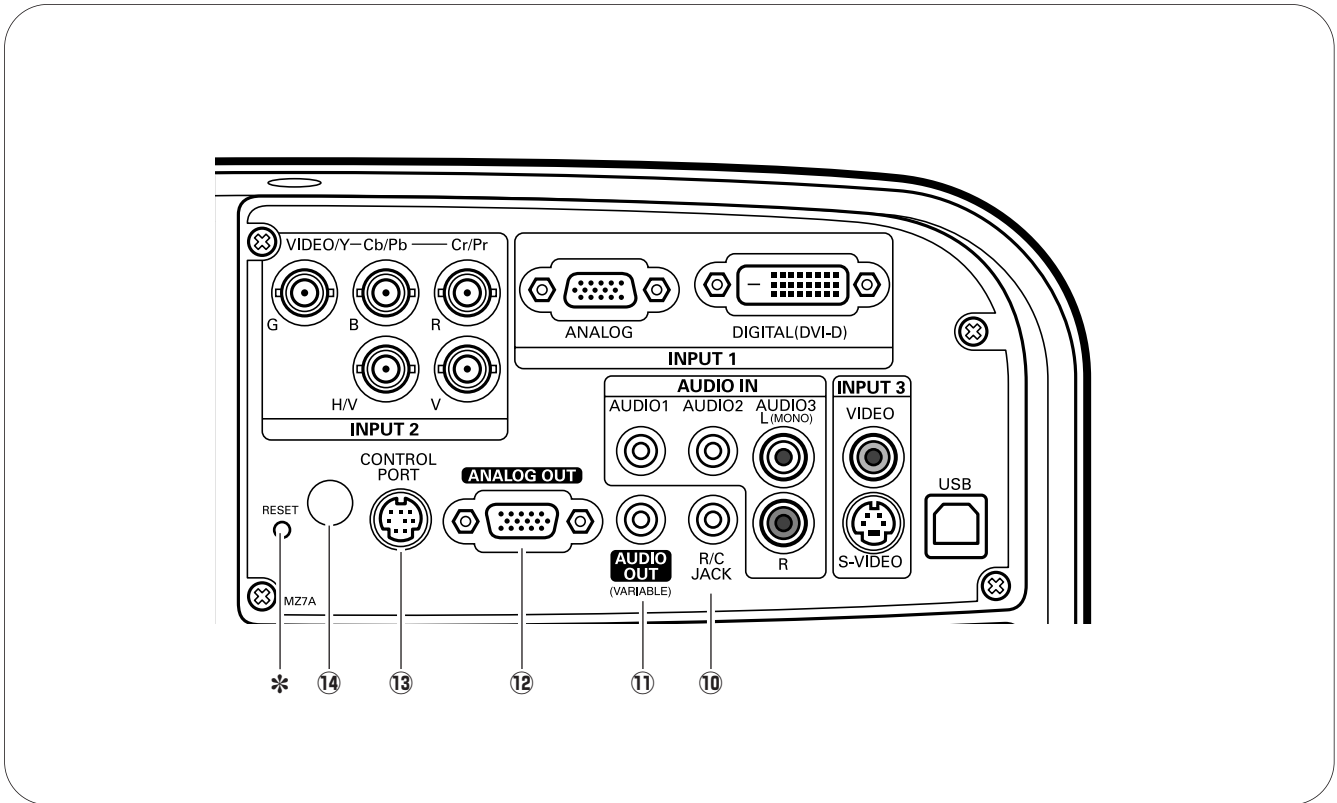

⑩ R/C JACK

When using the wired remote control, connect the wired remote control to this jack with a remote control cable (not supplied).

⑪ AUDIO MONITOR OUTPUT JACK (VARIABLE)

This jack outputs the audio signal from computer or video equipment to external audio equipment (pp.22–24).

⑫ MONITOR OUTPUT TERMINAL (ANALOG)

This terminal outputs the video signal from computer to external video equipment (pp.22, 24).

⑬ CONTROL PORT CONNECTOR

When controlling the projector from a computer, connect the computer to this connector with a control cable.

⑭ Infrared Remote Receiver (Back)

The infrared remote receiver is also located in the front (pp.10, 18).

* RESET button

A built-in micro processor which controls this unit may occasionally malfunction and need to be reset. This can be done by pressing the RESET button with a pen, which will shut down and restart the unit. Do not use the RESET function excessively.

Top Control

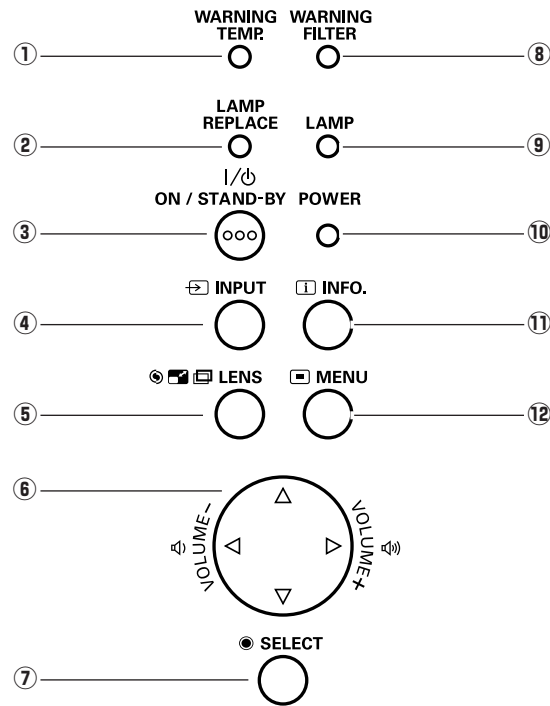

- ① WARNING TEMP. indicator**
Blinks red when the internal temperature of the projector exceeds the operating range (pp.67, 73).
- ② LAMP REPLACE indicator**
Lights yellow when the projection lamp reaches its end of life (pp.65, 74).
- ③ ON/STAND-BY button**
Turn the projector on or off (pp.25–26).
- ④ INPUT button**
Select an input source (pp.34–35).
- ⑤ LENS button**
Enter the focus, zoom, and lens shift adjustment mode (p.29).
- ⑥ POINT ▲▼◀▶ (VOLUME +/-) buttons**
 - Select an item or adjust the value in the On-Screen Menu (p.27).
 - Pan the image in Digital zoom + mode (p.51).
 - Adjust the volume level (Point ◀▶ buttons) (p.30).
- ⑦ SELECT button**
 - Execute the selected item (p.27).
 - Expand or compress the image in the Digital zoom mode (p.51).
- ⑧ WARNING FILTER indicator**
 - Blinks orange indicating the filter needs cleaning.
 - Lights orange when clogging of the filter is detected, urging immediate cleaning.
- ⑨ LAMP indicator**
Lights red during operations.
- ⑩ POWER indicator**
 - Lights when in stand-by mode and during operations.
 - Blinks during the cooling-off period.
 - Blinks in the Power management mode (p.58).
- ⑪ INFO. button**
Display the input source information (p.29).
- ⑫ MENU button**
Open or close the On-Screen Menu (p.27).

✓ Note:

- All five indicators on the top control blinks when the projector detects an abnormal condition.

Remote Control

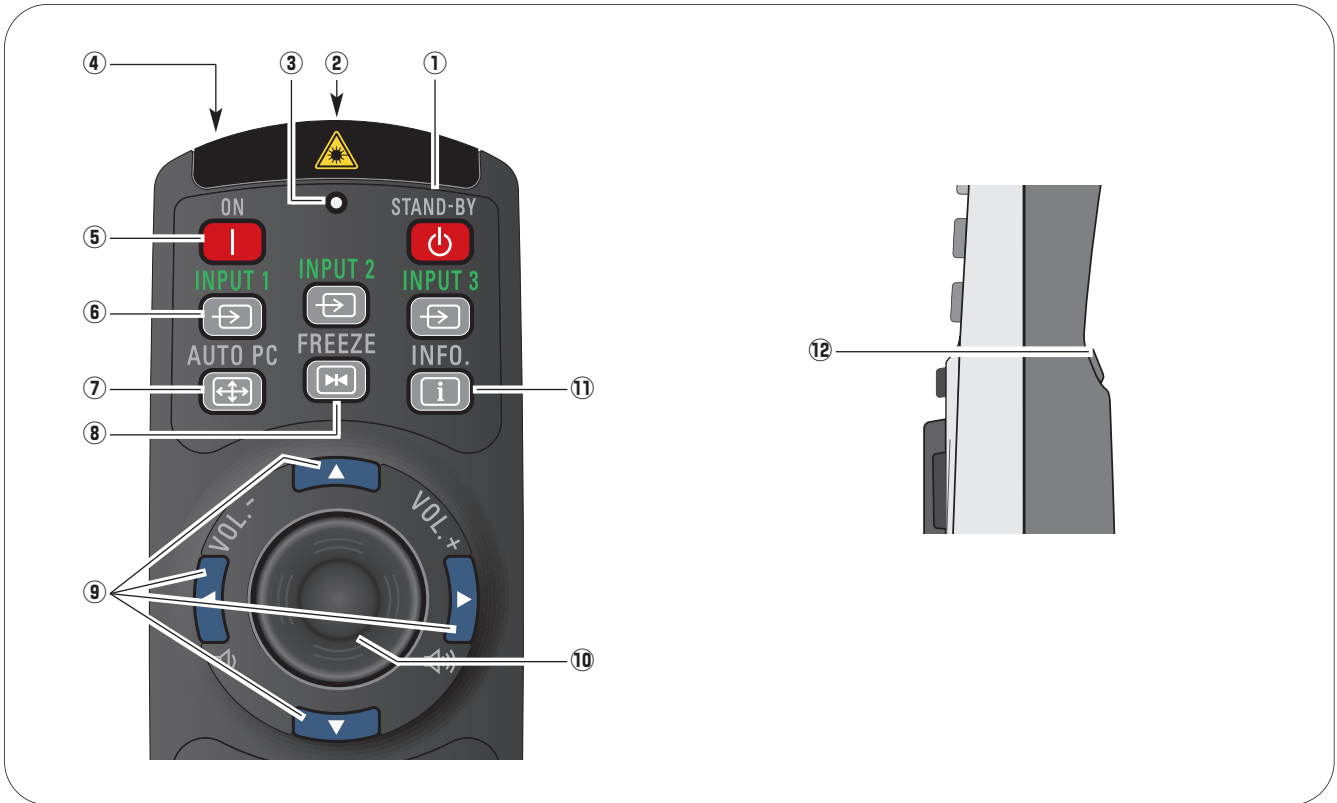

① STAND-BY button

Turn the projector off (p.26).

② WIRED REMOTE jack

Connect the remote control cable (not supplied) to this jack when using as a wired remote control.

③ SIGNAL EMISSION indicator

Lights red while the laser beam is being emitted from the laser light window or a signal is being sent from the remote control to the projector (p.16).

④ LASER LIGHT WINDOW

A laser beam is emitted from here (p.16).

⑤ ON button

Turn the projector on (p.25).

⑥ INPUT 1 – 3 buttons

Select a input source (INPUT 1 – INPUT 3) (pp.34–35).

⑦ AUTO PC button

Automatically adjusts the computer image to its optimum setting (pp.31, 39).

⑧ FREEZE button

Freeze the picture on the screen (p.31).

⑨ POINT ▲▼◀▶ (VOLUME +/-) buttons

- Select an item or adjust the value in the On-Screen Menu (p.27).
- Pan the image in Digital zoom + mode (p.51).
- Adjust the volume level (with Point ◀▶ buttons) (p.30).

⑩ PRESENTATION POINTER BUTTON

Move a pointer of the projector or a pointer for wireless mouse operation (pp.16–17).

⑪ INFO. button

Display the input source information (p.29).

⑫ L-CLICK button

Acts as left mouse button for wireless mouse operation (p.17).



To ensure safe operation, observe the following precautions:

- Do not bend, drop, or expose the remote control to moisture or heat.
- For cleaning, use a soft dry cloth. Do not apply benzene, thinner, splay, or any other chemical materials.

Remote Control

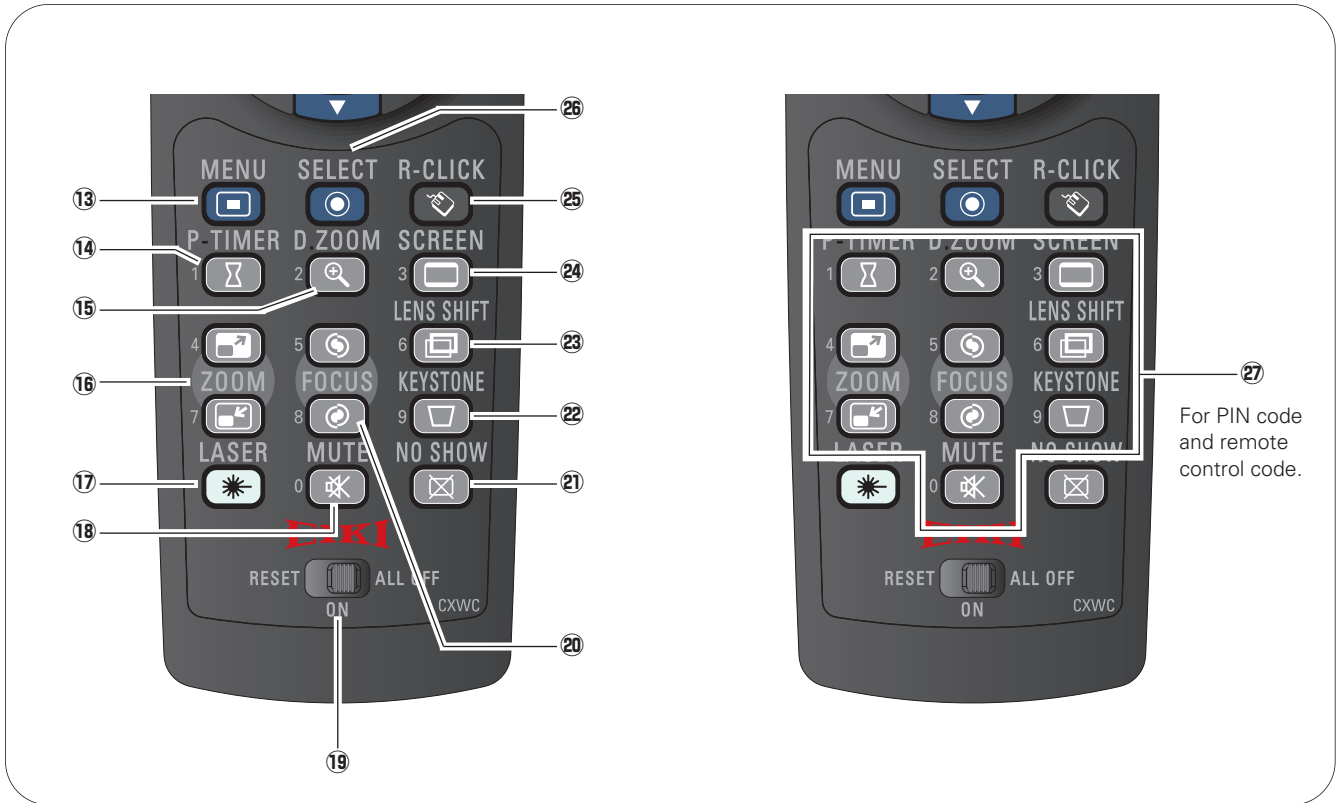

13 MENU button

Open or close the On-Screen Menu (p.27).

14 P-TIMER button

Operate the P-timer function (p.32).

15 D.ZOOM button

Select the Digital zoom +/- mode and resize the image (p.51).

16 ZOOM ▲▼ buttons

Zoom in and out the images (p.31).

17 LASER button

–Operate the Laser pointer function. Laser beam is emitted while pressing this button for one minute. When using the laser pointer for more than one minute, release the LASER button and press it again (p.16).
–Display the Pointer on the screen (p.16).

18 MUTE button

Mute the sound (p.30).

19 RESET/ON/ALL-OFF switch

When using the remote control, set this switch to “ON.” Set it to “ALL OFF” for power saving when it is not in use. Slide this switch to “RESET” to initialize the remote control code or switch the Spotlight and Pointer to the Laser pointer function (pp.16–17).

20 FOCUS button

Adjust the focus (p.31).

21 NO SHOW button

Temporarily turn off the image on the screen (p.32).

22 KEYSTONE button

Correct keystone distortion (p.32).

23 LENS SHIFT button

Select the Lens Shift function (p.31).

24 SCREEN button

Select the screen size (p.31).

25 R-CLICK button

Acts as right mouse button for wireless mouse operation (p.17).

26 SELECT button

–Execute the selected item (p.27).
–Expand or compress the image in the Digital zoom mode (p.51).

27 NUMBER buttons

Act as number buttons. Use these buttons when setting the remote control codes (p.17) or when entering the PIN code numbers (pp. 25, 56–57, 60–61).

Laser Pointer Function

This remote control emits a laser beam from the laser light window. Press the LASER button to activate the laser pointer. The signal emission indicator lights red and the red laser beam is emitted. If the LASER button is pressed for more than one minute or if it is released, the laser light goes off.

The laser emitted is a Class II laser. Do not look into the laser light window or point the laser beam at yourself or other people. The following is the caution label for the laser beam.

CAUTION: Use of controls, adjustments or performance of procedures other than those specified herein may result in hazardous radiation exposure. Never look directly into the laser light window while a laser is emitted, otherwise eye damage may result.

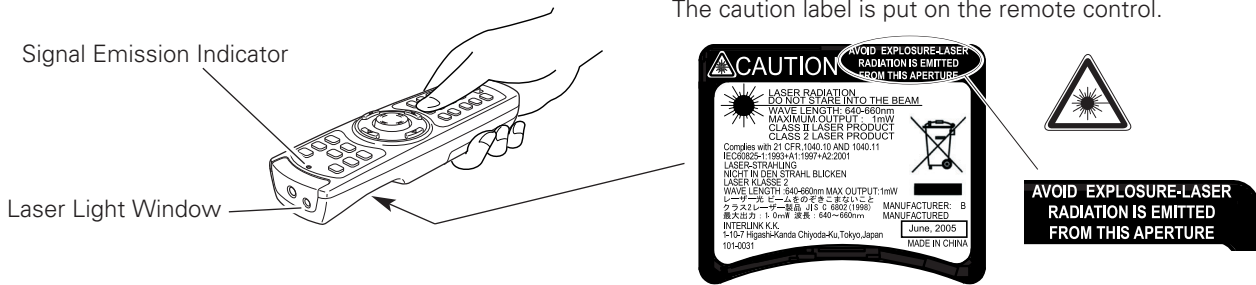

Pointer Function

You can move the Spotlight or Pointer of the projector with the remote control to emphasize a part of the projected image.

- 1 Press and hold the MENU and NO SHOW buttons for more than 10 seconds to activate the Pointer function. (The Laser pointer has switched to the Pointer function.)
- 2 Press the LASER button on the remote control pointing toward the projector. The Spotlight or Pointer is displayed on the screen with the LASER button lighting green. Then move the Spotlight or Pointer with the PRESENTATION POINTER button. If the LASER button does not light green and continues to emit a laser beam, try the abovementioned procedure until the LASER button lights green.
- 3 To clear the Spotlight or Pointer out the screen, press the LASER button pointing toward the projector and see if the LASER button lighting is turned off. To switch to the Laser pointer again, press and hold the NO SHOW and MENU buttons for more than 10 seconds or slide the RESET/ON/ALL-OFF switch to "RESET" and then to "ON". When you reset the Pointer function, the remote control code will be reset, as well.

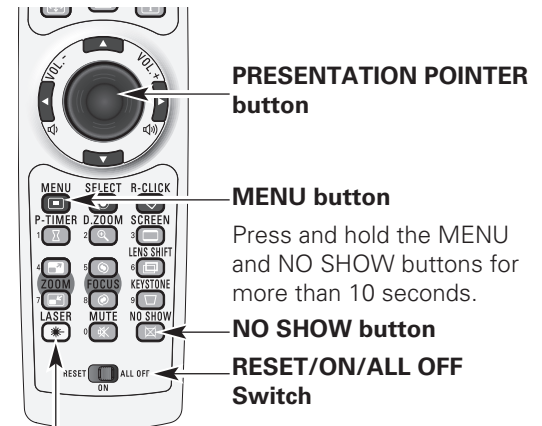

LASER button

After the Laser pointer has switched to the Pointer, use the LASER button as the Pointer function ON-OFF switch. Press the LASER button pointing toward the projector and see if it lights green.

Spotlight

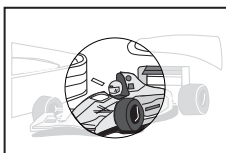

Pointer

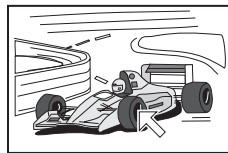

✓ **Note:**

- You can choose the size of Spotlight (Large/Middle/Small) and the pattern of Pointer (Arrow/Finger/Dot) in the Setting Menu. See "Pointer" on page 54.

Wireless Mouse Operation

The remote control can be used as a wireless mouse for your computer. Before operating the wireless mouse, connect your computer and the projector with the supplied USB cable. (See page 22 for connection.) When the Pointer function is used, the wireless mouse is not available.

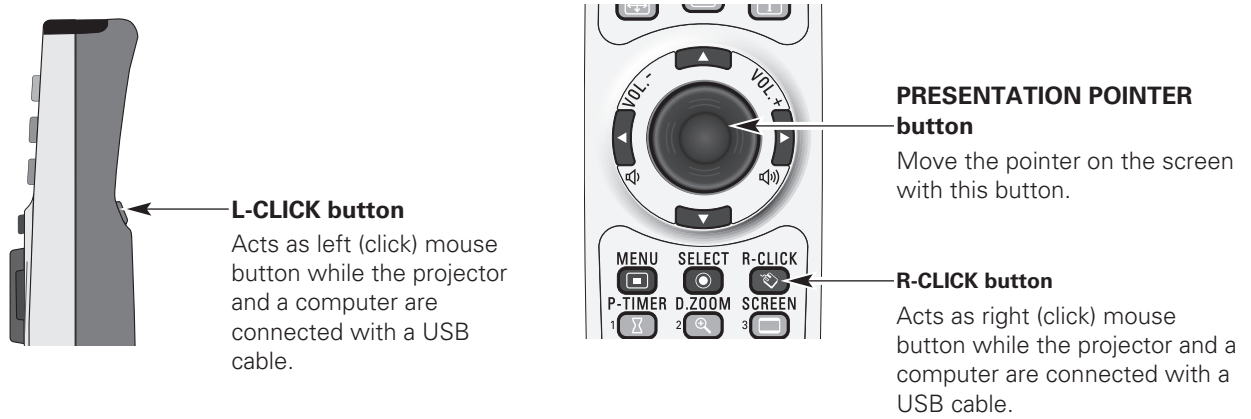

Remote Control Code

The eight different remote control codes (Code 1–Code 8) are assigned to this projector. Switching the remote control codes prevents interference from other remote controls when several projectors or video equipment next to each other are operated at the same time. Change the remote control code for the projector first before changing that for the remote control. See “Remote control” in the Setting Menu on page 57.

- 1** Press and hold the MENU and a number button (1–8) for more than five seconds to switch between the codes.
- 2** To initialize the remote control code, slide the RESET/ON/ALL-OFF switch to “RESET,” and then to “ON.” The initial code is set to Code 1.

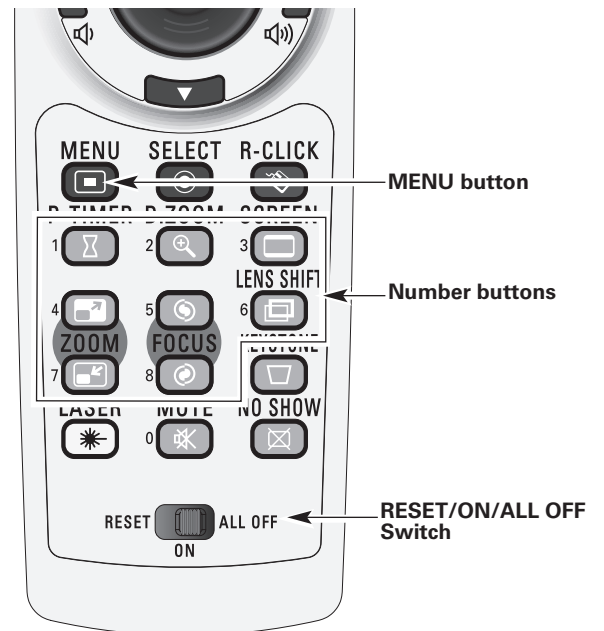

Press and hold the MENU and a number button (1–8) that corresponds to the remote control code for more than five seconds to switch between the codes.

Remote Control Battery Installation

- 1** Open the battery compartment lid.

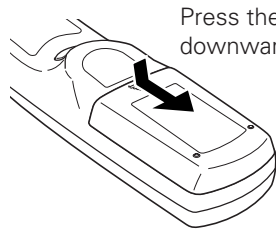

- 2** Install new batteries into the compartment.

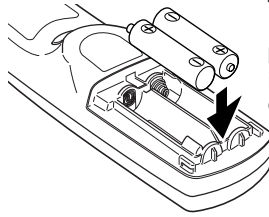

Two AAA size batteries

For correct polarity (+ and -), be sure battery terminals are in contact with pins in the compartment.

- 3** Replace the compartment lid.

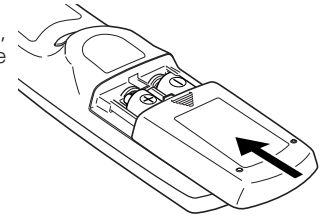

To insure safe operation, please observe the following precautions :

- Use two (2) AAA or LR03 type alkaline batteries.
- Always replace batteries in sets.
- Do not use a new battery with a used battery.
- Avoid contact with water or liquid.
- Do not expose the remote control to moisture or heat.
- Do not drop the remote control.
- If the battery has leaked on the remote control, carefully wipe the case clean and install new batteries.
- Risk of an explosion if battery is replaced by an incorrect type.
- Dispose of used batteries according to the instructions.

Remote Control Receivers and Operating Range

Point the remote control toward the projector (to Infrared Remote Receivers) when pressing the buttons. Maximum operating range for the remote control is about 16.4' (5 m) and 60 degrees in front and rear of the projector.

Infrared Remote Receivers are provided both in front and back of the projector. You can conveniently use both of the receivers (see pages 10, 57).

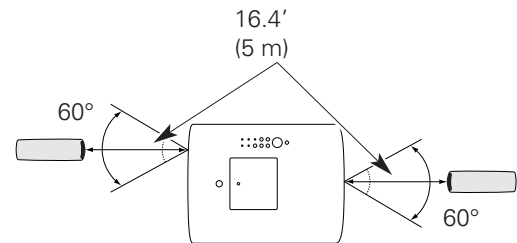

Adjustable Feet

Projection angle can be adjusted up to 5.0 degrees with the adjustable feet.

Rotate the adjustable feet and tilt the projector to the proper height; to raise the projector, rotate the both feet clockwise.

To lower the projector or to retract the adjustable feet, rotate the both feet counterclockwise.

To correct keystone distortion, press the KEYSTONE button on the remote control or select Keystone from the menu (see pages 15, 32, 50).

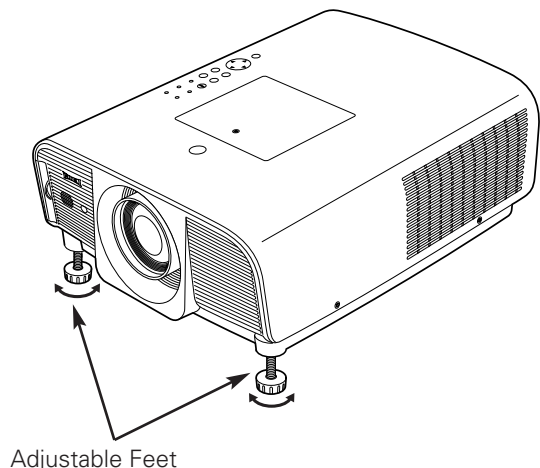

Installation

Lens Installation

When replacing the lens or using an optional lens, install the lens by following the instructions below. Ask the sales dealer for detailed information of the optional lens specifications.

Attaching the lens to the projector

- 1** Remove the lens mount cover.
- 2** Fit the lens to the projector by aligning the red dot on the lens with the red dot of the projector.
- 3** Slowly turn the lens clockwise until it clicks. Make sure that the lens is fully inserted to the projector.



CAUTION

Do not press the lens release button when attaching the lens.

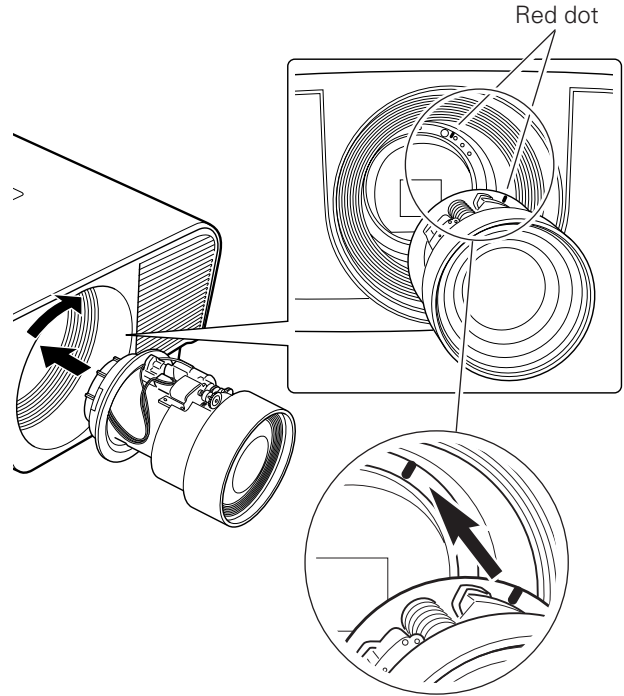

Removing the lens

- 1** Shift the lens to the center position by using the Lens shift function (see page 29).
- 2** While pressing the Lens release button on the top of the cabinet, turn the lens counterclockwise until it stops and pull it out slowly from the projector.



CAUTION

Be careful when handling the lens. Do not drop.

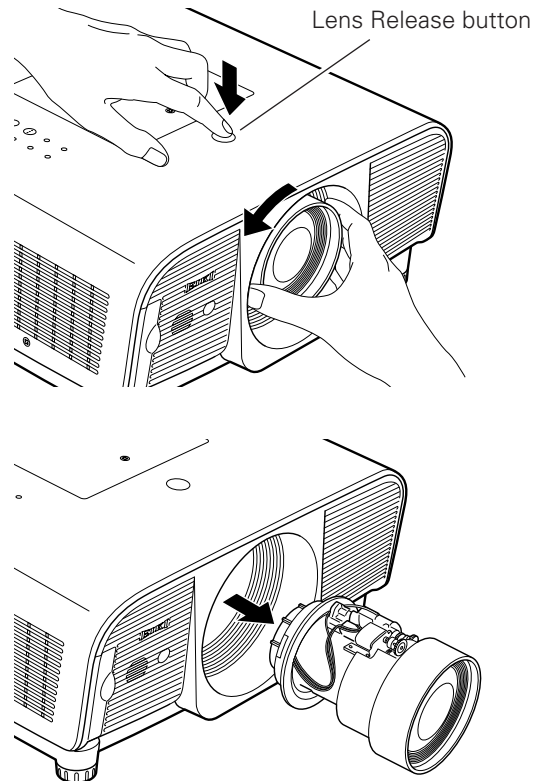

Positioning the Projector (for LC-XG300/XG250)

For projector positioning, see the figures below. The projector should be set perpendicularly to the plane of the screen.

✓Notes:

- The brightness in the room has a great influence on picture quality. It is recommended to limit ambient lighting in order to obtain the best image.
- All measurements are approximate and may vary from the actual sizes.

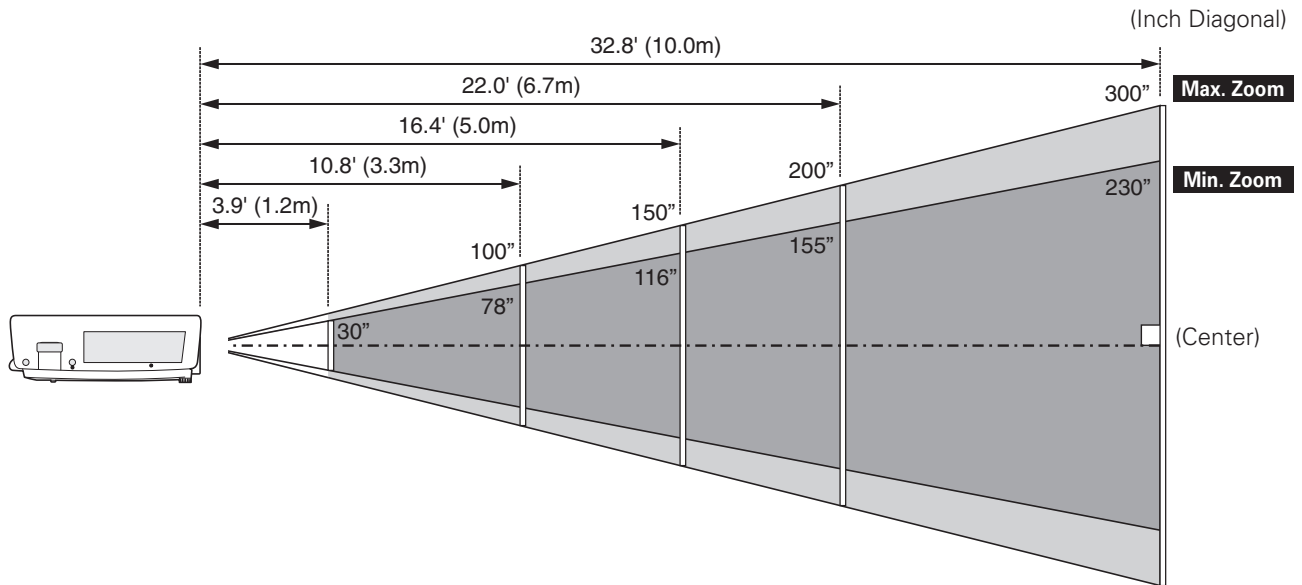

Screen Size (W x H) mm 4:3 aspect ratio	30"	100"	150"	200"	300"
Zoom (min.)	3.9' (1.2 m)	14.1' (4.3 m)	21.3' (6.5 m)	28.5' (8.7 m)	—
Zoom (max.)	—	10.8' (3.3 m)	16.4' (5.0 m)	22.0' (6.7 m)	32.8' (10.0 m)

Moving the Lens

For details about the Lens shift function, refer to "Lens Shift Adjustment" on page 29. The amount of lens shift range varies depending on the lens. The figures below are for LC-XG300/XG250.

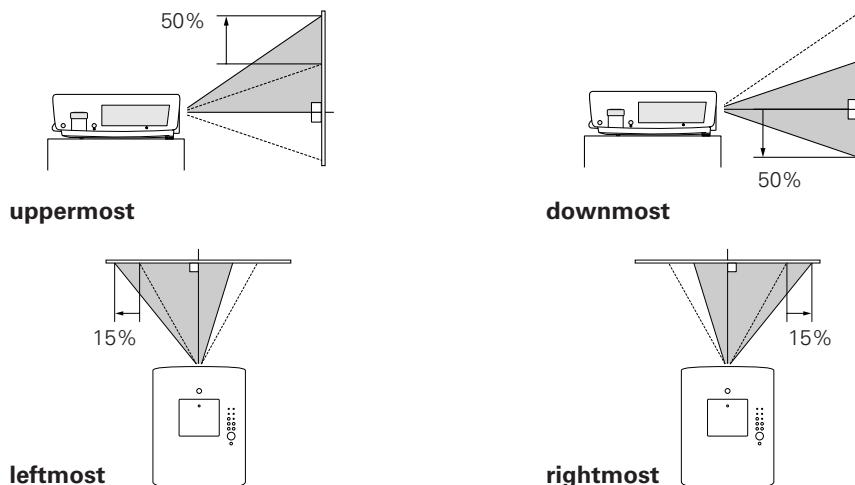

Connecting the AC Power Cord

This projector uses nominal input voltages of 100–120 V or 200–240 V AC and it automatically selects the correct input voltage. It is designed to work with single-phase power systems having a grounded neutral conductor. To reduce the risk of electrical shock, do not plug into any other type of power system.

If you are not sure of the type of power being supplied, consult your authorized dealer or service station. Connect the projector with all peripheral equipment before turning the projector on.

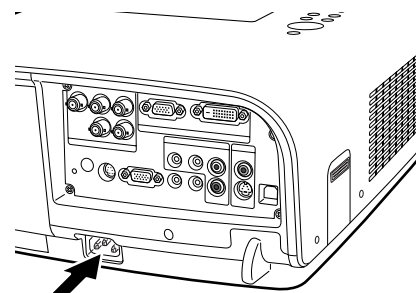

Connect the AC power cord (supplied) to the projector. The AC outlet must be near this equipment and must be easily accessible.

 **CAUTION**

For safety, unplug the AC power cord when the projector is not in use. When the projector is connected to an outlet with the AC power cord, it is in stand-by mode and consumes a little electric power.

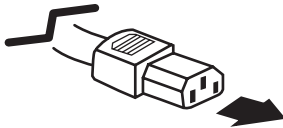
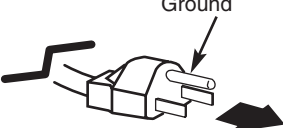
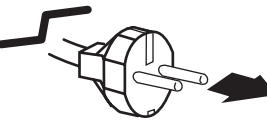
NOTE ON POWER CORD		
AC power cord must meet the requirements of the country where you use the projector. Confirm the AC plug type with the chart below and a proper AC power cord must be used. If the supplied AC power cord does not match your AC outlet, contact your sales dealer.		
Projector side	AC Outlet side	
 <p>To POWER CORD CONNECTOR on your projector.</p>	For the U.S.A. and Canada  <p>To the AC Outlet. (120 V AC)</p>	For Continental Europe  <p>To the AC Outlet. (200 - 240 V AC)</p>

Connecting to a Computer (Digital and Analog RGB)

Cables used for connection

- VGA Cable (HDB 15 pin)*
- DVI-Digital Cable
- BNC Cable
- USB Cable
- Audio Cables (Mini Plug [stereo] x 2)

(*One cable is supplied; other cables are not supplied with the projector.)

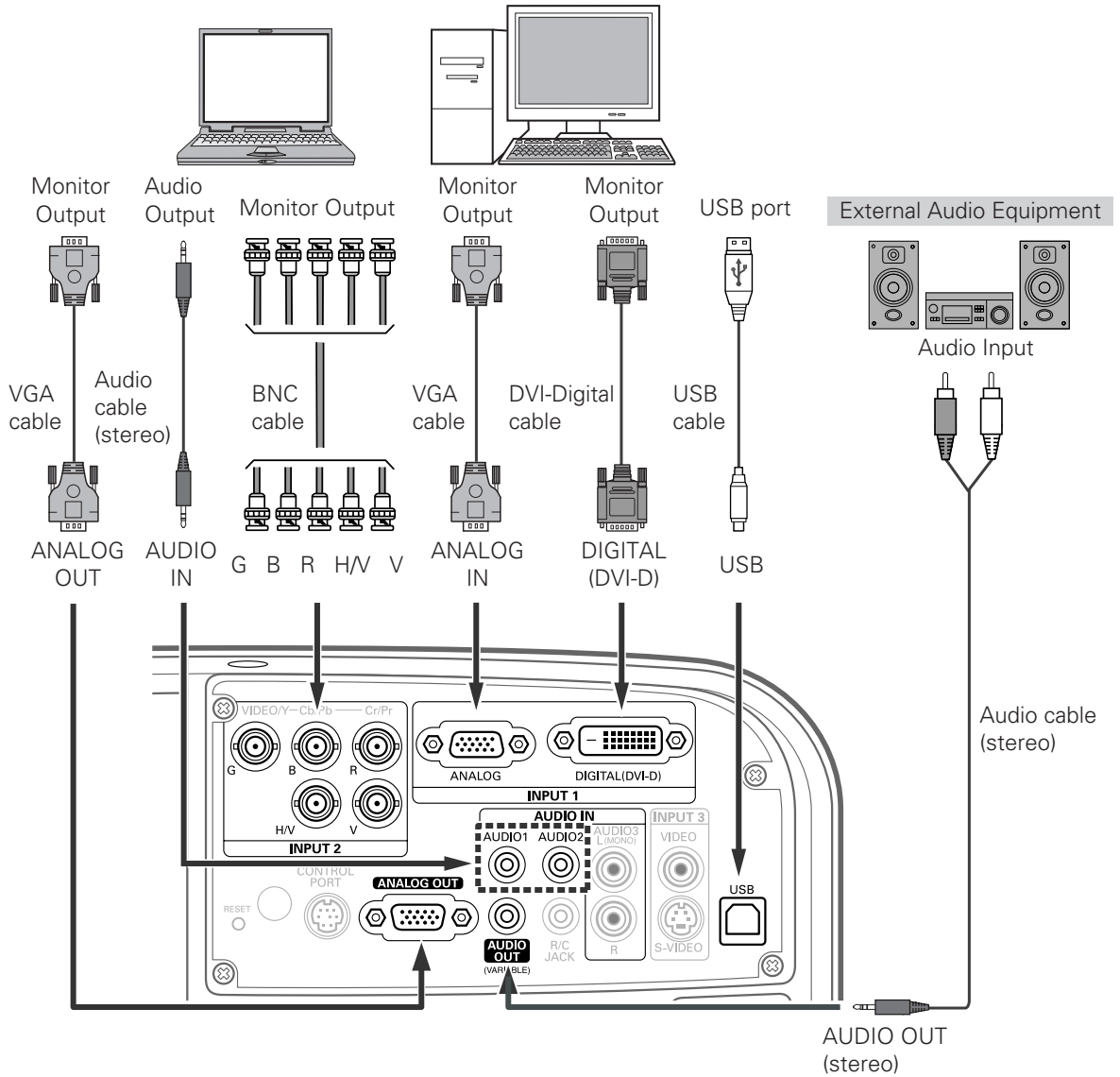

Notes:

- When connecting the AUDIO OUT to external audio equipment, the projector's built-in speaker is disconnected.
- USB cable connection is needed when operating the computer with the remote control.
- See page 78 for ordering optional cables.



Unplug the power cords of both the projector and external equipment from the AC outlet before connecting cables.

Connecting to Video Equipment (Video, S-Video)

Cables used for connection

- Video Cables (RCA x 1)
 - S-VIDEO Cable
 - Audio Cable (RCA x 2)
 - Audio Cables (Mini Plug [stereo] x 2)
 - BNC Cable
- (Cables are not supplied with the projector.)

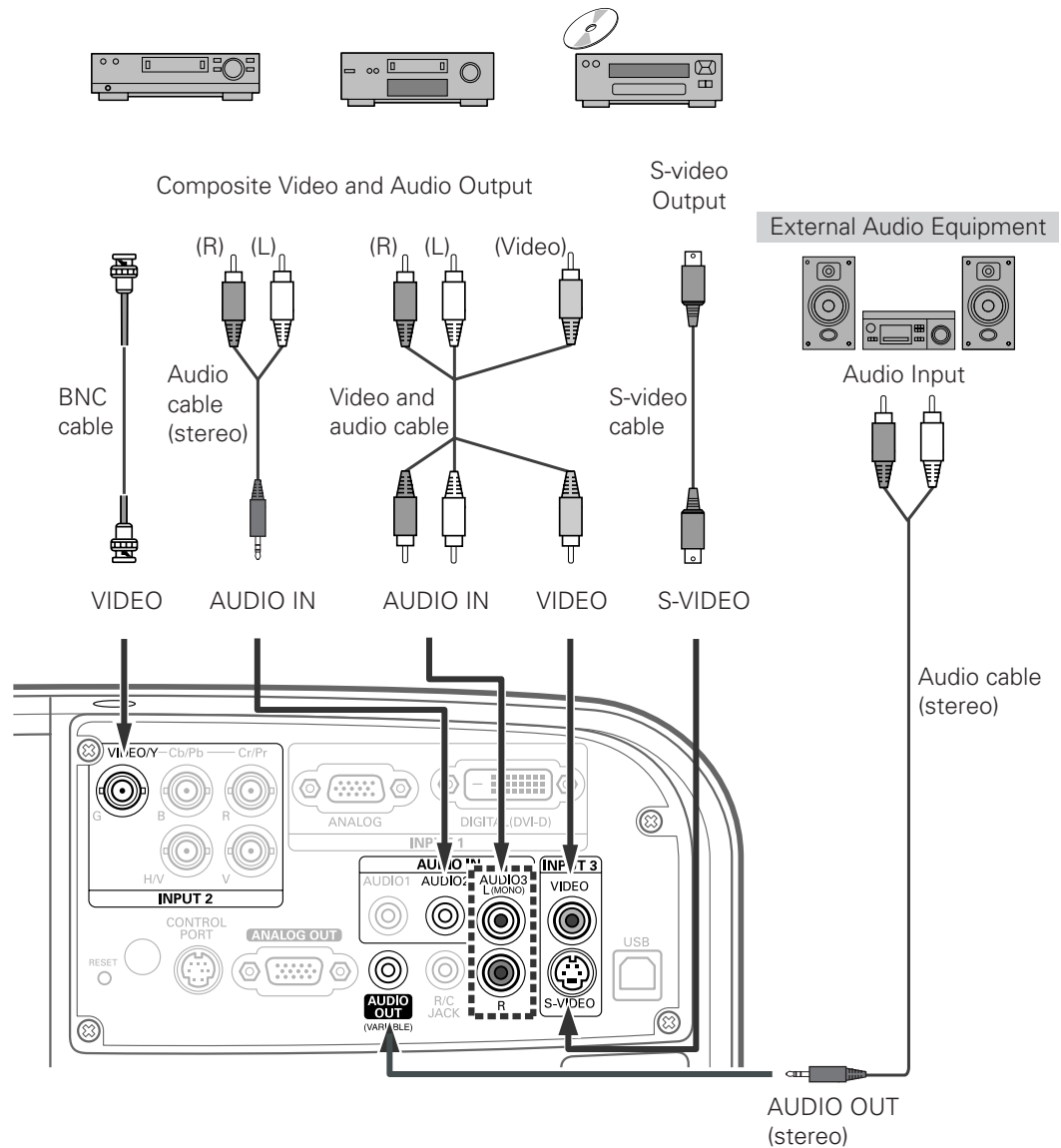

Notes:

- When connecting the AUDIO OUT to external audio equipment, the projector's built-in speaker is disconnected.
- The S-VIDEO jack connection overrides the VIDEO jack connection when selecting AUTO in the Input Menu (p.35).
- See page 78 for ordering optional cables.



Unplug the power cords of both the projector and external equipment from the AC outlet before connecting cables.

Connecting to Video Equipment (Component and RGB Scart)

Cables used for connection

- Audio Cables (Mini Plug [stereo] x 2)
 - Scart-VGA Cable
 - BNC Cable
 - DVI-Digital Cable
- (Cables are not supplied with the projector.)

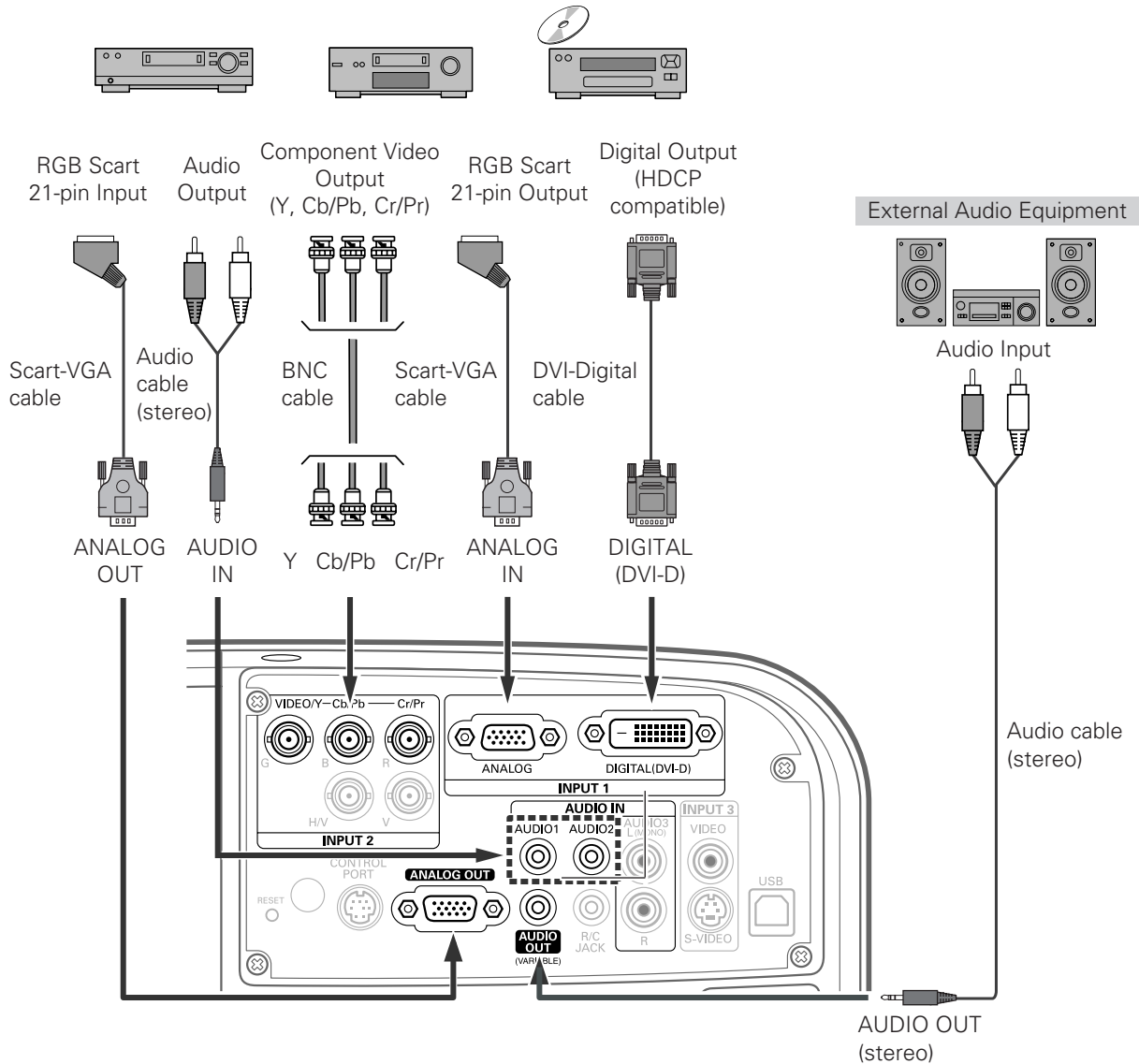

Notes:

- When connecting the AUDIO OUT to external audio equipment, the projector's built-in speaker is disconnected.
- See page 78 for ordering optional cables.



Unplug the power cords of both the projector and external equipment from the AC outlet before connecting cables.

Basic Operation

Turning On the Projector

- 1 Complete peripheral connections (with a computer, VCR, etc.) before turning on the projector.
- 2 Connect the projector's AC power cord into an AC outlet. The POWER indicator lights green.
- 3 Press the ON/STAND-BY button on the top control or the ON button on the remote control. The LAMP indicator lights red and the cooling fans start to operate. The preparation display appears on the screen and the count down starts.
- 4 After the countdown, the input source that was selected the last time and the lamp control status icon (see page 54) appear on the screen.

If the projector is locked with a PIN code, PIN code input dialog box will appear. Enter the PIN code as instructed below.

Enter a PIN code

Use the Point ▲▼ buttons or Number buttons on the remote control to enter a number. Press the Point ► button to fix the number and move the red frame pointer to the next box. The number changes to “*.” If you fixed an incorrect number, use the Point ◀ button to move the pointer to the number you want to correct, and then enter the correct number.

Repeat this step to complete entering a four-digit number.

After entering the four-digit number, move the pointer to “Set.” Press the SELECT button so that you can start to operate the projector.

If you entered an incorrect PIN code, “PIN code” and the number (****) will turn red for a moment. Enter the correct PIN code all over again.

What is PIN code?

PIN (Personal Identification Number) code is a security code that allows the person who knows it to operate the projector. Setting a PIN code prevents unauthorized use of the projector.

A PIN code consists of a four-digit number. Refer to the PIN code lock function in the Setting Menu on pages 60–61 for locking operation of the projector with your PIN code.



CAUTION ON HANDLING PIN CODE

If you forget your PIN code, the projector can no longer be started. Take a special care in setting a new PIN code; write down the number in a column on page 81 of this manual and keep it at hand. Should the PIN code be missing or forgotten, consult your dealer or service center.



The preparation display will disappear after 30 seconds.

Selected Input Source and Lamp Control



See page 54 for the Lamp control status.

✓Note:

- The Filter warning and Lamp replacement icons may appear on the screen depending on the usage state of the projector.

PIN Code Input Dialog Box

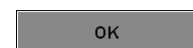
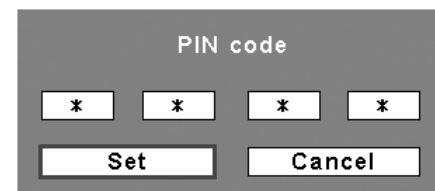

After the OK icon disappears, you can operate the projector.

✓Notes:

- When the Logo select function is set to “Off,” the logo will not be shown on the screen (p.55).
- When the “Countdown off” or “Off” is selected in the Display function, the countdown will not be shown on the screen (p.57).
- During the countdown period, all operations are invalid.
- If the correct PIN code number is not entered within three minutes after the PIN code dialog box appeared, the projector will be turned off automatically.
- The “1234” is set as the initial PIN code at the factory.

Turning Off the Projector

- 1** Press the ON/STAND-BY button on the top control or the STAND-BY button on the remote control, and “Power off?” appears on the screen.
- 2** Press the ON/STAND-BY button or the STAND-BY button on the remote control again to turn off the projector. The LAMP indicator turns off and the POWER indicator starts to blink green. After the projector is turned off, the cooling fans operate for 90 seconds. During the POWER indicator is blinking, you cannot turn on the projector.
- 3** When the projector has cooled down enough, the POWER indicator stops blinking and you can turn on the projector. After it is cooled down completely, unplug the AC power cord.

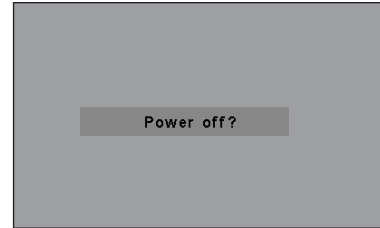

“Power off?” disappears after 4 seconds.



TO MAINTAIN LIFE OF THE LAMP, ONCE YOU TURN THE PROJECTOR ON, WAIT AT LEAST FIVE MINUTES BEFORE TURNING IT OFF. DO NOT UNPLUG THE AC POWER CORD WHILE THE COOLING FANS ARE RUNNING OR BEFORE THE POWER INDICATOR STOPS BLINKING. OTHERWISE IT WILL RESULT IN SHORTENING THE LAMP LIFE.

✓Notes:

- When the On start function is set to “On,” the projector will be turned on automatically by connecting the AC power cord to an AC outlet (p.58).
- Do not operate the projector continuously without rest. Continuous use may result in shortening the lamp life. Turn off the projector and let stand for about an hour in every 24 hours.
- The running speed of cooling fans is changed according to the temperature inside the projector.
- Do not put the projector in a case before the projector is cooled enough.
- If the WARNING TEMP. indicators blink or all the five indicators on the top panel blink, see “Warning Indicators” on page 67.
- While the POWER indicator is blinking, the lamp is being cooled down and the projector cannot be turned on. Wait until the POWER indicator stops blinking to turn on the projector again.

How to Operate the On-Screen Menu

The projector can be adjusted or set via the On-Screen Menu. For each adjustment and setting procedure, refer to the respective sections in this manual.

- 1 Press the MENU button on the top control or the remote control to display the On-Screen Menu.
- 2 Use the Point ◀▶ buttons to select a Menu icon. Use the Point ▲▼ buttons to select an item to in the selected menu.
- 3 Press the SELECT button to show the item data. Use the Point ◀▶ buttons to adjust the values.

To close the On-Screen Menu, press the MENU button again.

✓Note:

- The selected item is not active until the SELECT button is pressed.

Top Control

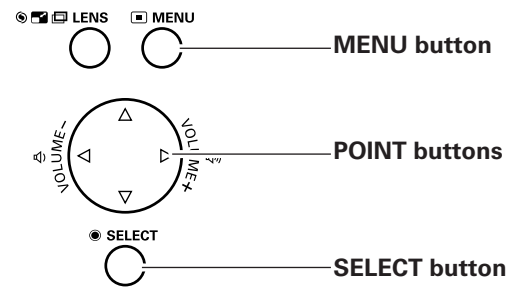

Remote Control

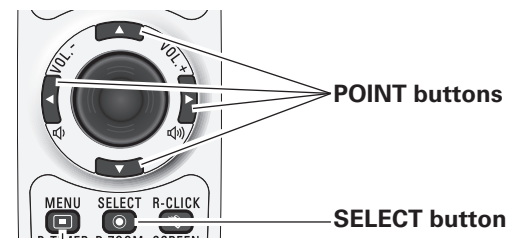

MENU button

On-Screen Menu

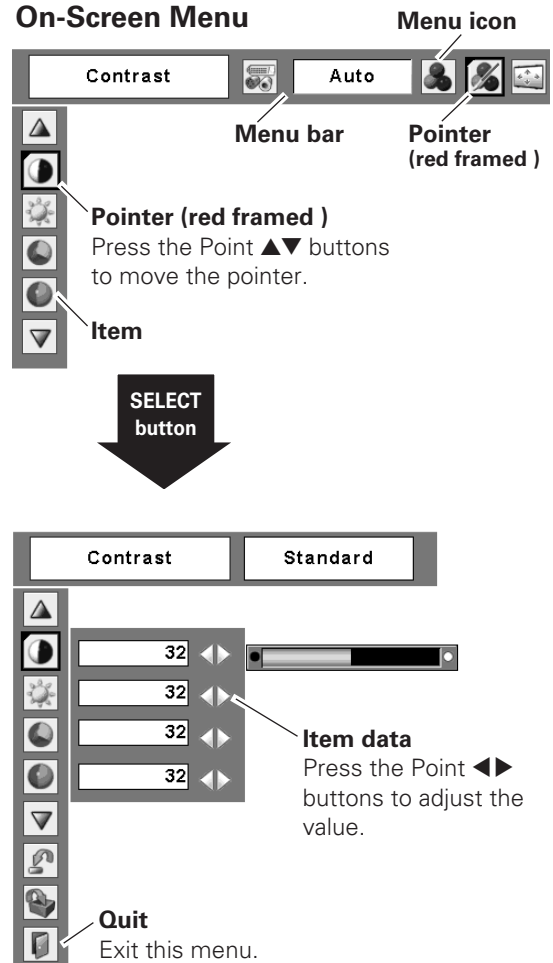

Menu Bar

For detailed functions of each menu, see “Menu Tree” on pages 71–72.

*The menu bar displays changes depending on the input signals.

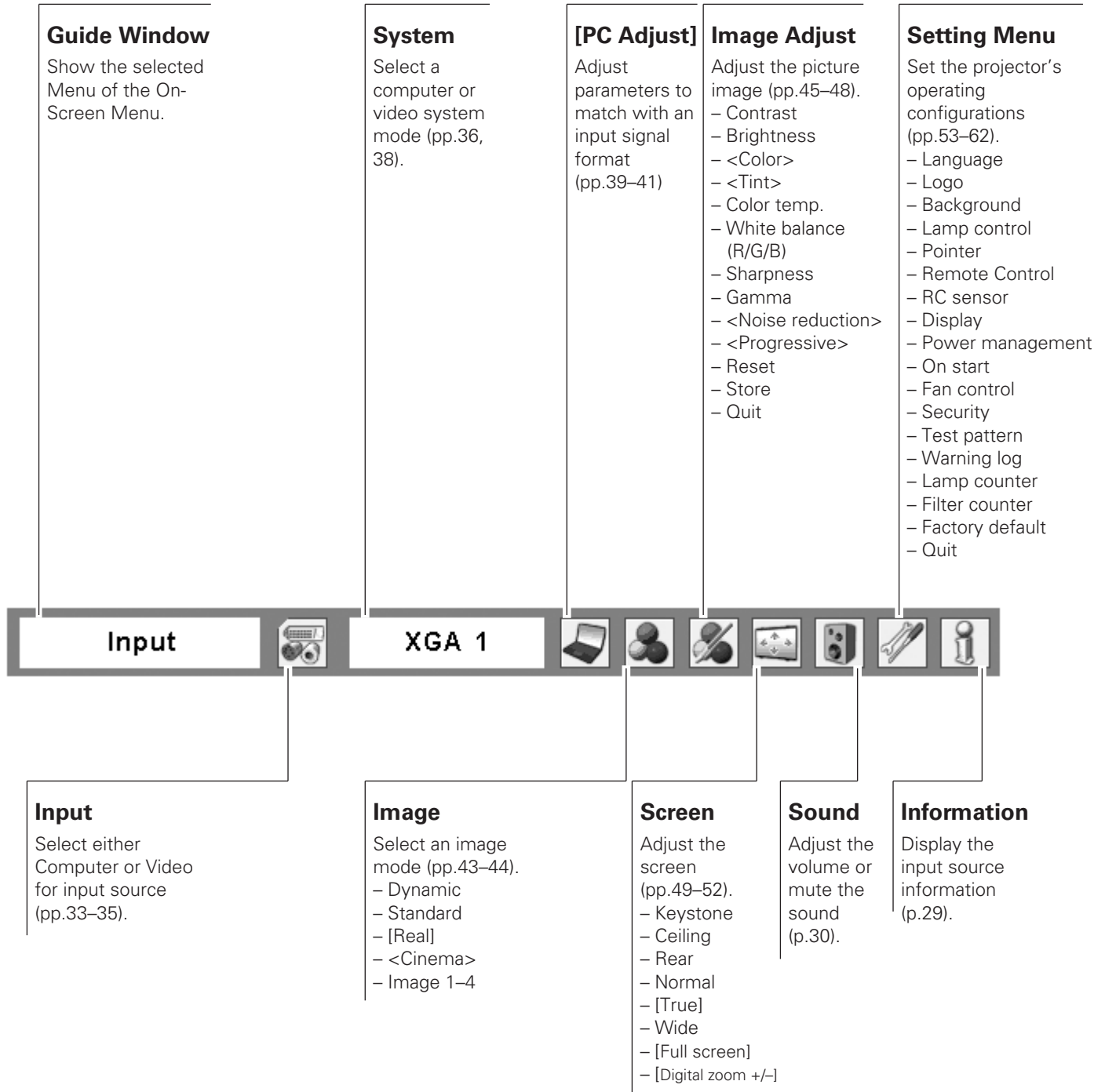

✓ **Note:**

[For PC input only.]
<For AV input only.>

Operating with Projector Control

Lens Operation

The following lens operation can be made with the Lens button on the top control.

Press the Lens button to enter each lens operation mode. The selected adjustment display appears on the screen.

ZOOM → FOCUS → LENS SHIFT → ZOOM →

Lens Shift Adjustment

Display "Lens shift" on the screen. Use the Point ▲▼◀▶ buttons to position the screen to the desired point without having picture distortion.

The screen can be moved up or down to 50 percent, or sideways up to 15 percent from the central axis of the lens shift.

✓Note:

- The arrow disappears at the maximum lens shift in each direction.

Zoom Adjustment

Display "Zoom" on the screen. Use the Point ▲▼ buttons to zoom in and out the image.

Focus Adjustment

Display "Focus" on the screen. Use the Point ▲▼ buttons to adjust focus of the image.

Information

Information display can be used to confirm the current operating condition of the projector and the signal being projected through the projector.

Press the INFO. button on the top control or remote control to display the information window on the screen. To hide the information window, press the INFO. button again or Point ◀▶ buttons.

The information window can also be selected from the menu.

Top Control

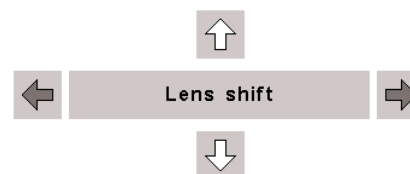
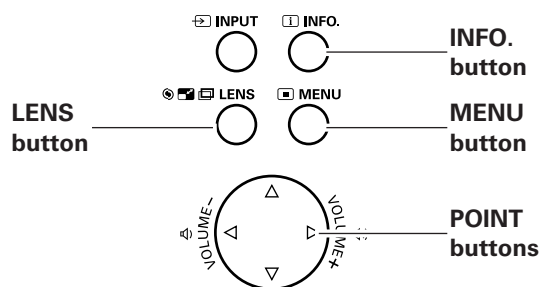

Information Menu



Information Menu

Input	Input 1
	RGB (PC Analog)
H-sync freq.	15.7 KHz
V-sync freq.	30.0 Hz
Screen	Normal
Language	English
Lamp status	
Power management	Ready 5 Min.
Security	Key lock
	PIN code lock Off
Remote control	Code 1

* The H- and V-sync freq. values described in this figure may be different from the actual values.

Sound Adjustment

Direct Operation

Volume

Press the VOLUME +/- buttons on the top control or on the remote control to adjust the volume. The volume dialog box appears on the screen for a few seconds.

Mute

Press the MUTE button on the remote control to temporarily turn off the sound. To turn the sound back on, press the MUTE button again or press the VOLUME +/- buttons. The Mute function is also effective for the AUDIO OUT jack.

Menu Operation

- 1 Press the MENU button to display the On-Screen Menu. Use the Point ◀▶ buttons to move the red frame pointer to the Sound Menu icon.
- 2 Use the Point ▲▼ buttons to move the red frame pointer to the desired item, and then press the SELECT button.

Volume

Press the Point ▶ button to turn up the volume; press the Point ◀ button to turn down the volume.

Mute

Press the Point ◀▶ buttons to switch the mute function On/Off. When the sound is turned off, "On" is displayed. Press the Point ◀▶ buttons again to turn the sound back on.

Top Control

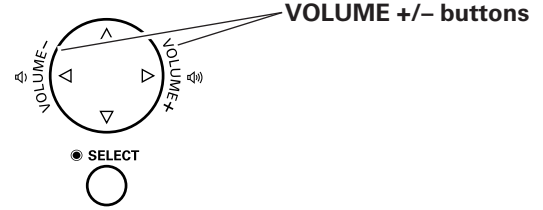

Remote Control

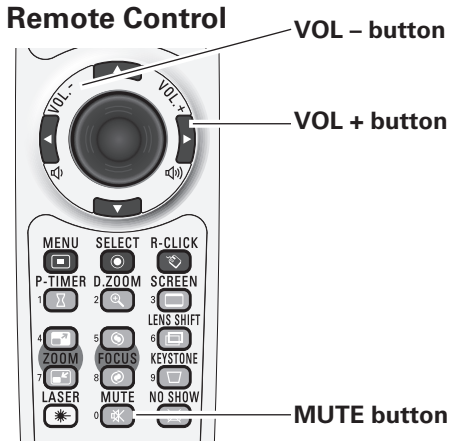

Volume Dialog Box

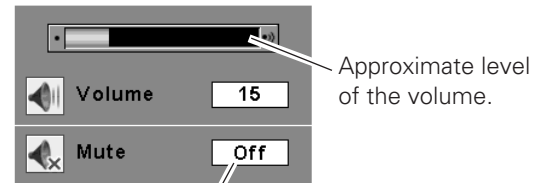

Press the MUTE button to set the Mute function On or Off. The dialog box disappears after 4 seconds.

Sound Menu

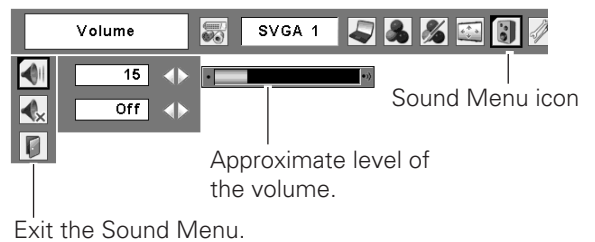

Operating with Remote Control

Using the remote control for some frequently used operations is advisable. Just pressing one of the buttons enables you to make the desired operation quickly without calling up the On-Screen Menu.

FREEZE button

Press the FREEZE button on the remote control to freeze the picture on the screen. To cancel the Freeze function, press the FREEZE button again or press any other button.

AUTO PC button

Press the AUTO PC button on the remote control to operate the Auto PC Adj. function. The computer screen adjustment can be done easily by pressing this button. See page 39 for details.

INFO. button

See page 29 for details.

D.ZOOM button

Press the D.ZOOM buttons on the remote control to enter to the Digital zoom +/- mode. See page 51 for details.

SCREEN button

Press the SCREEN buttons on the remote control to select the desired screen size. The selected screen size symbol appears on the screen for 4 seconds. See pages 51–52 for details.

LENS SHIFT button

See page 29 for details.

ZOOM buttons

Press the ZOOM buttons on the remote control to zoom in and out the image.

FOCUS buttons

Press the FOCUS buttons on the remote control to adjust focus of the image.

Remote Control

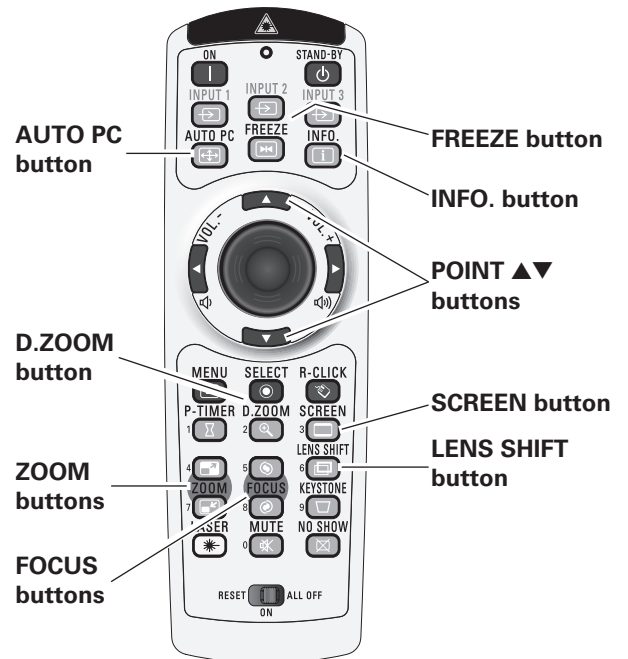

✓ **Note:**

- See the next page for the description of other buttons.

NO SHOW button

Press the NO SHOW button on the remote control to black out the image. To restore to normal, press the NO SHOW button again or press any other button.

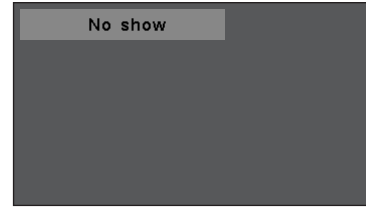

"No show" disappears after 4 seconds.

P-TIMER button

Press the P-TIMER button on the remote control. The P-Timer display "00:00" appears on the screen and the countdown starts (00:00–59:59).

To stop the countdown, press the P-TIMER button. To cancel the P-Timer function, press the P-TIMER button again.



P-Timer display

KEystone button

Press the KEystone button on the remote control. The "Keystone" appears on the screen.

Use the Point ▲▼ buttons to correct keystone distortion. The keystone adjustment can be stored (see page 50).

Reduce the upper width with the Point ▲ button.

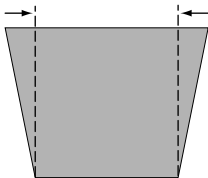

Reduce the lower width with the Point ▼ button.

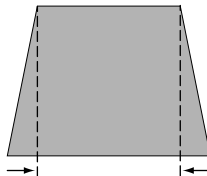

- The white arrows indicate that there is no correction.
- A red arrow indicates the direction of correction.
- An arrow disappears at the maximum correction.
- If you press the KEystone button on the remote control once more while the keystone dialog box is being displayed, the keystone adjustment will be canceled.

Remote Control

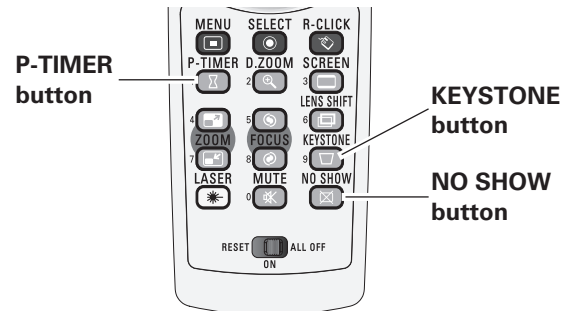

✓ Note:

- See the previous page for the description of other buttons.

Input Selection

Select the input signal of equipment connected to the projector.

This projector has three input options (INPUT 1, INPUT 2, and INPUT 3) and they are categorized by different signal type. Select an input source with the INPUT button on the top control or the INPUT 1–3 buttons on the remote control, or by On-Screen Menu.

Input Selection

Input

Remote Control

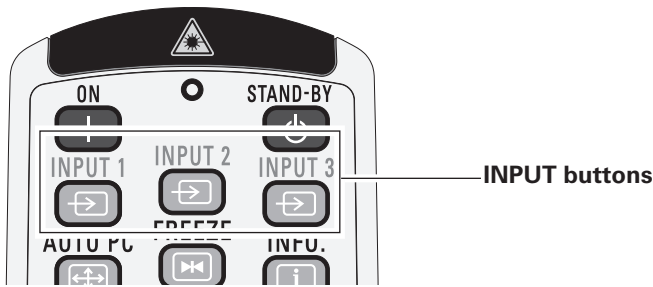

Remote Control Operation

Press the INPUT 1, INPUT 2, or INPUT 3 buttons on the remote control. The input source appears on the screen as you press each button. Select the connected input source.

Top Control

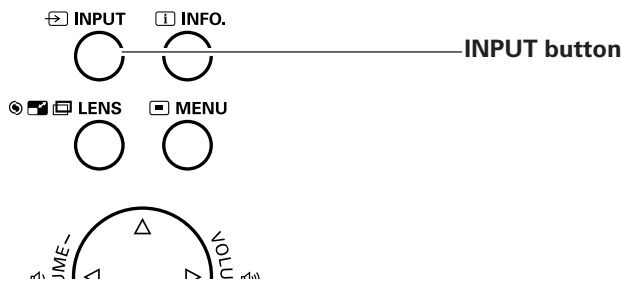

Top Control Operation

Press the INPUT button on the top control. It switches to INPUT 1, INPUT 2, and INPUT 3 as you press the INPUT button.

Before using the INPUT button on the top control, you must select a correct input source by On-Screen Menu and the latest input source will be displayed.

Remote Control button operation

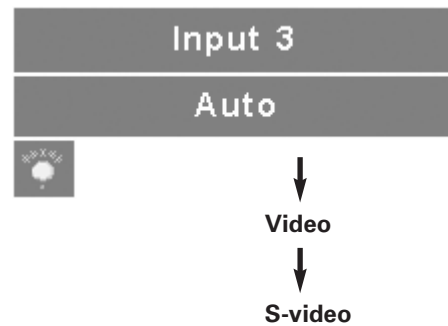
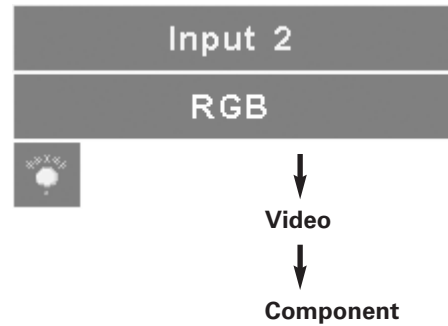
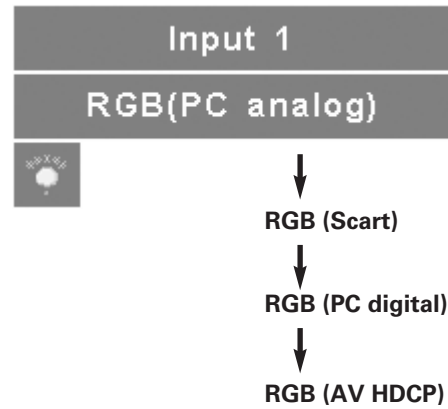

Input Source Selection

Menu Operation

- 1 Press the MENU button to display the On-Screen Menu. Use the Point ◀▶ buttons to move the red frame pointer to the Input Menu icon.
- 2 Use the Point ▲▼ buttons to move the red arrow pointer to the desired input and then press the SELECT button. The signal format menu appears.
- 3 Use the Point ▲▼ buttons to select the desired signal format and then press the SELECT button.

Input Menu

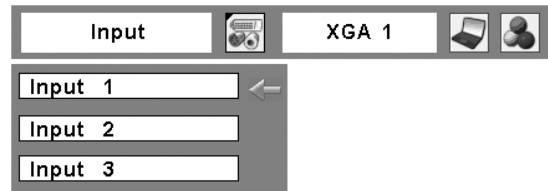

INPUT 1

- RGB (PC analog)** When the RGB PC (analog) signal is connected
- RGB (PC Scart)** When the RGB PC (scart) signal is connected
- RGB (PC digital)** When the RGB PC (digital) signal is connected.
- RGB (AV HDCP)** When the HDCP video signal is connected.

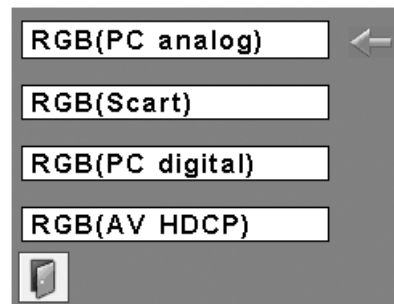

INPUT 2

- RGB** When the RGB PC signal is connected.
- Video** When the RGB video signal is connected.
- Component*** When the component signal is connected.

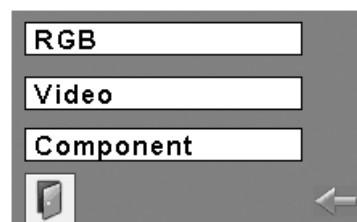

* If the projector cannot reproduce proper video image, select a system manually (see "Video System Selection" on page 36).

INPUT 3

- Auto** When selecting Auto, the projector automatically detects an incoming video signal and adjusts itself to optimize its performance. The projector selects the connection in the following order:
 1. S-video
 2. Video
- Video*** When the video signal is connected.
- S-video*** When the S-video signal is connected.

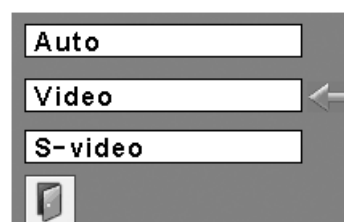

* If the projector cannot reproduce proper video image, select a system manually (see "Video System Selection" on page 36).

Video System Selection

- 1 Press the MENU button to display the On-Screen Menu. Use the Point ◀▶ buttons to move the red frame pointer to the AV System Menu icon.
- 2 Use the Point ▲▼ buttons to move the red arrow pointer to the desired system and then press the SELECT button.

Video or S-Video

Auto

The projector automatically detects an incoming video system, and adjusts itself to optimize its performance. When Video System is PAL-M or PAL-N, select the system manually.

PAL/SECAM/NTSC/NTSC4.43/PAL-M/PAL-N

If the projector cannot reproduce proper video image, select a specific broadcast signal format from among PAL, SECAM, NTSC, NTSC 4.43, PAL-M, and PAL-N.

Component

Auto

The projector automatically detects an incoming video signal, and adjusts itself to optimize its performance.

COMPONENT VIDEO SIGNAL FORMAT

If the projector cannot reproduce proper video image, select a specific component video signal format from among 480i, 575i, 480p, 575p, 720p, 1035i, and 1080i.

✓Note:

- The AV System Menu cannot be selected when selecting RGB (Scart).

AV System Menu (Video or S-Video)

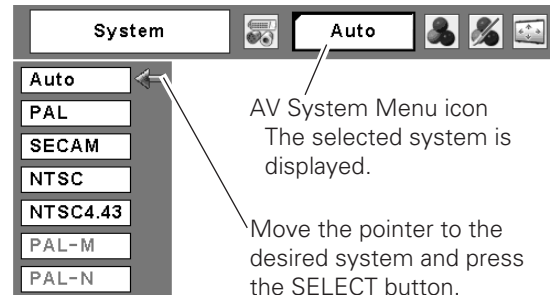

AV System Menu (Component)

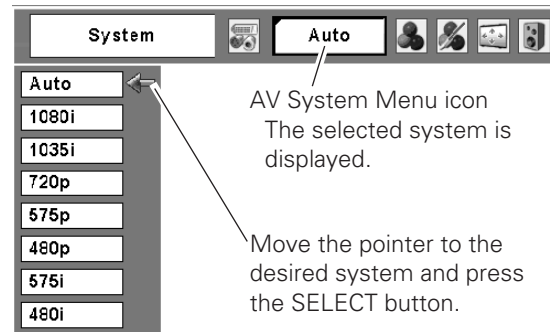

Computer Adjustment

Adjust the computer screen.

This projector has various types of signal formats to automatically tune to most computers. With these signal formats in the projector and the Auto PC Adjustment function, no special setting is required and you can enjoy the images in computers just by connecting the computer to the projector.

If you need to adjust the computer screen, adjust the setting by following this chapter. You can also store the adjusted parameters in the projector and call them up later when needed. Maximum 10 memory areas (Mode 1–10) are available.

*Some adjustments may not be available with the digital video signals (AV HDCP) input.

HELPFUL HINTS!

We frequently receive inquiries about computer connections. If the computer screen is not displayed properly, check the following matters once again.

- Is your computer cable connected to the projector's INPUT 1 or INPUT 2 terminals properly?
- Are the projector's input terminal and the connected computer signal selected properly with the INPUT 1 or INPUT 2 buttons on the remote control or by the On-Screen Menu?
- Is the signal correctly output from your computer? Many of the laptop computers need to change the setting for monitor output when connecting to the projector.

Computer System Selection

This projector automatically tunes to various types of computers based on VGA, SVGA, XGA, SXGA, WXGA, or UXGA with its Multi-scan system and Auto PC Adjustment. If a computer is selected as a signal source, this projector automatically detects the signal format and tunes to project a proper image without any additional settings. (Signal formats provided in this projector are shown on pages 75–76.)

One of the following messages may appear when:

Auto The projector cannot recognize the connected signal conforming to the provided PC Systems. The "Auto" is displayed on the System Menu box and the Auto PC Adjustment function works to display proper images. If the image is not projected properly, a manual adjustment is required (pp.40–41).

----- There is no signal input from the computer. Check the connection between your computer and the projector. (See "Troubleshooting" on page 69.)

Mode 1 The preset system is manually adjusted in the PC Adjust Menu. The adjusted data can be stored in Mode 1–10 (pp.40–41).

SVGA 1 PC Systems provided in this projector is chosen. The projector chooses a proper system provided in the projector and displays it.

*Mode 1 and SVGA 1 are examples.

PC System Menu

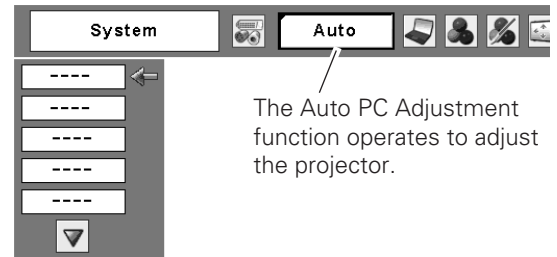

Selecting Computer System Manually

PC system can also be selected manually.

- 1 Press the MENU button to display the On-Screen Menu. Use the Point ◀▶ buttons to move the red frame pointer to the PC System Menu icon.
- 2 Use the Point ▲▼ buttons to move the red arrow pointer to the desired system and then press the SELECT button.

PC System Menu

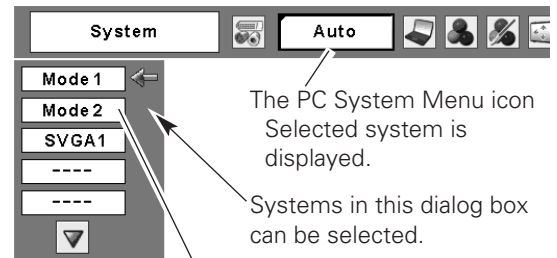

Custom Mode (1–10) set in the PC Adjust Menu (pp.40–41).

Auto PC Adjustment

Auto PC Adjustment function is provided to automatically adjust Fine sync, Total dots, Horizontal and Vertical positions to conform to your computer.

Direct Operation

The Auto PC adjustment function can be operated directly by pressing the AUTO PC button on the remote control.

Remote Control

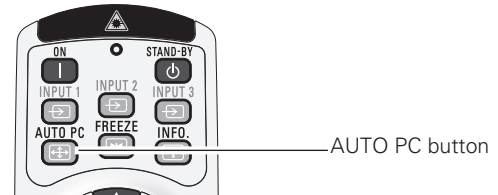

Menu Operation



Auto PC Adj.

- 1 Press the MENU button to display the On-Screen Menu. Use the Point ◀▶ buttons to move the red frame pointer to the PC Adjust Menu icon.
- 2 Use the Point ▲▼ buttons to move the red framed pointer to Auto PC Adj. and then press the SELECT button twice.

To store adjustment parameters

The adjusted parameters from the Auto PC Adjustment can be stored in the projector. Once the parameters are stored, the setting can be done just by selecting a Mode (1–10) in the PC System Menu (see page 38). See also “Store” on page 41.

✓Notes:

- Fine sync, Total dots, Horizontal and Vertical position of some computers cannot be fully adjusted with the Auto PC Adjustment function. When the image is not provided properly with this operation, manual adjustments are required (pp.40–41).
- The Auto PC Adjustment cannot be operated when 480i, 575i, 480p, 575p, 720p, 1035i, or 1080i is selected in the PC System Menu (p.38), or when the signal is coming from the DVI-terminal.

PC Adjust Menu

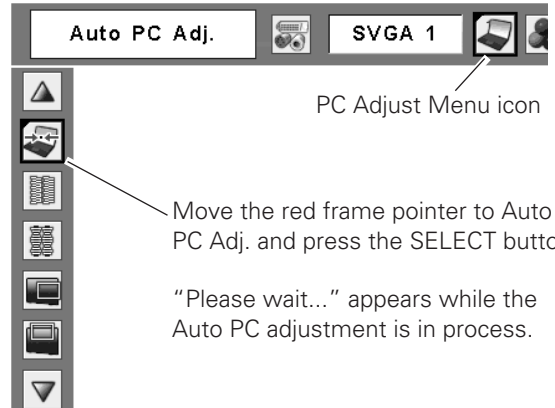

Manual PC Adjustment

Some computers employ special signal formats which may not be tuned by Multi-scan system of this projector. Manual PC Adjustment enables you to precisely adjust several parameters to match those signal formats. The projector has 10 independent memory areas to store those parameters manually adjusted. It allows you to recall the setting for a specific computer.

- 1 Press the MENU button to display the On-Screen Menu. Use the Point ◀▶ buttons to move the red frame pointer to the PC Adjust Menu icon.
- 2 Use the Point ▲▼ buttons to move the red frame pointer to the desired item and then press the SELECT button to display the adjustment dialog box. Use the Point ◀▶ buttons to adjust the setting value.

Fine sync

Use the Point ◀▶ buttons to adjust the value, eliminating a flicker from the image displayed (from 0 to 31).

Total dots

Use the Point ◀▶ buttons to adjust the number of total dots in one horizontal period to match your PC image.

Horizontal

Use the Point ◀▶ buttons to adjust the horizontal picture position.

Vertical

Use the Point ◀▶ buttons to adjust the vertical picture position.

Current mode

Press the SELECT button to show H-sync freq. and V-sync freq. of the connected computer.

Clamp

Use the Point ◀▶ buttons to adjust the clamp level. When the image has dark bars, try this adjustment.

PC Adjust Menu

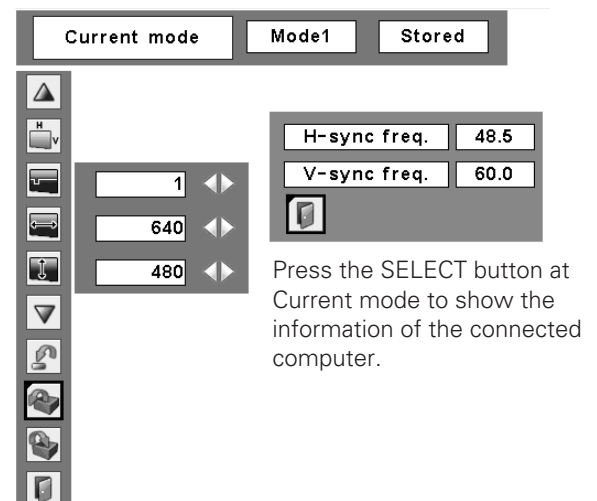
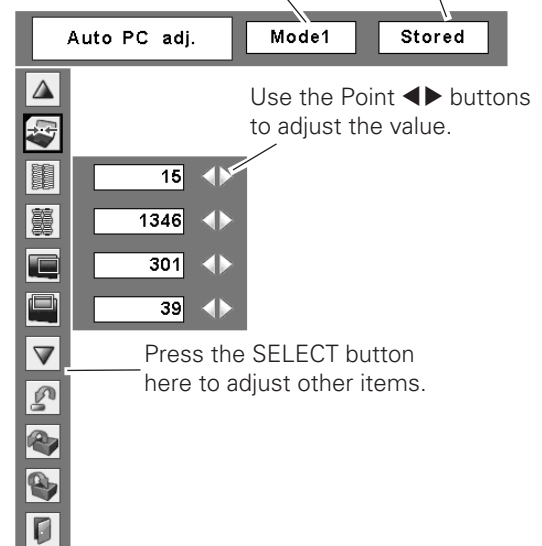
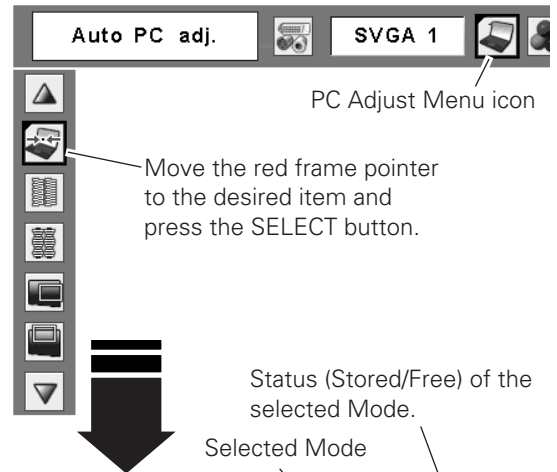

Display area H

Use the Point ◀▶ buttons to adjust the horizontal area displayed by this projector.

Display area V

Use the Point ◀▶ buttons to adjust the vertical area displayed by this projector.

Reset

To reset the adjusted data, select Reset and press the SELECT button. A confirmation box appears and then select [Yes]. All adjustments will return to their previous figures.

Mode free

To clear the stored data, select Mode free and then press the SELECT button. Move the red arrow pointer to the Mode that you want to clear and then press the SELECT button.

Store

To store the adjusted data, select Store and then press the SELECT button. Move the red arrow pointer to one of the Modes 1 to 10 in which you want to store, and then press the SELECT button.

Quit

Exit the PC Adjust Menu.

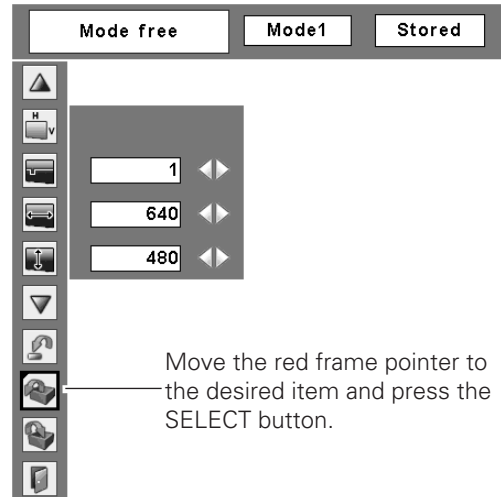

This Mode has stored parameters.

To clear the adjusted data

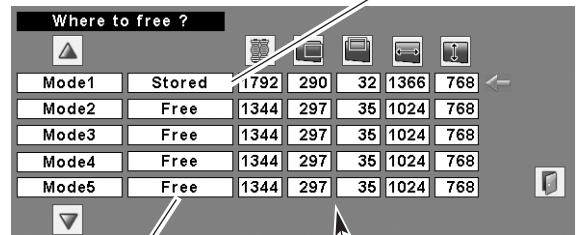

Vacant

Values of "Total dots," "Horizontal," "Vertical," "Display area H," and "Display area V."

To store the adjusted data

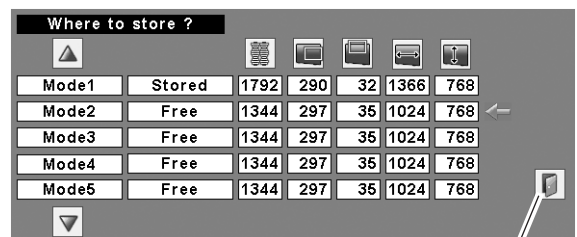

Close this dialog box.

✓Notes:

- Display area (H/V) cannot be selected when 480i, 575i, 480p, 575p, 720p, 1035i, or 1080i is selected in the PC System Menu (p.38).
- PC Adjust Menu cannot be selected when Input 1 [RGB (PC digital)] is selected in the Input Menu (p.35).

MEMO

Image Mode Selection

You can choose an image mode in accordance with each projected image such as presentation screen, movies, etc.

You can also adjust image parameters in the Image Adjust Menu and save them as Image 1–4. The four image modes with respect to each input source are stored.

Select Image Mode with the On-Screen Menu.

*Depending on the projected image, some image modes will not be available.

Image Mode Selection

Image Mode Selection

- 1 Press the MENU button to display the On-Screen Menu. Use the Point ◀▶ buttons to move the red frame pointer to the Image Menu icon.
- 2 Use the Point ▲▼ buttons to move the red frame pointer to the desired image mode and then press the SELECT button.

 **Dynamic**

For viewing pictures in a bright room.

 **Standard**

Normal picture mode preset on the projector.

 **Real**

Picture mode with improved halftone for graphics.
(This icon is displayed with the computer signal.)

 **Cinema**

Picture mode adjusted with fine tone.
(This icon is displayed with the video signal.)

 **Image 1-4**

For viewing with the user preset image mode in the Image Adjust Menu (see page 48). This Image memory is provided in each computer, component, and video input source.

Image Menu

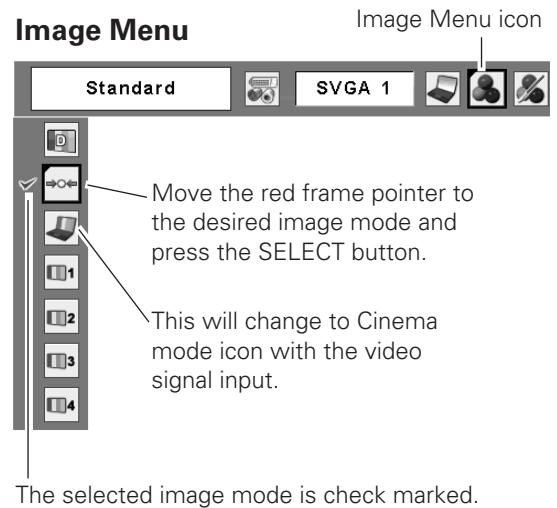

Image Adjustment

You can adjust the following image parameters.

Contrast

Brightness

Color*

Tint*

Color Temperature

White Balance (Red)

White Balance (Green)

White Balance (Blue)

Noise reduction*

This function can reduce noise interference on the screen. Certain images may be inapplicable.

Progressive*

An interlaced video signal can be displayed in progressive mode reproducing highly detailed images.

The adjusted parameters are stored and called up later when needed. Maximum of four user image modes (Image 1–Image 4) are available and they can be called up in the Image Menu (see “Image Mode Selection” on pages 43–44).

*Not available depending on the signals.

Image Adjustment

- 1 Press the MENU button to display the On-Screen Menu. Use the Point ◀▶ buttons to move the red frame pointer to the Image Adjust Menu icon.
- 2 Use the Point ▲▼ buttons to move the red frame pointer to the desired item and then press the SELECT button to display the adjustment dialog box. Use the Point ◀▶ buttons to adjust the setting value.

Contrast

Press the Point ◀ button to decrease the contrast; press the Point ▶ button to increase the contrast (from 0 to 63).

Brightness

Press the Point ◀ button to decrease the brightness; press the Point ▶ button to increase the brightness (from 0 to 63).

Color

Press the Point ◀ button decrease the intensity of the color; press the Point ▶ button increase the intensity of the color (from 0 to 63).

Tint

Press the Point ◀▶ buttons to adjust the tint value to get a proper color balance (from 0 to 63).

Color temp.

Use the Point ◀▶ buttons to select the desired Color temp. level (High, Mid, Low, or XLow).

White balance (Red)

Press the Point ◀ button to lighten red tone; press the Point ▶ button to deepen red tone (from 0 to 63).

White balance (Green)

Press the Point ◀ button to lighten green tone; press the Point ▶ button to deepen green tone (from 0 to 63).

White balance (Blue)

Press the Point ◀ button to lighten blue tone; press the Point ▶ button to deepen blue tone (from 0 to 63).

✓Notes:

- When the White balance Red, Green, or Blue is adjusted, the Color temp. level will change to "Adj."
- Tint cannot be selected when the video system is PAL, SECAM, PAL-M, or PAL-N (p.36).
- Each input signal has different On-Screen Menu display.

*The figure below shows for video signal input.

Image Adjust Menu

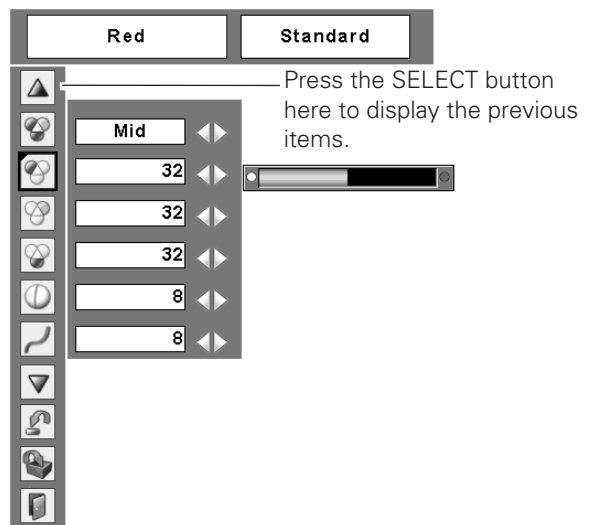
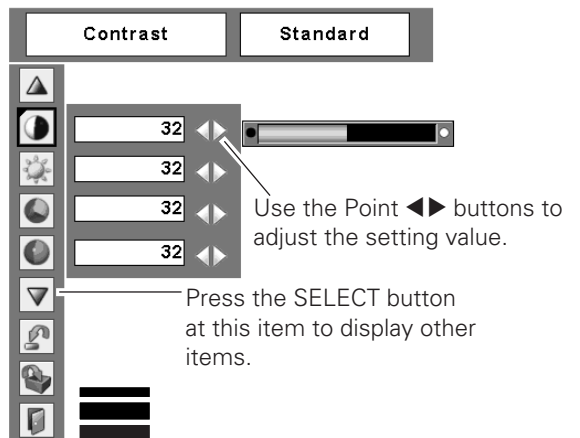
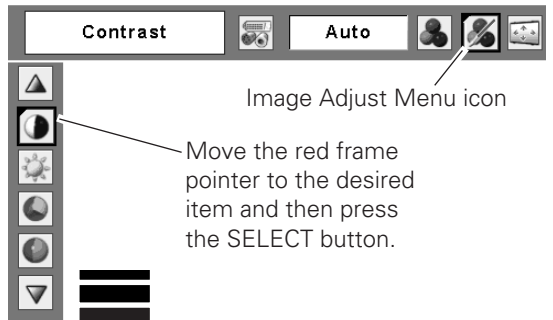



Sharpness

Press the Point ◀ button to decrease the sharpness of the image; press the Point ▶ button to increase the sharpness of the image (from 0 to 15).



Gamma

Use the Point ◀▶ buttons to adjust the gamma value to obtain a better balance of contrast (from 0 to 15).



Noise reduction

Noise interference on the screen can be reduced. Select one of the following options to get smoother images.

Off..... Disabled.

L1 Lower reduction

L2 Higher reduction



Progressive

An interlaced video signal can be displayed in progressive mode. Select one of the following options.

Off..... Disabled.

L1 For an active picture.

L2 For a still picture.

Film For watching a film. With this function, the projector reproduces pictures faithful to the original film quality.

✓Notes:

- Noise reduction and Progressive cannot be selected when 480p, 575p, 720p, 1035i, or 1080i is selected (p.36).
- Reset and Store icons will be displayed when more than one adjustment is made.

Image Adjustment

Reset

To reset the adjusted data, select Reset and press the SELECT button. A confirmation box appears and then select [Yes]. All adjustments will return to their previous figures.

Store

To store the adjusted data, select Store and press the SELECT button. Use the Point ▲▼ buttons to select one from Image 1 to 4 and press the SELECT button. A confirmation box appears and then select [Yes]. Stored data can be called up by selecting an “Image (1–4)” in the Image Mode Selection on page 44.

Quit

Exit the Image Adjust Menu.

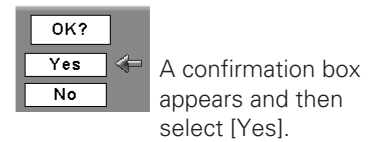
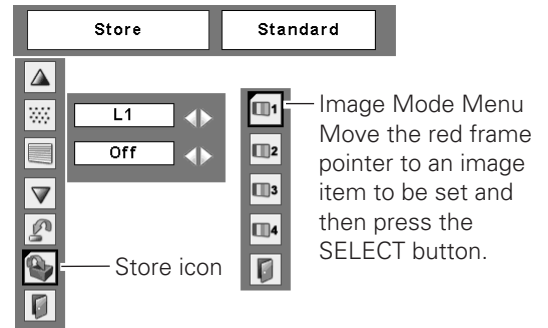

Screen Adjustment

You can change or adjust the appearance of the image as well as the image orientation with the following options.

Screen size	Select a screen size conforming to the input signal source.
Digital zoom	Zoom up and down the images. (Only available with the computer signals.)
Keystone	Correct Keystone distortion.
Ceiling	Set when projecting from the ceiling.
Rear	Set when projecting from the rear of the screen.

Screen Adjustment

- 1 Press the MENU button to display the On-Screen Menu. Use the Point ◀▶ buttons to move the red frame pointer to the Screen Menu icon.
- 2 Use the Point ▲▼ buttons to move the red framed pointer to the desired function and then press the SELECT button.

Screen Menu

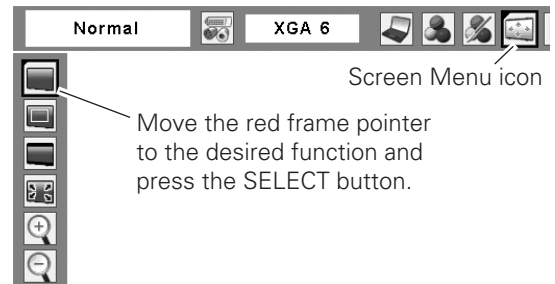

Keystone

This function is used to store or reset the keystone correction when the AC power cord is unplugged. Use the Point ◀▶ buttons to switch between each option.

Store Keep the keystone correction even when the AC power cord is unplugged.

Reset Release the keystone correction when the AC power cord is unplugged.

To correct keystone distortion, press the SELECT button. The "Keystone" appears on the screen. Use the Point ▲▼ buttons to correct keystone distortion. (p.32)

Keystone

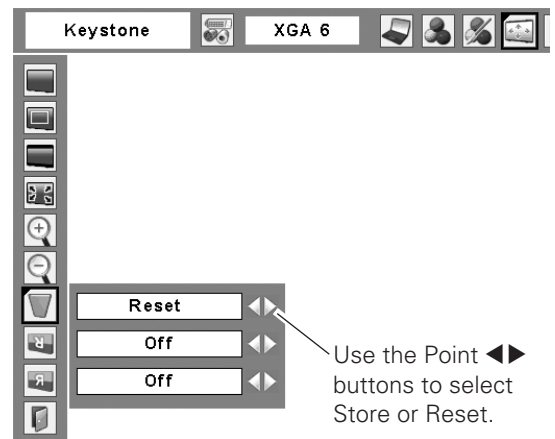

Ceiling

When this function is set to "On," the picture is top/bottom and left/right reversed. This function is used to project the image from a ceiling-mounted projector.

Ceiling

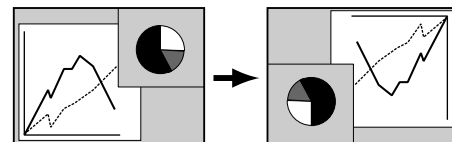

Rear

When this function is set to "On," the picture is left/right reversed. This function is used to project the image from the rear of the screen.

Rear

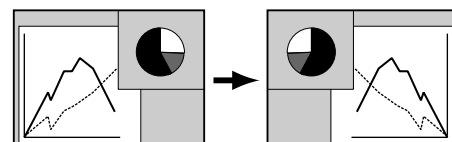

Screen Size Adjustment (Computer Signals)

Select the desired screen size that conforms to the input signal source.

Normal

Provide the image to fit the screen size.

True

Provide the image in its original size. When the original image size is larger than the screen size (1024 x 768), the projector enters to the panning mode automatically. Use the Point **▲▼◀▶** buttons to pan the image. When adjusted, the arrows will turn red. When reached to the correction limits, the arrows will disappear.

Wide

Provide the image to fit the wide video aspect ratio (16:9) by expanding the image width uniformly. This function can be used for providing a squeezed video signal at 16:9.

Full screen

Provide the full screen image.

For zooming in and out the images

Digital zoom +

Select Digital zoom +. The On-Screen Menu disappears and "D. zoom +" appears. Press the SELECT button to expand the image size. Use the Point **▲▼◀▶** buttons to pan the image. The Panning function can work only when the image is larger than the screen size.

You can also enter the Digital zoom + mode by pressing the D.ZOOM button on the remote control.

Digital zoom -

Select Digital zoom -. The On-Screen Menu disappears and "D. zoom -" appears. Press the SELECT button to compress image size.

You can also enter the Digital zoom - mode by pressing the D.ZOOM button on the remote control.

To exit the Digital zoom +/- mode, press any button except the D.ZOOM, SELECT, and Point buttons.

To return to the previous screen size, select a screen size from the Screen Menu or select an input source from the Input Menu (p.35) again, or adjust the screen size with the D.ZOOM buttons on the remote control.

Screen Menu

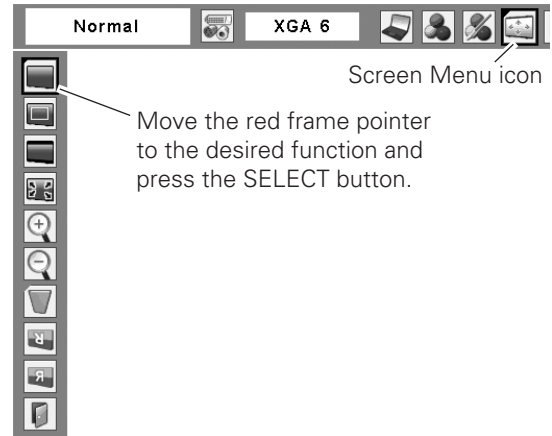

✓ Notes:

- The projector cannot display any resolution higher than 1600 x 1200. If your computer's screen resolution is higher than that, lower the resolution before connecting to the projector.
- The image data other than 1024 x 768 is modified to fit the screen size in initial mode.
- True, Full screen, and Digital zoom +/- cannot be selected when 480i, 575i, 480p, or 575p is selected in the PC System Menu (p.38).
- The panning function may not be operated properly if the stored Mode in the PC Adjust Menu is used (pp.39-41).
- The minimum compression ratio can be limited depending on the input signal or when the Keystone function is working.
- Digital zoom +/- cannot be selected when Full screen or True is selected.
- The Screen Menu cannot be operated when 720p, 1035i, or 1080i is selected in the PC System Menu (p.38).

Screen Size Adjustment (Video, Component Signals)

- 1 Press the MENU button to display the On-Screen Menu. Use the Point ◀▶ buttons to move the red frame pointer to the Screen Menu icon.
- 2 Use the Point ▲▼ buttons to move the red framed pointer to the desired function and then press the SELECT button.

Normal

Provide the image at the 4:3 normal video aspect ratio.

Wide

Provide the image at the 16:9 wide screen ratio.

✓Note:

- The Screen Menu cannot be operated when 720p, 1035i, or 1080i is selected in the AV System Menu (p.36).

Screen Menu

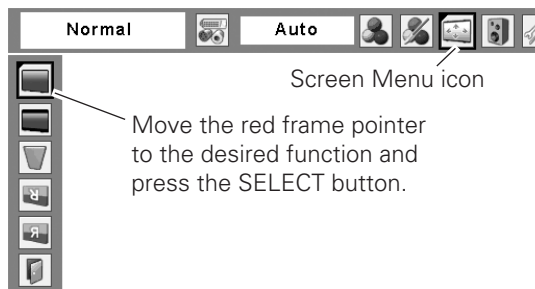

Setting

The following setting options are available:

Language Screen Menu.	Select the language of the On-
Background no signal input.	Select the background image for
Lamp control lamp.	Select the brightness of the
Pointer	Select the pointer shape.
Remote control	Select the remote control code.
RC Sensor selection	Select the location of infrared remote receiver.
Display	Select the screen display option
Logo	Customize the screen logo
Security	Set the Security function
Power management management function	Set the Power
Fan control	Set the cooling fans' operation
Lamp counter the lamp counter	Check the lamp time and reset
Filter counter	Set the filter cleaning timing
On start	Turn on the projector automatically when the AC cord is connected.
Test-pattern provided.	Convenient test patterns are
Warning log	Check the records of operation

Setting

This projector has a Setting menu that allows you to set up the other various functions described below.

- 1 Press the MENU button to display the On-Screen Menu. Use the Point ◀▶ buttons to move the red frame pointer to the Setting Menu icon.
- 2 Use the Point ▲▼ buttons to move the red framed pointer to the desired item and then press the SELECT button. The Setting dialog box appears.

Language

The language used in the On-Screen Menu is available in English, German, French, Italian, Spanish, Portuguese, Dutch, Swedish, Russian, Chinese, Korean, and Japanese.

Background

The selected background screen will be displayed when no input signal is detected.

- Blue..... Project a blue background
- User Project an image selected in the Logo setting.
- Black Project a black background

✓Note:

- When no captured image is set, the "User" options is not available.

Lamp control

This function allows you to change brightness of the screen.

- ⓂA1 Auto 1 The brightness according to the input signal (between Normal and Eco mode).
- ⓂA2 Auto 2 The brightness according to the input signal (between High and Eco mode).
- 💡 High Brighter than the Normal mode.
- 💡 Normal Normal brightness
- 💡 Eco Lower brightness reduces the lamp lower consumption and extends the lamp life.

Pointer

You can emphasize a part of the projected image with this function. Use the Point ▲▼ buttons to choose either Spotlight or Pointer and press the SELECT button. Then use the Point ◀▶ buttons to select a size of the Spotlight (Large, Middle, or Small) or a pattern of the Pointer (Arrow, Finger, or Dot). (See page 16 for operation.)

Setting Menu (Language)

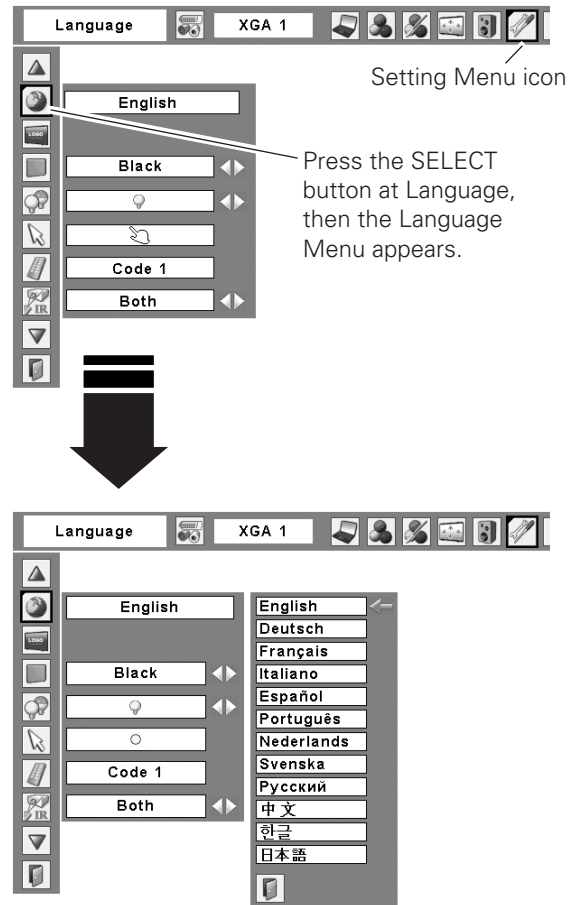

Pointer

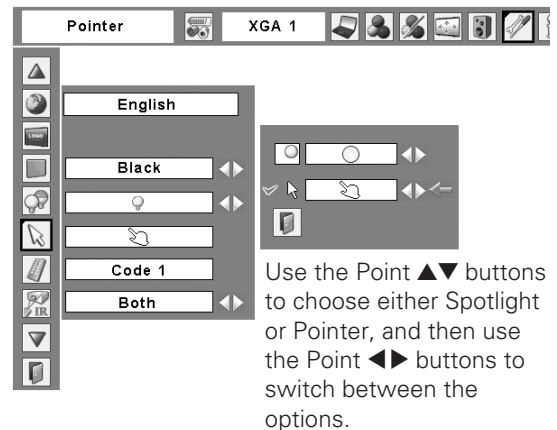

Logo (Logo and Logo PIN code lock settings)

This function allows you to customize the screen logo with Logo select, Capture, and Logo PIN code lock functions.

✓Note:

- When “On” is selected in the Logo PIN code lock function, Logo select and Capture functions cannot be selected.

L Logo select

This function decides on the starting-up display from among following options.

- User Show the image you captured
- Default Show the factory-set logo
- Off..... Show the countdown display only

Capture

This function enables you to capture an image being projected to use it for a starting-up display or interval of presentations.

Select Capture and press the SELECT button. A confirmation box appears and select [Yes] to capture the projected image.

After capturing the projected image, go to the Logo select function and set it to “User”. Then the captured image will be displayed the next time you turn on the projector or when you press the NO SHOW button (see page 32).

To cancel the Capture function, select [No].

✓Notes:

- Before capturing an image, select “Standard” in the Image Menu to capture a proper image (p.44).
- A signal from a computer can be captured up to XGA (1024 x 768). A signal from video equipment can be captured except for 720p, 1035i, and 1080i.
- When capturing the image that has been adjusted by the Keystone function, the adjusted data is automatically reset and the projector captures an image without keystone correction.
- When the Logo PIN code lock function is set to “On,” the Capture function cannot be selected.
- When starting to capture a new image, the previously stored image is cleared even if you cancel the capturing.

Logo

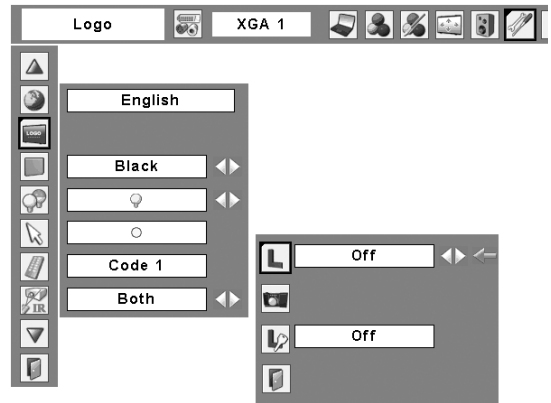

Capture

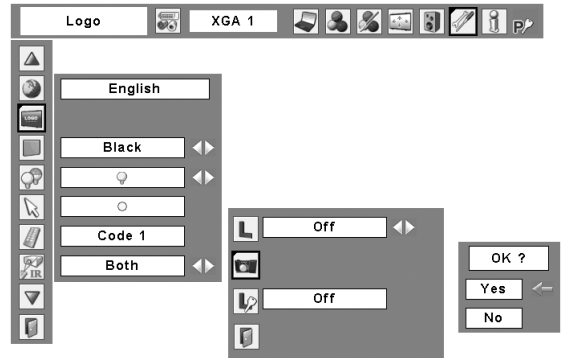

Select [Yes] to capture the projected image.

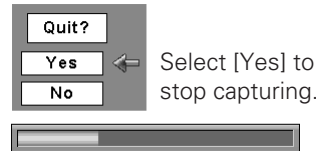



Logo PIN code lock

This function prevents an unauthorized person from changing the screen logo.

- Off..... The screen logo can be changed freely from the Logo Menu (p.55).
- On..... The screen logo cannot be changed without a Logo PIN code.

If you want to change the Logo PIN code lock setting, press the SELECT button and the Logo PIN code dialog box appears. Enter a Logo PIN code by following the steps below. The initial Logo PIN code is set to "4321" at the factory.

Enter a Logo PIN code

Use the Point ▲▼ buttons or Number buttons on the remote control to enter a number. Press the Point ► button to fix the number and move the red frame pointer to the next box. The number changes to "*." If you fixed an incorrect number, use the Point ◀ button to move the pointer to the number you want to correct, and then enter the correct number.

Repeat this step to complete entering a four-digit number.

After entering the four-digit number, move the pointer to "Set." Press the SELECT button so that you can start to operate the projector.

If you entered an incorrect Logo PIN code, "Logo PIN code" and the number (****) will turn red for a moment. Enter the correct Logo PIN code all over again.

Change the Logo PIN code lock setting

Use the Point ◀► button to switch On/Off, and then press the Point ▼ button to move the pointer to "Quit." Press the SELECT button to close the dialog box.

Change the Logo PIN code

Logo PIN code can be changed to your desired four-digit number. Press the Point ▼ button to select "Logo PIN code change" and then press the SELECT button. The New Logo PIN code input dialog box appears. Set a new Logo PIN code.

Be sure to note the new Logo PIN code and keep it at hand. If you lost the number, you could no longer change the Logo PIN code setting. For details on PIN code setting, refer to "PIN code lock" on pages 60–61.

Logo PIN code lock

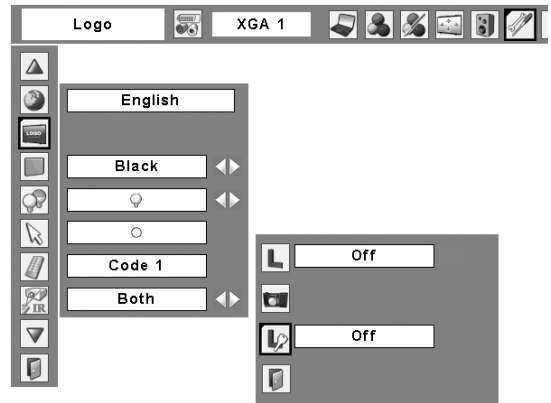

Enter a Logo PIN code

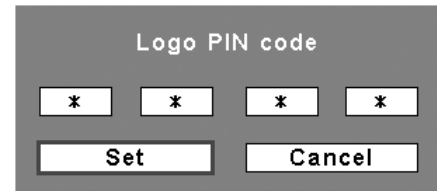

After a correct Logo PIN code is entered, the following dialog box appears.

Change the Logo PIN code lock setting



Use the Point ◀► buttons to switch On/Off.

Change the Logo PIN code

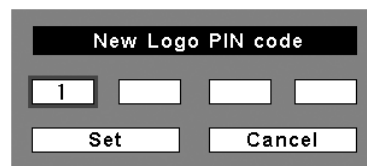

CAUTION:
WHEN YOU HAVE CHANGED THE LOGO PIN CODE, WRITE DOWN THE NEW PIN CODE IN COLUMN OF THE LOGO PIN CODE NO. MEMO ON PAGE 81, AND KEEP IT SECURELY. SHOULD THE LOGO PIN CODE BE LOST OR FORGOTTEN, THE LOGO PIN CODE SETTING CAN NO LONGER BE CHANGED.



Remote control

The eight different remote control codes (Code 1–Code 8) are assigned to the projector; the factory-set, initial code (Code 1) and the other seven codes (Code 2 to Code 8).

The same code should set on both the projector and the remote control. For example, operating the projector in “Code 7”, the remote control code also must be switched to “Code 7”.

To change the code for the projector

Select a remote control code in this Setting Menu.

To change the code for the remote control:

Press and hold the MENU button and a number button (1–8) on the remote control for more than five seconds to switch between the codes. (See page 17 for details.)

Remote control

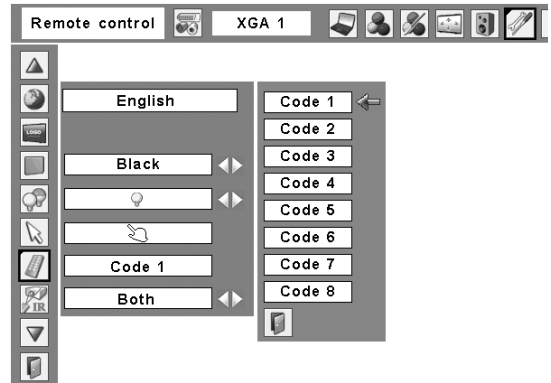

RC sensor

Select a location of the infrared remote receiver of the remote control. See “Remote Control Operating Range” on page 18 for details.

- Both Activate both the front and back receiver.
- Front Activate only the front receiver.
- Back Activate only the back receiver.



Display

This function decides whether to display On-Screen Displays.

- On Show all the On-Screen displays. Use this function when you want to project images after the lamp becomes bright enough. The factory default setting is in this option.
- Countdown Off Show the input image instead of the countdown when turning on the projector. Use this function when you want to project the image as early as possible even when the lamp is not bright enough.
- Off Hide the On-Screen Displays except;
 - On-Screen Menu
 - “Power off?” (p.26)
 - “No signal” for Power management (p.58)
 - “Please wait ...”
 - White arrows for the True function in the Screen Menu (p.51)
 - “Filter warning” icon (red) (p.74)

Display

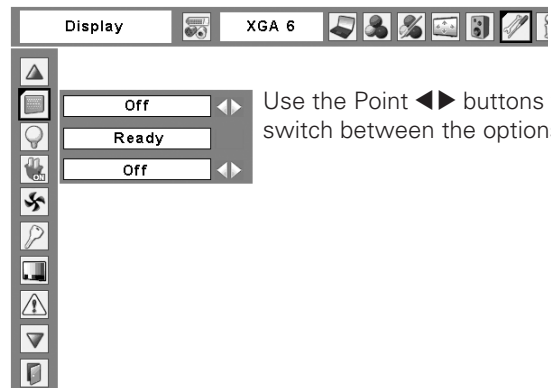



Power management

For reducing power consumption as well as maintaining the lamp life, the Power management function turns off the projection lamp when the projector is not used for a certain period.

If the input signal is interrupted and no button is pressed for more than 30 seconds, the timer display with “No signal” appears. It starts the countdown until the lamp is turned off. The countdown time can be set between 1–30 minutes. Use the Point ◀▶ buttons to set the countdown timer.

Select one of the following options:

- Ready When the lamp has been fully cooled down, the POWER indicator changes to fast blinking. In this condition, the projection lamp can be turned on if the input signal is reconnected or any button on the top control or remote control is pressed.
- Shut down..... When the lamp has been fully cooled down, the power will be turned off.
- Off..... Power management function is off.



On start

When this function is set to “On,” the projector will be automatically turned on just by connecting the AC power cord to a wall outlet.

✓Note:

- Be sure to turn off the projector properly (see “Turning Off the Projector” on page 26). If the projector is turned off in the incorrect sequence, the On start function does not work properly.

Power management



Time left before the lamp is off.

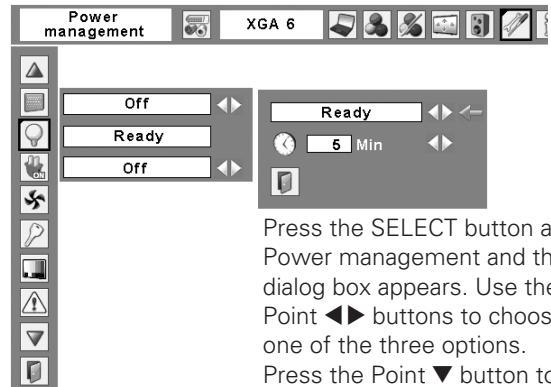

Press the SELECT button at Power management and this dialog box appears. Use the Point ◀▶ buttons to choose one of the three options. Press the Point ▼ button to select the timer, and then use the Point ◀▶ buttons to set timer.

 **Fan control**

This function is used to set the cooling fans' operation to the projector's setting environment. Set this function properly in accordance with the projector's installation method. Otherwise, the cooling fans will not work properly and that causes malfunctions of the projector and decreases the lamp life.

Slant

Select the projector's installation condition from the following options:

- Off..... When using the projector with the upward/downward inclination of 20 degrees to the horizontal plane.
- L1 When using the projector with upward inclination of over 20 degrees to the horizontal plane.
- L2 When using the projector with downward inclination of over 20 degrees to the horizontal plane.

Highland





Set this function according to the ground elevation under which you use the projector. When using the projector in high altitudes (about 1,200 meters or more above the sea level) where the fans have less cooling effect, set this function to "On."

 **Security (Key lock and PIN code lock settings)**

This function allows you to use the Key lock and PIN code lock function to set the security for the projector operation.

 **Key lock**

This function locks the top control and remote control buttons to prevent operation by unauthorized persons.

-  Unlocked
-  Lock all the top control buttons
-  Lock the top control buttons except for the ON/STAND-BY, INPUT, and INFO. buttons. To unlock, use the remote control.
-  Lock all the remote control buttons. To unlock, use the top control.
-  Lock the remote control buttons except for the ON, STAND-BY, INPUT 1-3, AUTO PC, FREEZE, and INFO. buttons.

If the top control accidentally becomes locked and you do not have the remote control nearby or there is something wrong with your remote control, contact the dealer where you purchased the projector or the service center.

Fan control

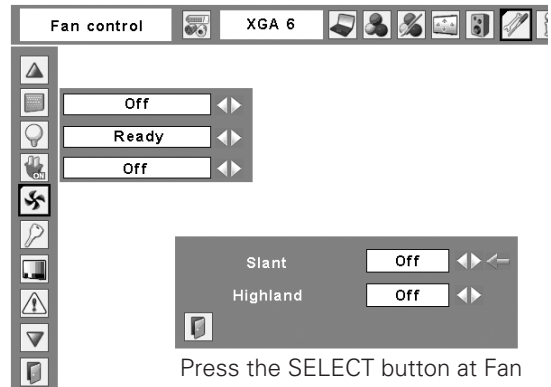

Press the SELECT button at Fan control and this dialog box appears. Use the Point ▲▼ buttons to choose Slant or Highland. Use the Point ◀▶ buttons to switch between the options.

Key lock

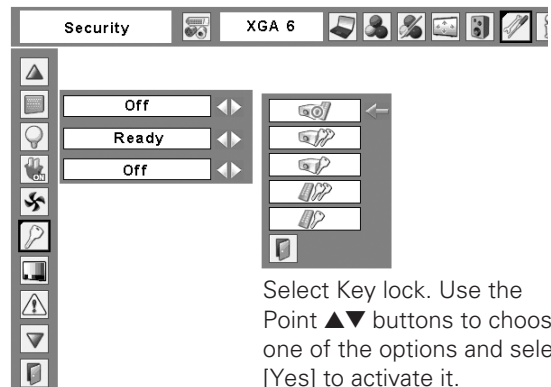

Select Key lock. Use the Point ▲▼ buttons to choose one of the options and select [Yes] to activate it.

PIN code lock

This function prevents the projector from being operated by unauthorized persons and provides the following setting options for security.

- Off..... Unlocked.
- On1 Enter the PIN code every time turning on the projector.
- On2 Enter the PIN code to operate the projector once the power cord is disconnected; as long as the AC power cord is connected, the projector can be operated without a PIN code.

Whenever you change the PIN code lock setting or the PIN code (the four-digit number), you are required to enter the PIN code. The "1234" is set as the initial PIN code at the factory.

If you want to change the PIN code lock setting, Press the SELECT button and the PIN code dialog box appears. Enter a PIN code by following the steps below.

Enter a PIN code

Use the Point ▲▼ buttons or Number buttons on the remote control to enter a number. Press the Point ► button to fix the number and move the red frame pointer to the next box. The number changes to "*." If you fixed an incorrect number, use the Point ◀ button to move the pointer to the number you want to correct, and then enter the correct number.

Repeat this step to complete entering a four-digit number.

After entering the four-digit number, move the pointer to "Set." Press the SELECT button so that you can start to operate the projector.

If you entered an incorrect PIN code, "PIN code" and the number (****) will turn red for a moment. Enter the correct PIN code all over again.

Change the PIN code lock setting

Use the Point ◀► button to select Off, On1, or On2 and then move the pointer to "Quit" with the Point ▼ button. Press the SELECT button to close the dialog box.

PIN code lock

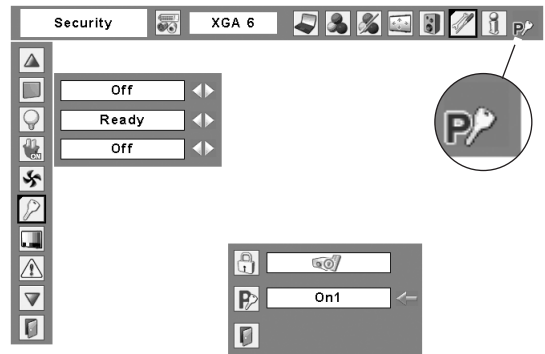

When the projector is locked with a PIN code, the PIN code lock symbol appears on the menu bar.

Enter a PIN code

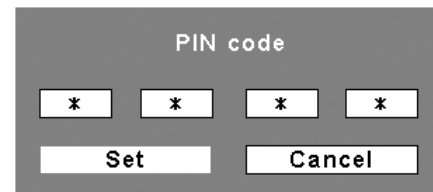

After a correct PIN code is entered, the following dialog box appears.

Change the PIN code lock setting



Use the Point ◀► buttons to switch between the options.

Change the PIN code

The PIN code can be changed to your desired four-digit number. Press the Point ▼ buttons to select “PIN code change” and press the SELECT button. The New PIN code input dialog box appears. Set a new PIN code.

Change the PIN code

CAUTION:
WHEN YOU HAVE CHANGED THE PIN CODE, WRITE DOWN THE NEW PIN CODE IN COLUMN OF THE PIN CODE NO. MEMO ON PAGE 81, AND KEEP IT SECURELY. IF YOU FORGET YOUR PIN CODE, THE PROJECTOR CAN NO LONGER BE STARTED.



Test pattern

Various test pattern are available for use when setting up the projector.



Warning log

This function records anomalous operations while the projector is in operation and use it when diagnosing faults. Up to 10 warning logs are displayed with the latest warning message at the top of the list, followed by previous warning messages in chronological order.

✓Note:

- When the Factory default function is executed, all the warning log records will be deleted.



Lamp counter

This function is used to reset the lamp counter.

When the lamp life is left less than 100 hours, the Lamp replacement icon appears on the screen, indicating that the end of lamp life is approaching.

When replacing the projection lamp, reset the lamp counter. See page 66 for operation.



This icon appears on the screen when the end of lamp life is approaching.



Filter counter

This function is used to set a frequency for the filter cleaning.

When the projector reached a specified time between cleanings, a Filter warning icon (yellow) appears on the screen and the WARNING FILTER indicator lights orange, notifying the cleaning is necessary. After cleaning the filter, be sure to select RESET and set the timer. The WARNING FILTER indicator and Filter warning icon will not turn off until the filter counter is reset.

For details about resetting the timer, refer to "Resetting the Filter Counter" on page 64.



Factory default

This function returns all setting values except for the user logo, PIN code lock, Logo PIN code lock, the filter counter, and the lamp counter to the factory default settings.



Quit

Exit the Setting Menu.

Filter counter

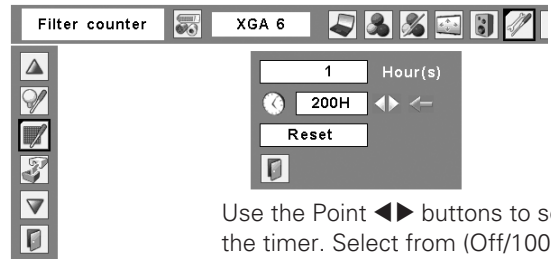

Use the Point ◀▶ buttons to set the timer. Select from (Off/100H/200H/300H) depending on the use environment.

Filter warning



Filter warning icon (yellow) appears on the screen at a set time.

✓ Note:

- The Filter warning icon (yellow) will not appear when the Display function is set to "Off" (p.57), during "Freeze" (p.31), or "Now show" (p.32).

Factory default

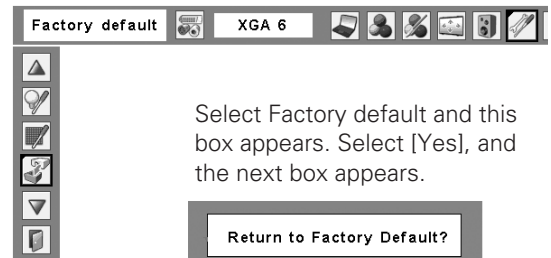

Select Factory default and this box appears. Select [Yes], and the next box appears.

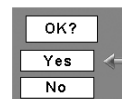

Select [Yes] to activate it.

Maintenance and Filter Cleaning

In order to care for the projector appropriately, regular maintenance is required. The instructions described here will help minimize the need for optical cleaning, reduce the likelihood of costly repairs, and maximize lamp life.

The projector uses a lamp which generates significant heat and thus requires a large amount of air to be drawn through the filter to cool the units. When the filter starts to clog, not enough air will be drawn into the projector housing.

Remove any dirt or dust on surface of the projector and on the filter regularly and keep them clean

RECOMMENDATION

We recommend avoiding dusty/smoky environments when you operate the projector. Usage in these environments may cause poor image quality.

IMPORTANT NOTICE ON MAINTENANCE OF THE FILTER

MAINTAIN THE FILTER by using the Filter counter function in the menu.

Clean the filter regularly. The frequency of cleaning the filter depends on the environment in which you use the projector. If you use the projector in an office or home every day, we recommend that you clean the filter once a week (or about every 200 hours). See "Filter counter" in the Setting Menu for details.

If the projector detects that the filter is clogged, a "Filter warning" icon (red) will appear on the screen and "WARNING FILTER" indicator on the top panel will blink. Stop using the projector immediately and clean or replace the filter.

After cleaning or replacing the filter, make sure to reset the filter counter. The Filter warning icon and WARNING FILTER indicator will not turn off until the filter is cleaned or replaced.

See "WARNING FILTER indicator" on page 74.

Cleaning the Filter

Filter prevents dust from accumulating on the optical elements inside the projector. Should the filter becomes clogged with dust particles, it will reduce cooling fans' effectiveness and may result in internal heat buildup and adversely affect the life of the projector. If a "Filter warning" icon (yellow or red) appears on the screen and the WARNING FILTER indicator lights or blinks, clean the filter immediately. Clean the filter by following the steps below.

- 1 Turn off the projector, and unplug the AC power cord from the AC outlet.
- 2 First, clean up the dust on the projector and around the air vents.
- 3 Pull out the filter cover from the projector and then remove the filter.
- 4 Gently clean the filter by using a brush or blower.

WARNING: Do not wash the filter with water and any other liquid matter. Otherwise the filter may be damaged.

- 5 Reinstall the filter into the projector properly.
- 6 Reset the filter counter in the Setting Menu. See "Resetting the Filter Counter" below.



CAUTION

Do not operate the projector with the filter removed. Dust may accumulate on the optical elements degrading picture quality. Do not put anything into the air vents. Doing so may result in malfunction of the projector.

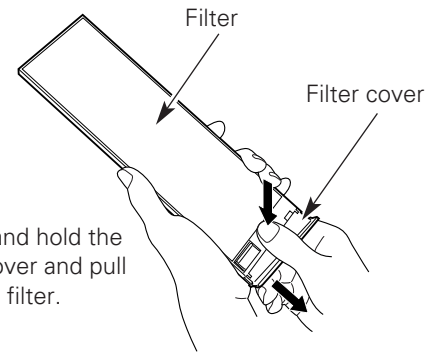
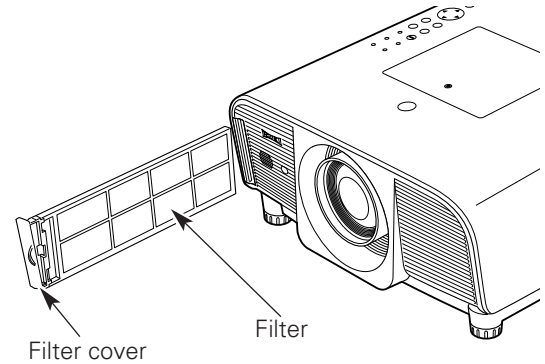

NOTE: If the filter is heavily clogged and unable to clean, replace it with a new one. Consult your dealer for details.

Replacement Filter Part No.: 910-330-7184

Resetting the Filter Counter

Be sure to reset the Filter counter after cleaning or replacing the filter.

- 1 Press the MENU button to display the On-Screen Menu. Use the Point ◀▶ buttons to move the red frame pointer to the Setting Menu icon.
- 2 Use the Point ▲▼ buttons to move the red frame pointer to Filter counter and then press the SELECT button. A dialog box appears showing the total accumulated time of the filter use, a timer setting option, and the reset option. Select Reset and the "Filter counter Reset?" appears. Select [Yes] to continue.
- 3 Another confirmation dialog box appears, select [Yes] to reset the Filter counter.

Filter counter

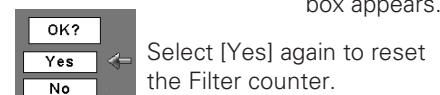
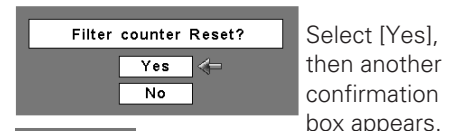
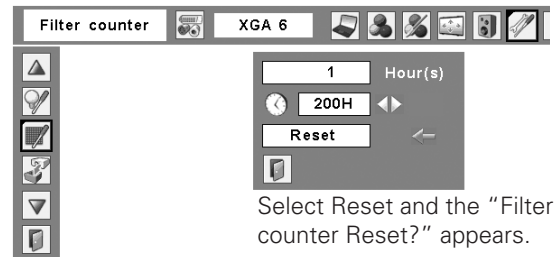

Lamp Replacement

When the projection lamp of the projector reaches its end of life, the Lamp replacement icon appears on the screen and LAMP REPLACE indicator lights yellow. Replace the lamp with a new one promptly. The timing when the LAMP REPLACE indicator should light is depending on the lamp mode.



WARNING:
TURN OFF THE UV LAMP BEFORE
OPENING THE LAMP COVER

Top Control

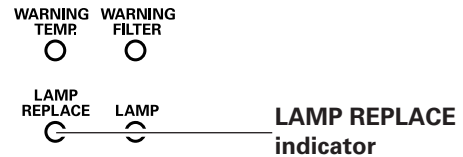

Lamp replacement icon



CAUTION

Allow a projector to cool for at least 45 minutes before you open the Lamp cover. The inside of the projector can become very hot.



CAUTION

For continued safety, replace with a lamp of the same type lamp. Do not drop the lamp or touch the glass bulb! The glass can shatter and may cause injury.

Follow these steps to replace the lamp.

- 1** Turn off the projector and unplug the AC power cord. Let the projector cool for at least 45 minutes.
- 2** Remove the screw that secures the lamp cover, and then open the lamp cover.
- 3** Remove the two (2) silver screws that secure the lamp. Lift the lamp out of the projector by using the handle.
- 4** Replace the lamp with a new one and secure the two (2) screws. Make sure that the lamp is set properly. Put the lamp cover back and secure it with the screw.
- 5** Connect the AC power cord to the projector and turn on the projector.
- 6** **Reset the lamp counter.**
See "Resetting the Lamp Counter" on the next page.

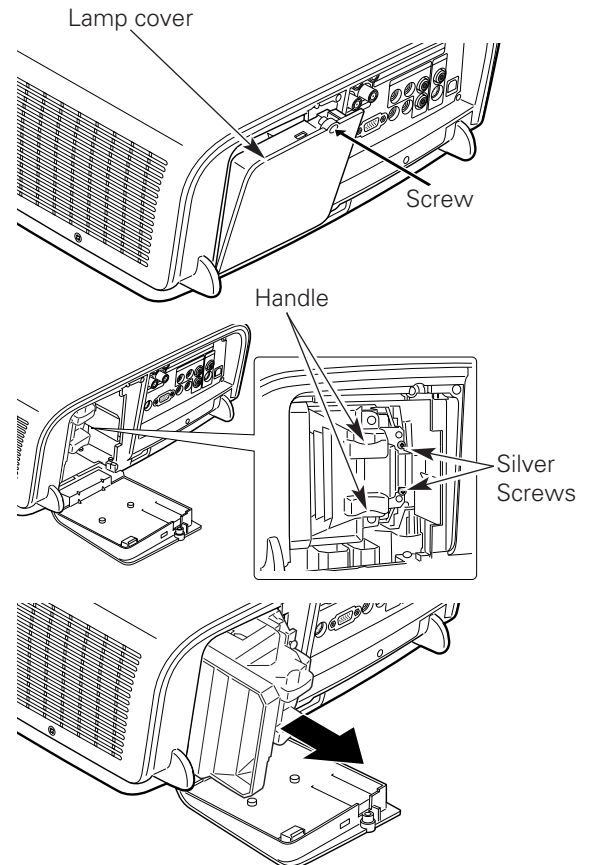

ORDER REPLACEMENT LAMP

Replacement lamp can be ordered through your dealer. When ordering, give the following information to the dealer.

- **Model No. of your projector** : **LC-XG300, LC-XG250, LC-XG300L, LC-XG250L**
- **Replacement Lamp Type No.** : **POA-LMP105**
(Service Parts No. 610 330 7329)

Resetting the Lamp Counter

Be sure to reset the Lamp counter after the lamp is replaced. When the Lamp counter is reset, the LAMP REPLACE indicator stops lighting and the Lamp replacement icon disappears.

- 1 Press the MENU button to display the On-Screen Menu. Use the Point ◀▶ buttons to move the red frame pointer to the Setting Menu icon.
- 2 Use the Point ▲▼ buttons to move the red frame pointer to Lamp counter and then press the SELECT button. A dialog box appears showing the total accumulated time of the lamp usage and the reset option. Select Reset and the "Lamp replacement counter Reset?" appears. Select [Yes] to continue.
- 3 Another confirmation dialog box appears, select [Yes] to reset the Lamp counter.

✓ **Note:**

- Do not reset the Lamp counter without implementing lamp replacement. Be sure to reset the Lamp counter only after replacing the lamp.

Lamp counter

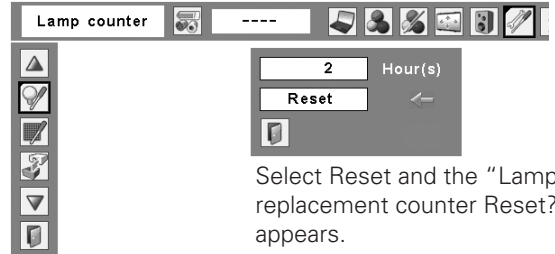

Select Reset and the "Lamp replacement counter Reset?" appears.

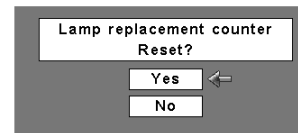

Select [Yes], then another confirmation box appears.

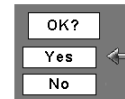

Select [Yes] again to reset the Lamp counter.



LAMP HANDLING PRECAUTIONS

This projector uses a high-pressure lamp which must be handled carefully and properly. Improper handling may result in accidents, injury, or create a fire hazard.

- Lamp life may differ from lamp to lamp and according to the environment of use. There is no guarantee of the same life for each lamp. Some lamps may fail or terminate their life in a shorter period of time than other similar lamps.
- If the projector indicates that the lamp should be replaced, i.e., if the LAMP REPLACE indicator lights up, replace the lamp with a new one IMMEDIATELY after the projector has cooled down. (Follow carefully the instructions in the Lamp Replacement section of this manual.) Continuous use of the lamp with the LAMP REPLACE indicator lighted may increase the risk of lamp explosion.
- A Lamp may explode as a result of vibration, shock or degradation as a result of hours of use as its lifetime draws to an end. Risk of explosion may differ according to the environment or conditions in which the projector and lamp are being used.

IF A LAMP EXPLODES, THE FOLLOWING SAFETY PRECAUTIONS SHOULD BE TAKEN.

If a lamp explodes, disconnect the projector's AC plug from the AC outlet immediately. Contact an authorized service station for a checkup of the unit and replacement of the lamp. Additionally, check carefully to ensure that there are no broken shards or pieces of glass around the projector or coming out from the cooling air circulation holes. Any broken shards found should be cleaned up carefully. No one should check the inside of the projector except those who are authorized trained technicians and who are familiar with projector service. Inappropriate attempts to service the unit by anyone, especially those who are not appropriately trained to do so, may result in an accident or injury caused by pieces of broken glass.

Warning Indicators

The WARNING indicators show the state of the function which protects the projector. Check the state of the WARNING indicators and the POWER indicator to take proper maintenance.

The projector is shut down and the WARNING TEMP. indicator is blinking red.

When the temperature inside the projector reaches a certain level, the projector will be automatically shut down to protect the inside of the projector. The POWER indicator is blinking while the projector is being cooled down. When the projector has cooled down enough (to its normal operating temperature), it can be turned on again by pressing the ON/STAND-BY button.

✓Note:

- The WARNING TEMP. indicator continues to blink even after the temperature inside the projector returns to normal. When the projector is turned on again, the WARNING TEMP. indicator stops blinking.

Then check the matters below:

- Did you provide appropriate space for the projector to be ventilated? Check the installing condition to see if the air vents of the projector are not blocked.
- Has the projector been installed near an Air-Conditioning/ Heating Duct or Vent? Move the installation of the projector away from the duct or vent.
- Is the filter clean? Clean the filter periodically or replace it with a new one.

The projector is shut down and all five indicators are blinking.

When the projector detects an abnormal condition, it will be automatically shut down to protect the inside of the projector and all five indicators on the top panel blink. In this case, unplug the AC power cord and plug it, and then turn on the projector once again to verify operation. If the projector cannot be turned on and these indicators are still blinking, unplug the AC power cord and contact the service station.



CAUTION

DO NOT LEAVE THE PROJECTOR WITH THE AC POWER CORD CONNECTED UNDER AN ABNORMAL CONDITION. IT MAY RESULT IN FIRE OR ELECTRIC SHOCK.

Top Control

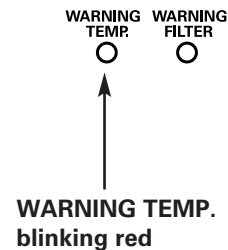

Top Control

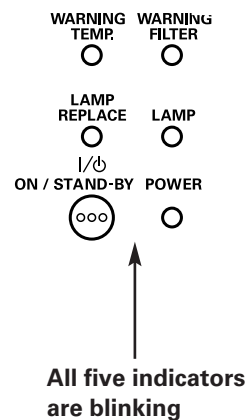

Maintenance and Filter Cleaning

Cleaning the Projection Lens

Unplug the AC power cord before cleaning.

Gently wipe the projection lens with a cleaning cloth that contains a small amount of non-abrasive camera lens cleaner, or use a lens cleaning paper or commercially available air blower to clean the lens.

Avoid using an excessive amount of cleaner. Abrasive cleaners, solvents, or other harsh chemicals might scratch the surface of the lens.

When the projector is not in use, replace the lens cap.

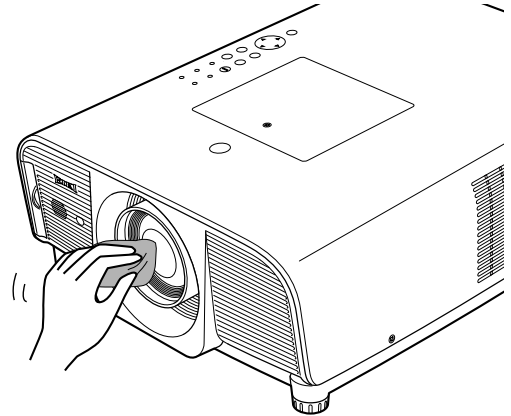

Cleaning the Projector Cabinet

Unplug the AC power cord before cleaning.

Gently wipe the projector body with a soft dry cleaning cloth. When the cabinet is heavily soiled, use a small amount of mild detergent and finish with a soft dry cleaning cloth. Avoid using an excessive amount of cleaner. Abrasive cleaners, solvents, or other harsh chemicals might scratch the surface of the cabinet.

When the projector is not in use, put the projector in an appropriate carrying case to protect it from dust and scratches.

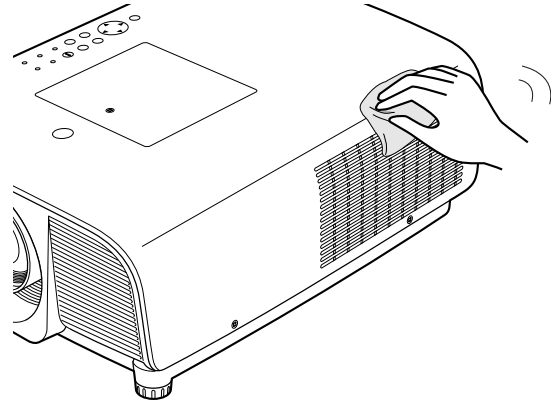

Appendix

Troubleshooting

Before calling your dealer or service center for assistance, check the items below once again.

- Make sure you have properly connected the projector to peripheral equipment as described on pages 22–24.
- Make sure all equipment is connected to AC outlet and the power is turned on.
- When the projector does not project an image from the connected computer, restart the computer.

Problem:

– Solutions

No power

- Plug the power cord of the projector into the AC outlet.
 - See if the POWER indicator is lit.
 - Wait 90 seconds after the projector is turned off when turning the projector back on. The projector can be turned on after the POWER indicator stops blinking. See on page 26.
 - Check the WARNING TEMP. indicator. If the WARNING TEMP. indicator is blinking, the projector cannot be turned on. See page 67.
 - Check the projection lamp. See page 65.
 - Unlock the Key lock function for the projector. See page 59.
-

Image is out of focus.

- Adjust focus of the projector. See pages 29, 31.
 - Provide proper distance between the projector and projection screen. See page 20.
 - Check the projection lens to see if it needs cleaning. See page 68.
 - Moving the projector from a cool to warm place may result in moisture condensation on the projection lens. In such cases, leave the projector off and wait until condensation evaporates.
-

No image

- Check the connection between your computer or video equipment and the projector. See pages 22–24.
 - See if the input signal is correctly output from your computer. Some laptop computers may need to change the setting for monitor output when connecting to the projector. See your computer's instruction manual for the setting.
 - It takes about 30 seconds to display an image after turning on the projector.
 - See if the selected system is corresponding with your computer or video equipment. See pages 36, 38.
 - Select correct input source once again through menu operation. See page 35.
 - Make sure the temperature is not out of the specified Operating Temperature (41 °F–95 °F [5 °C–35 °C]).
-

**Image is Left/Right reversed.
Image is Top/Bottom reversed.**

- Check the Ceiling/Rear function. See page 50.
 - Check the Ceiling function. See page 50.
-

No sound

- Check the audio cable connection from audio input source.
 - Adjust the audio source.
 - Press the Volume + button. See page 30.
 - Press the Mute button. See page 30.
-

<i>Some displays are not seen during the operation.</i>	– Check the Display function. See page 57.
<i>PIN code dialog box appears at start-up.</i>	– PIN code lock is being set. Input a PIN code (the “1234” or numbers you have set). See pages 25, 60–61.
<i>The Remote Control does not work.</i>	<ul style="list-style-type: none">– Check the batteries.– Make sure no obstruction is between the projector and remote control.– Make sure you are not too far from the projector when using the remote control. Maximum operating range is 16.4’ (5 m).– Make sure that the remote control code conforms to the projector’s code. See page 57.– Unlock the Key lock function for the remote control. See page 59.
<i>Cooling fans are still running after the AC power cord is unplugged.</i>	– This is a normal condition. The fans are running about one minute even after disconnecting the AC power cord.

WARNING :

High voltages are used to operate this projector. Do not attempt to open the cabinet.

If problems still persist after following all operating instructions, contact the dealer where you purchased the projector or the service center. Specify the model number and explain about the problem. We will advise you how to obtain service.



The CE Mark is a Directive conformity mark of the European Community (EC).



This symbol on the nameplate means the product is Listed by Underwriters Laboratories Inc. It is designed and manufactured to meet rigid U.L. safety standards against risk of fire, casualty and electrical hazards.

Menu Tree

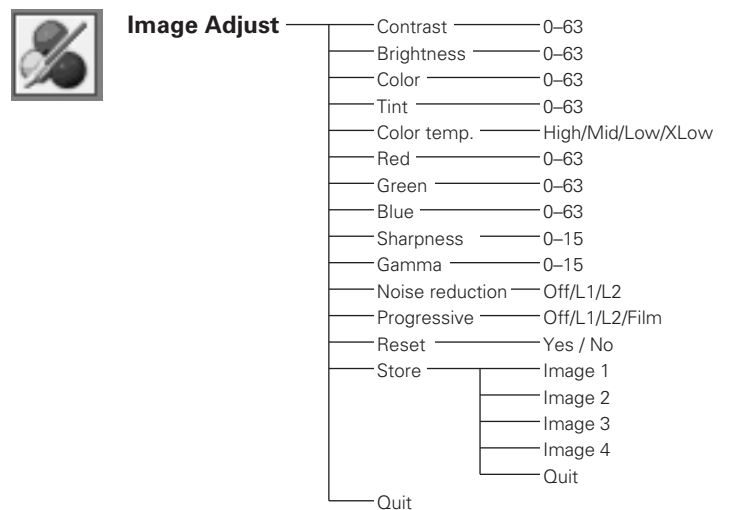
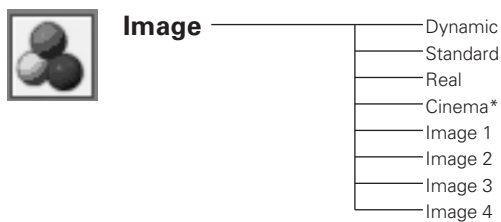
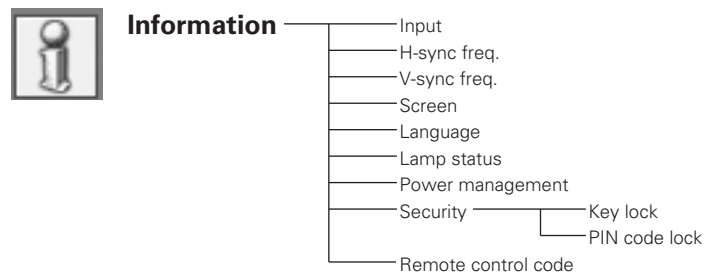
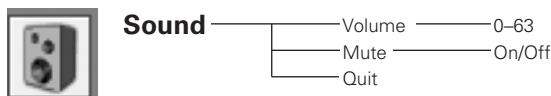
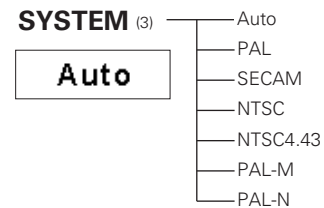
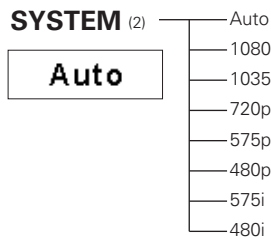
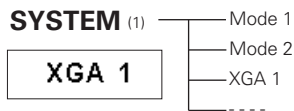
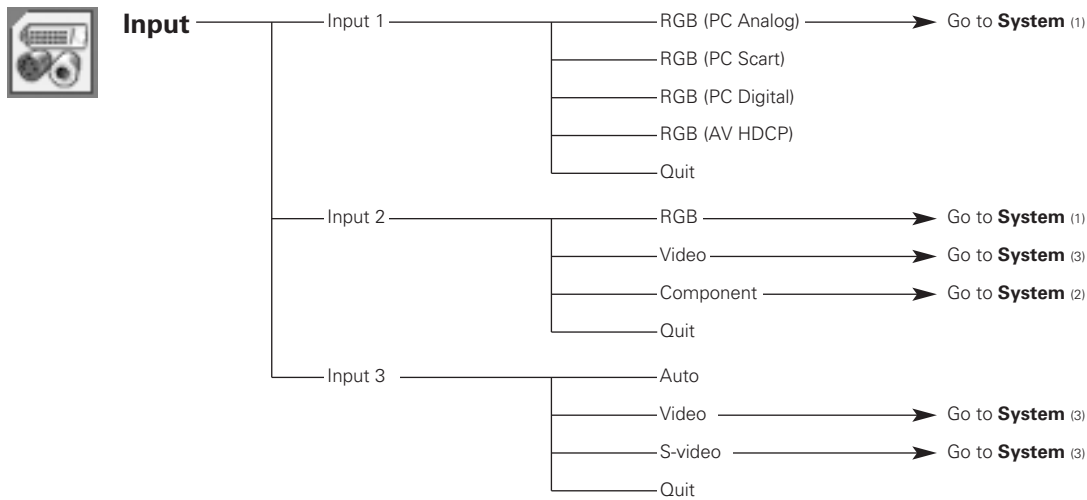

✓ **Note:**

• The Menu display varies depending on the input signal.



PC Adjust

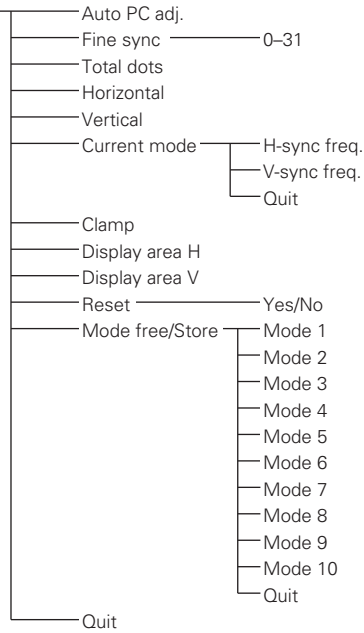

Setting

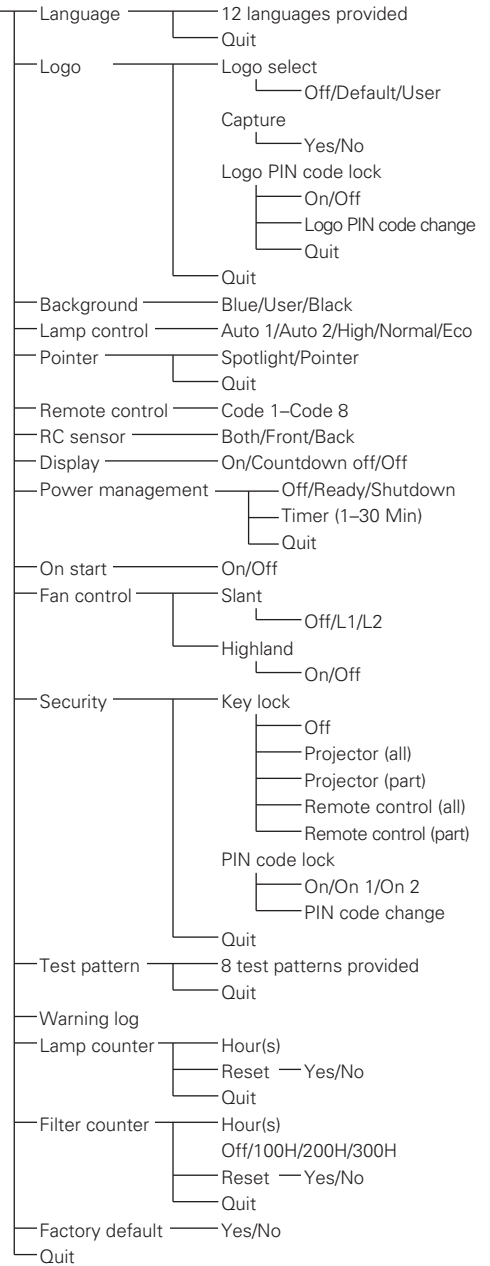

Screen

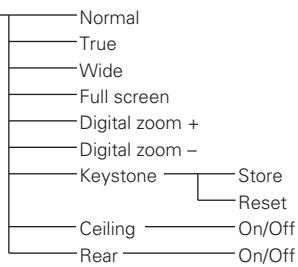

✓Note:

•The Menu display varies depending on the input signal.

Indicators and Projector Condition

Check the indicators for the projector condition.

WARNING TEMP. indicator



Indicators			Projector Condition
POWER green	LAMP red	WARNING TEMP. red	
●	●	●	The projector is off. (The AC power cord is unplugged.)
○	●	●	The projector is in stand-by mode. Press the ON/STAND-BY button to turn on the projector.
○	○	●	The projector is operating normally.
○ [⚡]	●	○ [⚡]	The temperature inside the projector is abnormally high. The projector cannot be turned on. When the projector is cooled down enough and the temperature returns to normal, the POWER indicator stops blinking and the projector can be turned on. (The WARNING TEMP. indicator keeps blinking.) Check and clean the filter.
○	●	○ [⚡]	The projector has been cooled down enough and the temperature returns to normal. When turning on the projector, the WARNING TEMP. indicator stops blinking. Check and clean the filter.
○ [⚡]	●	●	The projector is preparing for stand-by or the projection lamp is being cooled down. The projector cannot be turned on until cooling is completed and the POWER indicator stops blinking.
POWER, LAMP, WARNING TEMP., WARNING FILTER, and LAMP REPLACE indicators are blinking all together.		○ [⚡]	The projector detects an abnormal condition and cannot be turned on. Unplug the AC power cord and plug it again to turn on the projector. If the projector is turned off again, unplug the AC power cord and contact the dealer or the service center. Do not leave the projector on. It may cause an electric shock or a fire hazard.
○ [⚡]	○	●	The projector is in the Power management mode.

○ ● ● ● lighting

○[⚡] ● ● ● blinking

● ● ● ● off

WARNING FILTER indicator

Indicators			Projector Condition
POWER green	LAMP red	WARNING FILTER orange	
○	○	⦿	The filter is clogged. Stop using the projector immediately and clean or replace the filter (see below).
Filter warning red icon 			
—	—	○	The Filter counter reached a set time. Clean or replace the filter as soon as possible.
Filter warning yellow icon 			

If filter clogging is detected during operations, the Filter warning icon (red) appears on the screen and the WARNING FILTER indicator blinks orange, urging you to clean or replace the filter. Stop using the projector immediately and clean or replace the filter. The WARNING FILTER indicator and Filter warning icon will not be turned off until the filter is cleaned or replaced by a new one.



Filter warning icon (red) appears on the screen when the projector detects filter clogging.

✓Note:

- The Filter warning icon (red) will not appear during “Freeze” (p.31), or “Now show” (p.32).

LAMP REPLACE indicator

Indicators			Projector Condition
POWER green	LAMP red	LAMP REPLACE yellow	
●	●	⦿	The lamp cannot light up. (The projector is preparing for stand-by or the projection lamp is being cooled down. The projector cannot be turned on until cooling is completed.)
○	●	⦿	The lamp cannot light up. (The lamp has been cooled down enough and the projector is in stand-by mode and ready to be turned on with the ON/STAND-BY button.)
—	—	○	The lamp has been used overtime. Replace the lamp immediately and then reset the lamp counter. The indicator will be turned off after resetting the counter.

*When the projection lamp reaches its end of life, the LAMP REPLACE indicator lights yellow. When this indicator lights yellow, replace the projection lamp with a new one promptly. Reset the lamp counter after replacing the lamp. See pages 65–66.

Compatible Computer Specifications

Basically this projector can accept the signal from all computers with the V- and H-Frequency mentioned below and less than 140 MHz of Dot Clock.

PC Adjustment is limited when selecting these modes.

ON-SCREEN DISPLAY	RESOLUTION	H-Freq. (kHz)	V-Freq. (Hz)	ON-SCREEN DISPLAY	RESOLUTION	H-Freq. (kHz)	V-Freq. (Hz)
VGA 1	640 x 480	31.47	59.88	SXGA 1	1152 x 864	64.20	70.40
VGA 2	720 x 400	31.47	70.09	SXGA 2	1280 x 1024	62.50	58.60
VGA 3	640 x 400	31.47	70.09	SXGA 3	1280 x 1024	63.90	60.00
VGA 4	640 x 480	37.86	74.38	SXGA 4	1280 x 1024	63.34	59.98
VGA 5	640 x 480	37.86	72.81	SXGA 5	1280 x 1024	63.74	60.01
VGA 6	640 x 480	37.50	75.00	SXGA 6	1280 x 1024	71.69	67.19
VGA 7	640 x 480	43.269	85.00	SXGA 7	1280 x 1024	81.13	76.107
MAC LC13	640 x 480	34.97	66.60	SXGA 8	1280 x 1024	63.98	60.02
MAC 13	640 x 480	35.00	66.67	SXGA 9	1280 x 1024	79.976	75.025
480p	640 x 480	31.47	59.88	SXGA 10	1280 x 960	60.00	60.00
575p	768 x 575	31.25	50.00	SXGA 11	1152 x 900	61.20	65.20
480i	—	15.625	50.00 (Interlace)	SXGA 12	1152 x 900	71.40	75.60
575i	—	15.734	60.00 (Interlace)	SXGA 13	1280 x 1024	50.00	86.00 (Interlace)
SVGA 1	800 x 600	35.156	56.25	SXGA 14	1280 x 1024	50.00	94.00 (Interlace)
SVGA 2	800 x 600	37.88	60.32	SXGA 15	1280 x 1024	63.37	60.01
SVGA 3	800 x 600	46.875	75.00	SXGA 16	1280 x 1024	76.97	72.00
SVGA 4	800 x 600	53.674	85.06	SXGA 17	1152 x 900	61.85	66.00
SVGA 5	800 x 600	48.08	72.19	SXGA 18	1280 x 1024	46.43	86.70 (Interlace)
SVGA 6	800 x 600	37.90	61.03	SXGA 19	1280 x 1024	63.79	60.18
SVGA 7	800 x 600	34.50	55.38	SXGA 20	1280 x 1024	91.146	85.024
SVGA 8	800 x 600	38.00	60.51	SXGA+ 1	1400 x 1050	63.97	60.19
SVGA 9	800 x 600	38.60	60.31	SXGA+ 2	1400 x 1050	65.35	60.12
SVGA 10	800 x 600	32.70	51.09	SXGA+ 3	1400 x 1050	65.12	59.90
SVGA 11	800 x 600	38.00	60.51	MAC21	1152 x 870	68.68	75.06
MAC 16	832 x 624	49.72	74.55	WXGA 1	1366 x 768	48.36	60.00
XGA 1	1024 x 768	48.36	60.00	WXGA 2	1360 x 768	47.70	60.00
XGA 2	1024 x 768	68.677	84.997	WXGA 3	1376 x 768	48.36	60.00
XGA 3	1024 x 768	60.023	75.03	WXGA 4	1360 x 768	56.16	72.00
XGA 4	1024 x 768	56.476	70.07	WXGA 6	1280 x 768	47.776	59.87
XGA 5	1024 x 768	60.31	74.92	WXGA 7	1280 x 768	60.289	74.893
XGA 6	1024 x 768	48.50	60.02	WXGA 8	1280 x 768	68.633	84.837
XGA 7	1024 x 768	44.00	54.58	UXGA 1	1600 x 1200	75.00	60.00
XGA 8	1024 x 768	63.48	79.35	UXGA 2	1600 x 1200	81.25	65.00
XGA 9	1024 x 768	36.00	87.17 (Interlace)	UXGA 3	1600 x 1200	87.5	70.00
XGA 10	1024 x 768	62.04	77.07	UXGA 4	1600 x 1200	93.75	75.00
XGA 11	1024 x 768	61.00	75.70	UXGA 5	1600 x 1200	106.25	85.00
XGA 12	1024 x 768	35.522	86.96 (Interlace)	720p	1280 x 720	45.00	60.00
XGA 13	1024 x 768	46.90	58.20	1035i	1920 x 1035	33.75	60.00 (Interlace)
XGA 14	1024 x 768	47.00	58.30	1080i	1920 x 1080	33.75	60.00 (Interlace)
XGA 15	1024 x 768	58.03	72.00	1080i	1920 x 1080	28.125	50.00 (Interlace)
MAC 19	1024 x 768	60.24	75.08				

When an input signal is digital from the DVI terminal, refer to the chart below.
 PC Adjust Menu cannot be selected when Input 1 [RGB (PC digital)] is selected in the Input Menu.

ON-SCREEN DISPLAY	RESOLUTION	H-Freq. (KHz)	V-Freq. (Hz)	ON-SCREEN DISPLAY	RESOLUTION	H-Freq. (KHz)	V-Freq. (Hz)
D-VGA	640 x 480	31.47	59.94	D-SXGA 1	1280 x 1024	63.98	60.02
D-480p	640 x 480	31.47	59.88	D-SXGA 2	1280 x 1024	60.276	58.069
D-575p	768 x 575	31.25	50.00	D-SXGA 3	1280 x 1024	31.65	29.8
D-SVGA	800 x 600	37.879	60.32	D-SXGA+ 1	1400 x 1050	63.97	60.19
D-XGA	1024 x 768	43.363	60.00	D-720p	1280 x 720	45.00	60.00
D-WXGA 1	1366 x 768	48.36	60.00	D-1035i	1920 x 1035	33.75	60.00 (Interface)
D-WXGA 2	1360 x 768	47.70	60.00	D-1080i	1920 x 1080	33.75	60.00 (Interface)
D-WXGA 3	1376 x 768	48.36	60.00	D-1080i	1920 x 1080	28.125	50.00 (Interface)
D-WXGA 4	1360 x 768	56.16	72.00				
D-WXGA 5	1366 x 768	46.50	50.00				
D-WXGA 6	1280 x 768	47.776	59.87				
D-WXGA 7	1280 x 768	60.289	74.893				
D-WXGA 8	1280 x 768	68.633	84.837				

✓Notes:

- When the input signal is D-SXGA 1, D-SXGA 2, and D-SXGA 3, images may not be displayed properly depending on computers
- Specifications are subject to change without notice..

Technical Specifications

Mechanical Information

Projector Type	Multi-media Projector
Dimensions (W x H x D)	13.7" x 6.46" x 17.48" (348.1 mm x 164 mm x 444 mm) (Not including adjustable feet)
Net Weight	19.2 lbs (8.7 kg)
Feet Adjustment	0° to 5.0°

Panel Resolution

LCD Panel System	1.0" TFT Active Matrix type, 3 panels
Panel Resolution	1,024 x 768 dots
Number of Pixels	2,359,296 (1,024 x 768 x 3 panels)

Signal Compatibility

Color System	PAL, SECAM, NTSC, NTSC4.43, PAL-M, and PAL-N
High Definition TV Signal	480i, 480p, 575i, 575p, 720p, 1035i, and 1080i
Scanning Frequency	H-sync. 15 kHz–100 kHz, V-sync. 50 Hz–100 Hz

Optical Information

Projection Image Size (Diagonal)	Adjustable from 30" to 300" (LC-XG300, LC-XG250)
Throw Distance	3.9'–32.8' (1.2 m–10.0 m)
Projection Lens	F=1.7 to 2.1, f=33 to 43 mm with motor zoom and focus
Projection Lamp	300 W

Interface

Input 1	Digital (DVI-D) x 1, Analog (Mini D-sub 15 pin) x 1
Input 2	BNC Type x 5 (G or Video/Y, B or Cb-Pb, R or Cr-Pr, HV and V)
Input 3	RCA Type x 1, Mini DIN 4 pin x 1
AUDIO IN	Audio 1 (Mini Type stereo), Audio 2 (Mini Type stereo), Audio 3 (RCA Type) x 2
Analog Out	Mini D-sub 15 pin x 1
Audio Out	Audio (Mini Type stereo) x 1
R/C Jack	Mini Type (Wired Remote) x 1
Control Port	Mini DIN 8 pin x 1
USB Connector	USB Series B x 1
Option	Pj-to NetDirector Connector Terminal x 1

Audio

Internal Audio Amp	1.0 W RMS
Built-in Speaker	1 speaker, ø1.1" (28 mm)

Power

Voltage and Power Consumption	AC 100–120 V (4.6A Max. Ampere), 50/60 Hz (The U.S.A and Canada) AC 200–240 V (2.3A Max. Ampere), 50/60 Hz (Continental Europe)
-------------------------------	--

Operating Environment

Operating Temperature	41°F–95°F (5°C–35°C)
Storage Temperature	14°F–140°F (-10°C–60°C)

Remote Control

Battery	AAA or LR03 Type x 2
Operating Range	16.4' (5 m/±30°)
Dimensions	1.8" (W) x 1.0" (H) x 5.7" (D) (45 mm x 25 mm x 145 mm)
Net Weight	3.5 oz (99 g) (including batteries)
Laser Pointer	Class II Laser (Max. Output: 1 m W/Wave length: 640–660 nm)

Accessories

Owner's Manual (CD-ROM)
Quick Reference Guide
AC Power Cord
Remote Control and Batteries
VGA Cable
USB Cable
Lens Cap (for LC-XG300/XG250)
Lens Mount Cover (for LC-XG300L/XG250L)
PIN Code Label

- The specifications are subject to change without notice.
- LCD panels are manufactured to the highest possible standards. Even though 99.99% of the pixels are effective, a tiny fraction of the pixels (0.01% or less) may be ineffective by the characteristics of the LCD panels.

Optional Parts

The parts listed below are optionally available. When ordering those parts, specify the item name and Model No. to the sales dealer.

	<i>Model No.</i>
Long Zoom Lens	: AH-23541
Short Zoom Lens	: AH-23511
Control Cable	: AT-72021
PJ-to NetDirector	: PjNET-30

PJ Link Notice

This projector is compliant with PJLink Standard Class 1 of JBMIA (Japan Business Machine and Information System Industries Association). The projector supports all commands defined by PJLink Class 1 and is verified conformance with PJLink Standard Class 1.

Projector Input		PJLink Input	Parameter
Input 1	RGB (PC Analog)	RGB 1	11
	RGB (Scart)	RGB 2	12
	RGB (PC Digital)	DIGITAL 1	31
	RGB (AV HDCP)	DIGITAL 2	32
Input 2	Video	VIDEO 1	21
	Component	VIDEO 2	22
	RGB	RGB 3	13
Input 3	Auto	VIDEO 3	23
	Video	VIDEO 4	24
	S-video	VIDEO 5	25
Input 4	Network	NETWORK 1	51

PJLink is a registered trademark of JBMIA and pending trademark in some countries.



Configurations of Terminals

INPUT 1/ANALOG OUT

Terminal: Analog RGB (Mini D-sub 15 pin)

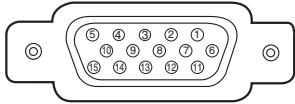

1	Red (R/Cr) Input/Output	9	----
2	Green (G/Y) Input/Output	10	Ground (Vert.sync.)
3	Blue (B/Cb) Input/Output	11	Ground/ ----
4	----	12	----
5	Ground (Horiz.sync.)	13	Horiz. sync. Input/Output (Composite H/V sync.)
6	Ground (Red)	14	Vert. sync.
7	Ground (Green)	15	----
8	Ground (Blue)		

DVI-D TERMINAL (DIGITAL)

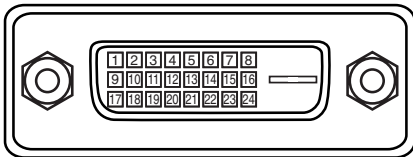

1	T.M.D.S. Data2-	9	T.M.D.S. Data1-	17	T.M.D.S. Data0-
2	T.M.D.S. Data2+	10	T.M.D.S. Data1+	18	T.M.D.S. Data0+
3	T.M.D.S. Data2 Shield	11	T.M.D.S. Data1 Shield	19	T.M.D.S. Data0 Shield
4	No Connect	12	No Connect	20	No Connect
5	No Connect	13	No Connect	21	No Connect
6	DDC Clock	14	+5V Power	22	T.M.D.S. Clock Shield
7	DDC Data	15	Ground (for +5V)	23	T.M.D.S. Clock+
8	Analog Vert. sync	16	Hot Plug Detect	24	T.M.D.S. Clock-

USB CONNECTOR (Series B)

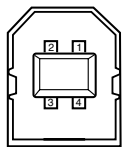

1	Vcc
2	- Data
3	+ Data
4	Ground

CONTROL PORT CONNECTOR

Terminal : Mini DIN 8-PIN

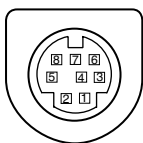

1	R X D	5	RTS/CTS
2	----	6	T X D
3	----	7	GND
4	GND	8	GND

PIN Code Number Memo

Write down the PIN code number in the column below and keep it with this manual securely. If you forgot or lost the number and unable to operate the projector, contact the service station.

PIN Code Lock No.

--	--	--	--

Factory default set No: 1 2 3 4*

Logo PIN Code Lock No.

--	--	--	--

Factory default set No: 4 3 2 1*

* Should the four-digit number be changed, the factory set number will be invalid.

While the projector is locked with the PIN code...

Put the label below (supplied) on in a prominent place of the projector's body while it is locked with a PIN code.

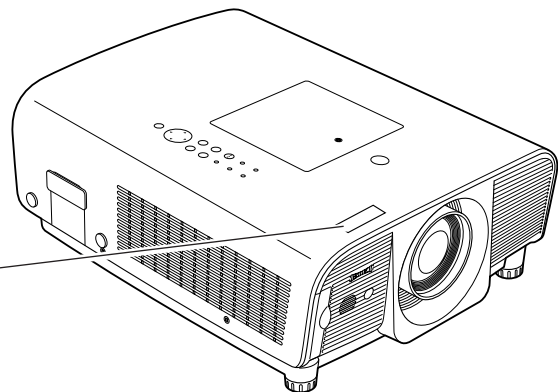

Dimensions

Unit: inch (mm)

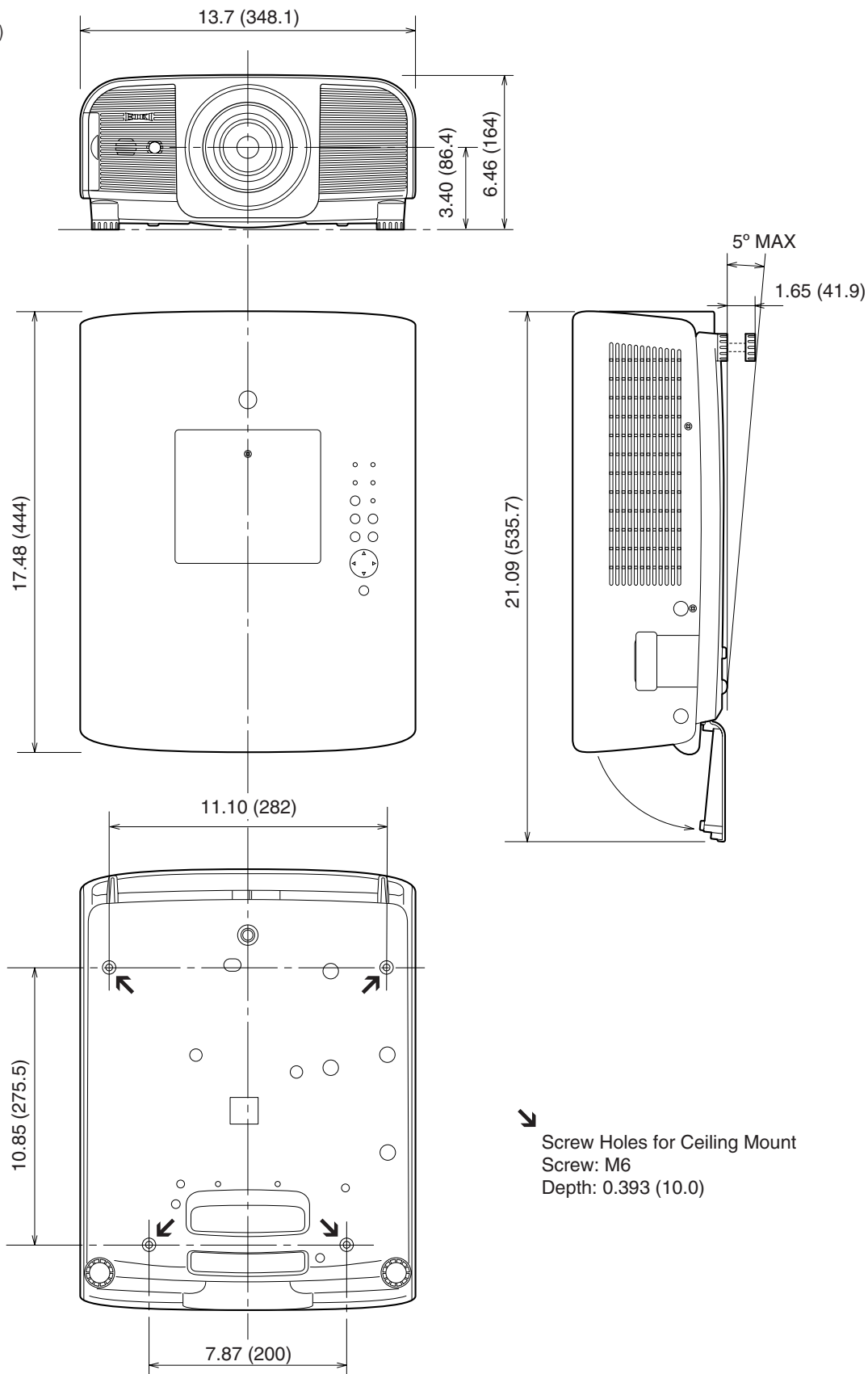

EIKI

A-key to better communications

U.S.A.

EIKI International, Inc.
30251 Esperanza
Rancho Santa Margarita
CA 92688-2132
U.S.A.
Tel : 800-242-3454 (949)-457-0200
Fax : 800-457-3454 (949)-457-7878
E-Mail : usa@eiki.com

Deutschland & Österreich

EIKI Deutschland GmbH
Am Frauwald 12
65510 Idstein
Deutschland
Tel : 06126-9371-0
Fax : 06126-9371-14
E-Mail : info@eiki.de

Canada

EIKI CANADA - Eiki International, Inc.
P.O. Box 156, 310 First St. - Unit 2,
Midland, ON, L4R 4K8, Canada
Tel : 800-563-3454 (705)-527-4084
Fax : 800-567-4069 (705)-527-4087
E-Mail : canada@eiki.com

Eastern Europe

EIKI CZECH spol. s.r.o.
Umělecká 15
170 00 Praha 7
Czech Republic
Tel : +42 02 20570024
+42 02 20571413
Fax : +42 02 20571411
E-Mail : easterneurope@eiki.de

Japan & Worldwide

EIKI Industrial Company Limited.
4-12 Banzai-Cho, Kita-Ku, Osaka,
530-0028 Japan
Tel : +81-6-6311-9479
Fax : +81-6-6311-8486

WorldWide Website <http://www.eiki.com>