

myprojectorlamps.com

**The most trusted, dependable name
in projector lamp sales.**



<http://www.myprojectorlamps.com>



<http://www.myprojectorlamps.ca>



<http://www.myprojectorlamps.eu>

The following projector manual has not been modified or altered in any way.

EIKI

MULTIMEDIA PROJECTOR

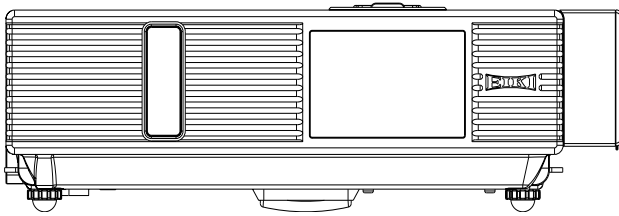

LC-XDP3500

OWNER'S MANUAL

Projector

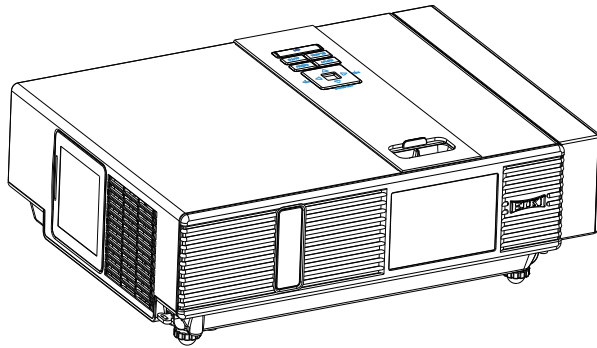

About the Owner's Manual

Please read the owner's manual thoroughly to ensure correct usage of the projector and its features.

After reading, store the owner's manual in a safe place for future reference.

Features

1. Dress up Design
2. Designed for tough environment
3. Side change lamp
4. Side change filter
5. Quick power off
6. Advanced Anti-theft features
7. Five auto features (Auto Search, Auto Sync, Auto Ceiling, Auto Keystone and Auto Filter Alert)
8. Seven display modes (Natural, Cinema, Daylight, Green board, White Board, Black Board and User)
9. Built-in 8W speaker
10. Logo capture
11. Image freeze function
12. Digital zoom adjustment
13. Long life Anti-dust filter

The content of this manual is subject to change without prior notice.

All rights reserved.

Issue of edition 0809.10_01

Contents

About Owner's Manual

Contents	1
Contents of Your Box	3-A
Safety Instructions	4
Safety Labels	5
Part Names	6
Projector.....	6
Control Panel.....	7
Rear.....	8
Setting Up	9
Arrangement.....	9
Power ON / OFF.....	10
Setting Up The Projector	11
Ceiling Mounted Installation Guide	12
Adjusting The Projector's Elevation	13
How To Connect.....	14
Remote Control	16
Menu Operation	18
How To Operate On-Screen Display	18
MENU (PC Mode)	19
Picture Menu (PC Mode).....	19
Audio Menu (PC Mode).....	20
Setting Menu (PC Mode).....	21
MENU (Video Mode)	22
Picture Menu (Video Mode).....	22
Audio Menu (Video Mode)	23
Setting Menu (Video Mode).....	24

MENU	25
Advanced Menu.....	25
Presentation Menu.....	28
Security Menu.....	30
PIN Key In Operation.....	33
Network Control Software Application	34
Before Use	35
Before Using Network Control Software	35
Projector Auto Search.....	36
Modify the Projector Setting	38
Registering And Configuring the Projector.....	39
Delete.....	39
Projector Setting.....	40
System Setting / Monitor / Default Setting / Auto Detect Optimal Setting.....	41
Link.....	43
Control Panel Window Introduction.....	44
Power Control / Input Source / Function Key	44
Function Key / Projector Status.....	45
Network Control Window Introduction.....	46
Maintenance Of Projector	47
Air Filter / Replacing the Air Filter	47
Lamp / Replacing New Lamp.....	48
Other Care	50
Troubleshooting.....	51
Indicator.....	51
Error For Machine Defects.....	52
List of Supported Monitor Displays	54
Appendix	

Contents of Your Box

Check-list of your accessories

Please make sure that following items are included in the box, along with the main unit. If any items missing, contact your dealer.

1. Projector

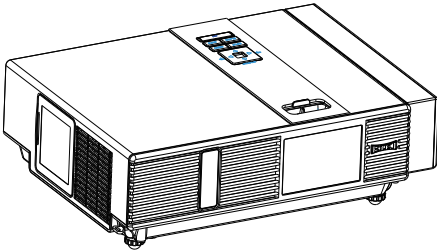

2. Computer cable

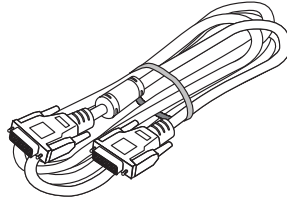

3. Power cord

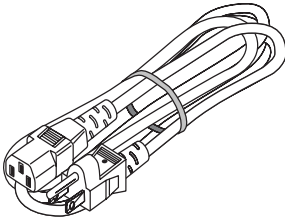

4. Quick Start Guide

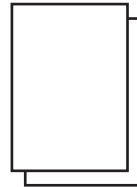

5. Owner's Manual CD

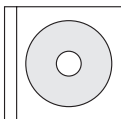

6. Remote control



Contents of Your Box

7. USB Cable

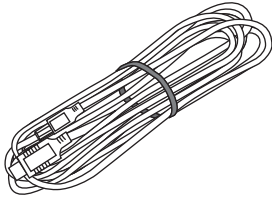

8. Soft Bag



9. Anti-smoke filter(with mesh) (Part Number:13340231)

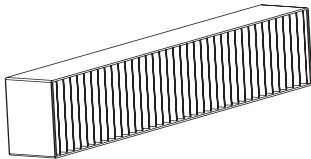

Safety Instructions

The projector is designed and tested to meet the latest standards for safety of information technology equipment. However, to ensure safe use of this product, it is important that you follow the instructions mentioned in this manual and marked on the product.



WARNING / CAUTION

1. If a problem occurs

- If smoke or strange odors arise, continued use could result in fire or electrical shock.
- If there is no image or sound, or the sound is distorted in the projector. In some cases, immediately remove the power cable from the power outlet. After making sure that the unit has stopped, contact your dealer for repairs. Never attempt to repair by yourself because this is dangerous.

2. Do....

- Place the projector in a stable horizontal position.
- Put the projector in a cool place, and ensure that there is sufficient ventilation.
- Consult with your dealer before a special installation such as suspending from a ceiling.

3. Do not....

- Do not place the projector on an unstable, slanted or vibrating surface such as a wobbly or inclined stand.
- Do not cover the projector's vents. Keep a space of 20 cm or more between the projector and other objects such as walls.
- Do not place the projector on metallic goods.
- Do not place the projector on carpet, cushions or bedding. Do not place the projector in direct sunlight or near hot objects such as heaters.
- Do not place anything near the projector lens or vents, or on top of the projector.
- Do not place anything that may be sucked into or stick to the vents beside the projector.
- Do not use this projector if there is no image or sound, or if the sound is distorted.
- Do not place this projector in a container containing liquid.

4. While connecting, make sure that the shape of the cable's connector fits the port to connect with. Be sure to tighten the screws on connectors with screws.
5. Do not disassemble or modify the projector and accessories.
6. Be careful not to damage the cables, and do not use damaged cables.
7. Use appropriate accessories or otherwise designed cables. Ask your dealer about non-accessory cables that may have other lengths.
8. Make sure that devices are connected to the correct ports. An incorrect connection may result in malfunction or damage to the device and the projector.
9. Do not look through the lens when the lamp is on.

Do not look through the lens when the lamp is on. The powerful light could adversely affect vision. Use special caution in households where children are present.

10. A strong light is emitted when the projector is powered on. Do not look into the lens of the projector or look inside of the projector.



Do not place the projector upon either side to project an image.

NO SIDEWARD



Do not point the projector down to project an image.

NO DOWNWARD

Safety Labels

Safety labels are used on or within the projector to alert you to items or areas requiring your attention.

WARNING LABEL

<p>WARNING</p> <ul style="list-style-type: none"> BEFORE OPERATING, PLEASE READ USER'S MANUAL. BEFORE REMOVING SCREWS, DISCONNECT POWER CABLE. DO NOT BLOCK VENTING OPENINGS. 	<p>WARNUNG</p> <ul style="list-style-type: none"> VOR DEM EINSATZ DIE BEDIENUNGSANLEITUNG LESEN. VOR DEM ENTFERNEN DER SCHRAUBEN DAS NETZKABEL ABTRENNEN. LÜFTUNGSÖFFNUNGEN NICHT BLOCKIEREN. 	<p>AVIS</p> <ul style="list-style-type: none"> VEUILLEZ LIRE LE MODE D'EMPLOI AVANT L'USAGE. DEBRANCHER LE CABLE D'ALIMENTATION AVANT DE RETIRER LES VIS. NE BOUCHEZ PAS LES ORIFICES DE VENTILATION.
<p>警告</p> <ul style="list-style-type: none"> ご使用になる前に、取扱説明書をお読みください。 取外しをする前に電源プラグをコンセントから抜いてください。 	<p>警告</p> <ul style="list-style-type: none"> 操作前、必ず詳細な使用説明書を読みます。 移設前、必ず電源プラグをコンセントから抜いてください。 冷却ファン口を内部温度上昇を防ぐため必ず開放してください。 	<p>警告</p> <ul style="list-style-type: none"> 操作前、必ず詳細な使用説明書を読みます。 移設前、必ず電源プラグをコンセントから抜いてください。 冷却ファン口を内部温度上昇を防ぐため必ず開放してください。

USA ONLY This product contains mercury. Disposal of mercury may be regulated due to environmental considerations. For disposal or recycling information, please contact your local authorities or the Electronic Industries Alliance: www.eiaa.org.

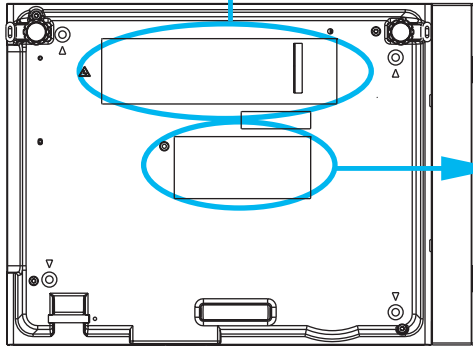

EMI LABEL



LAMP DOOR WARNING LABEL

<p>CAUTION HOT</p> <p>TURN THE POWER OFF AND WAIT 1 HOUR BEFORE CHANGING THE LAMP.</p> <p>WARNING HEISS!</p> <p>SCHALTEN SIE DAS GERÄT AUS UND WARTEN SIE 1 STUNDE, BIS SIE DIE LAMPE WECHSELN.</p>	<p>ATTENTION CHAUD</p> <p>COUPER L'ALIMENTATION ET ATTENDRE 1 HEURE AVANT DE CHANGER LA LAMPE.</p> <p>高温注意</p> <p>ランプ交換は、電源を切った後、1時間待ってから行ってください。</p> <p>矢張り投影机電源后、必須冷却至少1小时后才进行更换灯泡。</p>
<p>CAUTION</p> <p>HIGH-PRESSURE LAMP MAY EXPLODE IF IMPROPERLY HANDLED.</p> <p>REPLACE WITH SAME TYPE NUMBER LAMP DO NOT CLEAN THE AIR FILTER WITH WATER OR ANY LIQUID.</p> <p>DO NOT OPERATE THE PROJECTOR WITHOUT THE AIR FILTER.</p> <p>VORSICHT!</p> <p>DIE HOCHDRUCKLAMPE KANN BEI FALSCHER HANDHABUNG EXPLODIEREN. NUR MIT EINER LAMPE DES GLEICHEN TYPES AUSTAUSCHEN.</p> <p>VERWENDEN SIE ZUR REINIGUNG DES LUFFTFILTERS WEDER WASSER NOCH ANDERE FLÜSSIGKEITEN.</p> <p>BETRIEBEN SIE IHREN PROJEKTOR NICHT OHNE DEN LUFFTFILTERS.</p>	<p>ATTENTION</p> <p>LA LAMPE À HAUTE PRESSION PEUT EXPLOSER SI ELLE EST MANIPULÉE INCORRECTEMENT.</p> <p>REMPLEZ PAR UNE LAMPE AVEC UN NUMERO DE TYPE IDENTIQUE.</p> <p>N'UTILISEZ PAS D'EAU NI UN AUTRE LIQUIDE POUR NETTOYER LE FILTRE À AIR. NE FAITES PAS FONCTIONNER VOTRE PROJECTEUR SANS LE FILTRE À AIR.</p> <p>注意</p> <p>ランプは、同じタイプのものと交換してください。高圧の取扱いを誤ったときに、高圧ランプが破裂する恐れがあります。</p> <p>水やお湯で洗わないでください。</p> <p>フィルタをはずした状態で電源を入れないでください。</p> <p>高圧不正な処理でランプも也许会導致破裂。</p> <p>清潔用同类型的灯泡。</p> <p>请不要用水或清洗劑清洗濾網。</p> <p>沒有裝置濾網，請勿操作投影机。</p>

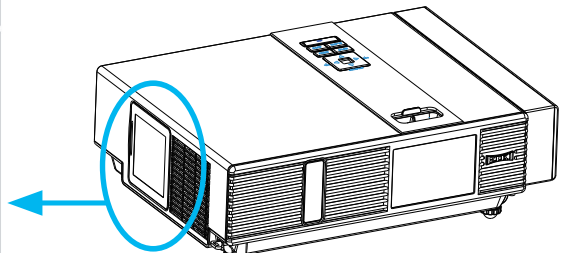

Projector

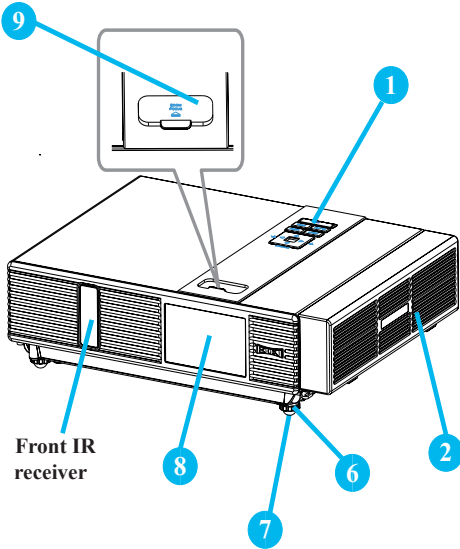

Front IR receiver

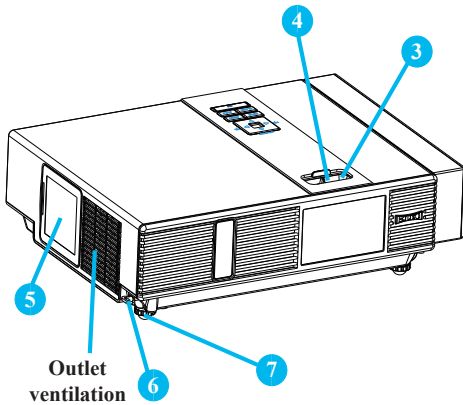

Outlet ventilation

1 Control panel

Operating system.

2 Filter cover

Prevents dust and other foreign particles from being drawn into projector.

Remove the filter cover to clean the air filter.

3 Focus ring

Use the focus ring to focus the projector image.

Rotate the focus ring until the image is clear.

4 Zoom ring

Use the zoom ring to adjust the size of the projected image.

Rotate the zoom ring until the image is the desired size.

5 Lamp door

The lamp unit is inside.

6 Foot adjust button

Lock / unlock the adjustable foot.

7 Front adjustable foot

Extend and retract to adjust the projection angle.

8 Anti-dust glass 9 Gate plate

Dustproof function.

Control Panel

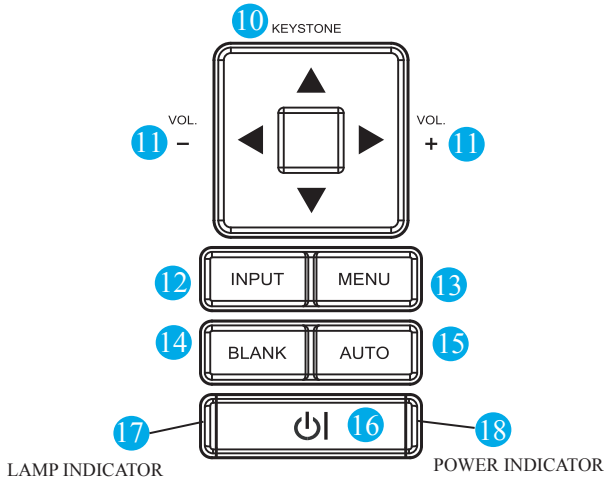

10 KEystone

Adjust the vertical keystone with menu-up, menu-down.

11 VOLUME + / -

Sound louder or lower.

12 INPUT

Select input source:



13 MENU

Display or hide the OSD main menu page.

14 BLANK

Blank the projected image. If the projector is left in blank mode for more than 15/30/60 minutes, the projector will automatically shut down.

15 AUTO

Automatically adjust the setting to match the current input.

16 (POWER)

Power on / operation mode, Standby mode, Cooling-down mode.

17 LAMP INDICATOR

Indicate a status in the projector internal temperature, lamp door properly closed or cooling down.

18 POWER INDICATOR

Light on or flash to indicate the operating status of the projector.

Rear

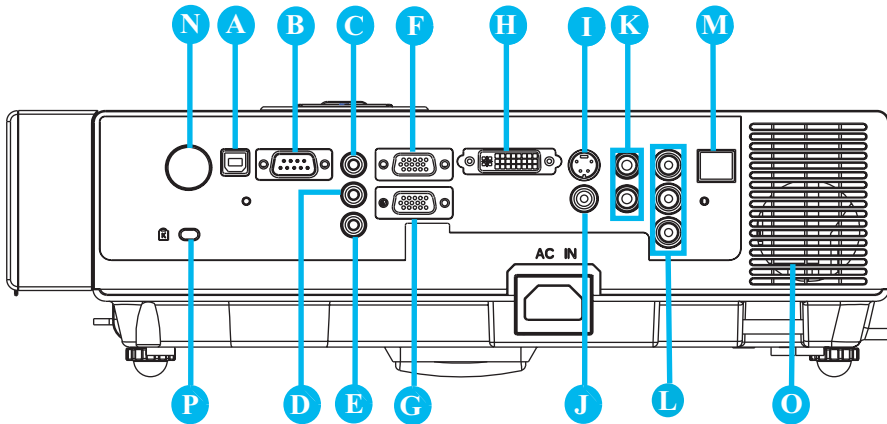

A MOUSE

Connect a USB mouse cable to a computer to control computer mouse functions.

B RS232

Serial data port for controlling the projector with a computer or other RS-232 control device.

C AUDIO IN 1 & D AUDIO IN 2

Mini jack port corresponds to computer input.

E AUDIO OUT

F RGB IN

Input analog RGB signal from a computer.

G RGB OUT

Connect an external monitor to this connection to view the “RGB IN” input.

H DVI-I IN

Input digital DVI-I signal from a computer.

I S-VIDEO

S-Video signal from a video source.

J VIDEO

Composite video signal from a video source.

K AUDIO IN 3, R / L

RCA type corresponds to video input.

L COMPONENT ,Y , Pb , Pr

Input Y,Pb,Pr signal from a DVD player.

M LAN

Please see page 34 Network Control Application for details.

N REAR IR RECEIVER

O SPEAKER

P Slot for Kensington Micro Saver Security System

Built-in Security Slot

This security slot supports the MicroSaver[®] Security System. MicroSaver[®] is a registered trademark of Kensington Microware Inc.

The logo is trademarked and owned by Kensington Microware Inc.

Setting Up

Arrangement

1. Before installation, make sure that the projector is turned off and the power cord is disconnected.
2. Do not set up and move the projector, while it is hot.
3. The distance between the projector and screen determines the actual image size. Refer to the table below to determine the screen size at a given distance.

Note: The dimensions in the table below are approximate.

Screen size (diagonal)		Distance (m)		Distance (feet)	
inch	m	Tele	Wide	Tele	Wide
40	1.0	1.36	1.11	4.47	3.62
60	1.5	2.07	1.69	6.78	5.54
70	1.8	2.42	1.98	7.93	6.51
80	2.0	2.77	2.28	9.09	7.47
100	2.5	3.48	2.87	11.40	9.40
150	3.8	5.24	4.33	17.18	14.21
200	5.1	7.00	5.80	22.96	19.03
250	6.4	8.76	7.27	28.74	23.84
300	7.6	10.52	8.74	34.52	28.66

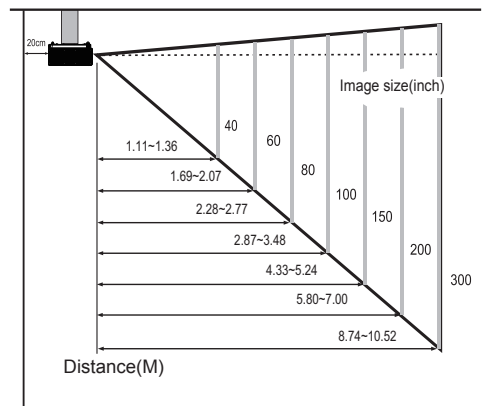
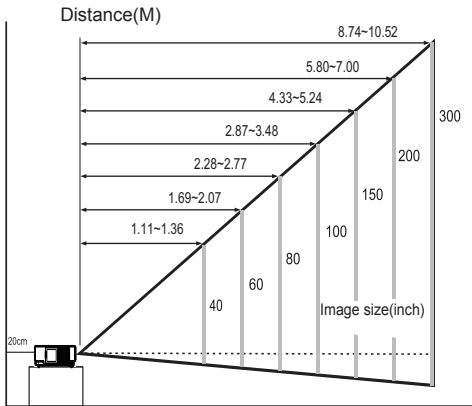

When installed against a wall, leave about 20cm (7.9in.) between the projector and the wall.

Power ON / OFF

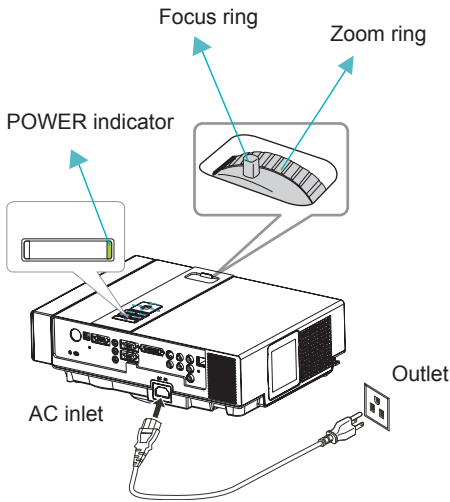

Turning On The Power

1. Make sure that power cord is firmly and correctly connected to the projector.
2. The POWER indicator will light up in green.
3. Press POWER button on the control panel or the remote control to turn on the projector.
4. Rotate the zoom ring to adjust the screen size.
5. Rotate the focus ring to adjust the focus.

! WARNING

- ★ A strong light is emitted when the projector's power is on. Do not look into the lens of the projector or look inside of the projector through any of the projector's openings.

1.



2.

Power off?
Please press



POWER
key again to power off.

3.

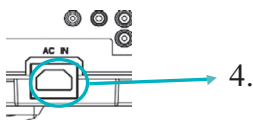
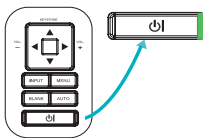

4.

Turning Off The Power

1. Press the POWER button on the control panel or the remote control. The "power off" confirmation message appears.
2. Press the POWER button again while the message appears.
3. When the projector enters "Standby" mode, the POWER indicator will light up in green.
4. If you don't use the projector, remove power cord.

! WARNING

- ★ Do not touch around the lamp cover and the exhaust vents during use or just after use, since it is too hot.

! CAUTION

- ★ Do not turn off the AC power for 60 seconds after the lamp is turned on. Doing so could cause premature lamp failure.

Setting Up

Setting Up The Projector

The projector supports the following four different projection methods.

1. Front projection

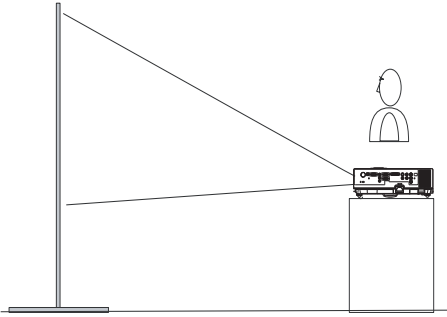

3. Rear ceiling projection

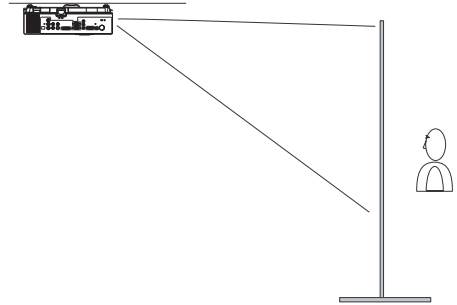

2. Rear projection

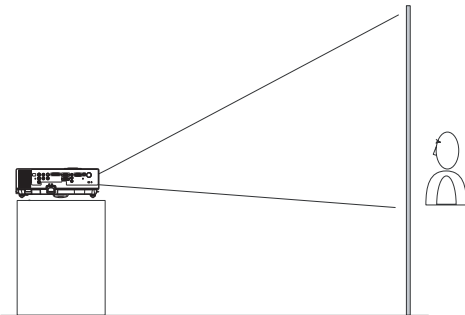

4. Front ceiling projection

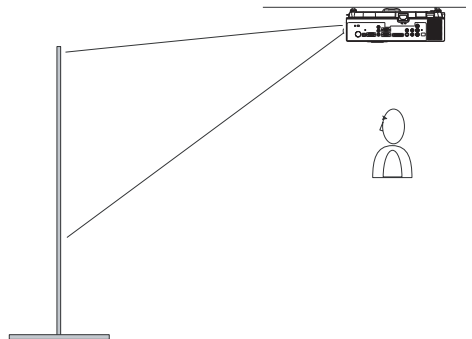

Special installation is required in order to suspend the projector from the ceiling. Please ask your dealer for details.

Ceiling Mounted Installation Guide

Attach ceiling mount at four-suspension bracket fixing points when suspending from a ceiling. Special installation is required in order to suspend the projector from the ceiling. Please ask your dealer for details.

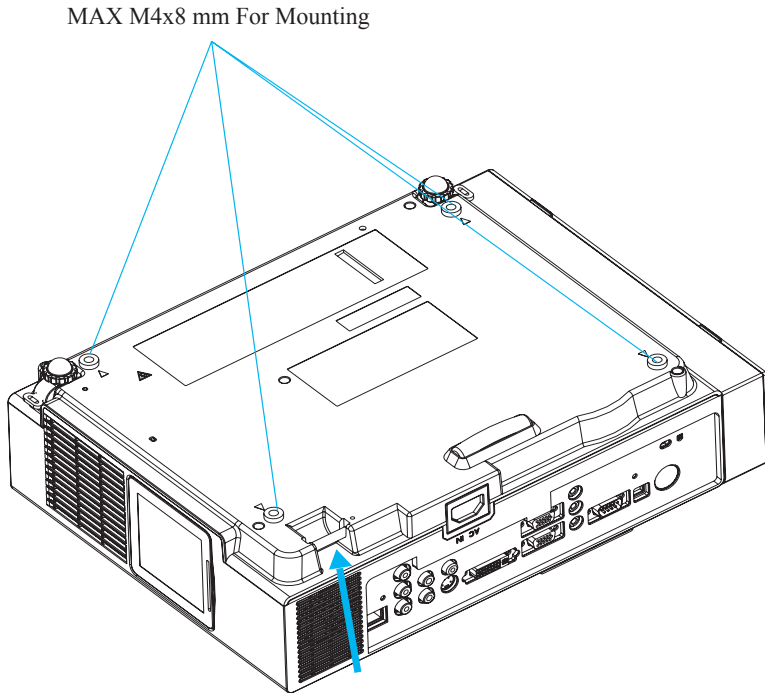

Security Anchor

The product is equipped with security anchor and PIN LOCK (See page 33 for details) functions to help prevent unauthorized removal of the projector.

WARNING

- ▶ Do not grasp the security anchor to carry projector, since it is not designed for it.
- ▶ The security anchor is not for comprehensive theft prevention measures. It is intended to be used as supplemental theft prevention measure.

Adjusting The Projector's Elevation

Use the adjustable foot at the front of the projector to set the image height.

- 1 Holding the projector, push the foot adjust buttons to loosen the front adjustable foot.
- 2 Position the front side of the projector to the desired height.
- 3 Release the foot adjust buttons in order to lock the front adjustable feet.
- 4 Please make sure that the front adjustable feet are locked.

CAUTION

- * The adjustment range of front adjustable foot is 0 to 8.5 degrees.
- * When the foot is adjusted, it may cause the shape of the projected image to become distorted. Use the keystone correction function to correct this distortion.

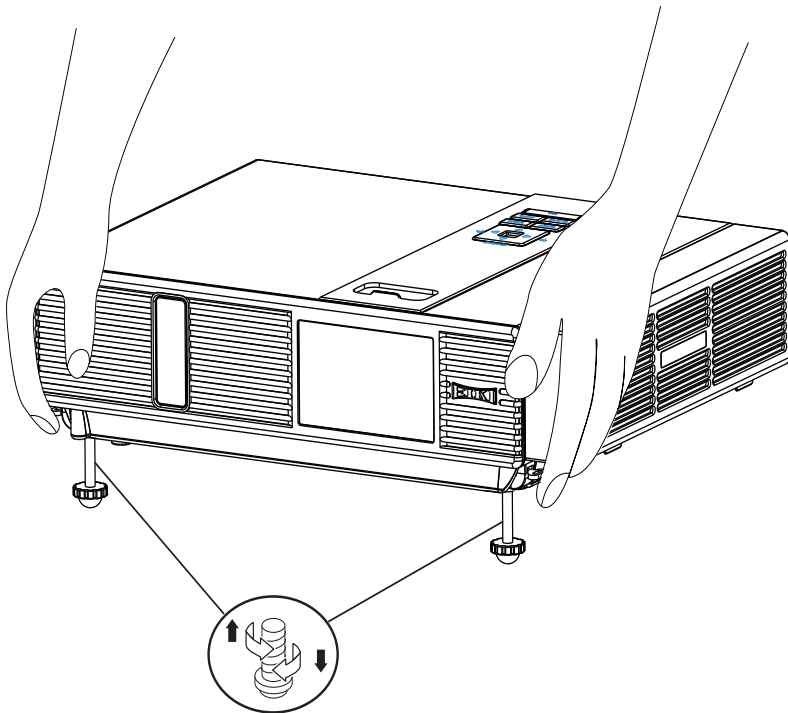

Setting Up

How To Connect

Laptop or desktop computer

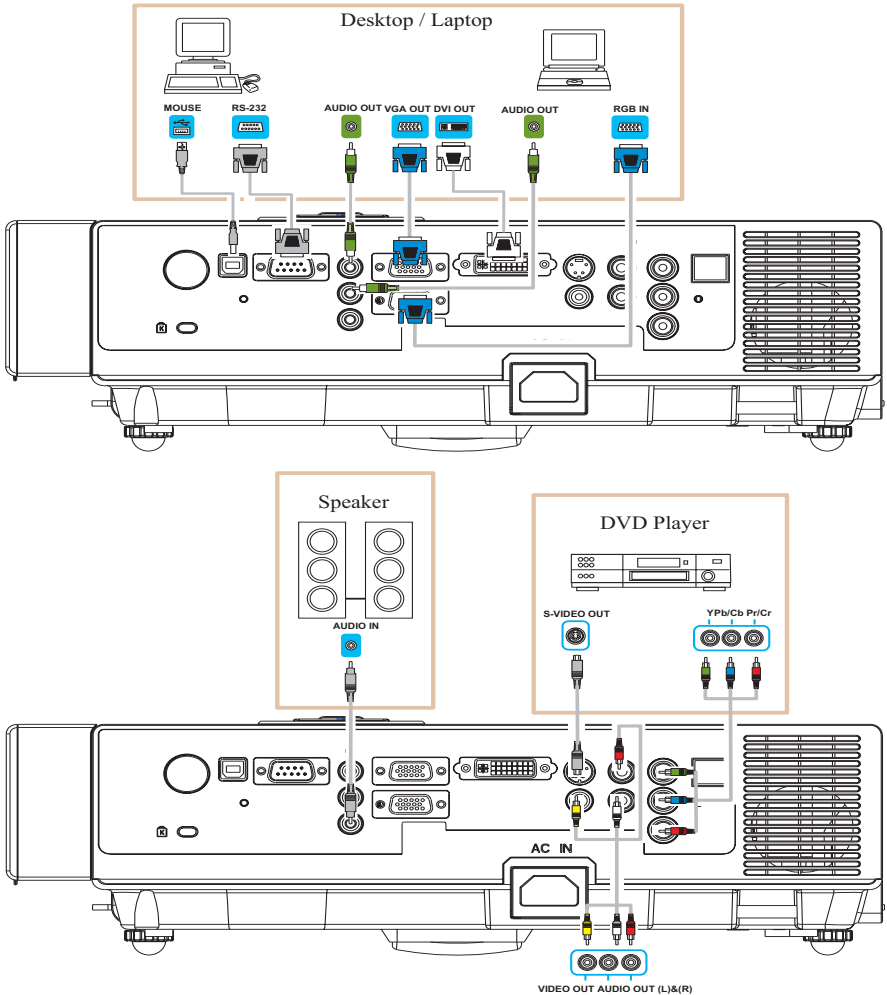

Before starting, make sure that the projector and computer are both turned off.

Connect the computer cable

Connect the computer cable from the computer to the projector's RGB IN. If needed, connect the MONITOR OUT to a monitor to view input from RGB IN. Tighten the screw on all connectors.

How To Connect

Laptop or desktop computer

Connect the audio cable if necessary

1. Please connect the audio cable to the AUDIO IN 1 if the computer cable is connected to the projector's RGB IN.
2. Please connect the audio cable to the AUDIO IN 2 if the computer cable is connected to the projector's DVI-I IN.
3. Please connect the audio cable to the AUDIO IN 3 if the video cables are connected to the VEDIO/S-VIDEO/Y,Pb,Pr port of the projector.

Connect USB Mouse

1. Before operating the wireless mouse, connect your computer and projector with supplied USB cable.
2. When a USB cable is connected to the computer and the projector, turn on the projector first, then the computer. If you turn on the computer first, the wireless mouse function may not operate properly.
3. When the projector and computer are turned on, the appropriate drivers should load automatically.

☞ If the selected video image is not displayed after the projector is turned on and the correct video source has been selected, please check whether the video source device is turned on and operating correctly. Also check whether the signal cables have been connected correctly.

☞ Many laptop computers may need to change the setting for monitor output when connecting to the projector. Usually a key combination like **Fn + F3** or CRT/LCD key turns the external display on / off. Locate a function key labeled CRT/LCD or a function key with a monitor symbol on the laptop. Press Fn and the labeled function key simultaneously. Refer to your laptop's documentation to find out your laptop's key combination.

Remote Control Batteries Installation

1. Remove the battery cover.
2. Load the batteries.
Make sure the poles are correctly oriented.
3. Close the battery cover.

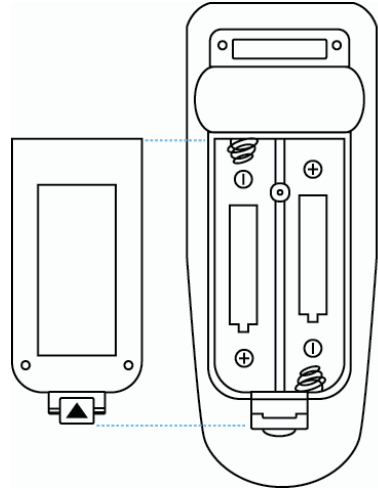

Caution

- ▶ Avoid excessive heat and humidity.
- ▶ Do not drop the remote control.
- ▶ If the remote control will not be used for an extended period, remove the batteries.
- ▶ Do not expose the remote control to water or moisture. This could result in malfunction.
- ▶ Replace the battery when remote control operation becomes sluggish or unresponsive.
- ▶ Do not place the remote control close to the cooling fan of the projector.
- ▶ Do not use batteries of different types at the same time.
- ▶ Do not mix a new battery with used one. Make sure the plus and negative terminals are correctly aligned when loading batteries.
- ▶ Dispose of batteries in accordance with environmental laws.
- ▶ Do not disassemble the remote control. If the remote control needs service, please contact your dealer.

Remote Control

POWER

Power on / operation mode, Standby mode, Cool down mode.

INPUT

Select input source :



MENU

Display or hide the On-Screen Display main menu page.



Press or to select On-Screen Display menu item.



Press or to select and adjust the function of On-Screen Display menu item or value.

LASER

Aim the remote control at the screen, press and hold button to activate the laser pointer.

MUTE

Mute audio.

AUTO

Refresh the current image.

BLANK

Hide the current image, become black color on the screen.



Press / / / button to move arrow direction of window.

MOUSE-L / MOUSE-R

The function is like mouse of desktop/ notebook.

Remote control's mouse functions only will work if the USB cable is connected (see page 15 for instructions)

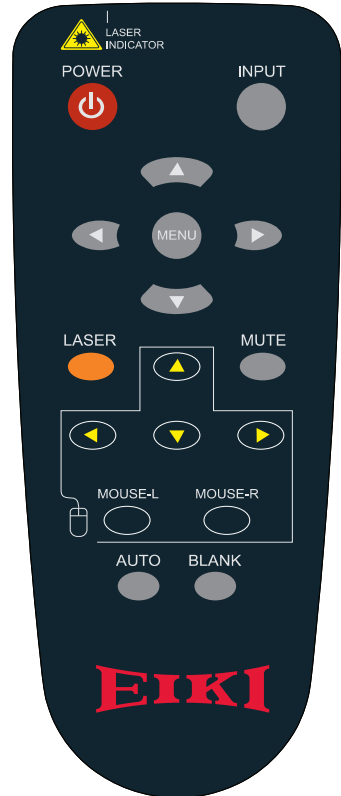

Menu Operation

How To Operate On-Screen Display

1. Press "Menu" button. Following menu will appear.
2. Choose the item you want to enter. Press up / down /left/ right button on control panel or remote control to adjust item or value.

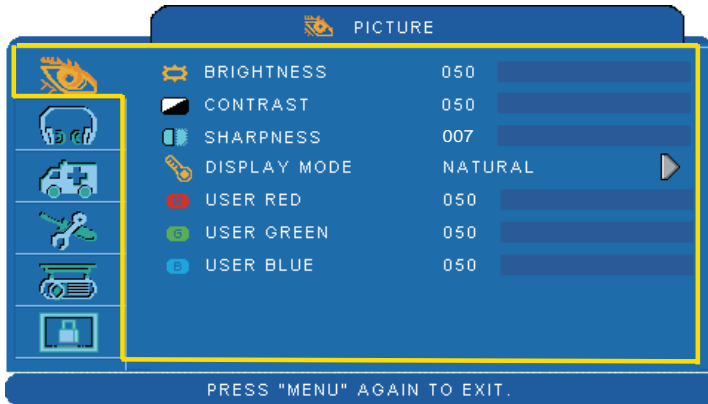

Up / Down / Right / Left button

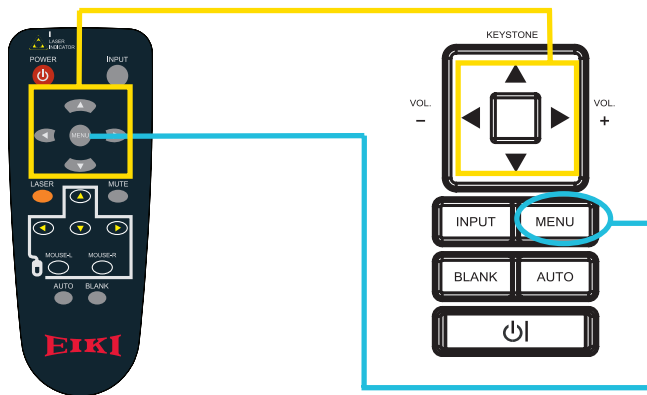

Menu button

Picture Menu

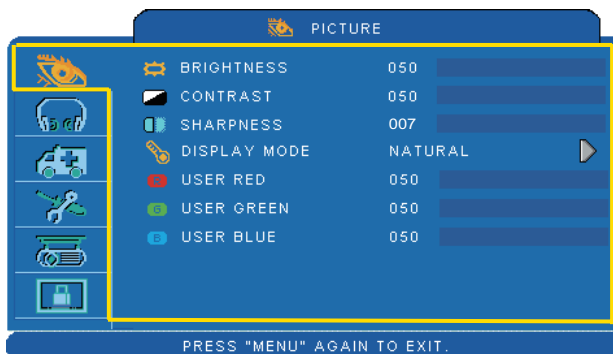

Step:

1. Use the ▲ / ▼ buttons to select an item.
2. Use the ◀ / ▶ cursor buttons to select an item or adjust the value.

Item	Selection	Description
BRIGHTNESS	000/100	Adjust the image brightness level.
CONTRAST	000/100	Adjust the image contrast level.
SHARPNESS	000/015	Adjusts the image sharpness.
DISPLAY MODE	NATURAL	Natural color.
	CINEMA	Enhance contrast ratio when displaying DVD contents.
	DAYLIGHT	Suitable when ambient light is strong.
	GREEN BOARD WHITE BOARD BLACK BOARD	Adjust the color settings to make the projected image on a (green, white, black) board more visible.
	USER	User Red 000/100 User Green 000/100 User Blue 000/100

Audio Menu

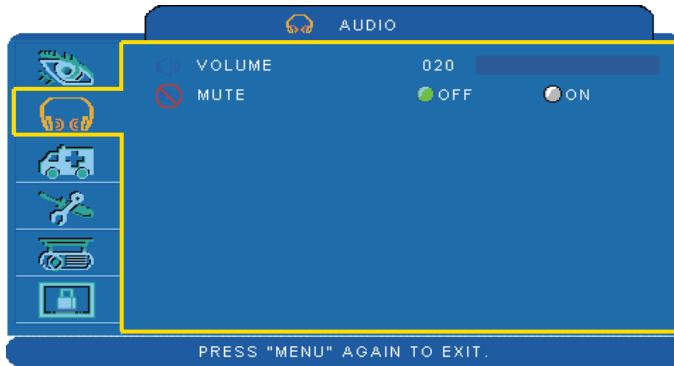

Step:

1. Use the ▲ / ▼ buttons to select an item.
2. Use the ◀ / ▶ buttons to select an item or adjust the value.

Item	Selection	Description
VOLUME	00/40	Adjust the volume.
MUTE	OFF/ON	Mute the volume OFF / ON.

Setting Menu

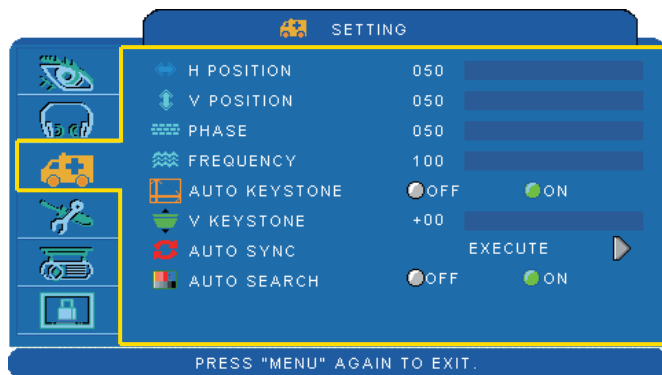

Step:

1. Use the ▲ / ▼ buttons to select an item.
2. Use the ◀ / ▶ buttons to select an item or adjust the value.

Item	Selection	Description
H POSITION	000/100	Move the image position horizontally. This function can be used under computer signal input only.
V POSITION	000/100	Move the image position vertically. This function can be used under computer signal input only.
PHASE	000/100	Adjust the image sharpness.
FREQUENCY	000/200	Set the horizontal scanning frequency.
AUTO KEYSTONE	OFF/ON	Correct keystone distortion in image automatically.
KEYSTONE V	-70/+70	Correct vertical keystone distortion in image manually.
AUTO SYNC	EXECUTE	Set all of the above setting automatically.
AUTO SEARCH	OFF/ON	Search signal source manually or automatically.

*DVI doesn't support H POSITION, V POSITION, PHASE, FREQUENCY and AUTO SYNC.

MENU (Video Mode)

Picture Menu

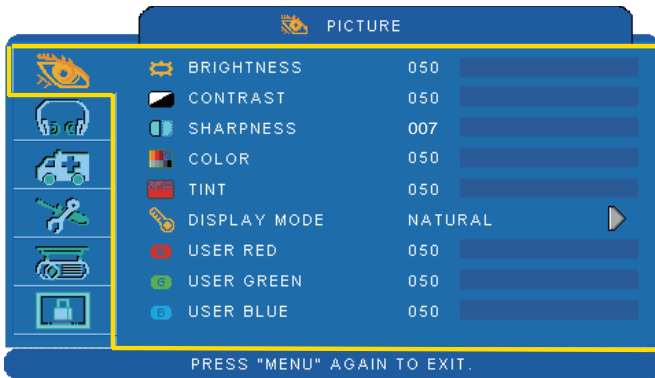

Step:

1. Use the ▲ / ▼ buttons to select an item.
2. Use the ◀ / ▶ cursor buttons to select an item or adjust the value.

Item	Selection	Description
BRIGHTNESS	000/100	Adjust the image brightness level.
CONTRAST	000/100	Adjust the image contrast level.
SHARPNESS	000/015	Adjusts the image sharpness.
COLOR	000/100	Adjust the strength of whole color. This function can be used under video signal, S-Video signal, or component video signal input only.
TINT	000/100	Adjust the image tint. This function can be used under video signal, S-Video signal, or component video signal.
DISPLAY MODE	NATURAL	Natural color.
	CINEMA	Enhance contrast ratio when displaying DVD contents.
	DAYLIGHT	Suitable when ambient light is strong.
	GREEN BOARD WHITE BOARD BLACK BOARD	Adjust the color settings to make the projected image on a (green, white, black) board more visible.
	USER	User Red User Green User Blue

Audio Menu

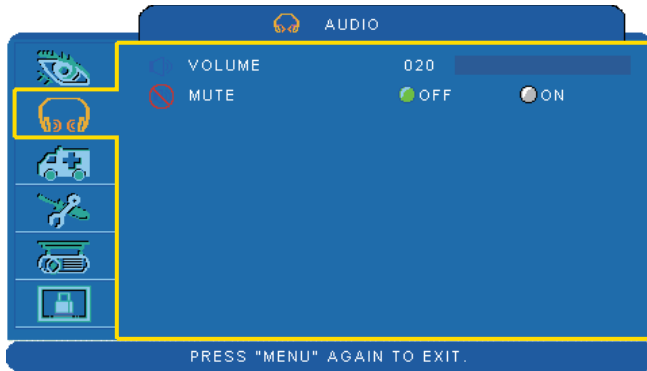

Step:

1. Use the ▲ / ▼ buttons to select an item.
2. Use the ◀ / ▶ buttons to select an item or adjust the value.

Item	Selection	Description
VOLUME	00/40	Adjust the volume.
MUTE	OFF/ON	Mute the volume OFF / ON.

Setting Menu

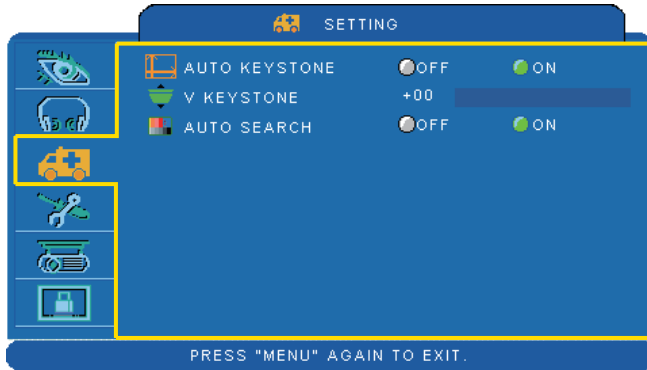

Step:

1. Use the ▲ / ▼ buttons to select an item.
2. Use the ◀ / ▶ buttons to select an item or adjust the value.

Item	Selection	Description
AUTO KEYSTONE	OFF/ON	Automatically Correct keystone distortion in image.
V KEYSTONE	-70/+70	Correct vertical keystone distortion in image manually.
AUTO SEARCH	OFF/ON	Search signal source manually or automatically.

Advanced Menu



Step:

1. Use the ▲ / ▼ buttons to select an item.
2. Use the ◀ / ▶ buttons to select an item or adjust the value.

Item	Selection	Description
ZOOM / PAN	EXECUTE	Execute digital zoom and pan function.
FREEZE	OFF/ON	Freeze the current image on the screen.
BLANK	OFF/ON	Hide the image. Display on the screen turns into black.
BLANK POWER OFF	15/30/60 Minute	Set power off time after "Blank".
RESET	EXECUTE	Reset all menu function to their factory default values.
RESIZE		4:3, 16:9, 1:1
LANGUAGE	ENGLISH	Select the language of the menu and on screen display message. English → 繁體中文 → 简体中文 → 日本語 Deutsch ← Français ← Dutch ← 한국어 Italiano → Polski → Português → Русский ไทย ← Українська ← Svenska ← Español
SELECT SOURCE	EXECUTE	Select the input source from: RGB 1 → RGB 2 → DVI-I S-Video ← Video ← Y,Pb,Pr
LOGO SETTING	EXECUTE	Customize the start-up logo.

Advanced Menu



LOGO SETTING

This function allows you to customize the start-up logo.

IMPORTANT:

To execute the logo function, you must enter the PIN code first.

Item	Selection	Description
LOGO MODE	DEFAULT	Select Mode(► cursor button)
	USER	The factory logo.
	OFF	The image you captured. The blank image. You can select color with background function.
LOGO CAPTURE	EXECUTE	Start to capture the image.(PC mode only)
BACKGROUND	BLACK BLUE WHITE	Set background color.
LOGO SIZE	ORIGINAL FULL	Display the captured image in original size and put in the center of the screen. Expand the image to full screen.

Advanced Menu

Logo Capture

How to use this function?

- ① Select Logo Capture item in the logo setting menu, then press ► button.
- ② Red frame will appear to select captures area.
- ③ Use 4 direction buttons to adjust the position of the frame.
- ④ Press “MENU” to start capturing and display a dialog.

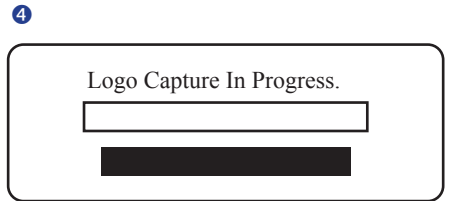
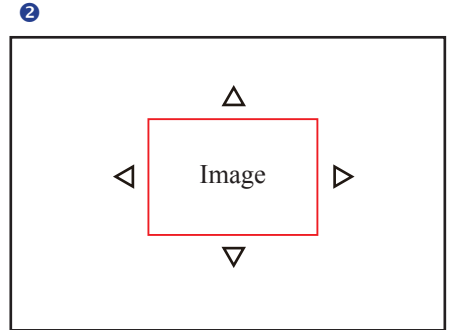

NOTE ► You can capture an image only in computer mode.
 ► The area that can be captured is 512 x 384 dots.

Presentation Menu

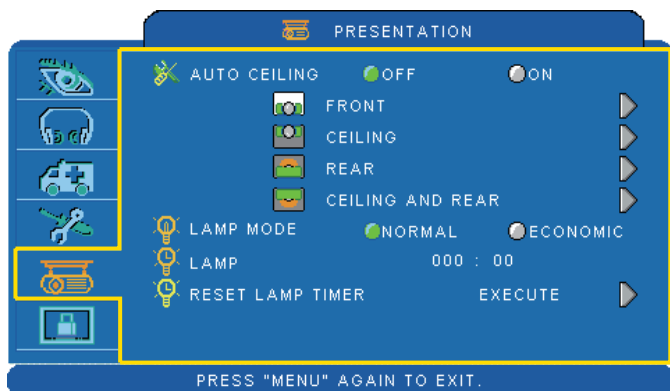

Step:

1. Use the ▲ / ▼ buttons to select an item.
2. Use the ◀ / ▶ buttons to select an item or adjust the value.

Item	Selection	Description
AUTO CEILING	OFF / ON	Automatically invert the image when the projector is turned upside down, i.e. when the projector is mounted on the ceiling.
FRONT	EXECUTE	Normal projection mode.
CEILING	EXECUTE	Mirror the image vertically, only for the projector mounted upside down.
REAR	EXECUTE	Mirror the image horizontally, only for projecting onto rear projection screen.
CEILING AND REAR	EXECUTE	Mirror the image horizontally and vertically. Projecting onto a rear projection screen while projector is upside down.
LAMP MODE	NORMAL / ECONOMIC	Switch lamp mode normal or ECO mode.
LAMP		Show lamp use time.
RESET LAMP TIMER	EXECUTE	After changing a new lamp, execute this function to reset the lamp timer.

Presentation Menu

Reset Lamp Timer

The lamp timer is the time counted after the last resetting. The usage time of the lamp is shown in the PRESENTATION Menu. Pressing the RESET button or the ► button displays a dialog.

To reset the lamp time, select the RESET using the ► button.

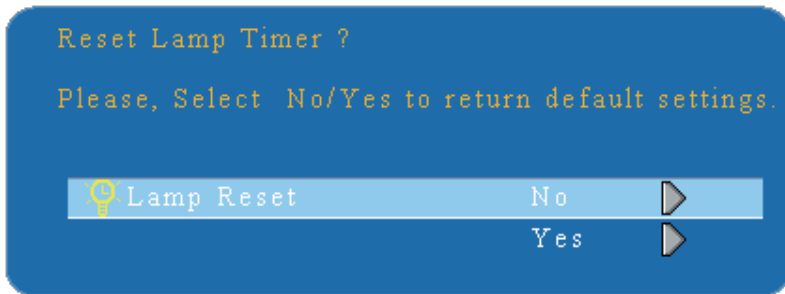

NOTE

- The replacement warning message is set to appear after about 2000 hours of lamp use in order to maintain the initial brightness. When replacement message appears, replace the lamp with a new one as soon as possible, even if the lamp is still workable..

Security Menu



Step:

1. Use the ▲ / ▼ buttons to select an item.
2. Use the ◀ / ▶ buttons to select an item or adjust the value.

Item	Selection	Description
PIN LOCK PROTECTION	OFF ON 1 ON 2	<p>OFF: Turn off PIN lock protection. ON 1: PIN code is needed only at the first time after AC power has been switched on. ON 2: PIN code is needed every time while the projector is turned on.</p> <div style="border: 1px solid black; padding: 5px;"> <p>⚠ CAUTION: Once the PIN code had been set, the projector cannot be used unless you enter the correct PIN code.</p> </div>
MODIFY PIN	EXECUTE	<ol style="list-style-type: none"> 1. Press “ MENU ” on the projector or remote control. 2. Use the ▶ button to select the MODIFY PIN item in the SECURITY category. 3. Press the ▶ button to change PIN LOCK PROTECTION mode. 4. Please enter the original PIN code. <ol style="list-style-type: none"> (a) If the PIN is correct, system will allow you to change a new PIN code. (b) If the PIN is incorrect, a “ Code Error ” message will appear. 5. Please enter a new PIN code. And then enter again to confirm. <div style="border: 1px solid black; padding: 5px;"> <p>NOTE:</p> <ol style="list-style-type: none"> (1) To change the PIN lock protection state, you must enter the PIN code first. (2) Please enter: 0000 for first-time use. (3) To avoid unnecessary trouble, if you activate the [PIN Lock Protection], it is highly recommended that you write down the PIN code and store it in a safe place. </div>

Security Menu



Step:

1. Use the ▲ / ▼ buttons to select an item.
2. Use the ◀ / ▶ buttons to select an item or adjust the value.

Item	Selection	Description
FILTER TIMER		Show the filter use time.
RESET FILTER TIMER	EXECUTE	Reset the filter timer after cleaning / changing filter.
FILTER COUNTER	500 hours 800 hours 1000 hours	Select (500 / 800 / 1000 hours) depending on the environment.(default : 500 hours). Please see next page.
MAC ADDR.		For LAN control module, "MAC ADDR." will be shown in "SECURITY" Menu. MAC address stands for unique Media Access Control address of LAN control module and displays with six groups of two hexadecimal digits.
CLOSED CAPTION	OFF(Default) C.C1 C.C2 C.C3 C.C4 T1 T2 T3 T4	The Closed Caption function intimates the sound effects, dialogue, and narration in the content of the television program or video source. Caption (C.C1~C.C4) : Display closed caption Text (T1~T4) : Display text data, which is for additional information such as news reports or a TV program guide. NOTE : This function is available only in video / S-Video source.

Auto Filter Alert

Auto Filter Alert in SECURITY category shows the air filter use time and alerts user to change filter. When the operating time reaches the set time, a warning message will appear on the screen to remind user of filter cleaning /replacing.

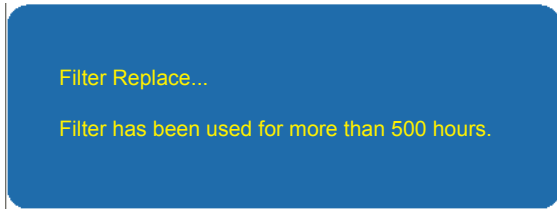

NOTE

► Please reset the Filter time only when you replace the filter.

PIN Key In Operation

When the projector is turned on and the PIN LOCK PROTECTION is set to [ON], the image will show as on the right side.

1. Press the MENU button on the projector or remote control. Enter PIN code by keypad or remote control.
2. How to enter a PIN code?
You can use control panel or remote control.

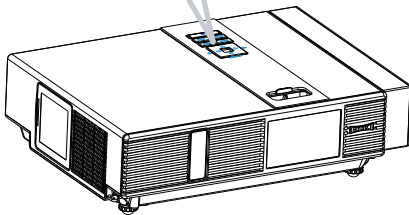
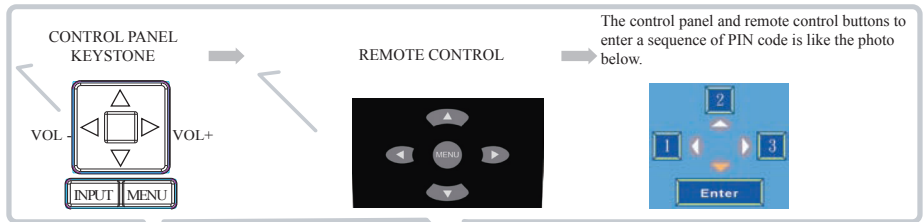
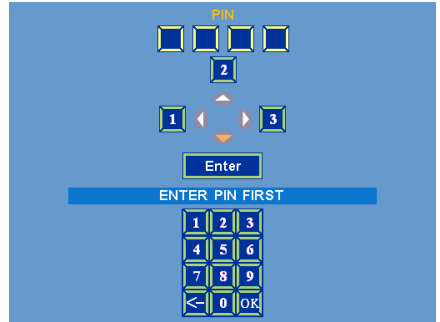

Refer to photo below to enter a sequence of PIN code by control panel or remote control buttons.

- (1) Press ◀ button: Select the [1]
- (2) Press ▲ button: Select the [2]
- (3) Press ▶ button: Select the [3]
- (4) Press ▼ button: Select the [Enter] move to next row.(4~6,7~9, ◀~OK)
- (5) Press ◀ (backspace) item:
In case you enter a wrong digit, select ◀ to delete the wrong digit you entered.
- (6) Press OK (backspace) item:
Once all four digits of the PIN are entered, select OK to confirm.

NOTE

- (1) Please enter: 0000 for first-time use.
- (2) If the PIN is incorrect, a ' Enter new code ' message will be shown. Please try again. If the PIN code input is incorrect for three times, a warning message will show up and the projector will shut itself down in 30 seconds.
- (3) If you have no idea about the PIN, please contact your dealer for help.

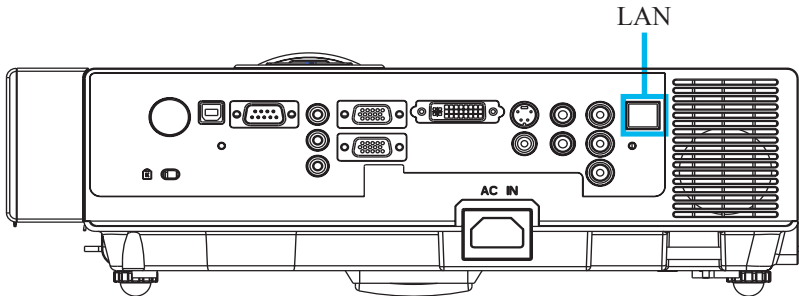

- ❶ Register the projector(s) which needs to be controlled.
“ Auto search ” can help you to seek the projector(s) source easily.
After registering in the work group, you can start to control the projector.
- ❷ Group the projector(s) into different sections.
You can monitor the status easily by GROUP NAME function in the network.
- ❸ Monitor the status for each projector.
 - a.You can manage and change the monitoring content by System Parameter Setting.
 - b.The Lamp timer, filter working time or system warning feedback etc. can be obtained by checking the status of projector(s).
- ❹ Control the booked projector(s).
The status can be refreshed and acquired by MONITOR functions; you can also operate the function easily by Network Control.

NOTE

To monitor and control the projector(including stand-by mode), the following conditions are needed to be ready:

- (1) Projector is powered on.
- (2) Projector is connected to network.
- (3) LED light of the projector network port shows normal. (Green light on, Orange twinkling)

* Stand-by mode indictor: Green LED (Power) on the projector’s control panel flashes.

Before Use

Before Using Network Control Software

- 1 If the system is Windows 2000, NT 4.0 or XP, the PC should be started by the Administrator.
- 2 Before starting the Network Control software, please check the following.
 - (1) The computer is installed with Network Control software.
 - (2) The projector is powered on and the LAN wire is well connected to the projector.
 - (3) Make sure the computer and projector can connect to network. Network Control software needs to arrange in TCP/IP network communication and the network cable.

Activate Network Control Software

- 1 Click Network control software icon.

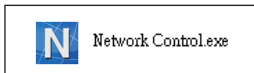

- 2 Monitor window will show as Graph 1.

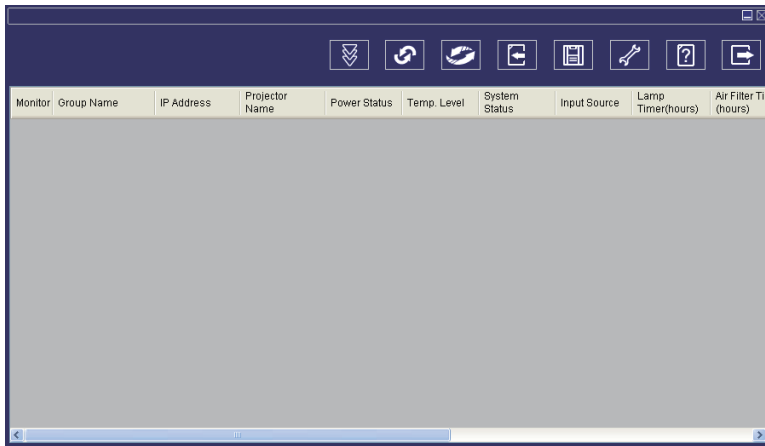

<Graph 1>

Before Use

Projector Auto Search.

- 1 Click the  (Projector search), located projector will show on the network correctly. (Graph2)

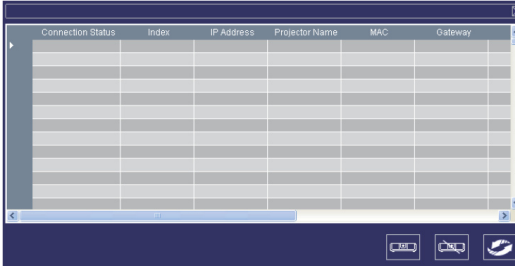

Connection Status	Index	IP Address	Projector Name	MAC	Gateway
-------------------	-------	------------	----------------	-----	---------

<Graph 2>

NOTE

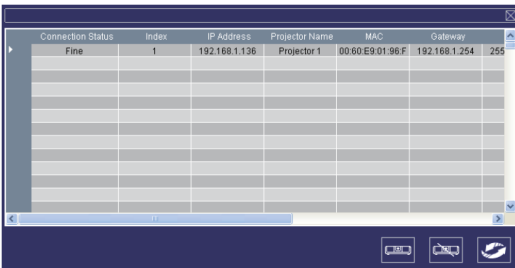

When the security warning window appears while Network Control is executing, please select "Unblock" to disable area network linking control from System Administrator.

- 2 Click  (search again), the projector which is well connected with a PC will be shown. (Graph3)



Connection Status	Index	IP Address	Projector Name	MAC	Gateway
Fine	1	192.168.1.136	Projector 1	00:60:E9:01:96:F	192.168.1.254 255

<Graph 3>

- 3 Click  (register projector), the projector information will show on the monitor window. Click  button (exit), it will cancel the registered item then return to register table.

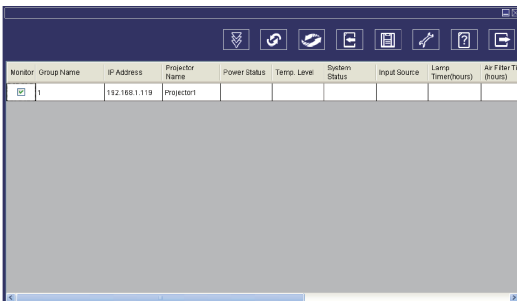

Monitor Group Name	IP Address	Projector Name	Power Status	Temp. Level	System Status	Input Source	Lamp Time(hours)	Air Filter/Tr Group
1	192.168.1.119	Projector1						

<Graph 4-1> Monitor window

Before Use

Projector Auto Search.

- Projector Auto Search can rank group names or display names by clicking the monitor window title (Group Name) or (Projector Name). This will help you easily understand projectors status.

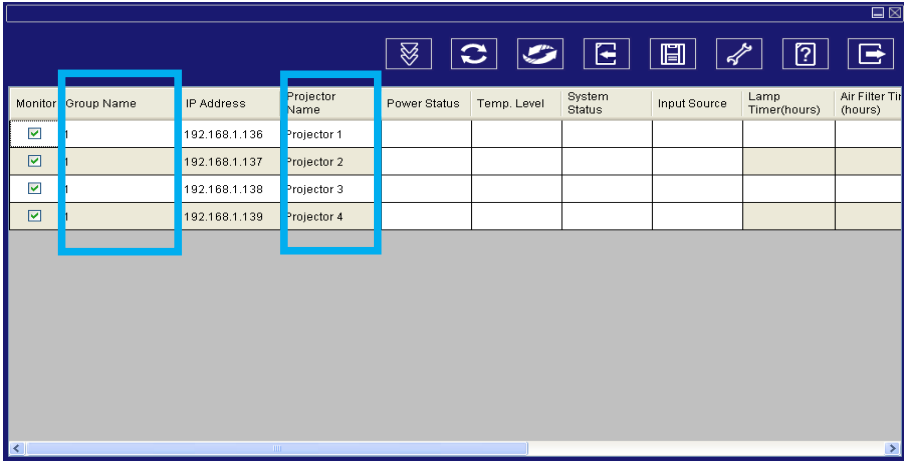

Monitor	Group Name	IP Address	Projector Name	Power Status	Temp. Level	System Status	Input Source	Lamp Timer(hours)	Air Filter Tin (hours)
<input checked="" type="checkbox"/>		192.168.1.136	Projector 1						
<input checked="" type="checkbox"/>		192.168.1.137	Projector 2						
<input checked="" type="checkbox"/>		192.168.1.138	Projector 3						
<input checked="" type="checkbox"/>		192.168.1.139	Projector 4						

<Graph 4-2>

- After registering, you can click  button (Data single capture) in the tool bar or click  button (Start Auto Scan) to monitor the projector(s).

NOTE

When pressing  (About) button for help, you will see icons explained as in the chart.

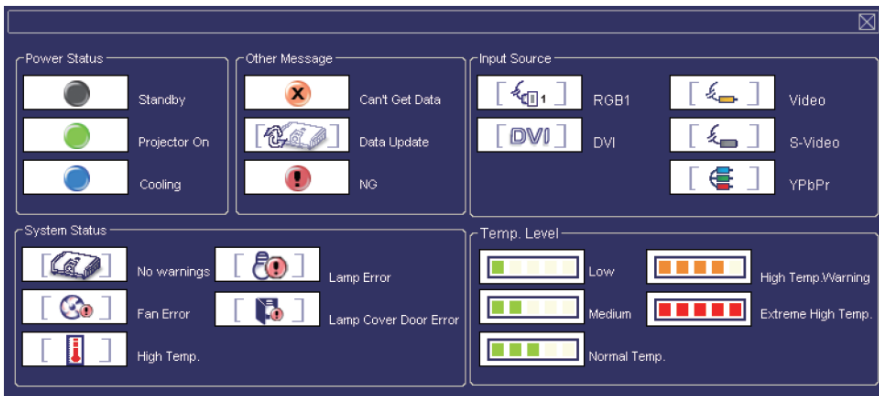

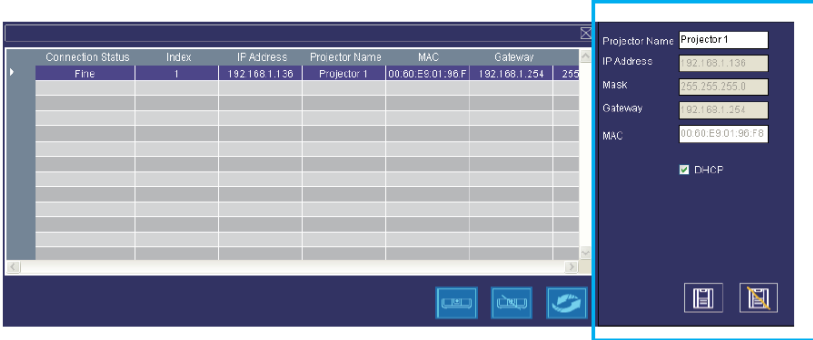

Modify The Projector Setting

- 1 If modifying the registered projector setting is needed, please move your cursor to the data table and click the item that you would like to modify. The detail will be shown on the right side table.



< Graph 5 > : Register Table.

- 2 After changing the projector setting, you can save the data by clicking  button or cancel by clicking  button.

Item	Description
Projector name	Show the Host name. (16 characters at most in ASCII.)
IP Address	Show the IP Address.
Mask	Show the Mask.
Gateway	Show the Gateway.
MAC	Show up the MAC code. (The default value can not be modified.)
DHCP	Capture IP address from network sensor automatically.

< Table 1 > : Setting Windows.

Registering And Configuring The Projector

Delete

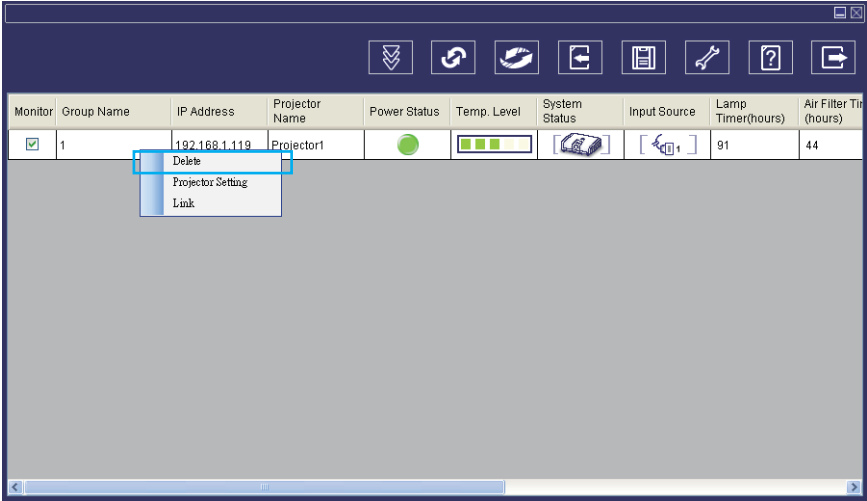

- 1 Select the registered projector in monitor window. Click mouse right key and select “ Delete ” to erase the registered projector data.



< Graph 6 > : Register Table.

Registering And Configuring The Projector

Projector Setting

- 1 Select the registered projector in monitor window. Click mouse right key and select “ projector setting ” to modify the registered projector data. After finishing the setting, you can save by clicking  button or cancel by clicking  button.

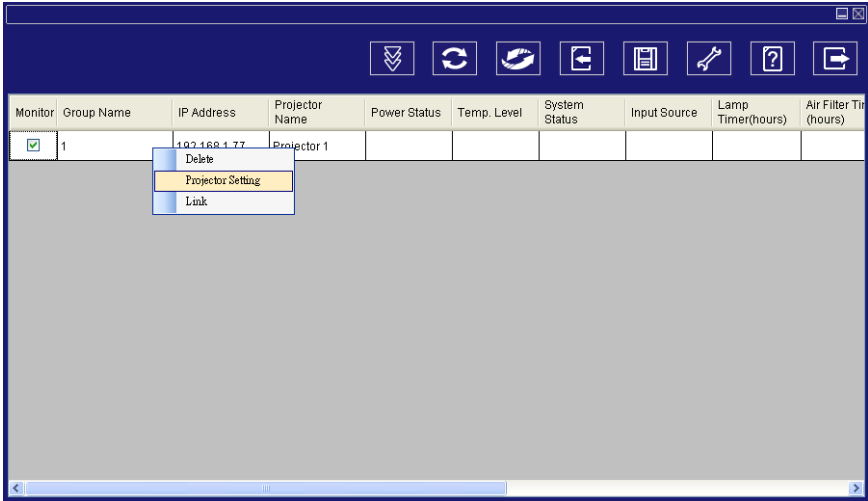

< Graph 7 > : Register table.

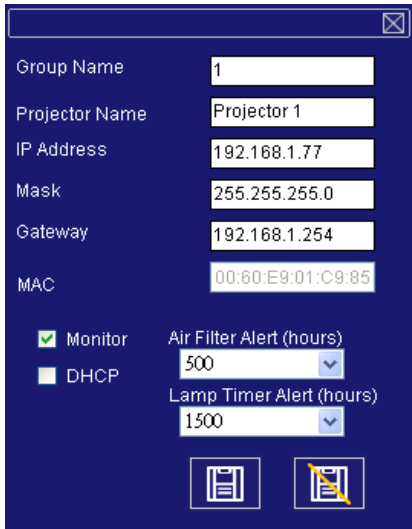

< Graph 8 > :Setting

Registering And Configuring The Projector

System Setting

- 2 Click  button (system setting) to modify system alert setting.

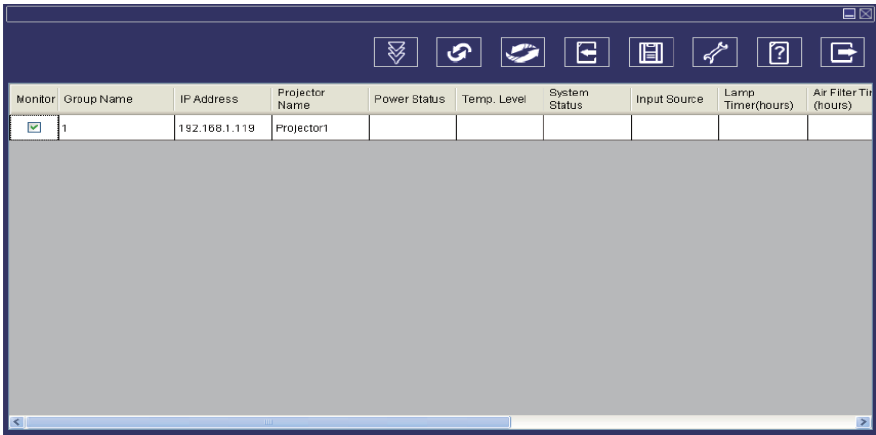

The screenshot shows a software window with a toolbar at the top containing icons for home, refresh, undo, redo, save, edit, help, and print. Below the toolbar is a table with the following columns: Monitor, Group Name, IP Address, Projector Name, Power Status, Temp. Level, System Status, Input Source, Lamp Timer(hours), and Air Filter Tim (hours). The first row of the table is selected and contains the following data:

Monitor	Group Name	IP Address	Projector Name	Power Status	Temp. Level	System Status	Input Source	Lamp Timer(hours)	Air Filter Tim (hours)
<input checked="" type="checkbox"/>	1	192.168.1.119	Projector1						

< Graph 9 >

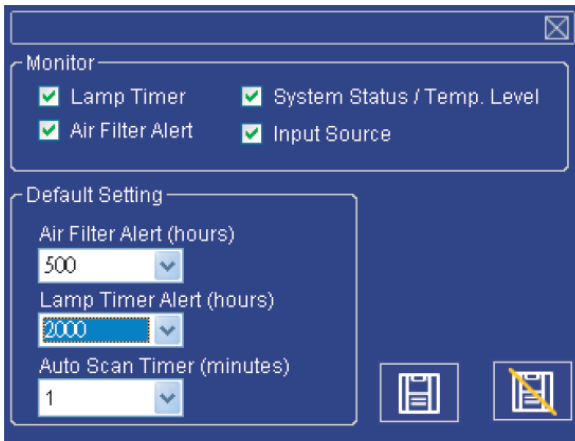

The screenshot shows a dialog box titled "Monitor" with a close button in the top right corner. It contains two sections: "Monitor" and "Default Setting".

Monitor

- Lamp Timer
- System Status / Temp. Level
- Air Filter Alert
- Input Source

Default Setting

Air Filter Alert (hours): 500

Lamp Timer Alert (hours): 2000

Auto Scan Timer (minutes): 1

At the bottom right of the dialog box, there are two icons: a floppy disk icon and a document icon with a diagonal slash through it.

<Graph 10>

Registering And Configuring The Projector

System Setting

Monitor

Item	Description
Lamp Timer	Read lamp use time from projector.
Air Filter Alert	Read Air Filter Timer from projector.
System Status/ Tempeture Level	Read System Status and Temperature from projector in Power On status.
Input Source	Read Input Source from projector in Power ON status.

< Table 2 >

Default Setting

Item	Description
Lamp Timer Alert (Hr.)	Default Setting Includes 1000/1500/2000 Hours. When Lamp Timer reaches alert target, window will show lamp timer in red color to remind user to replace the lamp.
Air Filter Alert (Hr.)	Default setting includes 300/500/800/1000/1500 Hours. When Filter Timer reaches alert target, window will show filter timer in red color to remind user to replace the filter.
Auto Scan Timer (minutes)	Auto Detect setting. Default setting includes 1/3/5/10 minutes; user can set the optimal default listed in Table 6.

< Table 3 >

Auto Scan Timer

Projector Number (Sets)	Timer Interval (Minutes)
1~25	1/3/5/10
26~50	3/5/10
51~100	5/10
101~255	10>

* The maximum quantity of projector monitored is 255.

< Table 4 >

Registering And Configuring The Projector

Link

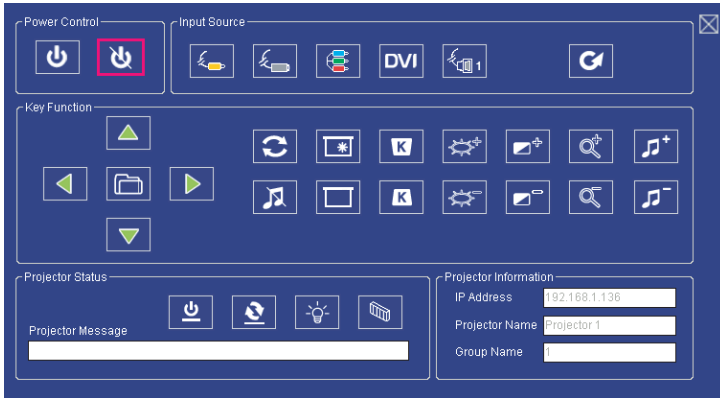

- 3 Select the registered projector in monitor window. Click mouse right key and select “ Link ” to show the control panel table and the projector connecting status.









< Graph 12 > : The control panel table.

Control Panel Window Introduction















1 Power Control

Icon	Name
	Power on
	Power off

2 Input Source





Icon	Name
	Video
	S-Video
	Y,Pb,Pr
	DVI-I
	RGB 1
	Change Input Source

3 Function Key





Icon	Name	Icon	Name
	Up		Freeze
	Down		Blank
	Left		Keystone Correction +
	Right		Keystone Correction -
	Menu		Increase Brightness
	Auto Sync		Decrease Brightness
	Mute		Higher Contrast

Control Panel Window Introduction

3 Function Key











Icon	Name
	Lower Contrast
	Zoom In
	Zoom Out
	Volume Up
	Volume Down

4 Projector Status

Icon	Name
	System Status
	Input Source Status
	Lamp Timer
	Air Filter Timer

Control Panel Window Introduction

1 Network Control Window introduction

Icon	Name	Description
	Scan all	Capture the all registered projectors' information one time only.
	Start Auto Scan	According to the system setting, get the projector information automatically.
	Stop Auto Capture	Stop scanning the projector information.
	Auto Search	Search the projector in the same network to register and modify the setting.
	Open Project File	Open project file which was saved.
	Save Project File	Save the registered projector in this project.
	System Setting	Setting the projector system reminder message.
	About	Icon content description.
	Exit	Exit the Network software.
	Register projector	Register projector's information.
	Exit	Cancel registered information.

Filter

Sponge Filter

When a warning message appears to remind you to clean the sponge filter, please clean the sponge filter immediately. (P.32)

<Please check and clean the air filter periodically.>

Replacing the Anti-dust filter (Part Numcer:13340230)

When the use time reaches the filter counter time, the projector will display a message to remind replacing a new filter. If there is no spare air filter available, please contact your dealer.

When the use time reaches the filter counter time, the projector will display a message to remind replacing a new Anti-dust filter. If there is no spare Anti-dust filter available, please contact your dealer.

Turn off the projector, and unplug the power cord. Allow the projector to sufficiently cool down.

1. Remove the filter cover from the side of projector.
2. Pull out the Anti-dust filter and pack the filter in plastic bag before disposing it.
3. It is recommended that you clean dust on the filter cover by vacuum cleaner, then gently brush the other side of the filter cover by brush.(Please do not clean the sponge filter with water.)
4. Install Anti-dust filter and press the filter until it is tightly loaded into the filter case.
5. Close the filter cover. When installing, make sure the two extruded points on the filter are facing downward.
6. After installing Anti-dust filter, reset the filter timer.(P.30)

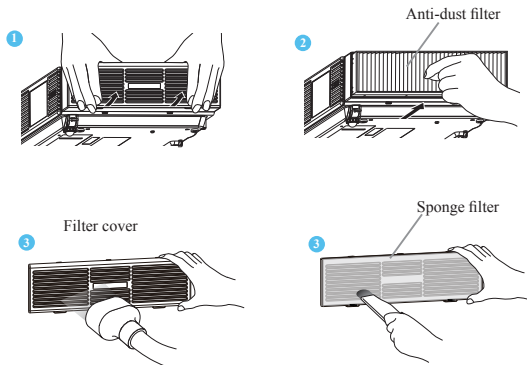

Notice:

When upper right corner of the image appears warning message as the graphic shows, it indicates there is a problem with the installation of the Anti-dust filter. Please check again if the Anti-dust filter is firmly installed.



1. Please check if Anti-dust filter is installed or not?
2. Please check if the filter cover is properly closed or not?

Maintenance of Projector

Lamp

1. If you want to replace new lamp, but the projector was just turned off, please let the projector cool down and unplug power cord at least 60 minutes.
2. If the projector is mounted in the ceiling, contact your dealer to replace the lamp.

Replacing New Lamp(Part Number:23040021)

1. Remove the lamp door.
2. Loosen 2 screws of the lamp holder. Hold the handle on the top of the lamp, pull out the lamp straight off the projector.
3. Insert new lamp, lock the lamp door firmly with 2 screws.
4. Put the lamp door on.
5. Please reset the lamp timer after replacing lamp. (P.29)

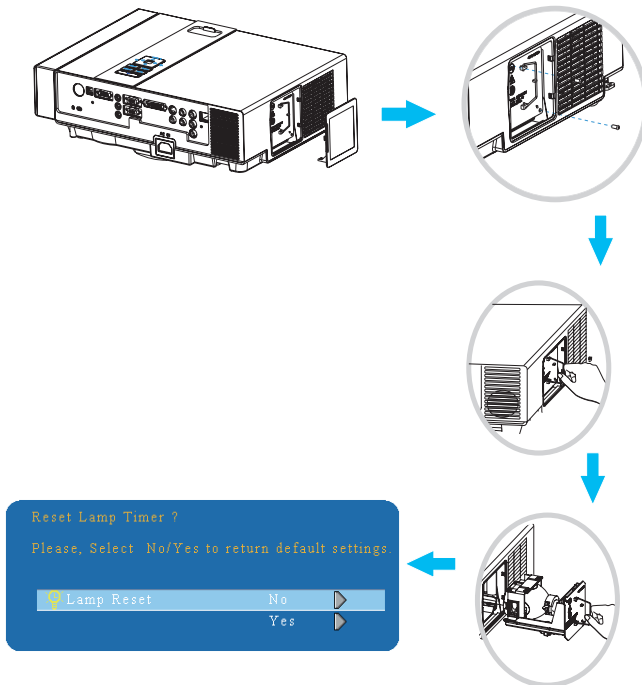



WARNING

The projector uses a high-pressure mercury lamp.

The explosion of lamp with a loud bang or burn out could possibly cause injury or a fire.

When the bulb bursts, it is possible for shards of glass to fly into the lamp housing; and for gas containing mercury to escape from the projector's vent holes.

If the lamp has broken, do not check the inside of the projector. Please ventilate the room immediately.

Do not touch or bring your face close to the broken pieces since it might get into your eyes or mouth. In case of injury, seek medical advice immediately.

Disposal of a Lamp

Dispose of a lamp in accordance with the local recycling laws.

Do not put it to your trash.

Recycling Lamp's laws of the USA, go to www.lamprecycle.org.

Recycling Product's laws of USA, go to www.eiae.org.

Recycling Product's laws of Canada, go to www.epsc.ca.

For more information about recycling laws, please contact local government agency or dealer.

CAUTION HOT

Before replacing the Lamp unit, pay attention to the following items:

1. The Lamp is optional part. Contact the dealer for replacement lamp.
2. The lamp becomes very hot when in use. Turn the power off and disconnect the power cord.
3. Wait for 1 Hour before replacing the lamp.
4. Do not use old lamp unit.

Maintenance of Projector

Additional

- In order to ensure the safe use of your projector, please contact your dealer to inspect about once a year.
- Before maintenance, make sure the power cable is unplugged, allow the projector to cool sufficiently. The high temperature state of the projector could cause a burn in and/or malfunction to the projector.
- Never try to maintain the inside of the projector by yourself.

Anti-smoke filter(Part Number:13340231)

- If the projector would be used in smokier environment, please use this filter.

Troubleshooting

Indicator

The power and lamp indicators show the status of the projector. Before requesting repair, check the projector status using the chart below. If the problem cannot be resolved, contact your dealer.

In normal status~~~

POWER	LAMP	CONDITIONS	DESCRIPTION
Blinking In Green	Off	Stand by mode	Projector is ready to be turned on.
Lighting In Green	Off	On mode	Projector is on and operating.
Lighting In Green	Blinking In Red (Slow)	Cool down mode	Projector is in cool down mode and will not respond to user input.

In abnormal status~~~

POWER	LAMP	CONDITIONS	DESCRIPTION
Blinking In Green	Blinking In Red (Fast)	Fan fault mode	The projector has detected a problem of a slow internal fan speed. The lamp will shut off automatically. Contact your dealer.
Blinking In Green	Lighting In Red	Lamp cover open	The lamp cover is open or there is a problem with the lamp. If the lamp door is closed and replacing the lamp does not correct the issue, contact your dealer.
Blinking In Green (Fast)	Blinking In Red (Fast)	High temperature	The projector has overheated and shut itself down. Correct the over temperature condition immediately. 1. Check that the ventilation slots are free from obstructions. 2. Check the cleanliness of the air filter.
Blinking In Green (Slow)	Blinking In Red (Slow)	Lamp fail	The lamp does not light. Come back to “ stand by mode ”, and press the power button.

Troubleshooting

Error For Machine Defects

The following problems may be confused with a machine defect. Check and follow the table. If it couldn't be improved, contact your dealer.

Symptom	Cause / Remedy
Projector power does not turn on.	The power cord is disconnected. Plug the power cord into an AC outlet.
	Intending to turn on the projector again during the cool down mode. Wait until the cool down mode has completed.
	There is no lamp and/or lamp cover is not firmly closed. Please turn off the power and disconnect the power plug from the power outlet. Check if the lamp is installed or the lamp cover is firmly closed and turn on the power again.
	Power cord has impaired. When you touch the power cord, the indicator goes on then off, please remove the power cord and connect it again. If the situation is repeated, remove the power cord and contact your dealer.
No Image	The input is not connected correctly. Select the appropriate input source.
	No signal input. Connect correctly.
	The lens cover is attached to the lens. Remove the lens cover.
Colors are pale	Color density and color matching are not adjusted correctly. Adjust the RGB setting.
	Color lose. Caused by poor VGA cable connection.
Abnormal brightness & contrast	Brightness and contrast are not adjusted correctly. Adjust the brightness and contrast setting.
	The lamp is near the end of its service life. Replace with a new lamp.
Image is blurred	The projection lens is not focused. Adjust the focus using the focus ring.
	The lens is dirty or misty. Clean the lens.

Troubleshooting

Error For Machine Defects

Symptom	Cause / Remedy
No audio	The projector is not connected correctly. Check audio cable if connect correctly.
	The volume is set to minimum. Adjust the volume.
	Mute is turned on. Press the MUTE button.
Remote control is not working.	No battery. Before using the remote control, please check the battery of remote control.
	Remote signal is obstructed. Remove the obstacle between projector and remote control.

Troubleshooting

List of Supported Monitor Displays

Computer mode / DVI-I mode		
Signal	Refresh Rate (Hz)	Resolution (dots)
VGA	60	640x480
VESA	60 / 72 / 75 / 85	640x480
SVGA	56 / 60 / 72 / 75 / 85	800x600
XGA	60 / 70 / 75 / 85	1024x768
SXGA	70 / 75	1152x864
SXGA	60 / 75	1280x960
SXGA	60	1280x1024
WXGA	60 / 75	1280x800
WXGA+	60 / 75 / 85	1440x900
SXGA +	60 / 75	1400x1050
UXGA	60	1600x1200
WSXGA+	60	1680x1050
MAC	67	1280x1024 / 640x480
MAC	75	832x624
MAC	75	1024x768
MAC	75	1152x870
Component (Y,Pb,Pr)		
Signal	Refresh Rate (Hz)	Resolution (dots)
SDTV(480i / 576i)	30 / 25	720x480 / 720x576
SDTV(480p / 576p)	60 / 50	720x480 / 720x576
HDTV(720p)	60	1280x720
HDTV(1080i / 1080p)	30 / 60	1920x1080
Composite / S-Video		
Signal	Refresh Rate (Hz)	Resolution (dots)
TV(NTSC)	60	720x480
TV(PAL,SECAM)	50	720x576

Appendix

Menu Tree (PC Mode)

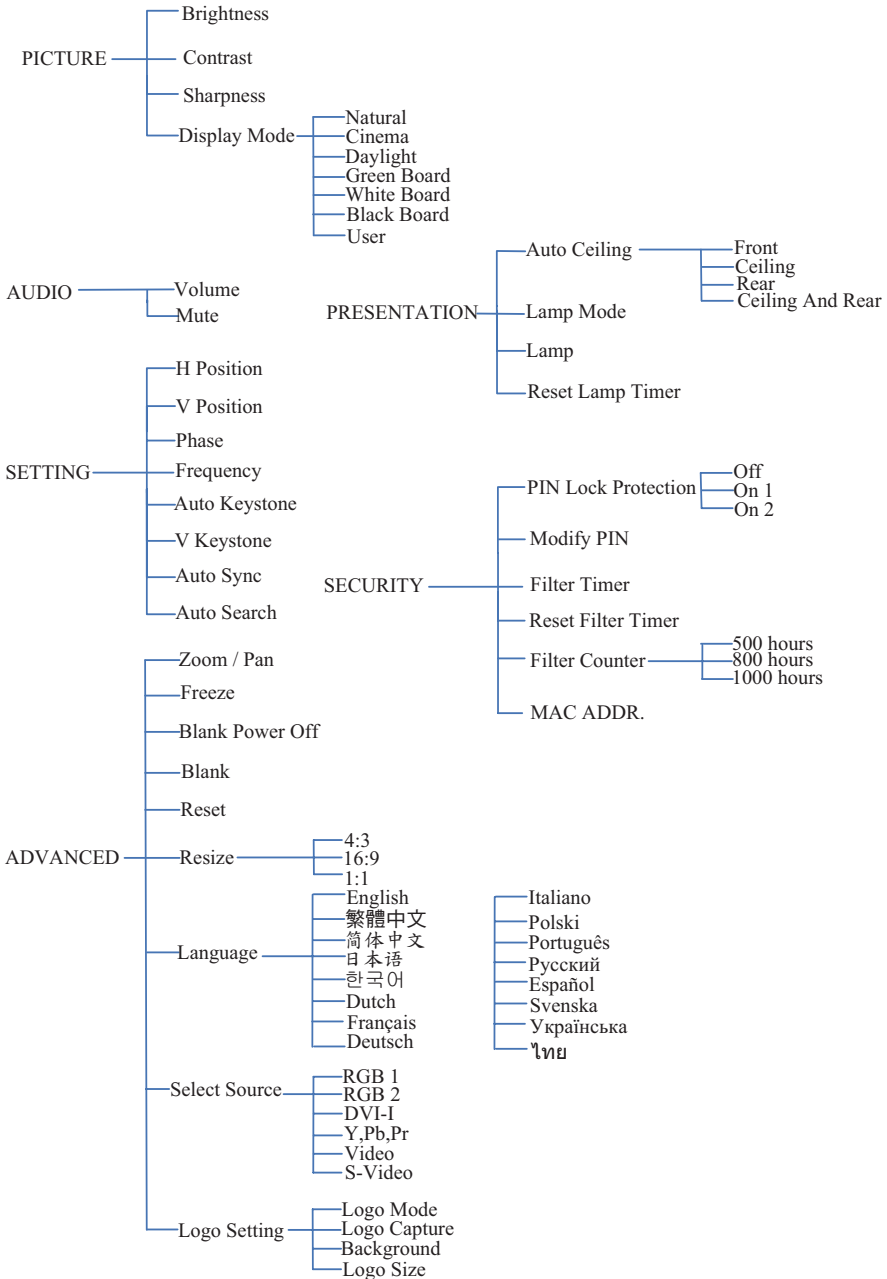

*DVI doesn't support H / V POSITION, PHASE, FREQUENCY, AUTO SYNC function.

Appendix

Menu Tree (Video Mode)

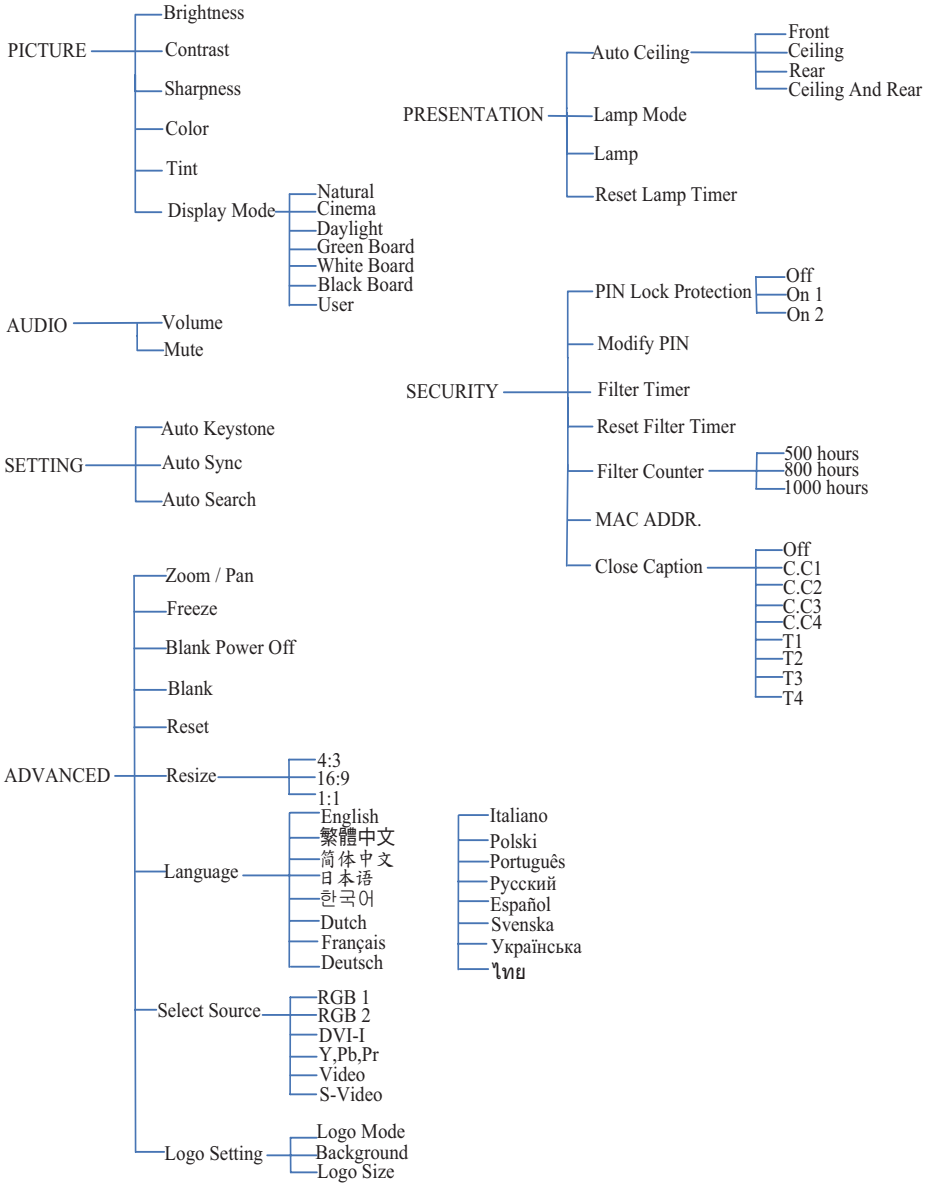

Appendix

Appearance

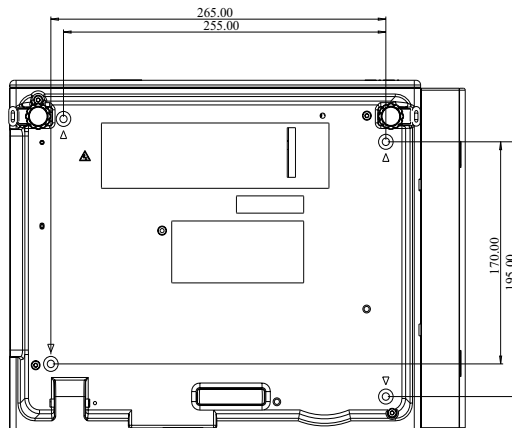
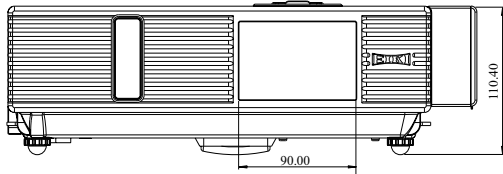
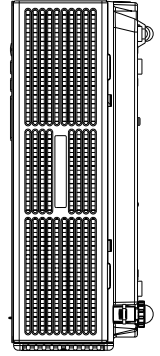
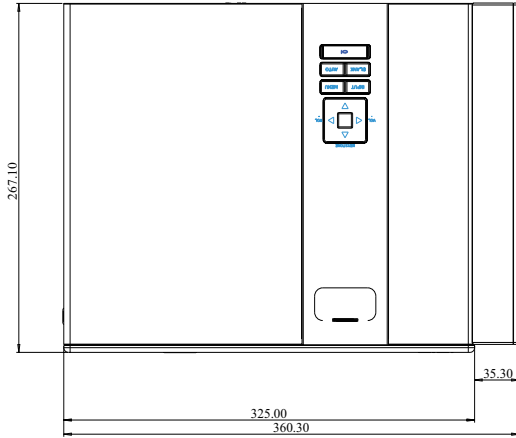
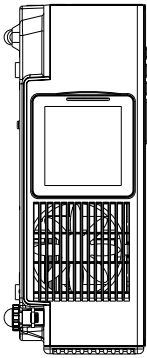

Screw for Ceiling Mounted M4x8mm 4pcs

Appendix

Configurations of Terminal

S-Video Signal

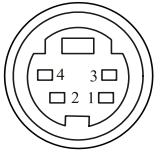

	Signal Name	Connection
4	Y signal	Y
2	return(GND)	GND
3	C signal	C
1	return(GND)	GND

Analog RGB

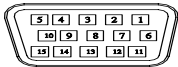

	Signal Name	Connection		Signal Name	Connection
15	R signal Input	R	11	GND	GND
14	G signal Input	G	12	GND	GND
13	B signal Input	B	7	DDC power	DDC power
5	N.C.	N.C	4	DDC data	DDC/SDA
6	GND	GND	3	HSYNC/TTL/ Comp.sync	H
10	R return(GND)	GND	2	VSYNC	V
9	G return(GND)	GND	1	DDC clock	DDC/SCL
8	B return(GND)	GND			

Y, Pb, Pr

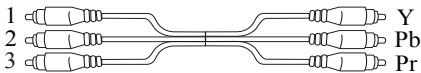

	Signal Name
1	Y
2	Pb
3	Pr

RS-232 Input

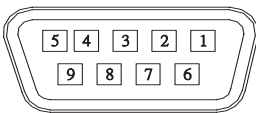

PC Side	D-Sub Pin
2 RX	2 RX
3 TX	3 TX
5 GND	5 GND

Appendix

USB Connector

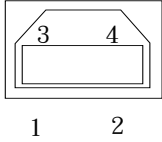

	Signal Name
4	VCC
3	Data-
1	Data+
2	GND

DVI-I

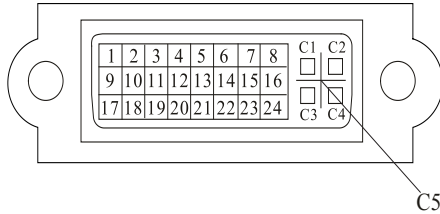

Signal Name		Signal Name		Signal Name	
1	T.M.D.S. Data2-	9	T.M.D.S. Data1-	17	T.M.D.S. Data0-
2	T.M.D.S. Data2+	10	T.M.D.S. Data1+	18	T.M.D.S. Data0+
3	T.M.D.S. Data2/4 Shield	11	T.M.D.S. Data1/3 Shield	19	T.M.D.S. Data0/5 Shield
4	T.M.D.S. Data4-	12	T.M.D.S. Data3-	20	T.M.D.S. Data5-
5	T.M.D.S. Data4+	13	T.M.D.S. Data3+	21	T.M.D.S. Data5+
6	DDC Clock/CLOCK	14	5V Power	22	T.M.D.S. Clock Shield
7	DDC Data	15	Ground(for +5V)	23	T.M.D.S. Clock+
8	No Connect	16	Hot Plug Detect	24	T.M.D.S. Clock-
C1	Analog red	C2	Analog green	C3	Analog blue
C4	Analog horizontal sync	C5	Analog ground (analog R,G,B return)		

EIKI

U.S.A.

EIKI International, Inc.
30251 Esperanza
Rancho Santa Margarita
CA 92688-2132
U.S.A.
Tel : 800-242-3454 (949)-457-0200
Fax :800-457-3454 (949)-457-7878
E-Mail : usa@eiki.com

Canada

EIKI CANADA - Eiki International, Inc.
P.O. Box 156, 310 First St. - Unit 2,
Midland, ON, L4R 4K8, Canada
Tel : 800-563-3454 (705)-527-4084
Fax :800-567-4069 (705)-527-4087
E-Mail : canada@eiki.com

Deutschland & Österreich

EIKI Deutschland GmbH
Am Frauwald 12
65510 Idstein
Deutschland
Tel : 06126-9371-0
Fax :06126-9371-14
E-Mail : info@eiki.de

Eastern Europe

EIKI CZECH SPOL. s.r.o.
Nad Cementárnou 1163/4a
Paraha 4, Podolí
147 00
Czech Republic
Tel : +42 02 4141 0928
+42 02 4140 3095
Fax: +42 02 4140 9435
E-Mail : easterneurope@eiki.de

China

EIKI (Shanghai) Co., Ltd.
1. Dapu Road,
Golden Magnolia Plaza
#2109 Shanghai,
200023 China
Tel : 86-21-5396-0088
Fax :86-21-5396-0318
E-mail : info@eiki-china.com

South East Asia

EIKI Industrial (M) Sdn Bhd
No. 3A-2C, 4th Floor, Jalan PJU 8/3A,
Perdana Business Centre,
Bandar Damansara Perdana,
47820 Petaling Jaya, Selangor
Malaysia
Tel : +603-7722-4362
Fax : +603-7722-4392
E-Mail : sales@eiki.my

Japan & Worldwide

EIKI Industrial Company Limited.
4-12 Banzai-Cho, Kita-Ku, Osaka,
530-0028 Japan
Tel : +81-6-6311-9479
Fax :+81-6-6311-8486

WorldWide Website <http://www.eiki.com>