

myprojectorlamps.com

**The most trusted, dependable name
in projector lamp sales.**



<http://www.myprojectorlamps.com>



<http://www.myprojectorlamps.ca>



<http://www.myprojectorlamps.eu>

The following projector manual has not been modified or altered in any way.

EIKI

MULTIMEDIA PROJECTOR

MODEL **LC-NB1U**



OWNER'S INSTRUCTION MANUAL

INFORMATION TO THE USER

NOTE: This equipment has been tested and found to comply with the limits for a Class A digital device, pursuant to Part 15 of the FCC Rules. These limits are designed to provide reasonable protection against harmful interference when the equipment is operated in a commercial environment. This equipment generates, uses, and can radiate radio frequency energy and, if not installed and used in accordance with the instruction manual, may cause harmful interference to radio communications. Operation of this equipment in a residential area is likely to cause harmful interference in which case the user will be required to correct the interference at his own expense.

SAFETY PRECAUTIONS

WARNING:

TO REDUCE THE RISK OF FIRE OR ELECTRIC SHOCK, DO NOT EXPOSE THIS APPLIANCE TO RAIN OR MOISTURE.

The projector has a grounding-type AC line plug. This is a safety feature to be sure that the plug will fit into the power outlet. Do not try to defeat this safety feature.

This Projector produces intense light from the projection lens. Do not stare directly into the projection lens as possible eye damage could result. Be especially careful that children do not stare directly into the beam.

If the projector will not be used for an extended time, unplug the projector from the power outlet.

This Projector should be set in the way indicated. It may result in fire hazard.

READ AND KEEP THIS OWNER'S MANUAL FOR LATER USE.

| | | |
|---|---|---|
|  | CAUTION RISK OF ELECTRIC SHOCK DO NOT OPEN |  |
| CAUTION: TO REDUCE THE RISK OF ELECTRIC SHOCK, DO NOT REMOVE COVER (OR BACK). NO USER-SERVICEABLE PARTS INSIDE. REFER SERVICING TO QUALIFIED SERVICE PERSONNEL. | | |
|  THIS SYMBOL INDICATES THAT DANGEROUS VOLTAGE CONSTITUTING A RISK OF ELECTRIC SHOCK IS PRESENT WITHIN THIS UNIT. |  THIS SYMBOL INDICATES THAT THERE ARE IMPORTANT OPERATING AND MAINTENANCE INSTRUCTIONS IN THE OWNER'S MANUAL WITH THIS UNIT. | |

IMPORTANT:

For your protection in the event of theft or loss of this LC Data-Grade projector, please record the Model Number and Serial Number located on the rear of unit and retain this information. Refer to these numbers whenever you call upon your authorized dealer regarding this product.

Do not discard shipping carton and packing materials. These items may be needed for storage or future servicing.

Model No: LC-NB1U

Serial No: _____

IMPORTANT SAFETY INSTRUCTIONS

All the safety and operating instructions should be read before the product is operated.

Read all of the instructions given here and retain them for later use. Unplug this projector from AC power supply before cleaning. Do not use liquid or aerosol cleaners. Use a damp cloth for cleaning.

Do not use attachments not recommended by the manufacturer as they may cause hazards.

Do not place this projector on an unstable cart, stand, or table. The projector may fall, causing serious injury to a child or adult, and serious damage to the projector. Use only with a cart or stand recommended by the manufacturer, or sold with the projector. Wall or shelf mounting should follow the manufacturer's instructions, and should use a mounting kit approved by the manufacturer.

Do not expose this unit to rain or use near water... for example, in a wet basement, near a swimming pool, etc...

Slots and openings in the back and bottom of the cabinet are provided for ventilation, to insure reliable operation of the equipment and to protect it from overheating.

The openings should never be covered with cloth or other material, and the bottom opening should not be blocked by placing the projector on a bed, sofa, rug, or other similar surface. This projector should never be placed near or over a radiator or heat register.

This projector should not be placed in a built-in installation such as a bookcase unless proper ventilation is provided.

This projector should be operated only from the type of power source indicated on the marking label. If you are not sure of the type of power supplied, consult your authorized dealer or local power company.

Do not overload wall outlets and extension cords as this can result in fire or electric shock. Do not allow anything to rest on the power cord. Do not locate this projector where the cord will be abused by persons walking on it.

Never push objects of any kind into this projector through cabinet slots as they may touch dangerous voltage points or short out parts that could result in a fire or electric shock. Never spill liquid of any kind on the projector.

Do not attempt to service this projector yourself as opening or removing covers may expose you to dangerous voltage or other hazards. Refer all servicing to qualified service personnel.

Unplug this projector from wall outlet and refer servicing to qualified service personnel under the following conditions:

- When the power cord or plug is damaged or frayed.
- If liquid has been spilled into the projector.
- If the projector has been exposed to rain or water.

- If the projector does not operate normally by following the operating instructions. Adjust only those controls that are covered by the operating instructions as improper adjustment of other controls may result in damage and will often require extensive work by a qualified technician to restore the projector to normal operation.
- If the projector has been dropped or the cabinet has been damaged.
- When the projector exhibits a distinct change in performance-this indicates a need for service.

When replacement parts are required, be sure the service technician has used replacement parts specified by the manufacturer that have the same characteristics as the original part. Unauthorized substitutions may result in fire, electric shock, or injury to persons.

Upon completion of any service or repairs to this projector, ask the service technician to perform routine safety checks to determine that the projector is in safe operating condition.



This projector is equipped with a grounding type AC line plug. Should you be unable to insert the plug into the outlet, contact your electrician. Do not defeat the safety purpose of this grounding type plug.

Follow all warnings and instructions marked on the projectors.

For added protection to the projector during a lightning storm, or when it is left unattended and unused for long periods of time, unplug it from the wall outlet. This will prevent damage due to lightning and powerline surges.



An appliance and cart combination should be moved with care. Quick stops, excessive force, and uneven surfaces may cause the appliance and cart combination to overturn.

If the projector is to be built into a compartment or similarly enclosed, the minimum distances must be maintained. Do not cover the ventilation slot on the projector. Heat build-up can reduce the service life of your projector, and can also be dangerous.

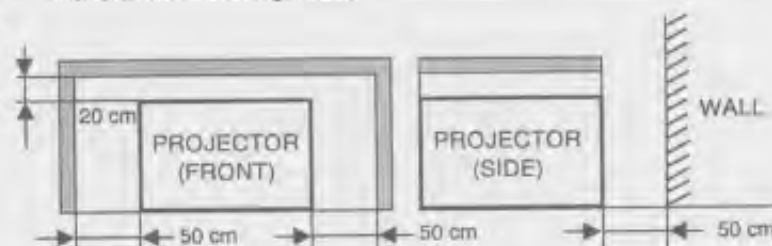

TABLE OF CONTENTS

| | PAGE | | PAGE |
|--|-------|--------------------------------------|-------|
| FEATURES AND DESIGN | 5 | LANGUAGE ADJUSTMENT | 29 |
| ACCESSORIES | 6 | COLOR SYSTEM SELECT (Video) COLOR | 30 |
| POWER REQUIREMENTS | 6 | PICTURE IMAGE ADJUSTMENT (Video) | 31 |
| DESCRIPTION | 7 | PICTURE SCREEN ADJUSTMENT (Video) | 32 |
| SETTING-UP THE PROJECTOR | 8-9 | COMPUTER SYSTEM SELECT | 33-34 |
| POSITIONING | 8 | PICTURE IMAGE ADJUSTMENT (Computer) | 35 |
| ROOM LIGHT | 8 | PICTURE POSITION ADJUSTMENT | 36 |
| VENTILATION | 8 | (Computer / MCI) | |
| ADJUSTABLE FEET | 9 | PC ADJUSTMENT | 37-40 |
| MOVING THE PROJECTOR | 9 | AUTO IMAGE FUNCTION (Computer) | 41 |
| CONNECTING THE PROJECTOR | 10-15 | PICTURE SCREEN ADJUSTMENT | 42 |
| CONNECTING THE COMPUTER | 10-14 | (Computer / MCI) | |
| IBM-compatible desktop computer connection | 11 | OTHER FUNCTION SETTING | 43-45 |
| Macintosh desktop computer connection | 12 | Blue Back | 43-44 |
| IBM-compatible laptop computer connection | 13 | Display | 43-44 |
| Macintosh PowerBook computer connection | 14 | Ceiling | 43-44 |
| CONNECTING THE VIDEO EQUIPMENT | 15 | Rear | 43-44 |
| CONNECTING THE EXTERNAL AUDIO EQUIPMENT | 15 | Lamp Age | 43,45 |
| OPERATION OF CONTROLS | 16-18 | MCI OPERATION | 46-52 |
| TOP OF THE PROJECTOR | 16-17 | AVAILABLE DATA | 46 |
| REAR OF THE PROJECTOR | 18 | AVAILABLE CARD | 46 |
| OPERATION OF REMOTE CONTROL | 19-21 | LOAD/UNLOAD PC CARD | 46 |
| REMOTE CONTROL BATTERY INSTALLATION | 21 | BASIC OPERATION | 47-48 |
| USING REMOTE CONTROL | 21 | DISPLAY DATA ON SCREEN | 47 |
| CONTROL THE PROJECTOR | 22-25 | INDEX SELECTION | 47 |
| DIRECT OPERATION | 22 | PAGE SELECTION | 47 |
| MENU OPERATION | 23-25 | CURSOR FUNCTION | 48 |
| BASIC OPERATION | 26-45 | CURSOR DISPLAY | 48 |
| TURNING ON THE PROJECTOR | 26 | AUTOPLAY FUNCTION | 48 |
| TURNING OFF THE PROJECTOR | 26 | PICTURE POSITION ADJUSTMENT | 48 |
| DIRECT OPERATION | 27 | PICTURE SCREEN ADJUSTMENT | 48 |
| MODE SELECT | 27 | WRITE DATA INTO MEMORY CARD | 49 |
| SOUND VOLUME ADJUSTMENT | 27 | CARD WRITE WITH PROJECTOR | 49 |
| SOUND MUTE FUNCTION | 27 | SMARTMEDIA AND PC CARD ADAPTER | 50-51 |
| ZOOM ADJUSTMENT | 27 | INSTALL AND REMOVE SMARTMEDIA | 50 |
| FOCUS ADJUSTMENT | 27 | AIR FILTER CARE AND CLEANING | 53 |
| NORMAL PICTURE FUNCTION | 27 | TEMPERATURE WARNING INDICATOR | 53 |
| NO SHOW FUNCTION | 27 | LAMP REPLACEMENT | 54 |
| AUTO IMAGE FUNCTION | 27 | CLEANING THE LENS | 55 |
| MENU OPERATION | 28-45 | TROUBLESHOOTING | 55-56 |
| MODE SELECT | 28 | TECHNICAL SPECIFICATIONS | 57 |
| SOUND ADJUSTMENT | 29 | | |

FEATURES AND DESIGN

This multimedia projector is designed with most advanced technology for portability, durability, and ease of use. The projector utilizes built-in multimedia features, a palette of 16.77 million colors, and active matrix liquid crystal display (LCD) technology.

Compatibility

This projector is compatible with many different types of personal computers and video devices, including;

SVGA (800x600), VGA (640x480, 720x400, 640x400)

MAC 12" (512x384), 13" (640x480), 16" (832x624)

XGA (1024x768)* / MAC 19"(1024x768)* -*projected with compress mode

Various video equipments using any of the world wide video standards, including; NTSC, NTSC4.43, PAL, and SECAM.

Image Resolution

Picture image is projected in the resolution of 804x604. Screen resolutions of 800x600 and 1024x768 are adjusted to 804x604.

This projector cannot display in the resolution more than 1024x768. If your computer's screen resolution is higher than 1024x768, reset the resolution to the lower before connecting the projector.

Portability

This projector is extremely compact in size and weight. Having a sophisticated shape like an attaché case with a retractable carrying handle, the projector will help you make powerful presentation wherever you go.

PC CARD SLOT

This projector have a PC CARD SLOT for easier presentation. Pictures can be projected just by inserting a memory card including image data.

Screen Mode

Screen display can be selected among;

Computer mode --- True, Digital zoom (Expand, Compress, Panning)

Video mode --- Regular (4:3), Wide (16:9)

Multilanguage

MENU DISPLAY is displayed with;

English, Deutsch, Français, Italiano, Español, or Japanese

Automatic Multiscanning system

This projector can detect display signals from most personal computers currently distributed. It is free from complicated adjustments to project picture images from PC.

Motor Zoom / Focus Lens

Zoom and Focus of Lens can be controlled with Top Control and Remote Control.

Other Features

Reverse Display, Air Pad Remote Control

ACCESSORIES

This projector contains following parts. When unpacking the package, make sure all of those are included. If any part is missing, contact authorized dealer or service station.

- Owner's Manual.
- AC Power Cord.
- Remote Control Unit and batteries.
- Lens Cover.
- Carrying Bag
- VGA Cable.
- VGA/MAC Adapter.
- Mouse Cable for PS/2 port.
- Mouse Cable for serial port.
- Mouse Cable for ADB port.
- Media Card Imager for Windows 95 (CD-ROM) and Owner's Manual for this software
- MCI Cable (RS-232C Cable)
- SmartMedia (memory card)
- PC Card Adapter for SmartMedia.

POWER REQUIREMENTS

Your projector uses nominal input voltages of 100-120VAC. The projector automatically selects the correct input voltage. It is designed to work with single-phase power systems having a grounded neutral conductor. To reduce the risk of electrical shock, do not plug into any other type of power system.

Consult your authorized dealer or service station if you are not sure of the type of power supply being in use.



CAUTION

For the safety, unplug the AC Power Cord when the appliance is not used.

When this projector is connected to the outlet with the AC Power Cord, the appliance is in Stand-by Mode and consumes a little electric power.

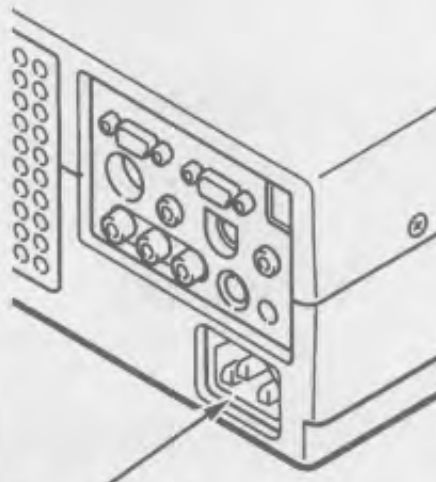

Connect the AC power supply cord (provided) to the projector.

Projector side (Female)

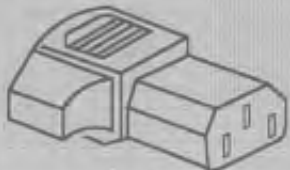

AC outlet side (Male)



TRADEMARKS

- Apple, Macintosh, and PowerBook are trademarks or registered trademarks of Apple Computer, Inc.
- IBM and PS/2 are trademarks or registered trademarks of International Business Machines, Inc.
- Windows and PowerPoint are registered trademarks of Microsoft Corporation.
- SmartMedia is a trademark of TOSHIBA Corporation.

DESCRIPTION

FRONT

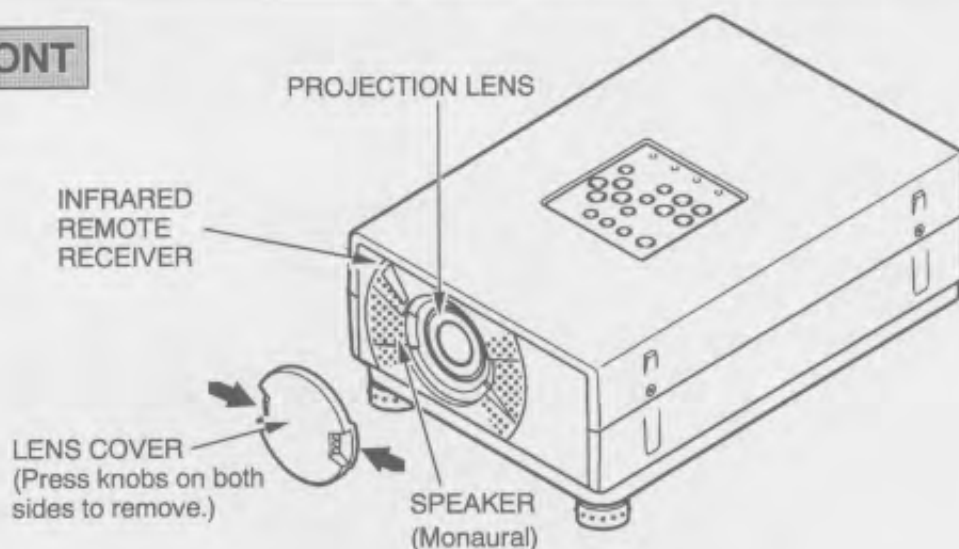

REAR

EXHAUST VENT



CAUTION

HOT AIR EXHAUSTED !

Air blown from the exhaust vent is hot. When using or installing the projector, following attention should be taken.

- Do not put a flammable object near this part. Keep heat-sensitive objects away from the exhaust part.
- Do not touch this part especially screws and metallic parts. This part will become hot while the projector is used.

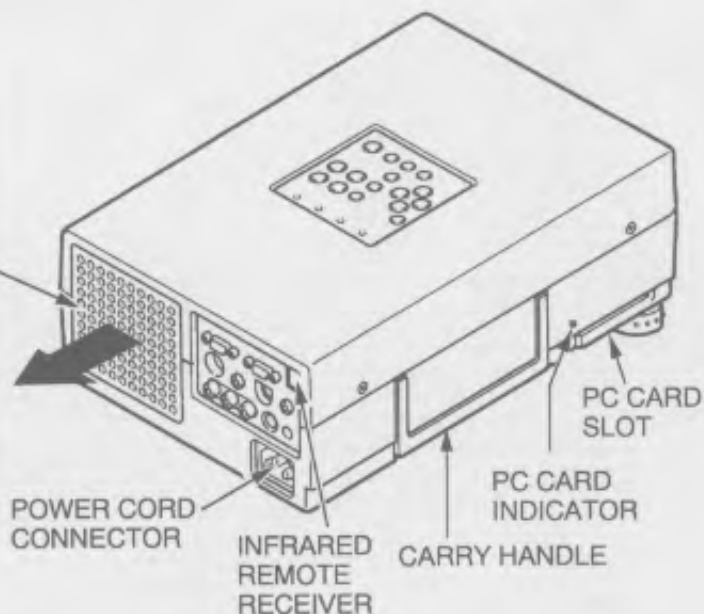

BOTTOM

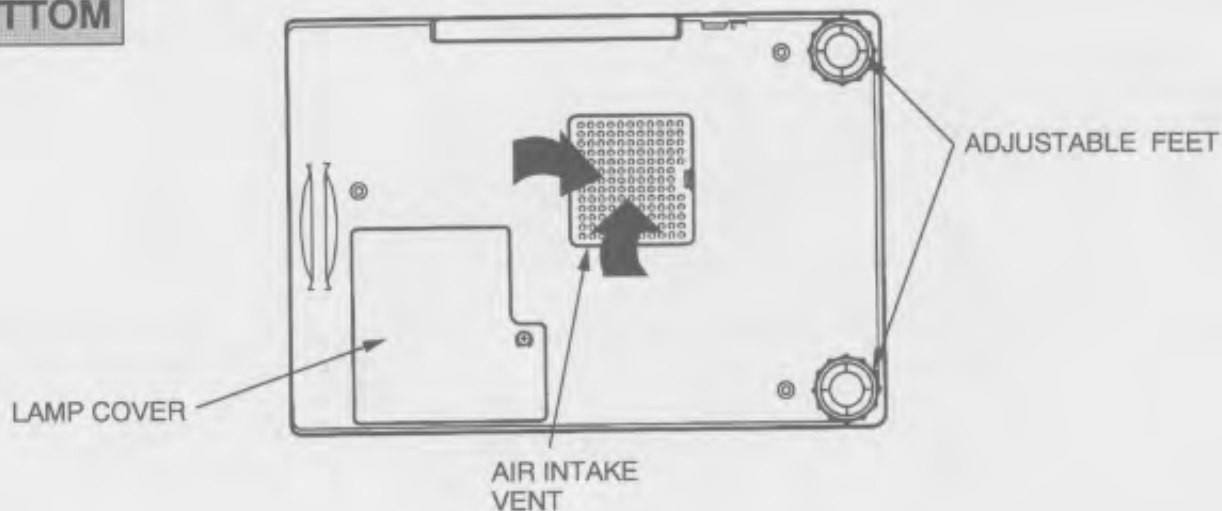

SETTING-UP THE PROJECTOR

POSITIONING:

- This projector is basically designed to project on a flat projection surface.
- This projector can be focused from 3.6'(1.1m) ~ 37.7'(11.5m).
- Refer to the figure below to adjust the screen size.

ROOM LIGHT

The brightness in the room has a great influence on the quality of a picture. Adjust the light little darker, and fine pictures are provided.

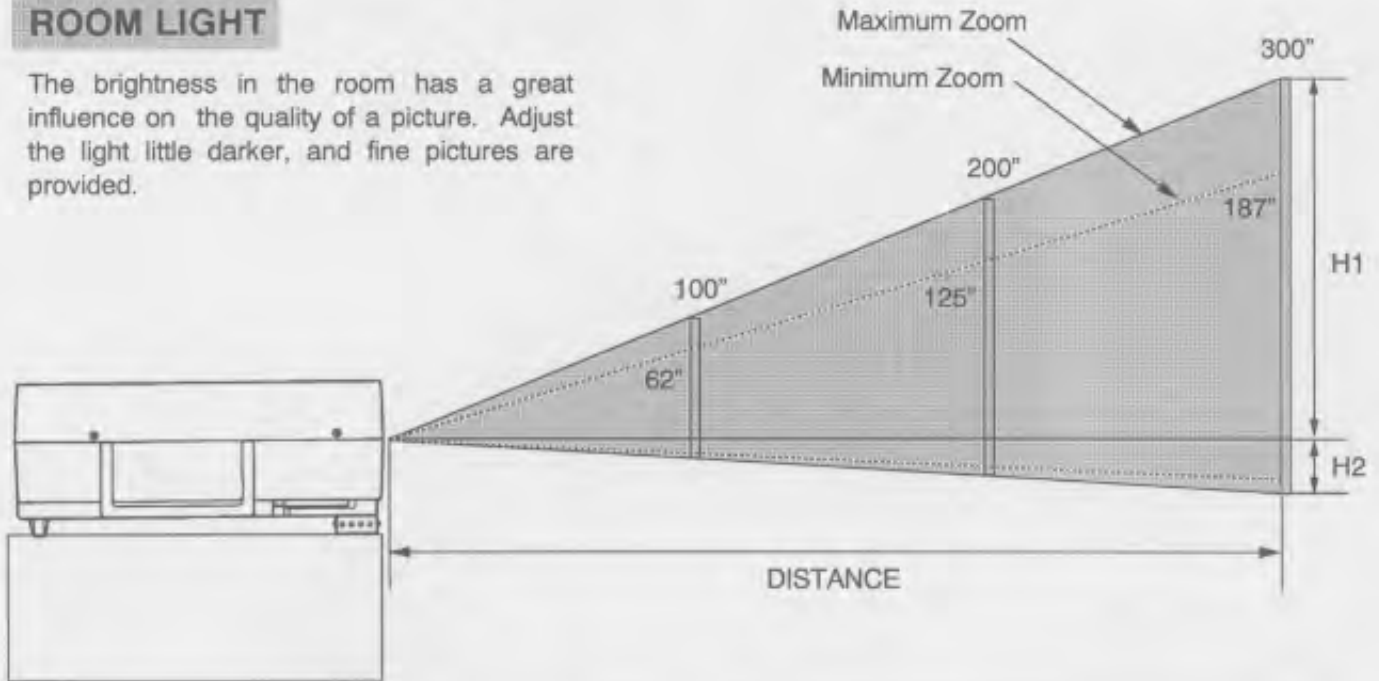

| | | | | | | | |
|-------------|-----------|--------------|--------------|---------------|---------------|---------------|----------------|
| Screen Size | Max. Zoom | 29" | 60" | 100" | 150" | 200" | 300" |
| | Min. Zoom | 18" | 37" | 62" | 93" | 125" | 187" |
| Distance | | 3.6' (1.1 m) | 7.5' (2.3 m) | 12.5' (3.8 m) | 18.7' (5.7 m) | 24.9' (7.6 m) | 37.7' (11.5 m) |

| | | | | | | |
|-------------------------------|---------------|-------------|--------------|--------------|---------------|---------------|
| Screen Size (W × H) inches | 20" | 60" | 100" | 150" | 200" | 300" |
| | 16 × 12 | 49 × 36 | 80 × 60 | 120 × 90 | 160 × 120 | 240 × 180 |
| Height (H1) | 11.4" (290mm) | 34" (864mm) | 57" (1448mm) | 86" (2184mm) | 114" (2896mm) | 171" (4343mm) |
| Height (H2) | 0.6" (15mm) | 2" (50mm) | 3" (76mm) | 4" (102mm) | 6" (152mm) | 9" (229mm) |

VENTILATION

This projector is equipped cooling fans for protection from overheating. Pay attention to the following to ensure the ventilation and avoid a possible risk of fire and malfunction.



- Do not cover the vent windows.
- Keep the rear grill at least one meter away from any object.
- Make sure that there are no object under the projector. An obstacle under the projector may prevent the projector from taking the cooling air through the bottom vent.

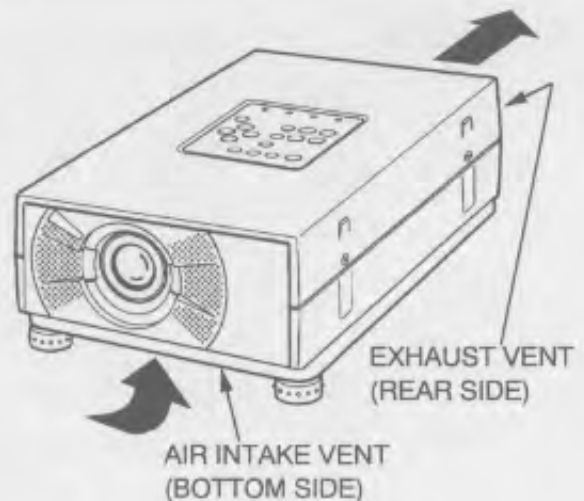

ADJUSTABLE FEET

Picture tilt and projection angle can be adjusted by twisting ADJUSTABLE FEET. Projection angle can be adjusted 0 to 2° degrees by rotating Adjustable Feet.

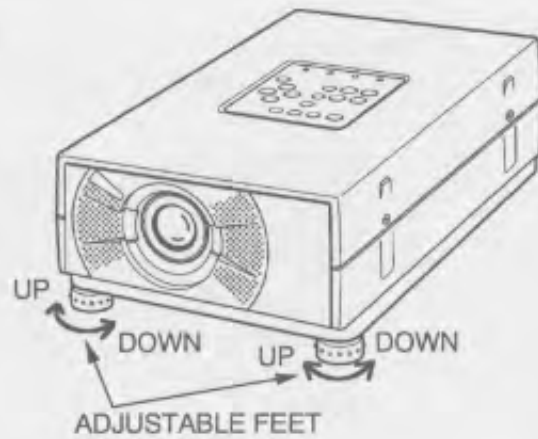
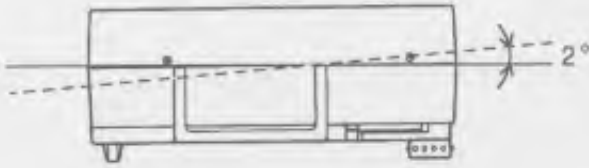

MOVING THE PROJECTOR

Use the carry handle when moving the projector.

- Replace the lens cover and rotate the feet fully clockwise (to shorten the feet) when moving the projector to prevent damage to the projector.

NOTE

The carrying bag (supplied) is intended for protection from dust and scratches on the surface of the cabinet, and it is not designed to protect the LCD projector from external shock.

Do not drop the projector, subject it to strong forces, or put other things on the cabinet when carrying the projector with this bag. Do not transport the projector through a courier or transport services with this bag. The projector can be damaged.

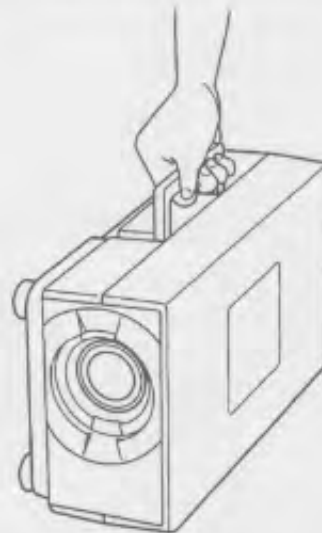

CAUTION IN CARRYING OR TRANSPORTING THE PROJECTOR

- Do not drop or give a shock to the projector, otherwise damages or malfunctions may result.
- When carrying the projector, use a Eiki recommended Carrying Case.
- Do not transport the projector by using a courier or transport service in an unsuitable transport case. This may cause damage to the projector. To transport the projector through a courier or transport service, use a Eiki recommended Case.
- For a carrying or transportation cases, contact a Eiki authorized dealer.

CONNECTING THE PROJECTOR

This projector has various kind of input/output terminals to connect with peripheral equipments. Connect the projector with these equipments before turning them on.

CONNECTING THE COMPUTER

CONNECTING TO THE COMPUTER INPUT HDB15-PIN (VGA) TERMINALS

Computer can be connected to the HDB15-pin terminal on the projector.

- Connect the computer to this terminal using the VGA cable and VGA/MAC adapter (supplied).

CONNECTING TO THE MONITOR OUTPUT HDB15-PIN (VGA) TERMINAL

This terminal outputs only computer input signal to the monitor.

Monitor can be connected to the HDB15-pin (VGA) terminal on the projector.

- Connect the monitor to this terminal using the monitor cable (not supplied).

CONNECTING TO THE COMPUTER AUDIO INPUT JACK

- Connect audio outputs from your computer to this jack using the audio cable (not supplied).

CONNECTING TO THE MULTI-POLE 12-PIN (CONTROL PORT)

- If you wish to control the computer with projector's remote control unit, you must connect control port (PS/2, Serial or ADB port) on your computer to projector's control port with cable. (three type cables supplied ; for PS/2 Port, Serial Port, and ADB Port)

| COMPUTER TYPE | CABLE |
|---|------------------------------|
| IBM Compatible computer with PS/2 mouse port. | Mouse Cable for PS/2 port. |
| IBM Compatible computer with serial control port. | Mouse Cable for Serial port. |
| Apple Macintosh computer with ADB mouse port. | Mouse Cable for ADB port. |

CONTROL PORT CABLE REMOVAL HINT

Disconnect control port cable with following steps.

1. Hold the portion (A) of the connector with one hand.
2. Pull the portion (B) arrow direction and remove connector.

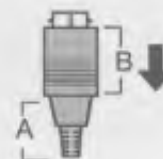

IBM-compatible desktop computer connection

Connect computer referring the figure below.

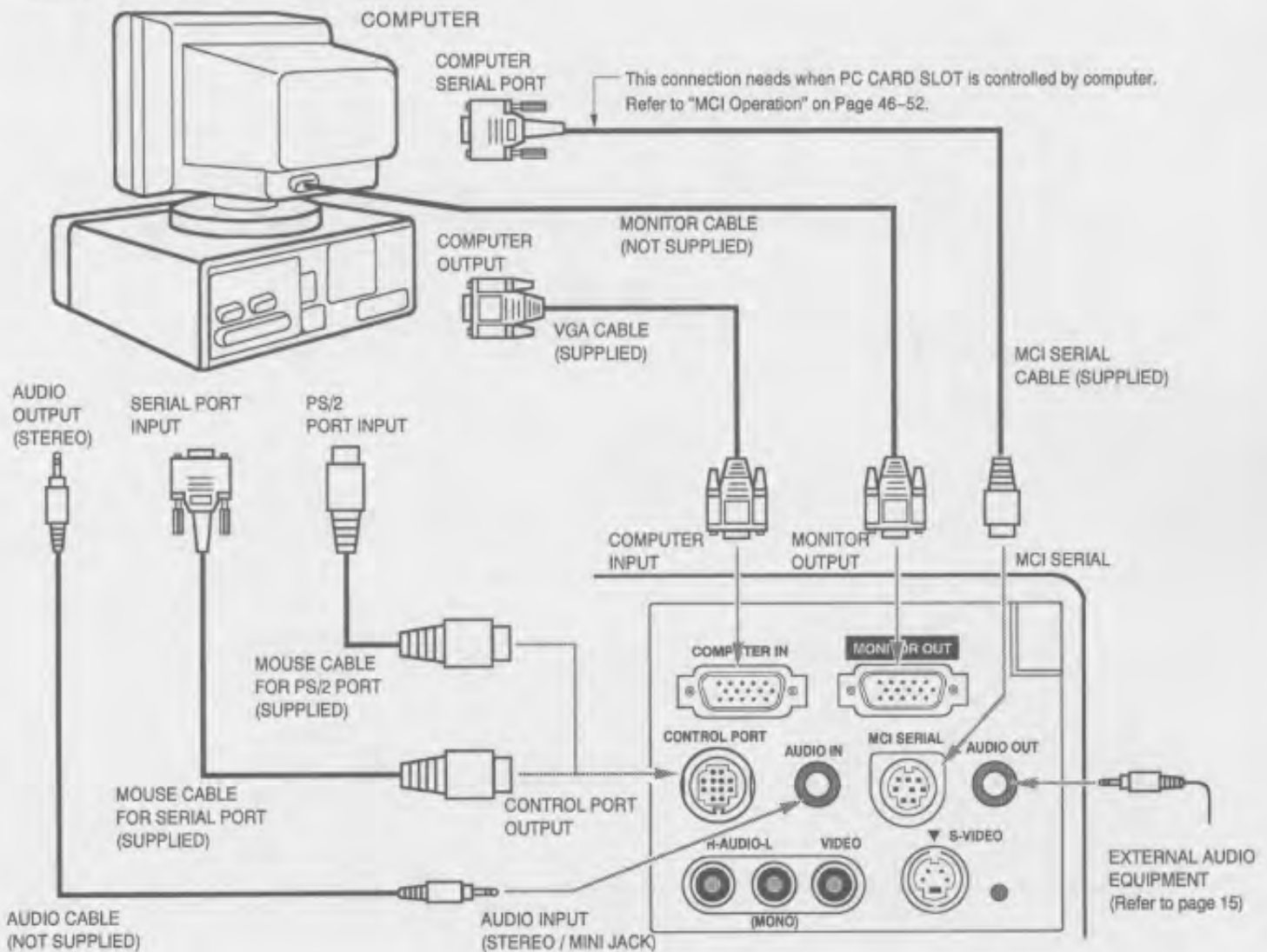

NOTE : When connecting the cable, the power cords of both the projector and the external equipments should be disconnected from AC outlet. Turn the projector and peripheral equipments on before the computer is switched on.

■ HDB 15-PIN TERMINAL (COMPUTER INPUT / MONITOR OUTPUT)

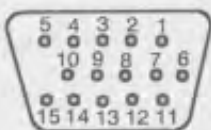

| Pin No. / Signal | Pin No. / Signal |
|-------------------------|-------------------------|
| 1 Red Input | 9 Non Connect |
| 2 Green Input | 10 Ground (Vert. sync.) |
| 3 Blue Input | 11 Sense 0 |
| 4 Sense 2 | 12 Sense 1 |
| 5 Ground (Horiz. sync.) | 13 Horiz. sync. |
| 6 Ground (Red) | 14 Vert. sync. |
| 7 Ground (Green) | 15 Reserved |
| 8 Ground (Blue) | |

■ CONTROL PORT



| | PS/2 Port | Serial Port | ADB Port |
|----|-----------|-------------|----------|
| 1 | | | |
| 2 | | | |
| 3 | | | |
| 4 | GND | GND | GND |
| 5 | | | |
| 6 | | READY | |
| 7 | | | |
| 8 | | RxD | |
| 9 | | | |
| 10 | DATA | | |
| 11 | CLK | | ADB |
| 12 | | TxD | |

Macintosh desktop computer connection

Connect computer referring the figure below.

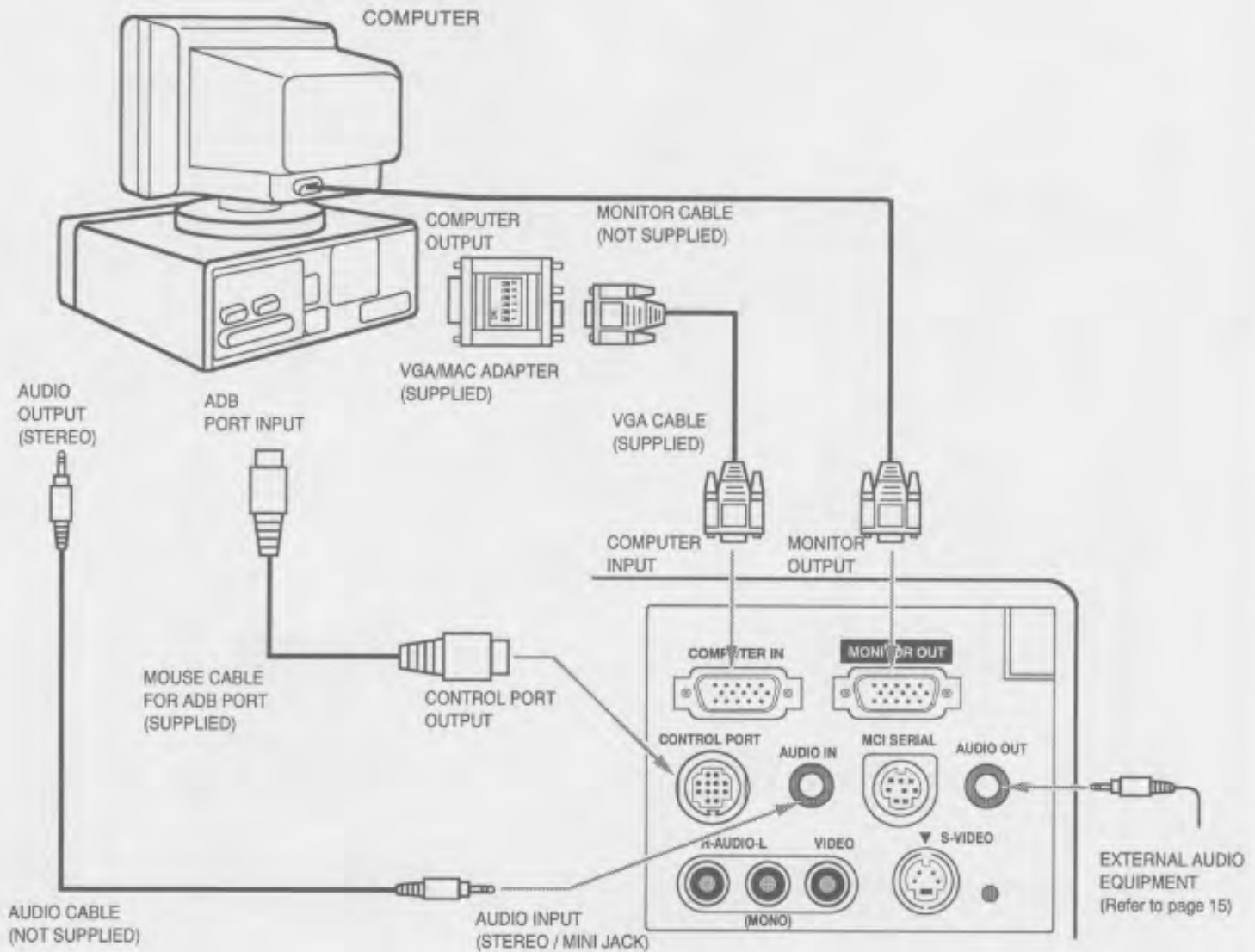

Set the slide switches as shown in the table below depending on the RESOLUTION MODE that you want to use before you turn on the projector and computer.

| RESOLUTION MODE | SW1 | SW2 | SW3 | SW4 | SW5 | SW6 |
|-----------------------|-----|-----|-----|-----|-----|-----|
| 13" MODE (640 × 480) | ON | ON | OFF | OFF | OFF | OFF |
| 16" MODE (832 × 624) | OFF | ON | OFF | ON | OFF | OFF |
| 19" MODE (1024 × 768) | OFF | ON | ON | OFF | OFF | OFF |

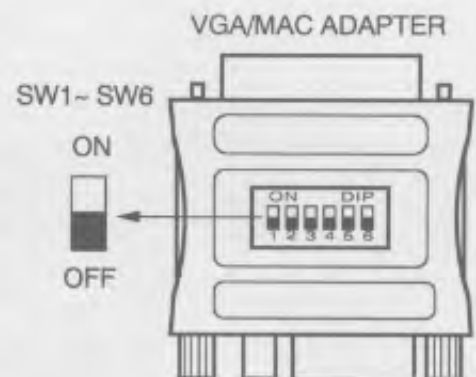

NOTE : When connecting the cable, the power cords of both the projector and the external equipments should be disconnected from AC outlet. Turn the projector and peripheral equipments on before the computer is switched on.

IBM-compatible laptop computer connection

Connect computer referring the figure below.

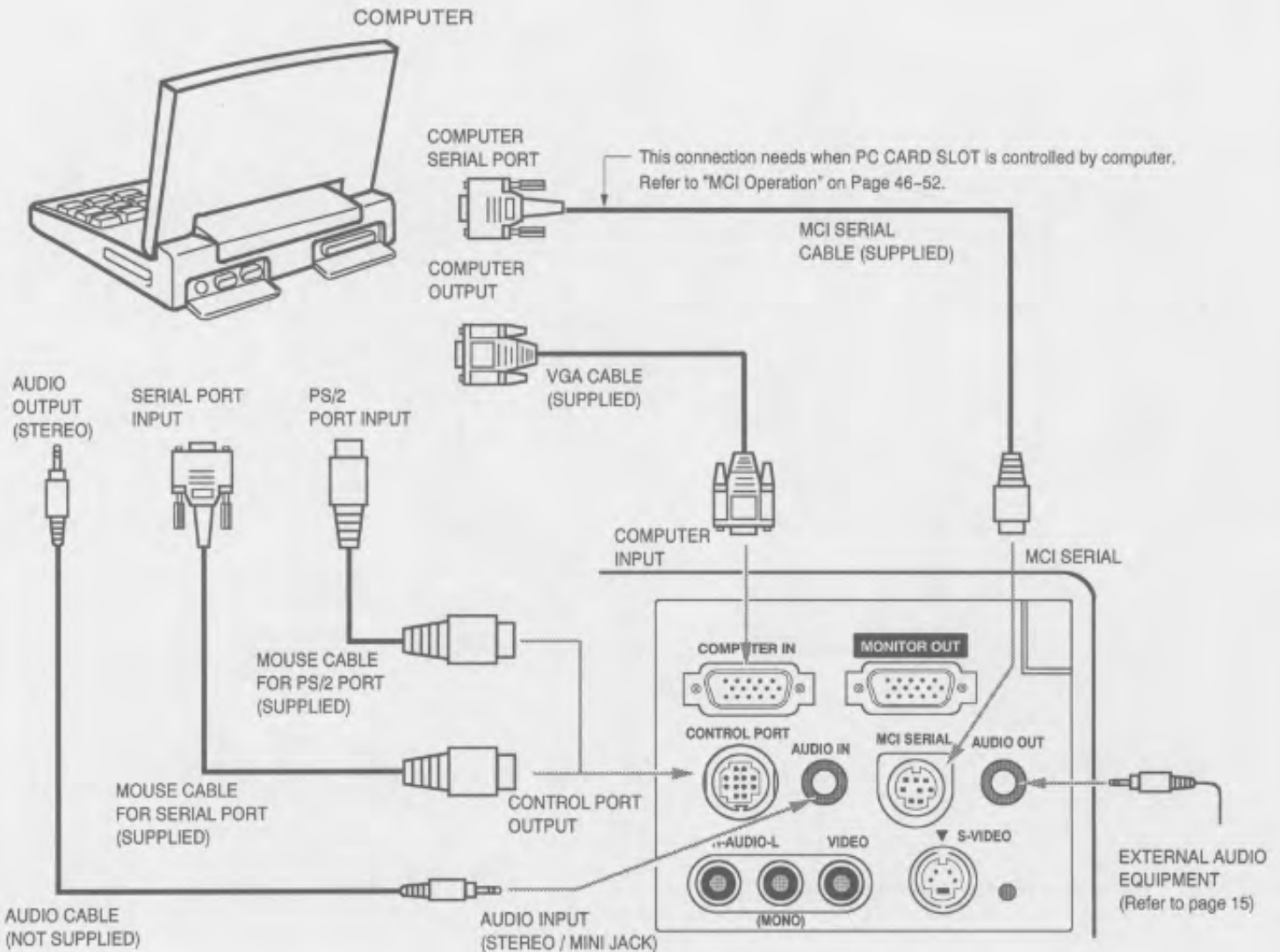

NOTE : When connecting the cable, the power cords of both the projector and the external equipments should be disconnected from AC outlet. Turn the projector and peripheral equipments on before the computer is switched on.

Macintosh PowerBook computer connection

Connect computer referring the figure below.

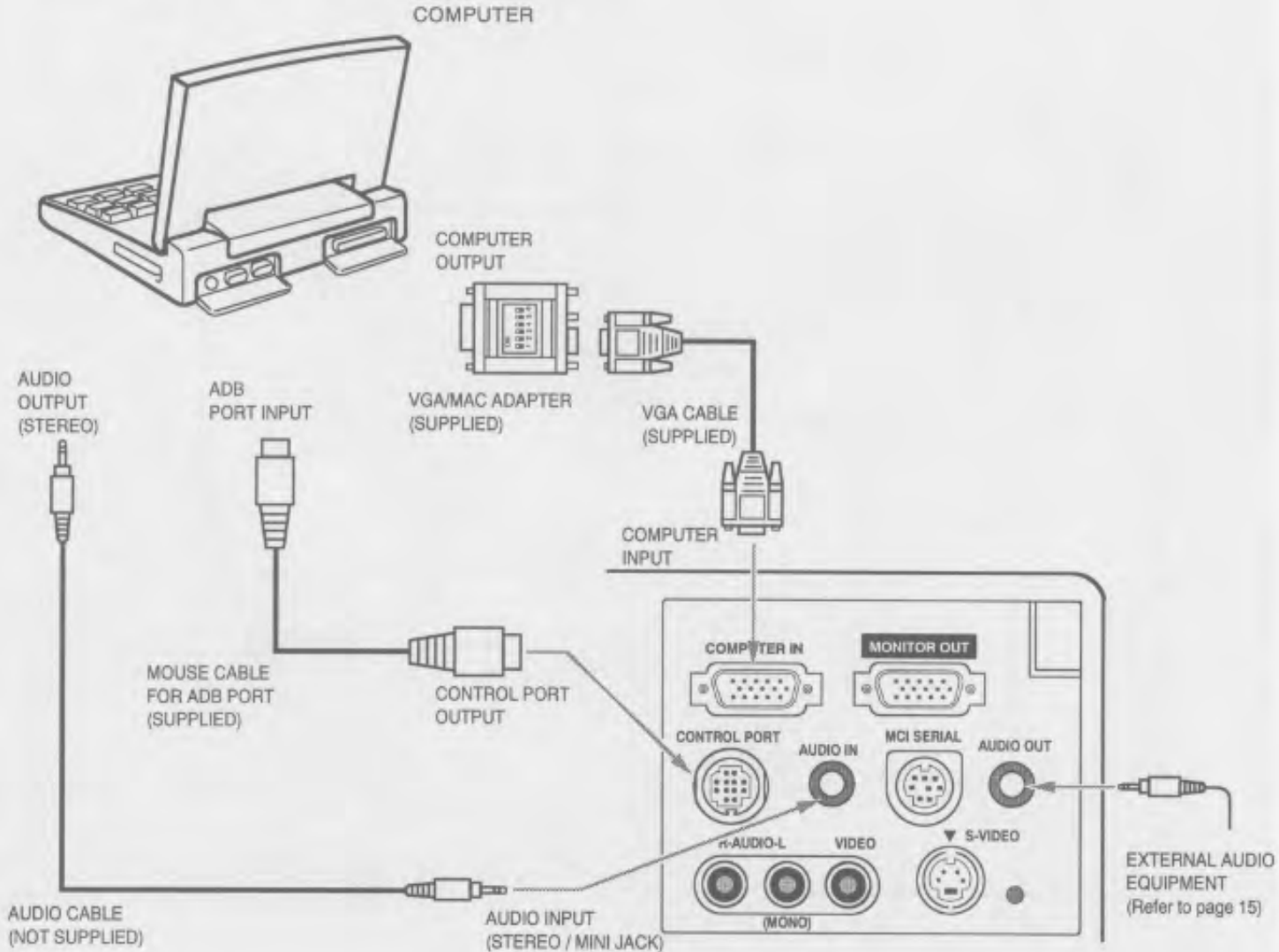

Set the slide switches as shown in the table below depending on the RESOLUTION MODE that you want to use before you turn on the projector and computer.

| RESOLUTION MODE | SW1 | SW2 | SW3 | SW4 | SW5 | SW6 |
|-----------------------|-----|-----|-----|-----|-----|-----|
| 13" MODE (640 × 480) | ON | ON | OFF | OFF | OFF | OFF |
| 16" MODE (832 × 624) | OFF | ON | OFF | ON | OFF | OFF |
| 19" MODE (1024 × 768) | OFF | ON | ON | OFF | OFF | OFF |

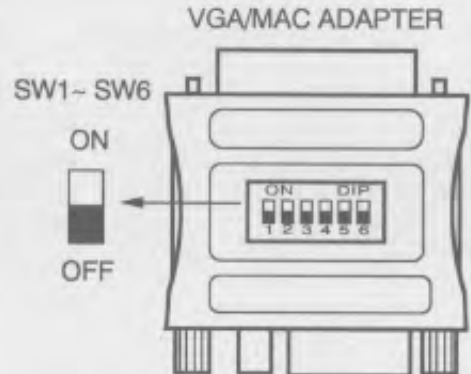

NOTE : When connecting the cable, the power cords of both the projector and the external equipments should be disconnected from AC outlet. Turn the projector and peripheral equipments on before the computer is switched on.

CONNECTING THE VIDEO EQUIPMENT

CONNECTING TO THE AUDIO/VIDEO INPUT JACKS

Connect to the video and audio outputs of a VCR, video disc player, video camera, satellite TV tuner or other Video equipment.

- Connect audio/video outputs from external source to these input jacks using the audio/video cable. (Not supplied)
- If the audio signal from the Video equipment is stereo, be sure to connect the right and left channels to the respective right and left audio input jacks.
- If the external audio signal is monaural, connect it to the L (MONO) .

S-VHS FORMAT VCR CONNECTION

The Video input includes an extra video input jack marked S-VIDEO to allow connection to an S-VHS format VCR that has separate Y/C video signals. The S-VIDEO jack has priority over the VIDEO jack.

CONNECTING THE EXTERNAL AUDIO EQUIPMENT

CONNECTING TO THE AUDIO OUT JACK (mini stereo type)

This jack outputs stereo sound from video or computer input when viewing on screen. If you use external audio equipment, connect the audio amplifier. Internal speaker sound is retained when AUDIO OUT jack is connected. When MCI mode is selected, it outputs sound from computer input.

Video and External Audio Equipments connection

Connect equipments referring the figure below.

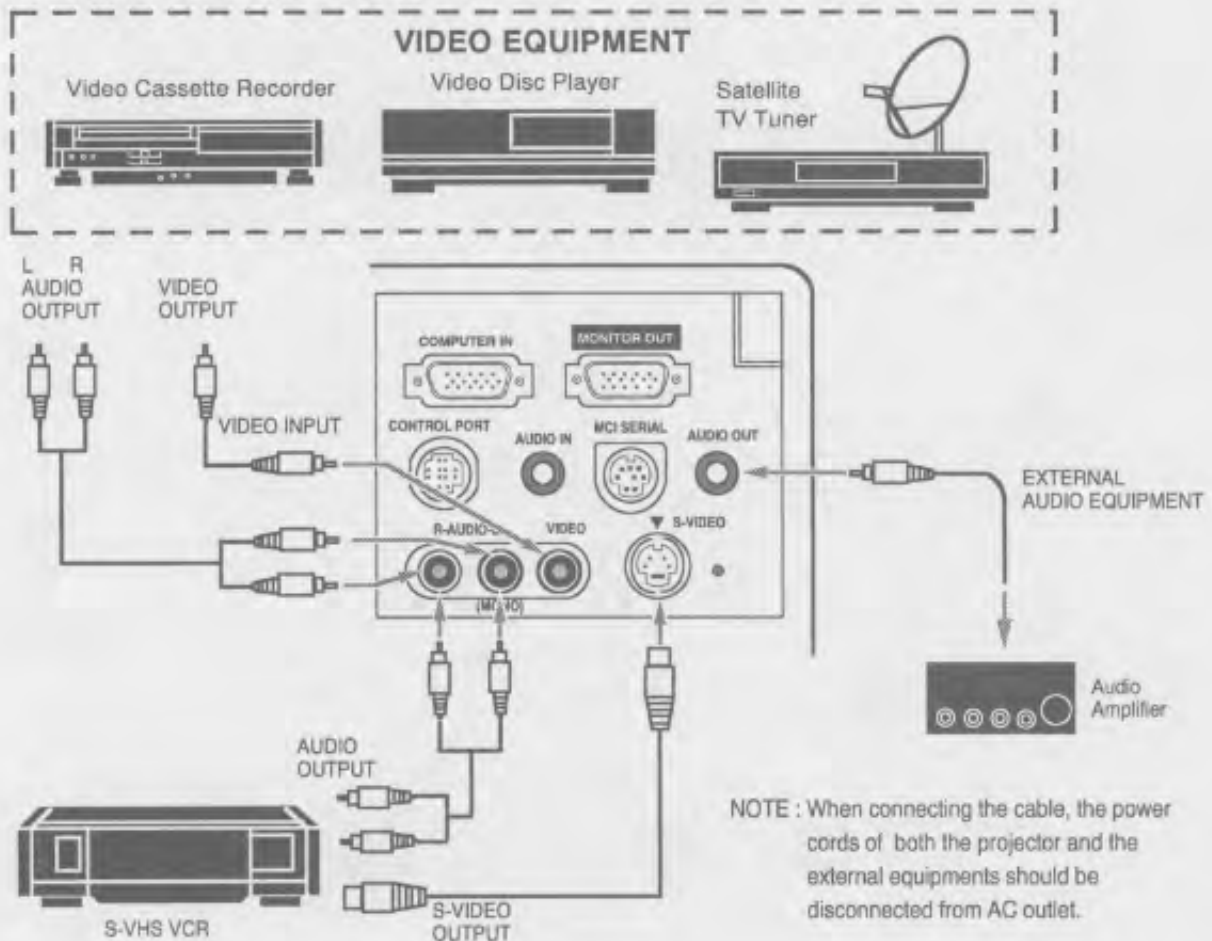

OPERATION OF CONTROLS

TOP OF THE PROJECTOR

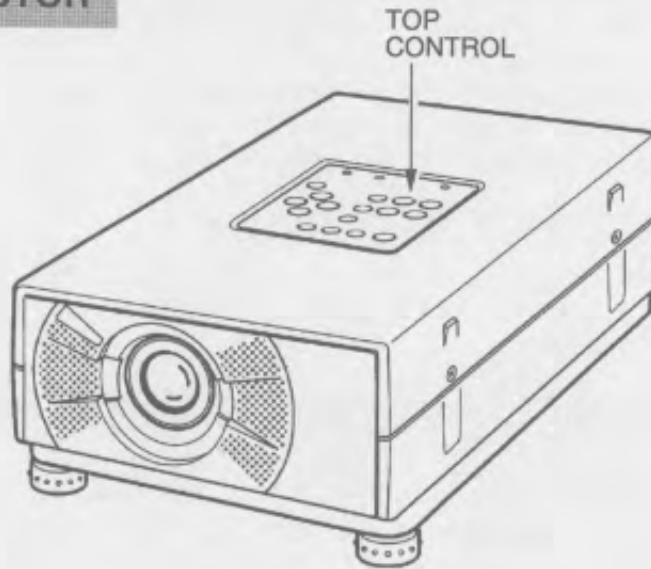

TOP CONTROL

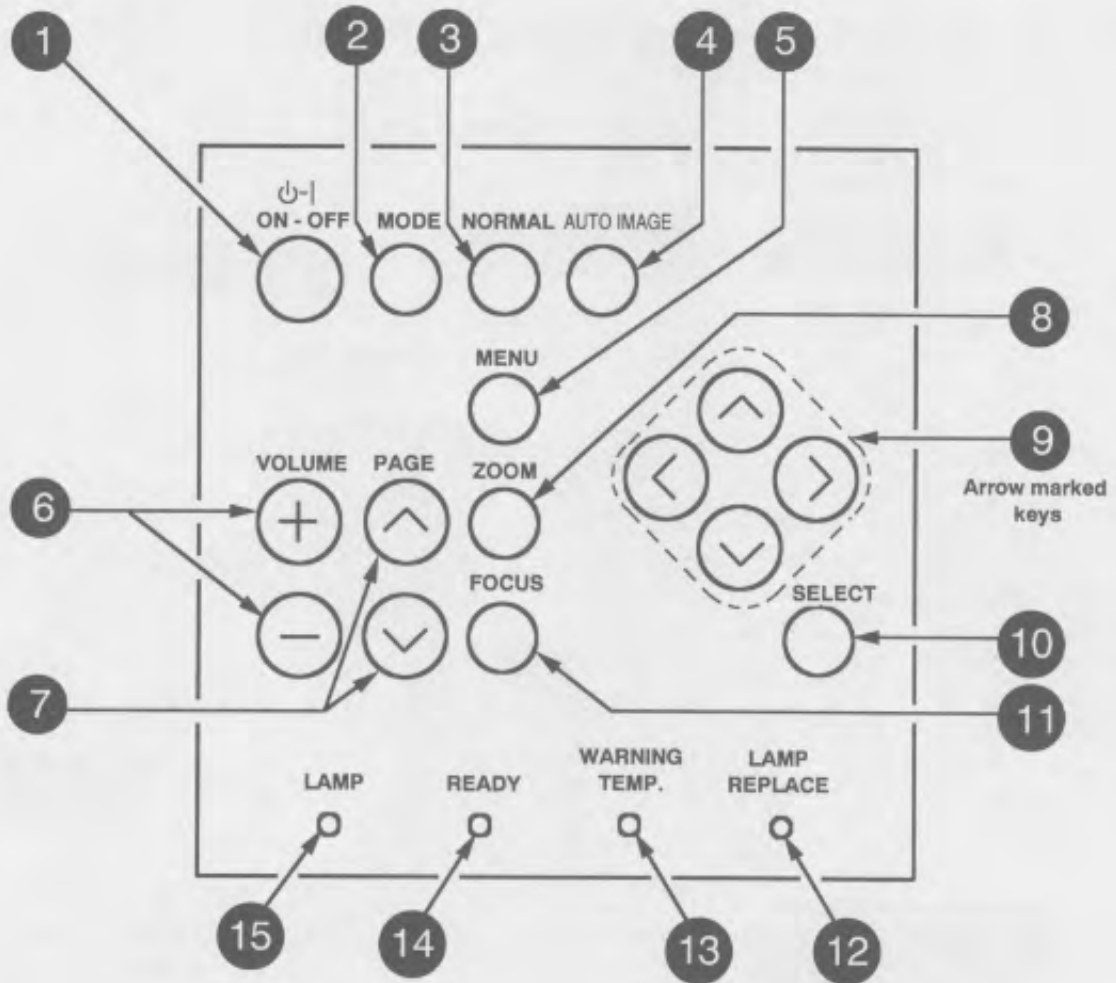

- 1 POWER ON/OFF BUTTON**
Used to turn projector on or off.
- 2 MODE BUTTON**
Used to select input source.
(Computer, Video, or MCI input)
- 3 NORMAL BUTTON**
Used to reset to normal picture adjustment preset by the factory.
- 4 AUTO IMAGE BUTTON**
Used to operate AUTO IMAGE function.
- 5 MENU BUTTON ***
This button is used to call MENU operation. (MENU DISPLAY is displayed on the screen.)
- 6 VOLUME BUTTONS**
Used to adjust volume of sound.
- 7 PAGE BUTTONS**
Used to move to next/previous page of the data in the memory card plugged into PC CARD Slot. These buttons are used to stop or resume AUTO-PLAY function. Page buttons are activated in MCI mode. (Refer to Pages 46-52.)
- 8 ZOOM BUTTON**
Used to select zoom adjust.
- 9 POINT UP/DOWN/LEFT/RIGHT BUTTONS ***
Used to select an item on MENU that you want to adjust. To select an item, move the arrow by pressing these buttons (UP, DOWN, LEFT or RIGHT).
These buttons are used to operate zoom/focus in Direct Operation and to pan the image in Picture Screen Adjustment of Menu Operation. (Refer to Page 42 for Picture Screen Adjustment.)
- 10 SELECT BUTTON ***
Used to activate the item when you want to adjust or change value up or down. This button is used to expand the image in Picture Screen Adjustment of Menu Operation. (Refer to Page 42 for Picture Image Adjustment)
- 11 FOCUS BUTTON**
Used to select focus adjust.
- 12 LAMP REPLACEMENT INDICATOR**
Light turns to yellow when the life of a projection lamp draws to an end.
- 13 TEMPERATURE WARNING INDICATOR**
Flashes red when internal projector temperature is too high.
- 14 READY INDICATOR**
Light is green when projector lamp is ready to be turned on.
- 15 LAMP POWER INDICATOR**
Light is dim when the projector is on.
Light is brightened when the projector is in stand-by mode.

* MENU, POINT UP/DOWN/LEFT/RIGHT, and SELECT buttons are used to operate the projector on MENU DISPLAY. Refer to "MENU OPERATION" on Page 28 to operate MENU DISPLAY.

REAR OF THE PROJECTOR

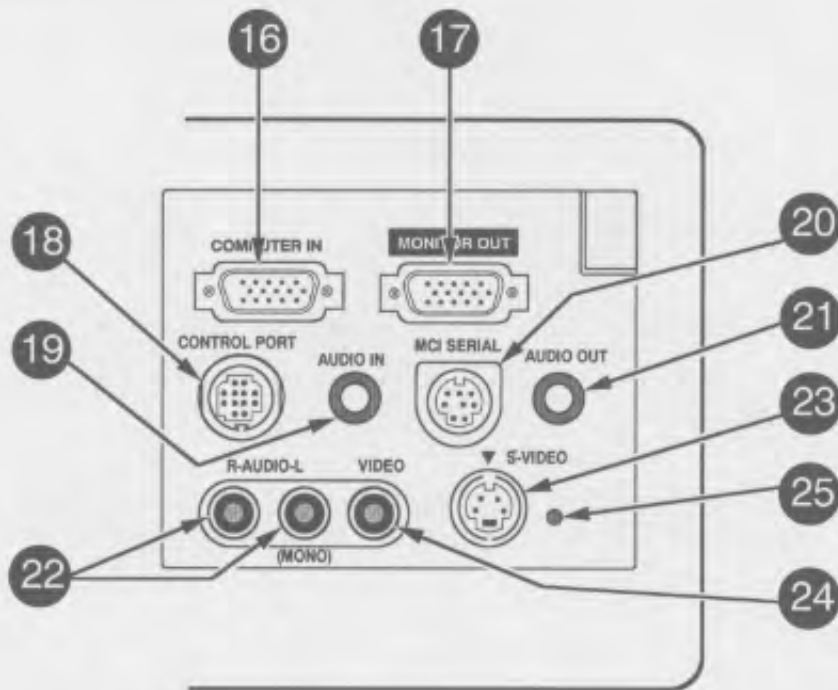

16 COMPUTER INPUT TERMINAL
Used to connect a computer to the projector.

17 MONITOR OUTPUT TERMINAL
Used to connect a monitor to the projector.

18 CONTROL PORT CONNECTOR
Used to connect a mouse port to the projector.

**19 COMPUTER AUDIO INPUT JACK
(3.5mm mini stereo type)**
Used to connect a computer audio input (stereo) to the projector.

20 MCI SERIAL TERMINAL
Used to connect a computer to edit (write and read) the data of PC card with Media Card Imager.

**21 AUDIO OUTPUT JACK
(3.5 mm mini stereo type)**
Used to connect an audio amplifier.

22 AUDIO INPUT JACKS
Used to connect an audio input to the projector.

23 S-VIDEO INPUT JACK
Used to connect a S-VHS video source to the projector.

24 VIDEO INPUT JACK
Used to connect a video source to the projector.

25 RESET BUTTON
This projector adopts Micro Computer to control the appliance. The Micro Computer rarely work incorrectly and may not control the projector properly. In that case, press RESET button with sharpened tool (like a pen) to shut down the appliance. The projector is switched off. Do not use RESET button unreasonably.

OPERATION OF REMOTE CONTROL

This remote control unit is not only able to operate the projector but also usable as a wireless mouse for a PC. POINTING PAD and two click buttons (Rear and Front) are used for wireless mouse operation.

Wireless mouse is usable when PC mouse pointer is displayed on the screen. When MENU DISPLAY or indicator of the projector is displayed on the screen, the wireless mouse function does not work.

NOTE: To use this remote control as a PC wireless mouse, connect the projector to the PC with the attached cable. Signals from the projector are transmitted to the PC, enabling the remote control unit of the projector to be used as a PC wireless mouse. (Refer to "CONNECTING THE PROJECTOR" on Pages 10-14 for the connection.)

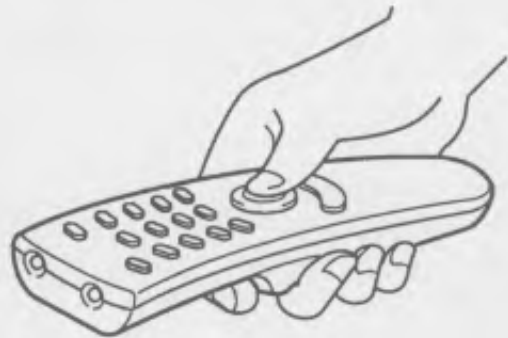

FRONT

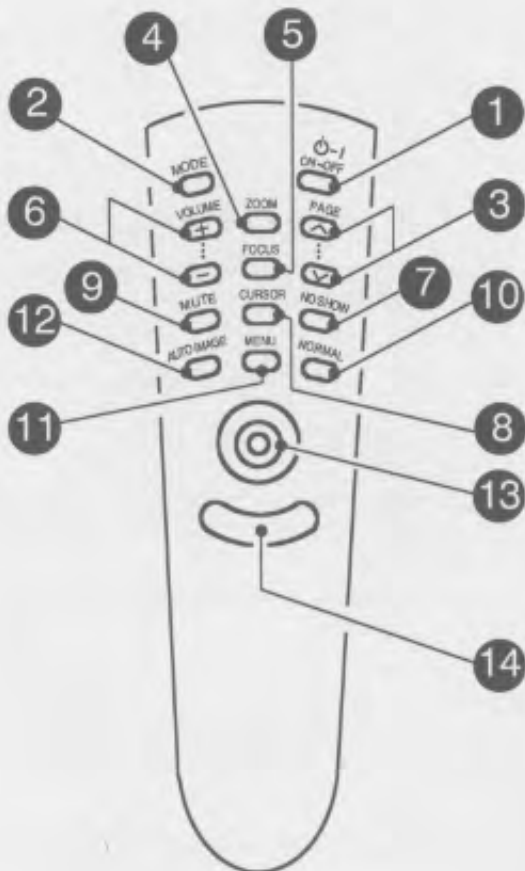

SIDE

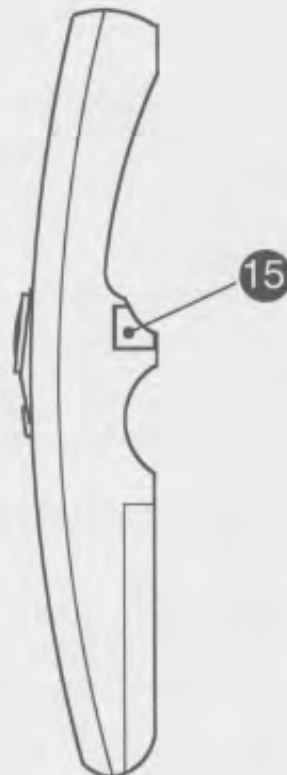

- 1 POWER ON/OFF BUTTON**
Used to turn the projector on or off.
- 2 MODE BUTTON**
Used to select input source. (Computer, Video, or MCI input)
- 3 PAGE BUTTONS**
Used to move to next/previous page of the data in the memory card. These buttons are also used to stop/resume AUTO-PLAY function. PAGE button is activated in MCI mode. (Refer to Pages 46-52.)
- 4 ZOOM BUTTON**
Used to select zoom adjust.
- 5 FOCUS BUTTON**
Used to select focus adjust.
- 6 VOLUME BUTTONS**
Used to adjust volume of sound.
- 7 NO SHOW BUTTON**
Used to turn a picture into black image.
- 8 CURSOR BUTTON**
Used to display CURSOR on the screen. This button is activated in MCI mode. (Refer to Pages 46-52).
- 9 SOUND MUTE BUTTON**
Used to mute sound.
- 10 NORMAL BUTTON**
Use to reset to normal picture adjustment preset by the factory.
- 11 MENU BUTTON ***
Used to call MENU operation. (MENU DISPLAY is displayed on screen).
- 12 AUTO IMAGE BUTTON**
Used to operate AUTO IMAGE function.
- 13 POINTING PAD *
(POINT UP/DOWN/LEFT/RIGHT BUTTON)**
Used to select an item on MENU that you want to adjust. To select an item, move the arrow by pressing the pad upward, downward, leftward or rightward.
This button is also used to operate zoom/focus in Direct Operation and to pan the image in Picture Screen Adjustment of Menu Operation. (Refer to Page 42 for Picture Screen Adjustment.)
- 14 FRONT CLICK BUTTON**
Used to compress the image in Picture Screen Adjustment of Menu Operation. (Refer to Page 42 for Picture Screen Adjustment.)
- 15 SELECT (REAR CLICK) BUTTON ***
Used to activate the item you want to adjust or change the value up or down. This button is used to expand the image in Picture Screen Adjustment of Menu Operation. (Refer to Page 42 for Picture Screen Adjustment.)

* MENU, POINTING PAD, and SELECT buttons are used to operate the projector on MENU DISPLAY. Refer to "MENU OPERATION" on Page 28 to operate MENU DISPLAY.

WIRELESS MOUSE OPERATION

These buttons (POINT PAD, and FRONT/ REAR CLICK buttons) are used as a wireless mouse for a PC. Each of those button has a function below.

- 13 POINTING PAD**
This button is used to move the pointer. The pointer moves according to the directions of POINTING PAD movement.
- 14 FRONT CLICK BUTTON**
This button has the same function as the right button in a PC mouse. Pressing this button does not affect any operation when in MENU mode.
- 15 REAR CLICK BUTTON**
This button has the same function as the left button in a PC mouse.

REMOTE CONTROL BATTERY INSTALLATION

1 Remove the battery compartment lid.



2 Slide the batteries into the compartment.

Note: For correct polarity (+ and - terminal), be sure the battery terminals are in contact with the pins in the compartment.

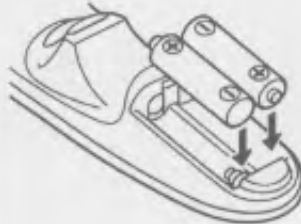

3 Replace the compartment lid.

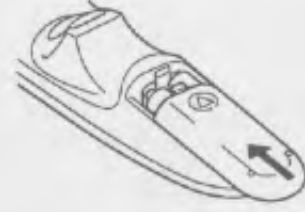

USING REMOTE CONTROL

Point the remote control toward the projector (Receiver window) whenever pressing the buttons. Maximum operating range for the remote control is about 16.4'(5m) and 60° front and rear of the projector.

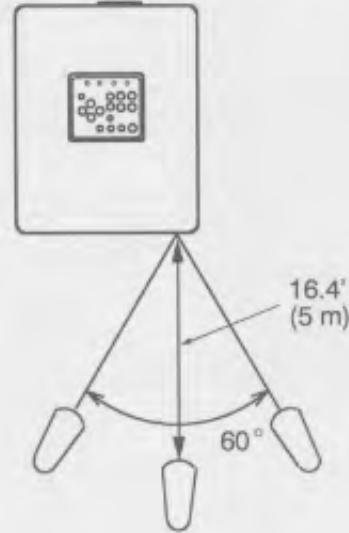
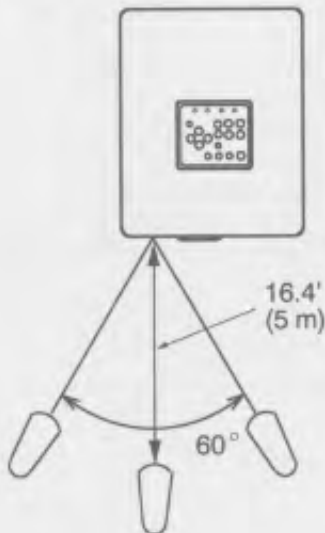

To insure safe operation, please observe the following precautions:

- Use (2) AA type alkaline batteries.
- Replace two batteries at the same time.
- Do not use a new battery with a used battery.
- Avoid contact with water or liquid.
- Do not drop the remote control unit.
- If batteries have leaked on the remote control, carefully wipe the case clean and load new batteries.

CONTROL THE PROJECTOR

This projector is controlled in DIRECT OPERATION, or MENU OPERATION.

DIRECT OPERATION : The projector is controlled directly with buttons on TOP CONTROL or REMOTE CONTROL (Refer to Page 27).

MENU OPERATION : The projector is adjusted by operating MENU DISPLAY. Press MENU button, and MENU DISPLAY is displayed.

DIRECT OPERATION

| ADJUST ITEM | TOP CONTROL OF THE PROJECTOR | REMOTE CONTROL UNIT |
|----------------|---------------------------------------|--|
| POWER ON/OFF | POWER ON-OFF BUTTON | POWER ON-OFF BUTTON |
| MODE SELECT | MODE BUTTON | MODE BUTTON |
| SOUND VOLUME | VOLUME (+) and (-) BUTTONS | VOLUME (+) and (-) BUTTONS |
| SOUND MUTE | Not available | MUTE BUTTON |
| ZOOM | ZOOM BUTTON POINT UP/DOWN BUTTONS | ZOOM BUTTON POINT (UP/DOWN) BUTTON |
| FOCUS | FOCUS BUTTON POINT UP/DOWN BUTTONS | FOCUS BUTTON POINT (UP/DOWN) BUTTON |
| NORMAL PICTURE | NORMAL BUTTON | NORMAL BUTTON |
| NO SHOW | Not available | NO SHOW BUTTON |
| AUTO IMAGE | AUTO IMAGE BUTTON | AUTO IMAGE BUTTON |
| PAGE | PAGE ^ and v BUTTONS | PAGE ^ and v BUTTONS |
| CURSOR | Not available | CURSOR BUTTON POINTING PAD |

MENU OPERATION

| ADJUST ITEM | TOP CONTROL OF THE PROJECTOR | REMOTE CONTROL UNIT |
|-------------|--|--|
| MODE SELECT | MENU BUTTON POINT LEFT/RIGHT BUTTONS SELECT BUTTON | MENU BUTTON POINT (LEFT/RIGHT) BUTTON SELECT (REAR CLICK) BUTTON |

1. COMPUTER / VIDEO / MCI MODE

| ADJUST ITEM | TOP CONTROL OF THE PROJECTOR | REMOTE CONTROL UNIT |
|--|--|--|
| SOUND SOUND VOLUME SOUND MUTE | MENU BUTTON POINT LEFT/RIGHT BUTTONS SELECT BUTTON POINT UP/DOWN BUTTONS SELECT BUTTON | MENU BUTTON POINT (LEFT/RIGHT) BUTTON SELECT (REAR CLICK) BUTTON POINT (UP/DOWN) BUTTON SELECT (REAR CLICK) BUTTON |
| LANGUAGE | | |
| SETTING BLUE BACK DISPLAY CEILING REAR LAMP AGE | | |

2. VIDEO MODE

| ADJUST ITEM | TOP CONTROL OF THE PROJECTOR | REMOTE CONTROL UNIT |
|---|--|--|
| COLOR SYSTEM | MENU BUTTON POINT LEFT/RIGHT BUTTONS SELECT BUTTON POINT UP/DOWN BUTTONS SELECT BUTTON | MENU BUTTON POINT (LEFT/RIGHT) BUTTON SELECT (REAR CLICK) BUTTON POINT (UP/DOWN) BUTTON SELECT (REAR CLICK) BUTTON |
| PICTURE IMAGE COLOR TINT CONTRAST BRIGHTNESS SHARPNESS | MENU BUTTON POINT LEFT/RIGHT BUTTONS SELECT BUTTON POINT UP/DOWN BUTTONS SELECT BUTTON | MENU BUTTON POINT (LEFT/RIGHT) BUTTON SELECT (REAR CLICK) BUTTON POINT (UP/DOWN) BUTTON SELECT (REAR CLICK) BUTTON |
| PICTURE SCREEN REGULAR WIDE | | |

3. COMPUTER MODE

| ADJUST ITEM | TOP CONTROL OF THE PROJECTOR | REMOTE CONTROL UNIT |
|---|--|--|
| COMPUTER SYSTEM | MENU BUTTON POINT LEFT/RIGHT BUTTONS SELECT BUTTON POINT UP/DOWN BUTTONS SELECT BUTTON | MENU BUTTON POINT (LEFT/RIGHT) BUTTON SELECT (REAR CLICK) BUTTON POINT (UP/DOWN) BUTTON SELECT (REAR CLICK) BUTTON |
| PICTURE IMAGE FINE SYNC TOTAL DOTS WHITE BALANCE CONTRAST BRIGHTNESS | MENU BUTTON POINT LEFT/RIGHT BUTTONS SELECT BUTTON POINT UP/DOWN BUTTONS SELECT BUTTON | MENU BUTTON POINT (LEFT/RIGHT) BUTTON SELECT (REAR CLICK) BUTTON POINT (UP/DOWN) BUTTON SELECT (REAR CLICK) BUTTON |
| PC ADJUSTMENT | | |
| AUTO IMAGE FINE SYNC TOTAL DOTS POSITION | | |
| PICTURE POSITION | MENU BUTTON POINT LEFT/RIGHT BUTTONS SELECT BUTTON POINT LEFT/RIGHT/UP/DOWN BUTTONS SELECT BUTTON | MENU BUTTON POINT (LEFT/RIGHT) BUTTON SELECT (REAR CLICK) BUTTON POINT (LEFT/RIGHT/UP/DOWN) BUTTON SELECT (REAR CLICK) BUTTON |
| PICTURE SCREEN TRUE DIGITAL ZOOM | MENU BUTTON POINT LEFT/RIGHT BUTTONS SELECT BUTTON POINT UP/DOWN BUTTONS SELECT BUTTON | MENU BUTTON POINT (LEFT/RIGHT) BUTTON SELECT (REAR CLICK) BUTTON POINT (UP/DOWN) BUTTON SELECT (REAR CLICK) BUTTON |

4. MCI MODE

| ADJUST ITEM | TOP CONTROL OF THE PROJECTOR | REMOTE CONTROL UNIT |
|--|--|--|
| VIEW INDEX PAGE CARD ACCESS | MENU BUTTON POINT LEFT/RIGHT BUTTONS SELECT BUTTON POINT UP/DOWN BUTTONS SELECT BUTTON | MENU BUTTON POINT (LEFT/RIGHT) BUTTON SELECT (REAR CLICK) BUTTON POINT (UP/DOWN) BUTTON SELECT (REAR CLICK) BUTTON |
| PICTURE IMAGE WHITE BALANCE CONTRAST BRIGHTNESS | | |
| PICTURE POSITION | MENU BUTTON POINT LEFT/RIGHT BUTTONS SELECT BUTTON POINT LEFT/RIGHT/UP/DOWN BUTTONS SELECT BUTTON | MENU BUTTON POINT (LEFT/RIGHT) BUTTON SELECT (REAR CLICK) BUTTON POINT (LEFT/RIGHT/UP/DOWN) BUTTON SELECT (REAR CLICK) BUTTON |
| PICTURE SCREEN TRUE DIGITAL ZOOM | MENU BUTTON POINT LEFT/RIGHT BUTTONS SELECT BUTTON POINT UP/DOWN BUTTONS SELECT BUTTON | MENU BUTTON POINT (LEFT/RIGHT) BUTTON SELECT (REAR CLICK) BUTTON POINT (UP/DOWN) BUTTON SELECT (REAR CLICK) BUTTON |

BASIC OPERATION

TURNING ON THE PROJECTOR

1. Connect peripheral equipments (Computer, VCR, and etc.) before turning on the projector. (Refer to "CONNECTING THE PROJECTOR" on Pages 10-15 for connecting those equipments.)
2. Connect the AC power cord of the projector into a wall outlet. Make sure READY INDICATOR on TOP CONTROL turns to green, and LAMP INDICATOR turns to red.
3. Press ON-OFF BUTTON on TOP CONTROL or REMOTE CONTROL. LAMP INDICATOR turns dim.
4. The display and NUMBER appear on the screen, and NUMBER starts to count down until picture image is displayed. It's about 30 seconds to project a picture image.



30

NOTE : Turn on the computer last when the computer is connected in system.



CAUTION

THIS PROJECTOR USES AN UHP LAMP. TO MAINTAIN THE LIFE OF LAMP, ONCE YOU TURN IT ON, WAIT AT LEAST 5 MINUTES BEFORE TURNING IT OFF.

NOTE : When TEMPERATURE WARNING INDICATOR flashes red, the projector will be automatically turned off. Wait at least 5 minutes to turn the projector on again.

If TEMPERATURE WARNING INDICATOR continues to flash, follow the procedures below;

1. Press POWER ON-OFF BUTTON to OFF.
2. Check if the air filter contaminated with dust. The air filter must be maintained and cleaned. Refer to "AIR FILTER CARE AND CLEANING" on Page 53.
3. Press POWER ON-OFF button to ON.

If TEMPERATURE WARNING INDICATOR still continues to flash, call your authorized dealer or service station.

TURNING OFF THE PROJECTOR

1. Press the POWER ON-OFF button on TOP CONTROL or REMOTE CONTROL. The message "Power off?" appears on the screen.
2. Press again POWER ON-OFF button to turn the projector off. Make sure LAMP INDICATOR turns to bright. READY INDICATOR turns off and the cooling fans operate for 1 minute for cooling the projector after switched off. (NOTE : During cooling the projector, it cannot be turned on.)
3. When Cooling of projector finished, READY INDICATOR turns to green again. You can turn the projector on again.



Power off ?

DIRECT OPERATION

MODE SELECT

This function is operated with MODE button. MODE button is used to select the input mode either Computer, Video, or MCI. Select the mode to suit your input source. The "Computer", "Video" or "MCI" display will appear on the screen for a few seconds.

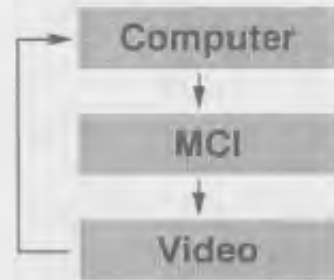

SOUND VOLUME ADJUSTMENT

Press VOLUME buttons (located on TOP CONTROL or REMOTE CONTROL) to adjust the volume. The volume display will be displayed on the screen for a few seconds.

Pressing volume (+) will increase volume and increase the number on the screen.

Pressing volume (-) will decrease volume and decrease the number on the screen.



SOUND MUTE FUNCTION

Pressing MUTE button on REMOTE CONTROL to cut off the audio sound. Press the MUTE button again to restore audio to its previous level. The mute display will be displayed on the screen for a few seconds. External audio equipments produce the audio sound while MUTE is on.

ZOOM ADJUSTMENT

Press ZOOM button (located on TOP CONTROL or REMOTE CONTROL) and press POINT UP/DOWN button(s) to obtain your desired picture size. The Zoom display will be displayed on the screen for a few seconds.

For a larger picture, press (UP) and for a smaller picture, press (DOWN).

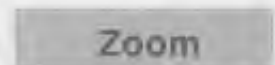

FOCUS ADJUSTMENT

Press FOCUS button (located on TOP CONTROL or REMOTE CONTROL) and press POINT UP/DOWN button(s) to obtain a sharper, crisper picture. The Focus display will be displayed on the screen for a few seconds.

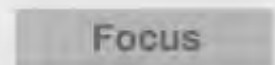

NORMAL PICTURE FUNCTION

The normal picture level is factory preset on the projector and can be restored anytime by pressing NORMAL button (located on TOP CONTROL or REMOTE CONTROL). The "Normal" display will be displayed on the screen for a few seconds.

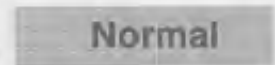

NO SHOW FUNCTION

Press NO SHOW button on REMOTE CONTROL. The screen will change into black image and "NO SHOW" is displayed on the screen for a few seconds. This function is cancelled when NO SHOW button is pressed again or any other function button is pressed.

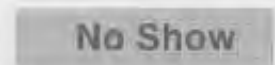

AUTO IMAGE FUNCTION

Press AUTO IMAGE button on TOP CONTROL or REMOTE CONTROL. The item(s) indicated "ON" in AUTO IMAGE FUNCTION are adjusted automatically.

If all the items in AUTO IMAGE FUNCTION are "OFF," AUTO IMAGE SETTING display appears. If you wish to operate AUTO IMAGE FUNCTION, perform the steps 3-9 of "AUTO IMAGE FUNCTION" section on Page 41.

PAGE AND CURSOR FUNCTION

These functions are used in MCI mode. Refer to MCI OPERATION on Pages 46~49 for operation.

MENU OPERATION

Basically MENU operation performs as follow;

1. Press MENU BUTTON. MAIN MENU DISPLAY is displayed.
2. Select the item to adjust or change with POINT BUTTON (UP/DOWN/LEFT/RIGHT) and SELECT (REAR CLICK) BUTTON.
3. Press MENU BUTTON while MAIN MENU DISPLAY is displayed, MENU is closed.

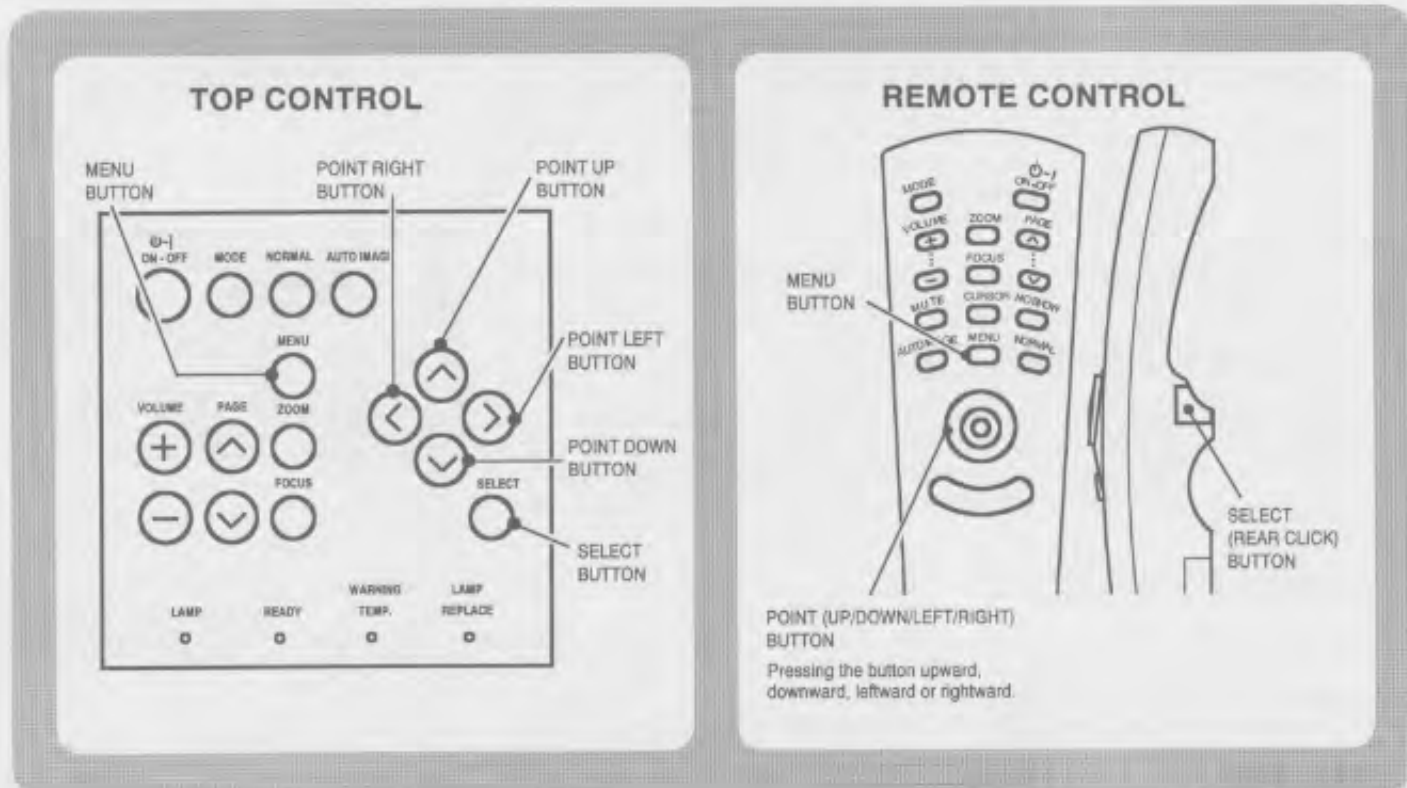

MODE SELECT

Select MODE among COMPUTER, VIDEO, MCI corresponding to the input source with MENU OPERATION.

1. Press MENU BUTTON and display MAIN MENU DISPLAY.
2. Press POINT LEFT/RIGHT BUTTONS to select the mode to suit your input source. (The mode with red box is selected.)
3. Press SELECT (REAR CLICK) BUTTON to fix the mode.

COMPUTER MODE



VIDEO MODE



MCI MODE



SOUND ADJUSTMENT

You can adjust the volume of sound and sound mute on MENU DISPLAY.

1. Press MENU button and MAIN MENU DISPLAY dialog box will appear.
2. Press POINT LEFT/RIGHT button(s) to select SOUND and press SELECT (REAR CLICK) button. Another dialog box SOUND ADJUST DISPLAY will appear.
3. Press POINT DOWN button and a red arrow will appear.
4. Move the arrow to an item that you want to adjust by pressing POINT UP/DOWN button(s).
5. To increase the volume, point the arrow to ▲ and then press SELECT (REAR CLICK) button. To decrease the volume, point the arrow to ▼ and then press SELECT (REAR CLICK) button.
6. To cut off the audio sound, point the arrow to Mute and then press SELECT (REAR CLICK) button. The mute display is changed On from Off and the sound is cut off. External audio equipments produce the audio sound while MUTE is on.
7. To quit Sound Adjustment Menu, point to Quit and then press SELECT (REAR CLICK) button.

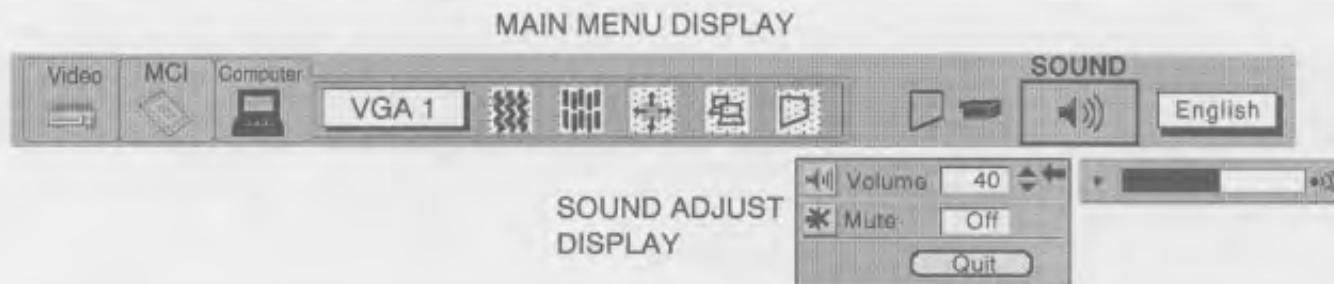

LANGUAGE ADJUSTMENT

MENU DISPLAY is displayed in the language selected among English, German, French, Italian, Spanish and Japanese on MENU DISPLAY.

1. Press MENU button and MAIN MENU DISPLAY dialog box will appear.
2. Press POINT LEFT/RIGHT button(s) to select LANGUAGE and press SELECT (REAR CLICK) button. Another dialog box LANGUAGE SETTING DISPLAY will appear.
3. Press POINT DOWN button and a red arrow will appear.
4. Move the arrow to the language you want to use by pressing POINT UP/DOWN button(s) and then press SELECT (REAR CLICK) button.
5. The setting is permanently held even if POWER ON/OFF is switched off.



COLOR SYSTEM SELECT (VIDEO MODE)

This projector is compatible with the four major broadcast video standards: PAL, SECAM, NTSC or NTSC 4.43 (COLOR SYSTEMS). When the color system is set to "Auto" position, this projector can receive color programs from one of the 4 systems (PAL, SECAM, NTSC or NTSC 4.43), automatically. However, if the video signal is poor, the projector may not reproduce the proper video image. In this case, a specific broadcast format should be chosen by color system select.

1. Connect the video equipment and the projector, and turn them on.
2. Set MODE SELECT to "VIDEO MODE".
3. Press MENU button and MAIN MENU DISPLAY dialog box will appear.
4. Press POINT LEFT/RIGHT button(s) to select SYSTEM and press SELECT (REAR CLICK) button. Another dialog box COLOR SYSTEM DISPLAY will appear. The current COLOR SYSTEM is displayed in the system window.
5. Press POINT DOWN button and a red arrow will appear.
6. If you want to change the COLOR SYSTEM from the current one, move the arrow by pressing POINT UP/DOWN button(s) to the system that you want to select and then press SELECT (REAR CLICK) button and changed the color mode.
7. The setting changed remains effective until POWER ON/OFF switch is turned off.

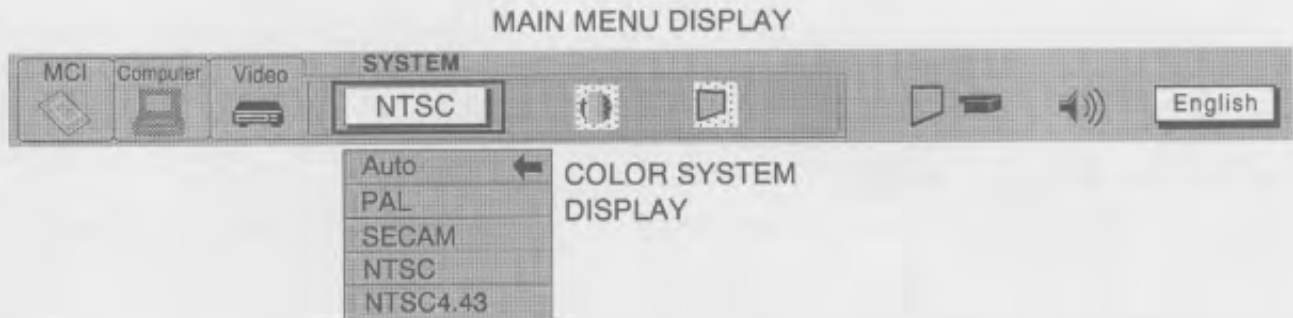

PICTURE IMAGE ADJUSTMENT (VIDEO MODE)

This projector is adjusted for our standards at the factory to produce suitable picture images. If you want to tune the projector finely, it can be adjusted at IMAGE ADJUSTMENT.

1. Press MENU button and MAIN MENU DISPLAY dialog box will appear.
2. Press POINT LEFT/RIGHT button(s) to select IMAGE and press SELECT (REAR CLICK) button. Another dialog box IMAGE ADJUST DISPLAY will appear. This shows the current picture settings.
3. In this dialog box, you can adjust the settings by increasing or decreasing the levels shown as numbers. The items and the range of the levels that you can adjust are summarized in the table as below.
4. Press POINT DOWN button and a red arrow will appear.
5. Move the arrow to an item that you want to adjust by pressing POINT UP/DOWN button(s).
6. To increase the level, point the arrow to ▲ and then press SELECT (REAR CLICK) button. To decrease the level, point the arrow to ▼ and then press SELECT (REAR CLICK) button.
7. You can store the settings in the memory to recall them later. To store the settings, move the arrow to "Stored" and then press SELECT (REAR CLICK) button. When you have stored the settings, "OK ?" is displayed for confirmation.
8. Move the arrow to Yes and then press SELECT (REAR CLICK) button. The stored settings are permanently held even if POWER ON/OFF is switched off.
9. To quit Picture Image Adjustment Menu, move the arrow to Quit and then press SELECT (REAR CLICK) button.
10. If you do not want to store the settings, move the arrow to Quit and then press SELECT (REAR CLICK) button. The settings changed remains effective until POWER ON/OFF switch is turned off.
11. To recall the settings from the memory that you have stored, move the arrow to Reset and then press SELECT (REAR CLICK) button. When you have reset the settings, "OK ?" is displayed for confirmation. Move the arrow to Yes and then press SELECT (REAR CLICK) button. You can adjust the settings again if needed.

NOTE: "TINT" is skipped during in the PAL and SECAM mode.

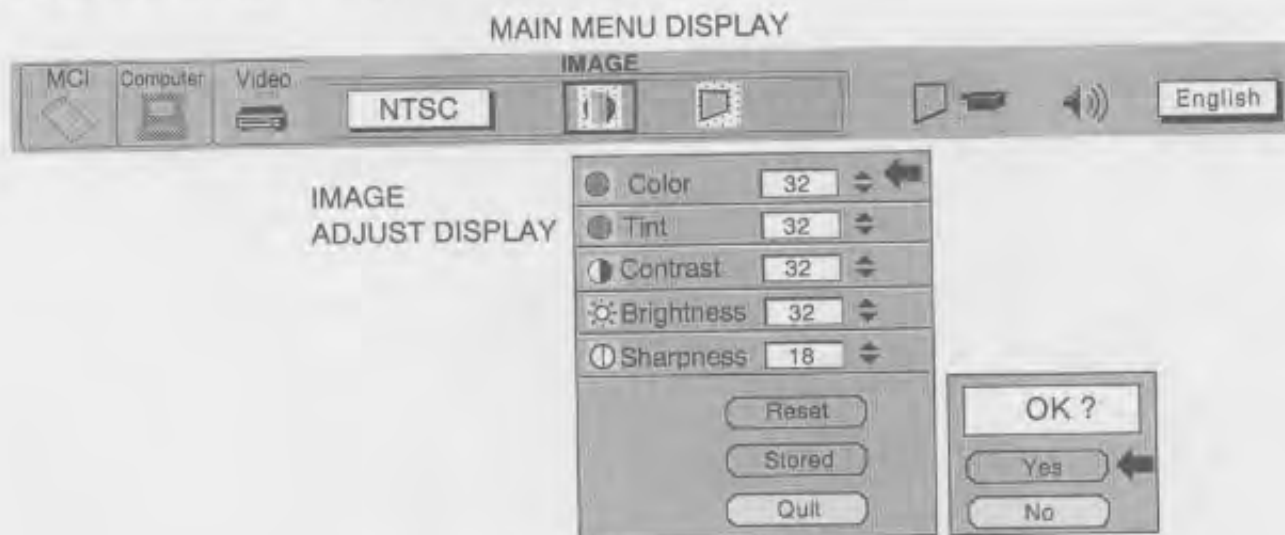

TABLE OF PICTURE IMAGE ADJUSTMENT

| | | | |
|------------|-------------|--------|------------|
| COLOR | DECREASES | 0 ↔ 63 | INCREASES |
| TINT | MORE PURPLE | 0 ↔ 63 | MORE GREEN |
| CONTRAST | LIGHTER | 0 ↔ 63 | DEEPER |
| BRIGHTNESS | DARKER | 0 ↔ 63 | BRIGHTER |
| SHARPNESS | SOFTER | 0 ↔ 31 | SHARPER |

PICTURE SCREEN ADJUSTMENT (VIDEO MODE)

This projector has a Wide function, which enables you to view a wider video image.

WIDE function

This projector is able to project not only a normal video image (with 4 x 3 aspect ratio), but also a wider video image by compressing 4 x 3 image. This feature may be used by those who want to enjoy watching a movie with a cinema-like image. You can switch either to WIDE or to REGULAR screen mode.

1. Press the MENU button and the MAIN MENU DISPLAY dialog box will appear.
2. Press the POINT LEFT/RIGHT button(s) to select SCREEN and press the SELECT (REAR CLICK) button. Another dialog box SCREEN ADJUST DISPLAY will appear.
3. Press the POINT DOWN button and a red arrow will appear.
4. To switch to "Wide" mode, move the arrow to Wide by pressing the POINT UP/DOWN button(s) and then press the SELECT (REAR CLICK) button.
5. To switch to "Regular" mode, move the arrow to Regular by pressing the POINT UP/DOWN button(s) and then press the SELECT (REAR CLICK) button.
6. The "Wide" settings remains effective until the POWER ON/OFF switch is turned off.

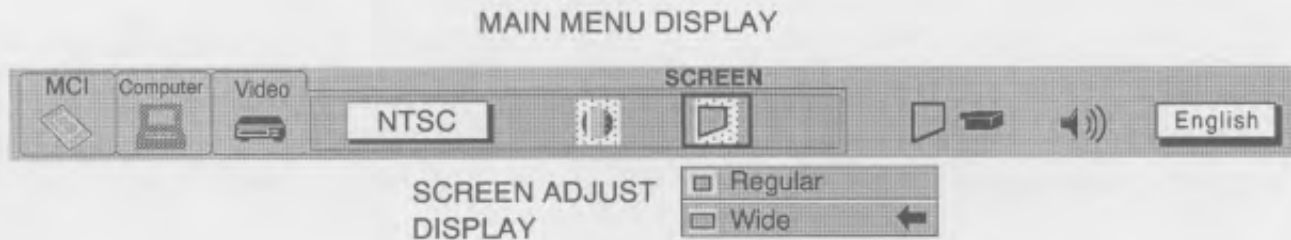

COMPUTER SYSTEM SELECT (COMPUTER MODE)

This projector is adjustable to different types of computer display signals based on VGA, SVGA or XGA (Refer to "COMPATIBLE COMPUTER SPECIFICATIONS" on the next page). If you set MODE SELECT to "COMPUTER", the projector will automatically process the incoming signal and project the proper image without any special setting. Although this will work in most cases, you may be required to manually set the projector for some computer signals. If the computer image is not reproduced properly, try the following procedure and switch to the computer display mode that you want to use.

1. Connect the computer and the projector, and turn them on.
2. Set MODE SELECT to "COMPUTER MODE". This shows the current display mode initially detected by the projector in the system window. And "Current mode" display appears.

NOTE: 1. If the projector cannot discriminate or detect the input signal from the computer, the "Go PC adj." display appears.

NOTE: 2. If no input signal from the computer, the "No signal" display appears on the screen.

3. Press MENU button and MAIN MENU DISPLAY dialog box will appear.
4. Press POINT LEFT/RIGHT button(s) to select SYSTEM and press SELECT (REAR CLICK) button. Another dialog box COMPUTER SYSTEM DISPLAY will appear.
5. Press POINT DOWN button and a red arrow will appear.
6. If you want to change the current display mode, move the arrow by pressing POINT UP/DOWN button(s) to the item of the mode that you want to change into.
7. Press the SELECT (REAR CLICK) button to change the display mode.
8. To quit the Computer System Menu, move the arrow to Quit and then press SELECT (REAR CLICK) button.

MAIN MENU DISPLAY



CURRENT MODE DISPLAY

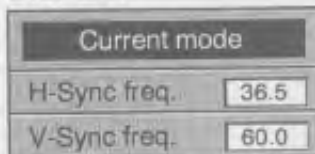

When the mark (↻) is displayed as BLACK, computer system mode will be available on the next page. Move an arrow to the mark (↻) and press SELECT (REAR CLICK) button to show computer system mode described on the next page.

PC ADJUSTMENT

This is a special function that may be used when a computer image is not reproduced properly. (See the pages 37~ 40 for more detail.)

COMPATIBLE PERSONAL COMPUTER SPECIFICATIONS

| ON-SCREEN DISPLAY | RESOLUTION | Horizontal Frequency (kHz) | Vertical Frequency (Hz) |
|-------------------|------------|----------------------------|-------------------------|
| VGA1 | 640 × 480 | 31.47 | 59.88 |
| VGA2 | 720 × 400 | 31.47 | 70.09 |
| VGA3 | 640 × 400 | 31.47 | 70.09 |
| VGA4 | 640 × 480 | 37.86 | 74.38 |
| VGA5 | 640 × 480 | 37.86 | 72.81 |
| VGA6 | 640 × 480 | 37.50 | 75.00 |
| MAC LC13 | 640 × 480 | 34.97 | 66.60 |
| MAC 13 | 640 × 480 | 35.00 | 66.67 |
| PC98 | 640 × 400 | 24.83 | 56.42 |
| FM TOWNS | 640 × 400 | 24.38 | 55.40 |
| SVGA1 | 800 × 600 | 35.156 | 56.25 |
| SVGA2 | 800 × 600 | 37.88 | 60.32 |
| SVGA3 | 800 × 600 | 46.875 | 75.00 |
| SVGA4 | 800 × 600 | 53.674 | 85.06 |
| SVGA5 | 800 × 600 | 48.08 | 72.19 |
| SVGA6 | 800 × 600 | 37.90 | 61.03 |
| SVGA7 | 800 × 600 | 34.50 | 55.38 |
| SVGA8 | 800 × 600 | 38.00 | 60.51 |
| SVGA9 | 800 × 600 | 38.60 | 60.31 |
| SVGA10 | 800 × 600 | 47.90 | 71.92 |
| SVGA11 | 800 × 600 | 32.70 | 51.09 |
| SVGA12 | 800 × 600 | 38.00 | 60.51 |
| MAC 16 | 832 × 624 | 49.72 | 74.55 |
| XGA1 | 1024 × 768 | 48.36 | 60 |
| XGA2 | 1024 × 768 | 68.677 | 84.997 |
| XGA3 | 1024 × 768 | 60.023 | 75.03 |
| XGA4 | 1024 × 768 | 56.476 | 70.07 |
| XGA5 | 1024 × 768 | 60.31 | 74.92 |
| XGA6 | 1024 × 768 | 48.50 | 60.02 |
| XGA7 | 1024 × 768 | 44.00 | 54.58 |
| XGA8 | 1024 × 768 | 63.48 | 79.35 |
| XGA9 | 1024 × 768 | 36.00 | 87.17 (Interlace) |
| XGA10 | 1024 × 768 | 62.04 | 77.07 |
| XGA11 | 1024 × 768 | 61.00 | 75.70 |
| XGA12 | 1024 × 768 | 35.522 | 86.96 (Interlace) |
| XGA13 | 1024 × 768 | 46.90 | 58.20 |
| XGA14 | 1024 × 768 | 47.00 | 58.30 |
| MAC19 | 1024 × 768 | 60.24 | 75.08 |

Specifications are subject to change without notice.

PICTURE IMAGE ADJUSTMENT (COMPUTER MODE)

Picture adjustments have been reset at the factory. If you want to change the setting, operate the projector as follows.

1. Press MENU button and MAIN MENU DISPLAY dialog box will appear.
2. Press POINT LEFT/RIGHT button(s) to select IMAGE and press SELECT (REAR CLICK) button. Another dialog box IMAGE ADJUST DISPLAY will appear. This shows the current picture settings.
3. In this dialog box, you can adjust the settings by increasing or decreasing the levels shown as numbers. The items and the range of the levels that you can adjust are summarized in the table as below.
4. Press POINT DOWN button and a red arrow will appear.
5. Move the arrow to an item that you want to adjust by pressing POINT UP/DOWN button(s).
6. To increase the level, point the arrow to ▲ and then press SELECT (REAR CLICK) button. To decrease the level, point the arrow to ▼ and then press SELECT (REAR CLICK) button.
7. You may want to store the settings in the memory so that you can recall them later. To store the settings, move the arrow to Stored and then press SELECT (REAR CLICK) button. When you have stored the settings, "OK ?" is displayed for confirmation.
8. Move the arrow to Yes and then press SELECT (REAR CLICK) button. The stored settings are permanently held even if POWER ON/OFF is switched off.
9. To quit Picture Image Adjustment Menu, move the arrow to Quit and then press SELECT (REAR CLICK) button.
10. If you do not want to store the settings, move the arrow to Quit and then press SELECT (REAR CLICK) button. The settings changed remains effective until POWER ON/OFF switch is turned off.
11. To recall the settings from the memory that you have stored, move the arrow to Reset and then press SELECT (REAR CLICK) button. When you have reset the settings, "OK ?" is displayed for confirmation. Move the arrow to Yes and then press SELECT (REAR CLICK) button. You can adjust the settings again if needed.

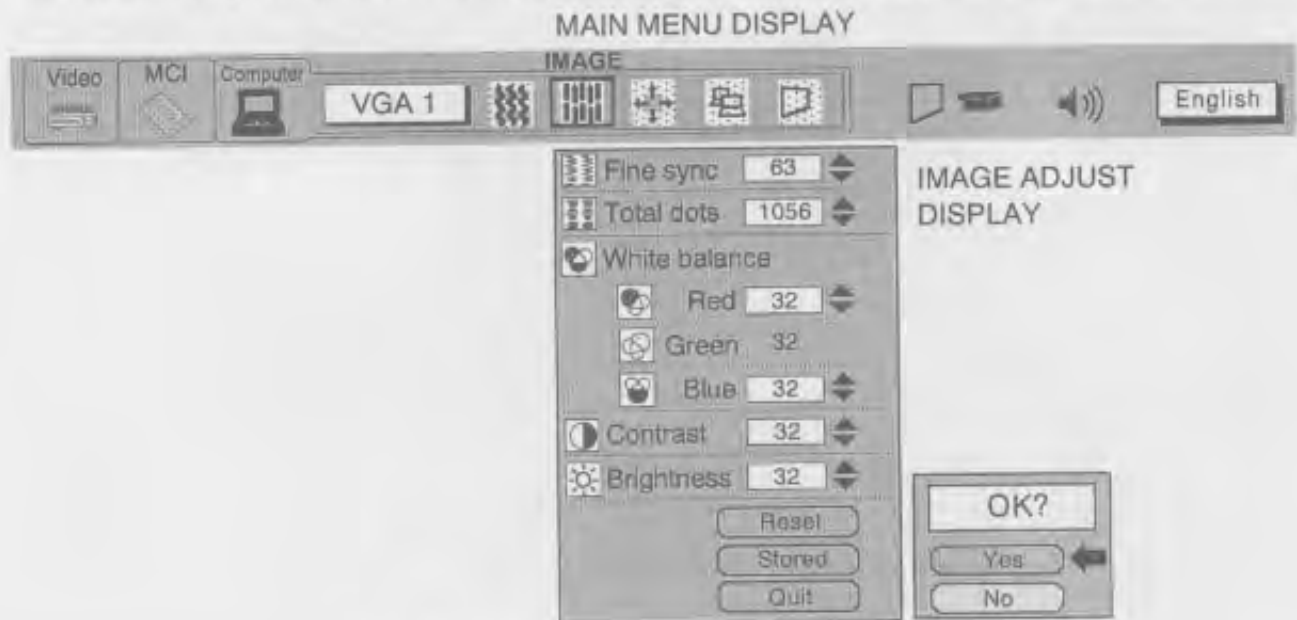
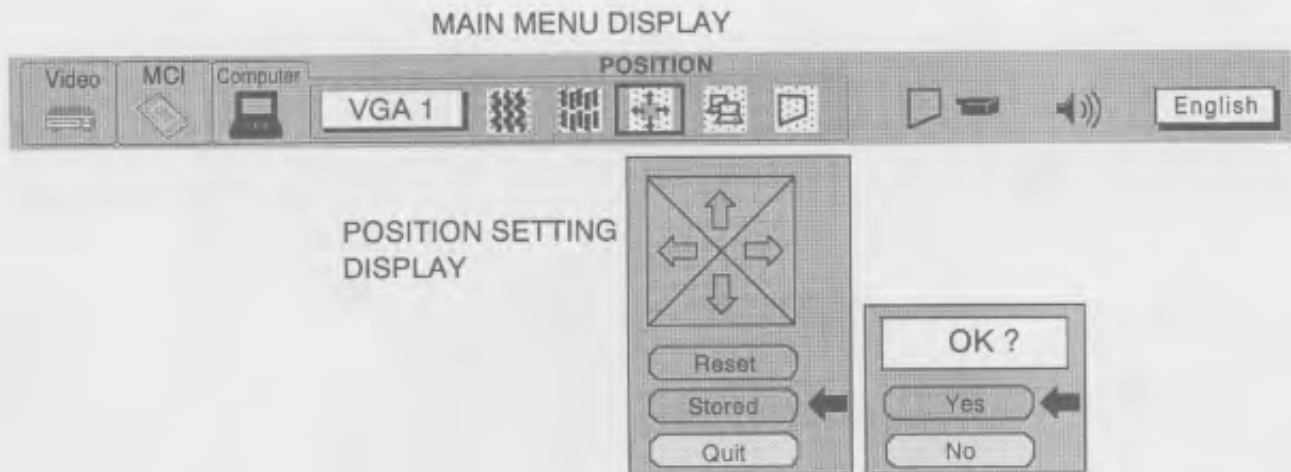

TABLE OF PICTURE IMAGE ADJUSTMENT

| | |
|-----------------------------------|--|
| FINE SYNC | Adjust the picture as necessary to eliminate flicker from the display. 0 ↔ 127 |
| TOTAL DOTS | The number of the total dots in one horizontal period. Adjust the number to match your PC image. |
| WHITE BALANCE (RED / BLUE) | DECREASE 0 ↔ 63 INCREASE |
| CONTRAST | LIGHTER 0 ↔ 63 DEEPER |
| BRIGHTNESS | DARKER 0 ↔ 63 BRIGHTER |

PICTURE POSITION ADJUSTMENT (COMPUTER / MCI MODE)

1. Press MENU button and MAIN MENU DISPLAY dialog box will appear.
2. Press POINT LEFT/RIGHT button(s) to select POSITION and press SELECT (REAR CLICK) button. Another dialog box POSITION SETTING DISPLAY will appear.
3. Press POINT DOWN button and a red arrow will appear.
4. Move the arrow to a desirable direction (← , → , ↑ or ↓) by pressing POINT LEFT/RIGHT/UP/DOWN button(s) and press SELECT (REAR CLICK) button to a desirable picture position.
5. You may want to store the settings to the memory so that you can recall them later. To store the settings, move the arrow to Stored and then press SELECT (REAR CLICK) button. When you have stored the settings, "OK ?" is displayed for confirmation.
6. Move the arrow to Yes and then press SELECT (REAR CLICK) button. The stored settings are permanently held even if POWER ON/OFF is switched off.
7. To quit Picture Position Adjustment Menu, move the arrow to Quit and then press SELECT (REAR CLICK) button.
8. If you do not want to store the settings, move the arrow to Quit and then press SELECT (REAR CLICK) button. The settings changed remains effective until POWER ON/OFF switch is turned off.
9. To recall the settings from the memory that you have stored, move the arrow to Reset and then press SELECT (REAR CLICK) button. When you have reset the settings, "OK ?" is displayed for confirmation. Move the arrow to Yes and then press SELECT (REAR CLICK) button. You can adjust the settings again if needed.



PC ADJUSTMENT

This projector can automatically detect display signals from most personal computers currently distributed. However, some computers employ special signal formats which are different from the standard ones and may not be detected by this projector. If this happens, the projector cannot reproduce a proper image and the image is recognized as a flickering picture, a non-synchronized picture, a non-centered picture or a skewed picture.

This projector has PC ADJUSTMENT function, to enable you to precisely adjust several parameters to match with the input signal format. The projector has eight independent memory areas where you can store the parameter you have set. This enables you to recall the setting for a specific computer whenever you need it.

1. Press MENU button and MAIN MENU DISPLAY dialog box will appear.
2. Press POINT LEFT/RIGHT button(s) to select PC ADJUST and press SELECT (REAR CLICK) button. Another dialog box "Where to reserve" will appear.
3. In this dialog box, you will select one of the memory areas from among "Mode 1" to "Mode 8". If parameters have been previously set and stored in the memory, the status "Stored" will appear on the corresponding row. If not, "Free" will appear.
4. Press POINT DOWN button and a red arrow will appear.
5. Move the arrow to one of the "Modes" (Free position) where you want to store the parameters by pressing the POINT UP/DOWN button(s). Press SELECT (REAR CLICK) button to select it.

NOTE: If "Stored" appears in all Modes, no new PC parameter data can be stored. In this case, clear the PC parameter data using Mode free Function (refer to Page 40).

Continued to the next page.

MAIN MENU DISPLAY

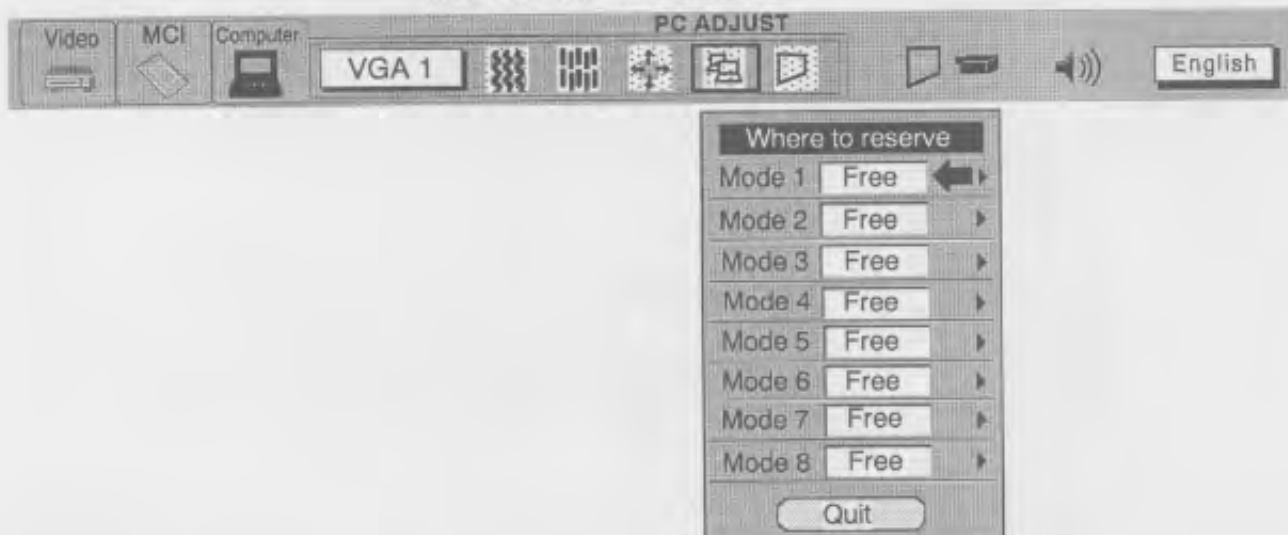

6. Another dialog box "PC ADJUSTMENT DISPLAY 1" will appear and the parameter data for the Mode you have selected is shown in this dialog box.
7. The parameters will be filled with the data determined by the projector according to the present signal input.
8. The function of the parameters and their values are summarized in the table as below.
9. Move the arrow to an item that you want to adjust by pressing POINT UP/DOWN button(s).
10. To increase the level, point the arrow to ▲ and then press SELECT (REAR CLICK) button. To decrease the level, point the arrow to ▼ and then press SELECT (REAR CLICK) button.
11. If you want to store the settings in the memory, move the arrow to Stored and press SELECT (REAR CLICK) button. When you have stored the settings, "OK ?" is displayed for confirmation. Move the arrow to Yes and then press SELECT (REAR CLICK) button .
12. To recall the parameter data before setting, move the arrow to Reset and then press SELECT (REAR CLICK) button. When you have reset the settings, "OK ?" is displayed for confirmation. Move the arrow to Yes and then press SELECT (REAR CLICK) button . You can adjust the settings again if needed.
13. To quit PC Adjustment Menu, move the arrow to Quit and then press SELECT (REAR CLICK) button.
14. If you quit PC Adjustment Menu without storing the settings in the memory, the parameter data you changed will not be kept.
15. The stored settings are permanently held even if POWER ON/OFF is switched off.
16. Adjust the data such as a "Clamp", "Height" and "Width" if you needed, move the arrow by pressing POINT UP/DOWN button(s) to select ▼ . Press SELECT (REAR CLICK) button.

Continued to the next page.

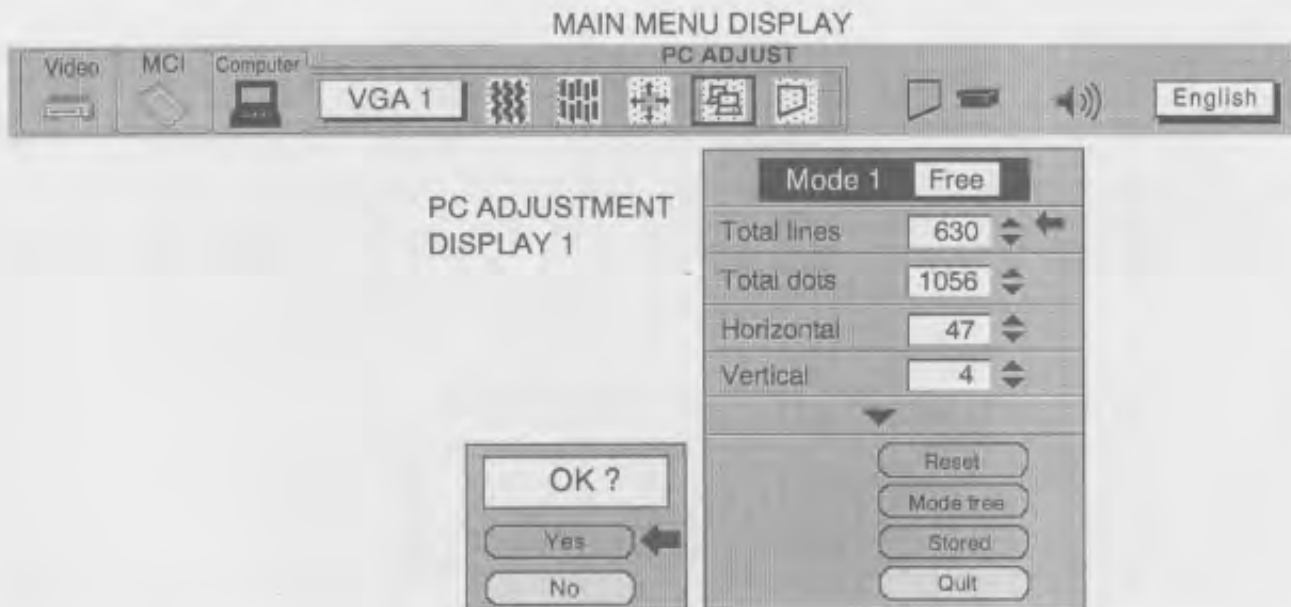

| ITEM | FUNCTION |
|--------------------|---|
| TOTAL LINES | The number of the total vertical lines. Adjust the number to match your PC image. |
| TOTAL DOTS | The number of the total dots in one horizontal period. Adjust the number to match your PC image. |
| HORIZONTAL | Adjustment of the horizontal picture position. When the image is not centered on the screen, adjust this. |
| VERTICAL | Adjustment of the vertical picture position. When the image is not centered on the screen, adjust this. |

17. Another dialog box "PC ADJUSTMENT DISPLAY 2" will appear and the parameter data for the Mode you have selected is shown in this dialog box.
18. Move the arrow to an item that you want to adjust by pressing POINT UP/DOWN button(s).
19. To increase the level, point the arrow to ▲ and then press SELECT (REAR CLICK) button. To decrease the level, point the arrow to ▼ and then press SELECT (REAR CLICK) button.
20. If you want to store the settings in the memory, move the arrow to Stored and press SELECT (REAR CLICK) button. When you have stored the settings, "OK ?" is displayed for confirmation. Move the arrow to Yes and then press SELECT (REAR CLICK) button .
21. To recall the parameter data before settings, move the arrow to Reset and then press SELECT (REAR CLICK) button. When you have reset the settings, "OK ?" is displayed for confirmation. Move the arrow to Yes and then press SELECT (REAR CLICK) button . You can adjust the settings again if needed.
22. To quit PC Adjustment Menu, move the arrow to Quit and then press SELECT (REAR CLICK) button.
23. If you quit PC Adjustment Menu without storing the settings in the memory, the parameter data you changed will not be kept.
24. The stored settings are permanently held even if POWER ON/OFF is switched off.

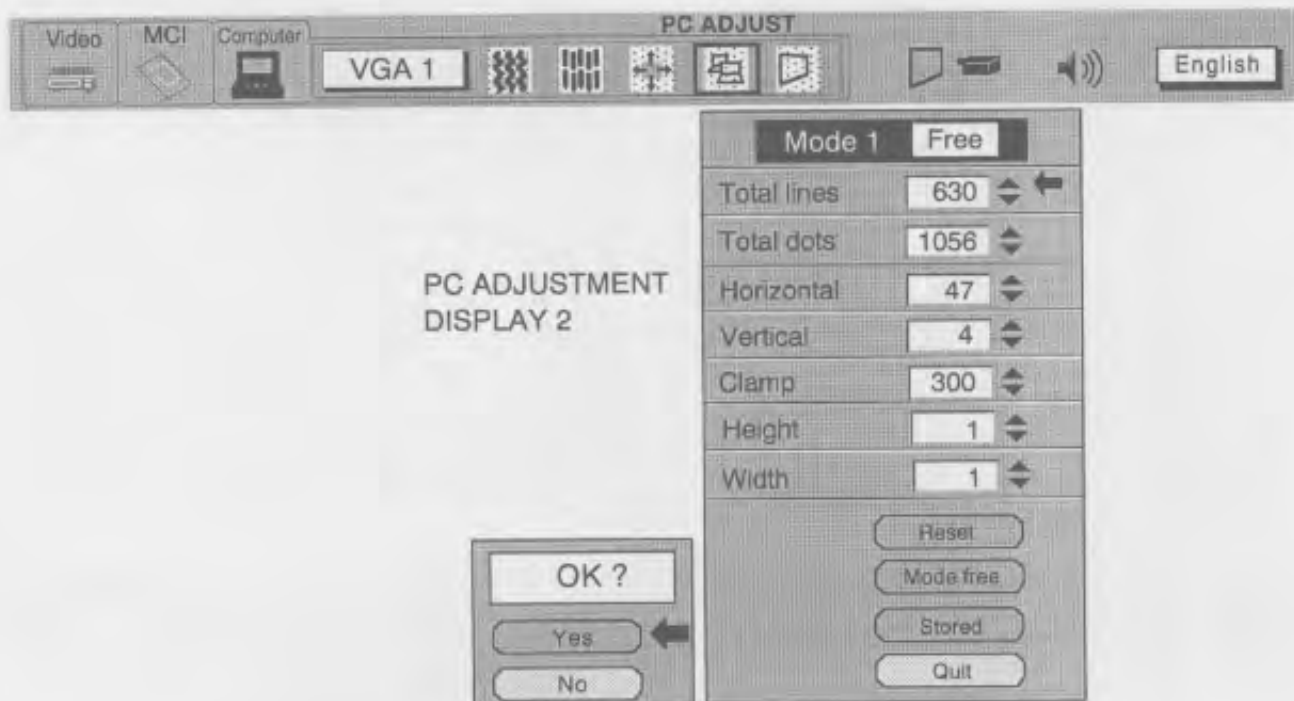

| ITEM | FUNCTION |
|--------|--|
| CLAMP | Adjustment of the clamp level. When the image has a dark bar, try this adjustment. |
| HEIGHT | Expanding or compressing level for the vertical direction. |
| WIDTH | Expanding or compressing level for the horizontal direction. |

MODE FREE

The Mode Free function is designed to delete the parameter data produced by PC ADJUST (Refer to Pages 37 – 39).

1. Press MENU button and MAIN MENU DISPLAY dialog box will appear.
2. Press POINT LEFT/RIGHT button(s) to select PC ADJUST and press SELECT (REAR CLICK) button. Another dialog box "Where to reserve" will appear.
3. Press POINT DOWN button and a red arrow will appear.
4. Move the arrow to one of the "Modes" (Stored position) that you want to confirm by pressing POINT UP/DOWN button(s). Press SELECT (REAR CLICK) button. Another dialog box "PC ADJUSTMENT DISPLAY" will appear.
5. If you delete the parameter data, move the arrow by pressing POINT UP/DOWN button(s) to select Mode free. Press SELECT (REAR CLICK) button. You will see "OK?" as a confirmation.
6. Move the arrow to Yes and then press SELECT (REAR CLICK) button to clear the parameter data.
7. To quit PC Adjustment Menu, move the arrow to Quit and then press SELECT (REAR CLICK) button.

MAIN MENU DISPLAY



PC ADJUSTMENT DISPLAY

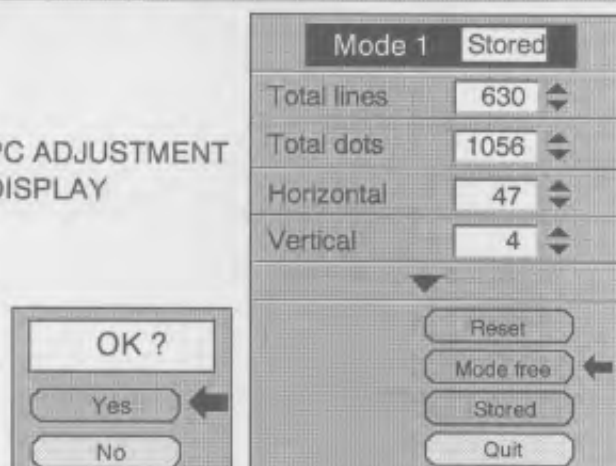

AUTO IMAGE FUNCTION (COMPUTER MODE)

The Auto image function is provided to automatically adjust Fine sync., Total dots and Screen position for most computers.

1. Press MENU button and MAIN MENU DISPLAY dialog box will appear.
2. Press POINT LEFT/RIGHT button(s) to select AUTO IMAGE and press SELECT (REAR CLICK) button. Another dialog box AUTO IMAGE SETTING DISPLAY will appear.
3. Press POINT DOWN button and a red arrow will appear.
4. Move the arrow to an item(s) you want to adjust by pressing POINT UP/DOWN button(s).
5. Change the setting "On", press SELECT (REAR CLICK) button.
6. Move the arrow by pressing POINT UP/DOWN button(s) to select "Go!" and then press SELECT (REAR CLICK) button. The auto image function is started now. It takes 10 ~ 60 seconds.
7. To store the settings, move the arrow to Stored and then press SELECT (REAR CLICK) button. When you have stored the settings, "OK?" is displayed for confirmation.
8. Move the arrow to "Yes" and then press SELECT (REAR CLICK) button. The stored settings are permanently held even if POWER ON/OFF is switched off.
9. To quit Auto Image Menu, point to Quit and then press SELECT (REAR CLICK) button.
10. This setting is temporarily effective until you turn off the projector or change the input signal.

NOTE: The fine sync., total dots and screen position of some computers may not be fully adjusted with the "Auto Image Function." In that case, use the "Picture Image" and/or "Picture Position" adjustments (see pages 35~36) to make fine-adjust them after the "Auto Image function" is executed.

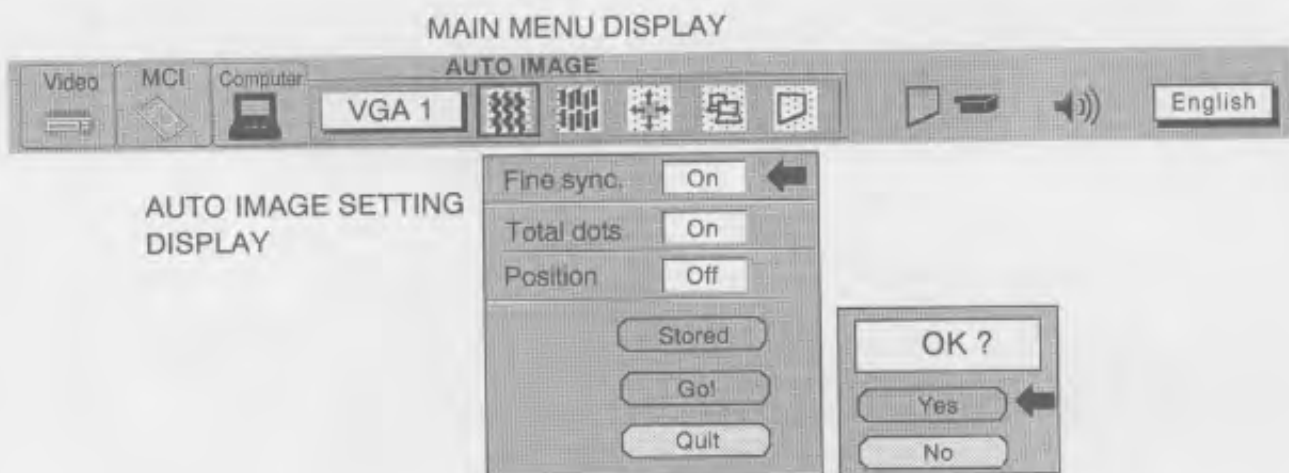

PICTURE SCREEN ADJUSTMENT (COMPUTER / MCI MODE)

This projector can adjust the image size and pan the image with PICTURE SCREEN ADJUSTMENT.

1. Press MENU button and MAIN MENU DISPLAY dialog box will appear.
2. Press POINT LEFT/RIGHT button(s) to select SCREEN and press SELECT (REAR CLICK) button. Another dialog box SCREEN ADJUST DISPLAY will appear.
3. Press POINT DOWN button and a red arrow will appear.
4. To adjust the image size or pan the image, move the arrow to Digital zoom by pressing POINT UP/DOWN button(s) and then press SELECT (REAR CLICK) button. MAIN MENU DISPLAY and SCREEN ADJUST DISPLAY will disappear and the message "Quit" is displayed to indicate Digital Zoom mode.
5. To expand the image size, press SELECT (REAR CLICK) button. The image is magnified by degrees (Expand function).
6. To compress the image size, press FRONT CLICK button. The size of image is reduced by degrees (Compress function).
7. To pan the image, press POINT UP/DOWN/LEFT/RIGHT (POINTING PAD) button(s). The image move to the direction indicated (panning function).
8. To cancel Digital Zoom mode, press other buttons (except PAGE ^ / v , NO SHOW, CURSOR buttons).
9. To turn the image size to true size (800x600 in SVGA or XGA, and 640x480 in VGA), move the arrow to True by pressing POINT UP/DOWN button(s) and then press SELECT (REAR CLICK) button. The image size is turned to the true size.

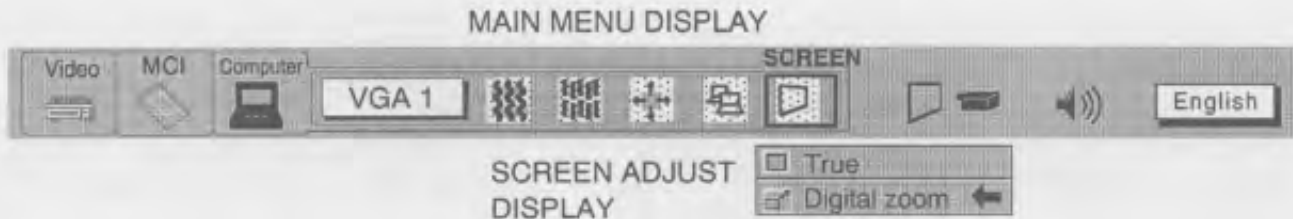

- This projector cannot display in the resolution more than 1024×768 . If your computer's screen resolution is higher than 1024×768 , reset the resolution to the lower before connecting the projector.
- The image data of VGA (640×480) or XGA (1024×768) is modified to fit the screen size in the initial mode.
- The maximum size in expand mode is 4 times as large as the screen size (804×604).
- The minimum size in compress mode is the screen size (804×604) in SVGA, XGA mode, or 640×480 in VGA mode.
- Panning function can work only when the image is expanded.

OTHER FUNCTION SETTING

This projector has other functions' settings; Blue Back, Display, Ceiling, Rear and Lamp Age (Refer to Pages 44 ~ 45).

BLUE BACK

This function provide the blue image on the screen with no video noise when the input signal source is unplugged or turned off. Set this function "On" to make it available.

DISPLAY

When this function is in the "On" position, on-screen displays always appear when adjustments are made. Although these on-screen displays are very helpful, these may spoil the view if adjustments are made during presentations. To avoid this, you can keep back certain displays by switching this function "Off". The followings are the displays that you can hide.

- Wait Display (Number counting down when turning on the projector)
- Mode Display
- Volume Display
- Mute Display
- Zoom/Focus Display
- No Show Display
- Normal Display

CEILING

This function provide top/bottom and left/right reversed picture for projecting from the ceiling-mounted projector. Set this function "On" to make it available.

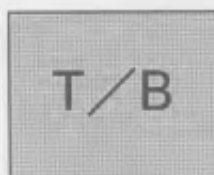

REAR

This function provide left/right reversed pictures for projecting onto a rear projection screen. Set this function "On" to make it available.

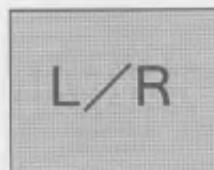

LAMP AGE

Lamp Age function is designed to reset the lamp replacement monitor timer. When replacing the lamp, reset the lamp replacement monitor timer with this function.

BLUE BACK, DISPLAY, CEILING AND REAR

1. Press MENU button and MAIN MENU DISPLAY dialog box will appear.
2. Press POINT LEFT/RIGHT button(s) to select SETTING and press SELECT (REAR CLICK) button. Another dialog box SETTING DISPLAY will appear.
3. Press POINT DOWN button and a red arrow will appear.
4. Move the arrow to an item you want to set by pressing POINT UP/DOWN button(s).
5. If you want to change the setting (On or Off), press SELECT (REAR CLICK) button.
6. To quit Setting Menu, point to Quit and then press SELECT (REAR CLICK) button.
7. The settings are permanently kept even if MAIN ON/OFF is switched off.



LAMP AGE

NOTE: Reset the LAMP REPLACEMENT MONITOR TIMER after the lamp replacement. Never reset it when the lamp is not replaced.

1. Press MENU button and MAIN MENU DISPLAY dialog box will appear.
2. Press POINT LEFT/RIGHT button(s) to select SETTING and press SELECT (REAR CLICK) button. Another dialog box SETTING DISPLAY will appear.
3. Press POINT DOWN button and a red arrow will appear.
4. Move the arrow by pressing POINT UP/DOWN button(s) to select Lamp age and then press SELECT (REAR CLICK) button. When you reset the lamp replace monitor, "lamp replace monitor reset?" is displayed for confirmation.
5. Move the arrow to Yes and then press SELECT (REAR CLICK) button, "OK?" is displayed for confirmation.
Move the arrow to Yes and then press SELECT (REAR CLICK) button, the lamp replace monitor is reset.
6. Move the arrow to No and then press SELECT (REAR CLICK) button. The lamp replace monitor is not reset.
7. To quit Setting Menu, move the arrow to Quit and then press SELECT (REAR CLICK) button.

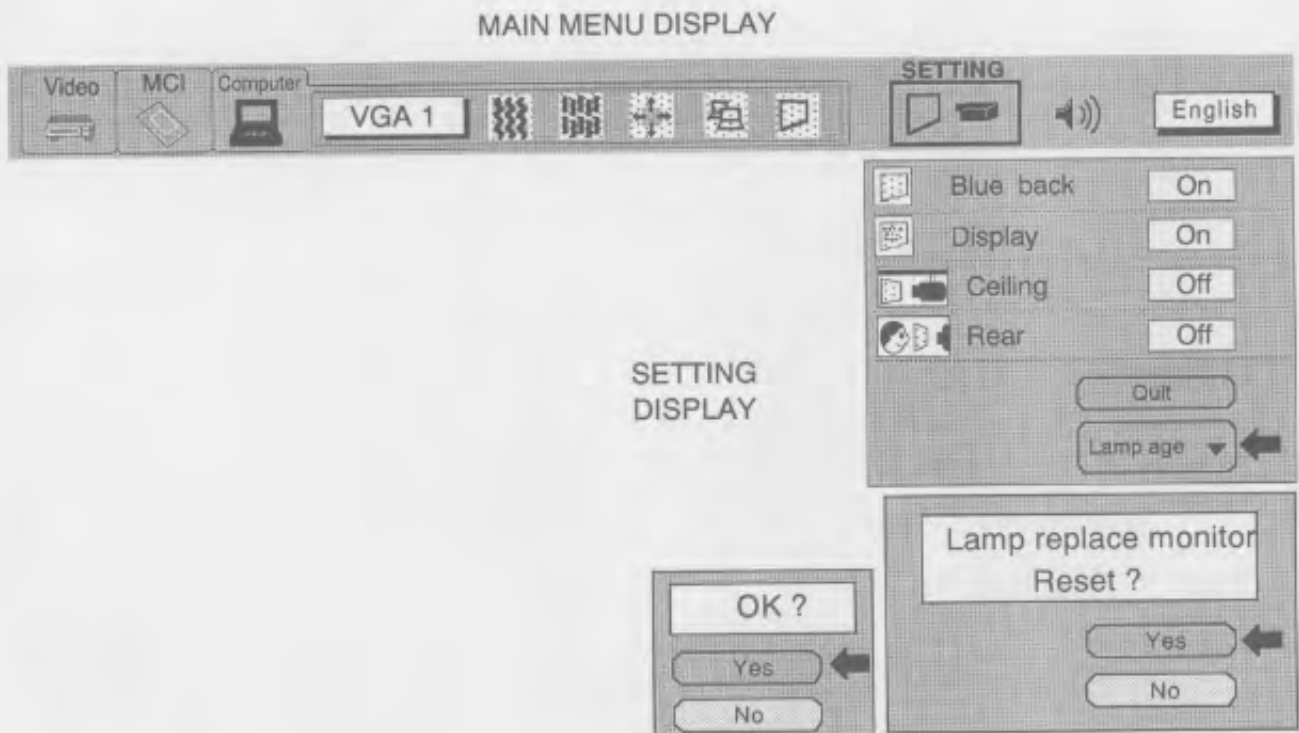

MCI OPERATION

This projector has PC CARD SLOT on its side. Pictures in a memory card (SmartMedia with PC Card Adapter or PC card) can be displayed just by inserting the card into PC CARD SLOT. It is unnecessary to connect with other input equipment. Media Card Imager (supplied with CD-ROM) can edit the image data and record it into a memory card for projecting with the projector.

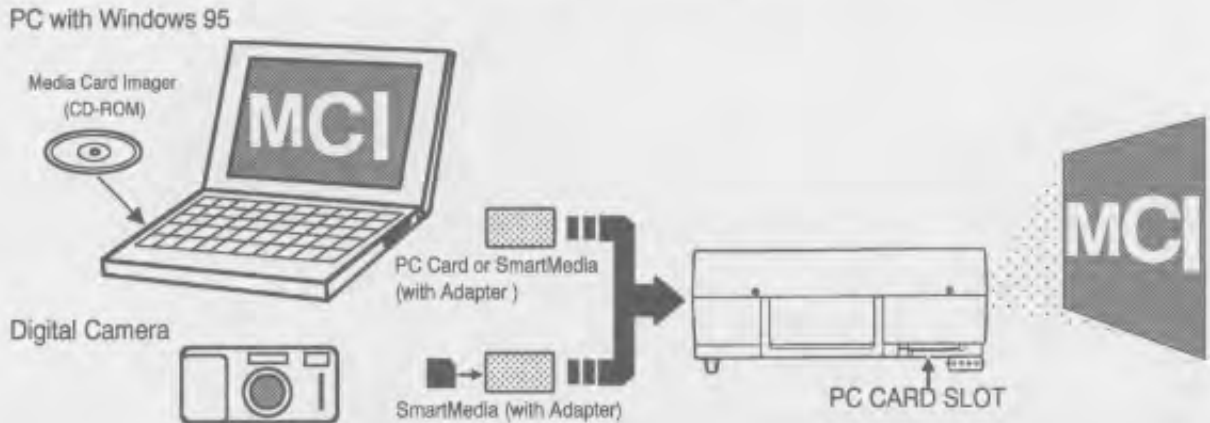

AVAILABLE DATA

This projector can project the image data as follow through PC CARD SLOT.

- The data edited by "Media Card Imager."
- The data in Bit Map type (BMP) or JPEG type (JPG), such as Digital Camera data, can be also displayed. Refer to "BASIC OPERATION" on page 47 to display the image data.

AVAILABLE CARD

SmartMedia (with PC Card Adapter) or Type II PCMCIA-ATA Card can be used with this projector. Refer to SMARTMEDIA AND PC CARD ADAPTER on pages 50, 51 for operation.

NOTE : Some PC Card Adapter or PC Card is not available for this projector and cannot provide the image data. In that case, use SmartMedia and PC Card Adapter supplied with this projector.

LOAD / UNLOAD PC CARD

LOAD

Insert PC Card Adapter (with SmartMedia) or PC card into PC CARD SLOT. Make sure EJECT button pops out.

NOTE : Do not insert the card in the reverse. The card can be damaged.

UNLOAD

Press EJECT button, and the memory card pops out.

NOTE : Do not take the card out while the PC CARD SLOT loading. Data and the card can be damaged.

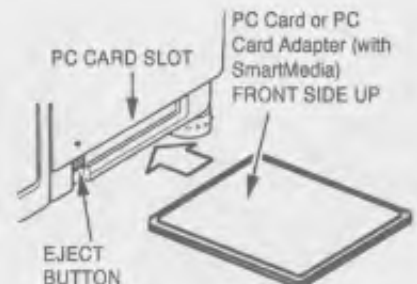

Media Card Imager

Media Card Imager (CD-ROM) is attached to this projector to edit the image data for projecting. Installation of Media Card Imager is recommended. Refer to Owner's Manual of Media Card Imager for installation and operation.

 **PC CARD INDICATOR**
DO NOT REMOVE THE MEMORY CARD WHILE THIS INDICATOR IS LIT. THE DATA IN THE MEMORY CARD CAN BE DAMAGED.

BASIC OPERATION

DISPLAY DATA ON SCREEN

1. When the memory card is inserted into PC CARD SLOT, mode is automatically set to MCI mode and the first Page of the latest Index is projected on the screen. (To turn Video/Computer mode to MCI mode, refer to MODE SELECT on pages 27 and 28.)
 2. To change the page, press PAGE \vee or \wedge buttons.
 3. To select described Index or Page in the table, follow the instructions of INDEX SELECTION and PAGE SELECTION.
- This projector can project only the image data edited with Media Card Imager or the data in Bit Map type or in JPEG type through PC CARD SLOT. Other data is not available and should be edited and written in a memory card with Media Card Imager before loading PC CARD SLOT.
(The data in Bit Map type or in JPEG type, such as the data captured with a digital camera, can be projected directly through PC CARD SLOT.)
 - If there are the data edited with Media Card Imager and other data (such as in Bit Map type or JPEG type) together in a memory card, the data edited by Media Card Imager has a priority to be projected with the LCD projector. The other image data in Bit Map type or JPEG type are not projected. In that case, edit those data and record in the memory card with Media Card Imager.

Index and Page

The data edited with Media Card Imager is a Index consisting of several Pages. To project the Page, select the Index and then select the Page in the Index.

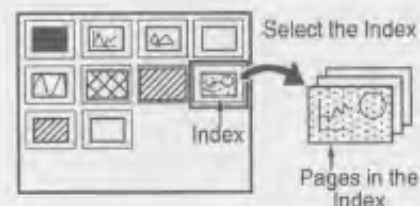

INDEX SELECTION

1. Press MENU button and MAIN MENU DISPLAY dialog box will appear.
2. Press POINT LEFT/RIGHT button(s) to select VIEW and press SELECT (REAR CLICK) button. Another dialog box VIEW SETTING DISPLAY will appear.
3. Press POINT DOWN button and a red arrow will appear.
4. Move the arrow to INDEX by pressing POINT UP/DOWN button(s). The table of Indexes in the memory card will appear.
5. Press POINT UP/DOWN/LEFT/RIGHT (POINTING PAD) button(s) to move to the Index that you want to project and press SELECT (REAR CLICK) button. The first Page of the Index selected is displayed.
6. Press SELECT (REAR CLICK) button again to display the table of Pages.

PAGE SELECTION

1. Press MENU button and MAIN MENU DISPLAY dialog box will appear.
2. Press POINT LEFT/RIGHT button(s) to select VIEW and press SELECT (REAR CLICK) button. Another dialog box VIEW SETTING DISPLAY will appear.
3. Press POINT DOWN button and a red arrow will appear.
4. Move the arrow to PAGE by pressing POINT UP/DOWN button (s). The table of Pages of the Index will appear.
5. Press POINT UP/DOWN/LEFT/RIGHT (POINTING PAD) button(s) to move to the Page that you want to project and press SELECT (REAR CLICK) button. The page selected is displayed on the screen.
6. The table of Pages can be displayed by pressing SELECT button when the page is displayed on full screen.

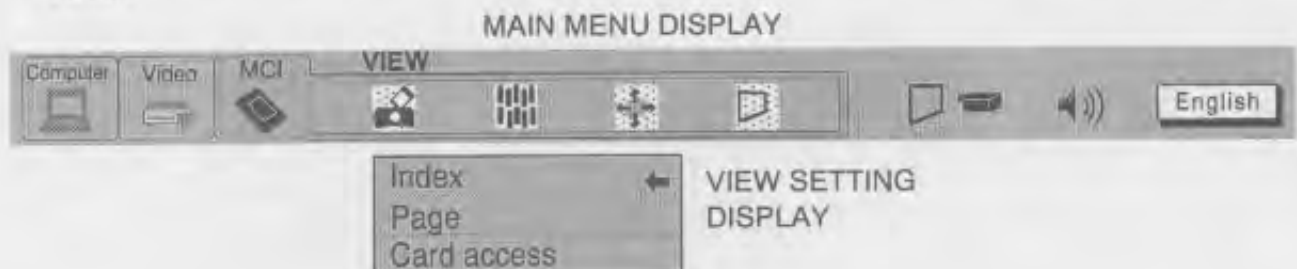

CURSOR

The data edited with Media Card Imager can provide CURSOR for easier presentation. Media Card Imager can select the CURSOR among variety of shapes and colors.

Refer to Media Card Imager 1.0 Help for CURSOR setting. (Pointer Settings)



CURSOR DISPLAY

1. Set MCI mode (refer to PAGE 27 or 28 for operation).
2. Press CURSOR button, the CURSOR is displayed on the screen.
3. Press POINT UP/DOWN/LEFT/RIGHT (POINTING PAD)to control CURSOR. CURSOR can move only vertically and horizontally.
Press CURSOR button again, and CURSOR disappears.

AUTOPLAY FUNCTION

This projector have AUTOPLAY function when the data is set to play automatically with Media Card Imager.

Press PAGE ^ button to stop the AUTOPLAY function, and press PAGE v button to start the AUTOPLAY function again.

Refer to HELP on Media Card Imager for setting AUTOPLAY.

PICTURE POSITION ADJUSTMENT

Refer to PAGE 36 for operating PICTURE POSITION ADJUSTMENT.

PICTURE SCREEN ADJUSTMENT

Refer to PAGE 42 for operating PICTURE SCREEN ADJUSTMENT.

WRITE DATA INTO MEMORY CARD

The data edited with Media Card Imager in the computer can be written in or read from the memory card with the PC or this projector.

The data edited by Media Card Imager is written in Bit Map type (BMP) or JPEG type (JPG).

CARD WRITE WITH PROJECTOR

If your computer doesn't have the PC card write equipment, the data can be written or read by connecting with this projector.

NOTE : This operation can be made only by Media Card Imager in PC.

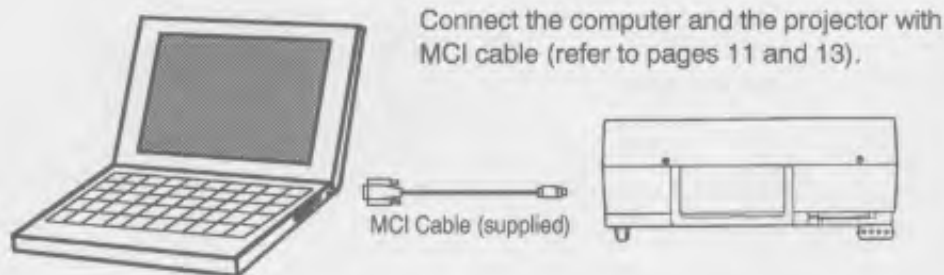

1. Connect the projector with your computer by the MCI cable (supplied).
(Refer to "CONNECTING COMPUTER" on Pages 10 to 14.)
2. Insert the memory card into PC CARD SLOT of the projector.
3. Turn on the LCD Projector and the computer.
4. Press MENU button and select MCI mode.
5. Press POINT LEFT/RIGHT button(s) to select VIEW and press SELECT (REAR CLICK) button. Another dialog box VIEW SETTING DISPLAY will appear.
6. Press POINT DOWN button and a red arrow appear. Move the arrow to Card access by pressing POINT UP/DOWN button. And then press SELECT(REAR CLICK) button. "Ready to access" is displayed.
7. Operate Media Card Imager in PC to write/read the data in the PC card.
Refer to Owner's Manual of Media Card Imager for operation.

NOTE : Connect the projector to the computer with MCI Cable before turning those appliances on.
Do not press any button while read/write the data through MCI Cable. Those operations are canceled and the data in the memory card may be damaged.

MAIN MENU DISPLAY

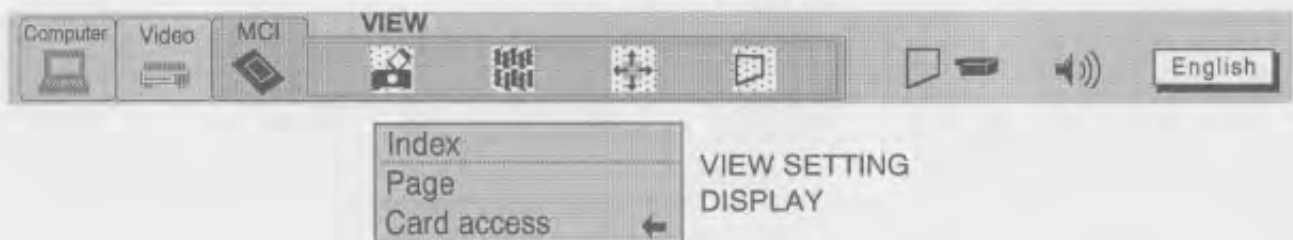

SMARTMEDIA AND PC CARD ADAPTER

SmartMedia and PC Card Adapter are provided with this LCD projector. SmartMedia can be used as a PC card conforming to the PC Card Standard-ATA by combining with PC Card Adapter.

INSTALL/REMOVE SmartMedia

INSTALL

Insert SmartMedia fully into PC Card Adapter. Make sure EJECT button pops out.

NOTE

- The front side of SmartMedia has Contact Area on its surface.
The front side of PC Card Adapter has Eject button on the left side of the slot.
- Do not insert SmartMedia in the reverse. The card and the data can be damaged.

REMOVE

To remove SmartMedia, fully press in the EJECT button. The card pops out, then take out the card.

NOTE

- Do not pull SmartMedia by force. It may damage SmartMedia or PC Card Adapter.

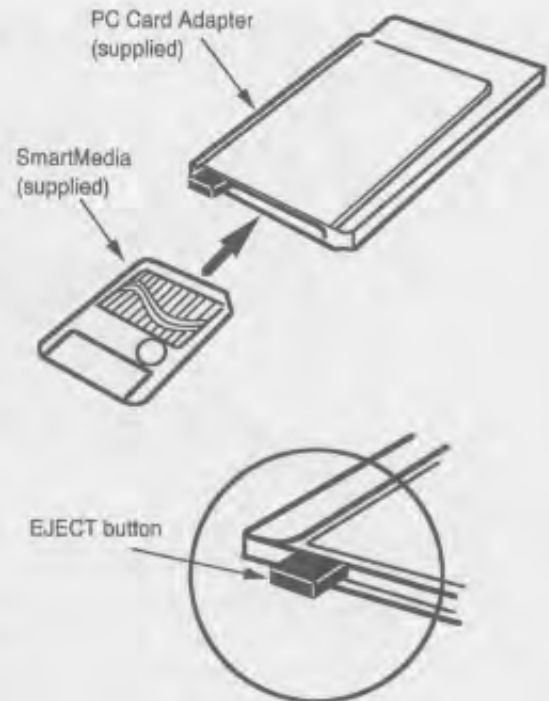

① Contact Area

Data is written in Contact Area. Never scratch or stain this area.

② Write Protect Area

Affix Write Protect Sticker onto Write Protect Area to prevent from accidental erasure.

③ Index Area

Affix Index Label onto Index Area.

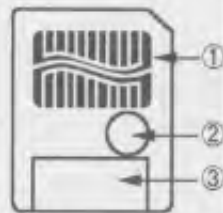

CAUTION

Write Protect Sticker is not available for PC. When PC attempts to read the data from SmartMedia with Write Protect Sticker, it provides the error messages or the control of PC becomes insecure because of the property of the interface. When the error messages are displayed, press any key to return to the normal display. It is recommended, however, SmartMedia should be used on PC without Write Protect Sticker.

IMPORTANT NOTE

THE DATA STORED ON THE MEMORY CARD (SMARTMEDIA OR PC CARD) MAY BE DAMAGED OR LOST BECAUSE OF THE DAMAGE OF THE MEMORY CARD OR THE ACCIDENTAL ERASURE. IT IS RECOMMENDED THAT ANY IMPORTANT DATA SHOULD BE COPIED ONTO SEPARATE MEDIA, SUCH AS A FLOPPY DISK, A HARD DISK, OR A MO DISK. WE SHALL NOT BE LIABLE FOR ANY DAMAGE OR LOSS OF PROFITS ARISING FROM THE LOSS OF DATA BECAUSE OF THE ACCIDENTAL OPERATION AND THE DAMAGE OF A MEMORY CARD OR APPLIANCES. REFER TO OWNER'S MANUAL OF MEDIA CARD IMAGER FOR OPERATING THE SOFTWARE.

PRECAUTIONS AND SPECIFICATIONS

SmartMedia

- SmartMedia is a precision device. Do not bend it, drop it, subject it to strong forces or shocks or place where strong static electrical charge can be generated.
- Do not touch the surface of the Contact Area with fingers or allow it to be stained with foreign materials. Store SmartMedia inside its protective case when it is not used.
- SmartMedia is a consumable item. The data may not be written in or read from SmartMedia by using for a long time. In that case, replace SmartMedia with new one.

Memory capacity : 4MB

Operating voltage : 3.3 V DC

Usage environment

Temperature : 0~55 °C (during use)
-20~65 °C (during storage)

Humidity : less than 95%
(during use, during storage)

PC Card Adapter

- Do not bend it, drop it, subject it to strong forces or shocks or place where strong static electrical charge can be generated.
- Do not insert materials other than SmartMedia. The adapter may be damaged. Store PC Card Adapter inside its protective case when it is not used.
- Do not shake the adapter, turn off the appliances, or remove SmartMedia from the PC Card Adapter during writing or reading data. It may damage the data in SmartMedia.

Operating voltage : 5 V DC

Usage environment

Temperature : 0~55 °C (during use)
-20~65 °C (during storage)

Humidity : less than 95%
(during use, during storage)

This adapter can be adapted to only our SmartMedia indicated below.

Available SmartMedia

: 3.3V / 5V, 2MB / 4MB / 8MB / 16MB

PICTURE IMAGE ADJUSTMENT (MCI MODE)

Picture adjustments have been reset at the factory. If you want to change the setting, operate the projector as follows.

1. Press MENU button and MAIN MENU DISPLAY dialog box will appear.
2. Press POINT LEFT/RIGHT button(s) to select IMAGE and press SELECT (REAR CLICK) button. Another dialog box IMAGE ADJUST DISPLAY will appear. This shows the current picture settings.
3. In this dialog box, you can adjust the settings by increasing or decreasing the levels shown as numbers. The items and the range of the levels that you can adjust are summarized in the table as below.
4. Press POINT DOWN button and a red arrow will appear.
5. Move the arrow to an item that you want to adjust by pressing POINT UP/DOWN button(s).
6. To increase the level, point the arrow to ▲ and then press SELECT (REAR CLICK) button. To decrease the level, point the arrow to ▼ and then press SELECT (REAR CLICK) button.
7. You may want to store the settings in the memory so that you can recall them later. To store the settings, move the arrow to Stored and then press SELECT (REAR CLICK) button. When you have stored the settings, "OK ?" is displayed for confirmation.
8. Move the arrow to Yes and then press SELECT (REAR CLICK) button. The stored settings are permanently held even if POWER ON/OFF is switched off.
9. To quit Picture Image Adjustment Menu, move the arrow to Quit and then press SELECT (REAR CLICK) button.
10. If you do not want to store the settings, move the arrow to Quit and then press SELECT (REAR CLICK) button. The settings changed remains effective until POWER ON/OFF switch is turned off.
11. To recall the settings from the memory that you have stored, move the arrow to Reset and then press SELECT (REAR CLICK) button. When you have reset the settings, "OK ?" is displayed for confirmation. Move the arrow to Yes and then press SELECT (REAR CLICK) button. You can adjust the settings again if needed.

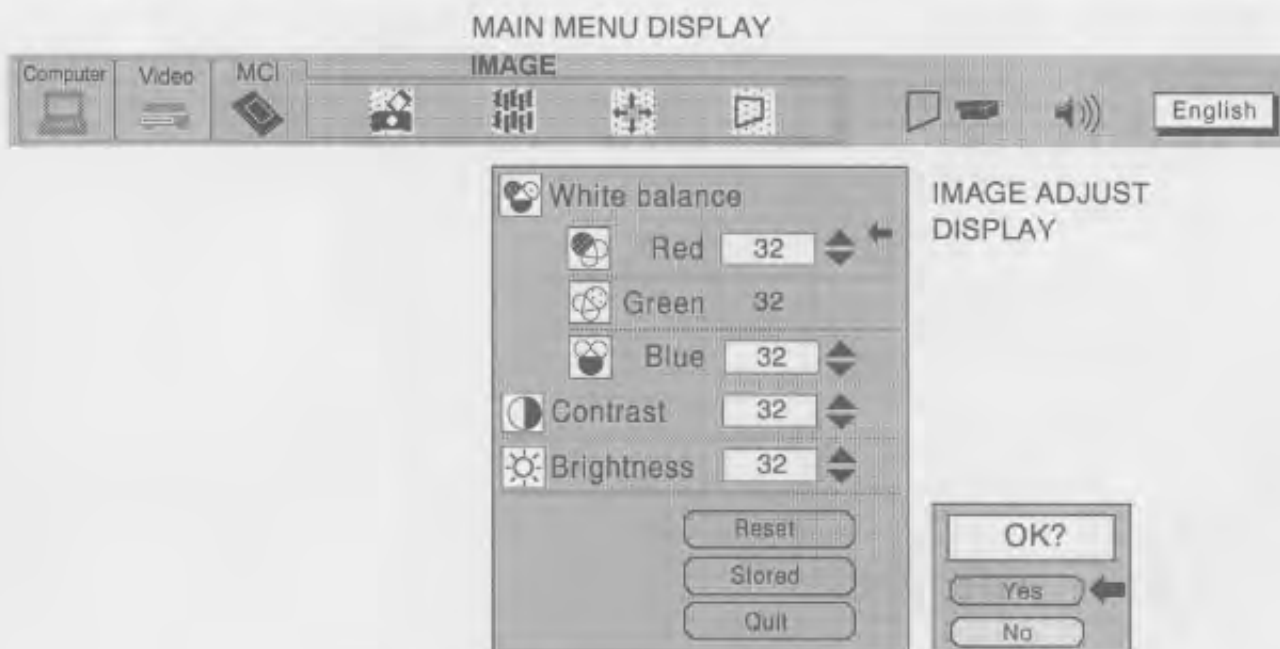

TABLE OF PICTURE IMAGE ADJUSTMENT

| | | | | | |
|----------------------|----------|---|---|----|----------|
| WHITE BALANCE (RED) | DECREASE | 0 | ↔ | 63 | INCREASE |
| WHITE BALANCE (BLUE) | DECREASE | 0 | ↔ | 63 | INCREASE |
| CONTRAST | LIGHTER | 0 | ↔ | 63 | DEEPER |
| BRIGHTNESS | DARKER | 0 | ↔ | 63 | BRIGHTER |

AIR FILTER CARE AND CLEANING

The removable air filter prevents dust from accumulating on the surface of the projection lens and the projection mirror. Should the air filter become clogged with dust particles, it will reduce the cooling fan's effectiveness and may result in internal heat build up and shorten the life of the projector.

We recommend to clean the air filter following the procedures below:

1. Turn the POWER ON/OFF button OFF, and disconnect the AC power cord from the AC outlet.
2. Remove the air filter cover.
Press the cover latch sideways and lift the cover.
3. Remove the air filter from the filter cover.
4. Clean the air filter with a vacuum cleaner.
5. Replace the air filter. Make sure that air filter cover is fully inserted.



CAUTION

Do not operate the projector with air filter removed.

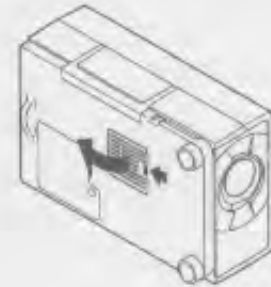

RECOMMENDATION

We recommend to avoid dusty/smoky place for operating the projector. Using in dusty place may cause the picture of poor quality.

When using under the dusty or smoky conditions, dust may accumulate on the liquid crystal panel and lens inside it, and may resultantly be projected on the screen together with the picture.

When the above symptoms are noticed contact your authorized dealer or service station for the cleaning.

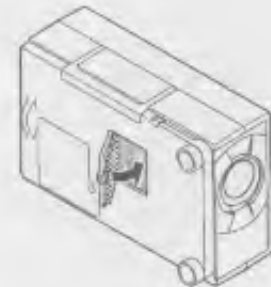

TEMPERATURE WARNING INDICATOR

TEMPERATURE WARNING INDICATOR flashes red when the internal temperature of the projector exceeds the normal temperature. Possible causes for the temperature warning may be:

1. Ventilation slots of the projector are blocked. In such an event, reposition the projector so that ventilation slots are not obstructed.
2. Air filter is clogged with dust particles. Remove dust from the air filter by following instructions in the Air Filter Care and Cleaning section above.

If the TEMPERATURE WARNING INDICATOR still continues to flash after checking (1) and (2), call your authorized dealer or service station.

TEMPERATURE
WARNING
INDICATOR

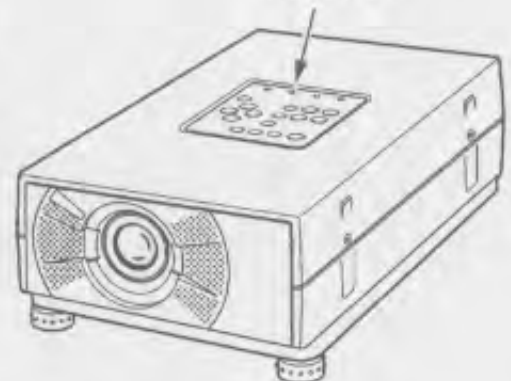

LAMP REPLACEMENT

If the lamp fails to come on and LAMP REPLACEMENT INDICATOR on the projector is yellow, you may need to replace the lamp.



- For continued safety, replace with a lamp assembly of the same type.
- Allow the projector to cool for at least 45 minutes before you open the lamp cover. The inside of the projector can become very hot.
- Do not drop the lamp module or touch the glass bulb! The glass can shatter and cause injury.

Follow these steps to replace the lamp assembly.

1. Turn off the projector and allow the projector to cool thoroughly.
2. Disconnect the AC cord from the AC outlet.
3. Remove a screw with a screwdriver and remove the lamp cover.
4. Remove 2 screws with a screwdriver and pull out the lamp assembly by grasping the handle.
5. Replace the lamp assembly.
6. Tighten 3 screws to secure the lamp assembly and the lamp cover.
7. Connect the detachable AC cord to the projector.
8. Reset LAMP REPLACEMENT MONITOR TIMER. (See "LAMP AGE" section on page 45.)

LAMP REPLACEMENT INDICATOR

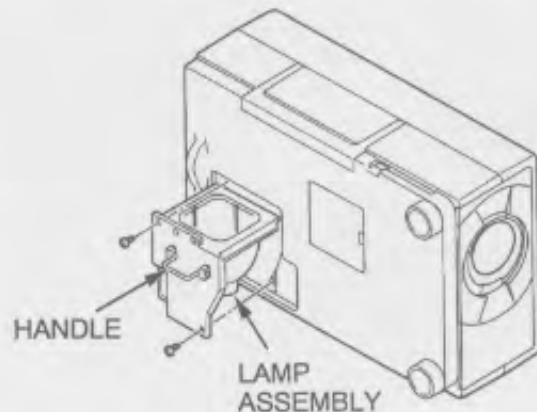
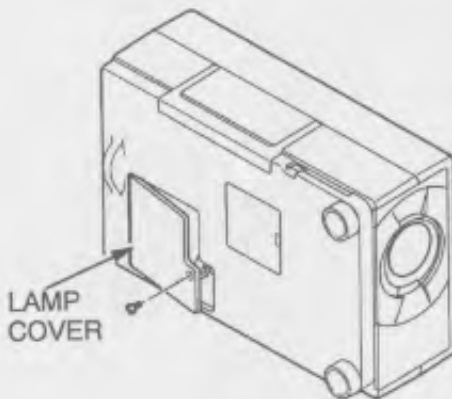
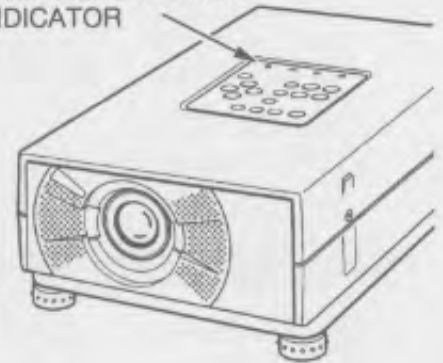

NOTE: Do not reset the LAMP REPLACEMENT MONITOR TIMER, when the lamp is not replaced.

CLEANING THE LENS

Follow these steps to clean the projection lens:

1. Apply a non-abrasive camera lens cleaner to a soft, dry cleaning cloth.
Avoid using an excessive amount of cleaner.
Abrasive cleaners, solvents or other harsh chemicals might scratch the lens.
2. Lightly wipe the cleaning cloth over the lens.
3. When you don't use the projector, replace the lens cover.

TROUBLESHOOTING

Before calling your dealer or service station for assistance, follow these steps, in this order, to make sure everything is properly connected.

1. Make sure you have connected the projector to your equipment as described in section "CONNECTING THE PROJECTOR" on pages 10 ~ 15.
2. Check cable connections. Verify that all computer, video and power cord are properly connected.
3. Verify that all power is switched on.
4. If the projector still does not display an image, restart the computer.
5. If the image still does not display, unplug the projector from the computer and check the computer monitor's display. The problem may be with your graphics controller rather than with the projector. (When you reconnect the projector, remember to turn the computer and monitor off before you power up the projector. Power the equipment back up in order of: Projector, monitor, and computer)
6. If the problem still exists, check with following chart.

| Problem: | Try these Solutions: |
|-------------------------------------|---|
| <p>No power</p> | <ul style="list-style-type: none"> ● Plug the projector into an AC outlet. ● Press POWER ON/OFF switch to ON. ● Be sure READY INDICATOR light is ON. ● Wait one minute after the projector is turned OFF before turning the projector back on. <p>NOTE: After pressing POWER ON/OFF button to OFF . The projector functions as follows.</p> <ol style="list-style-type: none"> 1. The LAMP indicator will light and the READY indicator will turn off. 2. After one minute, READY indicator will light green again and the projector may be turned on by pressing POWER ON/OFF button. <ul style="list-style-type: none"> ● Check TEMPERATURE WARNING indicator. If the indicator flashes red, the projector cannot be turned on. (See BASIC OPERATION on page 26). ● Check the projection lamp. |
| <p>Image is out of focus</p> | <ul style="list-style-type: none"> ● Adjust the focus. ● Make sure the projection screen is at least 3.6 feet (1.1 m) from the projector. ● Check the projection lens to see if it needs cleaning. <p>NOTE: Moving the projector from a cool temperature location to a warm temperature location may result in moisture condensation on the lens. In such an event, leave the projector OFF and wait until condensation disappears.</p> |

| Problem: | Try these Solutions: |
|---|---|
| Picture is L/R Reversed. | Check Ceiling/Rear feature. (See "OTHER FUNCTION SETTING" section on pages 43 ~ 44). |
| Picture is T/B inverted. | Check Ceiling feature. (See "OTHER FUNCTION SETTING" section on pages 43 ~ 44). |
| Some displays are not seen during operation. | Check Display feature. (See "OTHER FUNCTION SETTING" section on pages 43 ~ 44). |
| No sound. | <ul style="list-style-type: none"> ● Check audio cable connection from audio input source. ● Adjust audio source. ● Press VOLUME (+) button. ● Press MUTE button. |
| Remote control unit doesn't work. | <ul style="list-style-type: none"> ● Check the batteries. ● Make sure nothing is blocking between the remote control sensor and remote control unit. ● Make sure you are not too far from the projector when using the remote control unit. Maximum operate range is 16.4 feet (5 m). |
| Wireless mouse function does not work. | <ul style="list-style-type: none"> ● Check the cable connection between the projector and the computer. ● Check the mouse setting on your computer. ● Turn on the projector before you turn on the computer. |
| The image data in PC card isn't displayed | <ul style="list-style-type: none"> ● Check PC card is inserted properly into PC CARD SLOT. ● Check SmartMedia or PC Card Adapter is set properly. ● Check MCI mode is selected. ● Check the image data is recorded in PC Card properly. ● Start the projector again. |
| The image data can't be written in, read from PC card or SmartMedia with the projector. | <ul style="list-style-type: none"> ● Check the projector is turned on. ● Check Card access in VIEW mode is selected. ● Check MCI Cable is connected properly. ● Check PC Card or SmartMedia and PC Card Adapter is inserted into PC CARD SLOT properly. ● Check Media Card Imager is installed in the computer properly. ● Check the setting in Media Card Imager, like Serial Port setting, is set properly. |

TECHNICAL SPECIFICATIONS

SPECIFICATIONS

| | |
|----------------------------------|---|
| Projector Type | Multi-media Projector |
| Dimensions (W x H x D) | 215 mm × 109mm × 315 mm |
| Net Weight | 3.9 kg |
| LCD Panel System | 0.9" TFT Active Matrix type × 3 |
| Panel Resolution | 804 × 604 dots |
| Number of Pixels | 1,456,848 (485,616 × 3) |
| Color System | PAL, SECAM, NTSC and NTSC4.43 |
| Scanning Frequency | H-sync. 15 ~ 80 KHz, V-sync. 50 ~ 100 Hz |
| Projection Image Size (Diagonal) | Adjustable from 18" to 300" |
| Contrast Ratio | 250 :1 |
| Horizontal Resolution | 750 TV lines |
| Projection Lens | F2.3 ~ 3.0 lens with f36mm ~ 57.6mm Motor zoom and focus |
| Throw Distance | 3.6' (1.1 m) ~ 37.7' (11.5 m) |
| Projection Lamp | UHP, 120 watt type |
| Projection Mirror | Diachronic mirror and X-prism system |
| Key Stone Correction | 10 : 0.5 |
| AV Input Jacks | PHONO Type × 1 (Video, Audio R and L) and DIN 4 pin (S-Video) × 1 |
| Computer Input Jack | (VGA) HDB15 Terminal × 1 |
| Control Port Jack | Multi-pole 12 pin (Control port) × 1 |
| MCI Serial Port | Serial Port DIN 8 pin |
| Monitor Output Jack | (VGA) HDB15 Terminal × 1 |
| Computer Audio Input Jack | Mini Jack (stereo) |
| Internal Audio Amp | 1W RMS (MONO) |
| Audio Out Jacks | Mini Jack (stereo) |
| Built-in Speaker | 4 × 3 cm × 1 (Monaural) |
| Feet Adjustment | 0 to 2° degree |
| Voltage | 100 ~ 120V AC, 50/60 Hz |
| Power Consumption | 2.0A (Max. Ampere) |
| Operating Temperature | 5°C ~ 35°C |
| Storage Temperature | - 10°C ~ 60°C |
| Remote Control Battery | (2) AA Type |
| Accessories | AC power cord, remote control transmitter and batteries, VGA cable, VGA/MAC adapter, mouse cables (for PS/2 port × 1, for serial port × 1, for ADB port), MCI cable (RS-232C), Media Card Imager for Windows 95 (CD-ROM), SmartMedia, PC Card Adapter, lens cover, Carrying Bag |



This symbol on the nameplate means the product is Listed by Underwriters Laboratories Inc. It is designed and manufactured to meet rigid U.L. safety standards against risk of fire, casualty and electrical hazards.

EIKI

Audio Visual/Video Products

EIKI INTERNATIONAL, INC.

26794 Vista Terrace Drive, Lake Forest, CA. 92630-8113
TEL (714) 457-0200 FAX (714) 457-7878

IN CANADA, EIKI CANADA

865 Heritage Drive P.O. Box 156
Midland Ontario L4R 4K8 Canada
TEL (705) 527-4084 FAX (705) 527-4087

Printed in Japan

Part No. 610 273 3594 (1AA6P1P1519-- M6RB)

© 1998 Eiki International, Inc.