

myprojectorlamps.com

**The most trusted, dependable name
in projector lamp sales.**



<http://www.myprojectorlamps.com>



<http://www.myprojectorlamps.ca>



<http://www.myprojectorlamps.eu>

The following projector manual has not been modified or altered in any way.

EIKI

MULTIMEDIA PROJECTOR

MODEL **EIP-X350**

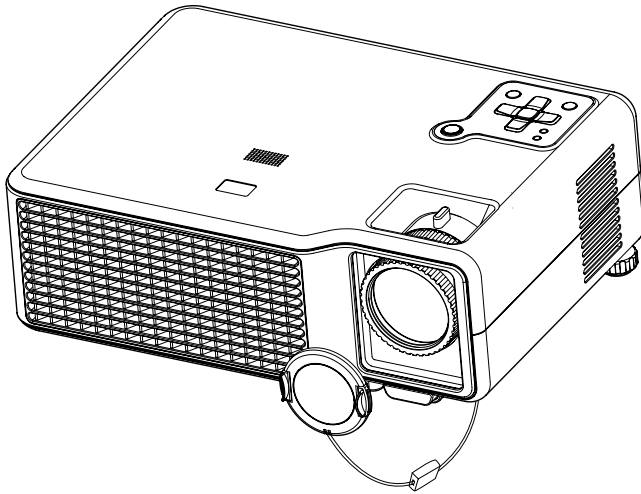

OWNER'S MANUAL

Federal Communication Commission Notice

Note : This equipment has been tested and found to comply with the limits for a Class B digital device, pursuant to part 15 of the FCC Rules.

These limits are designed to provide reasonable protection against harmful interference in a residential installation. This equipment generates, uses and can radiate radio frequency energy and, if not installed and used in accordance with the instructions, may cause harmful interference to radio communications. However, there is no guarantee that interference will not occur in a particular installation. If this equipment does cause harmful interference to radio or television reception, which can be determined by turning the equipment off and on, the user is encouraged to try to correct the interference by one or more of the following measures :

- Reorient or relocate the receiving antenna.
- Increase the separation between the equipment and receiver.
- Connect the equipment into an outlet on a circuit different from that to which the receiver is connected.
- Consult the dealer or an experienced radio/TV technician for help.

Use of shielded cable is required to comply with class B limits in Subpart B of Part 15 of FCC Rules.

Do not make any changes or modifications to the equipment unless otherwise specified in the instructions. If such changes or modifications should be made, you could be required to stop operation of the equipment.

Model Number : EIP-X350

Trade Name : EIKI





Responsible party : EIKI International, Inc.

Address : 30251 Esperanza Rancho Santa Margarita CA 92688-2132

Telephone No. : 800-242-3454 (949-457-0200)

Safety Instructions

Read all of these instructions before you operate your projector and save for future reference.

	CAUTION RISK OF ELECTRIC SHOCK DO NOT OPEN	
CAUTION : TO REDUCE THE RISK OF ELECTRIC SHOCK, DO NOT REMOVE COVER (OR BACK). NO USER-SERVICEABLE PARTS INSIDE EXCEPT LAMP REPLACEMENT. REFER SERVICING TO QUALIFIED SERVICE PERSONNEL.		
	THIS SYMBOL INDICATES THAT DANGEROUS VOLTAGE CONSTITUTING A RISK OF ELECTRIC SHOCK IS PRESENT WITHIN THIS UNIT.	
	THIS SYMBOL INDICATES THAT THERE ARE IMPORTANT OPERATING AND MAINTENANCE INSTRUCTIONS IN THE OWNER'S MANUAL WITH THIS UNIT.	

Allowing the proper amount of space on the top, sides, and rear of the projector cabinet is critical for proper air circulation and cooling of the unit. The dimension shown here indicate the minimum space required. If the projector is to be built into a compartment or similarly enclosed, these minimum distances must be maintained.

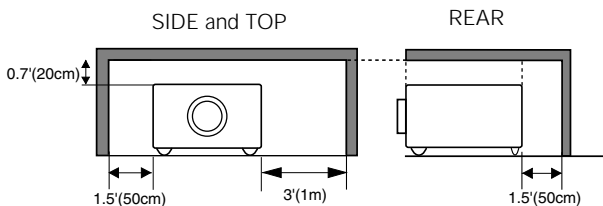

An appliance and cart combination should be moved with care. Quick stops, excessive force, and uneven surfaces may cause the appliance and cart combination to overturn.



1. Check that the operating voltage of your unit is identical with the voltage of your local power supply.

2. Should any liquid or solid object fall into the cabinet, unplug the unit and have it checked by the qualified personnel before operating it further.

3. Do not attempt to service this product yourself, as opening or removing covers may damage the components inside and will void your warranty.

4. Do not place this product on an unstable cart, stand, or table. The product may fall, causing serious damage to the product.

5. Unplug the unit from the wall socket if it is not to be used for several days. To disconnect the cord, pull it out by the plug. Never pull the cord itself.

6. The wall socket should be near the unit and easily accessible.

7. Do not place the projector where the cord can be stepped on as this may result in fraying or damage to the lead or the plug. Be alert to tripping hazards.

8. Never look into the projector lens when the lamp is switched on as the bright light can damage your eyes. Never let children look into the lens when it is on.

9. Do not place your hand or objects near the ventilation holes. The air coming out is hot.

10. Never open any covers on the projector except the lamp cover. Dangerous electrical voltages inside the projector can cause severe injury. Except as specifically directed in this User's Manual, do not attempt to service this product yourself. Refer all servicing to qualified service personnel.

11. Unplug the projector from the wall socket before cleaning. Use a damp cloth for cleaning the projector housing. Do not use liquid or aerosol cleaners.

12. Keep the plastic packing materials (from the projector, accessories and optional parts) out of the reach of children as these bags may result in death by suffocation. Be particularly careful around the small children.

13. For ventilation reasons, the fan continues to operate after the projector has been powered off. Please do not unplug the power cord until the fan stops.

14. The projector is equipped with ventilation holes (intake) and ventilation holes (exhaust). Do not block or place anything near these slots, or internal heat build-up may occur, causing picture degradation or damage to the projector.

15. When you replace the projector lamp, never touch the new bulb with your bare hands. The invisible residue left by the oil on your hands may shorten the bulb life. Use lint-free gloves or finger cots are recommended.

16. The product should be situated away from heat sources such as radiators, heat registers, stoves, or other products (including amplifiers) that produce heat.
-
17. Do not overload wall outlets, extension cords, or integral convenience receptacles as this can result in a risk of fire or electric shock.
-

NOTE: *This symbol mark and recycle system are applied only to EU countries and not applied to the countries in the other area of the world.*



Your EIKI product is designed and manufactured with high quality materials and components which can be recycled and reused.

This symbol means that electrical and electronic equipment, at their end-of-life, should be disposed of separately from your household waste.

Please dispose of this equipment at your local community waste collection/recycling centre.

In the European Union there are separate collection systems for used electrical and electronic products.

Please help us to conserve the environment we live in!



Voor de klanten in Nederland

Bij dit produkt zijn batterijen geleverd.

Wanneer deze leeg zijn, moet u ze niet weggooien maar inleveren als KCA.



CONTENTS

Introduction	6
Projector Features	6
Package Contents	7
Projector Overview	8
Using the Product	10
Control Panel	10
Terminals	11
Remote Control	12
Installing the Batteries	13
Notes on AC Power Cord	14
Remote Control Operation	15
Installation	16
Connecting the Projector	16
Powering On/Off the Projector	17
Adjusting the Projector	18
Menu Operation	21
Setup Menu	22
Picture Menu	23
Source Menu	25
Help Menu	25
Maintenance	26
Cleaning the Lens	26
Cleaning the Projector Housing	26
Replacing the Lamp	27
Specifications	29
Appendix	30
LED Indicator Messages	30
Compatibility Modes	31
Troubleshooting	32

Introduction

Projector Features

The projector integrates high-performance optical engine projection and a user-friendly design to deliver high reliability and ease of use.

The projector offers the following features:

- Single chip 0.7" Texas Instruments DLP® technology
- XGA (1024 x 768 pixels) real resolution
- Auto image re-sizing (Auto-Sync.) to 1024 x 768 full screen with scaling compression compatibility for VGA, SVGA, XGA and SXGA*
- Compatibility with Macintosh® computers
- Compatibility with NTSC, PAL, SECAM, and HDTV
- Multi-function remote control
- D-Sub 15-pin terminal for analog video connectivity
- User-friendly, multi-language on-screen display (OSD)
- Advanced electronic keystone correction



* *means compressed.*

Package Contents

When you unpack the projector, make sure you have all these components:

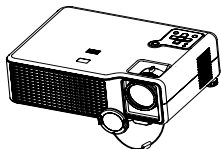

Projector with Lens Cap

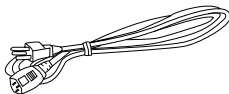

AC Power Cord

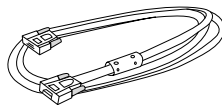

VGA Cable (D-SUB to D-SUB)



Composite Video Cable



S-Video Cable



Audio Cable

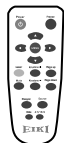

Remote Control (IR)



AAA size batteries for remote control



Projector Carrying Case

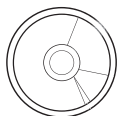

Owner's Manual



Quick Start Guide



- *Save the original shipping carton and packing material; they will come in handy if you ever to ship your unit. For maximum protection, repack your unit as it was originally packed at the factory.*

Projector Overview

Front View

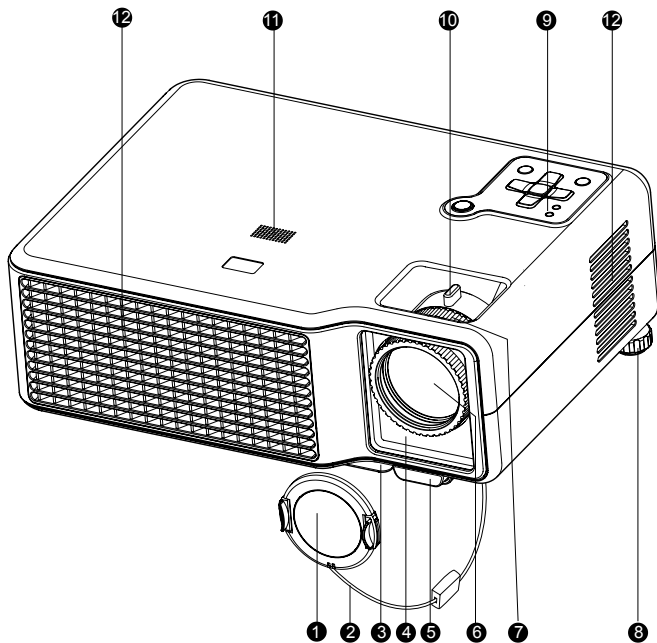

- ① Lens cap
- ② Lens cap strap
- ③ Elevator foot
- ④ Front IR remote control sensor
- ⑤ Elevator button

- ⑥ Projection lens
- ⑦ Focus ring
- ⑧ Tilt-adjustment foot
- ⑨ Control panel
- ⑩ Zoom ring
- ⑪ Speaker
- ⑫ Ventilation holes

Rear View

- 1 Rear IR remote control sensor
- 2 Terminals
- 3 Main power switch
- 4 AC power socket
- 5 Tilt-adjustment foot
- 6 Ventilation holes
- 7 Kensington lock

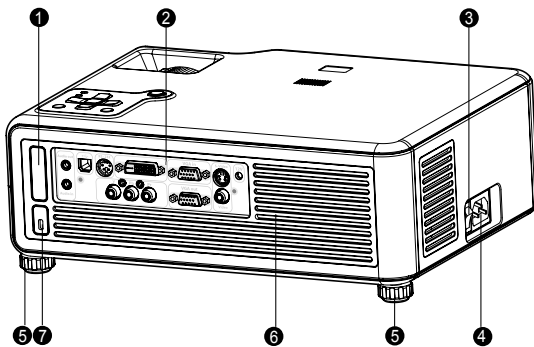

Bottom View

- 1 Lamp cover
- 2 Ceiling mount

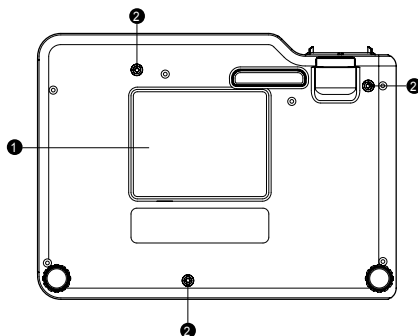

- This projector can be used with a ceiling mount for support. The ceiling mount is not included in the package.

Using the Product

Control Panel

LED

- ① **Temp.** (Temperature LED indicator)
Refer to “LED Indicator Messages”. (p.30)
- ② **Lamp.** (Lamp LED indicator)
Refer to “LED Indicator Messages”. (p.30)
- ③ **⏻** (Power LED indicator)
Refer to “LED Indicator Messages”. (p.30)

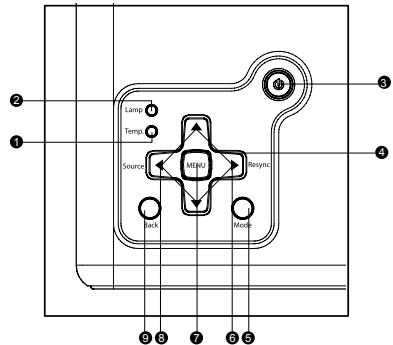

Button Function

- ③ **⏻ Power**
Turns the projector on or off. (p.17)
- ④ **Four directional buttons**
Use four directional buttons to select items or make adjustments to your selection. (p.21)
- ⑤ **Mode**
Selects the picture mode (p.24) picture and color combination can be customized in custom mode.
- ⑥ **Resync ▶**
Resynchronizes the projector to the input signal from a computer.
- ⑦ **MENU**
Opens the on-screen menu or acts on the selected menu item. (p. 21, 22-25)
- ⑧ **Source ◀**
Manually selects an input source. (p. 17, 25, 32)
- ⑨ **Back**
Exits the on-screen menu, or re-enters the on-screen menu at the most recently used item. (p. 21)

Terminals

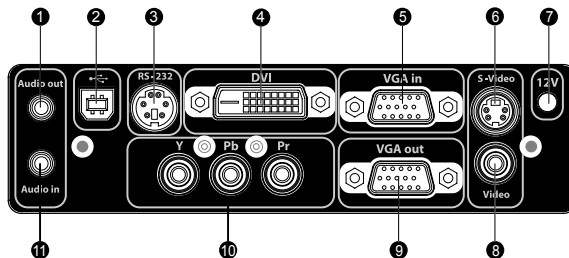

- 1 Audio out**
Connects to a speaker or other audio input equipment.

- 2 USB**
This connector is for page up & down mouse control function and firmware update.

- 3 RS-232**
When operating the projector via a computer, connect this to the controlling computer's RS-232C port.

- 4 DVI**
Connects a DVI-D digital source.

- 5 VGA in**
Connects image input signal (analog) to this jack.

- 6 S-Video**
Connects S-Video output from video from video equipment to this jack.

- 7 12-Vdc trigger output**
Controls a motorized screen or similar accessory device.

- 8 Video**
Connects composite video output from video equipment to this jack.

- 9 VGA out**
Connects to a computer display, etc.

- 10 YPbPr**
Connects YPbPr output from video equipment to this jack.

- 11 Audio in**
Connects an audio output from video equipment to this jack.

Remote Control

- 1 Power**
Turns the projector on or off. (p.17)
- 2 Four directional buttons**
Use four directional buttons to select items or make adjustments to your selection. (p.21)
- 3 MENU**
Opens the on-screen menu or acts on the selected menu item. (p.21)
- 4 Laser**
Press and hold this button to activate the laser pointer.
- 5 Mute**
Cuts off the sound temporarily. Press again to cancel the Mute function. (p.22)
- 6 Resync**
Automatically adjusts frequency and parameters. This function is available for computer mode only. (p.10, 23, 33)
- 7 Hide**
Hides the screen and mutes the sound. Press again to cancel the Hide function. (p.22)
- 8 4:3/16:9**
Press the 4:3/16:9 to switch the image aspect ratio from 4:3 to 16:9.
- 9 Source**
Manually selects an input source. (p.17, 25, 32)
- 10 Keystone + / -**
Adjusts image distortion caused by tilting the projector. (p.22)
- 11 Page down** (Computer mode only)
Use this button to page down. This function is only available when the projector is connected to a computer via an USB cable.
- 12 Page up** (Computer mode only)
Use this button to page up. This function is only available when the projector is connected to a computer via an USB cable.
- 13 Freeze**
Press "Freeze" to pause the screen image. Press again to cancel the Freeze function.

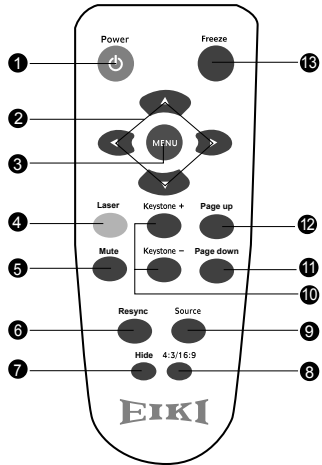

Installing the Batteries

1. Open the battery cover in the direction shown.

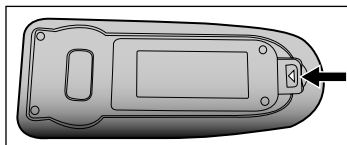

2. Install batteries as indicated by the diagram inside the compartment.

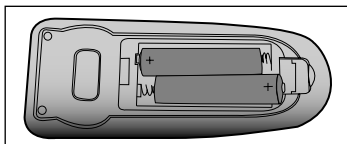

3. Close the battery cover into position.

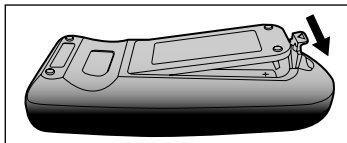

NOTE

- *Keep the batteries out of the reach of children. There is a danger of death by accidentally swallowing the battery.*
- *Remove batteries from remote control when not using for extended periods.*
- *Do not dispose of the used battery along with household waste. Dispose of used batteries according to local regulations.*
- *Danger of explosion may happen if batteries are incorrectly replaced. Replace all the batteries with new ones.*

Notes on AC Power Cord

AC Power Cord must meet requirement of country where you use a projector. Confirm an AC plug type with graphics below and proper AC Power Cord must be used. If supplied AC Power Cord does not match your AC outlet, contact your sales dealer. This projector is equipped with a grounding type AC line plug. Make sure that your outlet fits the plug. Do not defeat the safety purpose of this grounding type plug. We highly recommend using a video source device also equipped with a grounding type AC line plug to prevent from signal interference due to voltage fluctuation.

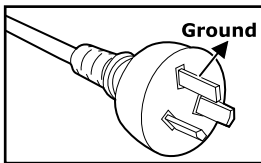

For Australia and
Mainland China

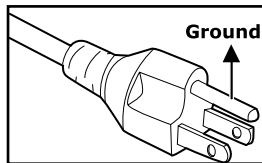

For the U.S.A. and Canada

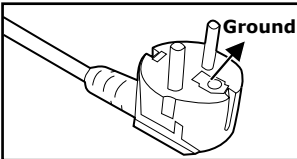

For Continental Europe

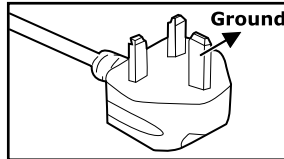

For the U.K.

Remote Control Operation

Point the remote control at the infrared remote sensor and press a button.

■ Operating the projector from the front

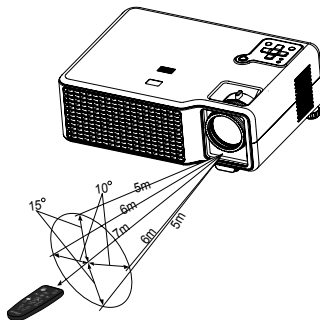

■ Operating the projector from the rear

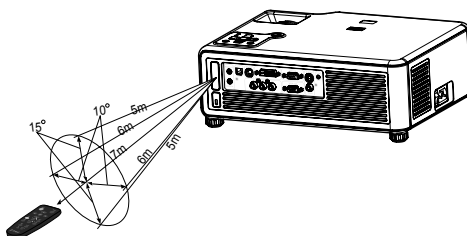

- Do not point the laser pointer directly to the people's eyes (especially small children). There is a danger of injury to the eyes.
- The remote control may not operate when there is sunlight or other strong light such as a fluorescent lamp shining on the remote sensor.
- Operate the remote control from a position where the remote sensor is visible.
- Do not drop the remote control or jolt it.
- Keep the remote control out of locations with excessively high temperature or humidity.
- Do not get water on the remote control or place wet objects on it.
- Do not disassemble the remote control.

Installation

Connecting the Projector

- ❶ USB Cable
- ❷ RS-232 Cable
- ❸ DVI Cable
- ❹ VGA Cable (D-Sub to D-Sub)
- ❺ S-Video Cable
- ❻ Composite Video Cable
- ❼ VGA (D-Sub) to HDTV (RCA) Cable
- ❽ YPbPr Cable
- ❾ Audio Cable

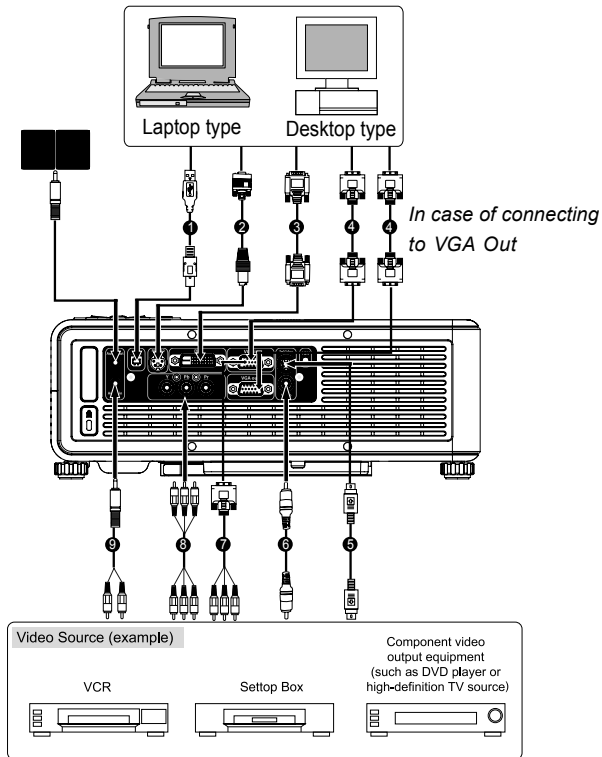

- When connecting cable, power cords of both a projector and external equipment should be disconnected from AC outlet.
- The figure above is a sample connection. This does not mean that all of these devices can or must be connected simultaneously.
- The cables that come with the projector may differ from the above illustration. The included cables are based on actual shipment delivery.

Powering On/Off the Projector



Powering on the projector:

1. Remove the projector lens cap.
2. Complete the AC power cord and peripheral signal cable(s) connections.
3. Turn on the main power switch.
4. The power LED indicator blinks blue in standby mode.
5. Press  button on the control panel or remote control. The power LED indicator lights on blue and fans start to turn on the projector.
6. Turn on your source (computer, notebook, DVD, etc.). The projector automatically detects your source.
 - If you are connecting multiple sources to the projector simultaneously, press **Source** button.

Warning:

- Remove the lens cap first before powering on.
- Never look into the lens when the lamp is on. This can damage your eyes. It is especially important that children are not allowed to look into the lens.

Powering Off the Projector:

1. Press  button on the control panel or remote control and warning message of shutting down appears on the screen.
2. Press the  button again to turn off the projector. The power LED indicator turns off and the cooling fans are operating about 120 seconds.
3. When the projector has cooled down enough to be turned on again, the power LED indicator blinks blue.
 - Do not disconnect power cord or turn off the main power switch until the projector has cooled down (the fan stops) and the power button stops blinking. Otherwise, you might shorten the life of the lamp.
 - The projector cannot be turned on during the cooling down period (the fans are operating).
4. Turn off the main power switch and then you can disconnect the AC power cord.
 - To maintain the life of lamp, once you turn projector on, wait at least 5 minutes before turning it off.

Adjusting the Projector

Adjusting the Projector Height

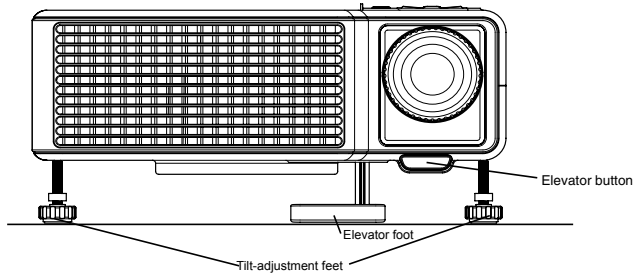

The projector is equipped with an elevator foot and tilt-adjustment feet to adjust the image height.

1. To raise or lower the image, press the elevator button and raise or lower the front of the projector. Release the button to lock the adjustment.
2. To level the image on the screen, turn the tilt-adjustment feet to fine-tune the height.



- *To avoid damaging the projector, make sure that the elevator foot and tilt-adjustment feet are fully retracted before placing the projector in its carrying case.*

Adjusting the Projector Zoom and Focus

1. Focus the image by rotating the focus ring.
A still image is recommended for focusing.
2. Adjust the image by rotating the zoom ring.
Rotate to the right to enlarge the image.
Rotate to the left to reduce the image.

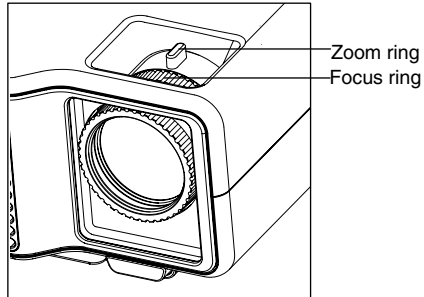

Adjusting Projection Image Size

Refer to the table below to determine the screen size and projection distance. (Tolerance: 10%)

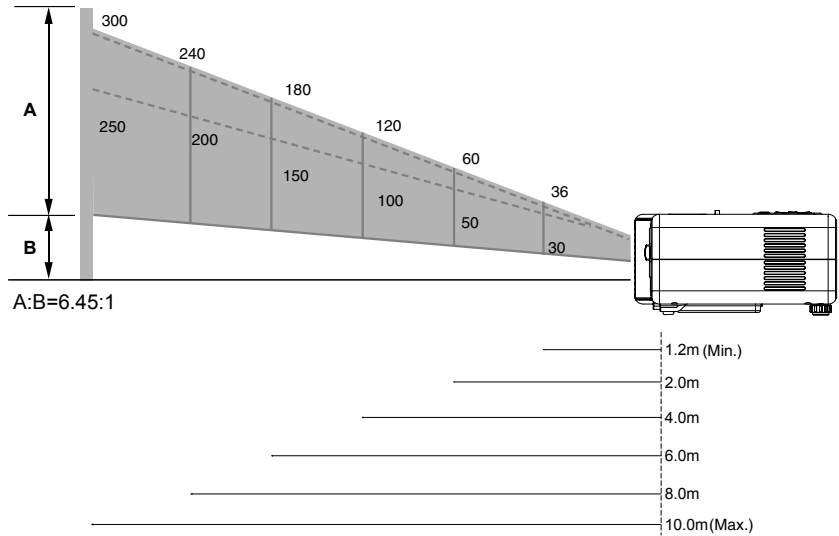

PROJECTION DISTANCE (METER)		1.2	2.0	4.0	6.0	8.0	10.0
4:3 SCREEN SIZE-	Wide	36	60	120	180	240	300
	Tele	30	50	100	150	200	250



- Position the projector in a horizontal position; other positions can cause heat build-up and damage to the projector.
- Make sure the heat ventilation holes are not blocked.
- Do not use the projector in a smoky environment. Smoke residue may cause buildup on critical parts.

Menu Operation

The projector has multilingual on-screen display menus that allow you to make image adjustments and change a variety of settings.

How to operate

1. Press **MENU** to display the on-screen menu.
2. Press **▲** / **▼** to select any feature in the main menu, then press **▶** to move into that menu.
3. Press **▲** / **▼** to select a setting, then press **MENU** to begin adjusting the setting.
4. Press **◀** / **▶** / **▲** / **▼** to adjust the setting, as prompted.
5. Press **MENU** to return to the menu.
6. To go to a different menu, press **◀** and select a menu.
7. To close the on-screen menu, press **Back** button.
 - If you do nothing for a period of time, the on-screen menu closes. To change the amount of time until the on-screen menu closes, press **MENU** and select **Setup > Timeout for menu**.
 - To exit from any on-screen menu or adjustment, press **Back**.

Setup Menu

Keystone

Adjusts image distortion caused by tilting projection.

Reset keystone

Resets the keystone correction to zero (no correction).

Volume

Adjusts the loudness of the projector's audio.

Mute

Temporarily turns off the projector's audio.

Projector position

Adjusts the picture to match the orientation of the projector: upright or upside-down, in front of or behind the screen. Inverts or reverses the image accordingly.

Lamp saver

Sets a lower power level for the lamp.

Language

Selects the language used by the on-screen menu.

Hide

Hides the screen and mutes the sound.

Advanced setup

Adjusts additional setup settings.

■ **Power timeout**

Sets the length of time the projector waits for an input signal before automatically shutting down.

■ **Clean edges**

Enlarges and clips video images to remove noise from picture edges.

■ **Timeout for menu**

Sets how many seconds the on-screen menu waits for input before it closes.

■ **Horizontal size**

Fine-tunes the width of the image for multi-projector setups.

■ **Reset lamp hours**

For a new lamp, resets the hours of use.

■ **Projector lock**

Sets or cancels a secret button sequence that must be entered for the projector to operate.

■ **Reset all settings**

Restores all menu settings to factory default settings.

Picture Menu

Changing these settings affects only the active source. Some picture adjustments are available only when certain input ports are in use. Unavailable adjustments are shown in gray in the on-screen menu.

Color settings

Adjusts the image and colors.

- **Brightness**

Brightens or darkens the image.

- **Contrast**

Sets the difference between light and dark areas.

- **Sharpness**

Sharpens or softens the image.

- **Color saturation**

Adjusts the intensity of colors.

- **Tint**

Shifts colors toward red or green.

- **Reset color settings**

Restores these color settings to the default settings.

Advanced color

Adjusts the individual colors in the image.

- **Red**

Adjusts the amount of red in the image.

- **Green**

Adjusts the amount of green in the image.

- **Blue**

Adjusts the amount of blue in the image.

- **Reset advanced settings**

Restores the advanced color settings to their default values.

VGA settings

Adjusts settings for a computer input.

- **Auto-sync**

Resynchronizes the projector with the input. If a VGA input image looks incorrect, press auto-sync to try correcting the image.

■ **Frequency**

Adjusts the timing of the projector relative to the computer.

■ **Tracking**

Adjusts the phase of the projector relative to the computer.

■ **Vertical offset**

Adjusts the image up or down within the projection area.

■ **Horizontal offset**

Adjusts the image left or right within the projection area.

Picture mode

Selects the Video/Graphics/Custom mode. Customize picture mode can be selected when Custom mode is selected.

Customize picture mode

Changes settings associated with the current picture mode.

■ **Picture enhancement**

Refines the color, lightness, and other characteristics of the picture.

■ **White intensity**

Increases the brightness of white areas.

■ **Color temperature**

Shifts color toward red or blue.

■ **Aspect ratio**

Selects how the picture fits on the screen:

- ✦ Best fit: automatically fits the picture without stretching it.
- ✦ 1-to-1: shows each picture dot as one projected dot.
- ✦ Reduced: fits a standard-shape picture onto a widescreen projection screen.
- ✦ Full: uses the entire projector resolution screen size, with stretching permitted.

■ **Reset this picture mode**

Restores the current picture mode to its default settings.

Source Menu

VGA

Shows the source connected to the VGA-in port.

Composite video

Shows the source connected to the composite-video port.

S-video

Shows the source connected to the S-video port.

Component

Shows the source connected to the component video port.

DVI

Shows the source connected to the DVI port.

Source scan

Sets whether the projector automatically searches for input signals and displays the next one found.

Widescreen input

Sets whether a widescreen (16:9) input device is in use. Adjusts the height of the image accordingly.

Help Menu

Displays information and status of the projector.

Maintenance

The projector needs proper maintenance. You should keep the lens clean as dust, dirt or spots will project on the screen and diminish image quality. If any other parts need replacing, contact your dealer or qualified service personnel. When cleaning any part of the projector, always switch off and unplug the projector first.

Warning:

Never open any of the covers on the projector. Dangerous electrical voltages inside the projector can cause severe injury. Do not attempt to service this product yourself. Refer all servicing to qualified service personnel.

Cleaning the Lens

Gently wipe the lens with lens cleaning paper. Do not touch the lens with your hands.

Cleaning the Projector Housing

Gently wipe with a soft cloth. If dirt and stains are not easily removed, use a soft cloth dampened with water, or water and neutral detergent, and wipe dry with a soft, dry cloth.



- *Turn off the projector and remove the AC power cord from the power outlet before beginning maintenance work.*
- *Make sure the lens is cool before cleaning.*
- *Do not use detergents or chemicals other than those noted above. Do not use benzene or thinners.*
- *Do not use chemical sprays.*
- *Use a soft cloth or lens paper only.*

Replacing the Lamp

As the projector operates over time, the brightness of the projector lamp gradually decreases and the lamp becomes more susceptible to breakage. We recommend replacing the lamp if a warning message is displayed.



- *The lamp becomes high temperature after turning off the projector with the power button. If you touch the lamp, you may scald your finger. When you replace the lamp, wait for at least 45 minutes for the lamp to cool down.*
- *Do not touch the lamp glass at any time. The lamp may explode due to improper handling, including the touching of the lamp glass.*
- *Lamp lifetime may differ from lamp to lamp and according to the environment of use. There is no guarantee of the same lifetime for each lamp. Some lamps may fail or terminate their lifetime in a shorter period of time than other similar lamps.*
- *A lamp may explode as a result of vibration, shock or degradation as a result of hours of use as its lifetime draws to an end. Risk of explosion may differ according to the environment or conditions in which the projector and lamp are being used.*
- *Faster on-off-cycles will damage the lamp and reduce lamp life. Wait at least for 5 minutes to turn off the projector after powering on.*
- *Do not operate the lamp in proximity to paper, cloth, or other combustible material nor cover it with such materials. Otherwise it could cause a fire.*
- *Do not operate the lamp in an atmosphere containing an inflammable substance, such as thinner. Otherwise it could cause a fire or explosion.*
- *Thoroughly ventilate the area or the room when operating the lamp in an oxygen atmosphere (in the air). If ozone is inhaled, it could cause headaches, nausea, dizziness, etc.*
- *The inorganic mercury is involved in the lamp. If the lamp bursts, the mercury inside the lamp will go out of the projector. Leave the area immediately if the lamp shatters while being operated and ventilate the area for at least 30 minutes in order to avoid the inhalation of mercury fumes. Otherwise it could be harmful to user's health.*

ORDERREPLACEMENTLAMP

Replacement lamp can be ordered through your dealer. When ordering a projection lamp, give the following information to the dealer.

Model No. of your projector : EIP-X350

Replacement LampNo. : P8984-1021

1. Turn off the projector.
2. Allow the projector to cool for at least 45 minutes.
3. Unplug the power cord.
4. Loosen the screws in the lamp cover ① and remove the cover ②.



5. Remove the screws from the lamp module ③, raise the handle ④, and lift out the module ⑤.

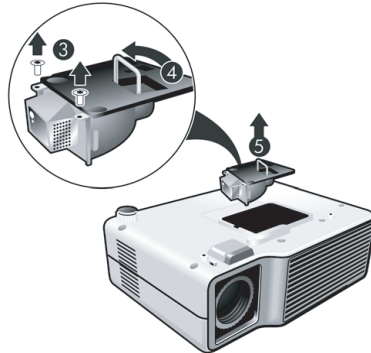

6. Insert the new lamp module into the projector and tighten the screws.
7. Replace the lamp cover and tighten the screws.
8. Turn on the projector. If the lamp does not turn on after the warm-up period, try reinstalling the lamp.
9. Reset the lamp timer. Press **MENU**, go to **Setup > Advanced setup > Reset lamp hours**, and press **MENU**.



- *Dispose of the used lamp according to local regulations.*
- *Ensure that screws are tightened properly. Screws not tightened fully may result in injury or accidents.*
- *Since the lamp is made of glass, do not drop the unit and do not scratch the glass.*
- *Do not reuse the old lamp. This could cause the lamp to explode.*
- *Be sure to turn off the projector and unplug the AC power cord before replacing the lamp.*
- *Do not use the projector with the lamp cover removed.*

Specifications

Display Type	Single 0.7" DLP panel
Resolution (Pixels)	XGA (1024 × 768)
Lens	Manual Zoom (1.2x) F=2.3~2.75 f=23.6~28.25mm Throw distance 1.2~10m Screen size 30inch ~300inch
Contrast Ratio	2000:1
Uniformity	>80%
Lamp	300W
Projection Type	Front, Rear, Ceiling
Input Source	D-Sub 15 pin, S-Video, Composite Video, DVI, YPbPr, Audio in (stereo phone jack), USB, RS-232
Output Source	D-Sub 15 pin, Audio out (stereo phone jack)
Video Compatibility	NTSC4.43, NTSC-M PAL-60, PAL-M, N, (B, D, G, H, I) SECAM
Scanning Frequency	
Horizontal Frequency	31 - 79 KHz
Vertical Frequency	50 - 85 Hz
Digital Keystone Correction	Vertical + / - 15°
Integrated Speaker	1 x 2W
Noise Level	Less than 35 dBA in Normal mode, or 32 dBA in lamp saver mode
Environment	Operating: Temperature: 0°C to 40 °C Humidity: 30% - 90% (No condensation) Storage: Temperature: -20°C to 60 °C Humidity: 90% maximum (No condensation)
Power Requirement	AC 100 – 240V, 50 / 60 Hz
Power Consumption	350W~380W Standby mode: less than 5W
Dimension	309 × 229 × 102 mm
Weight	3.2 kg (7.0lb)

Note: Design and Specifications are subject to change without prior notice.

Appendix

LED Indicator Messages

Indicators			Projector Condition
Power	Lamp	Temperature	
Solid On	-	-	The projector is operating normally.
Blinking	-	-	Standby mode
Off	-	-	During shutdown cool-down.
-	Solid On	-	During flash update. Lamp failure.
-	Blinking	-	Ballast failure.
-	-	Solid On	Over-temperature error. During flash update.
-	-	Blinking	Fan, sensor, or color wheel error.

Compatibility Modes

Computer:

Compatibility	Resolution	H-Sync [KHz]	V-Sync [Hz]
VGA	640x480	31.469	59.940
	640x480	37.861	72.809
	640x480	37.500	75.000
	640x480	43.269	85.008
SVGA	800x600	35.156	56.250
	800x600	37.879	60.317
	800x600	48.077	72.188
	800x600	46.875	75.000
	800x600	53.674	85.061
XGA	1024x768	48.363	60.004
	1024x768	56.476	70.069
	1024x768	60.023	75.029
	1024x768	68.677	84.997
SXGA	1280x1024	63.981	60.020
	1280x1024	79.976	75.025
MAC 16"	832x624	49.72	74.55
MAC 19"	1024x768	60.241	75.020

Video:

Signal	Horizontal Frequency (kHz)	Vertical Frequency (Hz)
480i	15.734 kHz	60 Hz
480p	31.469 kHz	60 Hz
576i	15.625 kHz	50 Hz
576p	31.25 kHz	50 Hz
720p	45.0 kHz	60 Hz
720p	37.5 kHz	50 Hz
1080i	33.75 kHz	60 Hz
1080i	28.125 kHz	50 Hz

Troubleshooting

Refer to the statement that most closely matches the nature of the problem before sending the projector for repairs. If the problem persists, contact your local reseller or service center.

Please refer to “LED Indicator Messages” (p.30) as well.

Problem:	Solutions
If no lights or sounds turn on:	<ul style="list-style-type: none">- Be sure that the power cord is securely connected to the projector and the other end is plugged into an outlet with power.- Be sure the main power switch is turned on.- Press the power button again.- Unplug the power cord and wait for a short while, then plug it in and press the power button again.
If a “scanning” or “waiting” message is displayed on a blank screen:	<ul style="list-style-type: none">- Press the Source button on the projector or remote control one or more times until the correct source name is selected.- Be sure the external source is turned on and connected.- For a computer connection, ensure your notebook computer’s external video port is turned on. Refer to the computer manual.
If the wrong input source is displayed:	<ul style="list-style-type: none">- Press the Source button on the projector or the remote control one or more times to select another active input source.
If the image is out of focus:	<ul style="list-style-type: none">- Be sure the lens cover is open.- While displaying the on-screen menu, adjust the focus ring. (The image size should not change; if it does, you are adjusting the zoom, not the focus.)- Check the projection lens to see if it needs cleaning.- For a computer connection, set the display resolution as the computer to the same resolution as the projector, 800 × 600 or 1024 × 768. If the computer has multiple monitors, adjust the resolution of the monitor assigned to the projector.- For a computer connected to the S-video port, the image cannot be as high resolution as what you see on the computer display.

If the image is flickering or unstable for a computer connection: - Press the **Resync button**.
- Press **MENU**, go to **Picture > VGA settings**, and adjust **Frequency** or **Tracking**.

If the remote control does not operate: - Be sure nothing is blocking the remote control receiver on the front or back of the projector. Use the remote control within the effective range.
- Aim the remote control at the screen or at the front or back of the projector.
- Move the remote control so it is more directly in front of or behind the projector and not as far to the side.

EIKI

U.S.A.

EIKI International, Inc.
30251 Esperanza
Rancho Santa Margarita
CA 92688-2132
U.S.A.
Tel : 800-242-3454 (949)-457-0200
Fax : 800-457-3454 (949)-457-7878
E-Mail : usa@eiki.com

Deutschland & Österreich

EIKI Deutschland GmbH
Am Frauwald 12
65510 Idstein
Deutschland
Tel : 06126-9371-0
Fax : 06126-9371-14
E-Mail : info@eiki.de

China

EIKI (Shanghai) Co., LTD
1. Dapu Road, Golden Magnolia Plaza
#2109 Shanghai,
200023 China
Tel : 86-21-5396-0088
Fax : 86-21-5396-031
E-Mail : info@eikichina.com.cn

Canada

EIKI CANADA -Eiki International, Inc.
P.O. Box 156, 310 First St. - Unit 2,
Midland, ON, L4R 4K8, Canada
Tel : 800-563-3454 (705)-527-4084
Fax : 800-567-4069 (705)-527-4087
E-Mail : canada@eiki.com

Eastern Europe

EIKI CZECH spol. s.r.o.
Umelecka 15
170 00 Praha 7
Czech Republic
Tel : +42 02 20570024 +42 02 20571413
Fax : +42 02 20571411
E-Mail : easterneurope@eiki.de

Japan & Worldwide

EIKI Industrial Company Limited.
4-12 Banzai-Cho, Kita-Ku, Osaka,
530-0028 Japan
Tel : +81-6-6311-9479
Fax : +81-6-6311-8486

WorldWide Website <http://www.eiki.com>