

**DS+60 / DW30 / Matrix 3000**  
**User's Manual**

# Table of Contents

---

<b>1 INTRODUCTION</b>	1.1	Projector Overview .....	1-1
	1.2	Components.....	1-3
	1.3	Purchase Record and Servicing.....	1-4
<b>2 INSTALLATION &amp; SETUP</b>	2.1	Quick Setup.....	2-1
	2.2	Installation Considerations.....	2-3
	2.3	Connecting Sources.....	2-12
	2.4	Connecting Communications .....	2-15
	2.5	System Integration – GPIO Connector.....	2-20
	2.6	Power Connection .....	2-20
<b>3 OPERATION</b>	3.1	About the Projector .....	3-1
	3.2	Using the Remote or Built-in Keypad.....	3-3
	3.3	Navigating the Menus .....	3-10
	3.4	Using Inputs and Channels.....	3-14
	3.5	Adjusting the Image .....	3-19
	3.6	Adjusting System Parameters and Advanced Controls.....	3-34
	3.7	Working with PIP and Seamless Switching.....	3-46
	3.8	The Lamp Menu.....	3-49
	3.9	Status Menu .....	3-53
	3.10	Using Multiple Projectors .....	3-53
	3.11	Remote Control of the Projector .....	3-63
	3.12	Error Conditions.....	3-64
<b>4 MAINTENANCE</b>	4.1	Warnings and Safety Guidelines.....	4-1
	4.2	Cleaning and Maintenance Guide .....	4-4
	4.3	Replacing Remote Batteries .....	4-5
	4.4	Lamp and Filter Replacement .....	4-5
	4.5	Replacing the Projection Lens.....	4-8
<b>5 TROUBLESHOOTING</b>	5.1	Displays.....	5-1
	5.2	Lamp .....	5-3
	5.3	Ethernet.....	5-3
<b>6 SPECIFICATIONS</b>	6.1	Specifications .....	6-1
<b>APPENDICES</b>		Appendix A: Glossary .....	A-1
		Appendix B: Keypad Reference .....	B-1
		Appendix C: Serial Communication.....	C-1
		Appendix D: Throw Distance .....	D-1
		Appendix E: System Integration.....	E-1
		Appendix F: Optional Input Modules.....	F-1
		Appendix G: 300W P-VIP Lamps Product Safety Data Sheet.....	G-1

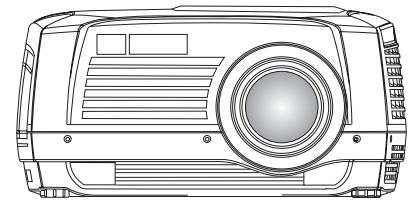


# Introduction

## 1.1 Projector Overview

*Christie DS+60/DW30/Matrix 3000* projectors are professional quality single-chip projectors that use Digital Light Processing™ (DLP™) technology from Texas Instruments to achieve bright, crisp images. With a range of available lenses, input modules and built-in ChristieNET™ these projectors are flexible and customizable.

The compact size and native SXGA+ (1400x1050) resolution of the *DS+60*, and the native 720P (1280X720) resolution of the *DW30* make them ideally suited for boardrooms, conference rooms and the like.



Also a reliable and compact SXGA+ projector, the *Matrix 3000* with its purpose built simulation features such as RGB color matching, and gamma controls can be used in Simulation and Visualization applications.

### Key features:

- 1-chip DLP™ technology
- Native SXGA+ resolution (1400 x 1050) for *DS+60/Matrix 3000*, 720P resolution for *DW30* (1280 x 720)
- Variable brightness due to use of dual lamp illumination system
- Exceptional contrast ratio range
- Two user replaceable lamps - 300W P-VIP®
- Auto-switching or user selectable lamp operation mode (Single or Dual lamp)
- 10-bit image processing
- 24-bit RGB display
- Display of NTSC, PAL, and SECAM video inputs and HDTV/DTV formats
- Memory for up to 50 custom channels (source setups)
- Intuitive on-screen menu system
- Picture-in-Picture and Seamless switching
- Optional ChristieTWIST™ image warping module (*standard in Matrix 3000*)
- Status LED display for projector monitoring
- Multiple control options including ChristieNET™, RS-232 and RS-422
- Remote controlled shutter
- Motorized lens mount for smooth lens control
- Field interchangeable projection lenses

See **Section 6** for a complete list of product specifications.

**Things You Should Know  
About Your Projector**

## 1 Powering ON

- (a) **Be patient when powering the projector ON** or switching lamp operation modes. As the lamps warm up, brightness will gradually increase. (No light appears on the wall during the first 25 seconds.) On the rare occurrence a lamp does not ignite, the projector will try again several times. *(For more information see 3.7 The Lamp Menu)*
- (b) **Wait for the projector to complete initialization before sending keypad commands** (“On” will appear on the LED display), otherwise it will be ignored.
- (c) **The projector enforces a 90 second wait from the time the projector is powered down and powered back up again.** This gives the lamps enough time to cool down to a point where they can be turned on again.
- (d) **Use the windows located on the lamp doors as indicators when trying to determine whether a lamp is on or off without accessing software menus.**

## 2 Lamp Operation Modes – Auto Switching

- (a) **The projector will automatically switch from one single lamp operation mode to another to maintain light on the wall.**
- (b) **Check the status of a lamp in the Status menu, Lamp menu or by looking at the windows on the lamp doors.**  
*(For more information see 3.7 The Lamp Menu)*

## 3 Lamp Operation Modes – Manual Switching

- (a) **One lamp will turn off only after the other lamp has successfully been turned on.** This allows you to view content without interruption when switching between lamp operation modes. It takes 25 seconds for a lamp that was just turned on to warm up and reach full brightness. When the original lamp turns off you will notice a slight dimming, which indicates the lamp switching operation is complete. At this point, you can perform any adjustment, such as Color Wheel Delay. *(For more information see 3.7 The Lamp Menu)*

## 4 Flexible Light Output Control

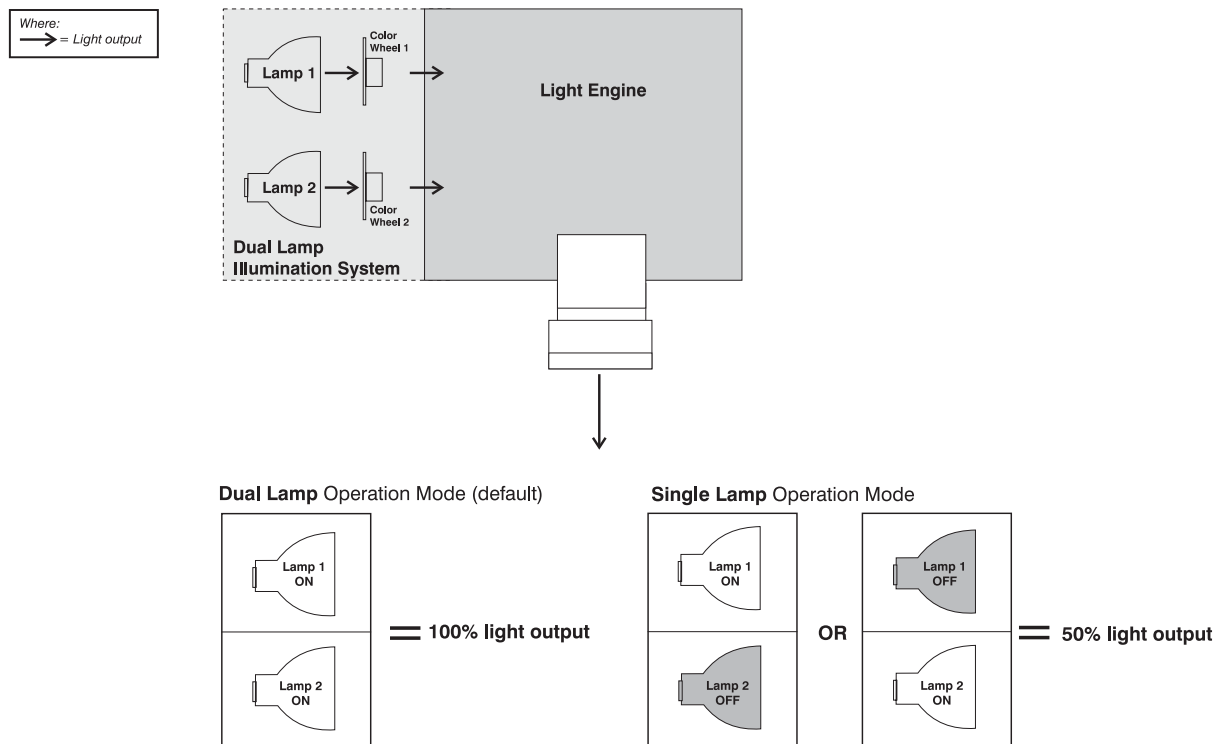
- (a) **Switching from Dual to Single Lamp operation modes** can reduce light output by approximately 50%.
- (b) **Adjusting lamp power** in the range of 300W to 250W can provide approximately 17% dimming capability.
- (c) **Adjusting the Optical Aperture** can significantly drive brightness down (approximately 78%) while increasing contrast from 1100-5000:1 increase contrast.
- (d) **Always check the optical aperture and lamp power levels** before troubleshooting brightness related problems.

## 5 White Boost

- (a) **White Boost automatically turns off when Edge Blending, adjusting Brightness Uniformity or making Color Adjustments.** A noticeable dimming of the display occurs. For best results, set White Boost to 10 for data content and 2 for video.



**How the projector works** ➤ The light generated by the lamp(s) is then sequentially filtered into the RGB color primaries by the spinning color wheel(s) and presented to the single chip DMD, located in the light engine, in sequence. The reflected light from the DMD chip then passes through the projection lens to the screen.



**Figure 1.1**

## 1.2 Components

Ensure you have received all the following components before using your projector.

- Wireless IR Remote (with batteries)
- Wired Remote Cable (10 ft.)
- Line Cord (North American and European)
- Computer Cable (Dsub 15 to DVI-I)
- DVI-I Cable
- S-Video Cable
- User's Manual

*NOTE: For a complete list of optional components that can be used with your projector, refer to Section 6 – Specifications. Call Christie or your dealer, if required.*

**1.3 Purchase Record and Servicing**

Whether the projector is under warranty or the warranty has expired, Christie’s highly trained and extensive factory and dealer service network is always available to quickly diagnose and correct projector malfunctions. Service manuals and updates are available to service technicians for all projectors.

If you encounter any problems with the projector and require assistance, contact your dealer or Christie Digital Systems. Fill out the information in the table below and keep with your records for future reference.

**Purchase Record**

Dealer:
Dealer Phone Number:
Projector Serial Number:
Purchase Date:
Installation Date, if applicable:

*NOTE: The serial number can be found on the license label located on the bottom and side of the projector.*

You can also register your product on-line by visiting [www.christiedigital.com](http://www.christiedigital.com) ⇒ **Service and Support** ⇒ **Product Registration**. This will keep you in touch with all the latest product information, such as updates, technical bulletins, downloads and Christie newsletters.

# Installation & Setup

---

## 2.1 Quick Setup

The instructions provided here are for those that are familiar with the projector and wish to quickly set it up and use it temporarily. Refer to the remaining subsections of this manual for a more complete setup.

### Step 1 ➤ **Install a Projection Lens**

The projection lens is shipped separately from the projector and must be installed prior to setting up the projector. Install the projection lens as described in 4.5 *Replacing the Projection Lens*.

▲ Remove the lens “plug” from the projector before installing a lens.

▲ When shipping the projector, always remove the lens and reuse the lens plug. This will prevent dust and debris from entering and settling on critical optical components.

### Step 2 ➤ **Position the Projector**

Place the projector on a sturdy, level surface and position it so that it is perpendicular to the screen at a suitable distance. In general, the further back the projector is positioned from the screen, the larger the image will be.

If required, you can level the projector by adjusting its three feet. With the projector positioned perpendicular to the screen the image will appear rectangular instead of keystone.

For more detailed instructions on positioning the projector refer to *Projector Position and Mounting* later in this section.


### Step 3 ➤ **Connect a Source**

Located at the back of the projector is the input panel where all source connections are made. Each input is clearly labeled for easy identification.

Using the appropriate cable(s), connect your source. Connect RGB and YPbPr sources to **INPUT 1** located in the upper right corner of the input panel. Use the DVI-I connector at **INPUT 2** to connect analog or digital display signals. Connect composite video to **INPUT 3** and S-video to **INPUT 4**. *NOTE: One of the available optional input modules can be installed at **INPUT 5** for additional connections.*


*Refer to 2.3 Connecting Sources for more details on connecting a specific source.*

**Step 4 ➤ Connect the Line Cord**

 *North American and European rated line cords are provided with each projector. Make sure you use the correct line cord for your area.*

Connect the appropriately rated line cord (supplied with the projector) to the AC receptacle located on the lower right side of the projector and the other end to an AC outlet (100-240V). Do not use a line cord or AC supply not in the specified voltage and power range. See *Section 6 – Specifications* for projector power requirements.

**Step 5 ➤ Turn the Projector ON**


Press  for two seconds to turn the projector on. As the projector begins initialization an active pattern of segments appear in the two-digit display located on the built-in keypad. Wait for “ON” to appear in the display before sending any keypad commands otherwise the command will be ignored.

By default, the projector powers up in dual lamp mode. *Refer to Section 3 – The Lamp Menu for more information on lamp operation modes and lamp auto-switching.*

**Step 6 ➤ Select a Source**

Press one of the input keys (remote or built-in keypad) to select and display the image from that source.

**Step 7 ➤ Perform Auto Setup on the current source**

Press  to automatically initiate the optimization of critical display parameters for the selected source, which includes but is not limited to size, position and pixel tracking. After this process is complete, additional modifications can be made to image settings as required.

## 2.2 Installation Considerations

Proper installation of your projector will ensure the quality of your display. Whether you are installing a projector temporarily or permanently you should take the following into account to ensure your projector performs optimally.

**Installation type** ➤ Choose the installation type that best suits your needs: front or rear screen, floor mount or inverted mount.

### **Front Screen, Floor Mount Installation**

ADVANTAGES	CONSIDERATIONS
<ul style="list-style-type: none"> <li>• Easy to set up</li> <li>• Can be moved or changed quickly</li> <li>• Easy to access</li> </ul>	<ul style="list-style-type: none"> <li>• Shares floor space with audience</li> </ul>

### **Front Screen, Inverted Mount (ceiling) Installation**

ADVANTAGES	CONSIDERATIONS
<ul style="list-style-type: none"> <li>• Does not take up audience space</li> <li>• Projector is unobtrusive</li> <li>• Projector cannot be accidentally moved</li> </ul>	<ul style="list-style-type: none"> <li>• Installation is more permanent</li> <li>• It is more difficult to access the projector</li> </ul>

### **Rear Screen, Floor Mount Installation**

ADVANTAGES	CONSIDERATIONS
<ul style="list-style-type: none"> <li>• Projector is completely hidden</li> <li>• Projector is easily accessed</li> <li>• Usually good ambient light rejection</li> </ul>	<ul style="list-style-type: none"> <li>• Requires additional space (separate room)</li> <li>• Installation cost is usually higher</li> </ul>

### **Rear Screen, Inverted Mount (ceiling) Installation**

ADVANTAGES	CONSIDERATIONS
<ul style="list-style-type: none"> <li>• Projector is completely hidden</li> <li>• Usually good ambient light rejection</li> </ul>	<ul style="list-style-type: none"> <li>• Requires separate room</li> <li>• Installation cost is usually higher</li> </ul>

### **Rear Screen, Floor Mount with Mirror**

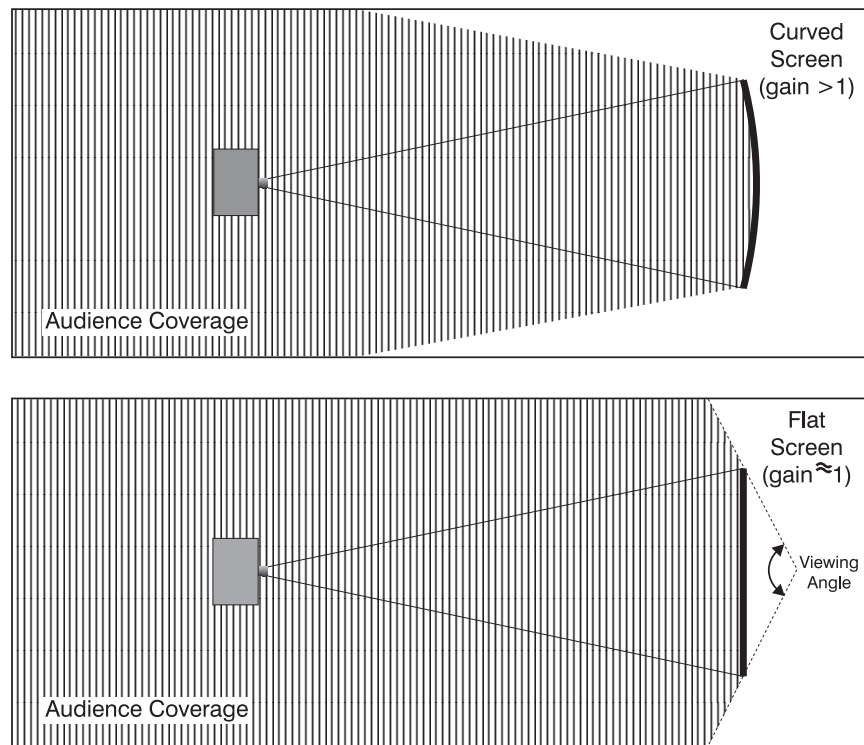
ADVANTAGES	CONSIDERATIONS
<ul style="list-style-type: none"> <li>• Projector is completely hidden</li> <li>• Usually good ambient light rejection</li> <li>• Requires less space behind screen than other rear screen installations</li> </ul>	<ul style="list-style-type: none"> <li>• Requires separate room</li> <li>• Installation cost is usually higher</li> </ul>

### **Screen Type** ➤ **Front Screen Installations**

In front screen installations the projector and audience are positioned in front of the screen, which can be flat or curved.

Flat screens are most recommended with this projector. They offer a gain of about 1 with a viewing angle just less than 180°. This type of screen reflects incident light equally in all directions so the audience can see the display from various angles.

Curved screens have a gain greater than 1 with a viewing angle much less than 180°. This type of screen does not reflect incident light equally in all directions instead it is concentrated in a viewing cone. The audience sitting within the viewing cone area will see a brighter image than those sitting just outside this area.



### **Rear screen installations**

There are two basic types of rear screens: diffused and optical.

A diffused screen has a surface, which spreads the light striking it. Purely diffused screens have a gain of less than 1. The main advantage of the diffused screen is its wide viewing angle, similar to that of a flat screen for front screen projection. This type of screen is suitable when a wide viewing angle is required but there is low ambient room lighting.

Optical screens take light from the projector and redirect it to increase the light intensity at the front of the screen. This reduces it in other areas. A viewing cone, similar to that of a curved front screen installation is created. This type of screen is better suited for brightly lit rooms where the audience is situated within the viewing cone.

### **Screen size**

Choose a screen size, which is appropriate for your lens and application. Keep in mind that if the projector will be used to display text information, the image size must allow the audience to recognize all text clearly. The eye usually sees a letter clearly if eye-to-text distance is less than 150 times the height of the letter. Small text located too far from the eye will likely be illegible at a distance no matter how sharply and clearly it is displayed.

To fill a screen with an image, the aspect ratio of the screen should be equal to the aspect ratio of the image (expressed as the ratio of its width to its height). Standard video from a VCR has a 4:3 or 1.33:1 aspect ratio. For example, to display a VCR output with a 4:3 aspect ratio onto a 10-foot (3m) high screen, the width of the screen must be at least 13.3feet (4m).

**Ambient Lighting** ➤ The high brightness of this projector is well suited for locations where ambient lighting might be considered less than ideal for projection. A typical room with ceiling lights and windows rarely requires special attention. Contrast ratio in your images will be noticeably reduced only if light directly strikes the screen, such as when a shaft of light from a window or floodlight falls on the image. Images may then appear washed out and less vibrant.

In general, avoid or eliminate light sources directed at the screen.

**Other Considerations** ➤ Other considerations and tips that can help improve your installation:

- Keep the ambient temperature constant and below 35°C (95°F). Keep the projector away from heating and/or air conditioning vents.
- Keep the projector away from devices that radiate electromagnetic energy such as motors and transformers. Common sources of these include slide projectors, speakers, power amplifiers, elevators, etc.
- Choose the best screen size for the application. Since more magnification reduces brightness, use a screen size appropriate for the venue but not larger than required. Installing a large screen in a small room is similar to watching television at a close range; too large a screen can overpower a room and interfere with the overall effect. A good rule of thumb is to be no closer than 1.5 times the width of the screen.

### **Projector Position and Mounting**

#### ➤ **Throw distance**

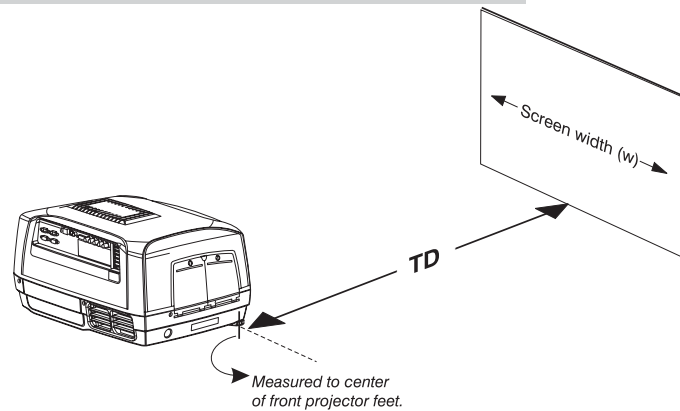
Throw distance (also known as projection distance) is the distance measured from your projector's front feet to the screen. This is an important calculation in any projector installation as it determines whether or not you have enough room to install your projector with a desired screen size and if your image will be of the right size for your screen.

You can quickly estimate the throw distance by taking the horizontal width of the screen and multiplying it by the lens throw ratio. The result of this calculation tells you roughly how far back the projector should be positioned from the screen in order to project a focused image large enough to fill the screen. For example, if you are going to use a 0.8:1 lens, throw distance would roughly be 0.8 X screen width.

**▲ IMPORTANT: Always calculate the precise throw distance for the lens type and screen size you're going to use. Refer to Appendix D for actual throw distance formulas and quick reference charts. NOTE: An online lens calculator is also available at [www.christiedigital.com / service and support / product downloads](http://www.christiedigital.com/service_and_support/product_downloads).**

**Estimating Throw Distance**

**Throw Distance (TD) = (Screen Width (w) X Lens Throw Ratio)**



**Figure 2.1. Estimating Throw Distance**

**Vertical and horizontal position**

The correct vertical and horizontal position of the projector in relation to the screen depends on the lens type and the screen size. Ideally, the projector should be positioned perpendicular to the screen. This way, the image will appear rectangular instead of keystone (trapezoidal).

The **vertical position** of the image can be offset – that is moved above or below the optical axis (lens center) by adjusting the fully motorized lens mount using the keypad. The amount of vertical offset available depends directly on the lens installed in the projector and can be slightly limited if horizontal offset has been applied. Vertical offset can also be expressed as the percent of half the image height OR the number of pixels of shift from lens center. Refer to Figure 2.2 for some illustrated examples of vertical offset.

Table 2.1 along with Figure 2.3 show the maximum vertical offset of a lens or alternatively, how much of your projected image will appear above or below lens center if the maximum vertical offset is applied using that lens.

**Table 2.1. Lens Offsets for DS+60 and Matrix 3000 (SXGA+)**

Lens Type	Vertical Offset (% of half height)		Maximum amount of projected image above or below lens center		Horizontal Offset (% of half width)		Maximum amount of projected image to one side of lens center	
	%	Pixels	%	Pixels	%	Pixels	%	Pixels
0.8:1 fixed	12%	+/-63	56%	+/-588	7%	+/-48	53%	+/-748
1.2:1 fixed	120%	+/-630	110%	+/-1155	78%	+/-546	89%	+/-1246
1.3-1.7:1	120%	+/-630	110%	+/-1155	78%	+/-546	89%	+/-1246
1.7-2.5:1	120%	+/-630	110%	+/-1155	78%	+/-546	89%	+/-1246
2.5-4.0:1	120%	+/-630	110%	+/-1155	78%	+/-546	89%	+/-1246
4.0-7.0:1	120%	+/-630	110%	+/-1155	78%	+/-546	89%	+/-1246

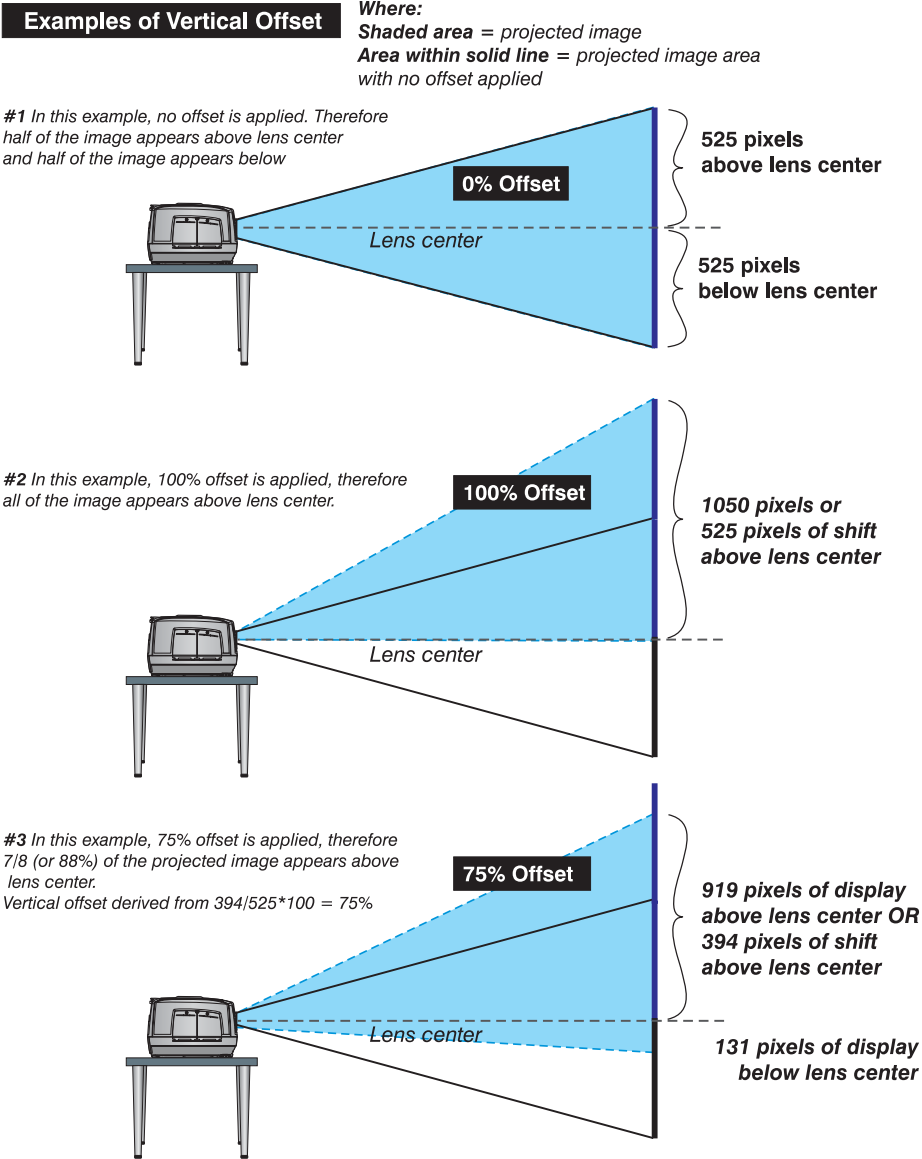
NOTES: 1) % Offset = # pixels of offset / half panel resolution x 100 2) Offsets are subject to ±7% centering tolerance.



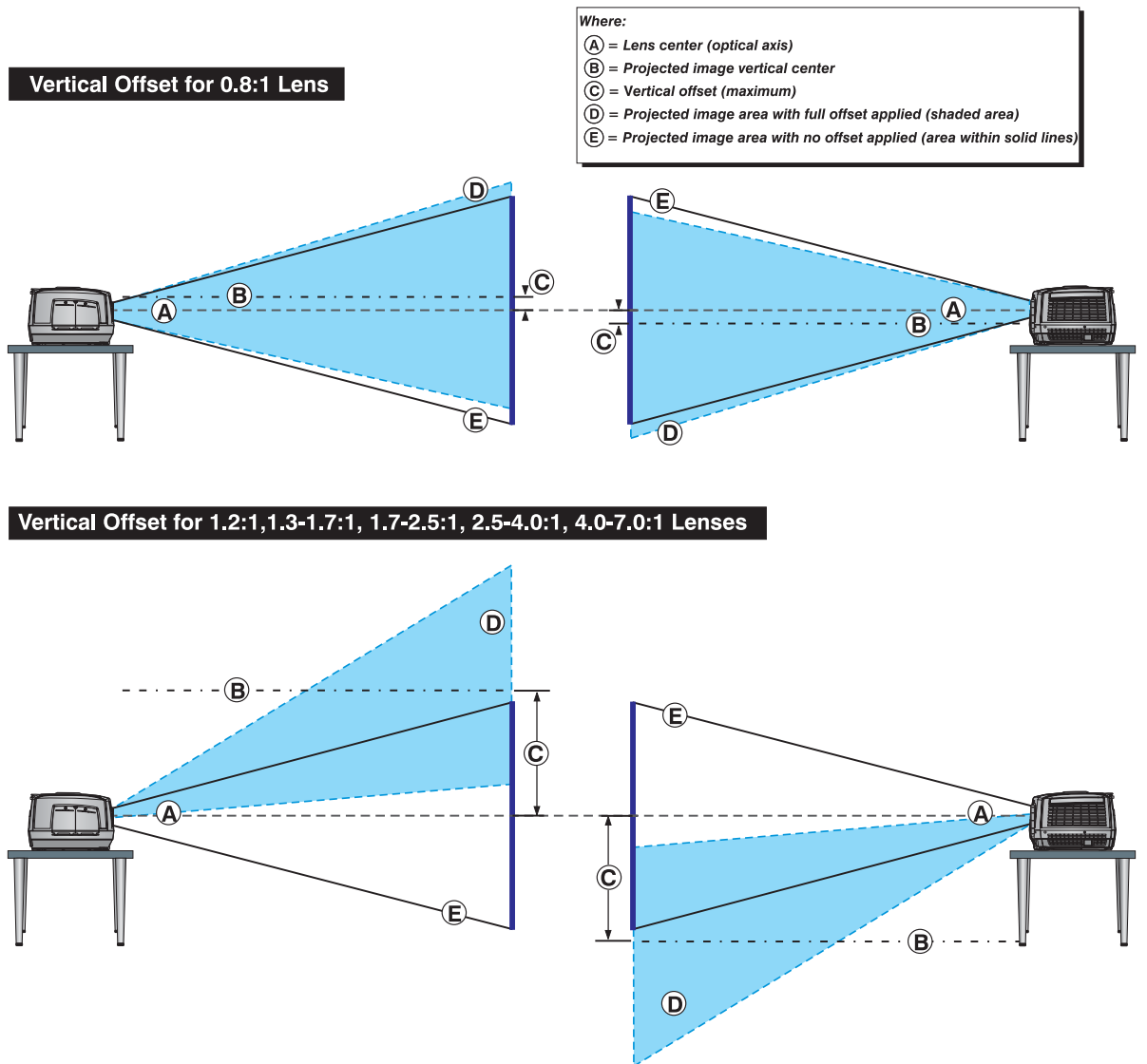
**Table 2. 2 Lens Offsets for DW30 (720P)**

Lens Type	Vertical Offset (% of half height)		Maximum amount of projected image above or below lens center		Horizontal Offset (% of half width)		Maximum amount of projected image to one side of lens center	
	%	Pixels	%	Pixels	%	Pixels	%	Pixels
0.8:1 fixed	81%	+/-292	90%	+/-652	31%	+/-200	66%	+/-840
1.2:1 fixed	231%	+/-832	110%	+/-1192	104%	+/-664	102%	+/-1304
1.3-1.7:1	231%	+/-832	165%	+/-1192	104%	+/-664	102%	+/-1304
1.7-2.5:1	231%	+/-832	165%	+/-1192	104%	+/-664	102%	+/-1304
2.5-4.0:1	231%	+/-832	165%	+/-1192	104%	+/-664	102%	+/-1304
4.0-7.0:1	231%	+/-832	165%	+/-1192	104%	+/-664	102%	+/-1304

NOTES: 1) % Offset = # pixels of offset / half panel resolution x 100 2) Offsets are subject to ±7% centering tolerance.



**Figure 2.2. Examples of Vertical Offset**



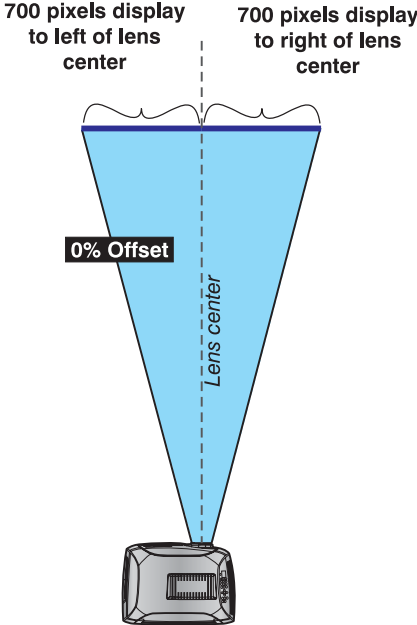
**Figure 2.3. Lens Vertical Offsets**

The **horizontal position** of the image can be offset – that is moved to the left or right of lens center, by adjusting the fully motorized lens mount through software. The amount of horizontal offset available depends on the lens installed and if the image has already been vertically offset. Horizontal offset can also be expressed as the percentage of half the image width – the number of pixels of shift to one side of lens center. Refer to Figure 2.4 for some illustrated examples of horizontal offset.

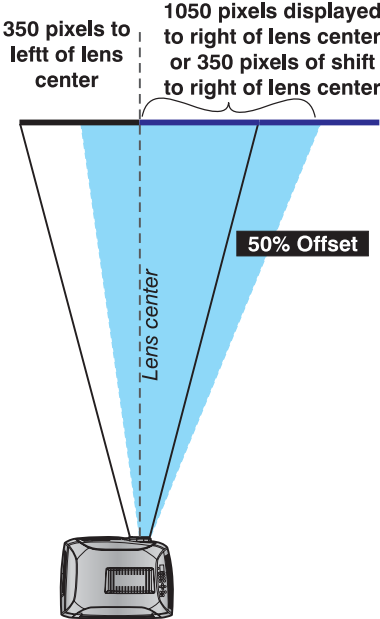
See also Table 2.1 along with Figure 2.5 which shows the maximum horizontal offset of a lens or alternatively, how much of your projected image will appear to one side of lens center if the maximum horizontal offset is applied using that lens.

**Examples of Horizontal Offset**

Shaded area = projected image  
 Area within solid line = projected image area with no offset applied



#1 In this example, no offset is applied. Therefore half (or 50%) of the image appears to the left or lens center and half (50%) appears to the right.

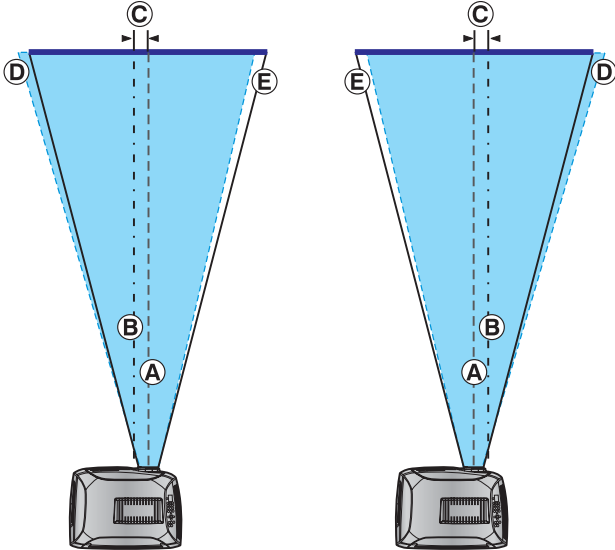


#2 In this example, 100% offset is applied, therefore 75% or 75% of the image appears to one side of lens center.

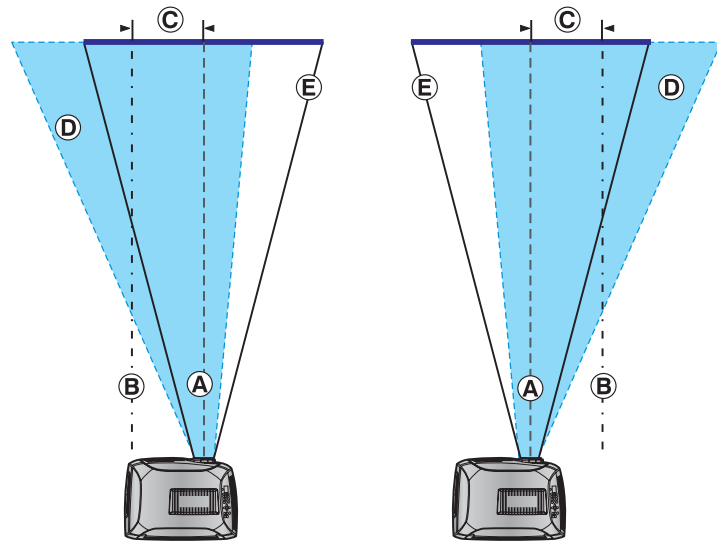
**Figure 2.4. Examples of Horizontal Offset**

**Horizontal Offset for 0.8:1 Lens**

- Where:
- (A) = Lens center (optical axis)
  - (B) = Projected image vertical center
  - (C) = Vertical offset (maximum)
  - (D) = Projected image area with full offset applied (shaded area)
  - (E) = Projected image area with no offset applied (area within solid lines)



**Horizontal Offset for 1.3-1.7:1, 1.7-2.5:1, 2.5-4.0:1, 4.0-7.0:1 Lens**



**Figure 2.5. Lens Horizontal Offsets**

**Lifting and transporting the projector** – The projector is light enough to lift and transport a short distance. Use the indentations on the bottom of the projector as a guide for hand placement, which makes carrying the projector easier.

When transporting the projector a long distance, use a stable cart or ask someone for help.

**Mounting**

There are several methods for mounting the projector. Depending on your chosen installation, one method may be more suitable than another. In typical front and rear screen installations the projector can be mounted to a secure and level surface, such as a table or cart. Carts are useful when moving a projector during a presentation or from site to site. If possible, lock the wheels when it's in position to prevent it from being moved during a presentation.

**CEILING MOUNT** - The projector can also be inverted and suspended from the ceiling using a specially designed ceiling mount fixture. This type of mounting is recommended for fixed installations and for those that want the projector out of sight or have a limited space for projector and audience.

**⚠ Use only the CHRISTIE approved ceiling mount kit designed for your projector. Ceiling Mount Kit # 38-804951-01**

**SPECIAL MOUNTING** – The projector can be rotated (front-to-back) up to 360 degrees and mounted without it affecting performance. However, the side-to-side tilt limit of the projector must not exceed +/-20 degrees. This limit is required to ensure optimal performance of the projector and its lamps. (Figure 2.6.)

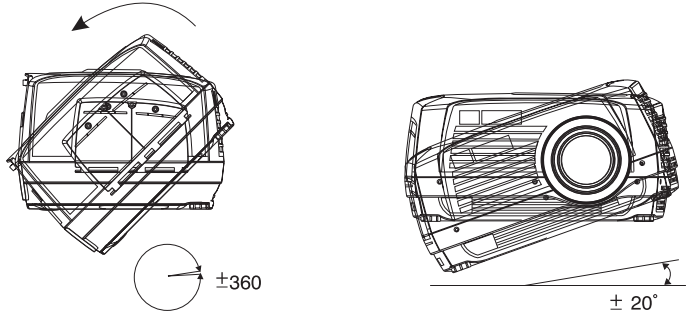


Figure 2.6.

**Adjusting projector height**

You can modify the height of the projector to remedy a slightly unlevel mounting surface by adjusting the three feet threaded into the bottom chassis. Turn each foot clockwise or counter-clockwise until the project is level on all sides. (Figure 2.7.)

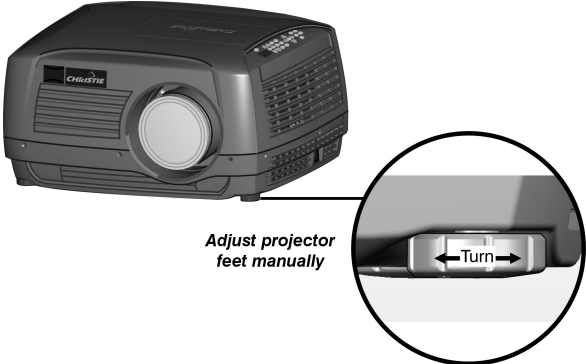


Figure 2.7.

*NOTE: The front of the projector can be raised up to 10 degrees. (Figure 2.8.)*

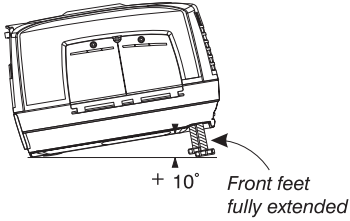


Figure 2.8.

**Folded Optics**

In rear screen applications where space behind the projector is limited, a mirror may be used to fold the optical path. See Figure 2.9. The position of the projector and mirror must be accurately set – if considering this type of installation call your dealer for assistance.

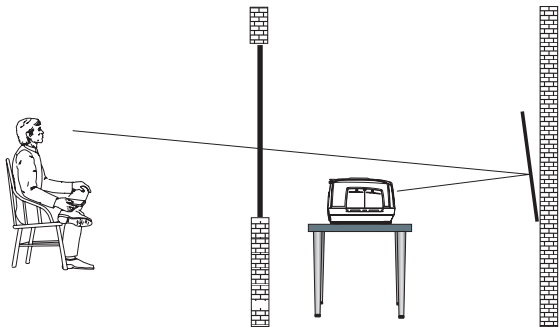


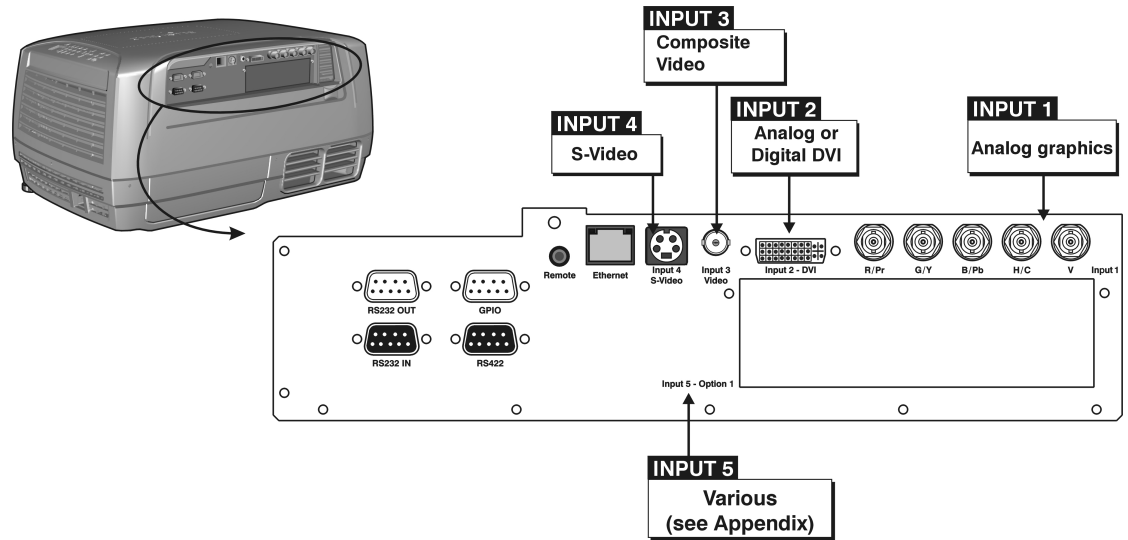
Figure 2.9.

### 2.3 Connecting Sources

Sources connect to the *Input Panel* located at the back of the projector. See Figure 2.10.

The upper right corner (**INPUT 1**) typically accepts an *RGB signal* from an external analog RGB source, or it can also be used for YPbPr signals or additional video sources. The DVI-I connector at **INPUT 2** accepts digital or analog display signals from a computer. Connect analog *composite video* at **INPUT 3** or *S-video* at **INPUT 4** from devices such as VCRs, laser disk players or DVD players.

Christie offers optional input modules that can be installed into the projector at **INPUT 5** to connect other sources.



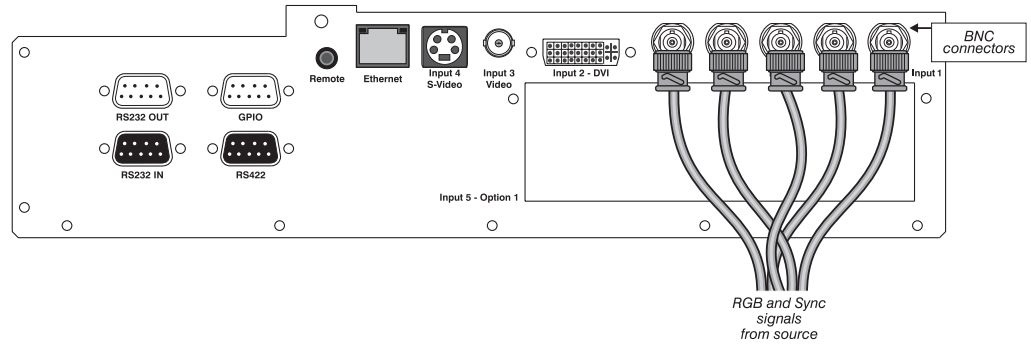
**Figure 2.10. Input Panel**

*NOTES: 1) See Section 6, Specifications for details regarding compatible inputs. 2) Use only high quality shielded cables only for all connections.*

**RGB signals (5 BNCs)** ➤ **INPUT 1** consists of 5 BNCs (connectors) for linking to a variety of sources. The typical connection would be to an RGB source such as a PC, Mac, Sun, SGI and others. This projector supports multiple sync types with RGB signals: sync-on-green, composite sync, and separate H & V syncs.

Connect the **SYNC** BNC input(s) first. Then connect the red, green and blue source outputs to the **RED**, **GREEN**, and **BLUE** BNCs on the **INPUT 1** panel. If the source uses sync-on-green, only the red, green, and blue connections are required. If the source provides a composite sync output, connect it to the **SYNC** input labeled **HOR/COMP**. If the source provides separate horizontal and vertical sync outputs, connect horizontal sync to the **SYNC** input labeled **HOR/COMP** and connect vertical sync to **SYNC** input labeled **VERT**. See Figure 2.11.

*NOTE: Depending on your source, you may need a custom adapter cable with BNC connectors at the projector end and a different type of connector at the other (such as a 15-pin "D" connector for some computer sources). Contact your dealer for details.*

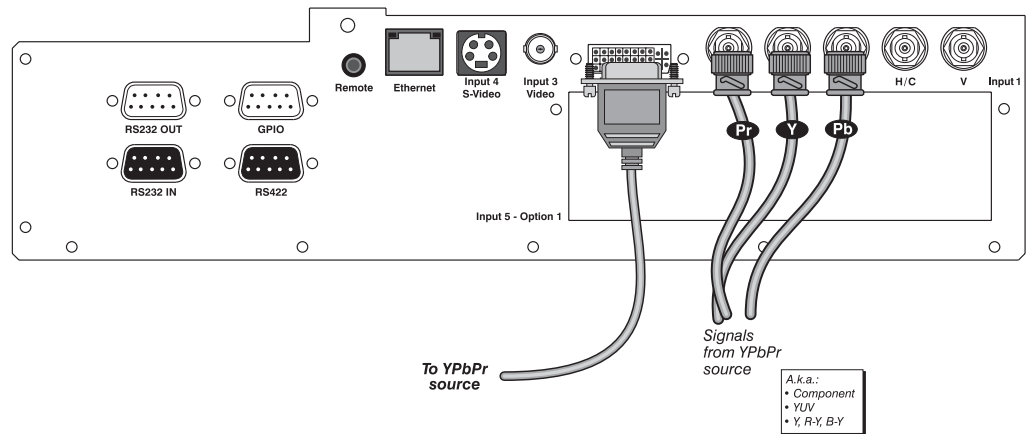


**Figure 2.11. Connecting RGB and Sync**

**NOTES:** 1) If for some reason the projector fails to recognize a signal as an RGB signal, specify the **Color Space** option within the **Image Settings** menu. See 3.7, **Adjusting the Image**. 2) To connect YPbPr signals—such as from DVDs or analog HDTV sources—to **INPUT 1**, use the red, green and blue BNCs as described in **YPbPr Signals** (below). 3) Use the computer cable provided, to connect some devices to the DVI-I connector at **Input 2**.

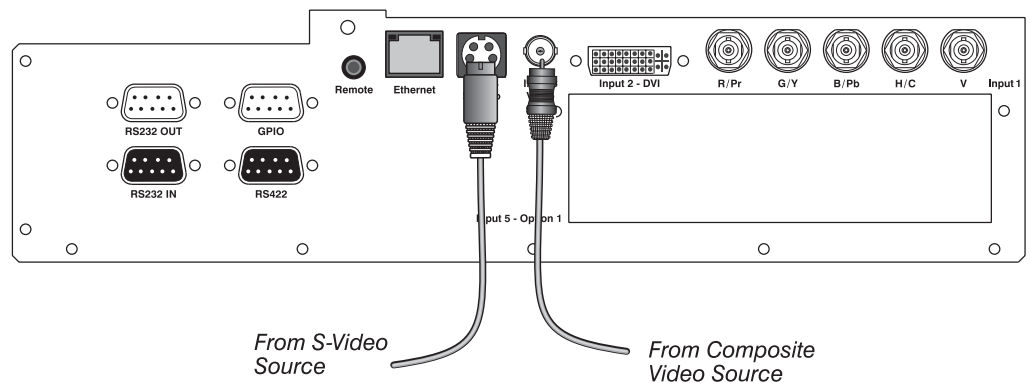
**YPbPr signals** ➤ Connect a YPbPr signal (*component video*) to **INPUT 1** or **INPUT 2** as shown in Figure 2.12.

**NOTES:** 1) If, for some reason, the projector fails to recognize a YPbPr signal, specify the **Color Space** option within the **Image Settings** menu. See 3.7, **Adjusting the Image**. 2) Do not connect digital component signals (known as YCbCr) to **INPUT 1**. Install an appropriate optional module in **INPUT 5** for this.



**Figure 2.12. Connecting YPbPr sources**

**Composite and S-Video** ➤ **INPUT 3** and **INPUT 4** provide simultaneous connection of both a composite video source (**INPUT 3**) and an S-Video source (**INPUT 4**). See Figure 2.13.



**Figure 2.13. Connecting Composite or S-Video sources**

**DVI Digital Video** ➤ Use the DVI-I connector at **INPUT 2** to connect either analog or digital video devices to the projector. When connecting devices that transmit an analog video signal such as VCRs, laptops, and PCs use the cable provided with the projector. Plug the DVI-I (single link) connector end to the projector and the 15-pin VGA connector to the device.

Use a cable with DVI-I connectors at both ends to connect devices that transmit digital and analog video signals such as high-quality DVD players, satellite receiver and digital cable TVs.

*NOTE: 1) To ensure true digital output from devices that transmit digital signals, connect to the DVI-I connector. 2) The DVI connector is HDCP compliant. 3) DVI loop through is not available unless you have the optional **DVI Input Module** installed at **INPUT 5**.*

**Optional Inputs** ➤ Optional input modules allow you to increase your total number of inputs and/or accommodate different signal types, whether analog or digital. Install in the area labeled **INPUT 5**. Options include:

- RGB 500 Input Module
- RGB 400 Active Loop Thru Input Module
- RGB 400 Buffered Amplifier Input Module
- PC250 Analog Input Module
- Serial Digital Input Module
- DVI Input Module
- Dual SD/HD-SDI Module (*available 2005*)

NOTES: See *Appendix F, Optional Input Modules* for a brief description of each interface.



## 2.4 Connecting Communications

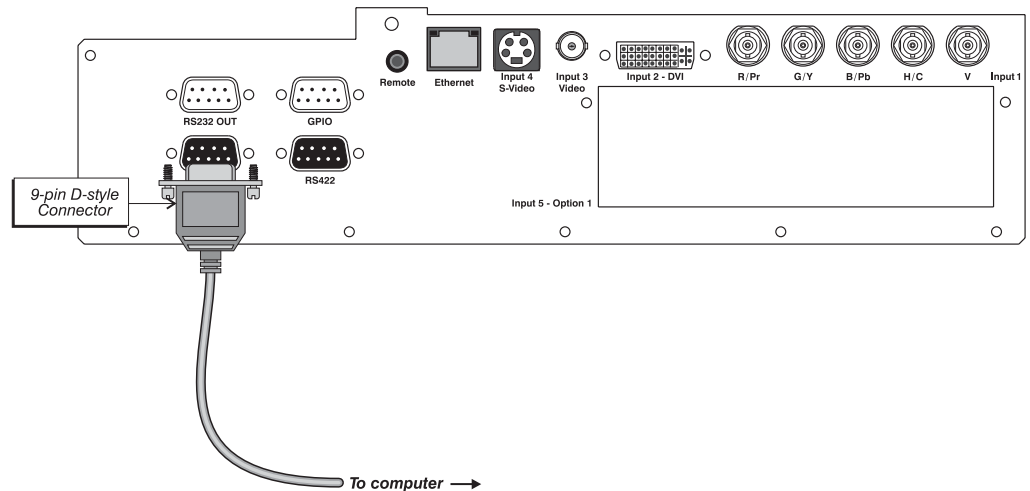
As an alternative to the projector's keypad or remote, you may wish to communicate with the projector using a PC or other controller. Such a device sends commands and receives feedback via serial links (RS232 and RS422), Ethernet or GPIO communications to the projector, all described below.

**IR Remote** ➤ As desired, direct the projector's IR remote towards the display screen or the projector's IR sensors. Alternatively, connect a wired (tethered) version of the remote to the RCA jack labeled **REMOTE** on the projector's input panel. Note that response to a wired keypad must also be enabled in the *Communications* menu—see 3.6, *Adjusting System Parameters and Advanced Controls* for more information.

**Serial Port Connections** ➤ There are two types of serial ports available on the projector: RS232 and RS422. You can connect a device with a serial interface, such as a computer to either of these connectors (not both) and control the projector remotely by entering specific serial communication commands.

### Connecting RS-232

The two 9-pin DIN connectors labeled RS232 IN and RS232 OUT on the input panel are dedicated to serial communication. Using the appropriate serial communication cables (*see Appendix C*) connect the controlling source, such as a personal computer to the RS232 IN connector. Then set the baud rate to match that of the computer. Refer to *Section 3* for details on changing the projector's baud rate.

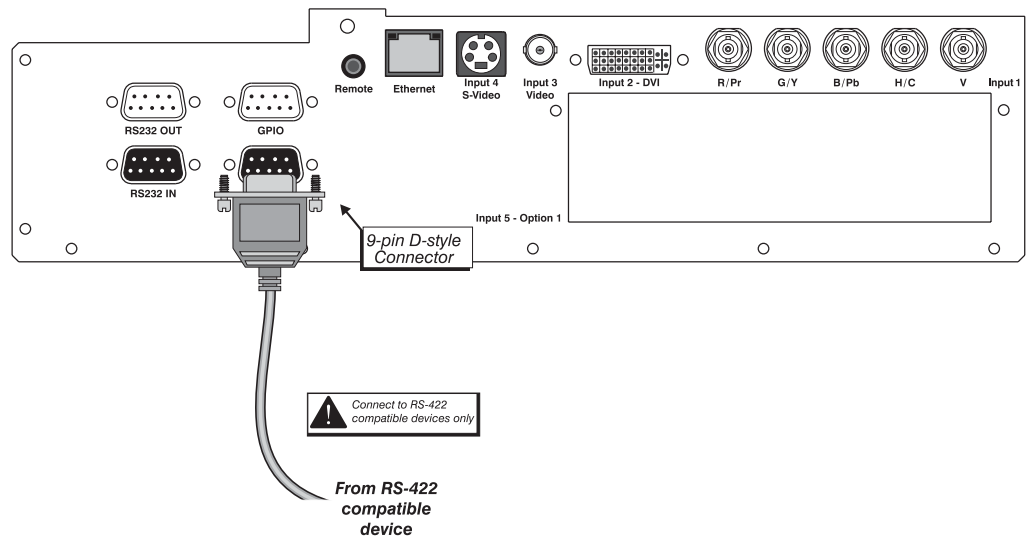


**Figure 2.14. Connecting RS232**

### Connecting RS-422

If you wish to control the projector with a computer and or other controlling device with RS-422 capability, connect a RS-422 serial communication cable between the computer and the RS-422 port on the projector. RS-422 is better suited for serial communication over long distances than is RS-232 communication.

**⚠** Use the RS-422 port only if your device had RS-422 capability – always consult the literature provided with your equipment before connecting. Connecting to the RS-422 port with incompatible equipment could damage your projector.

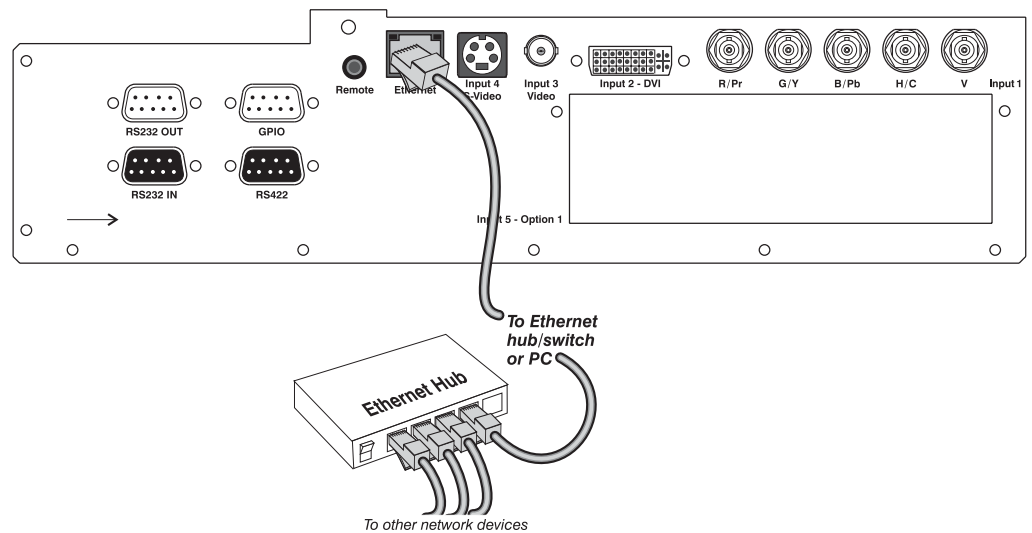


**Figure 2.15. Connecting RS422**

**Ethernet Communications**

To add the projector to an existing Ethernet network with other equipment such as controllers and other projectors, connect standard CAT5 Ethernet cable between your Ethernet controller (or hub) and the Ethernet port on the side of the projector.

**CONNECTING TO A PC:** If you are connecting the Ethernet port directly to a PC (rather than a network or hub), make sure to use a *crossover* Ethernet cable. Keep in mind that an Ethernet link cannot be used for downloading a software upgrade to the projector—use RS232.



**Figure 2.16.**

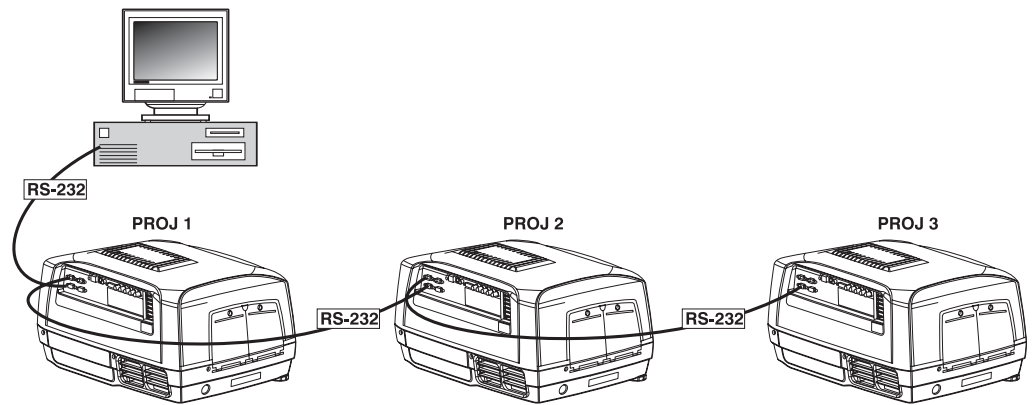
Upon connection to an Ethernet network, the projector’s factory default IP address of 0.0.0.0 will automatically enable the DHCP function (if available on the network) to assign a new IP address that is valid and unique for that network. Or, if there is no DHCP function available on the network (or if a specific static IP address for the projector is preferred or required), you can set the address in the *Ethernet Settings* menu or via an ASCII serial command.

Regardless of how it is assigned, once a projector has a valid and unique address it will respond to commands sent to this address. To determine the projector's current IP address, consult the *Status* or *Communications* menus.

Refer to *Section 3* for further information about setting up and using a projector connected via Ethernet.

### Connecting Multiple Projectors

**RS-232 NETWORK:** If you want to connect multiple projectors in a network with serial communication, connect the controlling source to the RS232 IN connector of the first projector in the network. Then take another serial communication cable and connect one end to the RS232 OUT connector and the other end to the RS232 IN connector of the next projector. Continue this pattern of connection with all projectors in the network. The last projector in the network will only have a connection to the RS232 IN connector. See Figure 2.17.

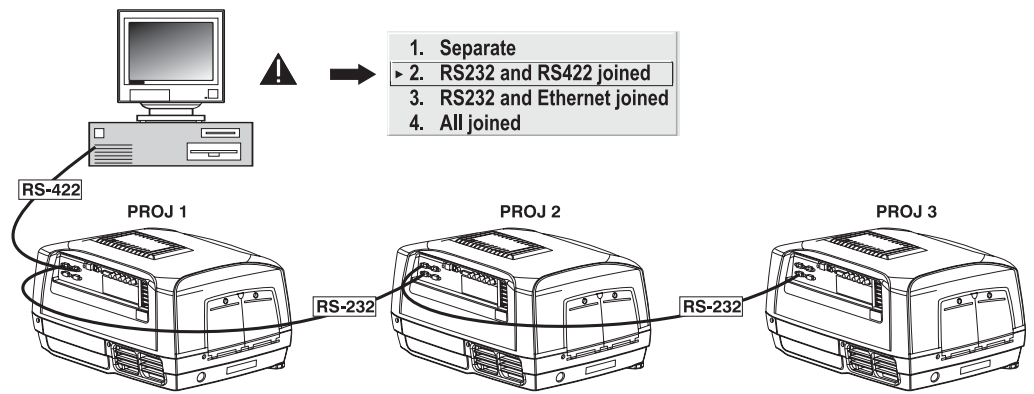


**Figure 2.17.**

**MIXED NETWORK:** To control multiple projectors with a computer/controller having an RS422 interface, first set them all to the same baud rate as your RS422 controller.

*NOTE:* You must enable this combination of RS422 and RS232 in the *Communications* menu. Set the “Network Routing” option to “RS232 and RS422 Joined”. See *Section 3* for details.

Then chain the projectors together by connecting an **RS232** port of the first projector (already connected to the computer/controller through the **RS422** port) to an **RS232** port on the next projector in the chain. Continue connecting projectors in this manner until you've reached the last projector in the chain, so that only the last projector has one unused **RS232** port. See Figure 2.18.

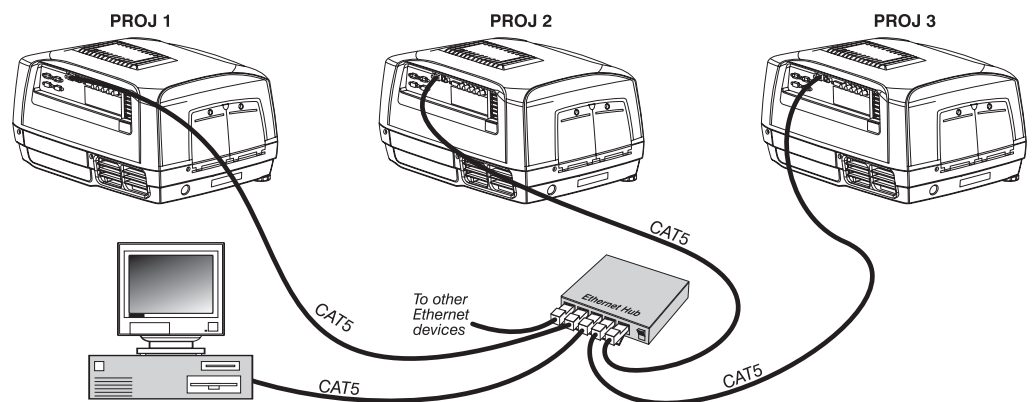


**Figure 2.18.**

Note that communication parameters such as baud rate must be set to match the particular controlling device *before* connecting as a network—refer to the documentation that came with your controlling device in order to determine the proper baud rate. See 3.6, *Adjusting System Parameters and Advanced Controls* if you need help changing the projector baud rate. In addition, set the Network Routing to “RS232 and RS422 Joined” if you want to reach all projectors.

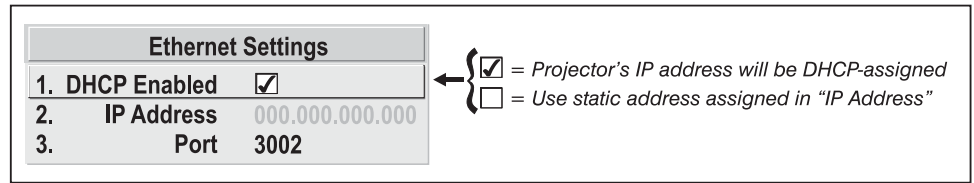
**NOTES:** 1) To avoid damage, connect only properly wired serial communication cables. See *Appendix C* for details. 2) It is recommended that each RS232 communication cable be no more than 25 feet in length. Use high quality cables.

**ETHERNET NETWORK SETUP:** To add one or more projectors to an Ethernet network, use standard CAT5 cable to connect each projector’s Ethernet port to a hub belonging to the network. A controller or PC must also be connected to the hub. See Figure 2.19.



**Figure 2.19.**

**SETTING THE PROJECTOR’S IP ADDRESS:** Upon connection to most Ethernet networks, each projector’s factory default IP address of 0.0.0.0 triggers the network’s DHCP (Dynamic Host Configuration Protocol) server function to automatically assign an IP address that is valid and unique for use on that network. Depending on the network, this DHCP-assigned IP address usually remains stable for a single session, but may change with subsequent power-ups and logins. On some networks, the address will remain stable from session to session. In all cases, the projector’s IP address and port appear in the *Status* menu as well as the *Ethernet Settings* submenu. See Figure 2.20



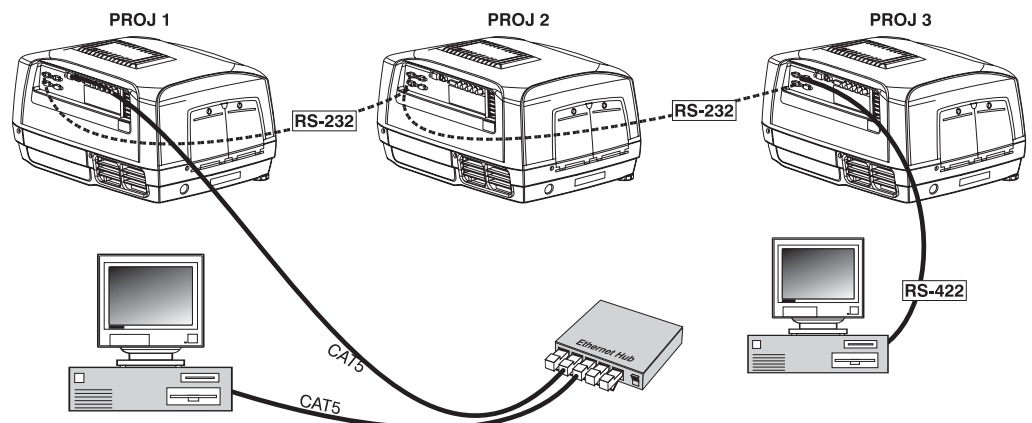
**Figure 2.20. Setting the Projector's IP Address**

Note that if a projector's IP address is anything *other* than 0.0.0.0 (shown as 000.000.000.000 in the *Ethernet Settings* menu) upon connection to an Ethernet network, or if DHCP is not available on the network, the automatic DHCP server function for supplying a valid and unique IP address to the projector is disabled. Instead, a specific and static IP address must be defined in projector memory—enter the new address in the *Ethernet Settings* submenu, or send to the projector via a serial command. The IP address will be in effect until it is changed again, or until the DHCP checkbox is re-enabled for use with a DHCP server on the network.

*NOTES: Only the port and IP address of the projector can be changed. The subnet mask is fixed (255.255.255.0).*

**CHANGING THE PORT#:** On some Ethernet networks, firewall restrictions may require that the port number of the projector be changed from its default of 3002. If so, enter a new port number in the *Ethernet Settings* menu or include the new port# in an XIP serial command sent to the projector.

- Separating Networks** ➤ By default, communications originating from one type of serial controller—RS232 vs. RS422 vs. Ethernet—stay on the corresponding network path. This separation is indicated by a “Separate” setting for “Network Routing” in the *Communications* menu. If you are using an RS422 controller, for example, it will communicate only with the projector to which it is connected unless you change this setting to either “RS232 and RS422 Joined” or “All Joined”.
- Communicating to All Ports** ➤ To relay all messages to all ports—RS232, RS422, and Ethernet—set the “Network Routing” option in the *Communications* menu for each projector to “All Joined”. This configuration is useful if you are using a non-RS232 controller with the RS232 linking available between these projectors. For example, you may want to use both an RS422-compatible controller and an Ethernet-connected PC for working with a network of projectors linked via their RS232 in/out ports (Figure 2.20).



**Figure 2.21.**

To isolate just RS422 communications, select “RS232 and Ethernet Joined”. In Figure 2.21, only projector #3 will respond to the RS422 controller. To isolate just Ethernet communications, select “RS232 and RS422 Joined”—only projector #1 will respond via Ethernet.

---

**2.5 System Integration - GPIO Connector**

The GPIO (*General Purpose Input Output*) connector on the input panel can be used to provide a method of interfacing a wide range of external I/O devices to the projector.

*Refer to Appendix E: System Integration for complete details on pin configuration and how to program the various pins on the connector.*

---

**2.6 Power Connection**

Plug the line cord to the AC receptacle located on the right hand side of the projector and the 3-pronged end into a grounded AC outlet (Figure 2.22). The input voltage to the projector must be capable of 100 – 240 VAC. (*See also Section 6 – Specifications for complete details on all power requirements.*)

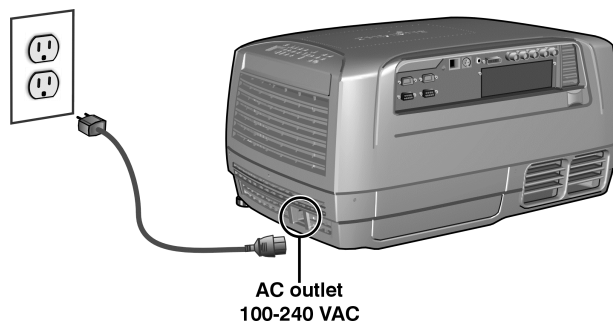
Each projector is provided with the North American and European rated line cords. Make sure you are using the appropriately rated line cord for your area.

**Always power down the projector before unplugging the AC line cord** – Once you power down, wait 2 minutes to allow the main exhaust fan to turn off and for the lamps to cool before unplugging the projector.

**⚠ WARNINGS**

**Do not attempt operation if the AC supply and cord are not within the specified voltage and power range.**

**Wait for the cooling fans to turn off before unplugging the projector.**

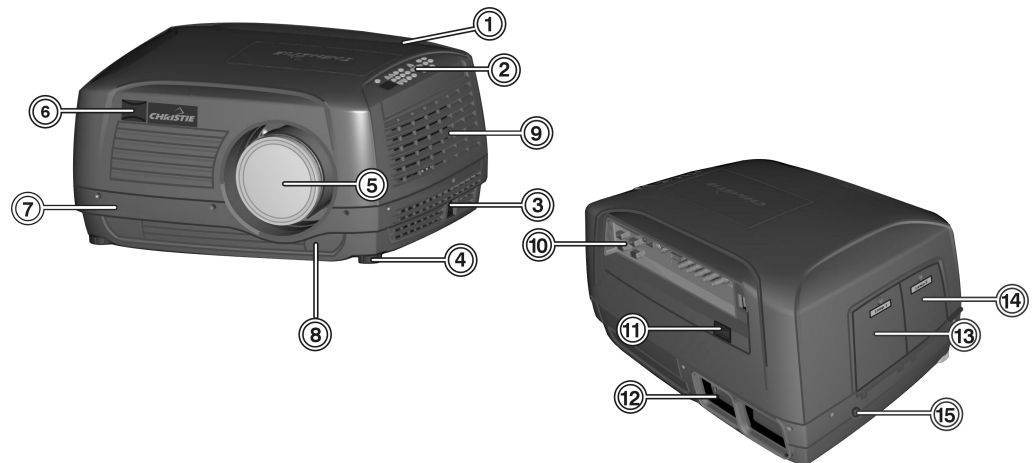


**Figure 2.22.**

# Operation

This section explains how to effectively operate the projector once it has been installed. It is recommended that you read this section and familiarize yourself with the components and the available menu options before you begin using your projector for the first time.

## 3.1 About the Projector



1	Top cover	9	Air vents
2	Built-in keypad	10	Rear input panel
3	AC receptacle	11	Rear IR sensor
4	Adjustable feet (3)	12	Rear exhaust
5	Projection lens	13	Lamp 1 Access (Door)
6	Front IR sensor	14	Lamp 2 Access (Door)
7	Bottom chassis	15	Slot for Kensington Security Lock
8	Lens release button		

**Figure 3.1. Projector Basics**

**Exterior** ➤ (1) & (7) The projector's top cover and bottom chassis form the shell of the projector. All optical, electrical, and other miscellaneous components are housed between these two parts.

**Built-in Keypad** ➤ (2) The built-in keypad is located on the top, right side of the projector. It's an alternate method to using the IR remote for projector control. It has a few less direct keys than the IR remote, but includes an LED display, which continually displays the projector's status.



- AC receptacle** ➤ (3) The AC receptacle is located on the right side of the projector (opposite side of lamp doors). Use this outlet to plug in an appropriately rated line cord. See 2.6 *Power Connection* for details.

The input voltage to the projector must be capable of 100 – 240 VAC. See also *Section 6 – Specifications* for complete details on all power requirements.

- Adjustable Feet** ➤ (4) Located on the bottom of the projector are 3 adjustable feet. You can raise or lower these feet to ensure the projector is level on all sides and the image displays rectangular without any keystone. See *Projector Position and Mounting (Section 2)* for instructions on adjusting these feet.

- Lens Mount & Projection Lenses** ➤ (5) The projector is built with a motorized lens mount that allows for easy lens control and adjustment. This includes such functions as adjusting vertical and horizontal offsets, zoom and focus. The lens mount can be fitted with any one of the available optional lenses – see *Section 6 - Specifications*.

- **Zoom and Focus** – There are two internal lens motors that allow for quick motorized adjustment of zoom and focus. Adjust zoom to fit the displayed image on the screen and adjust focus to improve the clarity of the image. *NOTE: You can manually override zoom and focus adjustments set with the remote. Turn the outer ring on the projection lens to adjust focus and the inner ring to adjust zoom.*
- **Lens Offset** – Vertical and horizontal offset is performed on the lens mount through the use of DC motors.
- **Shutter** – Standard on all models the shutter allows you to turn the screen absolutely black when in the “on” state.
- **Optical Aperture** – Enables adjustment of light output and contrast ratio.

*NOTES: 1) The projection lens is shipped separately from the projector. 2) Use the lens cap when transporting the projector to avoid scratching and damaging the lens, which could affect your displayed image.*

- Lens Release Button** ➤ (8) The **LENS RELEASE** button, located just below the projection lens, allows for a quick “tool-free” lens changeover. For instructions on how to use this button during lens replacement refer to *Section 4 – 4.5 Replacing the Projection Lens*.

- Rear Input Panel** ➤ (10) All source connections are made to the input panel located at the back of the projector. Connect RGB or YPbPr sources to **INPUT 1**, analog or digital display signals to **INPUT 2**, composite video to **INPUT 3**, and S-video to **INPUT 4**. **INPUT 5** is where you would install any of the available optional input modules.

There is no status display on the input panel. The only status display is part of the built-in keypad located on top of the projector.

- Cooling and Air Vents** ➤ (9) There are numerous air vents located around the projector. It is important these vents remain unobstructed. Allowing adequate airflow through the projector will prevent it from overheating.

**NOTE:** ▲ *Stand clear of the rear exhaust air path during operation. In the unlikely event of a lamp explosion, glass particles can be blown out of these vents.*



- Front & Rear IR Sensors** ➤ (6) & (11) The two IR sensors located on the projector receive transmissions from the IR remote from up to 100 feet away. It is important to keep the transmission path to these sensors unobstructed for uninterrupted communications with the projector. The front IR sensor is located next to the projector's nameplate and the rear IR sensor is located just below the input panel.
- Lamp Access Doors** ➤ (13) & (14) Located on the right hand side of the projector are two lamp doors that are labeled as Lamp #1 or Lamp #2. Each door is fitted with an amber window that makes it easy to identify which lamp because it will glow. *NOTE: It is important to always check the status of the lamp before opening the lamp door. Opening a lamp door while the lamp is still on will cause power to be cut to that lamp.*
- Kensington Security Slot** ➤ (15) Use the following slot to install a standard Kensington lock to keep your projector secure in some installations.

## 3.2 Using the Remote or Built-In Keypad

**⚠ Laser radiation is emitted from the laser diode in the remote. Do not look directly into the beam of the remote.**

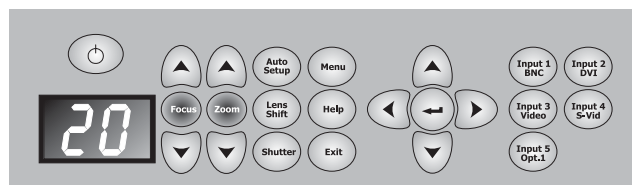
**Keypad Commands** ➤ The projector is typically controlled using one of the following keypads:

- **Built-in Keypad** located on the top, right edge of the projector
- **IR Remote** for wired or wireless control up to 100 feet away (includes cable for use as a wired remote)

While each of the keypads provides complete control of the projector, they differ slightly in their arrangement of keys and in what functions can be accessed directly with a key press rather than requiring use of the menu system. You may find one keypad more convenient than another for your specific installation and application.

*NOTE: The IR remote has a single IR protocol. It can be converted to a wired IR remote by connecting the cable provided with the projector to the mini stereo connector labeled **REMOTE** on the input panel.*

**Built-in Keypad** ➤ To control the projector when signals from an IR remote cannot reach the projector, use the projector's built-in keypad. Two nearby status windows provide feedback indicating current status and activities of the projector.

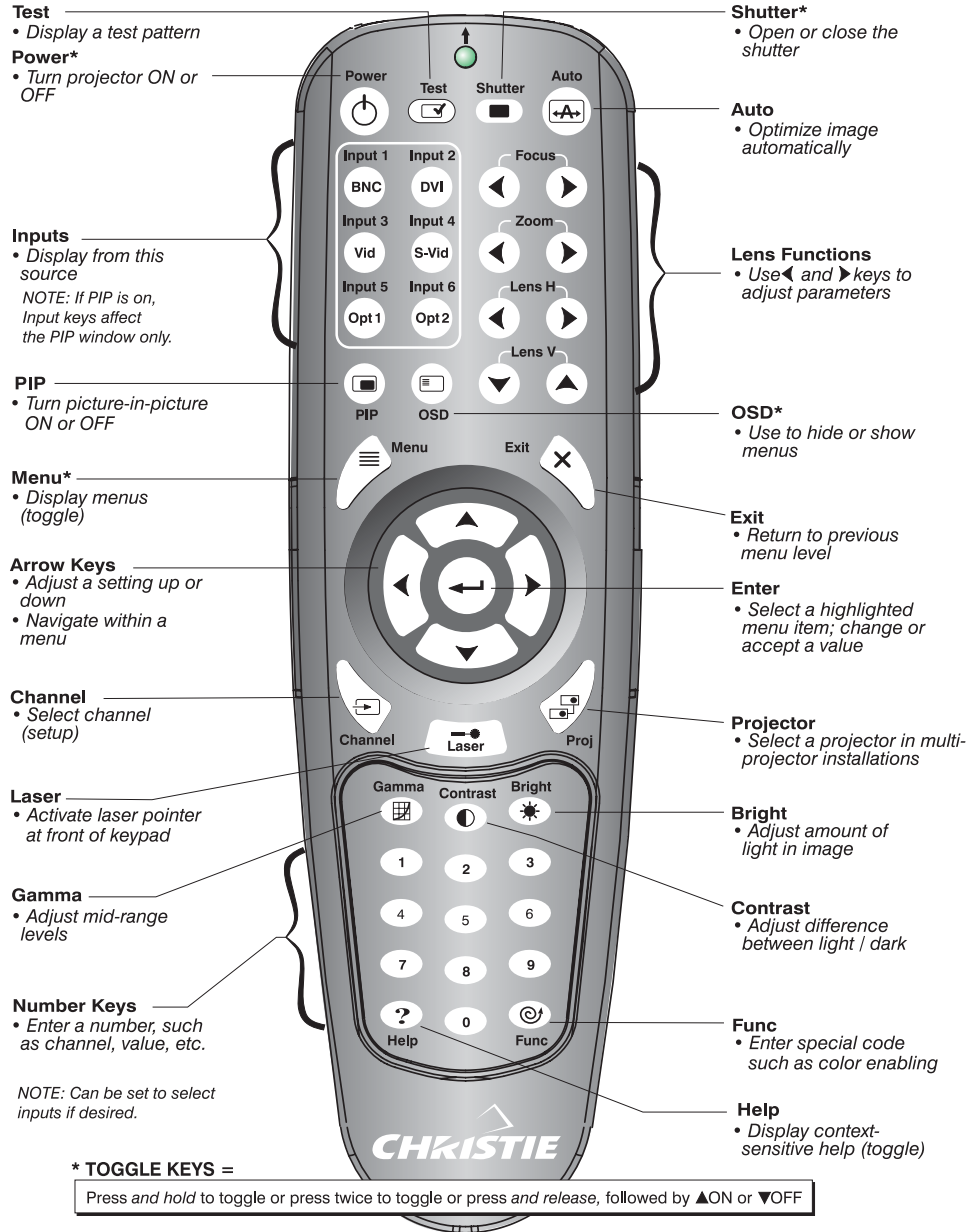




**Figure 3.2. Built-in Keypad**

Because the built-in keypad has fewer keys than the remote control, certain projector functions are accessible only through the menu system rather than via a direct key.

Refer to the key descriptions provided for the IR remote.

**IR Remote** ➤ The IR remote controls the projector by way of wireless communications from a battery-powered infrared (IR) transmitter. Use the IR remote the same way you would use a remote control supplied with a TV or VCR. When making key presses, direct the keypad either toward the screen or toward the front or rear of the projector. One of the two IR sensors on the projector will detect the signals and relay the commands for internal processing.



\*These are toggle keys, which require you to press and hold or press twice or press and use the up/down arrow keys. NOTE: To turn the OSD off you must press  and .

**Figure 3.3. IR Remote**

- Wired IR Remote** ➤ You can convert the IR remote into a wired IR remote using the cable provided with the projector. Connect one end into the remote and the other to the mini stereo connector on the input panel labeled **REMOTE**. The wired remote is recommended when:
- *the built-in keypad is inaccessible*
  - *the lighting conditions are unsuitable for proper IR transmission*
  - *NOTE: Leave the batteries in the wired remote for the laser key (⊖) to work.*

- Guide to Keypads** ➤ Keep in mind the following guidelines when using the keypad:
- Press keys one-at-a-time; there are no simultaneous key combinations required.
  - Note that three keys— Power (⏻) Shutter (Shutter) and OSD (OSD)—are “press-and-hold” keys that do not function with a typical quick press-and-release key press.
  - Hold arrow keys down for continuous adjustment/movement in one direction. In serial networks, pause briefly between adjustments to ensure that more distant projectors can “keep up” with the commands.
  - If you press a key while the projector is still responding to the previous action, such as during power-up, the second key press may not take effect.

- Keypad Commands** ➤ Specific keypad commands are explained below:

**⏻ Power ON/OFF**

Press (⏻) for two seconds to toggle the projector on or off with a single keystroke. Or press and release (⏻) followed immediately by (▲) (on) or (▼) (off) to guarantee the correct toggle (useful if you are unsure of the present state). Alternatively, press (⏻) (⏻) to toggle from the present on/off state.

*NOTES: 1) After powering down, the lamp cooling fan remains on for approximately 2 minutes to cool the lamp. 2) It is a good idea to avoid turning a projector back on until it has been off for a few minutes. Hot re-strikes of the lamp may reduce lamp life. 3) The projector enforces a 90 second wait between powering off and on again to allow the lamp to cool down. You will notice vertical scrolling bars across the status display during this wait period.*

**Test**

Press (Test) to step forward through all internal test patterns and eventually the current input. If you press (Test) and then cycle by using the (◀) and (▶) arrow keys, you'll be cycling in either direction through the test patterns only, no input.

**Auto**

Press (Auto) to initiate an automated process in which the projector optimizes critical display parameters such as size, position, pixel tracking, etc., for the current source. These parameters are listed in Table 3.1. An *Auto Setup* can save time in perfecting a display, and you can modify the adjustments as desired.

**Table 3.1. Auto Setup**

What an “Auto Setup” Does	
OPTIMIZES:	SETS TO DEFAULT:
Pixel Tracking	Contrast
Pixel Phase	Brightness
Size and Blanking	Auto Input Level (off)
Vertical Stretch	Detail (if video source)
Position	Filter
Input Levels	Luma Delay

*NOTE: You must have an unlocked channel present to use Auto Setup.*



**Channel**

Press to select a specific source setup (*channel*) defined and stored in projector memory. Once you enter a 2-digit channel number (or, if there is a list displayed, highlight it and press ) , the display will automatically change and update according to the numerous setup parameters defined for that channel. Note that a new channel is automatically created if you adjust an image from a new source.

*NOTE: Channel key behavior during a presentation depends on whether or not the **Display Channel List** option is enabled in the **Menu Preferences** menu. You can choose to use a scrollable list of channels when you press , or you may prefer to enter the desired channel number “blind”, i.e., without on-screen feedback. See **Menu Preferences** later in this section.*



**Input 1**

Press to display from the data or video input source connected to BNCs labeled **INPUT 1**.



**Input 2**

Press to display from the DVI source connected to **INPUT 2**.



**Input 3**

Press to display from the composite video source connected to **INPUT 3**.



**Input 4**

Press to display from the S-video source connected to **INPUT 4**.



**Input 5**

Press to display from the **INPUT 5** interface module installed in the Option 1 slot.




*NOTE: If you have the new optional **Dual SD/HD-SDI Module** installed at **INPUT 5** you can connect two inputs – A and B. Whether you are displaying from **INPUT 5** or from another input, press to display the input last used. Press again to toggle to the other input.*






**Input 6**

*No function.*

 **Contrast**

Press  to change the amount of white in your images. Use   keys until you reach the desired level of contrast—for best results, start low and increase so that whites remain bright but are not distorted or tinted, and that light areas do not become white (i.e., “crushed”). Conversely, low contrast causes dim images. See 3.5, *Adjusting the Image (Image Settings subsection)*.

 **Brightness**


Press  to increase or decrease the amount of black in the image. Use   keys until you reach the desired level of contrast—for best results, start high and decrease so that dark areas do not become black (i.e., “crushed”). Conversely, overly high brightness changes black to dark gray, causing washed-out images. See 3.5, *Adjusting the Image (Image Settings subsection)*.

 **Gamma**



“Gamma” determines how gray shades are displayed between minimum input (black) and maximum input (white) for a given amount of signal. The proper setting helps maintain optimized blacks and whites while ensuring a smooth transition for the “in-between” values utilized in grays. Unlike brightness and contrast controls, the overall tone of an image can be lightened or darkened without changing the two extremes, and your images will be more vibrant yet with good detail in dark areas.






The normal gamma setting of 2.2 is correct for most signals and conditions. If excess ambient light washes out the image and it becomes difficult or impossible to see details in dark areas, lower the gamma setting to compensate. This will improve contrast ratio while maintaining good details for blacks.

 **Menu**

Press  to enter or exit the projector’s menu system.

 **OSD (On-screen display)**

Press  followed by  to hide the projector’s menu system during use. To see the menus again, do one of the following:

- Press *and hold*  for a second
- Press and release  followed immediately by 
- Press  

Invisible menus are fully functional, enabling “hidden” access to numbered features and image adjustments by entering the corresponding sequence of keypresses on the keypad.

*NOTES: 1) With OSD “on”, you can still hide error messages and slidebars by disabling these options in the **Menu Preferences** menu.*

**Shutter**

Press *and hold* **Shutter** for two seconds to toggle the internal mechanical shutter blade closed or open with a single keystroke, or press and release **Shutter** followed immediately by **▲** (closed) or **▼** (open) to guarantee the correct toggle (useful if you are unsure of the present state). Alternatively, press **Shutter Shutter** to toggle from the present on/off state. A closed shutter blanks the display (turns it to black). Close the shutter to mute the display while maintaining access to projector functions. Opening the shutter restores the image.

*NOTES: 1) By default, the shutter is open upon powering up. 2) The LED status displays “5H” when the shutter is closed. 3) Response time after pressing the **Shutter** key is 1-2 seconds.*

**Function Key**

**IF WITHIN A MENU:** Using the **Func** for special tasks within the menu system is noted with the appropriate topic elsewhere in *Section 3*. For example, press **Func** in the *Channel Setup* menu to enable deletion or copying of a channel.

**IF WITHIN A PRESENTATION:** Press **Func** followed by a 2-digit number to enable a specific color or colors in the display (see right). For example, **Func 6 4** will display only red and green data, **Func 6 7** will display all color data. Eliminating one or more colors can help with certain diagnostics and setups, such as when accurately overlaying one image on top of another from stacked projectors.

- Func 6 1** = Red
- Func 6 2** = Green
- Func 6 3** = Blue
- Func 6 4** = Red & Green
- Func 6 5** = Green & Blue
- Func 6 6** = Red & Blue
- Func 6 7** = All Colors

*NOTE: Color enabling can also be implemented from numerous locations within the menu system.*

**Projector**

Press **Proj** to access a specific projector within a group of projectors or to confirm if the local projector is listening. The number in the “Enter Number” window indicates which projector is currently listening to commands, and will match the projector number that has been defined in the *Menu Preferences* menu.


The “Projector” checkbox (read-only) shows whether or not the projector physically connected to a keypad is listening to commands from that keypad. A checkmark means that connected projector is listening; if there is no checkmark, you are communicating with a different projector.

To control a specific projector with the keypad, enter the 3-digit number assigned to the projector you want to use. If you switch to a projector other than the one you are currently using, the checkmark will disappear.


To broadcast to multiple projectors, press **Proj** and then **Proj** again *without* entering a projector number. Keypad commands will then affect all projectors present. Note that there is no method of controlling a *group* of projectors within the same wired configuration using the wired IR remote exclusively, since there is only one wired protocol available.


**NOTES:** 1) The "Broadcast Keys" option in the Communications menu must be selected for only **one** (any) projector in a serial network. The keypad in use must be OFF (disabled) for the remaining projectors. See also 3.6, **Adjusting System Parameters and Advanced Controls**.

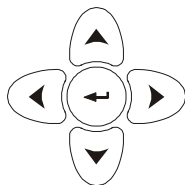
### **Enter**

Press  to select a highlighted item, to toggle a checkbox, or to accept a parameter adjustment and return to the previous menu or image.



### **Exit**



Press  to return to the previous level, such as the previous menu.

**NOTE:**  does not save changes within text editing boxes (including number editing of a slider value) or within pull-down lists. It acts as a "cancel" in these cases.







### **Arrow Keys**









Use the   keys to change a slider value or to select a different option within a pull-down list without having to first scroll through options. These keys also jump to the next page in long menus. See also *Editing Text* later in Section 3.


Use the   keys to navigate within a menu, pull-down list or text box. Use in combination with power, shutter and OSD keys to force the corresponding state. See details provided on the back of the IR remote.






### **Lens Focus, Zoom and Lens H, Lens V**

When adjusting the image for focus, zoom, horizontal and vertical positioning, use the specific arrow keys (/ or /) related to each function. A small window will appear to indicate the type of adjustment taking place. For example,



- Use the "Focus"  or  keys to improve image clarity as desired.
- Use the "Zoom"  or  keys to achieve a desired image size.
- Use the "Lens H"  or  keys to position the image horizontally while still keeping it rectangular.
- Use the "Lens V"  or  keys to position the image vertically while still keeping it rectangular.


Press  to return to presentation level.

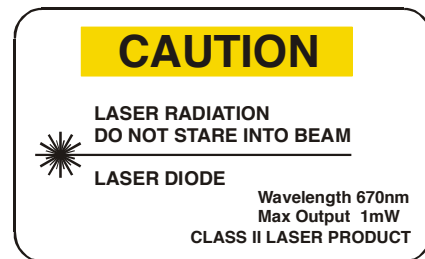
**NOTE:** Use the  key (built-in keypad) with the general   keys to get the same effect as if using the arrow keys related to "Lens V" or "Lens H" on the IR remote.




 **Laser**





Press  to activate the laser pointer on the remote. This feature is useful when making presentations - just point the remote at the screen to highlight an area of your presentation. Keep the  key depressed while you are pointing. Release it to turn it off. The laser pointer works best in an environment where ambient lighting can be controlled.

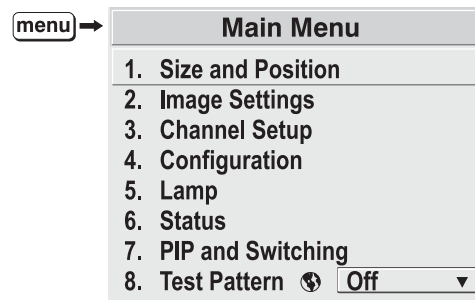
*NOTE: The batteries must be in the wired IR remote for the  key to work.*






**3.3 Navigating the Menus**

Most of the controls for the projector are accessed from within the projector’s menu system. There are several groups of related *functions*, with each group selectable from the *Main* menu as shown at right. Press  at any time to display this *Main* menu.

On the IR remote, either enter the number corresponding to the function menu you wish to access, such as  for the *Image Settings* menu, or use the   keys on any keypad to highlight the desired option, then press . The corresponding function menu or pull-down list of further options will then appear.







**Figure 3.4. Entering the Menu System**

With a function menu displayed, navigate in a similar manner—enter a menu option number for any numbered option or use the   keys to highlight the desired option, then press  (Enter). Extra long menus have a scroll bar on the right—use the arrow keys to access the remainder of the menu. Locked items or items that do not pertain to the current action or condition appear dimmed and cannot be selected.

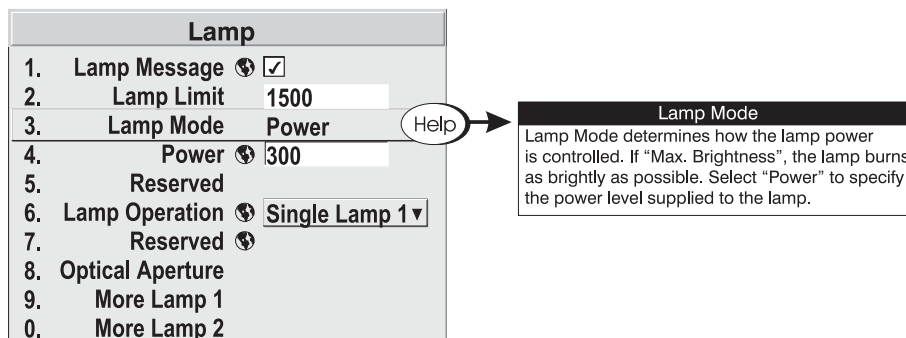
*NOTES: 1) If there is no signal present, all source-dependent adjustments are disabled. 2) After 15 minutes of inactivity, the projector leaves the menu system and returns to the presentation. 3) The **Status** menu is read-only.*

When finished with a function menu, do one of the following:

- Press  to return to the previous screen
- Press  to leave the menu system and return to the presentation

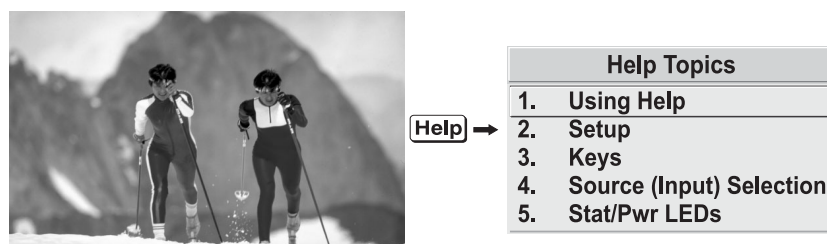
**On-line Help** ➤ If at any time you are uncertain what to do next, press  to display summary information about the current menu or highlighted option. Press  again to exit. In addition, a line of “hint” text is included at the bottom of some menus.





**Figure 3.5. Context-sensitive Help**

From presentation level, press to access general *Help Topics*. Scroll as necessary within a topic. Press or to return to your presentation.



**Figure 3.6. Accessing General Help Topics**

**Time-outs** ➤ If a sidebar, menu or message is displayed you have limited time in which to make a keypad entry before the projector returns to presentation level and the graphic disappears. These time-outs may vary depending on what is displayed.

**The Global Icon** ➤ Menu options that include this icon apply universally to any incoming signal.



**Using Slidebars and Other Controls** ➤ Most of the function menus allow you to change settings by using slidebars, checkboxes, and pull-down lists. To select a sidebar, toggle a checkbox status or view a pull-down list, do one of the following within the function menu:

- Enter the menu option number corresponding to the setting you wish to change (for example, press to select Vertical Stretch in the *Size & Position* menu).
- Or move the highlight to the option desired and press (Enter).
- Or move the highlight to the option desired and press to adjust immediately.
- Or bypass the menus entirely and use a single key to immediately access an adjustment during your presentation (*NOTE: applies only to options having their own key, such as Contrast, Brightness, Gamma, etc.*).
- For "blind" access, hide the entire menu system (see OSD key, above) and/or direct slidebars activated by their own key (such as Contrast, Brightness, etc.). Control by using the proper keypress or numerical sequence of key presses.
- When using PIP images, use key to adjust the other image.

Once selected, change the setting as desired (see below) and press to save and return to the current function menu.

**Slidebars in menus** – The current value for a given parameter, such as size or vertical stretch, appears to the left of its slider icon (adjustment window). This number often expresses a percentage, or it may have units associated with it (such as pixels, degrees Kelvin, etc.), depending on the specific option. Press to gradually adjust the setting up or down—both the number and the length of the bar change accordingly. Hold for continuous adjustment. Or press to activate a slider text box for specific number entry via the keypad, then press to save (or press to cancel).



**“Direct” slidebars** - For quick access, you can access Gamma, Brightness, and Contrast slidebars without traveling the menu system. For example, simply press to immediately display the same contrast slider accessed with the Contrast option in the *Image Settings* menu.

Use the arrow keys to adjust a direct slider, or press and enter a specific number from the keypad, then or or to save (or to cancel). When you are done, press to save and return to your presentation.

*NOTES: 1) You can still adjust a direct slider as usual if the display is turned off (see or **Menu Preferences** menu) — the slider just won't be visible. 2) A direct slider disappears if it is not used within 5 seconds.*

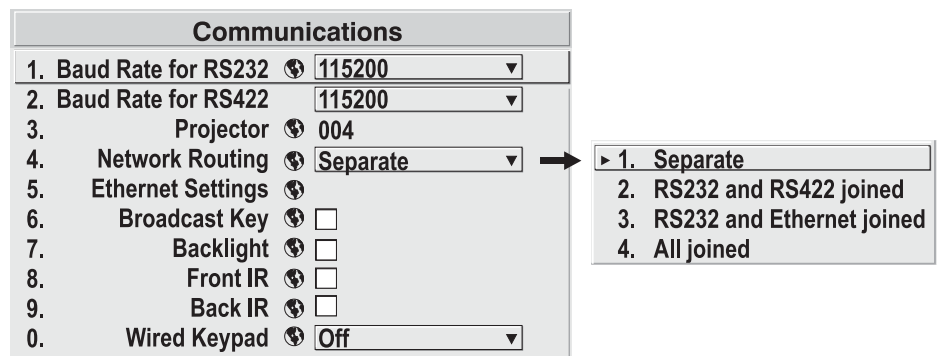
**Checkboxes** - Conditions are present if its adjacent checkbox contains a checkmark. To toggle the checkbox, simply highlight and press , or highlight and use to check and to uncheck. If a checkbox is numbered, simply enter its number to immediately toggle the checkbox.



**Pull-down lists** – To see a pull-down list of options available for a given parameter labeled with a ▼, you can:

- Highlight it and press (Enter)
- Or enter the menu option number.

Use or keys to navigate up and down within the list (the current choice is noted with a small ►). Press to choose an option from the list, if desired.



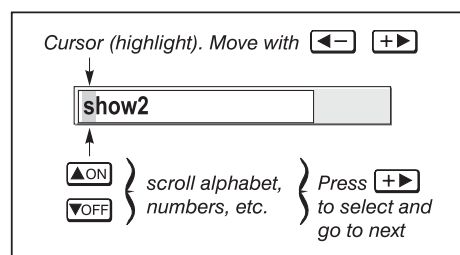
**Figure 3.7. Example of Pull-Down List**

If you prefer to quickly scroll through a list without first pulling it down, highlight the option and use . Press when the desired choice appears.

**NOTES:** 1) Press or to jump between pages in an extra long pull-down list.  
2) Press while in a pull-down list to **cancel** any change.

**Editing Text** ➤ **ACTIVATE THE EDIT WINDOW:** To enter or edit text, highlight the desired parameter (such as a channel name) and press to activate its adjacent edit window. Any previously entered text is displayed with its first character highlighted in a square cursor, signifying that this character is ready for editing.

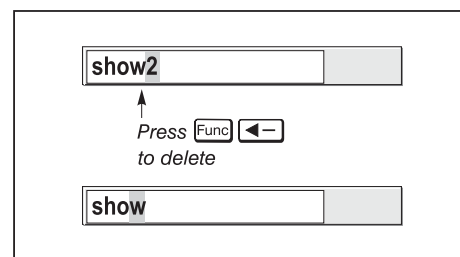
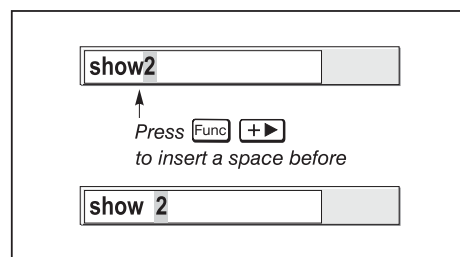
**NAVIGATE WITHIN THE EDIT WINDOW:** Press to move the cursor forward or to move the cursor backwards as desired.



**Figure 3.8. Entering Text**

**EDIT A CHARACTER:** To edit a highlighted character, use and to scroll through the alphabet, numbers, spaces and punctuation available. When the character you need appears, press to select it—the cursor will move to the next character of current text, if present. Note that you can also enter a number directly from the keypad—it will be accepted and the cursor will move on.


**ADD OR DELETE A CHARACTER OR SPACE:** To insert a space at the cursor location, press . To delete a highlighted character (or space), press .



**PRESS (ENTER) WHEN FINISHED:** To accept edits and leave the edit window, press (Enter).

**NOTE:** Press at any time to cancel changes and return to the previously-defined text.

**Editing Numerical Values** ➤ Enter numbers directly from the keypad in order to specify numbers representing projectors, channels (source setups) or slots. As each digit is entered, it is displayed and the cursor moves on. Note that channel numbers are defined with 2 digits—for example, if you enter only a single digit (such as “7”) for a channel number, the channel will automatically be defined as “07”. Enter “07” to utilize this channel.


**NOTES:** 1) Once you enter the first digit, this digit replaces all old digits. 2) If you press any non-numbered key, the number entered up to that point is accepted and updated as the new value. 3) Press  to cancel editing of numerical values.






### 3.4 Using Inputs and Channels

**NOTE:** See Section 2, *Installation and Setup*, for details on connecting sources to the projector.


The projector stores and automatically recalls up to 50 different channels (source setups) for a variety of inputs. This memory feature allows you to define and conveniently use a wide variety of customized setups rather than having to repeatedly re-configure the projector for different presentations. Depending on what you have defined, each physical source connection (i.e., input at the projector) can have several different channels associated with it.

#### Do I Select an Input Or a Channel? ➤




**INPUT** – An input is a source physically connected at the projector.  describes the source signal according to which *input slot* it is connected.


**SWITCHING INPUTS** – Press the appropriate “direct” key — , , , ,  to quickly display from one of the five inputs connected. The image will be displayed according to the following:


**If it is the first time you have used the source/input** (or if you used the input but did not define a channel by adjusting anything), the projector will recognize the new input signal based on its frequencies and polarities, and will automatically display an image according to default settings for such a signal. In general, the image from the new source will be as large as possible without losing its aspect ratio. This and other default image settings depend on the incoming source.

**If you used the source once before and changed a display parameter** such as contrast, V-Position, etc., then a channel was automatically created and still exists in projector memory (see below). Using one of the  keys will automatically recall this channel—and all its setup parameters—and update the display accordingly.

**If more than one channel exists** for the input, the image will be displayed according to the setup parameters for the first channel with matching characteristics.

**CHANNEL** - A channel is a collection of measurements, locations and settings that tailor the display of a signal to your specific needs. Since source types and applications can vary greatly, you will likely want to adjust and define a wide variety of parameters, such as brightness, contrast, size, etc., in order to customize and optimize the display from or for a particular source. For example, the display settings you choose for a VCR source may be very different from those you choose for a high resolution computer source, or one signal may simply vary from another signal used previously through the same input location. Once you have adjusted a display parameter, such as pixel tracking or contrast, all current settings are collectively stored in the projector's memory as a unique 2-digit channel, such as  . You can have numerous distinct channels available for the same input, any of which can be selected by using the  key on the keypad followed by the 2-digit channel number.

Shown at right is a sample channel list as would be available from . This is typically called the *channel list*.

**NOTE:** The  key may display a channel list or not, depending on what you have defined for “Display Channel List” (see **Menu Preferences** later in this section).

In order to access channels by using on the keypad, you must first create the channels. See below.






chan				
Channel: 02				
01	0,2	pDig	64.09k+	60.12+
02	0,1	i3LG	33.72-	59.94-
03	0,4	iSVid	15.73k-	59.94-
04	0,3	pCVid	15.73+	59.94+
05	0,1	p4WH	Fred's computer	

↑ channel#    ↑ input    ↑ signal type    ↑ H and V frequencies, or channel name

**Channel List**


### Creating a New Channel – AUTOMATIC –

To use a new source with the projector, a new channel must be added to projector memory so that the projector will respond properly to an input signal from that source in the future. A new channel can be created automatically, as described here, or it can be copied from an existing channel and then edited as necessary (see *Copying or Deleting Channels* later in this section).

When you select a direct input (, , , , ) , any existing channels in the projector are searched for matching input and signal parameters – this only occurs if Auto Source is enabled on these channels. If no match to the incoming input signal is found in currently-defined channels, a new channel is temporarily created based on factory-defined defaults for this type of signal. The *channel number* assigned is the lowest available number from 01-50.

**NOTES:** 1) An automatic channel will be discarded unless one or more of its parameters are changed, and will not appear in the channel list (see below). 2) If two channels have the same distinguishing source characteristics except for the reversal of sync connectors (i.e., H-sync and V-sync, are switched), they are still defined as distinct channels. 3) You cannot define a new channel without an incoming signal.

If the incoming signal *does* match an existing channel, the image will be set up and displayed as usual according to the parameters currently defined for that channel.

**USING A CHANNEL:** You can normally select a channel at any time by pressing  (see right). If you want to prevent a channel from appearing in this list, you must edit the channel as described in *Channel Edit* later in this section.

chan				
Channel: 01				
01	0,2	pDig	Display1	
02	0,1	p4WH	xga	
03	0,4	iSVid	Display3	

↑ channel#    ↑ input    ↑ signal type    ↑ channel name (or freq.)

**TO CHANGE CHANNEL:**

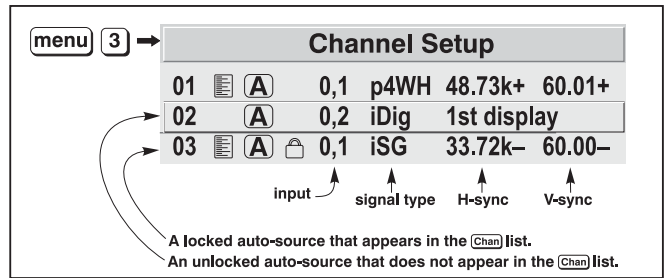
- Enter 2-digit channel#
- or
- Move highlight and press **Enter**

**NOTES:** 1) The current channel is highlighted upon entering the channel list, or, if this channel is not displayed here, the first channel in the list is highlighted. 2) Channels created automatically do not appear in the channel list unless a parameter for the channel has been changed.

**What Channels Are Defined So Far?**

➤ All available channels are listed in the *Channel Setup* menu, which describes how each channel can be accessed and which serves as the gateway for editing, copying and deleting channels.

From the presentation level press **Menu** to display the *Main* menu. To display the *Channel Setup* menu, press **3**, or move the highlight to the *Channel Setup* option and press **Enter**. The *Channel Setup* menu will appear (see sample at right), with the active channel highlighted.



**Figure 3.9. All Channels Appear in the Channel Setup Menu**

**WHAT APPEARS IN CHANNEL SETUP MENU?** This menu lists all channels defined so far and indicates where they are connected on the input panel. The far left column lists channel numbers currently defined. The values in the far right columns indicate horizontal and vertical frequencies—if someone has defined a name for this channel, it appears here instead. Remaining columns contain details pertaining to each channel setup, such as its switcher number (always 0 = projector), slot location, a variety of icons indicating access to each channel, and an abbreviated description of each signal type. See *Editing a Channel Setup* for details.

[List Icon]	Appears in (Chan) list
(A)	Auto-source
[Lock Icon]	Locked

*NOTE:* If you have more than a handful of channels, use **Left Arrow** and **Right Arrow** to see the remaining channels not visible in the initial display of channels.

**SIGNAL TYPE** — Either channel list, whether the **Channel** key list or the *Channel Setup* menu, identifies signal types in a shortened form as defined below. These descriptors indicate what signal information the projector uses to identify a match for a given channel, and are preceded by either an “i” (interlaced signals) or “p” (progressive signal“). See Table 3.2.

**Table 3.2. Abbreviations for Signal Type**

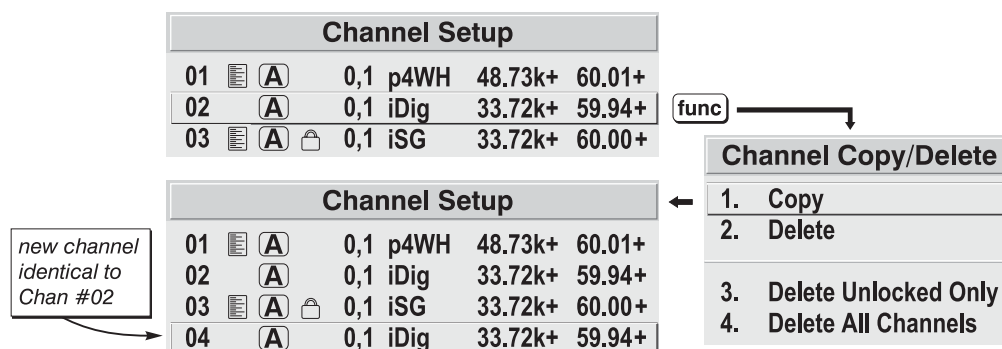
Abbrev.	Signal Type
4WH	Composite (4 wire) on HC input
4WV	Composite (4 wire) on V input
SG	Sync-on-green
5W	Separate H,V
5WR	Separate H,V swapped
SVid	S-Vid
CVid	Composite Video
Dig	Digital

**FUNCTIONS WITHIN THE CHANNEL SETUP MENU** —To copy, delete or edit a channel, highlight the desired channel in the *Channel Setup* menu and do one of two things:

- Press **Func** if you want to copy the selected channel or delete this or other channels. See *Copying or Deleting a Channel* below.
- Press **↔** if you want to edit channel setups (i.e., non-image related parameters) for the selected channel. See *Editing a Channel Setup*, below.

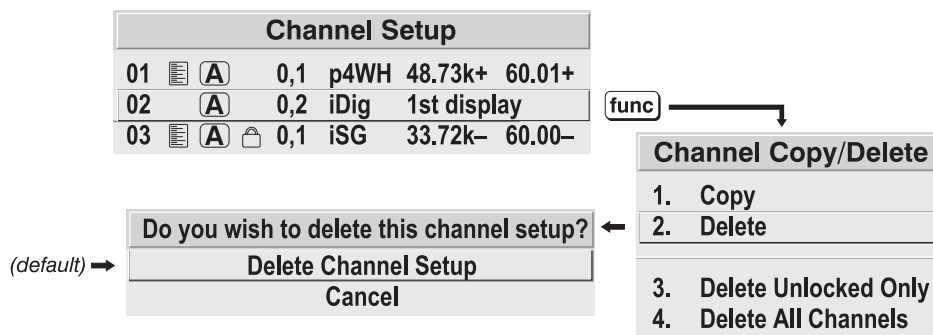
### Copying or Deleting Channels

**TO COPY A CHANNEL**, highlight the desired channel in the *Channel Setup* menu, then press **Func** to go to the *Channel Copy/Delete* submenu. Select “Copy” and press **↔** —a new channel will be created. It is identical to original, which still remains, but it is identified with the next available number from 01-50. If you change your mind and do *not* want to copy the current channel, press **Exit** to cancel and return to the previous menu. Copying channels is a quick method for creating numerous channels, each of which can then be edited and adjusted for a variety of presentations in the future.



**Figure 3.10. Copying A Channel**

**TO DELETE A CHANNEL**, highlight the desired channel in the *Channel Setup* menu, then press **Func** to activate the *Channel Copy/Delete* submenu. Select “Delete” and press **↔** —a confirmation window will appear to make sure that you really want to delete this channel.



**Figure 3.11. Deleting a Channel**



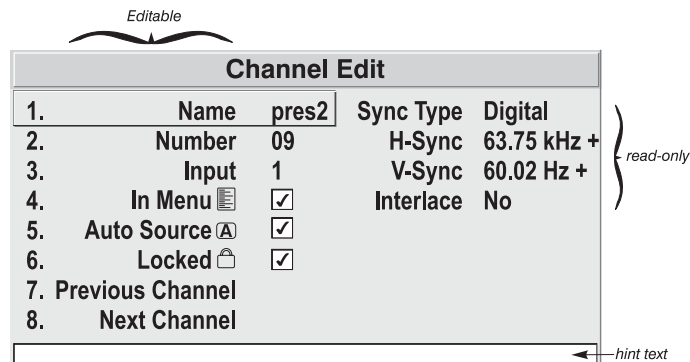
**TO DELETE MULTIPLE CHANNELS**, highlight any channel in the *Channel Setup* menu and press **Func** to go to the *Channel Copy/Delete* submenu. Select “Delete Unlocked Only” and press **←** to delete all unlocked channels. Or select “Delete All Channels” to delete all channels, even those that are locked. In either case, the current channel will remain but will be redefined from projector defaults.

*NOTE: For any deletion, a confirmation box appears to make sure that you really want to delete. Select “Cancel” (default) if you don’t want to delete after all.*

**Editing a Channel Setup** ➤ The basic setups that describe how and where a channel can be accessed are listed in the *Channel Setup* menu. These channel setups can be edited at any time in the *Channel Edit* submenu.

**CHANNEL EDIT — STEP 1** From the presentation level press **Menu** to display the main menu. To display the *Channel Setup* menu, press **3**, or move the highlight to the *Channel Setup* option and press **←**. The *Channel Setup* menu will appear.

**CHANNEL EDIT — STEP 2** To edit parameters shown in the *Channel Setup* menu, select the relevant channel and press **←**. The *Channel Edit* menu will appear similar to the sample shown in Figure 3.12.



**Figure 3.12. Channel Edit Menu (SAMPLE)**

**CHANNEL EDIT — STEP 3** If desired, review and/or edit the following channel setups in the *Channel Edit* menu:

- **CHANNEL NAME:** An alpha-numeric label can be defined and/or changed here. Channel names can be up to 12 characters in length.
- **CHANNEL NUMBER:** A 2-digit channel number can be changed here. *NOTES:* 1) If you enter a channel number that already exists, a dialog message appears indicating that this number is already in use—assign a different channel number. 2) You can define up to 50 channels.
- **INPUT:** 1-5, corresponding to where on the projector’s input panel the source is connected.
- **IN MENU:** If checked (default, except for automatically defined channels with unchanged parameters), this defined channel will then appear in the list available when **Channel** key is pressed. If unchecked, the channel must be accessed via **Channel** on the keypad or via the “Auto Source” function. *NOTE: On-screen display of the channel list is an option that must be set in the Menu Preferences menu.*



- **AUTO SOURCE:** If checked, (default), the projector can automatically locate this channel when an incoming input signal matches. If not checked, the projector can locate the selected channel only when it is directly selected via **Channel** on the keypad—and a change in input signal will *not* result in a channel change.
- **LOCKED:** If checked, all of the image settings for this channel are disabled. If unchecked (default), all available image settings can be adjusted as desired. You cannot use Auto Setup with a locked channel.
- **PREVIOUS CHANNEL:** Select this option to see or change *Channel Edit* settings for the previous channel in the *Channel Setup* list.
- **NEXT CHANNEL:** Select this option to see or change *Channel Edit* settings for the next channel in the *Channel Setup* list.

### 3.5 Adjusting the Image

The most commonly used options for image adjustments are accessed through two menus: *Size and Position* (**Menu 1**) and *Image Settings* (**Menu 2**), both of which appear in the *Main* menu. From either of these two menus, you can change settings affecting the image from the current channel by working with the appropriate slidebars, checkboxes and pull-down lists. **Exit** will return to the previous menu (or to the presentation, if from the *Main* menu) and accept any changes you may have entered. Settings are saved with the current channel.

From your presentation, you can access any of the individual options in these menus by pressing **Menu** followed by the appropriate two-digit number representing their location in the menu system. For example, press **Menu 2 3** to quickly access the “Gamma” option in the *Image Settings* menu.

Note that for certain options, you may prefer to use a “direct key” from presentation level to go directly to a particular option without traveling through the menu system (*note: available for certain display parameters only*). For example, press **Contrast** to access the “contrast” sidebar immediately. Press **Exit** to return to your presentation.

**NOTES:** 1) To hide these “direct” slidebars, disable the “Display Slidebars” checkbox in the **Menu Preferences** menu. 2) To hide the entire menu system from view, turn off the on-screen display by pressing **CSD** **▼**.

#### Before You Begin ➤ Use Auto Setup (**Auto**)

For a good and efficient first step in perfecting the image, press **Auto**. This initiates an automated process in which the projector quickly optimizes critical display parameters such as size, position, pixel tracking, etc., based on the type of incoming source data detected. An *Auto Setup* can save considerable setup time, and you can still modify the adjustments as desired using menu options described below.

**Size and Position Menu** ➤ In the *Size and Position* menu, you can increase or decrease the size of your image, change its proportion (aspect ratio), move the image to a specific area of the screen, and refine other related parameters. Use *Size and Position* controls to match the image precisely to the screen used at the site.

Size and Position			
1.	Resize Presets	No Resizing	▼
2.	Size	0.729	<input type="text"/>
3.	Vertical Stretch	1.000	<input type="text"/>
4.	Pixel Track	858	<input type="text"/>
5.	Pixel Phase	0	<input type="text"/>
6.	H-Position	360	<input type="text"/>
7.	V-Position	262	<input type="text"/>
8.	Reserved		
9.	Reserved		
0.	Advanced Size and Position		

Refer to "Using Slidebars and Other Controls" (earlier in this section) if you need help using any of the options and controls.

Changes made in the *Size and Position* menu are applied immediately and are saved when you exit the menu (press  or .

### Resize Presets

**NOTE:** *The same resize presets are available to the widescreen format DW30. Please note however, the graphics used to describe each preset are of the SXGA+ models only.*

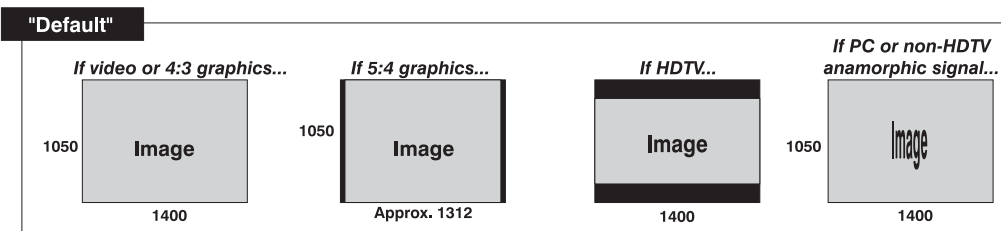
Resize Presets	
1. Default	= maximize for current source
2. No Resizing	= display in native resolution
3. Full Size	= fill the screen (regardless of source)
4. Full Width	= fill display width & keep aspect ratio
5. Full Height	= fill display height & keep aspect ratio
6. Anamorphic	= retain 16:9 aspect ratio
<i>Custom (not selectable) = non-preset values for Size, Vertical Stretch, H-Position, V-Position and/or Blanking</i>	

Select a *Resize Presets* option to quickly display an image in its native resolution or to automatically resize an image to closely fill the projector's native resolution or to optimize the width or height of your display. *Size*, *Position* and *Blanking* parameters will automatically adjust accordingly or, if *Blanking* is set first, which defines an Active Input Area, *Resize Preset* scaling will occur in this region of interest only. Resizing options are explained in detail below.

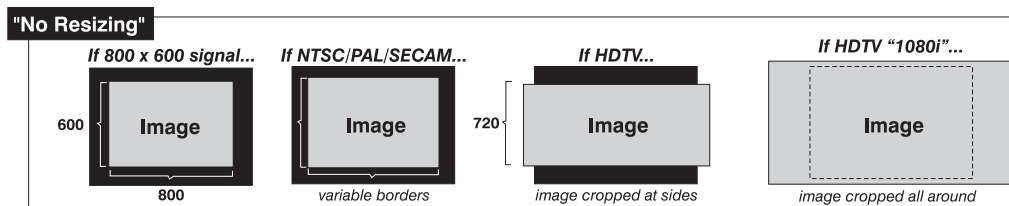
**WHAT IS THE RESIZING DEFAULT?** By default when displaying a new source, your image will utilize as much of the projector's display area as possible for the type of incoming source data, but with minimal or no changes to aspect ratio. See *Select "Default"* below.

**WHEN "CUSTOM" APPEARS:** The "Custom" re-size descriptor automatically appears in the *Size and Position* menu when any of the values for *Size*, *Vertical Stretch*, *H-Position*, *V-Position* or *Blanking* do not correspond to those for a preset. This option is not offered in the *Resize Presets* pull-down list.

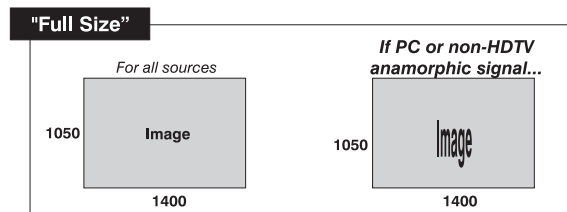
- Select "DEFAULT" for most sources (factory default). The image will be centered and displayed as large as possible *depending on the type of source*.



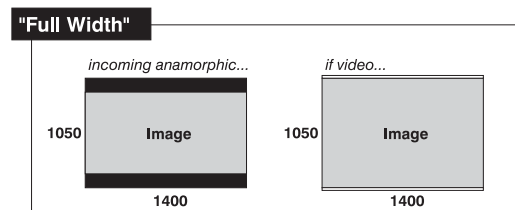
- Select **"NO RESIZING"** to display the image in its native resolution, which may or may not match the projector's resolution. For example, for a source with a native resolution of 800 x 600, "No Resizing" in an SXGA+ projector will use the central 800 x 600 pixels and have a black border—the black border areas are unused areas. See below.



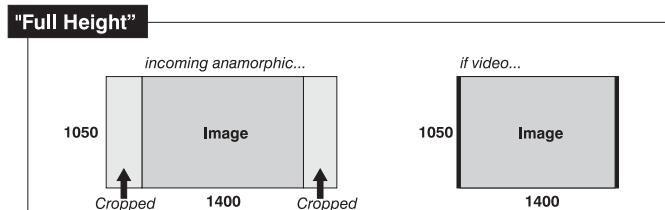
- Select **"FULL SIZE"** to use *all pixels* for displaying the image, regardless of source or original aspect ratio. Incoming source material having a different aspect ratio than the projector will be stretched for display.



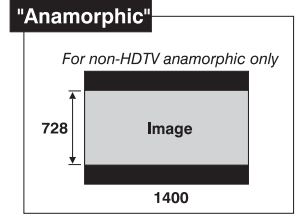
- Select **"FULL WIDTH"** to fill the projector's display from left-to-right without changing the original aspect ratio of the image. Depending on the source, data at the top and bottom may be discarded (cropped), or the display may have black borders at the top and bottom (called "letterboxed").



- Select **"FULL HEIGHT"** to fill the display from top-to-bottom. Depending on the source, this may create borders.



- Select “ANAMORPHIC” to display an anamorphic image in its native 16:9 aspect ratio. The image will fill the screen from side-to-side and be centered between black bars at top and bottom.



### Size

“Size” controls both the image *width* and *height* in tandem, maintaining the current aspect ratio (proportion) of the displayed signal data.

### Vertical Stretch

“Vertical Stretch” adjusts the *height* of the image while keeping the width constant. Use “Vertical Stretch” to change the aspect ratio of the display.

### Pixel Track

Steady flickering or several soft vertical stripes or bands across the entire image indicates poor pixel tracking. Proper pixel tracking helps ensure that the image quality is consistent across the screen, that aspect ratio is maintained, and that pixel phase can be optimized (described below). Tracking determines the frequency of the pixel sampling clock, indicated by the number of incoming pixels per line, so that all pixels generated by a particular source are sampled.

*NOTE: By default, the projector samples at the correct frequency for most sources.*

For best results, use a good test pattern such as a smooth gray consisting of a clear pattern of black and white pixels, or a similar “half on, half off” graphic image, such as the *Windows* shutdown screen. Adjust the slider until the vertical stripes broaden to the point where one large stripe fills the image. If the image still exhibits some shimmer or noise, adjust *Pixel Phase* (below).

### Pixel Phase

*NOTE: Adjust “Pixel Phase” after “Pixel Tracking”.*

Adjust pixel phase when the image (usually from an RGB source) still shows shimmer or “noise” after pixel tracking is optimized. Pixel phase adjusts the phase of the pixel sampling clock relative to the incoming signal.

For best results, use a good test pattern such as a smooth gray consisting of a clear pattern of black and white pixels, or a similar “half on, half off” graphic image, such as the *Windows* shutdown screen. Adjust the slider until the image stabilizes and each pixel is clearly defined. You may notice that you can stabilize the image at more than one point—i.e., you may find that the image appearance at “11” is identical to the image appearance at “38”, thus you can use either setting.

If some shimmer from a video or HDTV source persists, use the “Filter” control to remove high-frequency noise from the signal.

### H-Position

This option moves the image right or left within the area of available pixels.

*NOTE: The value shown represents where the approximate center of the image lies in relation to the total number of pixels available horizontally. This varies widely according to the signal—watch the image while adjusting.*

### V-Position

This option moves the image up or down within the area of available pixels.

*NOTE: The value shown represents where the approximate center of the image lies in relation to the total number of pixels available vertically. This varies widely according to the signal—watch the image while adjusting.*

### Advanced Size and Position — SUBMENU

This submenu consists of the following options:

**ACTIVE INPUT WINDOW:** This read-only value indicates the current size (i.e., area) of your displayed data or “region of interest” as defined by the blanking controls. By default, the projector automatically determines what portion of its full resolution to use, and pixels in the surrounding borders are turned off.

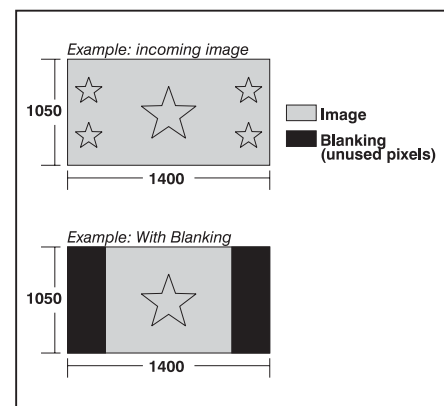
You can also specify a specific active input window size by adjusting one or more “Blank” settings. For example, if you have blanked (cropped) 100 pixels from both the left and right edges of an incoming source of 1400 x 1050, the remaining active input window will be reduced to 1200 x 1050. When using SD or HD or a decoded video source at **INPUT 3** or **INPUT 4**, the default blanking of “0” defines an active input window of 720 x 483.

### BLANKING (TOP, BOTTOM, LEFT, and RIGHT):

Crop the image as desired so that unwanted edges are removed from the display (changed to black—see right). Blanking defines the size of the *Active Input Window*, or area of interest. Range of adjustment depends on the source resolution and other factors. After adjustment of blanking it may be necessary to perform a source switch.

*NOTE: Blanking a PIP image resembles zoom (Figure 3. 13). For example, left Blanking zooms the right side of the PIP image; Right Blanking zooms the left side. There are no black bars.*

Advanced Size & Position			
Active Input Window		720x483	
1.	Top Blank	0	<input type="text"/>
2.	Bottom Blank	0	<input type="text"/>
3.	Left Blank	0	<input type="text"/>
4.	Right Blank	0	<input type="text"/>
5.	Plug & Display (EDID)		1280x1024x60Hz ▾
6.	PIP Border		Black ▾
7.	PIP Border Width		1 <input type="text"/>



**PLUG & DISPLAY (EDID):** By default, a *Plug & Play (EDID)* source outputs a signal according to the EDID information provided by the projector. To override this information and display in a different format (for example, if your *Plug & Play [EDID]* device does not support the projector’s resolution and/or frequency), select the desired *Plug & Play (EDID)* resolution from the list.

1. 1400x1050x60Hz
- ▶ 2. 720p (1280x720x60Hz)
3. DC2K (2048x1080x60Hz)
4. 1024x768x116Hz 3D
5. 1280x1024x110Hz 3D
6. 1400x1050x102Hz 3D
7. 1080p 60Hz / 1080i 60Hz
8. 1080p 50Hz / 1080i 50Hz
9. 1080p 24Hz / 1080i 30Hz

Any daisy-chained projectors will also display according to the chosen *Plug & Play (EDID)* format.

EDID = Extended Display Identification Data standard.

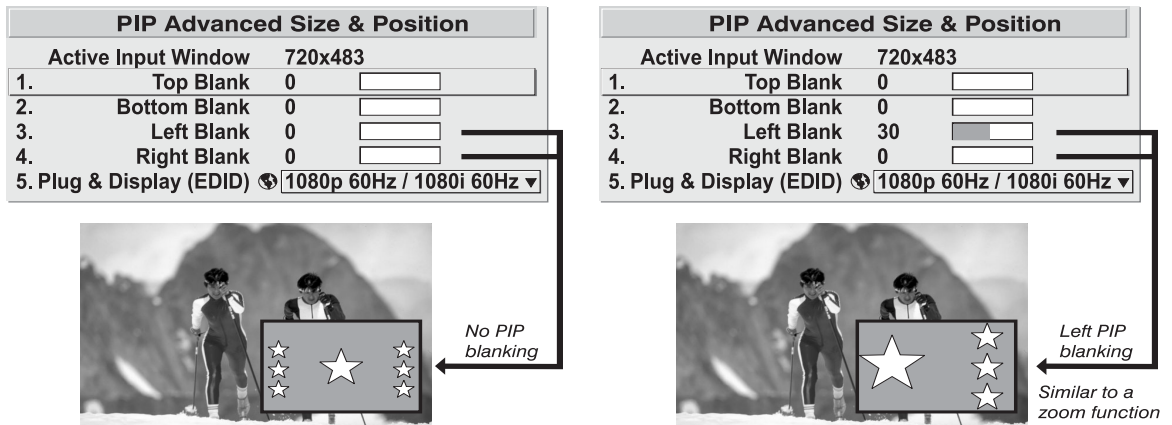
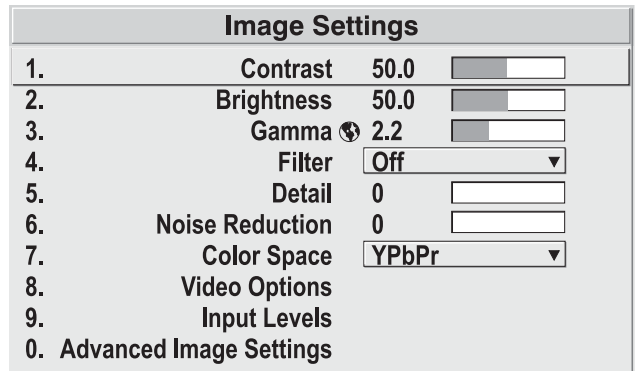


Figure 3.13 Blanking of a PIP Image

**Image Settings Menu** ➤ Use options in the *Image Settings* menu to alter your image without affecting its size or position. Changes made to the *Image Settings* menu are applied immediately and are saved when you exit the menu (press **Exit** or **Menu**). Options not available for the projector model or source are disabled and appear dim (gray).



**Contrast**

**(SHORT CUT:** Press **Contrast** and adjust the slidebar.)

“Contrast” increases or decreases the perceived difference between light and dark areas of your image (0-100). For best results, keep close to 50. If contrast is set too high, the light parts of the image lose detail and clarity. If set too low, the light areas will not be as bright as they could be and the overall image will be dim. For best results, start with a low value and increase so that whites remain bright but are not distorted or tinted, and that light areas do not become white (i.e., are “crushed”).

*NOTE:* If the environment lighting changes, an adjustment of **Gamma** is recommended (see below).

### **Brightness**

**(SHORT CUT:** Press  and adjust the slidebar.)

“Brightness” increases or decreases the amount of black in the image (0-100). For best results, keep close to 50. Start with a high value and decrease so that dark areas do not become black (i.e., are “crushed”). Conversely, high brightness changes black to dark gray, causing washed-out images.

### **Gamma**

**(SHORT CUT:** Press  and adjust the slidebar.)

“Gamma” is a global setting that determines what gray shades are displayed between minimum input (black) and maximum input (white) for all signals. A good gamma setting helps to optimize blacks and whites while ensuring smooth transitions for the “in-between” values utilized in other colors. Thus, unlike “Brightness” and “Contrast” controls, the overall tone of your images can be lightened or darkened without changing the extremes, and all images will be more vibrant while still showing good detail in dark areas.

Gamma is used to fine tune the gamma table currently in use, ranging from 1 – 3 (2.5 = default). If excess ambient light washes out the image and it becomes difficult or impossible to see details in dark areas, lower the gamma setting to compensate. This will improve contrast while maintaining good details for blacks. Conversely, if the image is washed out and unnatural, with excessive detail in black areas, increase the setting. In high ambient light conditions, lower gamma may produce better results than higher gamma. Gamma of 2.5 (default) indicates the gamma table has not been adjusted. For more information, refer to Advanced Image Settings, Gamma Table submenu. Again, good gamma improves contrast while maintaining good details for blacks.

### **Filter**

The proper filter setting is automatically set for virtually all signals, and rarely needs to be changed. It applies a low pass filter for noise reduction in the incoming input signal, particularly for HDTV or SDTV. Applied in the analog domain before sampling, this filtering removes high frequencies and thus reduces pixel phase noise (note this also reduces signal bandwidth). Override only if standard pixel tracking and phase adjustments do not adequately clear up a “noisy” video signal, or if a graphics signal appears overly “soft”. Both instances indicate that “Filter” may be set to the wrong option.

▶ 1. Off
2. HDTV
3. SDTV

### **Detail**

“Detail” adjusts the sharpness of a video image so that edges remain clearly defined. It can be particularly useful if a significant “Noise Reduction” adjustment has caused the image to appear too soft. Adjust until the display is as sharp as desired, keeping in mind that because “Detail” adds some high frequencies back into the image, it can also re-introduce a certain degree of noise.

### **Noise Reduction**

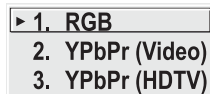
“Noise Reduction” is similar to the “Filter” control, but operates in the post-sampling digital domain with a more subtle effect. Higher settings are most useful for clearing



up noisy RGB images such as those from a PC. Adjust as desired, keeping in mind that reducing noise (which reduces high frequencies) may also soften the image.

### Color Space

“Color Space” determines how the color components of an analog input signal are decoded for accurate color in the display. Selecting a color space option is useful only for analog signals connected to **INPUT 1, INPUT 2, or INPUT 5**. Although color space for these analog signals is automatically determined by the projector, in some circumstances you may wish to override this and manually set a specific color space. *NOTE: For digital signals or for signals connected to **INPUT 3 or INPUT 4**, the color space function is entirely automatic and the pull-down list disabled.*



The current color space appears in the *Image Settings* menu. Press to select a different option:

- Select **RGB** unless you are using component video at **INPUT 1, 2, or 5**.
- Select **YPbPr (Video)** with a standard definition televised signal (SDTV)
- Select **YPbPr (HDTV)** with a high definition televised signal (HDTV).

*NOTE: When certain RGB signals are first connected, the projector may not initially recognize them as RGB and will incorrectly decode their color information as YPbPr (video). These signals appear magenta and can include:*

- RGB signals in NTSC, PAL, SECAM frequency ranges
- Scan-doubled sync-on-green
- Scan-quadrupled sync-on-green

*For these signals, change the Color Space to RGB, then define a new channel for future use*


### Video Options — SUBMENU

This submenu is used with video sources only (**INPUTS 3 or 4**).

**ENABLE DECODER AGC:** Automatic Gain Control (AGC) affects decoded video images only. Enter a checkmark (default) in most instances—this activates the decoder’s AGC circuit to ensure properly bright images. Delete the checkmark if a decoded video image exhibits strange color artifacts such as stripes in highly saturated colors, indicating an incompatibility between this source and the AGC.

Video Options	
1. Enable Decoder AGC	<input checked="" type="checkbox"/>
2. Video Standard	(A)?
3. Input Video Black	0 IRE
4. Color	50.0
5. Tint	50.0
6. Decoder Luma Delay	35.0



**VIDEO STANDARD:** For all but the more unusual video standards available in the world, the projector automatically detects the incoming horizontal and vertical frequencies and sets the projector's processing of this signal to the corresponding standard. The current video standard name appears in the *Video Options* submenu, and includes an “A” if it has been auto-detected. Press  to view or select a different video standard from those available to the projector—any that are disabled have frequency characteristics that differ from those of the incoming signal. Selecting a specific standard forces the projector to process the signal according to this standard.

- |                |
|----------------|
| 1. Auto        |
| 2. NTSC        |
| ▶ 3. NTSC 4.43 |
| 4. PAL         |
| 5. PAL-M       |
| 6. PAN-NC      |
| 7. PAL-60      |
| 8. SECAM       |

*NOTE: Best results are obtained with defined channels. Otherwise, switching from one video source to another can sometimes cause slight disturbances in the display, indicating that the Auto function is struggling. Recover by briefly selecting a different video standard, then going back*

**Table 3.3. Regions and Video Standards: Summary**

Standard	Where Used (SUBJECT-TO-CHANGE)
NTSC	N. America and Japan
NTSC 4.43	A tape-only standard for partially-translated hybrid signals
PAL	Most of Europe, China, Australia, some of S. America, some of Africa
PAL-M	Brazil
PAL-NC	Argentina, Chile, other Latin American countries
PAL 60	
SECAM	France, Eastern Europe, most of Africa

*NOTE: Generally, use “Auto” for all instances EXCEPT: 1) a poor quality input signal or 2) a black-and-white video signal. In order to detect and display such signals, select the relevant standard from the list.*

**INPUT VIDEO BLACK** — This control compensates for incoming elevated black levels present in certain video signals, and ensures that blacks in the display are neither crushed (i.e., where dark grays appear black) nor excessively elevated (i.e., where blacks appear dark gray). By default, the projector automatically determines the best setting according to the type of incoming video signal:

- |                              |            |
|------------------------------|------------|
| If grays are black, select → | ▶ 1. 0 IRE |
| If blacks are gray, select → | 2. 7.5 IRE |

- **0 IRE** – Used for DVD output with “enhanced black”, SECAM, most PAL standards, and Japanese NTSC.
- **7.5 IRE** – Used for most NTSC video signals.

For some types of video, you can override the setting. The control is disabled for other types of video (and all graphics sources). Generally, if black appears crushed when brightness = 50, choose “0 IRE”. If black appears excessively elevated, use “7.5 IRE”.

**COLOR** — This sidebar adjusts the color saturation level, i.e. the *amount* of color in a video image. Lower settings produce less saturated colors — for example a setting of “0” produces a black and white image. If the color level is too high, colors will be overpowering and unrealistic.

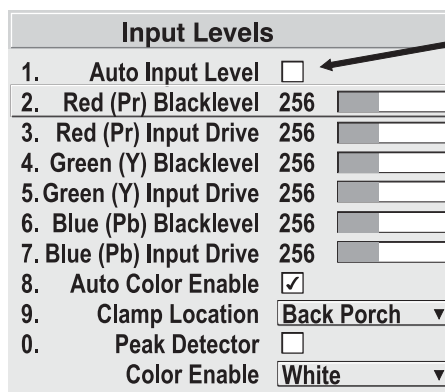
**TINT** — This sidebar adjusts the red/green color hue for true color reproduction of video signals connected to Input 3 or 4. For best results, adjust tint while displaying an external color bars test pattern—otherwise, it is recommended that tint remain at its default setting.

**DECODER LUMA DELAY** – This control affects any incoming composite or S-video signal, delaying the luma signal (intensity) in relation to the chroma (color). In the image, increasing the luma delay will move luma (seen as a shadow where colors overlap) to the right slightly, with colors remaining in place. Decreasing this delay will move the shadow slightly to the left. If necessary for your current source, adjust so that no shadows occur with adjacent colors.

**Input Levels — SUBMENU**

*NOTES: 1) Because the projector automatically optimizes input levels for all but the most unusual of sources, it is recommended that only experienced users use the **Input Levels** submenu. 2) Before beginning, check that overall contrast and brightness settings are near 50 and that color temperature is properly set up on an internal grayscale test pattern. 3) There must be at least 2 consecutive white pixels present in the image for proper “Auto Input Level” function. Leave this control **off** after use.*

Good RGB or input levels—that is, the *drives* and *blacklevels* for each of the three colors, red, green and blue—ensure that images from analog sources other than decoded video have maximum contrast without crushing black or white. By default (and in an “Auto Setup”), the projector automatically determines the best input levels by



Turn OFF before leaving menu.

Levels adjust automatically and correctly.

**NOTE:** Image must have at least 6-12 adjacent white pixels for “auto” to work.

monitoring image content and adjusting the controls appropriately—further adjustment is typically not required to obtain proper blacks or whites. *NOTE: This automatic adjustment requires at least 6-12 consecutive white pixels in the image. Without these pixels, input levels may produce skewed colors, particularly in non-video images.*



However, for a very unusual source exhibiting one or more overly high blacklevels (typically caused by a noisy source causing blacklevel spikes), an experienced user may prefer to use the *Input Levels* menu (shown above). These adjustments, which together serve as a calibration process compensating for differences in sources and cabling, enable an experienced user to perfect the source image input levels and eliminate the “overshoot” and “undershoot”. Note that *Input Levels* are of limited use with digital signals, but do offer some ability to tweak poorly mastered source materials.

*NOTES: 1) Input levels apply for the current source only, but for any color temperature used. 2) Assuming that color temperature has been set up based on the internal test patterns, you can then set up input levels for a given source so that it matches the color temperature of the internal test patterns.*

**AUTO INPUT LEVEL** – Temporarily enter a checkmark *only* if you are an experienced user and you have an unusual source that you feel needs further color temperature and/or input level adjustment. This compensates for incoming out-of-range drives (white) and blacklevels (black) that would cause “crushing” of light and dark colors in the image. After entering a checkmark, wait for the six sidebar values to stabilize,

then delete the checkmark and exit. The Auto Input Level is automatically turned off upon exiting the Input Levels menu.

**BLACKLEVELS AND DRIVES** – To check your image levels and adjust these controls:

1. Make sure overall “Contrast” and “Brightness” settings are both set to near 50.  
*NOTE: Not required for “Auto” adjustment.*
  -  = 50 (approx.)
  -  = 50 (approx.)
2. Check the color temperature setup using an internal grayscale test pattern, making sure to obtain a neutral grayscale. *NOTE: Not required for “Auto” adjustment.*
3. Confirm that you are using an analog source *not* connected to **INPUT 3** or **INPUT 4**, as Input Levels are not applicable for digital sources or sources going through the decoder. A grayscale is recommended.
4. If the blacks and/or whites appear OK, input levels do not need adjustment. If black levels are too high (and/or whites are too low, which is rare), you likely have a noisy source that is producing skewed input levels. Continue with Step 5.
5. Temporarily enable “Auto” in the *Input Levels* submenu. Wait for all 6 values to stabilize. Alternatively, do *not* use “Auto”—reduce blacklevels manually instead. Judge by eye and change one or more of the six levels as necessary to obtain proper blacks and whites. You may want to see only a certain color while adjusting—use the “Color Enable” option (described below).
6. Delete the “Auto” checkmark and leave the *Input Levels* menu.

**IMPORTANT:** Do not use *Input Levels* to adjust color temperature. This will distort Contrast and Brightness functions as well as color temperature.

**AUTO COLOR ENABLE** – When a checkmark is present, selecting a specific blacklevel or drive to adjust will automatically enable the corresponding color in the display. Delete the checkmark to see all colors, or to enable a different specific color through the Color Enable Control.

**CLAMP LOCATION** – This option (formerly known as *sync tip clamping*) can brighten the image produced from certain high-resolution high-frequency graphic sources. For almost all sources, the best clamp location is automatically selected by the projector.

- |                 |
|-----------------|
| ▶ 1. Back Porch |
| 2. Sync Tip     |
| 3. Tri Level    |

Use the normal *Back Porch* location if the image is either sufficiently bright or overly bright. Select *Sync Tip* if the image appears unusually dim, if there are horizontal streaks across the image, or if there is significant color drift. This moves the clamping pulse from the normal backporch location (which is likely too short) to the tip of the horizontal sync pulse. *Tri Level* is typically needed for an HDTV source.

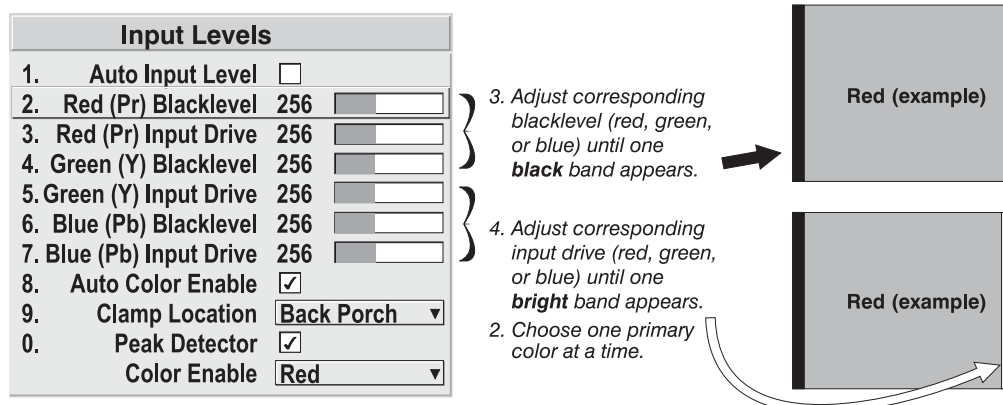
**COLOR ENABLE** – Select which color or colors you want to see in the display, useful while working with color temperature white levels or input levels.

**PEAK DETECTOR** – The Peak Detector is a tool to assist with defining individual input levels, enabling you to accurately set the Input Levels for any particular source with the appropriate image. Enabling the Peak Detector activates a special operating mode for detecting *only* pixels that are considered black or white—all other levels are displayed as a mid-level gray. When used with a smooth grayscale pattern in which black and white are known to be at opposite edges of the image, you can watch these

isolated areas while adjusting individual blacklevels and input drives until both black and white edges are *just* visible and distinguished from neighboring pixels. Images from this source will then display correct blacks and whites without crushing.

See Figure 3.14. ***Adjusting Input Levels Using the Peak Detector:***

1. Display a 16-level grayscale test pattern from the desired external source, and enter a checkmark in the Peak Detector checkbox. *NOTE: The “Peak Detector” will initially render the grayscale as a uniform gray field before adjustment or extreme crushing.*
2. Display one primary color. *NOTE: Selecting Auto Color Enable ensures the correct color is displayed for each setting.*
3. For the current color, adjust its corresponding “Blacklevel” slider *just* until a single band of black appears at one edge of the screen. This band represents the first band of the grayscale pattern, which should be 100% black. Do not adjust too far.
4. With the same color still active, adjust its corresponding “Input Drive” slider *just* until a single band of color appears at the opposite edge of the screen. This band represents the last band of the grayscale pattern, which should be 100% white (or the current color, if a certain color is enabled). Do not adjust too far.
5. It may be advantageous to go back and check the black band—adjust the blacklevel slider if necessary. *NOTE: Readjusting blacklevels at this point affects the gain; only readjust when absolutely necessary.*
6. Repeat Steps 3-5 with the other two remaining primary colors. When each primary color shows *one* optimized black band and white (or colored) band, the input levels for this source are correctly set. Upon exiting the *Input Levels* menu, the Peak Detector checkbox will clear.



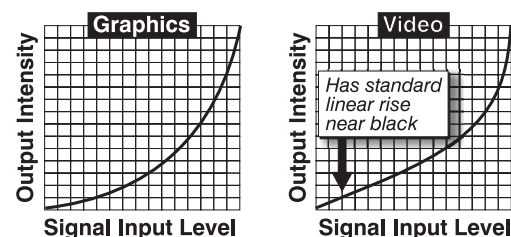
**Figure 3.14. Adjusting Input Levels Using the Peak Detector (RED EXAMPLE SHOWN)**

### Advanced Image Settings — SUBMENU

Use the *Advanced Image Settings* submenu to make the adjustments necessary for lesser-used but more specialized applications on your projector.

**GAMMA TABLE:** This control applies a default *video* or *graphics* gamma table or “curve” to your images, controlling the intensity of midlevel colors and producing maximum contrast, brightness and color performance. As shown at right, the graphics curve is a simple power curve while the video curve has a linear segment near black to compensate for increased blacklevels typical of video signals. Although the projector automatically applies either the graphics or video curve according to what type of incoming signal is detected, in some cases you may wish to override this default and use *graphics* gamma for a video source or *video* gamma for a graphics source. Alternatively, if neither default is ideal, you may prefer to apply a user-defined custom gamma curve that has been created externally, named, and downloaded to the projector (requires separate PC-based *Arbitrary Gamma* and *KoRE Librarian* software applications). If any of these special user curves have been installed, their names will appear in the Gamma Table pull-down list.

Advanced Image Settings		
1.	Gamma Table	Graphics
2.	Select Color Adjustment	Max. Drives
3.	Color Temperature	7600 <input type="text"/>
4.	Reserved	
5.	White Boost	0 <input type="text"/>
6.	Simulation 3D	
7.	Motion Filter	Auto
8.	Film Mode Threshold	0 <input type="text"/>
9.	Detail Threshold	0 <input type="text"/>



Keep in mind that any *Gamma Table* choice sets the related *Gamma* value (shown in the *Image Settings* menu) to a 2.5 default, where it can be fine-tuned as desired. Different values (1-3) here indicate that the original gamma table has been adjusted with either the *Gamma* slidebar or direct key.

**NOTES:** 1) If no user curves have been defined and downloaded to projector memory, only the “2.5, Graphics/Video Normal” default gamma curve is available here – adjust as desired using *gamma* in the main *Image Settings* menu. 2) Some graphic material will look best with the video setting while some video material is best with the graphic setting.

**SELECT COLOR ADJUSTMENT:** In “Select Color Adjustment”, choose an overall color palette for all images. The “Max Drives” factory default simply drives all 3 colors at their maximum level so that they are fully on and cannot be changed. The two other pre-defined color adjustment choices—*SD Video* and *HD Video*—apply a color gamut optimized for video sources (standard or high-definition). Alternatively, you can specify a color temperature. This enables the adjacent Color Temperature slidebar and applies its current setting (default = 6500K). If none of the pre-defined “Select Color Adjustment” options or color temperatures suit your application, select one of four color gamuts previously defined by a user (User 1, 2, 3, 4). A “User” option applies a

1.	Max. Drives
2.	Color Temperature
3.	SD Video
4.	HD Video
5.	User 1
6.	User 2
7.	User 3
8.	User 4

customized color performance in which the user has precisely set the hue and intensity of each color component in the *Color Adjustment by X/Y* or *Color Saturation* submenus. It is most often needed with multiple-projector applications. Select the color adjustment producing the best color accuracy for your application and installation.

To configure a “User” color adjustment (gamut), use either the *Color Adjustment by X/Y* or *Color Saturation* submenu.

*NOTES: 1) “Color Temperature” defaults to 6500K until changed. All four “User” options default to SD Video unless they have been redefined by the user. 2) Factory-defined color primaries, which ensure consistent color gamut from projector-to-projector, can be calibrated in the **Service** menu only. If you suspect alteration, the factory settings can be recovered with selection of **Reset to Factory Defaults?** in the **Color Primary Settings** submenu within the **Service** menu (password-protected).*

**COLOR TEMPERATURE** — Adjust to apply a specific and accurate color temperature to all displays. Color temperatures are expressed in degrees Kelvin (3200-9300K), and utilize different combinations of the projector’s original native color primaries to produce a “coloration” or cast (reddish or bluish) in images—the lower the temperature, the more reddish the cast; the higher the temperature, the more bluish the cast. Note that the slider is enabled only if you have a source connected and have selected “Color Temperature” in the adjacent “Select Color Adjustment” pull-down list in the *Advanced Image Settings* menu.

**RESERVED** — No function.

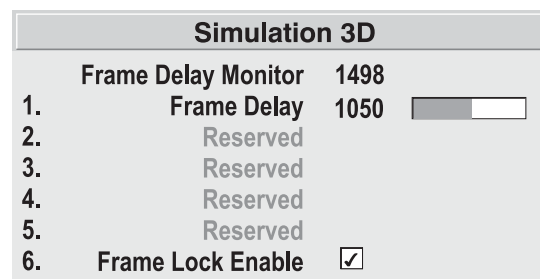
**WHITE BOOST** — White boost is a source dependent setting that enables you to recapture some of the lost light from the transition between segments in the color wheel as it’s spinning. For NTSC, HDTV, PAL and SECAM signals the white boost defaults to “2” and for graphic signals or when a test pattern is selected it’s “10”. When white boost is set to zero, it is off and the option grays out in the menu. As you increase the value of white boost you will notice that the image becomes increasingly brighter and a little less saturated.

*NOTES: 1) White Boost is automatically disabled (grayed out in menu) when you enable Brightness Uniformity, Edge Blending or select a color adjustment (Select Color Adjustment) other than “Max Drives”. The grayed out value you see is the last value loaded before being disabled. 2) White Boost can also be adjusted specifically for internal test patterns. However, once you switch back to a source, the White Boost settings will reset to the value set for that source. 3) If the ChristieTWIST module is installed and edge blending is enabled, White Boost is still active and can be adjusted to suit.*



**Simulation 3D — SUBMENU OF ADVANCED IMAGE SETTINGS**

This submenu allows you to adjust the timing between the input signal and its appearance on screen. This is most useful in applications where you want to match the timing of the projector to other equipment, such as a video recording device in broadcasting environments.

**Figure 3.15.**

**FRAME DELAY MONITOR** — This value changes as it monitors the latency between input and output. The value should remain fairly constant and close to the value of the Frame Delay, indicating that timing of input and output frames is locked; the Frame Delay Monitor value should stay within 5-10 lines or so of the Frame Delay setting. If a frame is lost or “dropped”, the values will change significantly, indicating that the frame input is no longer equal to the output.

**FRAME DELAY** — Set the number of lines delayed between the input signal and its appearance on screen, keeping in mind that projector processing always *adds one frame of delay* to the frame delay setting. For applications, where the feeling of “real time” image response is a priority, a minimum setting is usually preferable. If set too high or low, frame locking will not be possible—most sources require approximately 50 lines of delay to ensure frame locking.

**FRAME LOCK ENABLE**—When checked, the output image frame rate is locked to the input signal frame rate when possible. When the images are not locked, the input and the output will run as close to the same rate as possible, but frames may occasionally be duplicated or dropped.

By default, this option is checked.

**Advanced Image Settings continued — SUBMENU**

**MOTION FILTER** — This control is most useful for smoothing out moving images from interlaced sources. In most cases the proper Motion Filter setting is automatically determined according to the type of incoming source signal. However, if your source is jittery and/or tearing you may wish to “force” a setting to ensure stable processing for this source—if desired, override the default “Auto” setting by selecting the appropriate motion filter:



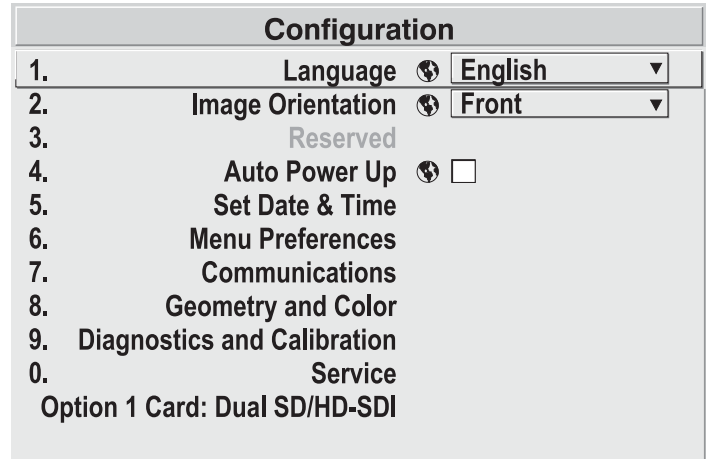
1. **AUTO:** The projector will automatically use the correct motion filter according to the incoming signal.
2. **STILL:** For static images with no motion, such as graphics from a CD.
3. **MOTION:** For video images that did not originate from film, or for moving computer-generated images.
4. **FILM:** For video images that originated from film. This will optimize image quality and stability.

**FILM MODE THRESHOLD** — This setting determines how sensitively the projector can detect if an incoming video signal originated from film or not. It should not require adjustment.

**DETAIL THRESHOLD** — Use “Detail Threshold” to define at what frequency level the “Detail” control will begin to magnify high frequencies, which adds details back into the image. Raise the threshold to *ignore* more of these high frequencies, and lower the threshold to *magnify* more of these frequencies. A setting of “0”, for example, means no noise will be ignored and all will be magnified. An ideal detail threshold is one in which high frequencies that are causing objectionable noise are *not* magnified when using “Detail”, but frequencies which can help sharpen an overly-soft image are magnified.

### 3.6 Adjusting System Parameters and Advanced Controls

Use the *Configuration* menu to define general operating parameters and communications with other projectors and equipment, and to access other advanced processing and image adjustments affecting overall performance. In addition, the *Configuration* menu provides access to diagnostics, calibration tools and the *Service* submenu (password-protected).



Keep in mind that settings in the *Configuration* menu (and its submenus) are typically “global” settings applied regardless of the type of source your are using. This characteristic is identified with the (globe) icon alongside the option.

*NOTE: The Configuration menu is recommended for experienced users/technicians only.*

#### System Configuration — GENERAL —

The first six options in the *Configuration* menu are explained below:

##### Language

Choose from available languages to use in the projector’s menus. The change will take effect immediately.

##### Image Orientation

Set the orientation of the image according to the orientation of your projector. If the setting is incorrect, projected images will be reversed and/or upside down.

##### Auto Power-up

Enter a checkmark to enable the projector to automatically power up after losing power due to a power failure or due to unplugging the projector during operation. Note that unsaved display adjustments may be lost.

##### Set Date & Time

Enter/read the current year-month-day and hour-minute-second. Changes here reset the projector’s real-time clock.



### Menu Preferences — SUBMENU

Adjust the appearance, content and/or location of on-screen menus and messages.

**LARGE MENU FONT** — Enter a checkmark to enlarge menus and their text. You may have to adjust “Menu Location” to accommodate the increased menu area.

Menu Preferences	
1.	Large Menu Font <input checked="" type="checkbox"/>
2.	Menu Location <input type="text" value="4:3 Top/Left"/>
3.	Horizontal Shift <input type="text" value="261"/>
4.	Vertical Shift <input type="text" value="204"/>
5.	Display Channel List <input type="checkbox"/>
6.	Display Slidebars <input type="checkbox"/>
7.	Display Error Messages <input type="text" value="All"/>
8.	Splash Screen Setup <input type="text" value="Always on"/>

**MENU LOCATION** — Use the pull-down list to choose a pre-defined default or customized location for the display of all on-screen menus.

To create a custom menu location quickly, choose a preset that is closest to the desired location. Then adjust “Horizontal Shift” and “Vertical Shift” slidebars to move the menu to the desired location. Avoid locations too close to a corner or edge to prevent cropping of larger menus.

**HORIZONTAL SHIFT AND VERTICAL SHIFT** — Shift your menus as desired, creating a customized menu location.

**DISPLAY CHANNEL LIST** — Enter a checkmark if you want to see a scrollable channel list whenever you press  from your presentation. Channels marked with a list icon  in the *Channel Setup* menu will appear here. The “Display Channel List” option also enables on-screen feedback when using the  key. If you prefer to hide the channel list and input dialog box while switching channels and sources during a presentation clear the checkbox.

*NOTE: The Channel List and input dialog box cannot be hidden during use of the menus.*

**DISPLAY SLIDEBARS** — Enter a checkmark to superimpose a small sidebar over the current image whenever an adjustable parameter is selected directly with a key such as  or . If “Display Slidebars” is unchecked, these slidebars can still be accessed, but will be hidden during adjustment. This option does not affect slidebars in menus.

**DISPLAY ERROR MESSAGES** — Choose how you want to be notified of errors detected in either the incoming signal or projector. Select “Screen” or “All” (default) to see brief on-screen messages. This is particularly recommended during setup or testing of the projector. Or select “RS232” to receive messages via RS232 (or RS422) serial communication only. To hide error message displays, such as during shows and presentations, select “Off” or “RS232”.

**SPLASH SCREEN SETUP** — Use the Splash Screen to choose when you would like to display a special introductory splash screen image, such as your company logo, graphic or message.

- Always Off = A splash screen never appears
- Always On = A splash screen is always on behind the current display image, similar to wallpaper.
- Startup Only – The splash screen logo appears at projector startup only.

- Startup And No Signal – A splash screen appears at startup only if there is no source signal.

To replace the default “Christie logo” splash screen (or other) with one of your own, use *KoRE Librarian* to download the desired .bmp to the projector. This will overwrite the current splash screen content in projector memory.

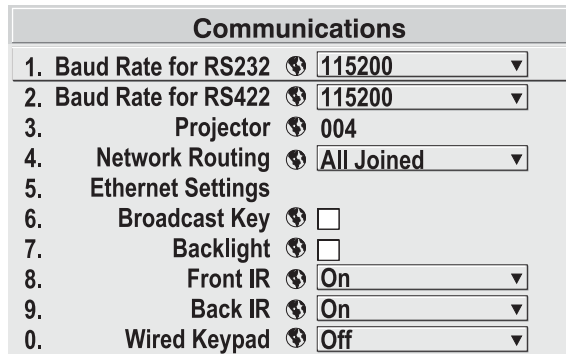
**System Configuration** ►  
— COMMUNICATIONS —

Settings in the *Communications* submenu define and control how single or multiple projectors are linked with each other and with a controlling device.

**Baud Rates**

The baud rate setting determines the speed of communication to and from the projector on the RS232 or RS422 links. The maximum rate for the RS232 is 115200; for RS422 it is 19200.

Set the baud rate to match that of your controlling device, such as your PC. If you are unsure about what baud rate to choose, refer to the documentation for the controlling device. In an existing network of projectors, if you discover that a projector has a different baud rate, make sure to use the pull-down list and select the correct baud rate using the key—do not just scroll this control with or keys. Serial communication is always 8 data bits, no parity.



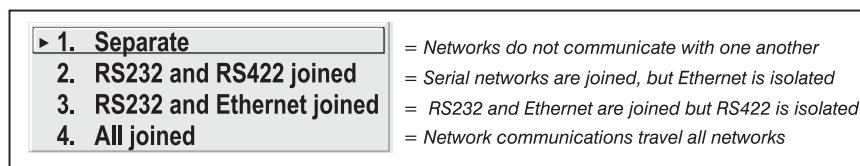
**Figure 3.16. Communications**

**Projector**

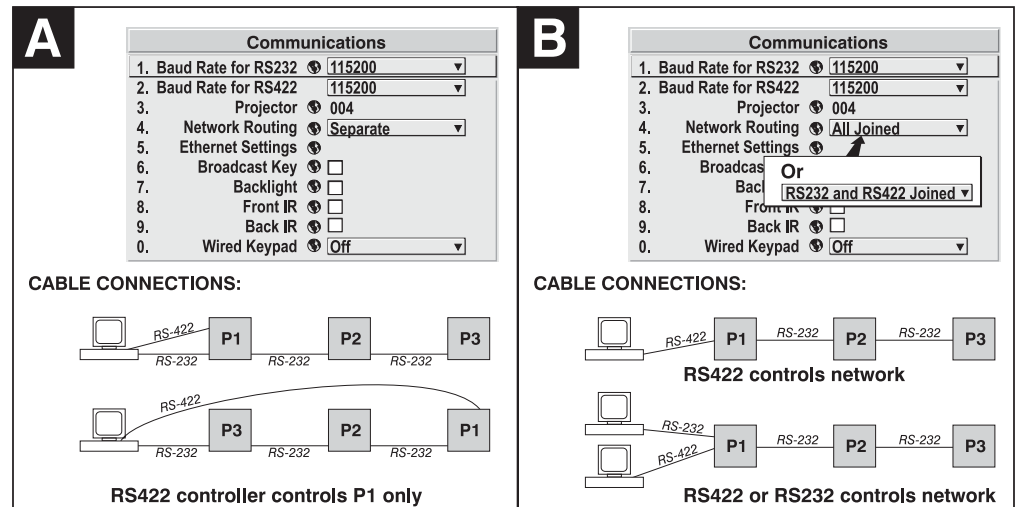
Enter a three-digit number (such as “001”) to assign or change a number to the projector currently in use. If the current projector already has a number assigned, that number will appear here (for example, “004” in Figure 3.16, above). Numerical identity for projectors enables you to communicate with a single projector within a multiple-projector application (see also key in 3.2, *Using the IR remote*). If you make a mistake in assigning or changing the projector number, press to cancel.

**Network Routing**

*NOTES: 1) Not applicable for stand-alone projectors or simple serial networks with only one type of controller and linking.*



**SEPARATE:** Select “Separate” (factory default) to keep RS232, RS422 and Ethernet messages on their respective paths instead of being broadcast to the other types of ports. In Figure 3.17A, RS422 controls only the projector to which it is connected. In Figure 3.17B, either RS232 or RS422 will control the network.



**Figure 3.17. Using the “Network Routing” Option**

**RS232 AND RS422 JOINED:** Messages originating from an RS232 or RS422 controller will be relayed to all RS232 or RS422 ports. Any Ethernet communication, however, will not.

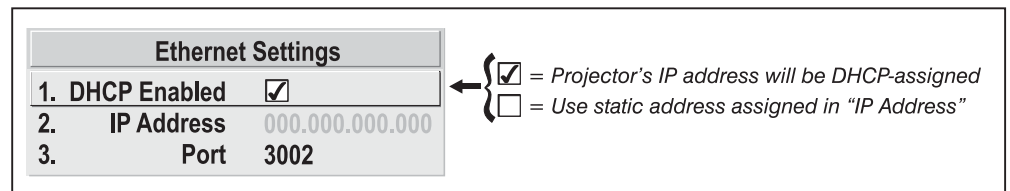
**RS232 AND ETHERNET JOINED:** Messages to and from the RS232 ports will also be relayed to the Ethernet port, and vice versa. Any RS422 communications will be isolated.

**ALL JOINED:** All messages reach all ports, regardless of type.

**Ethernet Settings – SUBMENU**

*NOTES: 1) Recommended for network administrators only.*

**DHCP:** Enable this checkbox if you want a DHCP server to automatically change the projector’s default IP address (0.0.0.0) to one that is valid and unique for use on the current Ethernet network. On networks without a DHCP server, or to simply override the automatic DHCP server function, delete the checkmark and enter the new “IP Address” settings desired. Remember that only a 0.0.0.0 address will trigger the DHCP addressing service, and only when the DHCP checkbox is enabled.



**IP ADDRESS:** Enter a valid and unique IP address for use on the network to which the projector is currently connected. This address will overwrite any previous IP address such as the projector’s factory-defined default (0.0.0.0), or one that has been assigned by a DHCP server or other user. It takes approximately 10 seconds for the projector to respond at its new address.

**PORT:** On some Ethernet networks, firewall restrictions may require that the port number of the projector be changed from its default of 3002. If so, enter a new valid port number here.

### Broadcast Key

Enter a checkmark if you want keypad commands sent to one projector to be relayed to all projectors in a serial network. Note that the **(Proj)** key will temporarily “override” the effect of a broadcast setting and allow you to control a specific projector when necessary. Disable the setting for all but one (any) projector in a network.

### Backlight

Toggle to turn the built-in keypad backlighting on and off.

### Front IR / Back IR

As needed for your application, set to “on” so that the front and/or rear IR sensor locations on the projector respond to the IR keypad. Set to “off” to disable.

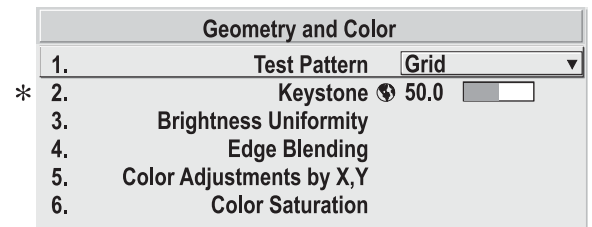
To disable *both* IR sensors, you cannot use the IR remote to select the second **OFF** setting. This safeguard prevents accidentally disabling an IR keypad while you are using it. Instead, use either the built-in keypad or a wired remote (optional) to set the remaining active sensor to **OFF**. The projector will no longer respond to an IR remote.

### Wired Keypad

The wired keypad is ON by default to when connected to the rear of the projector. The projector will then respond to incoming commands from this port. To disable the wired keypad, you must use a different keypad—the built-in or an IR remote—to select “off”. This safeguard prevents you from accidentally disabling the wired keypad during use.

## System Configuration ➤ — GEOMETRY & COLOR —

In the *Configuration* menu, select the *Geometry and Color* submenu when you need to modify overall color performance and/or image geometry for all sources.



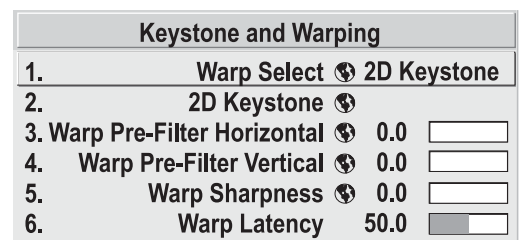
\* *Keystone and Warping if ChristieTWIST warping module is present (standard in Matrix models, optional in all others).*

### Test Pattern

Choose the desired internal test pattern, or select OFF to turn off a test pattern. Alternatively, use the **(Test)** key for cycling through test patterns.

### Keystone and Warping

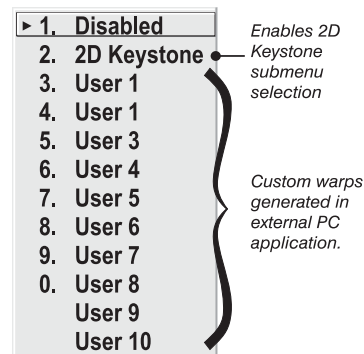
*NOTE: To see the submenu at right requires the ChristieTWIST™ warping module, which is standard with Matrix projectors. Without this module, this submenu is replaced with a sliderbar for adjusting **Keystone** – all other projectors will have this. Refer to the description provided later in this section.*



Use the *Keystone and Warping* submenu to shape your images using new corner points and/or to apply customized curved image boundaries (warps).

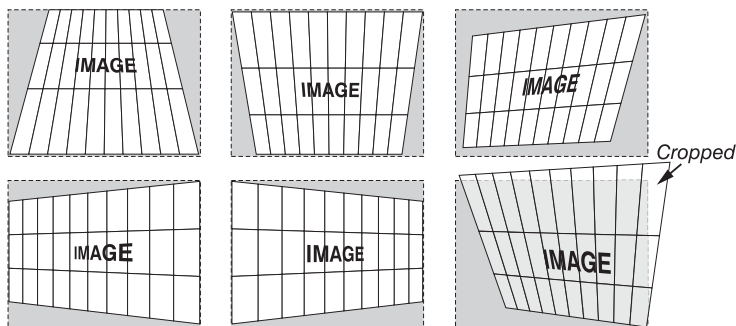
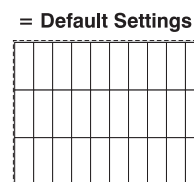
**WARP SELECT:** Choose a type of image shaping to apply, or choose to disable these adjustments. Settings apply to all sources.

- ❑ **Disabled:** Display standard (rectangular) images with no warping or keystone adjustments applied.
- ❑ **2D Keystone:** Move 4 corners of the image to correct for a keystone image and/or to create an unusual 4-sided image exhibiting perspective or distortion. See *2D Keystone*, below.
- ❑ **User 1-10:** Apply a custom image shape or twist that has been defined in the *ChristieTWIST™ Basic v1.0* PC application and downloaded to projector memory, typically creating one or more “squeezed” or stretched areas in the display. If no custom warps have been created, the User options will have no effect.



**2D KEYSTONE:** Move one or more corner points as desired for your application. Traditionally, keystone adjustments simply correct an image in which opposing sides are inclined away from each other (caused by tilting the projector in relation to the screen). If the lens surface is parallel to the screen and settings are 50.0, the image should appear rectangular.

2D Keystone	
1. Top Left H-Position	50.0 <input type="text"/>
2. Top Left V-Position	50.0 <input type="text"/>
3. Top Right H-Position	50.0 <input type="text"/>
4. Top Right V-Position	50.0 <input type="text"/>
5. Bottom Left H-Position	50.0 <input type="text"/>
6. Bottom Left V-Position	50.0 <input type="text"/>
7. Bottom Right H-Position	50.0 <input type="text"/>
8. Bottom Right V-Position	50.0 <input type="text"/>



**Figure 1. Moving the Corners for 2D Keystone**

Alternatively, move the corner points to create a specific 4-sided image in which corners are up to 25% closer to the center of the image, or which are cropped off.

**WARP PRE-FILTER HORIZONTAL:** Adjust as desired to smooth or sharpen side-to-side clarity in a warped image. An increase will appear to blur horizontal lines.

**WARP PRE-FILTER VERTICAL:** Adjust as desired to smooth or sharpen top-to-bottom clarity in a warped image. An increase will appear to blur vertical lines.

**WARP SHARPNESS:** Adjust as desired to soften or sharpen the overall image, similar to a *Detail* adjustment.

**WARP LATENCY:** Set the percentage of frame delay (default = 50.0) desired for displaying incoming data. A higher or lower setting will typically be needed with significant warps, ensuring that all of the image appears. Warp latency also provides a means of synchronizing one display with adjacent displays or other equipment such as audio.

*NOTE: If a ChristieTWIST™ module is installed, the Edge Blending menu controls are expanded to include user-defined blends appropriate for a warped image. The new blend ranges are 0-80 for side blends, and 0-60 for top or bottom blends. If no warping is currently applied but you still need to use edge blending for a tiled wall, select “Standard”.*

**Keystone**

*This option is available when the ChristieTWIST™ module is not installed.*

Use to correct a keystoneed image shape in which both sides of the image are inclined toward the top or bottom edge. Keystone is typically caused by tilting the projector in relation to the screen so that the lens surface and screen are no longer parallel to each other. (Figure 3.18)



**Figure 3.18.**

**Brightness Uniformity — SUBMENU**

*Brightness Uniformity* provides further refinement of displays already matched for their primary colors and overall light output. Use *Brightness Uniformity* to create an exceptionally smooth image in which no area appears brighter and/or more red, green or blue than another. In the *Brightness Uniformity* menu, enable the “Uniformity Enable” checkbox to access a multitude of adjustments for critical color light output control in specific areas throughout the image. Your settings apply as long as the “Uniformity Enable” checkbox is enabled and you are using a “User” color temperature defined by the *Brightness Uniformity* controls. To disable the *Brightness Uniformity* function, delete the “Uniformity Enable” checkmark.

*NOTE: See also 3.10, Using Multiple Projectors for the complete step-by-step procedure for achieving uniform brightness in adjacent displays.*

**Edge Blending — SUBMENU**

*The Edge Blending submenu provides a range of controls for smoothing together the overlapping bright edges of multiple adjacent projected images to create a single larger “seamless” image. These controls, which primarily affect whitelevels, are typically used in conjunction with mechanical lens blinders (optional), which are installed on the front of the projector and which primarily affect blacklevels. NOTE: There is a center line (both horizontal and vertical) in the Edge Blending test pattern. The intersection of these lines is the true center of the projector’s display area.*

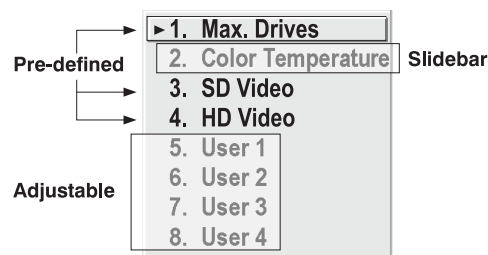
*NOTE: See also 3.10, Using Multiple Projectors.*



### Color Adjustments by X/Y, and Color Saturation — SUBMENUS

**NOTES:** 1) For defining or changing a User 1, 2, 3, or 4 color performance or “gamut”. Sometimes known as Comprehensive Color Adjustment™. 2) Factory-defined primary color levels, which ensure a specific color performance from projector-to-projector, can be calibrated in the **Service** menu only. If you suspect alteration of these defaults, the factory settings can be recovered with selection of “Reset to Factory Defaults?” in the **Color Primary Settings** submenu accessed via the **Service** menu (password-protected).

From the factory, the projector can utilize any of the 3 pre-defined color performance settings identified at right (default=Max Drives), or colors can be driven on the basis of color temperature. For most applications, one of these gamuts will produce accurate and realistic colors from a variety of sources. They can be applied at any time in the *Advanced Image Settings* menu (“Select Color Adjustment”), and are not adjustable.



**Figure 3.19. Color Gamut Choices**

**DEFINING “USER” COLOR GAMUTS:** In some cases, you may find that none of the pre-defined “Select Color Adjustment” options exactly suit your needs. For example, you may require a unique color gamut (range) for a single projector or application, or you may need to precisely match colors across multiple adjacent displays. In such cases, use the *Color Adjustments by X,Y* or *Color Saturation* submenu to define the precise *hue* of each primary color component (red, green, blue, and white) used to generate the millions of colors produced in displays. You can create up to four custom color gamuts (User 1, 2, 3, or 4) with these adjustments.

Note that the two menus differ only in their user interface, so use whichever menu best suits your needs and application. A color meter can help with adjustments.

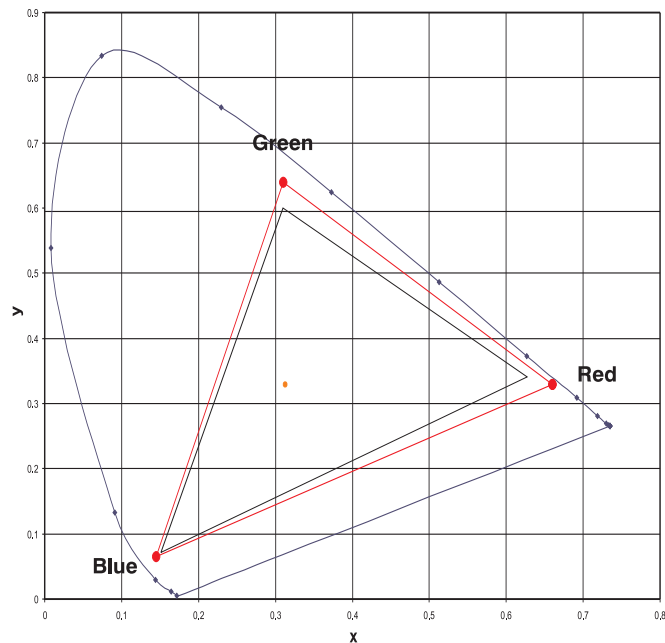
- *Color Adjustments by X,Y* — Enter known x/y coordinates from the chromaticity graph.
- *Color Saturation* — Adjust color sliders and judge image color by eye or meter.

A user-defined color “adjustment” can be applied by selecting it in the *Advanced Image Settings* menu (“Select Color Adjustment”).

**COLOR ADJUSTMENT BY X,Y:** Use this submenu if you want to create, alter or copy a color gamut (i.e., “color adjustment”). Controls in this menu define the precise hue of each primary color component (red, green, blue, and white) used to generate the millions of colors produced in displays. The x/y coordinates for each color define its location on the standard CIE chromaticity graph (see Figure 3.20)—changing either or both of these numbers will change the hue of the color, and relocate the “triangle” for possible colors. For example, changing the x/y coordinates for red may move the color closer to orange or closer to violet, which will in turn affect all displayed colors having a red component. Adjust the slidebars or enter new specific coordinates as desired to define or change up to four “User” color gamuts needed for your environment and applications. Apply at any time in the *Advanced Image Settings* menu.

Color Adjustments by X,Y			
1.	Select Color Adjustment	User2	
2.	Color Temperature	6521	<input type="text"/>
3.	Red X	0.655	<input type="text"/>
4.	Red Y	0.341	<input type="text"/>
5.	Green X	0.332	<input type="text"/>
6.	Green Y	0.575	<input type="text"/>
7.	Blue X	0.144	<input type="text"/>
8.	Blue Y	0.093	<input type="text"/>
9.	White X	0.320	<input type="text"/>
0.	White Y	0.330	<input type="text"/>
Auto Color Enable			<input checked="" type="checkbox"/>

**Figure 3.20. Customize Color**



**Figure 3.21. CIE 1931 Chromaticity Diagram**

*NOTE: Keep new x,y coordinates within the original color gamut triangle shown here.*

**PROCEDURE FOR X,Y ADJUSTMENTS:** See 3.10, *Using Multiple Projectors.*



**COLOR SATURATION:** Use this submenu if you do not have specific color coordinates in mind and will simply judge color performance by eye or meter. Like the *Color Adjustment by X,Y* submenu, each color control actually defines new x/y coordinates for that color and changes its hue—it is just a different interface.

Adjust the hue of each primary color (red, green, blue, and white) by using more or less of it in relation to the other colors.


Color Saturation		
1.	Select Color Adjustment	User 4
2.	Color Temperature	6521 <input type="text"/>
3.	Red Color Adjustment	
4.	Green Color Adjustment	
5.	Blue Color Adjustment	
6.	White Color Adjustment	
7.	Auto Color Enable	<input type="checkbox"/>
8.	Color Enable	White <input type="text"/>
9.	Copy From	Color Temperature <input type="text"/>
0.	Lamp	

**Figure 3.22. Customize Color**








*NOTE: A Color Saturation adjustment defines the corresponding x/y coordinates shown in the Color Adjustment by X,Y submenu. These x/y coordinates will remain stable for this User gamut until they are changed again via either menu. Values displayed in the Color Saturation menu, however, will likely fluctuate as you use the projector, and will be different when you return to this menu at some point in the future. These floating changes do not affect the x/y coordinates or gamut.*

## System Configuration **➤** DIAGNOSTICS / CALIBRATION

### Test Pattern

Choose the desired internal test pattern to display, or select OFF to turn off a test pattern. Alternatively, use the  key for cycling through test patterns.

*NOTE: There is a center line (both horizontal and vertical) in the Edge Blending test pattern. The intersection of these lines is the true center of the projector's display area.*

Diagnostics and Calibration		
1.	Test Pattern 	Grid <input type="text"/>
2.	Grey Level 	512 <input type="text"/>
3.	Freeze Image 	<input type="checkbox"/>
4.	Color Enable 	White <input type="text"/>
5.	Odd Pixel Adjustment	
6.	Color Wheel Calibration	
7.	Peak Detector 	<input type="checkbox"/>
8.	Level Detector 	<input type="checkbox"/>
9.	Level Value 	512 <input type="text"/>

### Test Pattern Grey Level

Set the desired level of grey for displaying in the full gray field test pattern.

### Freeze Image

Enter a check mark to freeze (stop) an image on a single frame. This diagnostic tool is useful if you need to examine in detail a still version of an incoming image that cannot be “frozen” at the source. For example, in moving images it is sometimes difficult to observe artifacts such as external deinterlacing/resizing and signal noise. Remove the checkmark to return back to normal.

### Color Enable

Select which color or colors you want to see. This is useful while working with color temperature, input levels or other special setup parameters. Colors can also be

enabled/disabled by entering the corresponding function code listed on the back of the standard IR remote.

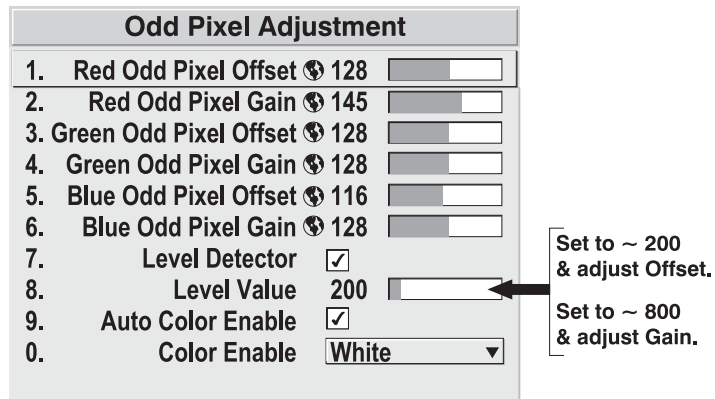
**Odd Pixel Adjustment**

*NOTES: 1) Factory-set and rarely required by user. 2) Source must be >90 MHz.*

When using certain RGB sources, you may need to adjust the normal gain or offset of odd pixels in relation to even pixels. This will smooth out very narrow (1-pixel wide) “checks” or vertical stripes that indicate adjacent “on” and “off” pixels. Using the Level Detector simplifies this process (see Figure 3.23):

1. Use an external analog native-sized continuous grayscale test pattern with at least 256-levels.
2. Turn “Level Detector” on.
3. Set “Level Value” to ~200. The image should now be black-and-white (or black-and-one color, if you use “Color Enable” function).
4. Adjust *offset*. Half of the pixels will move, the other half will not.
5. Adjust until the two transition regions overlap. The stripe of noise will be minimized, defined by the value in the sidebar.
6. Set “Level Value” to ~800. The image should now be black-and-white.
7. Repeat Steps 4 and 5, but adjusting *gain*.
8. Repeat Steps 3-7 for all remaining colors. Your RGB source should now be OK.

Two sets of values are automatically saved with these controls—one value for Input #1, and one for Input #2 (analog). The current set of values depends on which source is in use. This enables a source to be processed correctly via 2 different inputs.



**Figure 3.23. Using “Odd Pixel Adjustment”**

*NOTES: 1) Adjust offset before gain, since offset affects gain. 2) A value of 128 represents no change in normal odd pixel offset or gain. 3) Odd Pixel Adjustment eliminates “1 pixel on, 1 pixel off” artifact only, not any type of larger artifacts.*

### Color Wheel Calibration — SUBMENU

The *Color Wheel Calibration* submenu allows you to set the timing of the two color wheels in the projector. It is important the color wheels are correctly calibrated for the colors and shades in the displayed image to appear the same. Incorrectly calibrated, the colors will appear in various unmatched shades throughout the image. *Typically, this adjustment is only required when a color wheel is replaced.*

Color Wheel Calibration	
1. Color Enable	<input checked="" type="checkbox"/>
2. Color Wheel 1 Delay	148 <input type="text"/>
3. Color Wheel 2 Delay	145 <input type="text"/>
4. Lamp Operation	Single Lamp 1 ▾

1. Select the single lamp operation mode that corresponds to the color wheel you want to calibrate. For example, select “Single Lamp 1” when calibrating color wheel 1 and “Single Lamp 2” when calibrating color wheel 2.
2. Enter the *Color Wheel Calibration* submenu – the *Color Ramp* test pattern will automatically display and the “Color Enable” option will automatically switch to White.
3. Adjust “Color Wheel 1 (or 2) Delay” so the transitions across each color bar appears smooth.
4. Repeat Step 1 – Step 3 for the other color wheel. *NOTE: Wait for 35 seconds when requesting a change in single lamp operation modes to allow for one lamp to warm up and the other to turn off.*
5. Verify adjustments by choosing different colors in “Color Enable”.

*NOTES: 1) Upon entering the Color Wheel Calibration submenu, the “Color Enable” option automatically switches to white and the color ramp test pattern displays.*

### Peak Detector

The “Peak Detector” is a fast method for defining individual input levels, and can improve the accuracy of input levels set by the Auto Input Level function. Enabling the “Peak Detector” activates a special operating mode for detecting *only* pixels that are considered black or white—all other levels are displayed as a mid-level gray. When used with a 16-step grayscale pattern in which the two black and white bands are known to be at opposite edges of the image, you can watch these isolated areas while adjusting individual blacklevels and input drives until both bands are just visible. Images from this source will then display correct blacks and whites without crushing or washing out.

*NOTE: If using Peak Detector with PIP, both images must have the same color space.*

### Level Detector

The “Level Detector” checkbox enables specific thresholds for blacks and whites—input levels that fall below a specified *Level Value* (see below) are displayed as black, and all others are displayed as white. It aids in Odd Pixel Adjustment. To use:

1. Enable “Level Detector” and display a continuous grayscale.
2. Set “Level Value” to near black (such as 200).
3. Adjust Offsets to minimize area of black stripe.
4. Set “Level Value” to near white (such as 800).
5. Adjust Gains to minimize area of white stripe.

**Level Value**

*Level Value* defines the value to be used by the Level Detector in recognizing blacks and whites. See *Level Detector*, above.

**System Configuration** ➤  
**OPTIONAL INPUT MODULES**

The single “Option Card” entry in the *Configuration* menu identifies which optional input module (a.k.a. *cards*) is present at **INPUT 5** (Option 1). If the option slot is empty, the corresponding read-only menu entry does nothing. If there is a module installed, the corresponding menu entry may activate a submenu of further options pertaining to that module.

For example, if the *Dual SD/HD-SDI* module is installed at **INPUT 5** (Option 1). The Option 1 Card submenu provides controls for configuring the various connections on this multi-input, multi-output module. As desired for your application, you can define 1) which physical input loops through to which output, and 2) which functional input (main or PIP signal) loops through to which output.

**3.7 Working with PIP or Seamless Switching**

PIP (Picture-in-Picture) and Seamless Switching are independent but related projector features that both utilize two image processing paths within the projector. In the case of Picture-in-Picture, this double processing enables you to display two different images simultaneously – typically a smaller “secondary” image within a large “primary” background. In a seamless switch, the double processing essentially occurs between displays so that a full image relayed from one source can smoothly transform into a full image from another source. This change can be virtually instantaneous, or slowed as desired so that the current image appears to dissolve or “fade” into the new image.

Options for enabling and controlling PIP and Seamless Switching all reside in the same menu. Note however, that because both features utilize the projector’s double processing capability, PIP and Seamless Switching cannot be used together. For example, fading a pair of PIP images into a new display from a different source is not possible.

For best PIP or Seamless Switching results, use two *different* signal types\* as defined below. Do not mix two signals of the same type.

Signal Type	Description (Input Location)
#1	5 BNCs (RGBHV or YPbPr)
#2	DVI - I (analog or digital)
#3	Decoded signals (Input 3, Input 4, Composite video, S-Video, or any video signal via Input 1 BNC connectors or via an analog option card).
#4	Analog Option Cards
#5	Digital Option Cards
#6	Digital Option Cards

\* *HD interlaced sources are not recommended for the PIP window.*

Other PIP or Seamless Switching tips to keep in mind include:

- When using 2 digital signals or 1 analog and 1 digital, each must be ≤ 165 megapixels.
- When using two analog signals, each must be ≤ 90 megapixels.
- Avoid using an interlaced source in the PIP window
- Seamless switching may affect image quality in some cases

**Working with PIP** ➤ *NOTE: To control the primary image, access all picture controls through the Main menu. To control the secondary (PIP) image, access picture controls through the Picture-in-Picture and Switching menu.*

Use the first of six options in the *PIP and Switching* menu to enable and define how you want to use PIP.

PIP and Switching	
1.	Swap Main and PIP Image
2.	PIP Enable <input checked="" type="checkbox"/>
3.	PIP Size & Position
4.	PIP Image Settings
5.	PIP Border Width 4 <input type="text"/>
6.	PIP Border Color Red <input type="text"/>
7.	Image Optimization Best Quality <input type="text"/>
8.	Fade Time 2.0 <input type="text"/>
9.	Numbers Select Main Image PIP Only <input type="text"/>

*Picture-in-Picture Options* (bracketed next to items 1-6)

*Switching Options* (bracketed next to items 7-9)

**Swap Main and PIP Image**

Toggle the current picture-in-picture relationship so that the primary (main) image becomes secondary (PIP), and the secondary image becomes primary. Swapping is available only when PIP is enabled.

*NOTE: There may be a slight delay when swapping the Primary and Secondary images.*

**PIP Enable**

**Short cut:** Press  on the remote.

Toggle to display from two sources at once (Picture-in-Picture) or the primary source only. This checkbox turns the secondary source on and off.



*NOTE: Disable PIP and Best Switching for Interlaced sources > 35kHz.*

**PIP Size and Position – SUBMENU**

Most controls in the *PIP Size and Position* menu adjust the PIP (secondary) image in the same fashion as their counterparts in the main *Size and Position* menu adjust the main image—see 3.5, *Adjusting the Image* for details. Exceptions are:

**POSITION PRESETS** –Set the location of the PIP (secondary) image in the display.

PIP Size and Position	
1.	Position Presets Bottom Right <input type="text"/>
2.	Size 0.729 <input type="text"/>
3.	Vertical Stretch 1.090 <input type="text"/>
4.	Pixel Track 858 <input type="text"/>
5.	Pixel Phase 0 <input type="text"/>
6.	H-Position 360 <input type="text"/>
7.	V-Position 262 <input type="text"/>
8.	Aspect Ratio Presets Anamorphic <input type="text"/>
9.	Reserved
0.	Advanced Size and Position

**ASPECT RATIO PRESETS** – Choose the desired aspect ratio for your PIP pixels. Use the “Default” aspect ratio when incoming format has square pixels (most common). This ensures that the resulting PIP image maintains its intended aspect ratio. Use

“Anamorphic” for NTSC signals having narrower pixels--this will stretch the pixels horizontally to regain the intended aspect ratio of the PIP image. *NOTE: If the image is already resized at the source it will remain that way in the PIP window. If, for example, an NTSC signal is already set to anamorphic through the Resize and Preset menu it will remain that way in the PIP window. If the NTSC signal is formatted as widescreen at the source, then the image in the PIP window will appear with black bars above and below it.*

### **PIP Image Settings — SUBMENU**

Adjust the PIP (secondary image) without affecting the size or position. The primary image remains unchanged. See 3.5, *Adjusting the Image* for details

#### **PIP Border Width**

Set the desired line thickness for your PIP window border.

#### **PIP Border Color**

Select the desired color for the PIP window border.

*NOTES: 1) Numbers 7 and 8 on the Picture-in-Picture and Switching submenu control switching parameters. 2) Disable PIP in order to work with Seamless Switching. 3) Disable PIP and Best Switching for Interlaced sources > 35kHz.*

### **Working with Seamless Switching** ➤

Seamless Switching is the ability to instantly and/or smoothly switch sources, and is controlled with options 7 and 8 in the *PIP and Switching* menu. To use Seamless Switching, PIP must be disabled.

#### **Tips for best source switching:**

- Make sure a channel has been configured for each source.
- Progressive digital and analog sources are recommended.
- Set Image Optimization to Best Switching (see below).
- For best results, use the same frame rate and gamma setting for each.

*NOTE: Avoid using two Interlaced sources.*

#### **Image Optimization**

Choose whether to use Best Switching or whether you prefer to optimize image quality, whichever best suits your needs. When Best Switching is selected, sources are switched almost instantaneously without a dark state in between images. Eight-bit processing is used to maximize the opportunity for a seamless transition. Best Switching is recommended only when seamless switching is necessary. Best Quality maximizes allocated resources to maintain image quality by using 10-bit processing and a single source only. If selected, there may be a brief dark state between images.

*NOTE: Disable PIP and Best Switching for Interlaced sources > 35kHz.*

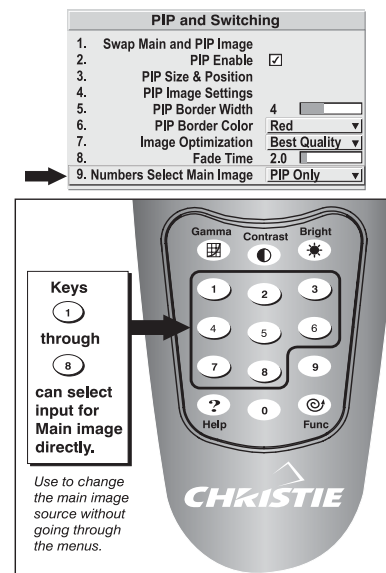
#### **Fade Time**

Set how long (in seconds) it takes to gradually dissolve one image into another for a source switch when Image Optimization is set to Best Switching. *NOTE: PIP must be disabled for Fade Time to take effect. Also, the PIP window must be closed to activate it.*

### Numbers Select Main Image

Use *Numbers Select Main Image* to use the numeric keys #1-8 as input keys. This remapping of the keypad (see right) can be particularly useful with PIP displays, providing a convenient shortcut for changing the primary (background) image without first having to return to the *Main* menu. To use the keys in this manner all of the time, even with single displays, select *Always*. For normal keypad function, select *Never* (default). Set to *PIP Only* to use activate number keys only when PIP is in use.

**NOTE:** *Numbers Select Main Image* keypad functionality works only when menus are closed.



## 3.8 The Lamp Menu

The dual lamp illumination system used in this projector gives you the flexibility to choose an operation mode (single lamp or dual lamp) to suit the specific needs of your installation. The unique lamp auto-switching feature also provides the potential to operate the projector for extended periods without interruptions related to lamps or lamp replacement.

A complete understanding of how the projector works is critical in effectively maintaining its continuous operation. The *Lamp Menu* and the options provided, such as selecting a lamp operation or power mode and monitoring lamp status can help in achieving bright, uninterrupted projection.

### About lamp operation, modes and auto-switching

The projector by default is set to power on in *Dual Lamp* mode. No light appears on the wall during the first 25 seconds of power up, as this is the time it takes to ignite the lamps. As the lamps warm up to their full potential, you will notice brightness gradually increasing. Before sending a keypad command, wait for the projector to complete its initialization phase (“ON” will appear in the status LED display), otherwise the request will be ignored. After this time, you can switch to one of the Single Lamp modes or make any other software request.

On rare occasions, a lamp may not ignite on the first attempt. A brief description of what you will notice in each of the lamp modes is described below.

- **In Dual Lamp mode**, only the light from the lamp that successfully ignited will be seen on the wall. In this case, the projector will wait 90 seconds and try re-striking the lamp. The projector will attempt only 2 re-strikes of the lamp. If it fails to turn the second lamp on it will automatically switch to the Single lamp operation mode for the lamp that was successfully turned on. If during one of its retries, the projector successfully turns the second lamp on, the lamp operation mode remains in Dual Lamp.

If *both* lamps fail at the same time, an error is reported and the projector automatically powers down.

- ***In Single Lamp mode***, the projector will try to strike the lamp again in 90 seconds (considered re-strike #1). Only after the third attempt (re-strike #2) will the projector declare the lamp as “*Failed to Strike*” (in Lamp submenu) and automatically switch to the single lamp operation mode for the lamp that was not ignited. All lamp specific menu options will then change to reflect the true lamp operation mode of the projector.

*NOTE: P-VIP lamps, by nature, do not successfully ignite when “hot” and therefore the 90 second wait period is taken by the projector before each strike attempt and between powering the projector down and up again.*

Lamp operation modes will also automatically change if there is a failure of one of the lamp related components, such as the lamp driver, color wheel or fan. An error code will be displayed in the status LED or through the RS-232 serial communications log that indicates which component has failed. The lamp status will also show one of several messages that points to the failed component. The lamp in this instance is typically still okay and does not require replacement.

**MANUALLY SWITCHING FROM DUAL TO SINGLE LAMP MODE** – Switching from dual to single lamp operation mode occurs immediately. The result is an instant dimming of the displayed image. At this time, you can modify the lamp power or adjust other settings to increase desired brightness.

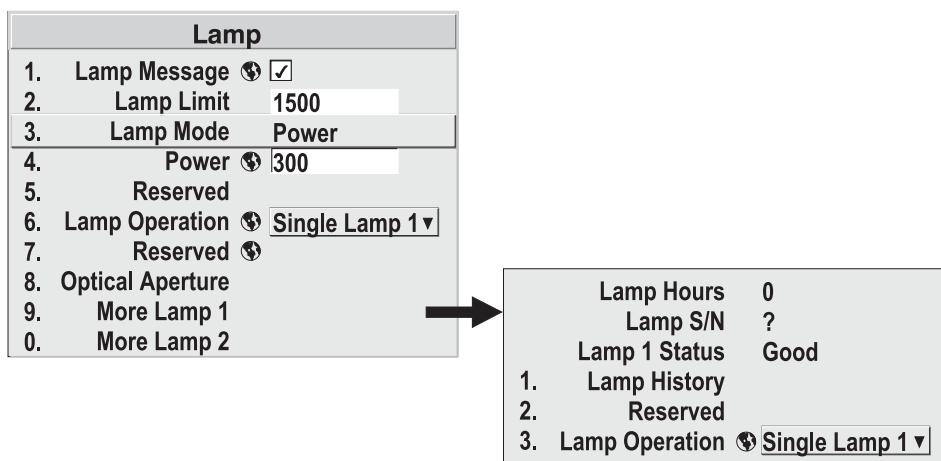
**MANUALLY SWITCHING FROM SINGLE TO DUAL LAMP MODE** – When you manually switch from a single lamp mode to the dual lamp mode, the projector immediately tries to ignite the second lamp. If the first attempt to ignite the lamp fails it will wait 90 seconds and try again.

**MANUALLY SWITCHING BETWEEN SINGLE LAMP MODES** – When manually switching between single lamp modes, there is a 35 second overlap when both lamps are on. This overlap allows the “new” lamp to warm up before the other lamp is turned off. The new lamp operation mode displays immediately in the menus. Only after the third attempt (re-strike #2), will an error message display to indicate the type of error that was detected. If no specific error is detected, then the error will be “*Failed to Strike*”. If this occurs, the first lamp will not turn off and the projector will continue to operate in the original lamp operation mode. In summary, it could potentially take the projector up to 4.5 minutes to successfully switch lamp modes. The projector will attempt to maintain light on the wall during this time. *NOTE: If a problem is fixed before the last strike attempt the lamp could turn on.*

If a lamp fails during operation, the projector will immediately attempt igniting the other lamp if it’s not already on. Only in this case, will there be a brief interruption in the display.

*NOTE: A lamp will naturally decrease in brightness as it ages. Lamp life can also be decreased further by a frequent change in lamp operation modes (number of times its ignited).*





**Figure 3.24. The Lamp Menu**

**LAMP MESSAGE** - Enter a checkmark to enable a warning message that will appear upon power-up when the lamp has reached the specified lamp limit and should be replaced. Delete the checkmark to prevent display of this message—instead, when your lamp expires only the status LED display will provide the visual warning to replace the lamp.

*NOTES: 1) It is recommended that the Lamp Message checkbox remain enabled. 2) If a lamp warning message appears during power-up, press **Exit** to temporarily cancel the message. The message will continue to appear upon power-up until you install a new lamp.*

**LAMP LIMIT** - Set the lamp limit to the number of hours you expect to log on the current lamp before replacing it. The limit by default is 1500 hours.

**LAMP MODE** - Select a lamp mode to control the light output of your projector — select “Max Brightness” to run the lamp as brightly as possible or “Power” (default) to continually run the lamp at the specific wattage set by adjusting the **POWER** sidebar.

**POWER** - Adjust the sidebar when **LAMP MODE** is set to “Power”, to indicate the number of watts (250-300) applied to the lamp. In general, a lower power level generates a dimmer image. Specifying a maximum power level is the same as operating in “Max Brightness” mode.

**LAMP OPERATION** - One of the key features of the projector is that it can be operated with one or two lamps on. From the pull down list, select the lamp operation mode you want to operate the projector in. “Dual Lamp” is the default.

- **DUAL LAMP** - Select “Dual Lamp” to operate the projector with both lamps on. In this mode, you can achieve maximum brightness output by the projector. Refer to *Lamp Operation and Switching* on the previous page for more details on how the projector behaves when in this mode.
- **SINGLE, LAMP #1 OR SINGLE, LAMP #2** - Select “Single, Lamp 1” or “Single, Lamp 2” to specify the lamp you want to operate the projector with. The other lamp remains in “reserve” and will only turn on if the current lamp “fails” for some reason or if the mode is manually selected.

*NOTES: 1) The projector will automatically shutdown if it detects both lamps have “failed” (this includes lamps not installed). 2) The lamp operation mode will not automatically switch to a previous mode once a “failed” lamp is replaced. It must manually be selected. 3) It takes approximately 25 seconds for a cold lamp to reach full brightness when it is first turned on. 4) Power is cut to a lamp only when the lamp operation mode is switched to the other lamp. **IMPORTANT** - the original lamp stays on for 35 seconds to allow the new lamp to warm up before power is cut and lamp operation modes change.*

**MORE LAMP 1 (MORE LAMP 2)** - There are two separate lamp submenus that can be accessed from the *Lamp* menu. Each submenu is dedicated to one lamp – you can view specific lamp information, such as lamp hours, lamp history and the current status of the lamp. You can also change lamp operation modes.

**LAMP HOURS** - This read-only information shows the current number of hours logged on the current lamp. Whenever a new lamp serial number is detected it begins to log time for the new lamp. This information also appears in the *Status* menu.

**LAMP S/N** - This read-only information displays the serial number for the current lamp. *NOTE: When a lamp is installed, the projector automatically detects the serial number and displays it here. The serial number is not manually entered.*

**LAMP 1 (OR 2) STATUS** – This read-only information displays the current status of a lamp and can be viewed any time during operation. Refer to the list below for the possible lamp status messages and their meaning:

- **“Good”** continually appears as the status until there is a failure with one of the lamps. Then one of the other error messages will display.
- **“Failed to Strike”** will display when the projector fails to turn a lamp on. This may or may not be lamp related. Further investigation is required.
- **“Lamp Not Installed”** will display when a lamp is not detected. If present, check to ensure the lamp is fully inserted and connected to the terminal block.
- **“Turned Off Unexpectedly”** will display when a lamp or lamp related component, such as a lamp driver fails. Check for an error code on the status display.
- **“Interlock Tripped”** will display when the lamp door is opened for a lamp that is still on. In this case, the lamp will automatically be turned off.
- **“Cooling Fan #8 (or #10) Failed”** will display when one of the corresponding lamp fans fail. (Cooling fan #8 is associated with Lamp #1 and Cooling fan #10 with Lamp #2)
- **“Color Wheel Stopped”** will display when a color wheels ceases operation.
- **“Operation Error”** will display when the lamp driver reports an operation error and the lamp is off. This typically occurs when trying to turn on a hot lamp.
- **“Driver Vcc too Low”** will display when a lamp driver fails.

**LAMP HISTORY** - This read-only option lists the lamp serial number and corresponding lamp hours of the lamp most recently installed. *Lamp History* is automatically updated when a new lamp is installed.


Lamp 1 History	
S/N	Hours
1234	1999
5679	23

### 3.9 Status Menu

The read-only *Status* menu lists a variety of details about the standard and optional components currently detected in the projector. Refer to the *Status* menu for versions of hardware and software installed, the type (size) of lamp, the hours logged in total and for a specific period (such as a rental period), and for your projector model name and serial number. In addition, the *Status* menu identifies the current channel, its location, its frequencies and other details.

Scroll the full *Status* menu using  . Use   for page up/down.

### 3.10 Using Multiple Projectors

When an installation requires multiple projectors, you can use the RS232 serial ports to daisy-chain the units together and control the group with a single keypad or a computer/controller connected to the first projector. In such a network, you can choose to broadcast commands to the entire group, or use the  key as desired to limit responses to an individual projector.

Alternatively, you may want to add projectors to a hub on an Ethernet network. See 2.6, *Connecting Multiple Projectors* for full routing details.

*NOTE: Refer back to 3.6, Adjusting System Parameters and Advanced Controls for complete information about communicating with multiple projectors.*

#### Matching Colors In Multiple Screens

➤ In a multiple-projector wall, you will likely want to precisely match color and intensity from image-to-image so that the full wall is as uniform as possible. This matching is typically done in conjunction with brightness uniformity and edge blending.

#### Preliminary Calibration

As a final part of the manufacturing process, all primary colors in the projector are precisely set to pre-established values to ensure that overall color performance is optimized and is as accurate as possible (refer back to Figure 3.21). Upon installation at a site, however, lighting and other environmental factors may slightly change how these colors appear on your screen. While the change is negligible in most cases, you may prefer to recover the originally intended color performance before trying to match colors from several projectors. Or you may be renting a projector in which the colors were corrected for use at its previous site, but are not ideal for yours.

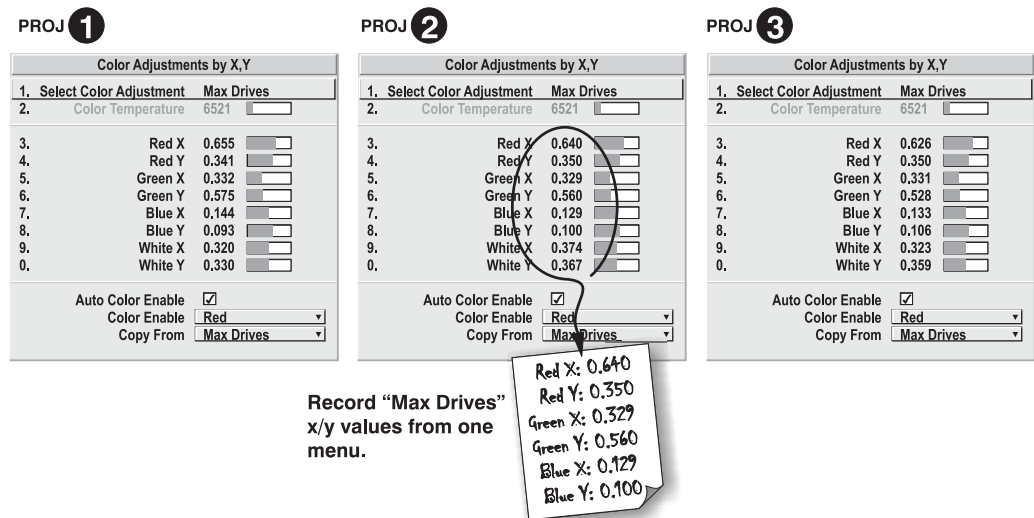
The recommended first step in achieving such consistency is to use a color meter to measure the native primary colors—red, green, blue, and white—as they appear at the screen and record these as *Color Primary Settings* in the *Service* menu (password-protected) for each projector. On the basis of these new values, which are stored in memory, each projector will then automatically calculate any necessary corrections to reproduce the original factory colors under the current environmental conditions. This essentially calibrates a projector to its surroundings, compensating for factors such as screen type, lamp and/or ambient lighting that can alter the final color characteristics on-screen, and will improve color accuracy and consistency in a group of projectors. It ensures a good starting point for further customizing and matching; however, is not critical for all installations.

To return to the factory-set color primaries, such as when a projector is moved to different site, you must access the *Service* menu (password-protected). Select the *Reset to Factory Defaults?* option in the *Color Primaries* submenu. Then repeat the calibration process describe above, if desired, and continue with matching of colors.

### Color Adjustment Procedure

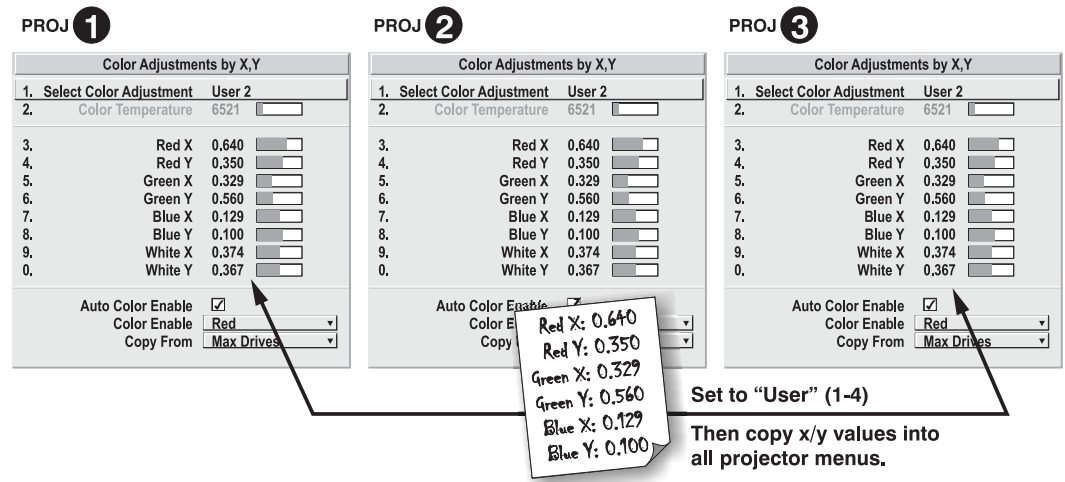
Once the *Color Primary Settings* are calibrated for the site (see above), use the *Color Adjustments by X,Y* or *Color Saturation* menu to further refine each projector’s fundamental colors so that the hue and intensity of each color appears the same from one display to another. Once matched, you will have created a single new shared range of colors or “color gamut” that all of your projectors can produce. This palette—named User 1, 2, 3 or 4—can be applied or disabled for a source at any time throughout a bank of adjacent displays, simplifying both the setup and maintenance of a “seamless” wall.

1. Set up and optimize all projector settings. You can ignore color temperature, since you will be redefining color performance in this procedure, but do optimize each projector in every other aspect. Closely align all screen edges.
2. Assign projector numbers to make communications easier. Use desired keypad.
3. Use the same lamp mode for all projectors, and do the following:
  - ❑ Set *Select Color Adjustment* to “Max Drives”
  - ❑ Display a full white test pattern
  - ❑ Adjust lamp power and Optical Aperture until adjacent white fields appear the same brightness.
4. Display the *Color Adjustments by X,Y* menus for all projectors. Each menu shows the x/y coordinates defining the “Max Drives” color gamut for this projector. Jot down the values shown in one (any) of the displays. See Figure 3.25. Or use the “Copy From” function to copy them into a “User” gamut in one projector.



**Figure 3.25. Jot Down a Set of “Max Drives” X/Y Values**

5. In each projector, select a “User” color adjustment (1-4) to enable *Color Adjustments by X,Y* changes. Then enter your recorded x/y values into each menu (Figure 3.26).



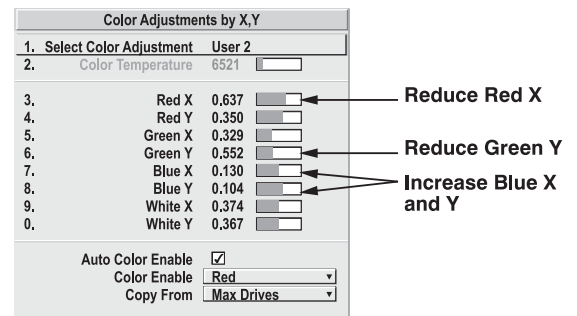
**Figure 3.26. Copy X/Y Values into All Projectors**

6. In each projector, judge by eye and adjust x/y coordinates slightly in the following manner:

- ❑ To match reds, decrease “Red X” until full field red screens match.
- ❑ To match greens, decrease “Green Y” until full field green screens match.
- ❑ To match blues, increase both “Blue X” and “Blue Y” until full field blue screens match.

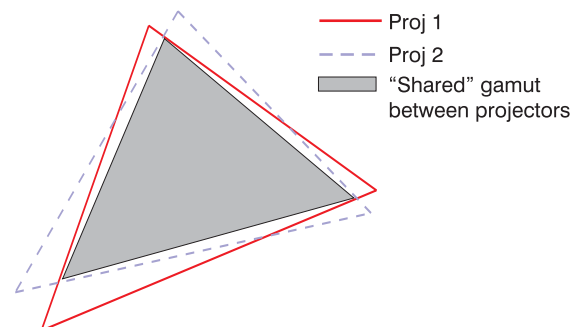
*NOTE: For speed, enable the “Auto Color Enable” checkbox. Each color coordinate you select will then automatically trigger a full field display of the corresponding color.*

IN ALL PROJECTORS:



Alternatively, use the Color Saturation menu for these adjustments or to fine tune.

These coordinate adjustments move the three color points closer together (refer back to the chromaticity chart shown in Figure 3.21.) to establish a “shared” gamut attainable by all projectors in your group. Adjust only as necessary to ensure that the resulting color palette is as large as possible. When done, you may need to adjust lamp power slightly.

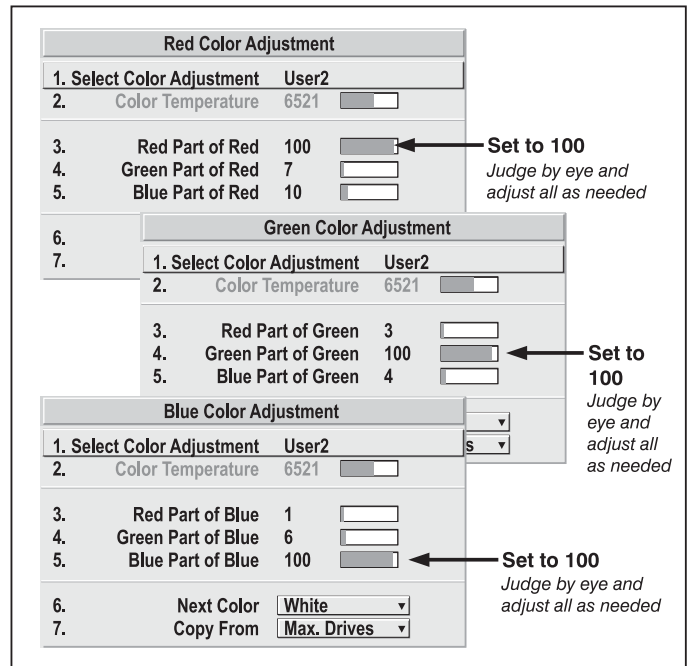


7. All screens should now be color-matched and will remain matched upon exit from the menus. Apply this new “User” gamut to a source at any time by selecting it in the “Select Color Adjustment” list accessed in the *Advanced Image Settings* menu.

### Using the Color Saturation Menu for Color Matching

You may prefer to use the *Color Saturation* menu to match colors across multiple screens. In the three *Color Adjustment* submenus (Red, Green, Blue—see right), set all main values to 100 and the secondary values to 0. Then judge by eye and adjust the slidebars as needed. Note that adjustments here define new x/y coordinates in the *Color Adjustments by X,Y* menu.

For best results, use this menu after doing the color adjustment procedure.



**Figure 3.27. Color Matching Using Color Saturation Menu**

### Achieving Brightness Uniformity

**WHAT IS BRIGHTNESS UNIFORMITY?** When used to refine screens already matched for their primary colors (see *Matching Colors in Multiple Screens*, above) and overall light output, proper adjustment of *Brightness Uniformity* can create an exceptionally smooth screen in which:

- no area of the screen appears more red, green or blue than another
- no area of the screen appears brighter than another
- color and light output from one screen closely matches adjacent screens

Although the *Brightness Uniformity* control can be used for a stand-alone projector, it is particularly useful for setting up and maintaining tiled images that form a cohesive display wall in which the color “cast” and light output appear uniform throughout each image as well as throughout the entire wall. The procedure provided here assumes a multiple-screen application.

#### **▲ Before You Begin**

Read through the entire procedure before attempting to adjust Brightness Uniformity controls, and keep in mind the following checklist of prerequisites and guidelines:

- ❑ **ADJUST COLORS FIRST**—Always adjust the primary colors as described in the “*Matching Colors in Multiple Screens*” procedure (above) before attempting to work with Brightness Uniformity. This ensures that primary colors, color temperature, and maximized light output are all well-matched from one screen to another. These matches are needed before you can achieve good Brightness Uniformity results.
- ❑ **RUN LAMP FOR 100 HOURS**—Light output and Brightness Uniformity can vary significantly during the first 100 hours of lamp use. For best results with new lamps, either set up Brightness Uniformity after this period, or do an initial setup and re-check at 100 hours.



- ❑ **SET LAMP POWER**—Make sure each “Lamp Power” setting is as high as possible for your application while still maintaining a good overall match of light output from screen-to-screen. By nature, achieving a *uniform* brightness will require a slightly reduced *overall* brightness—this reduction will help ensure that you have enough range of adjustment when examining brightness variables more closely from screen-to-screen, and will help prevent premature “maxing out” when trying to match to a certain color, zone or projector.
- ❑ **USE A “USER” COLOR TEMPERATURE**—Always adjust Brightness Uniformity for a *User* color temperature defined when you matched primary colors, and continue to use it for all sources displayed on the wall. Your other color temperatures will not necessarily be matched from screen-to-screen.
- ❑ **WHITE UNIFORMITY SLIDEBARS**—White Uniformity sidebar values may not reduce to “0”. Each sidebar adjusts overall light output in a specific screen zone, but the value shown represents the current setting for *green* in this zone. When other “hidden” values (red or blue) are lower than green, during adjustment in the White Uniformity menu their values will reach “0” first, causing the sidebar to stop earlier than expected.
- ❑ **JUDGE BY EYE OR USE A METER**—Good brightness uniformity can be achieved with either.

### Step 1: General Setup

- 1a) Adjust primary colors (see *Matching Colors in Multiple Screens*) to ensure matched overall color temperatures and light output between screens.

#### ⚠ IMPORTANT ⚠

**Double-check that all WHITES and LIGHT OUTPUT are well-matched.**

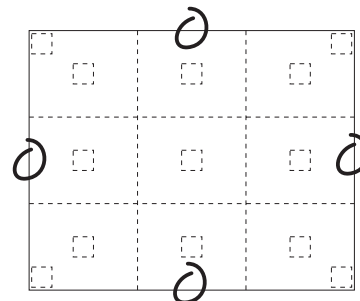
- 1b) Enable the *Brightness Uniformity* checkbox. This will enable access to the uniformity controls and will apply the settings to your image.

Brightness Uniformity	
1.	Uniformity Enable <input checked="" type="checkbox"/>
2.	Test Pattern <span>Off</span>
3.	Left Uniformity
4.	Right Uniformity
5.	Top Uniformity
6.	Bottom Uniformity
7.	White Uniformity
8.	Color Adjustment by X,Y
9.	Color Saturation
0.	Lamp

← Enable adjustment of options #3-7

- 1c) Select the 13 Point test pattern for display. This pattern provides 9 screen “zones” with 13 targets.

*FOR BEST RESULTS: Rather than examining the CENTER of each zone when assessing Brightness Uniformity adjustments, focus on extreme EDGES as indicated in the illustration at right.*



- 1d) In either *Color Adjustments* menu, select a “User” color. Then:

- *If you have created a “User 1” color gamut (recommended) for a well-matched wall, continue to Step 1e.*
- *If you prefer maximum brightness rather than a particular color temperature, select “Max Drives”.*



**Do not change User 1 Color Adjustment in color-matched applications!**

1e) In the *White Uniformity* menu, set the “Overall” output level to **50.0** and all remaining slidebars to **0.0**. This decreases the light output *just enough* throughout the screen so that any color level can then be *increased* later as necessary for matching light output from zone-to-zone. Do not exceed **50.0** for “Overall”—a higher level will likely interfere with achieving brightness uniformity and is not recommended.

White Uniformity		
1.	Left Side	0.0 <input type="text"/>
2.	Right Side	0.0 <input type="text"/>
3.	Top Edge	0.0 <input type="text"/>
4.	Bottom Edge	0.0 <input type="text"/>
5.	Top Left Corner	0.0 <input type="text"/>
6.	Top Right Corner	0.0 <input type="text"/>
7.	Bottom Left Corner	0.0 <input type="text"/>
8.	Bottom Right Corner	0.0 <input type="text"/>
9.	Overall	50.0 <input type="text"/>
<small>Adjust light output of entire screen.</small>		

← Set to 50.0

Ensure that overall light output remains well-matched from one screen center to the next. Where necessary, increase or decrease Lamp Power slightly to recover center matches.

**Step 2: Adjust Color (level of red/green/blue) in 8 Zones**

*NOTES: 1) At this point, ignore the **brightness** of individual zones. 2) Always ignore menu colors.*

- 2a) On each screen, compare the color temperatures in the 8 target zones (4 edges and 4 corners) to that of the color temperature of the center. Compare using a *white* field only, and take note of any areas that do not match the center. Also decide if any screen exhibits a more obvious color shift than other screens—begin with this screen in Step 2b.
- 2b) Return to the *Brightness Uniformity* menu. Beginning with the screen that exhibits the most obvious color shift(s), for each edge that exhibits a noticeably different color temperature from the center, select the corresponding *Uniformity* adjustment menu—*Left, Right, Top* or *Bottom*. For example, if any part of the left side is too blue, too red or too green, go to the *Left Uniformity* menu and adjust the colors (i.e., change their light output) until all portions of the left side closely match the center color temperature. Adjust an edge first (focusing on its center), then adjust its corners. See Figure 3.28



Match to color temperature of center zone

• Adjust **SIDE** first, then **CORNERS**  
• Focus on extreme **EDGES**

Left Uniformity		
1.	Left Side, R	5.6
2.	G	15.6
3.	B	35.2
4.	Top Left Corner, R	19.5
5.	G	35.1
6.	B	70.5
7.	Bottom Left Corner, R	71.3
8.	G	79.1
9.	B	68.1
Color Enable		White

Adjust light output of entire left side. Look at center of side.

Examine test pattern.  
Adjust color(s) in each zone as required, matching to center zone.  
**Recommended:**  
• 0~40 for edges  
• 0~80 for corners

**Figure 3.28. Match Zones to Center Color Temperature**

Repeat the color adjustment of sides and corners for each edge of the screen that does not yet match the center (note that each corner is adjustable in either of its two adjacent “side” menus). When done, all areas of a given screen should match. Repeat Steps 2a & 2b for all remaining screens.

### Step 3: Adjust Light Output in 8 Zones

**3a)** For each screen, compare the light output of each *edge* and *corner* to that of the *center*. If any of the areas differ, use the *White Uniformity* menu to match edges and corners to the center as described below (see Figure 3.9). Begin with the screen exhibiting the most obvious variations in light output.

- Adjust **edge** *White Uniformity* first—note that each edge adjustment also affects the rest of the screen slightly. Keep all edges just slightly *lower* than the center light output rather than matching light output precisely. Otherwise, it may not be possible to brighten the corners (typically the dimmest areas of the screen) enough. I.e., the best uniformity is a compromise between the brightest and darkest areas of the screen.
- Adjust **corner** *White Uniformity* last—each corner adjustment affects only this quadrant.
- Repeat for each screen.

Match light output to center zone

White Uniformity		
1.	Left Side	35.6
2.	Right Side	17.4
3.	Top Edge	9.2
4.	Bottom Edge	10.2
5.	Top Left Corner	35.1
6.	Top Right Corner	73.5
7.	Bottom Left Corner	3.0
8.	Bottom Right Corner	9.4
9.	Overall	50.0

Adjust light output of entire left side. Look at center of side.

Examine test pattern.  
Adjust light output in each zone as required, matching center zone.  
Do corners last.  
**Recommended:**  
• 0~40 for edges  
• 0~80 for corners

**Figure 3.29. Match Zones to Center Light Output**

### Step 4: Readjust Color Temperature (level of red/green/blue) in 8 Zones

**4a)** Return to Steps 2a & 2b and, if necessary, fine tune the zones so that they all still exhibit a single color temperature.

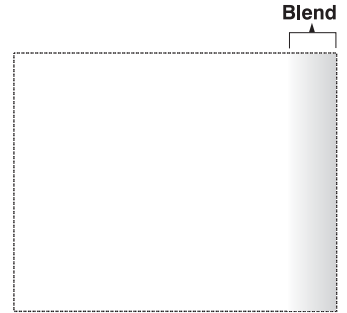
**Canceling Brightness Uniformity**

If you do not want to use or apply Brightness Uniformity settings, delete the checkmark from the “Uniformity Enable” checkbox at the top of the *Brightness Uniformity* menu.

**Edge Blending** ➤ Christie *Edge Blending* is an innovative set of software functions that can quickly and easily blend the edges of multiple adjacent full screen images to create a single seamless larger image.

**What is a Blend?**

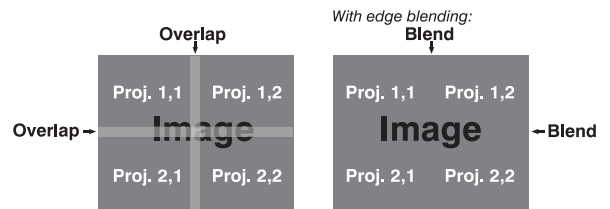
In simple terms, a blend appears as a gradient strip along an edge of a projected image. It is darkest along the extreme edge of the image, and lightens nearer to the rest of the image (see right). This area runs along the edge of the projector’s internal DMDs (display area); it cannot be located on interior pixels.



**Figure 3.30**

**How Are Blends Used?**

In multiple-projector walls, complementary blends between neighboring images can compensate for the extra “brightness” or intensity where these edges overlap. By controlling blend width and other properties, you can achieve uniformity across the group of images. Visible overlaps will disappear as illustrated in Figure 3.31.



**Figure 3.31. Edge Blending Concept (NOTE: TILING DONE AT SOURCE)**

For best results, use the same projector model and type throughout your display wall. In addition, avoid high-gain screens whenever possible—the optical performance of such screens demands minimal image offset, thus projectors must be located very close to one another. Note too that the requisite tiling of the image—with data repeated along internal edges that will overlap—must be correctly done by your source.

Standard edge blending software controls are located in the 2-page *Edge Blending* submenu access via *Configuration* menu, then *Geometry and Color* submenu, then *Edge Blending*. The *More* option opens the second page of the *Edge Blending* submenu.

**Main Functions**

Use standard edge blending controls to set the precise *width*, *shape* and *midpoint* you need to blend overlapping edges together smoothly.

- ❑ **Blend Width** determines how much area is used for blending along an overlapping edge. Slider values represent the number of 8-pixel steps used for the blend. For example, a setting of “3” creates a blended edge 24 pixels wide. A setting of “0” signifies no blending. For best results in most applications, use a blend width of 16-48 steps (128-384 pixels).

Ranges: 0-80 horizontal, 0-60 vertical.

- ❑ **Blend Shape** determines the rate of roll-off across the blend width, i.e. how quickly the white levels across the blend change from light and dark. Increasing the *Blend Shape* setting accelerates the rate of change at both extremes so that *less* of the region appears mid-gray (see Figure 3. 32).

Decreasing the *Blend Shape*

setting slows the rate of change so that *more* of the region appears mid-gray. For most applications, this subtle control is best left close to 50.

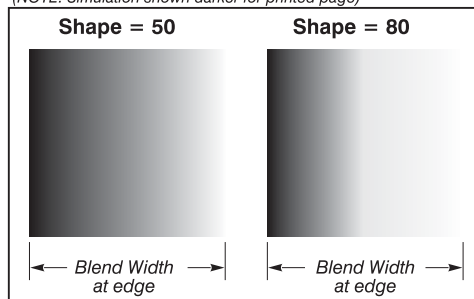
- ❑ **Blend Midpoint** determines the white level at the blend midpoint (the point equidistant between the beginning and end of the blend). Increasing the *Blend Midpoint* setting creates a blend that appears brighter than the rest of the image. Decreasing the *Blend Midpoint* setting creates a blend that is darker than the rest of the image. A setting of 50 means the midpoint is approximately 50% black—for best results in most applications, keep fairly close to this default.

- ❑ **Show Blending Overlap** turns your defined blend width area to solid gray so that two adjacent images can be seamlessly aligned simply by overlapping their gray bars, if needed. Toggle the *Show Blending Overlap* off to reactivate the blend effect.

### Other Functions

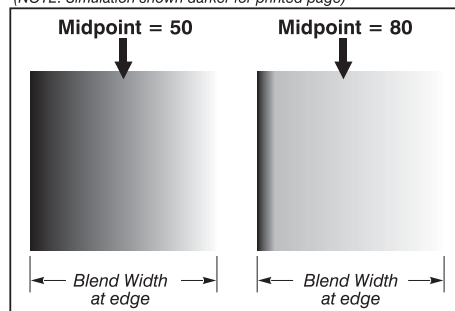
For convenience, the *Edge Blending* submenu also includes related options for enabling a specific color and/or test pattern, or for working with colors or the lamp. Such functions duplicate those provided elsewhere in the menu system.

(NOTE: Simulation shown darker for printed page)

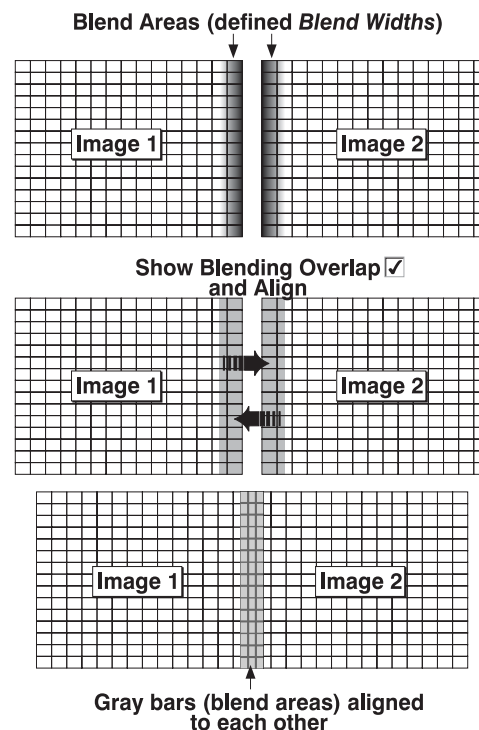


**Figure 3. 32. “Shape” Examples**

(NOTE: Simulation shown darker for printed page)



**Figure 3. 33. “Midpoint” Examples**



### Edge Blending Procedure

**BEFORE YOU BEGIN:** Make sure your source hardware and/or software can supply a *tiled* image for the number of projector in use, and that the tiling includes overlapping data of approximately 12.5-25% along shared edges (see Figure 3.34). Tiling not a projector feature.

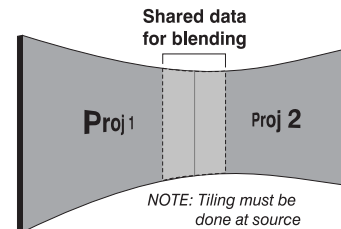


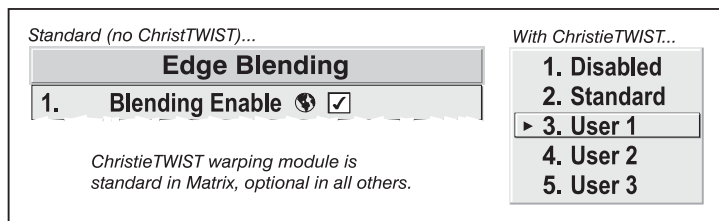
Figure 3.34. Tiling Example

Physically align the projectors and images from your intended external source, then match colors and Brightness Uniformity.

### ! IMPORTANT !

For a shared edge, the following *Blend* procedures and settings should be identical on **BOTH** projectors.

1. Start with 2 full-screen projector images overlapped by approximately 12/5%-25% each. Display full white field test pattern from both.
2. In the *Edge Blending* submenu, enable the top checkbox to activate all controls.



### 3. SET STARTING POINTS FOR ADJUSTMENT:

- Set all blend widths to 0.
- Go to “More” and set everything in the *Edge Blending (2)* menu to 50.

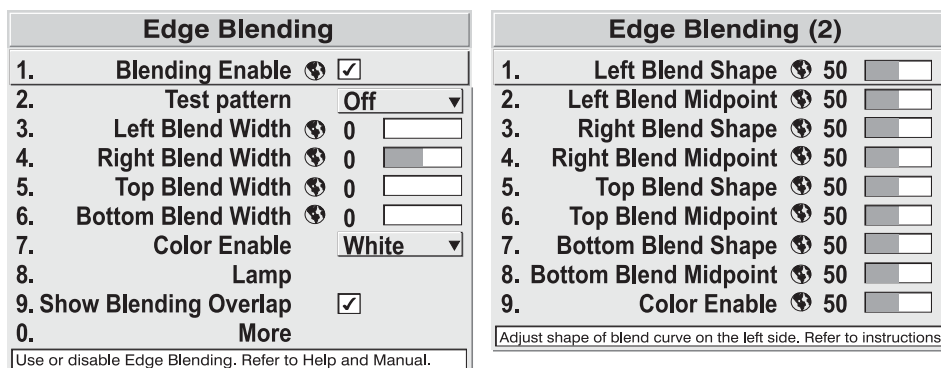


Figure 3.35. Set Starting Points for Each Projector

4. **SET BLEND WIDTH:** On one projector, increase the *Blend Width* for an overlapping edge (for example, if the projector’s image is on left, its right edge overlaps the adjacent image—adjust *Right Blend Width*). Use the same setting on the second projector for this shared edge.
5. Re-adjust width (both projectors) until the overly bright band at the midpoint of the overlapping blends disappears or *just* changes to very light gray. For the shared edge, use the same *Blend Width* setting on each projector. If the best effect appears to be between two settings, choose the wider setting for both projectors.

6. **CHECK BLEND:** If the blended region appears too dark or light in relation to the rest of the image:
  - ❑ Increase *Blend Midpoint* in both projectors to “lighten” the overall blend, decrease to “darken” the overall blend.
  - ❑ Adjust *Blend Shape* in both projectors to fine-tune change the amount of mid-gray intensity (as opposed to black/white) in the blend.
7. Repeat with remaining projectors / overlaps.
8. Check completed display wall with the desired external signal.
9. Adjust mechanical alignment if necessary to maintain perfect pixel-on-pixel alignment over time.

In applications where you are projecting only white or light images, the *Blend Width* may be slightly higher—set according to how much overlap you have between images.

### 3.11 Remote Control of the Projector

As an alternative to using a keypad, most projector functions can be controlled remotely, typically at a controller such as a PC, via 1) simple bi-directional ASCII messaging on an Ethernet or serial communication link or 2) a web interface or “ChristieNET” on an Ethernet network. Using a PC interface can also prove to be useful in instances where extreme warping is applied and the menu items become illegible and hard to navigate.

**VIA ASCII MESSAGING** — Connect a serial link between your controller and the RS232 or RS422 port (recommended), or open an Ethernet socket (i.e., Telnet) between your controller and the valid projector address. Valid ASCII codes and messages are documented in the *Christie Serial Communications* document available at the Christie website.

**VIA WEB INTERFACE** — Connect your PC to the projector’s Ethernet port. In your web browser (*Internet Explorer*, for example), enter the IP address of the projector you wish to control. This will start a password-protected ChristieNET application—enter the factory default “**ccm7**” login and password to open the program. If the projector is powered up, you can access assorted menu options and slidebars.

Repeat for remaining networked projectors as desired. Keep in mind that multiple units can be controlled from one PC, but each unit will be in its own ChristieNET interface (web browser) at the PC. Likewise, you can make up to five separate web locations to a single projector.

The default login provides access to security settings, where you can define other users with the same or fewer rights. Use “unlimited” rights for most applications. For all logins, the *Service* menu is still protected with its own password.

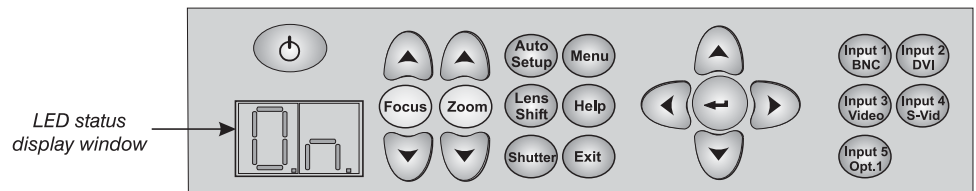
**NOTES:** **1)** Any proxy server settings that interfere with this type of link should be disabled for using ChristieNET. Disable through Internet Explorer’s <Tools> <Internet Options> <Connections> <LAN Settings>. **2)** Your PC must be Java-enabled to v1.4.2 or higher to run ChristieNET. **3)** Depending on your projector model, certain controls provided through ChristieNET are non-functional.

### 3.12 Error Conditions

Occasionally the projector will encounter an error condition that can interrupt normal operation. Such a condition can be caused by a simple invalid keypad entry, an input signal error (most common) or a system error. The manner in which users are to be notified of error conditions is set in the *Menu Preferences* menu:

- To see error messages displayed on-screen, select the “**Screen**” option
- To be notified via a serial communication only, select the “**RS232**” option.
- To receive both types of notifications, select “**All**”.
- To disable error messages (except for “invalid user key entry”, which can’t be hidden), select “**Off**”.

The 2-digit error code that corresponds to the message appears in the LED status display window located next to the built-in keypad (Figure 3.36.). *NOTE: During normal operation the status code “0n” appears.*



**Figure 3.36. LED Status Display on Built-In**

#### **User Errors** ➤ **Invalid User Entry**

A keypad entry not recognized by the projector triggers a short on-screen error message identifying the problem. For example, if you specify a channel number that is not available, the message “*Invalid Channel*” will appear. Or if you try to enter the wrong password, you’ll see “*Invalid Password*”. Press or to clear the message and try again.

*NOTE: On-screen display of “Invalid User Entry” messages cannot be disabled, even if **Display Error Messages** has been set to “Off”.*

**Input Signal Errors** ➤ An input signal error message occurs if you are in presentation level (i.e., there are no menus present) and have selected an input on which the projector detects a problem. While menus remain operational and any key press will temporarily remove any displayed error message, you must resolve the signal problem in order to permanently eliminate the message.

#### **No Signal**



The message “*No signal*” occurs when there is no source signal detected at the selected input—both HSYNC and VSYNC are inactive and the screen background is black. Connect or correct the signal, or try another input.

#### **Bad Sync**

The message “*Bad Sync*” occurs when HSYNC or VSYNC are active but the signal cannot be displayed. Such a condition occurs when only one of the two sync signals is present, or when either sync signal is unstable or the wrong frequency. Correct the signal or select another input.




### Other Signal Error Messages

In addition to the common "Bad Sync" and "No Signal" errors, you may encounter a signal error message indicating that HSYNC and/or VSYNC are either too fast or too slow. When such a message appears, check the frequencies shown in the *Status* menu. If they are correct, then the signal is not recognized by the projector. On some PCs you may be able to change the settings to generate a compatible signal. If the frequencies shown in the *Status* menu are incorrect, check the cabling to see where the problem might originate.


**System Warnings / Errors** ➤ When the projector encounters a system malfunction, either a *System Warning* message or a *System Error* message may appear. Both types of messages are accompanied by a numerical error code on the LED status display window next to the built-in keypad. A system malfunction can be cleared with   from presentation level, but may indicate the need for service by a qualified service technician.

*NOTE: System messages appear on-screen only if **Display Error Messages** has been set to "Screen" or "All".*



### System Warnings

A system *warning* indicates that a system malfunction has been detected (see *Status LED Codes*, below). A system warning message replaces any input signal message and disappears when the input signal status changes. While the projector will remain operational, the message indicates the presence of a potentially serious problem that should be reported to the manufacturer. You can press   to remove the message, but for best results you should reset the projector—power the projector down and up again with the  (power) key.

### System Errors

A system *error* message indicates that a serious malfunction has been detected and must be reported to the manufacturer as soon as possible (see *Status LED Codes*, below). The projector will no longer operate and must be reset—power the projector down and up again with the  (power) key.

### The Status LED Codes

If the status code display on the back of the projector shows one of the following values, you have encountered a likely system error requiring the attention of a qualified service technician (see *System Warnings* and *System Errors*, above). Acknowledge and clear the error with   from presentation level, or try resetting the projector by powering it off and on again, cooling when necessary. Consult and contact your dealer if the problem persists.

The specific code number identifies the source of the error detected, and is particularly useful in cases where the projector is too far away to read the accompanying text message in the LED status display window. For example, the code "27" means "Lamp 1 could not be turned on". Error codes for this projector are listed in the table below.



**Error Codes** ➤

Code	Description
<b>GENERAL</b>	
12	Software bug. Contact dealer/factory.
13	Flash memory corrupted. Download new software.
14	Engineering only programming is complete. Call Christie, replace TIPM.
15	Attempting to download code without being in boot mode
16	Invalid interrupt. Power off/on. If it persists, contact dealer/factory.
17	Forced boot mode. Keys held down too long.
18	Attempting to program boot mode without jumper
<b>LAMP FAILURES</b>	
21	Lamp compartment too hot
25	Lamp 1 not installed
26	Lamp 1 Interlock: door open, lamp not installed
27	Unable to turn lamp 1 ON
28	Lamp 1 shut off unexpectedly
29	Lamp 1 driver overheated
2A	Lamp 1 driver operation error (e.g. too hot can't start)
2C	Lamp 1 driver UART communications failure
30	Lamp 2 not installed
31	Lamp 2 door open
32	Unable to turn lamp 2 ON (unknown reason)
33	Lamp 2 shut off unexpectedly
34	Lamp 2 driver overheated
35	Lamp 2 driver reports operation error (e.g. too hot can't start)
36	Lamp 2 driver UART communications failure
37	Lamp Watchdog Tripped – Unless lamps turn on again after 3 minutes, assume software hung.
<b>POWER AND COOLING</b>	
41	Lamp 1 driver Vcc to low
42	Color wheel 1 stopped for at least one second
44	Lamp 2 driver Vcc too low
45	Color wheel 2 stopped for at least one second
4C	Projector shutdown due to critical error
51	TIPM fan failed
53	Main blower failed
56	Engine fan failed
57	Lamp 1 driver fan failed
58	Lamp 1 fan failed
59	Lamp 2 driver fan failed
5A	Lamp 2 fan failed
<b>TIPM (image processor)</b>	
60	Boot code CRC failed
61	Unable to program the DigMux PLD
62	Unable to program the Control PLD
63	Unable to program the BUBKS PLD
64	Unrecognized ROM type
65	Write to flash ROM failed
66	General image processor failure
67	Downloaded code will not fit in the ROMs
68	Communication problem with scaler on image processor
<b>BUILT-IN or EEPROM</b>	
70	Unable to access the EEPROM on the built-in keypad
71	EEPROM memory re-initialization (built-in keypad)
72	Unable to access the EEPROM on the lamp module
73	Unable to access the EEPROM on the Back End Board
<b>BACK END BOARD</b>	
80	Unable to detect Back End Board
81	Unable to program a device on the programming bus
82	TI flash download failure – not started
83	TI flash download failure – partial write
84	TI flash download failure – checksum read
85	TI – I2C write failure
86	Communications failure
<b>BACKPLANE or OPTIONAL INTERFACE MODULE</b>	
A0	Unable to program the Option Card
A1	Unable to power the Option Card
A2	Unable to program the Backplane module
A3	Unable to program the Warp Module

Clear system errors with **Exit** **Exit**. If you encounter a system error, try resetting the projector by powering it off and on again (wait at least 90 seconds and allow for proper cooling). For detailed information, monitor the RS232 IN port. Contact dealer/factory if error persists and if a code appears that is not listed.



# Maintenance

## 4.1 Warnings and Safety Guidelines

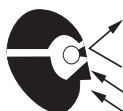
The projector is an international regulatory agency approved product designed for safe and reliable operation. It is important to acknowledge the following precautions while operating the projector to assure complete safety at all times.

### **WARNING**

Always remove the lens when shipping the projector.

### **WARNING**

**NEVER** look directly into the projector lens. The high brightness of this projector could cause permanent eye damage.



### **WARNING**

For protection from ultraviolet radiation, keep all projector shielding intact during operation.

### **CAUTION**

Installation should be performed by qualified personnel.

**Labels and Markings** ➤ Observe and follow all warnings and instructions marked on the projector.



The exclamation point within the equilateral triangle alerts the user to important operating and maintenance (servicing) instructions in the literature accompanying the projector.



The lightning flash and arrowhead symbol within the equilateral triangle alerts the user to uninsulated “dangerous voltage” within the projector’s enclosure that may be of sufficient magnitude to constitute a risk of electric shock.

**Instructions** ➤ Read all operating instructions prior to using the projector.

**Projector Location** ➤ Operate the projector in an environment, which meets the operating range as specified in *Section 6 – Specifications*.

- ◇ Do not operate the projector close to water, such as near a swimming pool. Do not operate in extremely humid environments.
- ◇ Do not place the projector on an unstable cart, stand or table. A projector and cart combination should be used with care. Sudden stops, excessive force and uneven surfaces may cause the projector and cart combination to overturn.
- ◇ If the projector is to be ceiling mounted, use only the Christie-approved ceiling mount fixture.

**Lamps** ➤ The two 300W P-VIP lamps in the projector require replacement when they have reached their end of life (approximately 1500 hours), if they have failed during operation, or have a drastic change in brightness (typical of aging lamps). To effectively maintain operation of the projector it is best to be aware of any changes that occur in brightness and the number of hours each lamp is in use. Refer to *4.4. Lamp Replacement* for more details on lamp replacement.

*NOTE: These are mercury-containing lamps. Handle appropriately. Refer to Appendix G for the lamp product safety data sheet.*

Follow all safety and warning precautions regarding lamp replacement and handling.

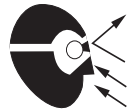


**WARNING**



**Wait approximately 5 minutes to allow the lamp to cool before removing.**

**Do not stick hands into the lamp compartment during lamp replacement.**



**The lamp is under great pressure when hot and may explode causing physical injury and/or property damage. Allow a lamp to cool before handling and/or powering down and unplugging the projector.**

**Use only the lamps supplied by CHRISTIE, in the *Lamp Replacement Kit*.**

**Power Cord and Attachments** ➤ Use only the attachments and/or accessories recommended by CHRISTIE. Use of others may result in the risk of fire, shock or personal injury.



**WARNING**

**Use only the AC power cord supplied. Do not attempt operation if the AC supply is not within the specified voltage and power range. See *Section 6*.**

- ◇ Do not set or rest items on the power cord. Place the projector in an area where the projector cord cannot be abused or damaged by persons walking on it or by objects rolling over it.
- ◇ Operate the projector at the specified voltage only. Do not overload power outlets and extension cords as this can result in fire or shock hazards.

- ◇ The projector is equipped with a three-wire plug having a third grounding pin. This is a safety feature – if you are unable to insert the plug into an outlet contact an electrician to have the outlet replaced. Do not defeat the safety purpose of this grounding-type plug.

**Ventilation** ➤ Slots and vents in the projector provide ventilation. Never block or cover these openings. This ensures reliable operation of the projector and prevents overheating.

- ◇ Do not place the projector over a radiator or heat register. The projector should not be placed in an enclosure unless proper ventilation is provided.
- ◇ Do not “poke” objects into the ventilation openings of the projector. They may touch dangerous voltages or short-out components resulting in a fire or shock hazard. Do not spill liquids of any kind into the projector. Should an accidental spill occur, immediately unplug the projector and have it serviced by a qualified service technician.

**Servicing** ➤ If any of the following conditions exist, immediately unplug the projector from the power outlet and ask a qualified service technician to look at it.

- ◇ The power cord has been damaged.
- ◇ The internal cooling fans do not turn on when the projector is first powered up.
- ◇ Liquid has been spilled into the projector.
- ◇ The projector has been exposed to excessive moisture.
- ◇ The projector is not operating normally or its performance has significantly deteriorated in a short period of time.
- ◇ The projector has been dropped or the shipping case (if applicable) has been badly damaged.

**▲ WARNING**

**Do not attempt to service the projector yourself. All servicing must be performed by CHRISTIE accredited service technicians.**

**Use replacement parts that are manufacturer-approved only. Use of any other part other than the ones specified by the manufacturer can result in fire, electric shock or risk of personal injury and irreparable equipment damage.**

**▲ WARNING**

**Never service the projector while it is still plugged in. There are exposed voltages that could cause severe physical injuries and possibly death. Always unplug the projector and wait 2 minutes to allow the capacitors on the power supply to discharge before removing the projector's covers.**

**4.2 Cleaning and Maintenance Guide**

**⚠ WARNING**

**Always power down and unplug the projector before cleaning or servicing.**

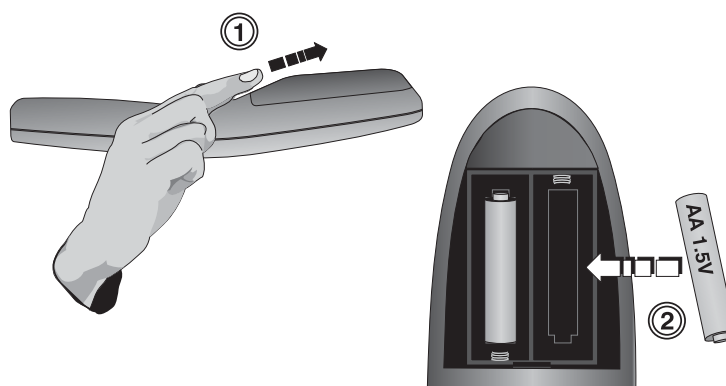
**Table 4.1. Maintenance Guide**

Part Description	Frequency	How to clean
<b>Lens</b>	<i>As required</i>	<p><b>CLEAN:</b> Clean if absolutely necessary. A small amount of dust on the lens has very little affect on picture quality.</p> <p><b>To clean:</b> Apply a solvent such as acetone, alcohol or vinegar sparingly to clean, lint-free lens tissue. Wipe across the surface of the lens. Do not scrub or rub tissue in circular motion, this will scratch the lens. Do not reuse tissue. Do not use cleaning tools treated with Ether. If particles still appear on the lens, try using compressed air to remove.</p>
<b>Lamp Module (300 W P-VIP)</b>	<i>As required</i>	<p><b>CLEAN (front glass only):</b> Clean if absolutely necessary. Never touch the glass surface of the lamp. Any oil (left by fingerprints) will seriously degrade lamp performance or cause “hotspots” which can lead to an accumulation of intense heat in the touched area and cause the lamp to shatter.</p> <p><b>To clean, wait</b> until lamp is cool. Moisten a clean, lint-free cotton cloth with isopropyl alcohol and gently rub the surface of the glass in a circular motion until clean.</p>
	<i>1500 hours or sooner if required</i>	<b>REPLACE:</b> Refer to 4.4 Lamp Replacement for instructions.
<b>Covers</b>	<i>As required</i>	<p><b>CLEAN:</b> Clean dust from external covers using a clean, lint free cotton cloth as required. <b>NOTE:</b> Before cleaning the modules, it is recommended that you install the lens cap. This will keep dust particles from settling on the glass surface of the lens.</p>

### 4.3 Replacing Remote Batteries

The optional IR remote uses two AA size, 1.5V alkaline batteries. To replace the batteries simply turn the remote over and push out the cover using the finger groove, as shown in (1) Figure 4.1.

Remove and properly discard the old batteries. Insert new batteries in the proper positive/negative orientation as shown etched in the bottom of the compartment (2). Replace the cover by inserting the tabbed end into the opening and snapping the opposite end into place.



**Figure 4.1. Replacing remote batteries**

### 4.4 Lamp Replacement

The projector uses two 300W P-VIP lamps and can be operated with both lamps ON (Dual Lamp Operation mode) or with one lamp ON (Single Lamp Operation mode). The projector has the ability to automatically switch modes to maintain continuous operation.


**When do I replace a lamp?** Lamps that have shown a drastic reduction in brightness or have reached their end of life (approx 1500 hours) should be replaced immediately. You can check the number of hours each lamp has been in use by looking up the number of **LAMP HOURS** in individual lamp submenus or in the *Status* menu. From the *Lamp* menu, you can also set a **LAMP LIMIT** and enable the projector to send a warning message when it's powered on to indicate the lamps have reached their set limit.

At anytime during operation, you can check the status of a lamp by checking the lamp status in individual lamp submenus – *More, Lamp 1* or *More, Lamp 2*. You will see one of six states: “*Good*”, “*Cooling Fan #8 Failed*”, “*Cooling Fan #10 Failed*”, “*Interlock Tripped*”, “*Failed to Strike*”, “*Turned Off Unexpectedly*”, “*Color Wheel Stopped*”, “*Driver Vcc too Low*” or “*Lamp Not Installed*”. A status of “**Failed to Strike**” or “**Turned Off Unexpectedly**” indicates a failure that requires further investigation and may or may not be directly related to the lamp.

If you have ruled out the cause being an aged lamp or another component in the projector, it may indicate that your lamp has prematurely burned out or failed for some other reason (check status LEDs and/or error codes through RS-232, if possible). Burned out lamps or lamps that have failed due to some characteristic flaw should be replaced, as soon as possible.

In general, monitor the performance of your projector and replace lamps as needed.

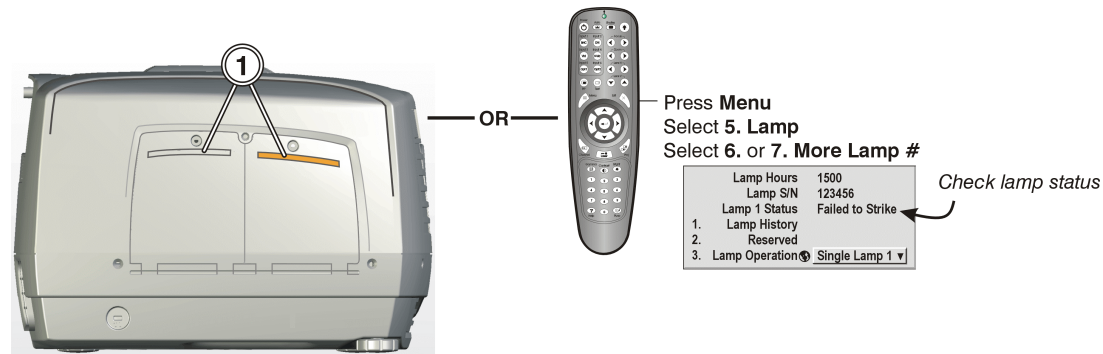
To replace a lamp:

1. Press  to power down the projector and allow the lamp to cool for approximately 5 minutes after the fans have turned off before continuing with Step 2. If required, you can switch lamp modes and cut power to the lamp you want to replace without having to power down the projector and interrupt a presentation. Check the *Lamp* menu to ensure the lamp operation mode has been switched to the other lamp. Allow the lamp to cool sufficiently before continuing with Step 2.

*NOTE: Opening a lamp door with a “live” lamp will cause the projector to automatically cut power to that lamp.*

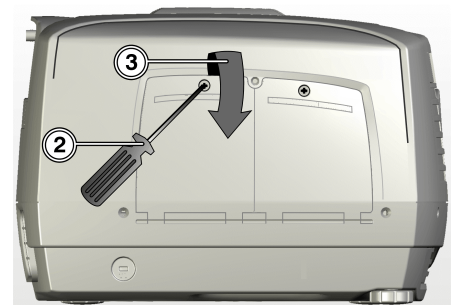
**⚠ WARNING**

**Wait at least 5 minutes after powering down or switching lamp operation modes to allow the lamp to cool sufficiently before removing.**



**Figure 4.2.**

2. Remove the single screw from the lamp door you want to open.  
*NOTE: The amber window on the door (Figure 4.2.) should be dim. If it “glows” then the lamp in this compartment is still on. Manually switch to the other single lamp operation mode to cut power to the lamp before replacing. (Figure 4.3)*



**Figure 4.3.**

3. Swing the lamp door open. (Figure 4.3.)
4. Using a screwdriver or fingers, turn the three lock screws on the lamp module counter-clockwise a quarter turn each to “unlock” it. (Figure 4.4.)
5. Using the two finger guides molded into the lamp housing, pull the lamp straight out of the projector. (Figure 4.4) The lamp module disconnects from the terminal block located at the back of the lamp compartment.

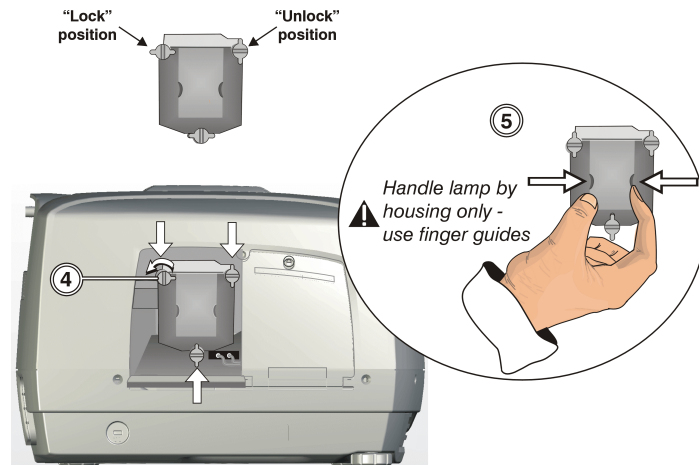


Figure 4.4.

6. Discard the lamp using approved disposal methods for your area. *NOTE: Lamps containing mercury must be treated as hazardous waste if discarded in large volumes.*

**⚠ WARNING**

**Do not stick hands into an empty lamp compartment, especially if the other lamp is still on. The lamp compartment can become quite hot and cause physical injury.**

7. On the new lamp module, turn the three lock screws to the “unlock” position before inserting it into the lamp compartment. Align the lamp with the three pins located at the back of the compartment. Insert the lamp all the way in until it is fully seated. (Figure 4.5)
8. Turn the three lock screws on the new lamp module clockwise a quarter turn to “lock” it in place. (See Figure 4.4 for lock screw position.)
9. Close the lamp door and tighten the screw to secure it in place.

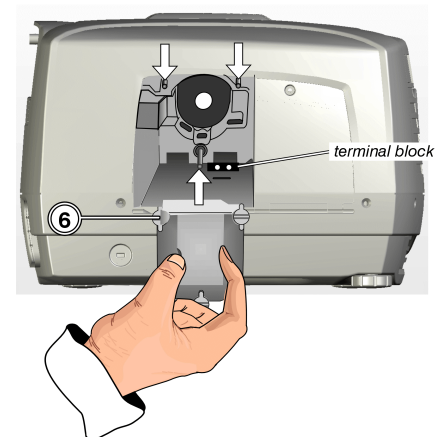


Figure 4.5.

*NOTE: The projector automatically detects a new lamp and records the serial number in software the next time it's powered up. Manual entry of the serial number is not required.*

### 4.5 Replacing the Projection Lens

Use the following instructions when replacing a projection lens:

**▲ NOTE for first time use:** The projection lens is shipped separately from the projector. Before you install a lens it is important to remove the lens plug from the lens opening in the projector and the protective end cap from the lens.

1. Power down the projector and wait 5 minutes to allow the lamps to cool before continuing with Step 2.
2. Place the lens cap on the projection lens to protect it from being damaged during the installation or removal process.
3. **When removing the projection lens** - Press and hold the **LENS RELEASE** button located in the bottom right corner of the projector's front panel. Grasp the lens barrel with your free hand and turn it in a counter-clockwise direction until it can be removed from the projector. Release the **LENS RELEASE** button.

**OR**

**When installing a projection lens**, complete Steps 1 and 2 above. Slide the lens into the lens opening in the projector and turn clockwise until it is fully installed.

**▲ Remove the protective end cap from a new lens before installing otherwise you could damage the projector.**

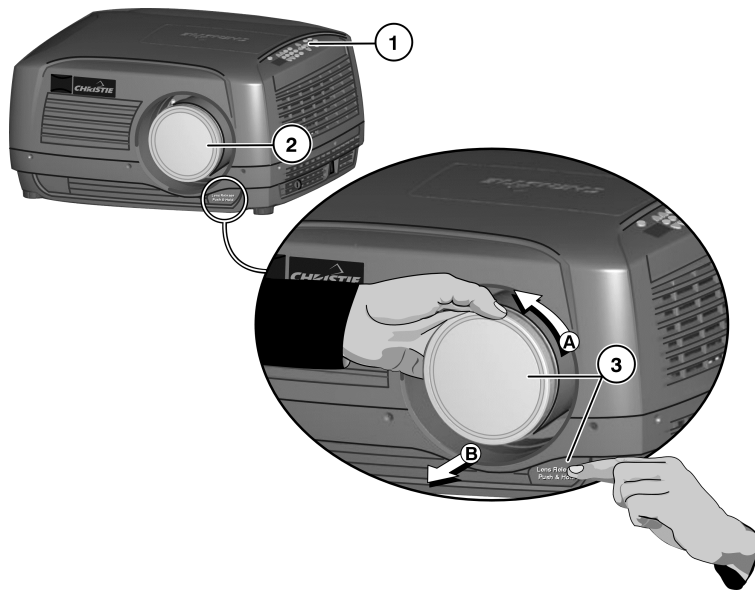


Figure 4.6.



# Troubleshooting





If the projector does not appear to be operating properly, note the symptoms present and use the following guide to assist you. If you cannot resolve the problems yourself, contact your dealer for assistance.

*NOTE: A qualified service technician is required when opening the projector to diagnose any “probable cause”.*

## 5.1 Displays

### **Symptom** ➤ **The projector is on but there’s no display...**

**CAUSE / REMEDY:**

1. Was a lens cover accidentally left on? Remove lens cover.
2. Make sure the shutter is OPEN.
3. Is the lamp ignited? It could take up to 3 attempts to strike a lamp. With a 90 second wait period in between each attempt it could take a total of 4.5 minutes to turn the lamp on. Check **LAMP STATUS**.
4. Is the correct input selected?
5. Is the source connected properly? Check the cable connections and make sure the correct source is selected.
6. Can you access test patterns? Make sure there is not a full black test pattern selected for display—press   to access test patterns, then cycle patterns with   keys.

### **Symptom** ➤ **Severe motion artifacts...**

**CAUSE / REMEDY:**

1. Most likely there is a synchronization problem with reversed 3/2 pull-down in 60Hz-to-24Hz film-to-digital conversion in your source. Correct at the source.

### **Symptom** ➤ **Image appears “squeezed” or vertically stretched into center of screen**

**CAUSE / REMEDY:**

1. Check your Resizing selection.

### **Symptom** ➤ **The display is jittery or unstable...**

**CAUSE / REMEDY:**

1. If the display is jittery or blinking erratically, ensure that the source is properly connected and of adequate quality for detection. With a poor quality or improperly connected source, the projector will repeatedly attempt to display an image, however briefly.
2. The horizontal or vertical scan frequency of the input signal may be out of range for the projector. Refer to *Section 6, Specifications* for scan frequency ranges.
3. The sync signal may be inadequate. Correct the source problem.

**Symptom ➤ The display is faint...**

- CAUSE / REMEDY:**
1. Brightness and/or contrast may be set very low.
  2. The source may be double terminated. Ensure the source is terminated only once.
  3. The source (if non-video) may need a different sync tip clamp location.

**Symptom ➤ The upper portion of the display is waving, tearing or jittering...**

- CAUSE / REMEDY:**
1. This can sometimes occur with video or VCR sources. Check your source.

**Symptom ➤ Portions of the display are cut off or wrap to the opposite edge...**

- CAUSE / REMEDY:**
1. Resizing and/or blanking may need adjustment.

**Symptom ➤ The display appears compressed (vertically stretched)...**

- CAUSE / REMEDY:**
1. The frequency of the pixel sampling clock is incorrect for the current source.
  2. Resizing, vertical stretch and positioning options may be improperly adjusted for the incoming source signal.

**Symptom ➤ Data is cropped from edges**

- CAUSE / REMEDY:**
1. Check settings for Blanking.
  2. If incoming data is still missing from the image, reduce the image size to within the display area available in the projector.

**Symptom ➤ Display quality appears to drift from good to bad, bad to good...**

- CAUSE / REMEDY:**
1. The source input signal may be of low quality.
  2. The H or V frequency of the input may have changed at the source end.

**Symptom ➤ The display has suddenly frozen...**

- CAUSE / REMEDY:**
1. If the screen blacks out inexplicably, it is possible that excessive voltage noise on the AC or ground input has interrupted the projector's ability to lock on to a signal. Power down the projector and disconnect from AC. Then plug in again and power up as usual.

**Symptom ➤ Colors in the display are inaccurate...**

- CAUSE / REMEDY:**
1. The color, tint, color space, color temperature and/or other settings may require adjustment.
  2. Make sure you are using the proper channel for this source.
  3. Check *Color Wheel Calibration*.

**Symptom ➤ The display is not rectangular...**

- CAUSE / REMEDY:**
1. Check leveling of the projector. Make sure that the lens surface and screen are as parallel to each other as possible.
  2. Is the vertical offset correct? Adjust as necessary using the vertical offset knob.
  3. Check if Keystone is incorrectly set.

**Symptom ➤ The display is "noisy"...**

- CAUSE / REMEDY:**
1. Display adjustment at your input source may be required. Adjust pixel tracking, phase and filter. Noise is particularly common on YPbPr signals from a DVD player. (If using a PC source, adjust using a high-frequency test pattern with one pixel on/off throughout.)

2. The video input may not be terminated. Make sure the video input is terminated (75  $\Omega$ ). If it is the last connection in a loop-through chain, the video input should be terminated at the *last* source input only.
3. The input signal and/or signal cables carrying the input signal may be of poor quality.
4. If the distance between the input source device and the projector is greater than 25 feet, signal amplification/conditioning may be required.
5. If the source is a VCR or off-air broadcast, detail may be set too high.

---

## 5.2 Lamps

For more information on lamp operation modes and auto-switching, refer to *Section 3 – 3.7 The Lamp Menu*.

### **Projector Delayed on Power Up**

- 1. The projector enforces a 90 second delay between powering down and up again, because a hot lamp is more difficult to ignite. *NOTE: It can potentially take 2 minutes to cool a lamp sufficiently enough before re-striking it.*

### **Powered Up, But No Light On The Wall**

- 1. It takes 25 seconds for the projector to power up and strike a lamp. One of the inherent properties of the lamp is that it may not strike with the first attempt. The projector will wait 90 seconds before trying to strike the lamp again. It will try a total of three times (4.5 minutes total) before it declares the lamp as “*Failed to Strike*” – check **LAMP STATUS**.
2. Make sure the shutter is OPEN.

### **Lamp Operation Mode Didn't Change**

- 1. Did you request a lamp operation mode change during power up? The projector will ignore any commands sent during initialization. Wait for “ON” to appear in the LED status display window before entering a command.
2. Check the status of the lamp. The lamp operation mode will not change if there is a lamp with an associated failure or lamp is not installed.
3. Make sure you have allowed enough time for the projector to turn a lamp on. This can take up to 4.5 minutes, as the projector will strike a lamp up to 3 times waiting 90 seconds in between each attempt. Only after a lamp is successfully turned on will the lamp operation mode change.

---

## 5.3 Ethernet

1. Make sure the Ethernet settings are valid for your site—all network devices should have the *same* subnet mask and *unique* IP addresses.
2. Make sure to save any address change, and re-boot to implement.
3. If you still have trouble establishing communications with a projector added to an existing Ethernet network, the projector’s IP address is likely in conflict with another address already in use. Contact your network administrator.



# Specifications

---

*NOTES: 1) Due to continuing research, specifications are subject to change without notice. 2) Specifications apply to all models unless otherwise noted.*

## **Display** ➤ **Resolution**

SXGA+ (1400 x 1050) for *DS+60* and *Matrix 3000*

720P (1280 x 720, widescreen) for *DW30*

## **Brightness**

*DS+60*

Dual Lamp (White Boost ON)	6000 ANSI lumens
Single Lamp (White Boost ON)	3050 ANSI lumens

*DW30 & Matrix 3000*

Dual Lamp (White Boost ON)	2700 ANSI lumens
Single Lamp (White Boost ON)	1500 ANSI lumens

## **Contrast Ratio**

*DS+60 & DW30*

1100:1 – 5000:1 full field *when using light shutter*

*Matrix 3000*

1500:1 – 4000:1 on/off contrast ratio with internal aperture

## **Brightness Uniformity**

90% across the screen

## **Colors and Gray Scale**

Resolution	8 bits
Displayable Colors	64 million

## **Color Wheel**

<i>DS+60</i>	2xRGW80B
<i>DW30</i>	2xRGRGB
<i>Matrix 3000</i>	2xRGB

## **Color Temperature**

Default	6300K±500K <i>with White Boost = 10</i>
	6000K±500K <i>with White Boost = 0</i>
Range of Adjustment	3200K – 9600K

**Lenses** ➤  
(optional)

\* for DS+60 and Matrix 3000, 0% offset is equal to half the image above and below lens center (525 pixels) OR half the image to the left or right of lens center (700 pixels) – see table below.

**Table 5.1. SXGA+ Lens Offsets**

Lens Type	Part No.	Vertical Offset (% of half height)		Maximum amount of projected image above or below lens center		Horizontal Offset (% of half width)		Maximum amount of projected image to one side of lens center	
		%	Pixels	%	Pixels	%	Pixels	%	Pixels
0.8:1 fixed	38-809082-02	12%	+/-63	56%	+/-588	7%	+/-48	53%	+/-748
1.2:1 fixed	38-809083-02	120%	+/-630	110%	+/-1155	78%	+/-546	89%	+/-1246
1.3-1.7:1 zoom	38-809084-02	120%	+/-630	110%	+/-1155	78%	+/-546	89%	+/-1246
1.7-2.5:1 zoom	38-809085-02	120%	+/-630	110%	+/-1155	78%	+/-546	89%	+/-1246
2.5-4.0:1 zoom	38-809086-02	120%	+/-630	110%	+/-1155	78%	+/-546	89%	+/-1246
4.0-7.0:1 zoom	38-809087-02	120%	+/-630	110%	+/-1155	78%	+/-546	89%	+/-1246

\* for DW30, 0% offset is equal to half the image above and below lens center (360 pixels) OR half the image to the left or right of lens center (640 pixels) – see table below.

**Table 5.2. 720P Lens Offsets**

Lens Type	Part No.	Vertical Offset (% of half height)		Maximum amount of projected image above or below lens center		Horizontal Offset (% of half width)		Maximum amount of projected image to one side of lens center	
		%	Pixels	%	Pixels	%	Pixels	%	Pixels
0.88:1 fixed	38-809082-02	81%	+/-292	90%	+/-652	31%	+/-200	66%	+/-840
1.3:1 fixed	38-809083-02	231%	+/-832	110%	+/-1192	104%	+/-664	102%	+/-1304
1.42-1.86:1	38-809084-02	231%	+/-832	165%	+/-1192	104%	+/-664	102%	+/-1304
1.86-2.73:1	38-809085-02	231%	+/-832	165%	+/-1192	104%	+/-664	102%	+/-1304
2.73-4.38:1	38-809086-02	231%	+/-832	165%	+/-1192	104%	+/-664	102%	+/-1304
4.38-7.66:1	38-809087-02	231%	+/-832	165%	+/-1192	104%	+/-664	102%	+/-1304

**Inputs** ➤ **Analog RGB or YPrPb (Interlaced or Progressive Scan Format)**

Horizontal Frequency Range	15 – 120 kHz
Vertical Frequency Range (See Note 1)	23.97 – 150 Hz
Pixel Clock Rate	13-210 MHz max
Signal Format	
Input Levels	R, G, B, - with sync: 1.0V <sub>p-p</sub> ±2dB
	R, G, B, - without sync: 0.7V <sub>p-p</sub> ±2dB
	Pb, Pr 0.7V <sub>p-p</sub> ±2dB
DC Offset	±2V
Nominal Impedance	75 ohms

*Note 1: Value specifies frame rate of non-interlaced sources and field rate for interlaced sources. Frame/field rates higher than the maximum refresh rate of the panels will be displayed at a lower rate.*

**Sync (Interlaced or Progressive Scan Format)**

Horizontal Frequency Range	15 – 120 kHz
Vertical Frequency Range (See Note 1)	23.97 – 120 Hz
Sync Type	Separate H and V Composite (bi-level, tri-level, XOR) Sync-On-Green/luma (bi-level, tri-level) MarcoVision™ compatible
Polarity (See Note 2)	Positive or Negative
Input Levels (See Note 2)	0.5V <sub>pp</sub> – 4.0V <sub>pp</sub>
DC Offset (See Note 2)	±3V
Nominal Impedance (See Note 2)	75 ohms
Horizontal Sync Duty Cycle	3% min, 20% max

*Note 2: Does not apply to sync-on-green/luma.*

**Composite Video and S-Video**

Signal Formats	Composite-video (CVBS), S-video Y/C
Video Standards	NTSC, NTSC 4.43, PAL, PAL M, PAL N, PAL60, SECAM
Input Levels	Composite-video: 1.0Vp-p $\pm$ 3db (including sync tip) S-video luma (Y): 1.0Vp-p $\pm$ 3dB (including sync tip) S-video chroma (C): 630mV nominal (burst)
DC Offset	$\pm$ 2V
Nominal Impedance	75 ohms
Return Loss (VSWR)	20dB min (1.2:1 max.) @ 6 MHz

**DVI-I – Analog**

Input Characteristics	Same as Analog RGB except as noted below.
Formats	RGB or YPbPr – video signal cannot be routed to the decoder.
Sync Types	Separate H and V (direct or swapped) Bi-level – TTL levels only Composite (XOR, OR) Sync-on-green Serrations and/or Equalization pulses MacroVision™ (standard & progressive)

**DVI-I – Digital**

Input Characteristics	meets DVI spec
DVI Cable Length	5m
EDID	Supported
HDCP (High Speed Digital Content Protection)	Supported

**RS-232 Serial Input**

Connector Type	1 male DB9 (RS-232 out) 1 female DB9 (RS-232 in)
----------------	---

**RS-422 Serial Input**

Connector Type	1 female DB9 connector
----------------	------------------------

**Network Control**

Ethernet	1 RJ45 connector
Max. Baud Rate	115200

**Remote Control**

Type	IR with wired ability
Range	30 meters
Laser Pointer	Included
Battery Type (2 required)	AA, 1.5V Alkaline

**Wired Control**

Connector Type	3.5mm plug
Input Levels	High: 2.2V min. Low: 0.9V max. Power: 500mA @ 5V

**Power Requirements** ➤ **▲ General**

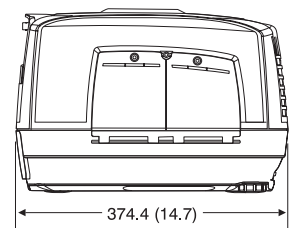
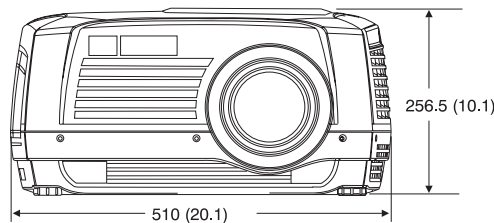
Voltage Range	100 – 240 VAC nominal
Line Frequency	50 Hz – 60 Hz nominal
Max. Inrush Current	68 A
Current Rating	Both lamps on - 8.4A @ 100V (typical), 3.5A @ 240V (typical)
	One lamp on - 4.8A @ 100V (typical), 2.0A @ 240V (typical)
Power Consumption	Both lamps on - 840W nominal One lamp on - 480W nominal

**Lamps** ➤

Type	OSRAM 300W P-VIP®
Power	300 Watts
Operating Position	± 20 deg. tilt from horizontal plane
Warm up to full brightness	5 minutes
Lamp Life (typical)	1500 hours per lamp

**Size and Weight** ➤

Dimensions (L x W x H)	374mm x 510mm x 256mm 14.7” x 20.1” x 10.1”
Weight	36 lbs



Dimensions: mm (inches)

**Safety** ➤ CAN/CSA C22.2 No. 60950-00  
ANSI/UL 60950 3<sup>rd</sup> Edition  
EN60950, 2000 European Norm, Safety of Information Technology Equipment  
China Compulsory Certificate (CCC)  
FDA

**EMI** ➤ **Emissions**  
FCC Code of Federal Regulations, Title 47, Part 15, Conducted and Radiated Emissions, Class A  
EN55022 (CISPR 22) for Information Technology Equipment, Conducted and Radiated, Class A  
EN61000-3-2 Induced Harmonic Distortion  
EN61000-3-3 Induced Voltage Fluctuations (Flicker)

**Immunity**  
EN55024, specific to Information Technology Equipment (all parts), under which are:  
EN61000-4-2 ESD,  
EN61000-4-3 Radiated Immunity,  
EN61000-4-4 Fast Transient/Burst Immunity  
EN61000-4-5 Surge Immunity,  
EN61000-4-6 Immunity to Conducted Disturbances,  
EN61000-4-8 Magnetic Field Immunity,  
EN61000-4-11 Voltage Dips, Short Interruptions and Voltage Variations Immunity



<b>Operating Environment</b>	➤	Temperature	10°C to 35°C
		Humidity	20% to 90%
		Altitude	0m to 3050m
<b>Non-Operating Environment</b>	➤	Temperature	-20°C to 70°C
		Humidity	5% to 95%
		Altitude	0m to 9144 m
<b>Standard Components</b>	➤	IR remote (with batteries)	
		Wired remote control cable	
		Line Cords (North American and European)	
		Computer cable (Dsub15 to DVI-I)	
		DVI-I cable	
		S-video cable	
		User's Manual	
<b>Optional Accessories</b>	➤	Kore™ 10-bit Librarian for downloading new software	
		Ceiling Mount	
		Stacking Kit	
		Shipping Case	
		Service manual	
		Remote IR Sensor	

**Lenses (SXGA+)**

0.8:1 fixed (38-809082-01)  
 1.2:1 fixed (38-809083-02)  
 1.3-1.7:1 zoom (38-809084-02)  
 1.7-2.5:1 zoom (38-809085-02)  
 2.5-4.0:1 zoom (38-809086-02)  
 4.0-7.0:1 zoom (38-809087-02)

**Optional Input Modules**

RGB500 Input Module  
 RGB400 Active Loop-Through Input Module  
 RGB400 Buffered Amplifier Input Module  
 PC250 Analog Input Module  
 Serial Digital Input Module  
 DVI/DFP Input Module  
 Dual SD/HD-SDI Module



# Glossary

---

This appendix defines the specific terms used in this manual as they apply to this projector. Also included are other general terms commonly used in the projection industry.

- Active Line Time** ➤ The time, inside one horizontal scan line, during which video is generated.
- Ambient Light Rejection** ➤ The ability of a screen to reflect ambient light in a direction away from the "line of best viewing". Curved screens usually have good ambient light rejection. Flat screens usually have less ambient light rejection.
- Analog Video** ➤ The video output of most computers and videotape machines. Analog video can generate a large number of colors.
- Anamorphic** ➤ Having or requiring a linear distortion, generally in the horizontal direction. Anamorphic lenses can restore a 'scope' (CinemaScope) or 'flat' format film frame to the correct wide-screen appearance by increasing its horizontal proportion.
- ANSI** ➤ The American National Standards Institute is the organization that denotes the measurement standard for lamp brightness.
- Aspect Ratio** ➤ The ratio of the width of an image to its height, such as the 4:3 aspect ratio common in video output. Can also be expressed as a decimal number, such as 1.77, 1.85 or 2.39. The larger the ratio or decimal, the wider and "less square" the image.
- Auto Source** ➤ The ability of the projector to automatically recognize and synchronize to the horizontal and vertical scan frequencies of an input signal for proper display.
- Bandwidth** ➤ The frequency range of the projector's video amplifier.
- Baud Rate** ➤ The speed (bits-per-second) at which serial communications travel from their origin.
- Blanking Time** ➤ The time inside one scan line during which video is not generated. The blanking time of the input signal must be equal to or greater than the retrace time of the projector.
- Brightness** ➤ In projection, brightness usually describes the amount of light emitted from a surface such as a screen. It is measured in foot-lamberts or candelas per square meter.
- Candela or Candle** ➤ Unit of measure for measuring intensity of light.
- Channel** ➤ A collection of measurements stored by the projector for a given input source, including frequencies, pulse width, polarity, syncs, channel number and location, user-adjustable display settings, etc. Use channels to switch between a variety of setups quickly, automatically recalling previously defined display parameters.
- Channel List** ➤ A list/menu of previously-defined channels available in projector memory.

- Channel Number** ➤ A number that uniquely identifies a specific channel retained in projector memory. The projector can retain up to 50 channels.
- Checkbox** ➤ A menu item that indicates whether an option is currently in effect (checked) or not (unchecked).
- Chrominance** ➤ The signal representing the color information (hue and saturation) when the image is represented as separate chrominance and *luminance*. Same as “chroma”.
- Color Gamut** ➤ The range of colors allowed in a specific system, as defined within a triangular area located on the CIE color locus diagram whose corners are the three primaries defined in the system. Also known as color space.
- Color Shift** ➤ A change in the tint of a white field across an image.
- Color Temperature** ➤ The coloration (reddish, white, bluish, greenish, etc.) of white in an image, measured using the Kelvin (degrees K) temperature scale. Higher temperatures output more light.
- Color Wheel** ➤ An optical component, the color wheel is made up of red, green and blue and sometimes white segments. The light generated by the lamp is sequentially filtered by the color wheel (as it’s spinning) into R, G, B color primaries and passed to the DMD which then creates an image for each color.
- Component Video** ➤ See *YCbCr* or *YPbPr*.
- Composite Video** ➤ The output of video tape players and some computers, characterized by synchronization, luminance and color signals combined on one output cable.
- Contrast (ratio)** ➤ The degree of difference between the lightest and darkest areas of the image.
- Convergence** ➤ The alignment of the red, green, and blue elements of a projected image so that they appear as a single element.
- Curved Screen** ➤ A projection screen which is slightly concave for improved screen gain. Curved screens usually have screen gains, which are greater than 1 but viewing angles much less than 180°. Curved screens are not recommended for use with this projector.
  - DDC** ➤ The Display Data Channel VESA standard enables communication between PCs and monitors, and is based on E-EDID protocol.
  - DDI** ➤ A “direct digital interface” signal can be supplied to the projector via an optional digital input module installed in **INPUT 5**. For example, you can input an SMPTE-259M signal using a *Serial Digital Input Module* or input an SMPTE-272M signal from a *Digital HDTV Serial Input Module*.
  - DMD™** ➤ Digital Micromirror Devices™ used in this projector for processing red, green, and blue color data.
  - Decoder** ➤ Located at **INPUT 3** and **INPUT 4**, this device converts NTSC 3.58, NTSC 4.4, PAL, PAL-N, PAL-M, or SECAM to RGB video.
  - Detail** ➤ The sharpness of a display from a video source.

- 
- Diffused Screen** ➤ A type of rear-projection screen which spreads the light striking it. Screen gain is less than 1 but audience viewing angles are increased.
- Display Setting** ➤ An adjustment that affects the display of an image. Such display settings include contrast, brightness, tint, blanking, size, offsets, and others.
- Dot Clock** ➤ The maximum frequency of the pixel clock. Also known as pixel clock rate.
- E-EDID** ➤ The Enhanced Extended Display Identification Data standard, established by VESA, enables properties (such as resolution) of a display device to be detected by the display card in a controlling device such as a PC. The PC, in turn, can then output in a matching format to fill the display. Some sources used with the projector are VESA E-EDID reported.
- Flicker** ➤ A very rapid variation in image brightness caused by a frame rate that is too slow. (See *Interlace*) See also *Lamp Flicker*.
- Foot-candle** ➤ The intensity of visible light per square foot.
- Foot-lambert** ➤ The luminance (brightness) which results from one foot-candle of illumination falling on a perfectly diffuse surface.
- Frame Rate** ➤ The frequency at which complete images are generated. For non-interlaced signals, the frame rate is identical to the vertical frequency. For interlaced signals, the frame rate (also known as field rate) is one half of vertical frequency.
- Gain or Screen Gain** ➤ The ability of a screen to direct incident light to an audience. A flat matte white wall has a gain of approximately 1. Screens with gain less than 1 attenuate incident light; screens with gain more than 1 direct more incident light to the audience but have a narrow viewing angle. For example: An image reflecting off a 10 gain screen appears 10 times brighter than it would if reflected off a matte white wall. Curved screens usually have larger gain than flat screens.
- GPIO** ➤ General Purpose Input Output, used for remote control of a limited number of programmable functions by direct signal or dry-contact connection.
- HDTV** ➤ High-definition Television (1035, 1080 and 1125 lines interlace, and 720 and 1080 line progressive formats with a 16:9 (i.e. 1.77) aspect ratio.
- Help Text** ➤ A display of help information regarding the current task or presentation.
- Horizontal Frequency** ➤ The frequency at which scan lines are generated, which varies amongst sources. Also called horizontal scan rate or line rate.
- Horizontal Offset** ➤ The difference between the center of the projected image and the center of the projector lens. For clarity, offset is often expressed as the maximum amount of the image that can be projected to one side of the lens center without degrading the image quality. Horizontal offset ranges can be affected by the type of lens in use, and whether or not the image is offset vertically at the same time.
- Hot Spot** ➤ A circular area of a screen where the image appears brighter than elsewhere on the screen. A hot spot appears along the line of sight and "moves" with the line of sight. High gain screens and rear screens designed for slide or movie projection usually have a hot spot.
-

- Input** ➤ A physical connection route for a source signal, described by a 2-digit number representing 1) its switcher/projector location and 2) its slot in the switcher/projector.
- Input Signal** ➤ Signal sent from a source device to the projector.
- Interface** ➤ A device, such as the *Serial Digital Input Module*, that accepts an input signal for display by the projector.
- Interlace** ➤ A method used by video tape players and some computers to double the vertical resolution without increasing the horizontal line rate. If the resulting frame/field rate is too low, the image may flicker depending on the image content.
- Keypad** ➤ A small push-button device for controlling most projector settings and operation. For more information, refer to 3.3, *Using the Keypad*.
- Keystone** ➤ A distortion of the image which occurs when the top and bottom borders of the image are unequal in length. Side borders both slant in or out, producing a “keyhole” shaped image. It is caused when the screen and lens surface are not parallel, or (in “X” models) by poor Keystone adjustment.
- Linearity** ➤ The reproduction of the horizontal and vertical size of characters and/or shapes over the entire screen.
- Line of Best Viewing** ➤ When light from a projector is incident on a screen, the light reflects from the screen such that the angle of reflection equals the angle of incidence. The Line of Best Viewing is along the line of reflection.
- Loophrough (Loophru)** ➤ The method of feeding a series of high impedance inputs from a single video source with a coaxial transmission line in such a manner that the line is terminated with its characteristic impedance at the last input on the line.
- Lumen** ➤ The unit of measure for the amount of visible light emitted by a light source.
- Luminance** ➤ The signal representing the measurable intensity (comparable to brightness) of an electronic image when the image is represented as separate *chrominance* and *luminance*. Luminance also expresses the light intensity of a diffuse source as a function of its area; measured in lumens or candles per square foot (1 lumen per square foot = 1 *footlambert*). SMPTE RP 98 calls for a luminance of 12 to 22 footlamberts for theatre screens. See: *Foot-lambert*.
- Lux** ➤ The amount of visible light per square meter incident on a surface.  
*1 lux = 1 lumen/square meter = 0.093 foot-candles*
- Menu** ➤ A list of selectable options displayed on the screen.
- NTSC Video** ➤ A video output format of some video tape and disk players. There are two types of NTSC (National Television Standards Committee) video: NTSC 3.58 and NTSC 4.43. NTSC 3.58 is used primarily in North America and Japan. NTSC 4.43 is less commonly used.
- Optical Aperture** ➤ Commonly called an iris, the optical aperture when adjusted affects true contrast.
- Optical Screen** ➤ A type of rear-projection screen which re-directs light through the screen to increase image brightness in front of the screen. Screen gain is usually greater than 1 but audience viewing angles are reduced.

- 
- PAL Video** ➤ PAL (Phase Alternating Line) video is a 50 Hz standard with 768 x 576 resolution. It is found on some video tape and disk players (used primarily in Europe, China and some South American and African countries).
- Pixel** ➤ The smallest discernible element of data from a computer-generated image.
- Pixel Phase** ➤ The phase of the pixel sampling clock relative to incoming data.
- Pixel Tracking** ➤ The frequency of the pixel sampling clock, indicated by the number of pixels per line.
- Presentation Level** ➤ The projector is at presentation level when an image from a source is displayed without the presence of a slidebar, menu, pull-down list, or error message.
- Projector-to-Screen Distance** ➤ The distance between the projector's front feet centers and the screen. Also called "Throw Distance".
- Protocol** ➤ The type of code format called "A" or "B" utilized by the IR remote keypad(s). The default protocol set at manufacture is Protocol "A". By using two different keypad protocols, adjacent projectors can be controlled independently with their remote IR keypads.
- Pull-down List** ➤ A selectable menu item that unfolds into a list of options pertaining to it.
- QuVis** ➤ A manufacturer of a digital video recorder/player/server, QuBit, frequently used for providing digital cinema data. QuVis image compression uses a proprietary technology called Quality Priority Encoding, based on *wavelets*, in which the user selects a quality level based on *signal-to-noise ratio*. The data rate varies to efficiently maintain that quality level. Frames are coded individually.
- Rear Screen** ➤ A translucent panel for screen projection. Incident light travels through the incident surface of a rear screen and forms an image on the other surface.
- Resizing** ➤ The ability to manipulate through software commands the physical size, placement and/or aspect ratio of an image.
- Resolution (lens)** ➤ The maximum number of alternate white and black horizontal lines that can be distinguished on a screen when a photographic target is placed between the lens and a light source and illuminated by that source.
- Resolution (projector)** ➤ The maximum number of pixels that the projector can display horizontally and vertically across an image, such as 1024 x 768 (called XGA).
- Rise Time** ➤ The time required by the video amplifier of the projector to increase its output from 10% to 90% of the maximum value.
- RGB Video** ➤ The video output (analog or digital) of most computers. Analog RGB video can have 3, 4, or 5 wires — one each for red, green, and blue, and either none, one or two for sync. For three-wire RGB, the green wire usually provides sync. (See TTL Video).
- RS-232** ➤ A common asynchronous data transmission standard recommended by the Electronics Industries Association (EIA). Also called serial communication.
- RS-422** ➤ A less common asynchronous data transmission standard in which balanced differential voltage is specified. RS-422 is especially suited to long distances.
-



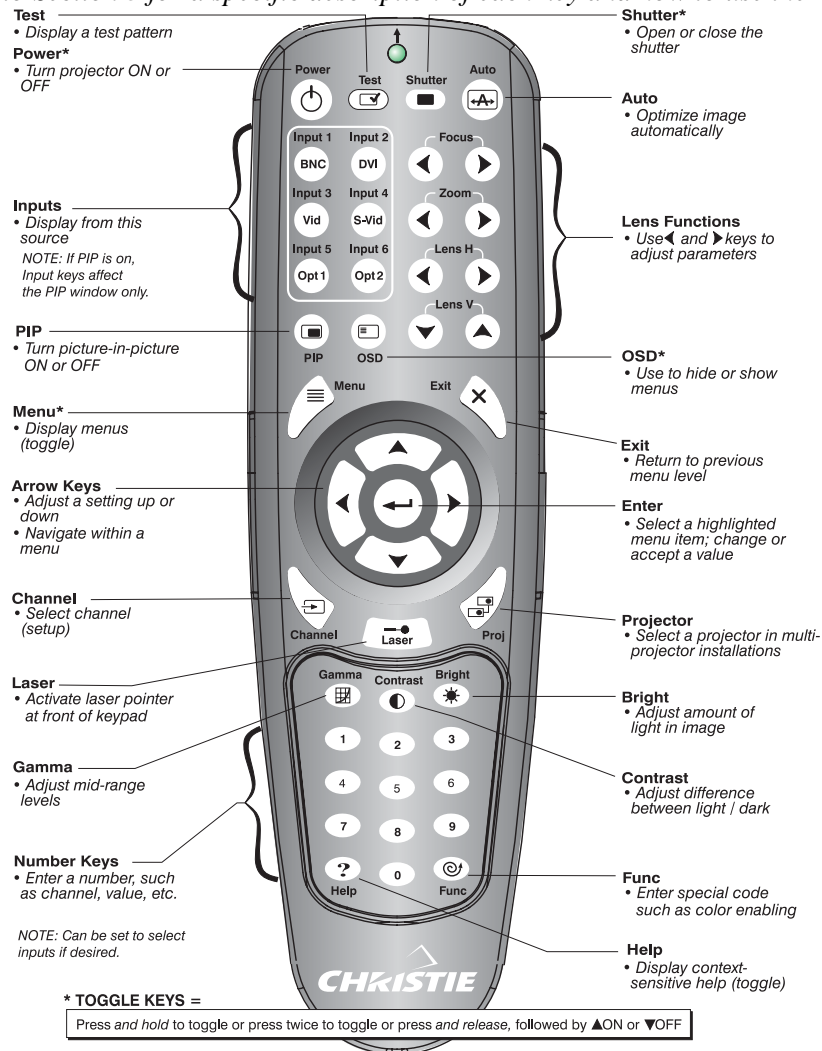
- S-Video** ➤ The output from certain video tape players and video equipment. S-Video separates sync and luminance from color information, typically producing a higher quality display than composite video.
- Scan Frequency** ➤ The horizontal or vertical frequency at which images are generated. Also known as scan rate or refresh rate.
- Scan Line** ➤ One horizontal line on the display.
- Scan Rate** ➤ The horizontal or vertical frequency at which images are generated.
- SECAM** ➤ A video output format of some video tape and disk players (used primarily in France). SECAM (Sequential Couleur á Mémoire) signals are similar in resolution and frequency to PAL signals. The primary difference between the two standards is in the way color information is encoded.
- Slidebar** ➤ A slidebar is a graphical display of an adjustable setting. The numerical setting often represents a percentage but can be a specific unit such as degrees Kelvin.
- Source** ➤ The device, such as a computer or VCR, connected to the projector for display. A source may have numerous corresponding channels defined and recognized by the projector. See *Input*.
- Source Setup** ➤ See *Channel*.
- Switcher** ➤ A signal selector that can be connected to a projector for the purpose of adding more sources.
- Sync** ➤ This term refers to the part of the video signal that is used to stabilize the picture. Sync can occur in three forms:
  - 1) "Composite sync": the horizontal and vertical components are together on one cable.
  - 2) "Sync-on-green": the sync is part of the green video.
  - 3) "Separate sync" or "H.SYNC and V.SYNC": the horizontal and vertical components of the sync are on two separate cables.
- Sync Width** ➤ The duration of each sync pulse generated by a computer. The sync width is part of the blanking time.
- TTL Video** ➤ A type of RGB video with digital characteristics.
- Terminated** ➤ A wire connecting a single video source to a display device, such as a projector, must be terminated by a resistance (usually 75Ω for video).
- Throw Distance** ➤ The distance between the front feet of the projector and the screen. Also called "Projector-to-Screen Distance". Always use the correct Christie throw distance formula to calculate the proper throw distance (±5%) required for your lens.
- Throw Ratio** ➤ Throw ratio = throw distance / screen width. Typically used to differentiate lenses.
- Tint** ➤ Balance of red-to-green necessary for realistic representation of NTSC signals.
- Variable Scan** ➤ The ability of a projector to synchronize to inputs with frequencies within a specified range.

- Vertical Frequency** ➤ The frequency at which images are generated. Vertical frequencies vary amongst sources. Also called vertical scan rate.
- Vertical Offset** ➤ The difference between the center of the projected image and the center of the projector lens. For clarity, offset is often expressed as the maximum amount of the image that can be projected above or below the lens center without degrading the image quality. Vertical offset ranges depend on the type of lens in use, and whether or not the image is offset horizontally at the same time.
- Video** ➤ The signal that is used by display devices (such as projectors) to generate an image. This term also refers to the output of video tape/disk players and computers.
- Video Decoder** ➤ An optional device that converts NTSC 3.58, NTSC 4.4, PAL, PAL-N, PAL-M or SECAM to RGB video.
- Video Standard** ➤ A specific type of video signal, such as NTSC, PAL, SECAM. This projector can automatically recognize and interpret the incoming standard and display accordingly.
- Viewing Angle** ➤ Screens do not reflect equally in all directions. Most light is reflected in a conical volume centered around the "line of best viewing". Maximum brightness is perceived if you are within the viewing cone defined by the horizontal and vertical viewing angles.
- White Balance** ➤ The color temperature of white used by the projector.
- White Boost** ➤ White Boost is an option that enables the recapture of some of the lost light from the transition between each segment in the color wheel.
- White Field** ➤ The area of an image that is white only. For example, a full white field is an image that is white everywhere. A 10% white field is a white area (usually rectangular) that occupies 10% of the image; the remaining 90% is black.
- YCbCr** ➤ A high-end *digital* component video signal.
- YPbPr** ➤ A high-end *analog* component video signal. Sometimes called YUV, Component, or Y, R-Y, B-Y, the YPbPr signal by-passes the video decoder in this projector.
- YUV** ➤ See *YPbPr*.
- Zoom** ➤ The adjustment of image size by means of a zoom lens.





# IR Remote Key Reference

*NOTE: The IR remote is a standard component provided with the projector. Use the extension cable also provided to convert the IR remote to a wired remote, if desired. Refer to Section 3 for a specific description of each key and how to use them correctly.*



*Toggle keys marked with an “\*” require you to press and hold or press twice or use with the up/down arrow keys. Refer to the description of these keys and others in Section 3.*

*NOTE: To turn the OSD off you must press  and .*

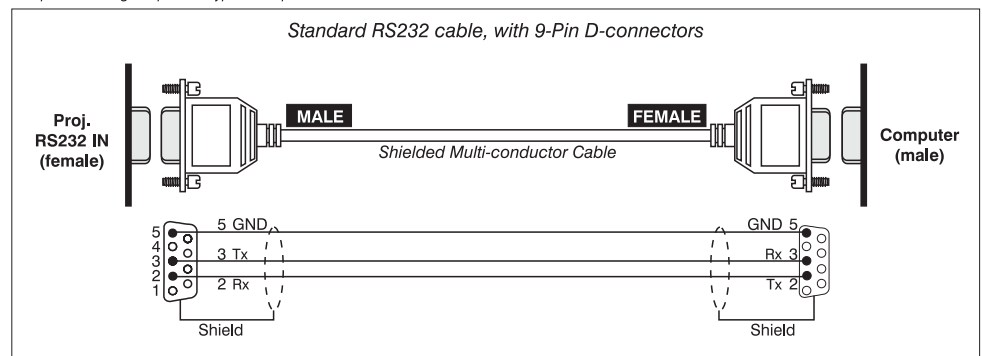


# Serial Communication Cables

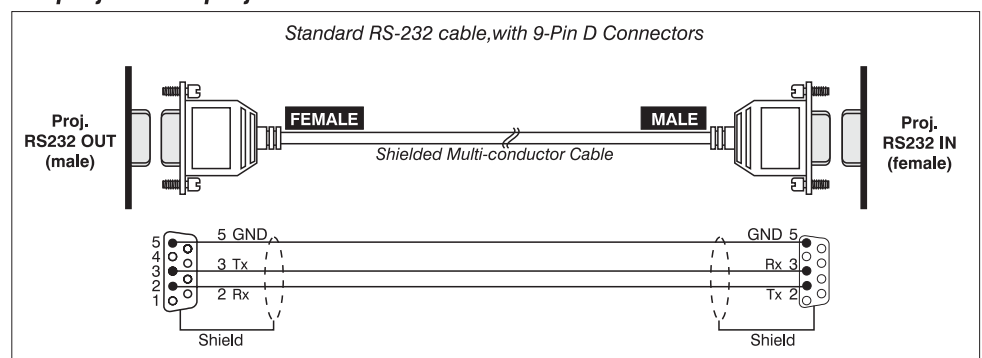
A serial link of RS232 or RS422 enables ASCII communication with the projector so that it can be controlled remotely from a PC or other controller. From a PC, connect a standard 9-wire RS232 serial cable to the **RS232 IN** port. Or, for long-distance (>100 ft.) links with an RS422-compatible PC or controller, connect RS422 cable to the **RS422** port.

## □ From projector to computer (RS232)

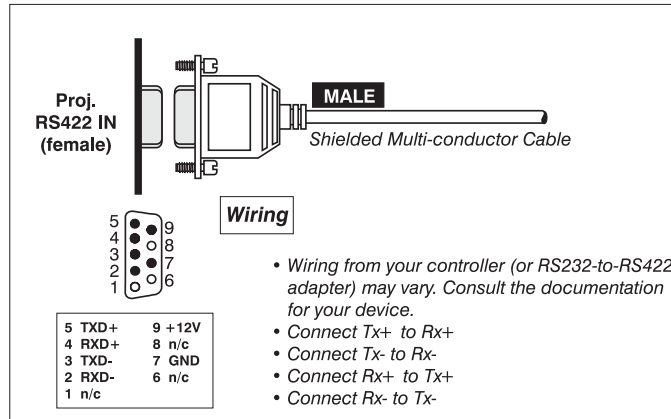
*For computers having a 9-pin "AT" type serial port*



## □ From projector to projector



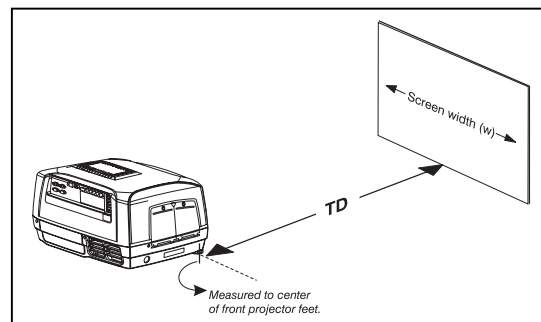
□ **From projector to RS422 compatible computer**



# Throw Distance

## Calculating Throw Distance

It is important throw distance be precisely calculated for your installation using the appropriate formula from the chart below. To calculate throw distance you must know the screen size and the lens type installed in the projector. In general, the larger you want the image to be the greater the distance you must allow between the lens and the screen.



**NOTES:** 1) Throw distance is the perpendicular distance from the screen to the center of the projector's front feet. 2) This measurement is not necessarily parallel to the floor as the projector and screen may be inclined. 3) Due to lens manufacturing, throw distance calculations have a tolerance of  $\pm 5\%$ .

**Table D-1 SXGA+ Throw Formulas**

Lens Throw Ratio	Throw Distance Formula (cm, +/-5%)	Screen Widths **(cm)	
		Min.	Max.
0.8 (fixed)	$TD = .83 * W + 1.46$	51	289
1.2 (fixed)	$TD = 1.15 * W + 24.51$	79	1208
1.3-1.7 (zoom)	Min. $TD = 1.31 * W + 3.18$ Max. $TD = 1.72 * W + 3.12$	69	1114
1.7-2.5 (zoom)	Min. $TD = 1.70 * W - 6.27$ Max. $TD = 2.39 * W - 6.71$	110	862
2.5-4.0 (zoom)	Min. $TD = 2.45 * W + 9.50$ Max. $TD = 4.01 * W - 4.37$	73	1150
4.0-7.0 (zoom)	Min. $TD = 3.84 * W + 27.84$ Max. $TD = 6.67 * W + 31.06$	95	973

**Table D-2 720P Throw Formulas**

Lens Throw Ratio	Throw Distance Formula (cm, +/-5%)	Screen Widths **(cm)	
		Min.	Max.
0.88 (fixed)	$TD = .88 * W + 1.46$	51	289
1.31 (fixed)	$TD = 1.31 * W + 24.51$	79	1208
1.42 - 1.86 (zoom)	Min. $TD = 1.42 * W + 3.18$ Max. $TD = 1.86 * W + 3.12$	69	1114
1.86 - 2.73 (zoom)	Min. $TD = 1.86 * W - 6.27$ Max. $TD = 2.73 * W - 6.71$	110	862
2.73 - 4.38 (zoom)	Min. $TD = 2.73 * W + 9.50$ Max. $TD = 4.38 * W - 4.37$	73	1150
4.38 - 7.66 (zoom)	Min. $TD = 4.84 * W + 27.84$ Max. $TD = 7.66 * W + 31.06$	95	973

Where:

$TD$  = projector distance from the screen to the center of the projector's front feet (cm)

$W$  = screen (image) width (cm)

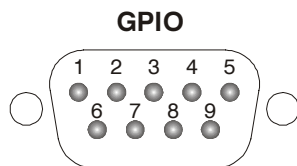
\*\*preliminary data





# System Integration

The GPIO connector located on the input panel provides a flexible method of interfacing a wide range of external I/O devices to the projector. There are 7 GIO pins available on the 9pin D-Sub GPIO connector, which are configurable via RS232 commands. The other two pins are reserved for ground and power – see table below for pin identification.



GPIO Pins	
Pin #	Signal
1	+ 12V (200mA)
2	GPIO 1
3	GPIO 2
4	GPIO 3
5	Ground
6	GPIO 4
7	GPIO 5
8	GPIO 6
9	GPIO 7

The serial cable required for connecting the external device to the projector's GPIO connector, whether it's a standard serial cable or a custom one, must be compatible with the external device.

## Configuring the GPIO

The GPIO connector can be configured to automate any number of events using the serial command code **GIO**. Each pin is defined as either an *input* or *output* depending on the desired outcome. In general, configure the pin as an input if you want the projector to respond to something the device does and as an output if you want the external device to respond to an action taken by the projector. For example, configure the pin as an output if you want the lighting in a room to automatically dim when the projector is turned on.

By using the GIO command, you can also set the state of each pin as *high* or *low*. By default, the state of each pin is *high*. The voltage applied to pins in the *high* state is + 3.3V.

**Example 1.** Turn room lighting on when the projector is turned off. (Assumes a control/automation unit is configured to turn the lights on when pin 2 of it's input goes high.)

(GIO C2 O)

Set pin #2 configuration to output

(GIO 2 H)

Set pin #2 to high (state)

**Query Command**

- (GIO?) *Request the state and configuration of all pins*
- (GIO! "HLLHLH" "OOIOOOI") *Reply of pin state and configuration*
- (GIO? C2) *Request configuration for pin #2*
- (GIO! C2 O) *Reply with pin #2 configuration as output*
- (GIO? 2) *Request the state of pin #2*
- (GIO! H) *Reply with pin #2 state as high*

**Real Time Event**

Use the serial command **RTE** to specify an action that is initiated at a particular time or based on an external stimulus.

**For General Purpose IO "G"**

Parameter	Name	Value
P1	RTE type	G (Real Time I/O Event)
P2	I/O bit	1-7
P3	Pin state (1 Character) (String)	H = High L = Low "LHXXXHL" Combine multiple inputs and trigger occurs when all conditions are met
P4	Commands	Any valid serial protocol command for the device

**Example 2.** Projector powers up when a switch on the external device is turned on.

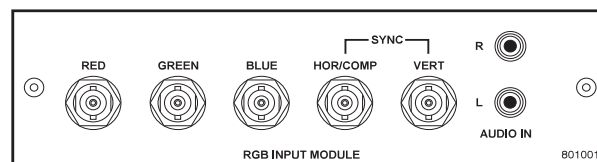
- (GIO C2 I) *Set pin #2 configuration as input*
- (RTE G 2 H "(PWR 1)") *Power on when pin #2 set to high*
- (RTE G 2 L "(PWR 0)") *Power off when pin #2 set to low*

# Optional Input Modules

There are many optional input modules and accessories currently available for this projector. Contact your dealer for a complete and up-to-date listing.

*NOTE: Always unplug the projector or switcher before installing or removing any optional input module.*

- RGB500 Input Module** ➤ The *RGB500 Input Module* may be installed in this projector, a *Marquee Signal Switcher*, or a *Marquee Case/Power Supply*. The module receives analog RGB input signals from computers or other RGB source devices.

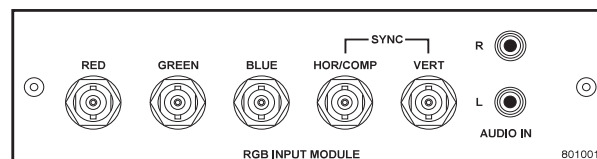


## RGB500 Features

- ◇ accepts 3, 4, or 5 wire RGB video (sync-on-green, composite sync, or separate horizontal and vertical sync), up to 500 MHz bandwidth
- ◇ BNC connectors for RGB signal inputs

*NOTE: The audio connectors are not functional.*

- RGB400BA Input Module** ➤ The *RGB400 Buffered Amplifier Input Module* may be installed in this projector, in a *Marquee Signal Switcher* or in a *Marquee Case/Power Supply*. Connect three-, four-, or five-wire RGB video signals of up to 400 MHz bandwidth, signals typically produced by high-resolution computer or workstations. The buffering capability of the module enables the incoming signal to be sent to a remote destination. Inputs are 75Ω terminated.



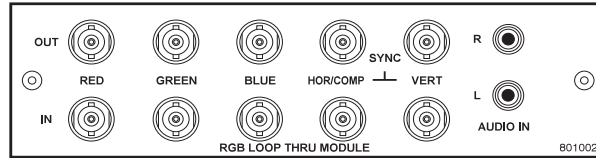
## RGB400BA Features

- ◇ accepts 3, 4, or 5 wire RGB video (sync-on-green, composite sync, or separate horizontal and vertical sync)
- ◇ BNC connectors for RGB signal inputs
- ◇ Buffered signals to a remote destination

*NOTE: The audio connectors are not functional.*

**RGB400 Active Loop-Thru Input Module 38-804607-xx**

➤ The *RGB400 ALT Input Module* may be installed in this projector, a *Marquee Signal Switcher*, or a *Marquee Case/Power Supply*. The module receives analog RGB input signals from computers or other RGB source devices. Video inputs are 75Ω terminated. Video outputs provide buffered loop-through to another display device.



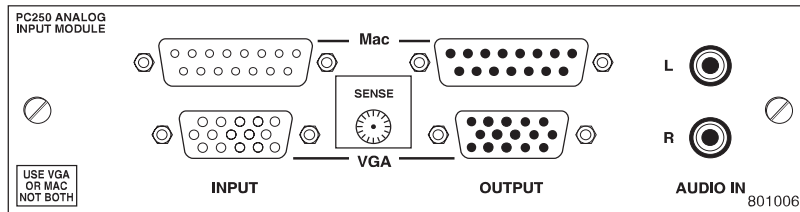
**RGB400ALT Features**

- ◇ accepts 3, 4, or 5 wire RGB video (sync-on-green, composite sync, or separate horizontal and vertical sync)
- ◇ BNC connectors for RGB signal inputs
- ◇ buffered loop-through video outputs

*NOTE: The audio connectors are not functional.*

**PC250 Analog Input Module 38-804609-xx**

➤ The *PC250 Analog Input Module* may be installed in this projector, a *Marquee Signal Switcher* or a *Marquee Case/Power Supply*. The module receives analog RGB input signals from IBM PC compatibles or Macintosh computers. Video inputs are 75Ω terminated. Video outputs are provided for buffered loop-through to another display device.

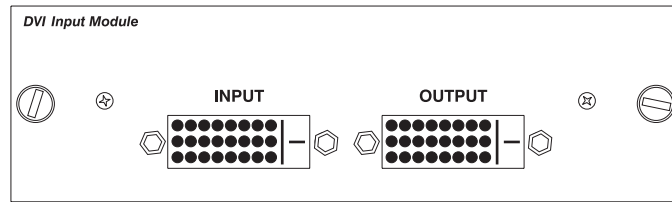


**PC250 Analog Features**

- ◇ accepts VGA or MAC RGB video
- ◇ 15 pin D connectors for video
- ◇ active loop-through video outputs

*NOTES: 1) This interface does not accept VGA and MAC signals simultaneously. 2) The audio connectors are not functional. 3) Trademarks are the rights of their respective owners.*

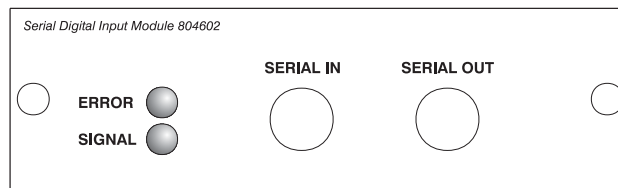
- **DVI Input Module 38-804635-xx** This module can display digital video input signals conforming to the DVI (Digital Visual Interface) single-channel standard.



**Features**

- ◇ supports Digital Visual Interface (DVI) single-channel
- ◇ supports VESA® Extended Display Identification Data (EDID™)
- ◇ provides an active-loop-through using a DVI connector (conforming to the DVI Specification)

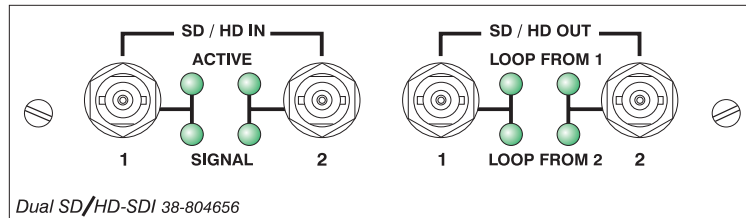
- **Serial Digital Input Module 38-804602-xx** This module accepts a serial digital 4:2:2 component video signal (YCbCr) via a single **SERIAL IN** BNC connector. The signal can loop through the **SERIAL OUT** BNC out to another device (such as another projector). Inputs are 75Ω terminated.



**SDI Features**

- ◇ accepts serial digital 4:2:2 component video (YCbCr)
- ◇ provides both a **SERIAL IN** and a **SERIAL OUT** BNC connector
- ◇ includes status LEDs for signal and error

- **Dual SD/HD-SDI Module 38-804656-xx** The *Dual SD/HD-SDI Module* enables incoming serial digital data to be tiled across multiple screen displays, overlapped for extra-bright displays, or distributed to additional projectors for multiple, same-image screens.



**Dual SD/HD-SDI Features**

- ◇ accepts and decodes up to two serial digital inputs
- ◇ outputs up to two 10-bit YCbCr 4:2:2 video signals
- ◇ provides input(s) to output(s) loop-through capability
- ◇ supplies interchangeable inputs as part of the Picture-in Picture display



# 300W P-VIP® Product Safety Data Sheet

## PRODUCT SAFETY DATA SHEET (PSDS) for VIP® Videoprojection lamps



OSRAM High Pressure Mercury Discharge Lamps, manufactured by OSRAM GmbH, are exempted from the requirements of the OSHA Hazard Communication Standard (29 CFR 1910.1200) because they are “articles.” The following information is provided by OSRAM GmbH as a courtesy to its customers.

### I. PRODUCT IDENTIFICATION

Trade Name (as labeled): OSRAM VIP Super High Pressure Mercury Discharge Lamp

This data sheet covers the following models:

P-VIP 300/1.3 E21.8

Manufacturer:  
OSRAM GmbH  
Hellabrunner Strasse 1  
81536 Munich  
Germany

For General Information and for technical inquiries:  
OSRAM GmbH  
FOMS/KAM  
13625 Berlin  
Germany

### II. HAZARDOUS INGREDIENTS

**THERE ARE NO KNOWN HEALTH HAZARDS FROM EXPOSURE TO LAMPS THAT ARE INTACT.** The following information is for the arc-tube portion of the bulb only, and does not include materials used in the reflector or base. If the lamp is broken, the following materials may be released:

Chemical Name	CAS Number	% by wt.	Exposure Limits in Air (mg/cubic m)	
			ACGIH (TLV)	OSHA (PEL)
<sup>(1,2)</sup> Mercury	7439-97-6	<0.125	0.025	0.1 Ceiling
Quartz, Fused	60676-86-0	<20	0.1 Resp. Dust	0.1
Tungsten	7440-33-7	1-2	---	---
(Insoluble compounds)			5	10
Molybdenum	7439-98-7	1-2	---	---
(Insoluble compounds)			10	15
<sup>(1)</sup> Nickel	7440-02-0	<0.2	0.05	1

(1) These chemicals are subject to the reporting requirements of section 313 of Title III of the Superfund Amendments and Reauthorization Act of 1986 and 40 CFR Part 372.

(2) The mercury in this product is one of the substances known to the state of California to cause reproductive toxicity if ingested. [California Safe Drinking Water and Toxic Enforcement Act of 1986 (Proposition 65).]

### III. PHYSICAL PROPERTIES

Not applicable to intact lamp.



Product Safety Data Sheet for OSRAM Videoprojection Lamps

---

IV. FIRE & EXPLOSION HAZARDS

---

Flammability: ignition temperature of front-cap material: 595°C

Fire Extinguishing Materials: Use extinguishing agents suitable for surrounding fire, such as water spray, foam, dry powder, or CO<sub>2</sub>.

Special Firefighting Procedure: Use a self-contained breathing apparatus to prevent inhalation of dust and/or fumes that may be generated from broken lamps during firefighting activities.

Unusual Fire and Explosion Hazards: When exposed to high temperature, toxic fumes may be released from broken lamps.

Fire Fighting Protective Equipment: A self-contained breathing apparatus and suitable protective clothing should be worn in fire conditions.

Hazardous Decomposition Products: CO, CO<sub>2</sub>

---

V. HEALTH HAZARDS

---

A. OPERATING LAMPS

Consult the OSRAM GmbH product catalog or technical data sheets for complete warnings, operating and installation guides for specific bulb types.

**WARNING:**

- This VIP lamp operates at high pressure and at high temperature and may unexpectedly shatter.
- This VIP lamp generates ultraviolet radiation which may cause skin and eye irritation with prolonged exposure.
- This VIP lamp must be operated only in suitably designed, enclosed fixtures which prevent direct observation of the arc and will prevent lamp fragments from exiting, in the unlikely event of a lamp rupture.

B. LAMP MATERIALS

**THERE ARE NO KNOWN HEALTH HAZARDS FROM EXPOSURE TO LAMPS THAT ARE INTACT.** No adverse effects are expected from occasional exposure to broken lamps. As a matter of good practice, avoid prolonged or frequent exposure to broken lamps unless there is adequate ventilation. The major hazard from broken lamps is the possibility of sustaining glass cuts.

*NIOSH/OSHA Occupational Health Guidelines for Chemical Hazards and/or NIOSH Pocket Guide to Chemical Hazards lists the following effects of overexposure to the chemicals/materials tabulated below when they are inhaled, ingested, or contacted with skin or eye:*

Mercury - Exposure to high concentrations of vapors for brief periods can cause acute symptoms such as pneumonitis, chest pains, shortness of breath, coughing, gingivitis, salivation and possibly stomatitis. May cause redness and irritation as a result of contact with skin and/or eyes.

Quartz, Fused - Fibrosis of the lungs causing shortness of breath and coughing has been associated with silica exposure.

Tungsten - Inhalation of dust may cause mild irritation of nose and throat. Contact may cause mechanical irritation of skin and eyes.

Molybdenum - Oxides have caused irritation to the eyes, nose, and throat; weight loss and digestive disturbances in experimental animals.

Nickel - Skin contact may cause an allergic rash. Inhaled dust of nickel and its compounds have been reported to cause cancer of the lungs and sinuses. Nickel itself is not very toxic if swallowed, but its soluble salts are quite toxic and, if swallowed, may cause giddiness and nausea.

Product Safety Data Sheet for OSRAM Videoprojection Lamps

EMERGENCY AND FIRST AID PROCEDURES

Glass Cuts: Perform normal first aid procedures. Seek medical attention as required.

Inhalation: If discomfort, irritation or symptoms of pulmonary involvement develop, remove from exposure and seek medical attention.

Ingestion: Seek medical attention.

Contact, Skin: Thoroughly wash affected area with mild soap or detergent and water and prevent further contact. Seek medical attention if irritation occurs. The molten polymer of the front cap adheres to the skin and causes severe burns. Do not try to remove molten polymer from the skin. Cool with water immediately.

Contact, Eye: Wash eyes, including under eyelids, immediately with copious amounts of water for 15 minutes. Seek medical attention.

CARCINOGENIC ASSESSMENT (NTP ANNUAL REPORT, IARC MONOGRAPHS, OTHER):

Nickel was identified as a known or suspected carcinogen by NTP and/or IARC.

---

VI. REACTIVITY DATA

---

Stability: Stable, front cap material degrades at temperatures above 460°C.

Conditions to avoid: None for intact lamps.

Incompatibility (materials to avoid): None for intact lamps.

Hazardous Decomposition Products (including combustion products): CO, CO<sub>2</sub>.

Hazardous Polymerization Products: Will not occur.

---

VII. PROCEDURES FOR DISPOSAL OF LAMPS

---

If lamps are broken, ventilate area where breakage occurred. Clean-up with mercury vacuum cleaner or other suitable means that avoids dust and mercury vapor generation. Take usual precautions for collection of broken glass. Place materials in closed containers to avoid generating dust and mercury vapor.

It is the responsibility of the waste generator to ensure proper classification of waste products. To that end, TCLP tests should be conducted on all waste products, including this one, to determine the ultimate disposition in accordance with applicable federal, state and local regulations.

---

VIII. SPECIAL HANDLING INFORMATION - FOR BROKEN LAMPS

---

Ventilation: Use adequate general and local exhaust ventilation to maintain exposure levels below the PEL or TLV limits. If such ventilation is unavailable, use respirators as specified below.

Respiratory Protection: Use appropriate NIOSH approved respirator if airborne dust concentrations exceed the pertinent PEL or TLV limits. All appropriate requirements set forth in 29 CFR 1910.134 should be met.

Eye Protection: OSHA specified safety glasses, goggles or face shield are recommended if lamps are being broken.

Protective Clothing: OSHA specified cut and puncture-resistant gloves are recommended for dealing with broken lamps.

Hygienic Practices: After handling broken lamps, wash thoroughly before eating, smoking or handling tobacco products, applying cosmetics or using toilet facilities.

---

Although OSRAM attempts to provide current and accurate information herein, it makes no representations regarding the accuracy or completeness of the information and assumes no liability for any loss, damage or injury of any kind which may result from, or arise out of, the use of or reliance on the information by any person.

---

Issue Date: March, 2004

Revision: 1.0

---



# Index

---

## A

- Adjusting Input Levels, 3-29
- Advanced Image Settings, Submenu, 3-31
- Anamorphic, 3-22
- Arrow Key, 3-9
- Arrow Keys, 3-9
- Auto Input Level, 3-26
- Auto Key, 3-5
- Auto Setup, 3-5, 3-19
- Automatic Gain Control (AGC), 3-26
- AutoSource Checkbox, 3-19

## B

- Bad Sync, 3-64
- Baud Rate, 2-18, 3-36
- Blacklevels and Drives, 3-29
- Blanking, 3-23
- Brightness Key, 3-7, 3-25
- Brightness Uniformity
  - Canceling, 3-60
  - Definition, 3-56
  - Prerequisites, 3-56
  - Procedure, 3-56
  - Submenu, 3-40
- Broadcast Key, 3-38
- Broadcasting, 3-8
- Built-in Keypad, 3-1, 3-3

## C

- Ceiling Mount, 2-10
- Channel
  - Locked, 3-19
  - Name, 3-18
  - Number, 3-15, 3-18
  - Signal Type, 3-16
- Channel Copy/Delete, 3-17
- Channel Edit Menu, 3-18
- Channel Key, 3-6, 3-14
- Channel Selection, 3-15
- Channel Setup Menu, 3-16
  - And Enter Key, 3-17
  - And Function Key, 3-17
- Channels
  - Creating Automatically, 3-15
  - Creating in Channel Setup Menu, 3-17, 3-18

- Definition of, 3-14
- Deleting in Channel Setup Menu, 3-17
- Checkbox Toggles, 3-12
- ChristieNET. *See*
  - Communications:ChristieNET
- Clamp Tip, 3-29
- Color Adjustment, 3-31, 3-41
  - Color Saturation Submenu, 3-43
  - XY Submenu, 3-42
- Color Enable, 3-43
- Color Matching, 3-53
- Color Space, 3-26
- Color Temperature, 3-32
- Color Wheel
  - Calibration of, 3-45
- Communications
  - ASCII Messaging, 3-63
  - Baud Rate, 3-36
  - ChristieNET, 3-63
  - Ethernet, 3-63
  - Remote Control of Projector, 3-63
  - Submenu, 3-36
- Component Video
  - Connection, 2-13
- Composite Video
  - Connection, 2-14
- Configuration Menu, 3-34
- Contrast Key, 3-7, 3-24
- Custom Sizing, 3-20

## D

- Date and Time
  - Setting, 3-34
- Decoder Luma Delay, 3-28
- Detail, 3-25
  - Threshold, 3-34
- Diagnostics and Calibration, Submenu, 3-43
- Display
  - Channel List, 3-35
  - Error Messages, 3-35
  - Menu Location, 3-35
  - Slidebars, 3-35
- DVI Digital Video
  - Connection, 2-14

## E

- Edge Blending, 3-40
  - Description, 3-60
  - How Blends Are Used, 3-60

- Main functions, 3-60
- Enter Key, 3-9
- Error Codes, 3-65
- Error Conditions, 3-64
- Error Messages
  - Bad Sync, 3-64
  - H-Sync or V-Sync, 3-65
  - No Signal, 3-64
  - System Warnings/Errors, 3-65
- Ethernet
  - Communications, 2-16
  - Troubleshooting, 5-3
- Ethernet Network, 2-18
- Ethernet Settings, 3-37
- Exit Key, 3-9

**F**

- Film Mode Threshold, 3-33
- Frame Delay, 3-33, 3-34
- Frame Delay Monitor, 3-33
- Frame Lock Enable, 3-33
- Freeze Image, 3-43
- Full Height, 3-21
- Full Screen, 3-21
- Full Width, 3-21
- Function Key, 3-8

**G**

- Gamma Key, 3-7, 3-25
- Gamma Table, 3-31
- Gamma, Description of, 3-25
- Glossary of Terms, 1

**H**

- Help
  - Context-sensitive, 3-10
  - From presentation level, 3-11

**I**

- Image
  - Orientation, 3-34
  - Troubleshooting, 5-1
- Image Adjustments, 3-19
- Image Position, 3-23
- Image Resizing, 3-20
- Image Size, 3-22, 3-23
- InMenu Checkbox, 3-18
- Input
  - Definition of, 3-14
  - Levels, 3-28
  - Selecting/switching, 3-14
  - Settings, Advanced, 3-31
- Input 1, 2-12
- Input 1 Key, 3-6
- Input 2, 2-14
- Input 2 Key, 3-6

- Input 3 Key, 3-6
- Input 4 Key, 3-6
- Input 5 Key, 3-6
- Input 6 Key, 3-6
- Input Level, Auto, 3-28
- Input Panel, 3-2
- Input Video Black, 3-27
- Installation
  - Ambient Lighting, 2-5
  - Horizontal Position, 2-8
  - Other Considerations, 2-5
  - Quick Setup, 2-1
  - Types, 2-3
  - Vertical Position, 2-6
- Interfaces, Optional, 2-14

, ...  
Invalid Channel, 3-64

- IP Address, 3-37
  - Setting, 2-18

- IR Remote
  - Description of, 1
- IR Remote Keypad, 3-4
- IR Sensors, 3-3
- IR Sensors, 3-38

**K**

- Kensington Security Lock, 3-3
- Keypad
  - Backlight, 3-38
  - Built-in, 3-3
  - Enabling Wire Remote, 3-38
  - IR Remote, 3-4
  - Wired Remote, 3-5
- Keypad Commands, 3-3, 3-5
- Keypad Guidelines, 3-5

**L**

- Lamp
  - Cleaning of, 4-4
  - Dual Lamp, 3-51
  - Replacement, 4-2, 4-5
  - Single Lamp, 3-51
  - Troubleshooting, 5-3
- Lamp Door, 3-3
- Lamp History, 3-52
- Lamp Hours, 3-52
- Lamp Limit, 3-51
- Lamp Menu, 3-49
- Lamp Message, 3-51
- Lamp Mode, 3-51
- Lamp Operation, 3-51
  - Auto-Switching, 3-49
- Lamp Power, 3-51
- Lamp Serial Number, 3-52
- Lamp Status, 3-52
- Language
  - Choosing, 3-34

Laser Key, 3-10  
 Lens  
   Cleaning of, 4-4  
   Offset Adjustment, 2-6, 2-8  
   Release Button, 3-2  
   Replacement, 4-8  
 Lens Mount, 3-2  
 Level Value, 3-46  
 Locked Channel Checkbox, 3-19  
 Luma Delay, 3-28

## M

Menu  
   Channel Edit, 3-18  
   Channel Setup, 3-16  
   Configuration, 3-34  
   Image Settings, 3-24  
   Lamp, 3-49  
   Main, 3-10  
   PIP and Switching, 3-46  
   Size and Position, 3-20  
   Status, 3-53  
 Menu Font Size, 3-35  
 Menu Key, 3-7  
 Menu Location on Screen, 3-35  
 Menu Navigation, 3-10, 3-19  
 Menu Preferences submenu, 3-35  
 Motion Filter, 3-33  
 Multiple Projectors  
   Description, 3-53

## N

Network Routing, 3-36  
 Network, Split. *See* Split Network  
 No Resizing, 3-21  
 No Signal, 3-64  
 Noise Reduction, 3-25  
 Numerical Entry, 3-13

## O

Odd Pixel Adjustment, 3-44  
   Level Detector, 3-45  
 Offsets  
   Horizontal, 2-6, 2-8  
   Vertical, 2-6, 2-8  
 On Screen Display, 3-7  
 Optional Input Modules, 2-14, 1  
 OSD Key, 3-7

## P

Peak Detector, 3-29, 3-45  
 PIP, 3-46  
   Border Color, 3-48  
   Border Width, 3-48  
   Enable, 3-47

Image Settings. *See* Image Settings  
 Pixel Phase, 3-22  
 Pixel Tracking, 3-22  
 Port Number  
   Changing, 2-19  
   Entering, 3-37  
 Power  
   Connection, 2-20  
   Line Cord, 4-2  
   Requirements, 6-4  
 Power On/Off Key, 3-5  
 Powerup, Auto, 3-34  
 Primary Colors, Adjusting, 3-53  
 Projector  
   Assigning/Changing Number, 3-36  
   Location, 4-2  
   Mounting, 2-10  
   Number, 3-13  
   Position and Mounting, 2-5  
   Resetting, 3-65  
 Projector Height, 3-2  
   How to Adjust, 2-11  
 Projector Number, 3-8  
 Pull-Down Lists, Use of, 3-12

## R

Remapping Keypad. *See* Working with  
 PIP or Seamless Switching  
 Remote  
   Replacing Batteries, 4-5  
 Resizing, 5-1  
 RGB  
   Connection, 2-12  
 RS-232  
   Connection, 2-15  
 RS-422  
   Connection, 2-15

## S

Screen Size, 2-4, 2-5  
 Seamless Switching, 3-46. *See* Working  
 with PIP or Seamless Switching  
   Fade Time, 3-48  
   Image Optimization. *See* Working with  
   PIP or Seamless Switching  
 Serial Ports  
   Communication Cables, 1  
 Service Requirements, 4-3  
 Setting RGB Levels, 3-28  
 Shutter Key, 3-8  
 Simulation 3D  
   Frame Delay, 3-33  
   Frame Delay Monitor, 3-33  
   Frame Lock, 3-33  
 Simulation 3D, Submenu, 3-33  
 Slidebar Adjustment, 3-11

- Slidebars
    - "Direct", 3-12
    - Using, 3-12
  - Source
    - Specifying a Location, 3-6
  - Source Setup. *See Channel*
  - Splash Screen Setup. *See Menu: Splash*
    - Screen Setup
  - Split Network, 3-36
  - Split Networks
    - Options for Setup, 2-19
  - S-Video
    - Connection, 2-14
  - Swap Main and PIP Image. *See PIP*
  - Switcher, 3-18
  - Sync
    - Def. and types, 6
  - System Integration
    - GPIO Connector, 2-20
- T**
- Temperature, 2-5
    - Non-Operating, 6-5
    - Operating, 6-5
  - Test Pattern Grey Level, 3-43
  - Test Patterns via Menus, 3-38
  - Text
    - Editing, 3-13
  - Throw Distance
    - Definition of, 2-5, 1
    - Formulas, 1
  - Time-outs, 3-11
  - Troubleshooting
    - Displayed Image, 5-1
    - Ethernet, 5-3
    - Lamps, 5-3
    - Power, 5-1
- V**
- Ventilation, 3-2, 4-3
  - Vertical Stretch, 3-22
  - Video Options, 3-26
  - Video Standard*, 3-27
  - Video Standards, 3-27
- W**
- White Boost, 3-32
  - Wired Remote, 3-5
- Y**
- YPbPr, 3-26
    - Connection, 2-13