

# M-Series



**USER MANUAL**

020-100009-01



## China RoHS Compliance Information

### 关于中国《电子信息产品污染控制管理办法》的说明

- Environmentally Friendly Use Period

环保使用期限



The year number in the centre of the label indicates the Environmentally Friendly Use Period, which is required to mark on the electronic information product sold in China according to the China RoHS regulations.

本标志中表示的年数是根据《电子信息产品污染控制管理办法》（2006年2月28日）以及《电子信息产品污染控制标识要求》（2006年11月6日）制定的、适用于在中华人民共和国境内销售的电子信息产品的环保使用期限。

- Material Concentration Values Table

有毒有害物质含量表

Part Name	部件名称	Material Concentration (有毒有害物质或元素)					
		铅 ( Pb )	汞 ( Hg )	镉 ( Cd )	六价铬 ( Cr 6+ )	多溴联苯 ( PBB )	多溴二联苯醚 ( PBDE )
Power Supply	电源适配器	X	O	O	O	O	O
Switch interlock	开关安全锁	X	O	O	O	O	O
Harness/cable	电线/电缆	X	O	O	O	O	O
Panel Driver PCB	面板驱动模块	X	O	O	O	O	O
Passive black plane PCB	无源背板	X	O	O	O	O	O
Lamp driver	灯源驱动模块	X	O	O	O	O	O
LCD control panel	LCD 控制面板	X	O	O	O	O	O
Blower/Fan	吹风机/风扇	X	O	O	O	O	O
Sensor	传感器	X	O	O	O	O	O
Light engine	光学引擎	X	O	X	O	O	O
Integrator	光学积分器	X	O	X	O	O	O
Dynamic iris	动态光圈	X	O	O	O	O	O
Auxiliary optics	辅助光学器件	X	O	X	O	O	O
Lamp	灯源	X	X	O	O	O	O
Projection lens	投影镜头	X	O	X	O	O	O
Motorized lens mount	马达驱动镜头架	X	O	O	O	O	O
Remote control IR	红外线遥控器	X	O	O	O	O	O
Mechanical enclosure*	机械附件/外壳	X	O	O	O	O	O

Note:

**O**: indicates that the concentration value of the particular hazardous substance contained in all the homogeneous materials for this part, according to EIP-A, EIP-B, EIP-C, is below the stipulated levels in China SJ/T11363-2006.

表示该有毒有害物质在该部件所有均质材料中的含量均在 SJ/T11363-2006 规定的限量要求以下。

**X**: indicates that the concentration value of the particular hazardous substance contained in all the homogeneous materials for this part, according to EIP-A, EIP-B, EIP-C, may be above the stipulated levels in China SJ/T11363-2006.

表示该有毒有害物质至少在该部件的某一均质材料中的含量可能超出 SJ/T11363-2006 规定的限量要求。

\* This part uses metallic alloys, which may contain Lead. 因该部件使用金属合金材料，故可能含有铅。



## 1 Introduction

1.1 Using this Manual .....	1-2
1.1.1 Labels and Markings .....	1-2
1.1.2 Typographical Notations .....	1-2
1.2 Purchase Record and Service Contacts .....	1-2
1.3 Projector Overview .....	1-3
1.3.1 Main Features .....	1-3
1.3.2 How the Projector Works .....	1-4
1.4 Other Components .....	1-4

## 2 Installation and Setup

2.1 Projector Quick Setup and Installation .....	2-2
2.2 Detailed Setup and Installation .....	2-6
2.2.1 About the Projector .....	2-6
2.2.2 Installation Considerations .....	2-8
2.2.3 Projector Position and Mounting .....	2-11
2.2.4 Mounting .....	2-17
2.2.5 Adjusting Projector Height/Tilt .....	2-17
2.2.6 Basic Optical Alignment .....	2-18
2.2.7 Advanced Optical Alignment .....	2-19
2.2.8 Powering Down .....	2-21
2.2.9 Connecting Communications .....	2-22
2.3 Connecting Sources .....	2-30

## 3 Operation

3.1 Using the Remote Keypad or Built-In Keypad .....	3-2
3.1.1 Remote Keypad Commands .....	3-5
3.2 Navigating the Menus .....	3-10
3.3 Using Inputs and Channels .....	3-14
3.3.1 Channel Setup Menu .....	3-16
3.4 Adjusting the Image .....	3-20
3.4.1 Size and Position Menu .....	3-21
3.4.2 Image Settings Menu .....	3-25
3.5 Configuration - Adjusting System Parameters and Advanced Controls .....	3-36
3.6 Working with PIP or Input Switching .....	3-50
3.6.1 Input Switching & PIP Menu .....	3-51
3.7 Lamp .....	3-53
3.8 Status .....	3-54
3.9 Using Multiple Projectors .....	3-55
3.10 Remote Control of the Projector .....	3-58
3.11 Alarm Conditions .....	3-59

4 Maintenance

4.1 Safety Warnings and Guidelines.....4-2

    4.1.1 General Precautions .....4-2

    4.1.2 AC /Power Precautions .....4-3

    4.1.3 Lamp Precautions.....4-3

4.2 Maintenance of the Cooling System.....4-4

    4.2.1 Ventilation.....4-4

    4.2.2 Optional Filters .....4-4

4.3 Maintenance of Optics .....4-5

    4.3.1 Optical (Excluding Lens).....4-5

    4.3.2 Cleaning the Lens.....4-6

4.4 Replacing the Lamps .....4-6

5 Troubleshooting

5.1 Power .....5-2

    5.1.1 Projector Does Not Power ON.....5-2

5.2 Lamp .....5-2

    5.2.1 Lamp Does Not Ignite.....5-2

    5.2.2 Lamp Suddenly Turns OFF.....5-2

    5.2.3 Flicker, Shadows Or Dimness.....5-2

    5.2.4 LiteLOC™ Does Not Seem to Work .....5-3

5.3 LCD .....5-3

    5.3.1 Blank Screen, No Menu Displaying .....5-3

5.4 Remote Keypad.....5-3

    5.4.1 Remote Keypad Does Not Seem to Work .....5-3

5.5 OSD .....5-3

    5.5.1 The OSD Menu does not display .....5-3

5.6 Ethernet.....5-4

    5.6.1 Trouble Establishing Communication with Projector.....5-4

5.7 Displays .....5-4

    5.7.1 The projector is on but there is no display .....5-4

    5.7.2 Severe Motion Artifacts .....5-4

    5.7.3 Image Appears ‘Squeezed’ or Vertically Stretched into Center of Screen.....5-4

    5.7.4 The Display is Jittery or Unstable.....5-5

    5.7.5 The Display is Faint .....5-5

    5.7.6 The Upper Portion of the Display is Waving, Tearing or Jittering.....5-5

    5.7.7 Portions of the Display are Cut OFF or Warped to the Opposite edge.....5-5

    5.7.8 Display Appears Compressed (Vertically Stretched) .....5-5

    5.7.9 Data is Cropped from Edges .....5-5

    5.7.10 Display Quality Appears to Drift from Good to Bad, Bad to Good .....5-5

    5.7.11 Display has Suddenly Frozen.....5-5

    5.7.12 Colors in the Display are Inaccurate .....5-6

    5.7.13 Values in Color Saturation slide bars vary overtime .....5-6

    5.7.14 Display is Not Rectangular .....5-6

5.7.15 Display is “Noisy” .....5-6

**6 Specifications**

6.1 Image Performance ..... 6-2

    6.1.1 Pixel Format ..... 6-2

    6.1.2 Brightness (ANSI Lumens) ..... 6-2

    6.1.3 Contrast ..... 6-2

    6.1.4 Luminance Uniformity ..... 6-3

    6.1.5 Color Uniformity ..... 6-3

    6.1.6 Color Primaries ..... 6-3

    6.1.7 Gamma ..... 6-3

    6.1.8 Grayscale/Color Resolution ..... 6-3

    6.1.9 Color Temperature ..... 6-3

    6.1.10 Convergence ..... 6-4

    6.1.11 Blemishes ..... 6-4

    6.1.12 Pixel Defects ..... 6-5

    6.1.13 Image Artifacts ..... 6-5

    6.1.14 Picture Centering ..... 6-5

6.2 Feature Set ..... 6-5

    6.2.1 Airflow ..... 6-5

    6.2.2 Air Filters (Optional) ..... 6-5

    6.2.3 Dust Sealing ..... 6-5

    6.2.4 ILS (Intelligent Lens System) ..... 6-6

    6.2.5 Projection Lens Compatibility ..... 6-6

    6.2.6 Dynamic Iris ..... 6-6

    6.2.7 Automatic Fans ..... 6-7

    6.2.8 Automatic Color Filtering ..... 6-7

    6.2.9 Constant Lamp Output Management ..... 6-7

    6.2.10 Shutter ..... 6-7

    6.2.11 Lamps ..... 6-7

    6.2.12 Status LED ..... 6-8

    6.2.13 Electronics/SW ..... 6-8

6.3 Image Processor Performance ..... 6-9

6.4 Input (Source Signal) Compatibility ..... 6-9

    6.4.1 Analog (Only) Input ..... 6-9

    6.4.2 Twin HDMI Input ..... 6-9

    6.4.3 Dual Link DVI Input ..... 6-10

    6.4.4 Video Decoder Input ..... 6-10

    6.4.5 Dual Standard Definition, High Definition or Serial Digital Input ..... 6-10

6.5 Control Signal Compatibility ..... 6-10

    6.5.1 Remote Dual Frequency ..... 6-10

    6.5.2 Control Receiver ..... 6-11

    6.5.3 RS232 ..... 6-11

    6.5.4 RS422 ..... 6-11

    6.5.5 Ethernet ..... 6-11

6.5.6 USB 2.0 Device Port .....	6-11
6.5.7 GPIO .....	6-11
6.5.8 DMX512 Interface .....	6-11
6.5.9 Built-In Keypad and Display .....	6-11
6.5.10 AMX/Crestron Support.....	6-12
6.6 Power Requirements .....	6-12
6.6.1 Lamp Specification .....	6-13
6.7 Physical Specifications .....	6-13
6.7.1 Size.....	6-13
6.7.2 Adjustment.....	6-13
6.7.3 Weight.....	6-13
6.7.4 Operating Position.....	6-13
6.7.5 Cosmetics .....	6-13
6.8 Reliability and Serviceability.....	6-14
6.8.1 Reliability.....	6-14
6.8.2 Serviceability .....	6-14
6.9 Environment.....	6-14
6.9.1 Temperature/Humidity/Altitude.....	6-14
6.10 Accessories and Service Components .....	6-14
6.10.1 Service Components .....	6-15
6.11 Regulatory.....	6-15
 <i>Appendix - GPIO</i>	
A.1 GPIO Port.....	A-2



# 1

# Introduction

This Manual applies to the M-Series projector. Read this manual in its entirety and understand all warnings and precautions before attempting to operate the projector.

- *1.1 Using this Manual*
- *1.2 Purchase Record and Service Contacts*
- *1.3 Projector Overview*
- *1.4 Other Components*

**Disclaimer:** *Every effort has been made to ensure the information in this document is accurate and reliable. However, the information in this document is subject to change without notice. Christie Digital Systems assumes no responsibility for omissions or inaccuracies. Updates to this document are published, as required.*

## 1.1 USING THIS MANUAL

**USERS/OPERATORS:** This manual is intended for trained users operating professional high-brightness projection systems. Such users may also be trained to replace the lamp and air filter, but cannot install the projector or perform any service functions on the M-Series projector.

**SERVICE:** Only trained and qualified Christie service technicians knowledgeable about all potential hazards associated with high voltage, ultraviolet exposure and high temperatures generated by the lamp and associated circuits are authorized to **1)** assemble/install the projector and **2)** perform service functions inside the projector.

### 1.1.1 Labels and Markings

Observe and follow all warnings and instructions marked on the projector.

 The exclamation point within the equilateral triangle indicates a warning and refers to related operating/maintenance instructions in the User Manual.

 The lightning flash and arrowhead symbol within the equilateral triangle indicates non-insulated “dangerous voltage” within the projector’s enclosure that may be of sufficient magnitude to constitute a risk of electric shock.

### 1.1.2 Typographical Notations

The following notations are used throughout this manual:

- Keypad commands and PC keystrokes appear in bold small caps, such as *POWER*, *INPUT*, *ENTER* etc.
- References to specific areas of the document appear italicized and underlined. When viewed online the text appears in blue indicating a direct link to that section.  
For example, [6 Specifications](#).
- References to other documents appear italicized and bold, such as ***Christie User Manual***.
- References to software menus and available options appear bold, such as **Main Menu**, **Preferences**.
- User input or messages that appear on screen, in status display units or other control modules appear in Courier font.  
For example. “No Signal Present”, Login: christiedigital.
- Error codes, LED status appear in bold, e.g. **LP**, **A1** etc.
- Operational states of modules appear capitalized, such as “power ON, power OFF”.
- Signal words, such as **Warning**, **Caution** and **Notes** are used in this manual to point the reader to specific information or instructions that warn of safety related hazards which may be present and how to avoid them.

## 1.2 PURCHASE RECORD AND SERVICE CONTACTS

Whether the projector is under warranty or the warranty has expired, Christie’s highly trained and extensive factory and dealer service network is always available to quickly diagnose and correct projector malfunctions.

Should you encounter a problem with any part of the projector, contact your dealer. In most cases, servicing can be performed on site. If you have purchased the projector, fill out the information below and keep with your records.

**Table 1.1 Purchase Record**

<b>Dealer:</b>
<b>Dealer Phone Number:</b>
<b>Projector Serial Number*:</b>
<b>Purchase Date:</b>
<b>Installation Date:</b>

\* The serial number can be found on the rear of the projector.

**Table 1.2 Ethernet Settings**

<b>Default Gateway</b>	
<b>DNS Server</b>	
<b>Projector Address</b>	
<b>Projector Mgmt IP Address</b>	
<b>Subnet Mask</b>	

## 1.3 PROJECTOR OVERVIEW

The M-Series is a family of high resolution video/graphics 3 chip HD and SXGA+ projectors, see [Table 1.3 M-Series Projectors](#). These projectors are based on next-generation DLP® technology provided by Texas Instruments.



FIGURE 1-1 - M-SERIES

### 1.3.1 Main Features

- Up to 10,000 lumens
- HD (1080p) or SXGA+ resolution
- Dual Mercury lamp illumination with 200W or 350W options
- Dynamic iris contrast aperture providing up to 10,000:1 contrast ratio
- Ultra-compact design and weight less than 55lbs
- 10-bit image processor electronics with modular design
- Fully sealed optical system
- Active fan control for minimum noise level
- Selectable, motorized yellow notch filter for expanded color gamut
- User interchangeable projection lenses with no-tool mounting

- PIP and seamless switching
- LiteLOC™ for constant brightness maintenance
- Intelligent Lens System (ILS)
- Motorized lens mount for all models
- Auto-setup feature
- Integrated ChristieNET
- Networking ability through RS232 and RS422 connectors
- Status LED display on built-in keypad for easy projector status monitoring
- Control with remote keypad, wired remote, or built-in keypad
- Four input slots for Optional Input Modules

Refer to [6 Specifications](#) for a complete list of technical specifications.

Table 1.3 M-Series Projectors

Model Name	Part Number
DS+6K-M	118-013105-XX
DS+10K-M	118-014106-XX
HD6K-M	118-021104-XX
HD10K-M	118-023106-XX
Roadster HD10K-M	118-042107-XX
Roadster S+10K-M	118-044109-XX

### 1.3.2 How the Projector Works

The projector accepts data/graphics and video input signals for projection onto front or rear screens. Light is generated by dual mercury lamps, then modulated by three Digital Micro-mirror Device (DMD) panels that provide digitized red, green or blue color information. Light from the "ON" pixels of each panel is reflected, converged and then projected to the screen through a single front lens, where all pixels are perfectly superimposed as a sharp full-color image.

## 1.4 OTHER COMPONENTS

The items listed below are shipped with the projector. Ensure you have received these items before using the projector.

- IR remote keypad (includes two, 1.5V AA batteries and an XLR to mini-stereo cable for conversion to wired)
- Line cord
- Warranty Card
- Lens Mount Security Screw (M6x10mm long, Qty. 2)
- Lens Mount Security Screw (5mm Hex, Qty. 1)

## 2

# *Installation and Setup*

This section explains how to install, and setup the projector for delivery of superior image quality.

- *2.1 Projector Quick Setup and Installation*
- *2.2 Detailed Setup and Installation*
- *2.3 Connecting Sources*

## 2.1 PROJECTOR QUICK SETUP AND INSTALLATION

The following instructions are for those preferring a quick setup. Refer to the remaining subsections for detailed setup instructions.



**DANGER**

*Always power down the projector and disconnect all power sources before servicing or cleaning.*



**WARNING**

*Refer to Safety Warnings and Guidelines in Section 4.*

### STEP 1 - INSTALLING A PROJECTION LENS

The projection lens, shipped separately from the projector, must be installed prior to setting up the projector.

 **Remove the lens plug** from the lens opening in the projector before installing the lens. Retain the lens plug for projector transportation to protect the projector’s optical components from dust and debris.

*IMPORTANT! The lens seals the projector, preventing contaminants from entering the interior of the projector. Never operate a projector without a lens.*

### LENS INSTALLATION

1. Remove the small lens cap from the lens. Keep the large lens cap on the lens to protect it during installation.
2. Rotate the lens clamp to the OPEN position, see [Figure 2-1 - Lens Installation](#).
3. Remove and retain the 2 security screws from the lens mount, see [Figure 2-2 - Security Screw Location](#).
4. Align the lens interface plate with the lens mount. Align the lens electrical connector with the mating connector on the lens mount. Fully insert the assembly straight into the lens mount opening without turning. Press using your hand, see [Figure 2-3 - Lens Placement](#).
5. While holding the lens flat against the lens mount, rotate the lens clamp clockwise to lock the lens assembly in place.
6. For added stability such as motion applications, fasten the security screws, see [Figure 2-2 - Security Screw Location](#) provided on the lens-mount, using the tool provided. **NOTES: 1) Recommended for heaviest lenses such as 0.73:1 and 1.2:1. 2) Security screws MUST be installed when hoisting the projector overhead, or installing the projector in an overhead position.**
7. Remove the large lens cap.

**⚠ WARNING**

*Use of the lens security screws is required if the projector is hoisted or installed in an overhead position*

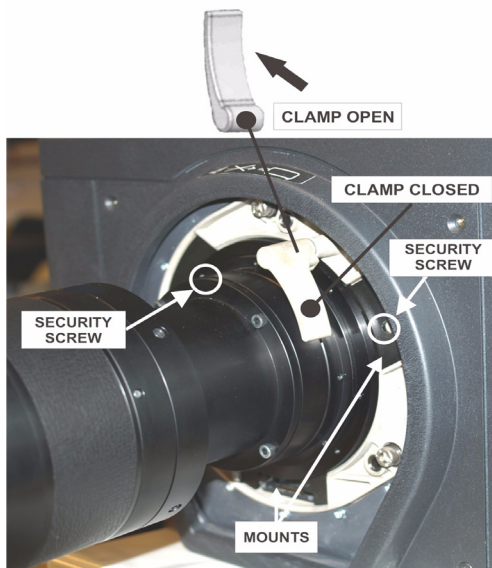

*FIGURE 2-1 - LENS INSTALLATION*

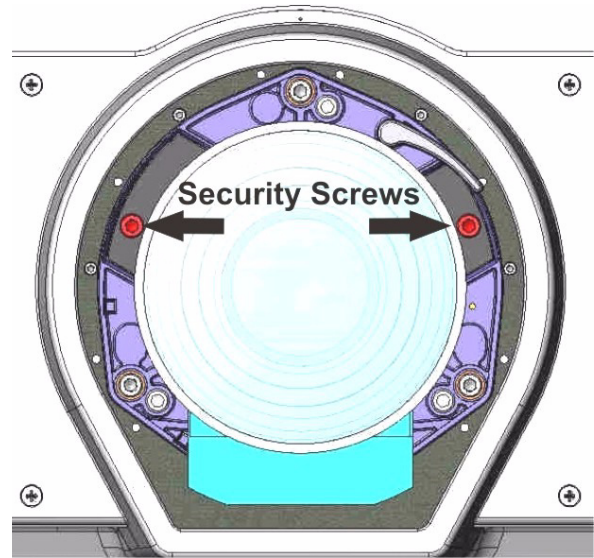

*FIGURE 2-2 - SECURITY SCREW LOCATION*



*FIGURE 2-3 - LENS PLACEMENT*

## STEP 2 - POSITIONING THE PROJECTOR



### WARNING

*2 people are required to safely lift and install the projector.*

Place the projector on a sturdy, level surface and position it so that it is perpendicular to the screen at a suitable distance. The further back the projector is positioned for the screen, the larger the image will be.

To level the projector adjust its 3 feet. With the projector positioned perpendicular to the screen the image will appear rectangular instead of keystone.

For more detailed instructions on positioning the projector refer to [2.2.3 Projector Position and Mounting](#) later in this section.

## STEP 3 - CONNECTING A SOURCE

Located at the back of the projector is the input panel where all source connections are made. Each input is clearly labeled for easy identification. Depending on the type of option card installed, connect your source using the appropriate cable(s), as follows:

- **Analog Input Card**, connect 3-, 4-, or 5-wire RGB source to Red/Pr, Green/Y, Blue/Pb, H/C and V using 3, 4 or 5 BNC connectors as required.
- **Dual SD/HD - SDI Input Card**, connect SDI (Serial Digital Interface) cable to one of the two inputs, 1-IN or 2-IN. Both standard-definition (SD) and high-definition (HD) signals are accepted and automatically recognized on either input.
- **Dual Link DVI Input Card**, connect a single or dual DVI video signal to the DVI-I connector, an analog video signal to the DVI-I connector or an analog video signal to the VGA connector. The DVI signal may contain HDCP (High-Bandwidth Digital Content Protection).
- **Twin HDMI Input Card**, connect HDMI (High-Definition Multimedia Interface) cable to one of the two inputs, 1-IN or 2-IN.
- **Video Decoder Input Card**, depending on the source you can apply the following;
  - Composite video source to 1-CVBS, using a BNC Cable *NOTE: Same signal can be used on 4, 5 or 6 when input is selected as CVBS.*
  - A component signal on Inputs 4(Pr), 5(Y), 6(Pb) using BNC Connectors. *NOTE: Grouped as a component input, YPbPr.*
  - S-Video to one of the two, 2-SVID or 3-SVID using S-Video cable.
  - S-Video using two BNC cables, with Luma (Y) connected to 4 (Sy) and Chroma (C) connected to 6 (Sc). *NOTE: Must be grouped as 1 S-Video + 1 CVBS.*

Refer to [2.3 Connecting Sources](#) for more details.



#### **STEP 4 - CONNECTING THE LINE CORD**

*IMPORTANT: Use the line cord provided with the projector, or ensure you are using a line cord, power plug and socket that meet the appropriate rating standards. NOTE: Listed on the license label.*

Connect the projector's line cord to the AC receptacle at the AC inlet of the projector, then push the wire clip over the plug to retain it. This prevents the line cord from inadvertent disconnection. Plug the 3-pronged plug end into a suitably rated grounded AC receptacle. Switch the projector ON. The switch is located just above the AC receptacle.

#### **WARNING**

*Do not attempt operation if the AC supply and cord is not within the specified ratings. On power down, wait 5-10 minutes for the fans to turn OFF before unplugging the projector. Always switch off the projector before unplugging the AC line cord.*

#### **STEP 5 - POWER UP**

After the AC Power has been switched on, the LCD display above the keypad indicates “Please wait” and the 4 LED status indicators on the top cover window switch on to amber. These indicate that the projector is changing its state from powered down to standby. The message “Standby Mode” appears in the display when the projector has completed its initialization and is ready for power up. The 2 lamp status LEDs will go off to indicate that the lamps are off. The Power status LED will show amber, indicating that the projector is in standby mode. The shutter LED will display amber, indicating the shutter is closed. Press and hold the power button on the keypad or remote for 2 seconds, or press twice quickly. The lamps will power on and the fans will come on. Note: See [Section 3 Operation](#) for a full description of the status indicators.

*NOTE: The default settings for the projector are to perform a lens calibration after the insertion of a new lens. If this is the first time the projector has been powered up with the lens, expect a short period (about 15 seconds) where the lens will move slightly.*

#### **STEP 6 - SELECTING A SOURCE**

Press one of the input keys on the remote or built-in keypad to select and display the image for the source you connected in Step 3.

#### **STEP 7- ADJUSTING IMAGE**

Adjust the image settings, such as Brightness, Contrast, Gamma, Focus, Zoom etc. using the direct keys on the remote or built in keypad. *NOTE: Refer to [Section 3 Operation](#) for more details.*

## 2.2 DETAILED SETUP AND INSTALLATION

**⚠ DANGER**

*Always power down the projector and disconnect all power sources before servicing or cleaning.*

**⚠ WARNING**

*Refer to Safety Warnings and Guidelines in Section 4.*

### 2.2.1 About the Projector

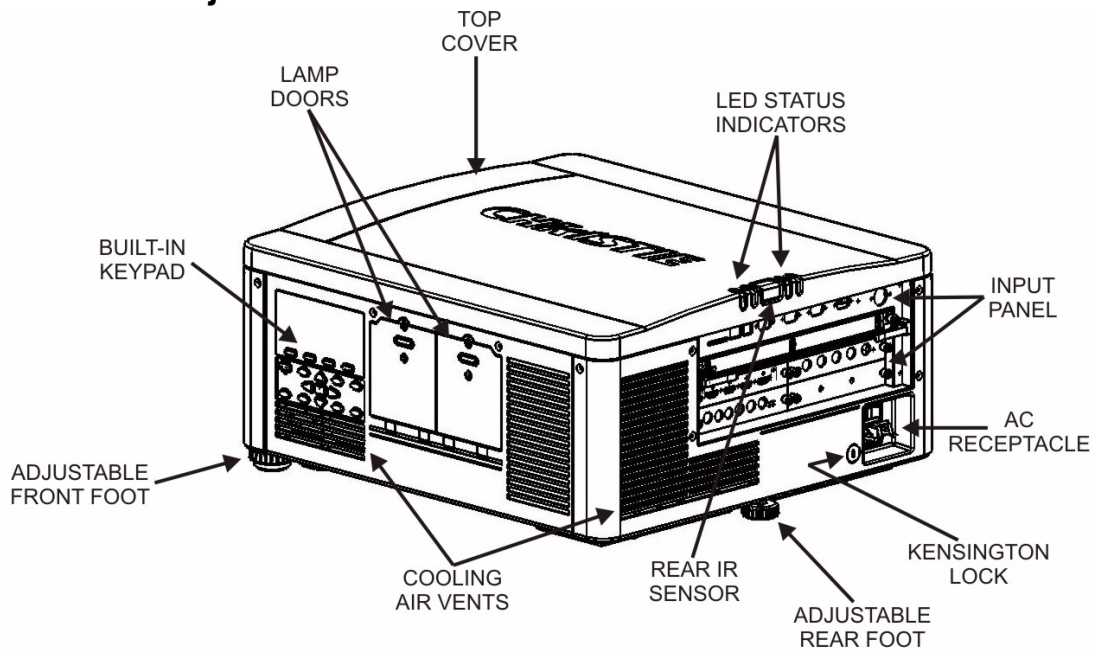

FIGURE 2-4 - ABOUT THE PROJECTOR - REAR/SIDE VIEW

#### **BUILT-IN KEYPAD**

The built-in keypad is located on the side of the projector. Use it similarly to the IR remote to control the projector. An LCD display is located above the keypad for displaying projector status.

#### **AC RECEPTACLE**

The AC receptacle is located at the back of the projector. Use this receptacle to plug in an appropriately rated line cord. *NOTE: The power switch is located above the AC receptacle. Refer to [Section 6 – Specifications for details](#).*

## ADJUSTABLE FEET

Located on the underside of the projector are three adjustable feet. Raise or lower these feet when positioning the projector to ensure it is level on all sides so the displayed image will appear rectangular without any keystone.

Refer to [2.2.5 Adjusting Projector Height/Tilt](#) for instructions on how to adjust the projector's feet.

## INPUT PANEL

All source connections are made to the input panel located at the back of the projector. Any of the available optional input cards can be installed in the 4 option card slots. The slots are labelled 1 through 4. All option cards have LEDs to indicate their status.

## COOLING AND AIR VENTS

There are numerous air vents located around the projector. It is important these vents remain unobstructed. Adequate airflow through the projector will prevent it from overheating.

## KENSINGTON LOCK ATTACHMENT

Located at the rear of the projector to the left of the AC receptacle, is a Kensington lock attachment point. This provides the ability to secure the projector against possible theft.

## LAMP DOOR

The lamp doors are located at the side of the projector, which provides easy access to the lamp module for replacement. Refer to Section [4.4 Replacing the Lamps](#). The lamp doors are fitted with safety interlocks which switch the lamp off when the door is opened. The lamp doors are provided with clear windows to indicate when the lamps are on.

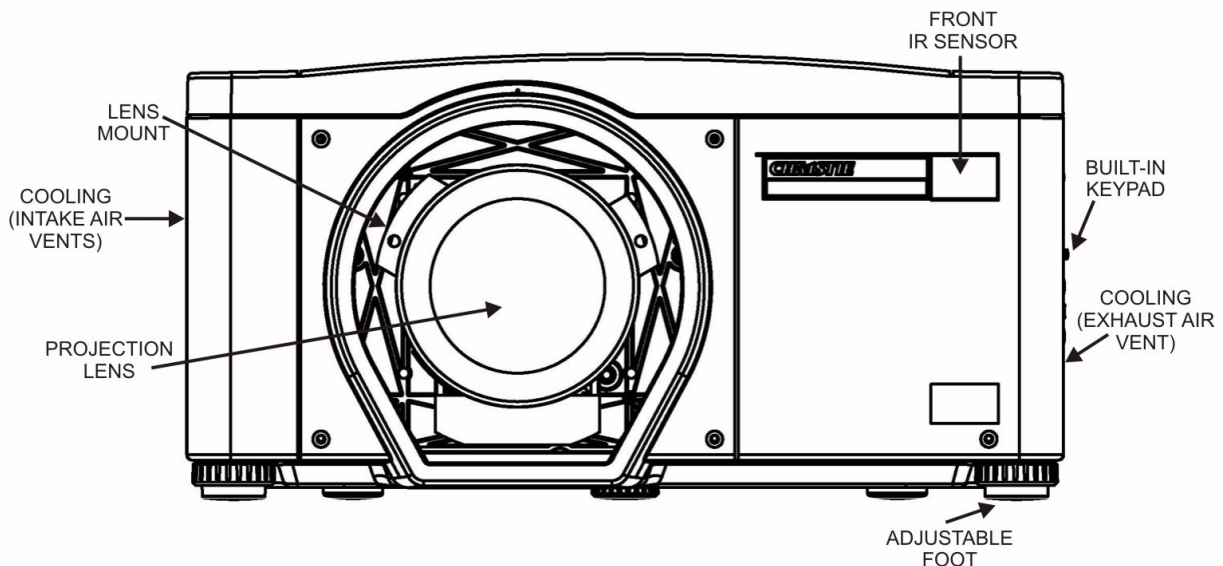

FIGURE 2-5 - ABOUT THE PROJECTOR - FRONT VIEW

**FRONT & REAR IR SENSORS**

The two IR sensors located on the projector receive transmissions from the IR remote from up to 100 feet away. It is important to keep the transmission path to these sensors unobstructed for uninterrupted communications with the projector. The rear IR sensor is located at the back of the projector between the status LEDs and the front IR sensor is located next to the projector’s front nameplate.

**PROJECTION LENSES, LENS MOUNT AND OTHER FEATURES**

The projector includes a motorized lens mount that allows automated lens control and adjustment: vertical and horizontal offsets, zoom and focus. The lens mount can be fitted with any one of the available optional lenses – see Section [6 Specifications](#).

- **Zoom and Focus** – There are two internal lens motors that allow for quick motorized adjustment of zoom and focus. Adjust zoom to fit the displayed image on the screen and adjust focus to improve the clarity of the image.

*NOTES: 1) The projection lens is shipped separately from the projector. 2) Use the lens cap when transporting the lens to avoid scratching and damaging the lens, which could affect your displayed image. 3) Motorized lenses should not be adjusted by hand without first setting them for manual operation, otherwise the zoom and focus motors may be damaged. (Set in **Menu ->Configuration->Lens Settings ->Manual Zoom/Focus**).*

- **Lens Offset** – The motorized lens mount allows vertical and horizontal offset of the displayed image.
- **Shutter** – Standard on all models, the shutter allows you to turn the screen absolutely black when in the “Closed” state.
- **Dynamic Iris Contrast Aperture** – Enables adjustment of light output and contrast ratio.

**2.2.2 Installation Considerations**

Proper installation of your projector will ensure the quality of your display. Whether you are installing a projector temporarily or permanently you should take the following into account to ensure your projector performs optimally. Choose the installation type that best suits your needs: front or rear screen, floor mount or inverted mount.

**FRONT SCREEN / FLOOR MOUNT INSTALLATIONS**

<i>Advantages</i>	<i>Considerations</i>
<ul style="list-style-type: none"> <li>• Easy to set up.</li> <li>• Can be moved or changed quickly.</li> <li>• Easy to access.</li> </ul>	<ul style="list-style-type: none"> <li>• Shares floor space with audience.</li> </ul>

**FRONT SCREEN / INVERTED MOUNT (CEILING) INSTALLATION**

<i>Advantages</i>	<i>Considerations</i>
<ul style="list-style-type: none"> <li>• Does not take up audience space.</li> <li>• Projector is unobtrusive.</li> <li>• Projector cannot be accidentally moved.</li> </ul>	<ul style="list-style-type: none"> <li>• Installation is more permanent.</li> <li>• It is more difficult to access the projector.</li> </ul>

**REAR SCREEN / FLOOR MOUNT INSTALLATION**

<i>Advantages</i>	<i>Considerations</i>
<ul style="list-style-type: none"> <li>• Projector is completely hidden.</li> <li>• Projector is easily accessed.</li> <li>• Usually good ambient light rejection.</li> </ul>	<ul style="list-style-type: none"> <li>• Requires separate room or enclosure.</li> <li>• Installation cost is usually higher.</li> </ul>

**REAR SCREEN / INVERTED MOUNT (CEILING) INSTALLATION**

<i>Advantages</i>	<i>Considerations</i>
<ul style="list-style-type: none"> <li>• Projector is completely hidden.</li> <li>• Usually good ambient light rejection.</li> </ul>	<ul style="list-style-type: none"> <li>• Requires separate room.</li> <li>• Installation cost is usually higher.</li> <li>• More difficult to access projector.</li> </ul>

**REAR SCREEN / FLOOR MOUNT WITH MIRROR**

<i>Advantages</i>	<i>Considerations</i>
<ul style="list-style-type: none"> <li>• Projector is completely hidden</li> <li>• Usually good ambient light rejection.</li> <li>• Requires less space behind screen than other rear screen installations.</li> </ul>	<ul style="list-style-type: none"> <li>• Requires separate room or enclosure.</li> <li>• Installation cost is usually higher.</li> <li>• More involved to perform setup.</li> </ul>

**FRONT SCREEN INSTALLATIONS**

In front screen installations, the projector and audience are positioned in front of the screen, which can be flat or curved.

Flat screens offer a gain of about 1.0 with a viewing angle just less than 180°. This type of screen reflects incident light equally in all directions so the audience can see the display from various angles.

Curved screens have a gain greater than 1.0 with a viewing angle much less than 180°. This type of screen does not reflect incident light equally in all directions; instead it is concentrated in a viewing cone. The audience sitting within the viewing cone area will see a brighter image than those sitting just outside the area.

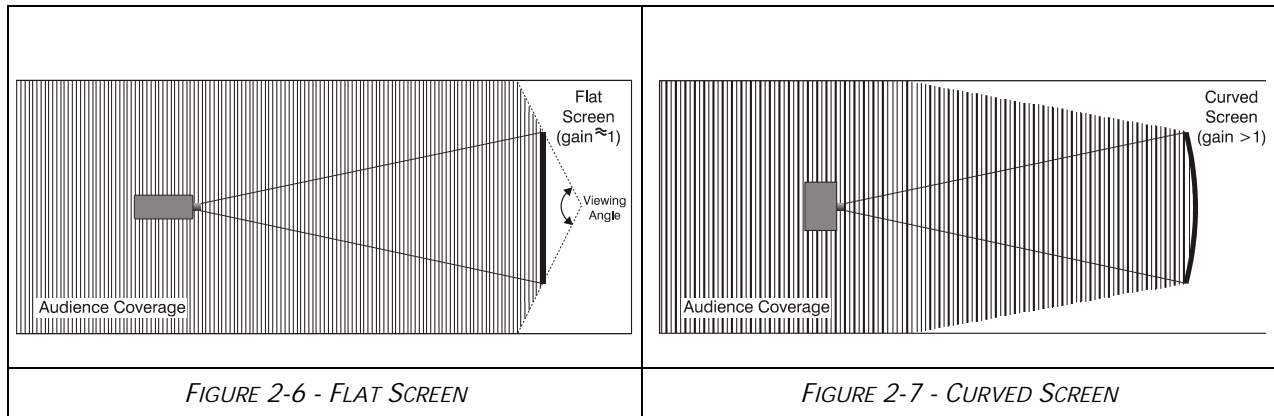

**REAR SCREEN INSTALLATIONS**

There are two basic types of rear screens: diffused and optical.

A diffused screen has a surface which spreads the light striking it. Purely diffused screens have a gain of less than 1.0. The advantage of the diffused screen is its wide viewing angle, similar to that of a flat screen for front screen projection. This type of screen is suitable when a wide viewing angle is required but there is low ambient room lightening.

Optical screens take light from the projector and redirect it to increase the light intensity at the front of the screen. This reduces it in other areas. A viewing cone, similar to that of a curved front screen installation is created. This type of screen is better suited for brightly lit rooms where the audience is situated within the viewing cone.

**SCREEN SIZE**

Choose a screen size appropriate for your lens and application. If the projector will be used to display text information, the image size must allow the audience to recognize all text clearly. The eye sees a letter clearly if eye-to-text distance is less than 150 times the height of the letter. Small text located too far from the eye will be illegible at a distance no matter how sharply and clearly it is displayed.

To fill a screen with an image, the aspect ratio of the screen should be equal to the aspect ratio of the image (expressed as the ratio of its width to its height). Standard video from a VCR has a 4:3 or 1.33:1 aspect ratio. For example, to display a VCR output with a 4:3 aspect ratio onto a 10-foot (3m) high screen, the width of the screen must be at least 13.3 feet (4m).

**AMBIENT LIGHTING**

The high brightness of this projector is well suited for locations where ambient lighting might be considered less than ideal. A typical room with ceiling lights and windows rarely requires special attention. Contrast ratio in your images will be reduced if stray light directly strikes the screen. For example, when a shaft of light from a window or floodlight falls on the image. Images may appear washed out and less vibrant. Avoid or eliminate stray light sources directed at the screen.

**VENTILATION**

The projector vents and louvers provide ventilation, both for intake and exhaust. Never block or cover these openings. Do not install the projector near a radiator or heat register, or within an enclosure. To ensure adequate airflow around the projector, allow free air exchange to the projector with a minimum clearance of 25cm (10”) on the left, right and rear sides of the projector from any walls or other obstructions. *NOTE: Do not obstruct the air exchange to the projector.*

**OTHER CONSIDERATIONS**

Other considerations and tips to improve your installation:

- Keep the ambient temperature constant and below 40°C (104F). Keep the projector away from heating and/or air conditioning vents. Changes in temperature may cause drifts in the projector circuitry, which may affect performance.
- Keep the projector away from devices that radiate electromagnetic energy, such as motors and transformers, slide projectors, speakers, power amplifiers, elevators, etc.
- Use a screen size appropriate for the venue but not larger than required. Installing a large screen in a small room is similar to watching television at a close range; too large a screen can overpower a room and interfere with the overall effect. As a rule, be no closer than 1.5 times the width of the screen.

**2.2.3 Projector Position and Mounting**

**THROW DISTANCE**

Throw distance is the distance measured from your projector’s front feet to the screen. This calculation determines if there is enough room to install your projector with a desired screen size and if the image will be of the right size for your screen.

To estimate the throw distance take the horizontal width of the screen and multiply it by the lens throw ratio. The result determines approximately the distance the projector should be positioned from the screen to project a focused image large enough to fill the screen. For example, using a 0.73:1 lens, throw distance would roughly be 0.73 x screen width.

*IMPORTANT: Use the lens and screen size to calculate the precise throw distance using the tables provided in the **Dealer Section of the Christie Website, PN 020-100221-XX**. Due to lens manufacturing tolerances for lens focal length, actual throw distance can vary ±5% between lenses with the same nominal throw ratio.*

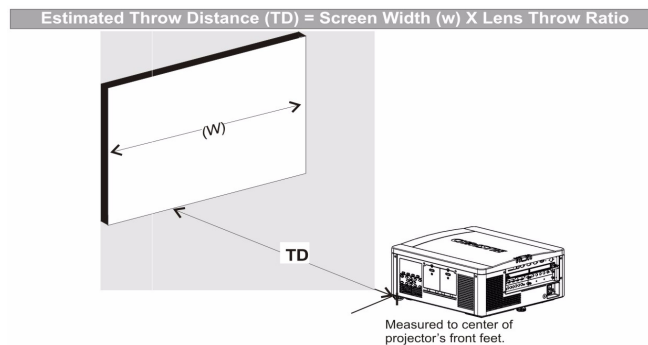

FIGURE 2-8 - THROW DISTANCE

**VERTICAL AND HORIZONTAL POSITION**

The correct vertical and horizontal position of the projector in relation to the screen depends on the lens type and the screen size. Ideally, the projector should be positioned perpendicular to the screen. This way, the image will appear rectangular instead of keystone (trapezoidal).

The vertical position of the image can be offset (that is moved above or below the optical axis) by adjusting the motorized lens mount. The amount of vertical offset available depends on the type of lens installed in the projector and can be limited if horizontal offset has been applied. Vertical offset can be expressed as the percent of half the image height or the number of pixels of shift from lens center. Refer to [Figure 2-9 - Vertical Offset Examples](#) for illustrated examples of vertical offset.

[Table 2.1](#) and [Table 2.2](#) specify the vertical offset of each type of lens.

*Table 2.1 - Lens Type and Vertical Offsets, HD 1080p (1920 x 1080 pixels)*

Lens Throw Ratio	Fixed	Zoom	Lens Part Number	Minimum Offset Above or Below Lens Center	
CHRISTIE ILS LENS 0.73:1 SX+ / 0.67:1 HD 0.95" 3-CHIP DLP®	X		118-100110-XX	±35%	±189 pixels
CHRISTIE ILS LENS 1.2:1 SX+ / 1.1:1 HD 0.95" 3-CHIP DLP®	X		118-100117-XX	±119%	±643 pixels
CHRISTIE ILS LENS 1.2:1 SX+ / 1.1:1 HD SFL 0.95" 3-CHIP DLP®	X		118-101103-XX	±119%	±643 pixels
CHRISTIE ILS LENS 1.25-1.6:1 SX+ / 1.16-1.49:1 HD 0.95" 3-CHIP DLP®		X	118-100111-XX	±102%	±551 pixels
CHRISTIE ILS LENS 1.5-2.0:1 SX+ / 1.4-1.8:1 HD 0.95" 3-CHIP DLP®		X	118-100112-XX	±119%	±643 pixels
CHRISTIE ILS LENS 2.0-2.8:1 SX+ / 1.8-2.6:1 HD 0.95" 3-CHIP DLP®		X	118-100113-XX	±119%	±643 pixels
CHRISTIE ILS LENS 2.8-4.5:1 SX+ / 2.6-4.1:1 HD 0.95" 3-CHIP DLP®		X	118-100114-XX	±119%	±643 pixels
CHRISTIE ILS LENS 4.5-7.5:1 SX+ / 4.1-6.9:1 HD 0.95" 3-CHIP DLP®		X	118-100115-XX	±119%	±643 pixels
CHRISTIE ILS LENS 7.5-11.2:1 SX+ / 6.9-10.4:1 HD 0.95" 3-CHIP DLP®		X	118-100116-XX	±119%	±643 pixels

*NOTES: 1) Offsets are subject to ±7% centering tolerance. 2) % Offset = # of pixels of offset/half vertical panel resolution x 100.*



Table 2.2 - Lens Type and Vertical Offsets, SXGA+ (1400 x 1050 pixels)

Lens Throw Ratio	Fixed	Zoom	Lens Part Number	Minimum Offset Above or Below Lens Center	
CHRISTIE ILS LENS 0.73:1 SX+ / 0.67:1 HD 0.95" 3-CHIP DLP®	X		118-100110-XX	±23%	±121 pixels
CHRISTIE ILS LENS 1.2:1 SX+ / 1.1:1 HD 0.95" 3-CHIP DLP®	X		118-100117-XX	±100%	±525 pixels
CHRISTIE ILS LENS 1.2:1 SX+ / 1.1:1 HD SFL 0.95" 3-CHIP DLP®	X		118-101103-XX	±100%	±525 pixels
CHRISTIE ILS LENS 1.25-1.6:1 SX+ / 1.16-1.49:1 HD 0.95" 3-CHIP DLP®		X	118-100111-XX	±73%	±383 pixels
CHRISTIE ILS LENS 1.5-2.0:1 SX+ / 1.4-1.8:1 HD 0.95" 3-CHIP DLP®		X	118-100112-XX	±100%	±525 pixels
CHRISTIE ILS LENS 2.0-2.8:1 SX+ / 1.8-2.6:1 HD 0.95" 3-CHIP DLP®		X	118-100113-XX	±100%	±525 pixels
CHRISTIE ILS LENS 2.8-4.5:1 SX+ / 2.6-4.1:1 HD 0.95" 3-CHIP DLP®		X	118-100114-XX	±100%	±525 pixels
CHRISTIE ILS LENS 4.5-7.5:1 SX+ / 4.1-6.9:1 HD 0.95" 3-CHIP DLP®		X	118-100115-XX	±100%	±525 pixels
CHRISTIE ILS LENS 7.5-11.2:1 SX+ / 6.9-10.4:1 HD 0.95" 3-CHIP DLP®		X	118-100116-XX	±100%	±525 pixels

NOTES: 1) Offsets are subject to ±7% centering tolerance. 2) % Offset = # of pixels of offset/half vertical panel resolution x 100.

**Examples of Vertical Offset (SXGA+ pixels represented)**

Where:

Shaded area = projected image

Area within solid line = projected image area with no offset applied

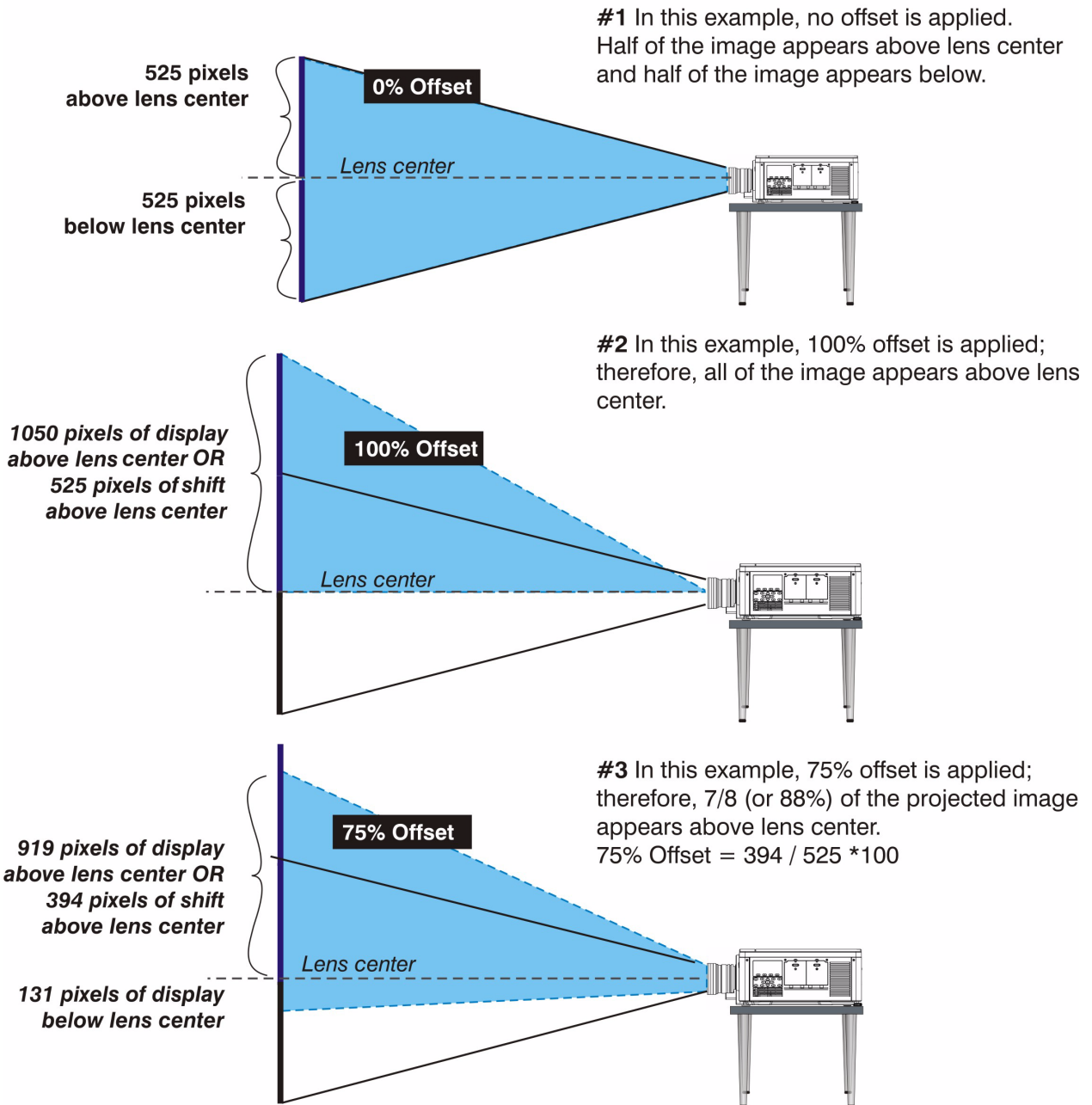

FIGURE 2-9 - VERTICAL OFFSET EXAMPLES

The horizontal position of the image can also be offset; that is moved to the left or right of optical center, by adjusting the motorized lens mount. The amount of horizontal offset available depends on the lens installed and if the image has already been vertically offset. Horizontal offset can be expressed as the percent of half the image width or the number of pixels of shift to one side of lens center. [Table 2.3](#) and [Table 2.4](#), each show the horizontal offset of a lens type. Refer to [Figure 2-10 - Horizontal Offset Examples](#).

*Table 2.3 - Lens Type and Horizontal Offsets, HD 1080p (1920 x 1080 pixels)*

Lens Throw Ratio	Fixed	Zoom	Lens Part Number	Minimum Offset Left or Right of Lens Center	
CHRISTIE ILS LENS 0.73:1 SX+ / 0.67:1 HD 0.95" 3-CHIP DLP®	X		118-100110-XX	±12%	±115 pixels
CHRISTIE ILS LENS 1.2:1 SX+ / 1.1:1 HD 0.95" 3-CHIP DLP®	X		118-100117-XX	±42%	±403 pixels
CHRISTIE ILS LENS 1.2:1 SX+ / 1.1:1 HD SFL 0.95" 3-CHIP DLP®	X		118-101103-XX	±42%	±403 pixels
CHRISTIE ILS LENS 1.25-1.6:1 SX+ / 1.16-1.49:1 HD 0.95" 3-CHIP DLP®	X		118-100111-XX	±40%	±384 pixels
CHRISTIE ILS LENS 1.5-2.0:1 SX+ / 1.4-1.8:1 HD 0.95" 3-CHIP DLP®		X	118-100112-XX	±42%	±403 pixels
CHRISTIE ILS LENS 2.0-2.8:1 SX+ / 1.8-2.6:1 HD 0.95" 3-CHIP DLP®		X	118-100113-XX	±42%	±403 pixels
CHRISTIE ILS LENS 2.8-4.5:1 SX+ / 2.6-4.1:1 HD 0.95" 3-CHIP DLP®		X	118-100114-XX	±42%	±403 pixels
CHRISTIE ILS LENS 4.5-7.5:1 SX+ / 4.1-6.9:1 HD 0.95" 3-CHIP DLP®		X	118-100115-XX	±42%	±403 pixels
CHRISTIE ILS LENS 7.5-11.2:1 SX+ / 6.9-10.4:1 HD 0.95" 3-CHIP DLP®		X	118-100116-XX	±42%	±403 pixels

*NOTES: 1) Offsets are subject to ±7% centering tolerance. 2)% Offset = # of pixels of offset/half horizontal panel resolution x 100.*

*Table 2.4 - Lens Type and Horizontal Offsets, SXGA+ (1400 x 1050 pixels)*

Lens Throw Ratio	Fixed	Zoom	Lens Part Number	Minimum Offset Left or Right of Lens Center	
CHRISTIE ILS LENS 0.73:1 SX+ / 0.67:1 HD 0.95" 3-CHIP DLP®	X		118-100110-XX	±13%	±91 pixels
CHRISTIE ILS LENS 1.2:1 SX+ / 1.1:1 HD 0.95" 3-CHIP DLP®	X		118-100117-XX	±50%	±350 pixels
CHRISTIE ILS LENS 1.2:1 SX+ / 1.1:1 HD SFL 0.95" 3-CHIP DLP®	X		118-101103-XX	±50%	±350 pixels

CHRISTIE ILS LENS 1.25-1.6:1 SX+ / 1.16-1.49:1 HD 0.95" 3-CHIP DLP®		X	118-100111-XX	±45%	±315 pixels
CHRISTIE ILS LENS 1.5-2.0:1 SX+ / 1.4-1.8:1 HD 0.95" 3-CHIP DLP®		X	118-100112-XX	±50%	±350 pixels
CHRISTIE ILS LENS 2.0-2.8:1 SX+ / 1.8-2.6:1 HD 0.95" 3-CHIP DLP®		X	118-100113-XX	±50%	±350 pixels
CHRISTIE ILS LENS 2.8-4.5:1 SX+ / 2.6-4.1:1 HD 0.95" 3-CHIP DLP®		X	118-100114-XX	±50%	±350 pixels
CHRISTIE ILS LENS 4.5-7.5:1 SX+ / 4.1-6.9:1 HD 0.95" 3-CHIP DLP®		X	118-100115-XX	±50%	±350 pixels
CHRISTIE ILS LENS 7.5-11.2:1 SX+ / 6.9-10.4:1 HD 0.95" 3-CHIP DLP®		X	118-100116-XX	±50%	±350 pixels

NOTES: 1) Offsets are subject to ±7% centering tolerance. 2) % Offset = # of pixels of offset/half horizontal panel resolution x 100.

**Examples of Horizontal Offset (SXGA+ pixels represented)** Where:  
 Shaded area = projected image  
 Area within solid line = projected image area with no offset applied

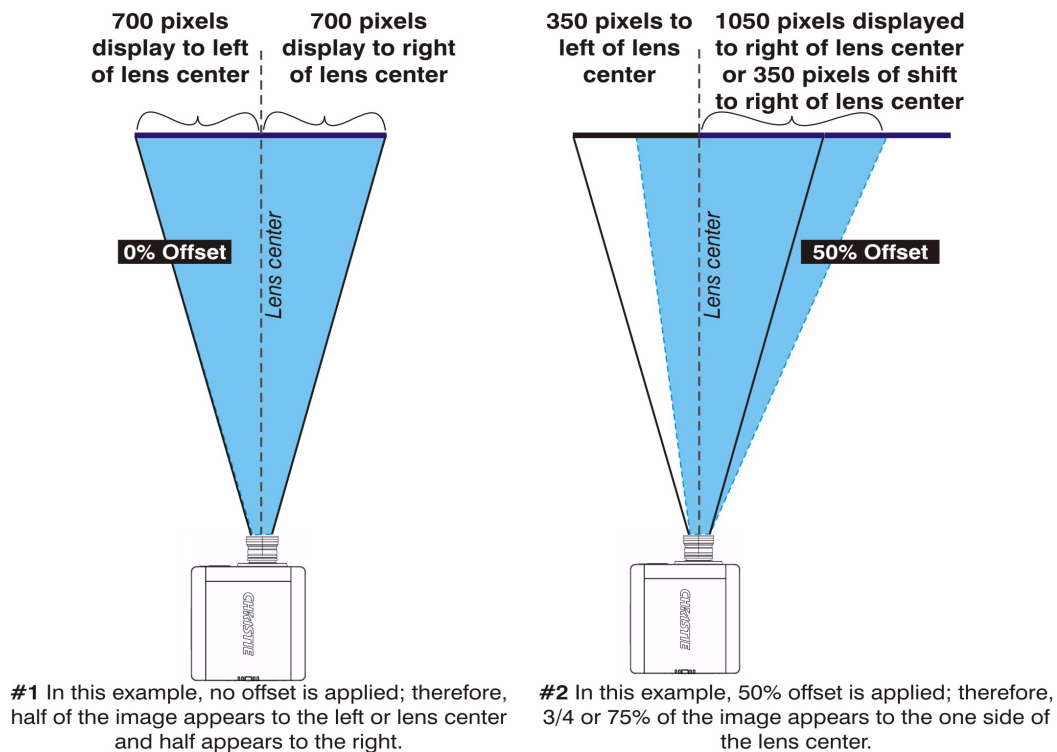



FIGURE 2-10 - HORIZONTAL OFFSET EXAMPLES

## 2.2.4 Mounting

There are several methods for mounting the projector. In typical front and rear screen installations the projector can be mounted to a secure and level surface, such as a table or cart. Carts are useful when the projector has to be moved often. Lock the wheels on a cart, when it is in position, to prevent accidental movement during a presentation.

### CEILING MOUNT

The projector can be inverted and suspended from the ceiling using a specially designed ceiling mount fixture 118-100108-XX. This mounting is recommended for those that want the projector out of plain view or have limited amount of space for the projector. For more information, contact your dealer.

 Use only the CHRISTIE approved ceiling mount kit designed for your projector. Refer to the installation instructions and safety guidelines provided in the kit.

### SPECIAL MOUNTING

The projector can also be rotated (front-to-back) up to 360 degrees and fixed in a rotated position without affecting performance. However, the side-to-side tilt limit of the projector must not exceed +/- 15 degrees, to ensure optimal performance of the projector.

## 2.2.5 Adjusting Projector Height/Tilt

### ADJUSTING HEIGHT

You can modify the height of the projector to remedy a slightly uneven mounting surface by adjusting the three feet threaded into the bottom chassis. Turn each foot clock-wise or counter-clockwise until the projector is level on all sides.

The front feet are adjusted by turning the collar, see [Figure 2-11 - Front Foot](#). The front feet do not rotate when adjusted. The rear foot is adjusted by turning the entire foot, see [Figure 2-12 - Rear Foot](#).

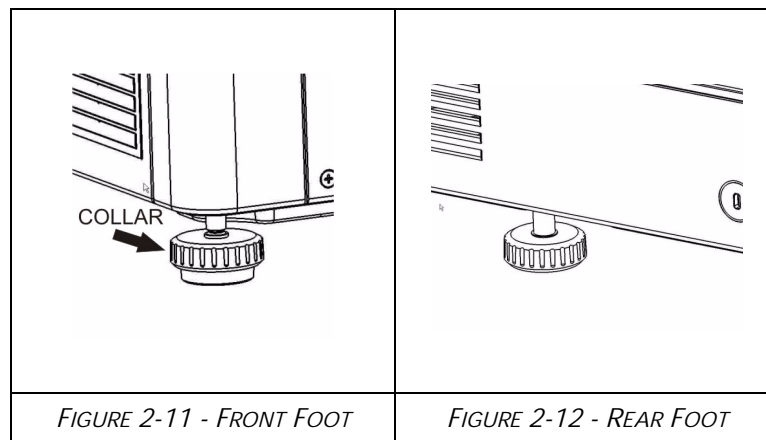

## ADJUSTING TILT

1. Before adjusting tilt, ensure the projector is centered. *NOTE: Check with site personnel for the degree of screen tilt, or measure this incline with a protractor at the screen.*
2. Then tilt the projector to closely match the screen tilt angle by extending or retracting the projector's 3 adjustable feet.

*NOTE: 1) For an ideal installation, the lens surface should be centered and parallel to the screen - this orientation helps to ensure optimized lens performance with minimal offset. Choose a sturdy mounting surface that allows for this. If this position is not possible (such as when the projector is significantly higher than the center of the screen), it is better to rely on offset rather than extra tilt.*

### 2.2.6 Basic Optical Alignment

Only perform image alignment once the projector is fully assembled and powered up in its final location. Basic image alignment ensures the image reflected from the DMDs is parallel to and well-centered with the lens and screen. This initial optical alignment is the foundation for optimizing images on the screen and must be completed before final boresight adjustments. Before beginning ensure the projector is properly positioned relative to the screen.

## BASIC OPTICAL ALIGNMENT PROCEDURE

1. **Display a test pattern:** Appropriate for analyzing image focus and geometry, such as the “framing” test pattern showing the cross-hair centered across the image. Press the  (Test) key on the remote keypad or use the built-in keypad and press the soft key that displays Test on the LCD display.
2. **Course focus:** Do a quick preliminary focus and (if available) zoom adjustment with the primary lens. Do not worry about consistency across the image at this point, just center focus. It is good practice to have zoom adjustment color and focus adjustment color in the center of its range.
3. **Center the image in the lens:** Holding a piece of paper at the lens surface, adjust offsets as necessary until the image is centered within the lens perimeter. A full white field works best for this.
4. **If necessary, center the image on the screen:** If the projector is mounted off center to the screen axis, then offset the lens as much as required. Aim the projector over slightly towards the center of the screen, but use caution when doing so, as too much tilt will cause excessive keystone distortion. Lens offset will not.
5. **Re-check side-to-side leveling:** With the framing pattern on screen, double-check projector leveling so the top edge of the image is parallel to the top edge of the screen.
6. **Throw Distance:** Ensure the projector is positioned in the throw distance range for the particular lens.

## FOLDED OPTICS

In rear screen applications where space behind the projector is limited, a mirror may be used to fold the optical path. The position of the projector and mirror must be accurately set - if considering this type of installation call your dealer for assistance.

## 2.2.7 Advanced Optical Alignment

### BORESIGHT ALIGNMENT PROCEDURE

1. Display the Boresight Test Pattern by pressing the  (Test) key on the remote keypad or use the built-in keypad and press the soft key that displays Test on the LCD display, then  to cycle to Boresight, then Enter, see [Figure 2-13 - Boresight Pattern](#)

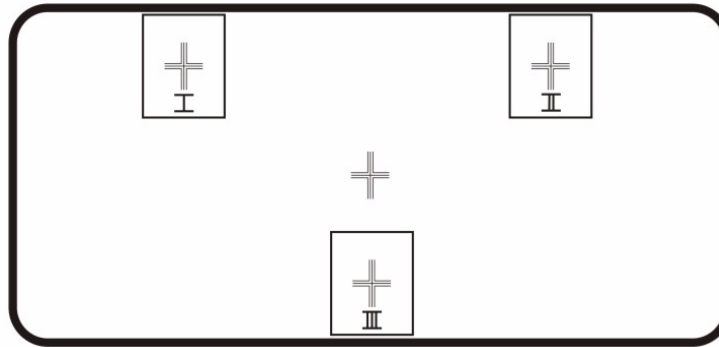
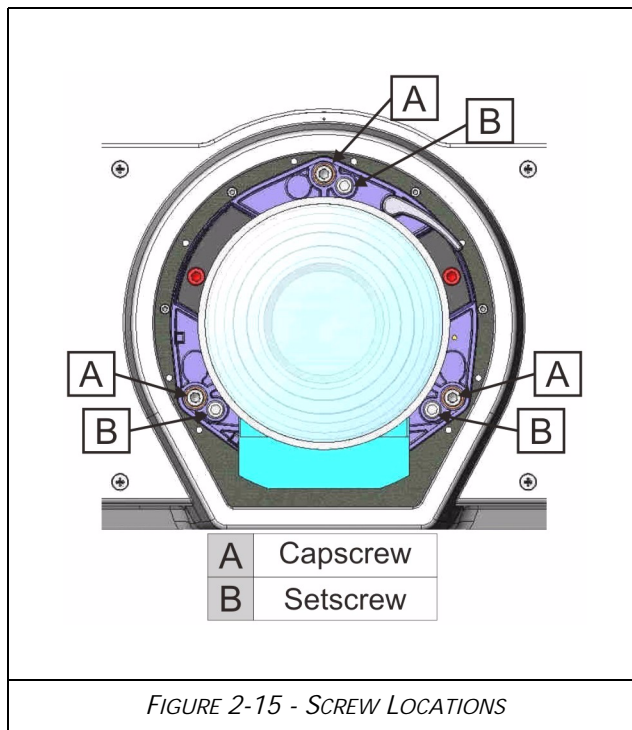
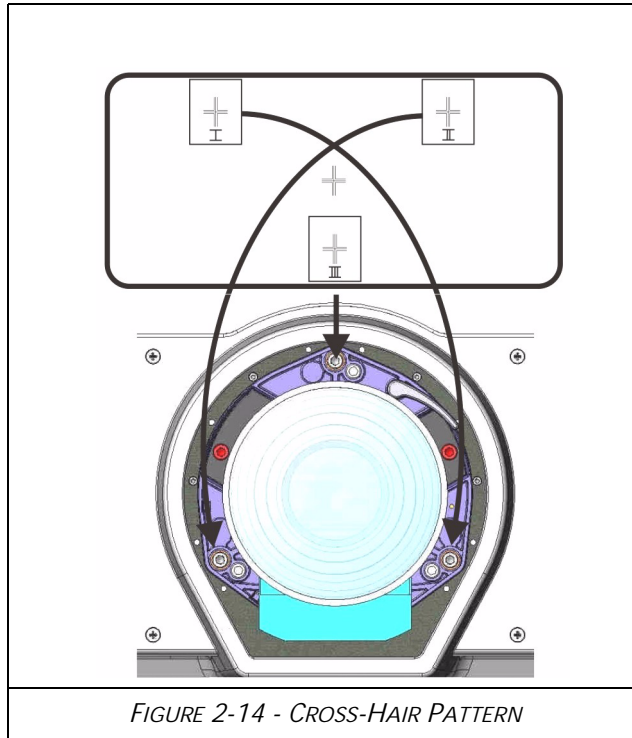

FIGURE 2-13 - BORESIGHT PATTERN

2. Focus the image on cross-hair pattern I. Evaluate the focus on cross-hair image II and III. If all 3 images are in focus, no further action is required. If boresight is required see step 3.
3. If boresight is required, refer to [Figure 2-14 - Cross-Hair Pattern](#) to understand how the adjustment screws on the lens mount affect the corresponding cross-hairs on the test pattern.
4. Use a 5mm Allen™ key to loosen the 3 locking setscrews on the lens mount, see [Figure 2-15 - Screw Locations](#), below. *NOTE: The setscrews must be backed out several turns, so that they do not contact the inner lens mount plate.*





5. Fine tune the focus of cross-hair pattern I by adjusting the appropriate capscrew, see [Figure 2-15 - Screw Locations](#). Adjust until the cross-hair image is in focus with minimal flare.
6. Adjust cross-hair pattern II, by adjusting the appropriate capscrew, see [Figure 2-15 - Screw Locations](#). Adjust until the cross-hair image is in focus with minimal flare.
7. Adjust cross-hair pattern III, by adjusting the appropriate capscrew, see [Figure 2-15 - Screw Locations](#). Adjust until the cross-hair image is in focus with minimal flare.
8. Repeat step 5, 6, and 7 as required until all 3 cross-hair patterns are in equal sharp focus. If the boresight is acceptable, see step 11. If the boresight does not appear to be converging to an acceptable level of image quality or if the lens will not focus over the correct range of throw distances, then the boresight requires coarse adjustment, see step 9.
9. The original factory boresight can be recovered approximately by positioning the 3 setscrews, see [Figure 2-15 - Screw Locations](#). Position the setscrews flush with the front face of the lens mount plate and in contact with the inner lens mount plate, see below [Figure 2-16 - Position Setscrew Flush](#). This may require adjusting both setscrews and capscrews.

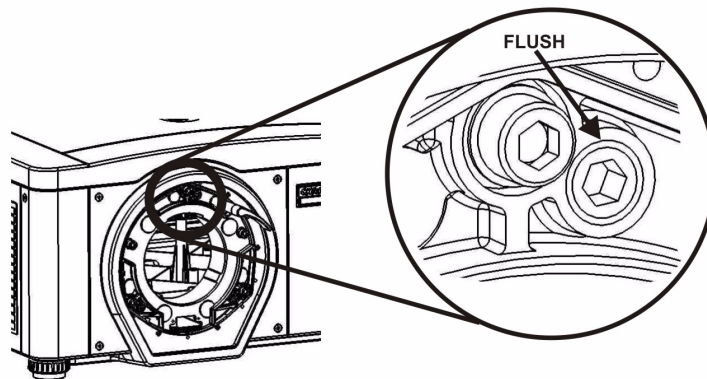



FIGURE 2-16 - POSITION SETSCREW FLUSH



10. If further action is required. Repeat #2.
11. Lock the setscrews, and re-check the boresight quality. Tighten the setscrew enough to ensure they will not shift.

### 2.2.8 Powering Down

The projector can be powered down by using one of the following methods:

#### REMOTE KEYPAD/BUILT-IN KEYPAD

1. Press and hold .
2. Press  twice, quickly to toggle the projector off with a single keystroke.

- Press  once, a Confirmation window will appear, press  again to power down. *NOTE: Once the Confirmation window is displayed the second press of the  must be within 1 second to power down.*

*NOTE: After powering down, the Status LEDs cycle and the LCD displays the message “Cooling Down”, until cool down is complete.*

WEB USER INTERFACE (UI)

- From the **Main** Tab, Select **Power: On**.  
*NOTE: A window will display for confirmation on powering down, see [Figure 2-17](#).*
- Select **Yes**.

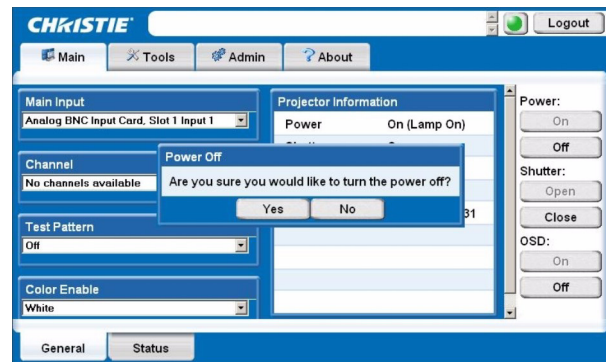

FIGURE 2-17 - POWERING DOWN/WEB USER INTERFACE

2.2.9 Connecting Communications

REMOTE KEYPADS

To control the projector, direct the projector’s IR remote towards the display screen or the projector’s IR sensors. Alternatively, connect a wired (tethered) version of the remote to the XLR connector labeled as **WIRED KEYPAD** on the projector’s input panel. Note that response to a wired keypad must also be enabled in the **Communications** menu—see [Section 3 Operation](#) for more information.

As an alternative to the projector’s keypad or remote, you may wish to communicate with the projector using a PC or other controller. Such a device sends commands and receives feedback via serial links (RS232 and RS422), or Ethernet communications to the projector, refer to *the Serial Command document provided in the Dealer Section of the Christie Website, PN 020-100224-XX*.

1.) SERIAL PORT CONNECTIONS

RS232 and RS422, serial ports available on the projector: You can connect a device with a serial interface, such as a computer to either of these connectors (not both) and control the projector remotely by entering specific serial communication commands, refer to [3 Operation, System Configuration - Communications, on page 3-41](#) and the *Serial Command document provided in the Dealer Section of the Christie Website, PN 020-100224-XX*.

## 2.) CONNECTING RS232

Two nine-pin D-sub connectors, labeled RS232 IN and RS232 OUT on the input panel, are dedicated to serial communication, see [Figure 2-18 - Connecting RS232](#). Using the appropriate serial communication cables, connect the controlling source, such as a personal computer to the RS232 IN connector. Set the projector baud rate to match that of the computer. Refer to [Section 3 Operation](#) for details on changing the projector's baud rate.

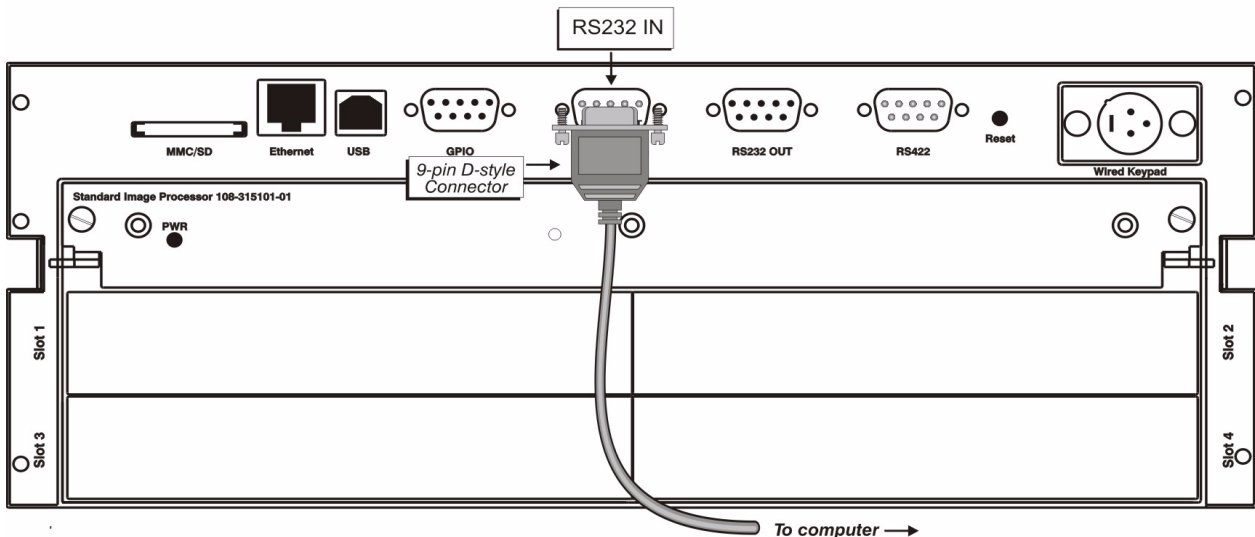

FIGURE 2-18 - CONNECTING RS232

## 3.) CONNECTING RS422

To control the projector with a computer or other controlling device with RS422 capability, connect a RS422 serial communication cable between the controlling device and the RS422 port on the projector, see [Figure 2-19 - Connecting RS422](#). RS422 is better suited than RS232 for serial communication over distances greater than 50 feet.

**⚠ Use the RS422 port only if your device had RS422 capability – always consult the literature provided with your equipment before connecting.**

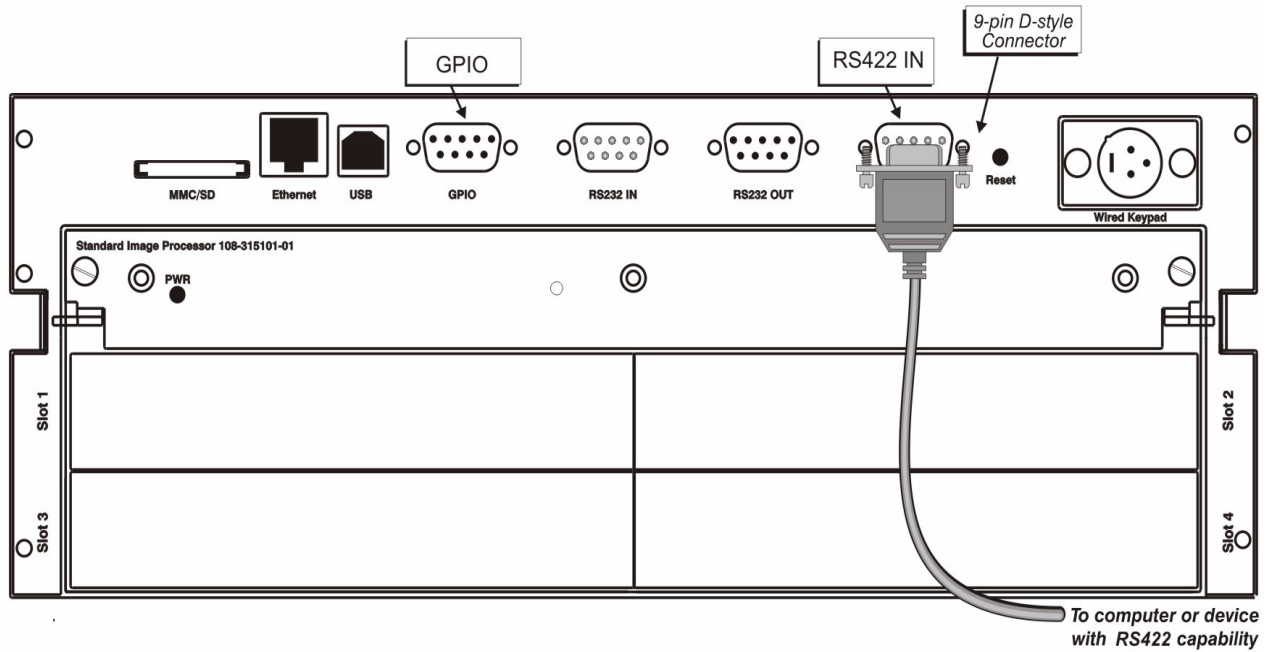

FIGURE 2-19 - CONNECTING RS422

## ETHERNET COMMUNICATIONS

Refer to [Section 3 Operation](#) for further information about setting up and using a projector connected via Ethernet, and the *Serial Command* document provided in the **Dealer Section of the Christie Website, PN 020-100224-XX**.

## CONNECTING MULTIPLE PROJECTORS

**RS232 NETWORK:** To connect multiple projectors in a network with serial communication:

1. Connect the controlling source to the RS232 IN connector of the first projector in the network.
2. Using another serial communication cable, connect one end to the RS232 OUT connector and the other end to the RS232 IN connector of the next projector.
3. Continue this pattern of connection with all projectors in the network. *NOTE: The last projector in the network will only have a connection to the RS232 IN connector; see [Figure 2-20 - RS232 Network](#).*

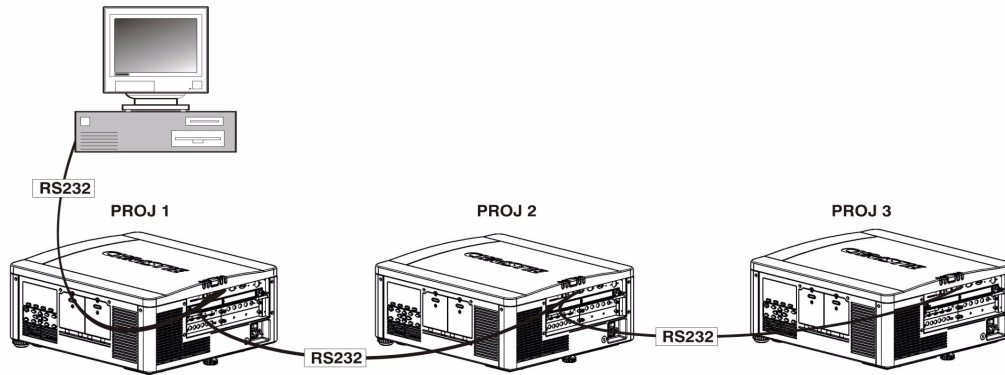

FIGURE 2-20 - RS232 NETWORK

**MIXED NETWORK:** To control multiple projectors with a computer/controller having an RS422 interface:

1. Set them all to the same baud rate as your RS422 controller.

*NOTE: You must enable this combination of RS422 and RS232 in the Communications menu. Set the “Network Routing” option to “RS232 and RS422 Joined”. See [Section 3 Operation](#) for details.*

2. Chain the projectors together by connecting an **RS232 OUT** (Null Cable) of the first projector (already connected to the computer/controller through the **RS422** port straight thru to an **RS232 IN** on the next projector in the chains). Continue connecting projectors in this manner until you’ve reached the last projector in the chain, so that only the last projector has one unused port **RS232 OUT**, see [Figure 2-21 - Mixed Network](#).

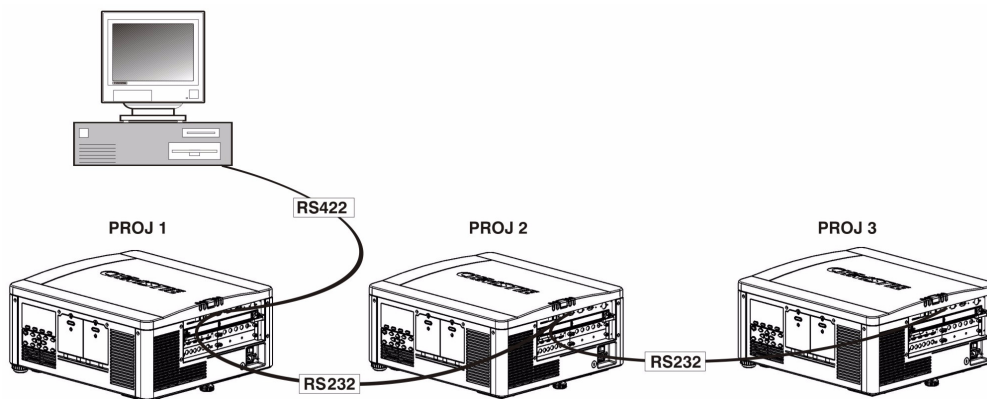

FIGURE 2-21 - MIXED NETWORK

Communication parameters, such as baud rate, must be set to match the particular controlling device. *before* connecting as a network—refer to the documentation that came with your controlling device to determine the proper baud rate. See [Section 3 Operation](#) for help changing the projector baud rate. To communicate to all projectors, set the Network Routing to “RS232 and RS422 Joined”.

**NOTES:** 1) Connect only properly wired serial communication cables. 2) Each RS232 communication cable should be no more than 50 feet in length. Use high quality cables.

**ETHERNET NETWORK SETUP:** To add one or more projectors to an Ethernet network, use standard CAT5 cable to connect each projector's Ethernet port to a hub belonging to the network. A controller or PC must also be connected to the hub, see [Figure 2-22 - Ethernet Network Setup](#). **NOTE:** A wireless router can be used to communicate to the projectors via 802.11b/g.

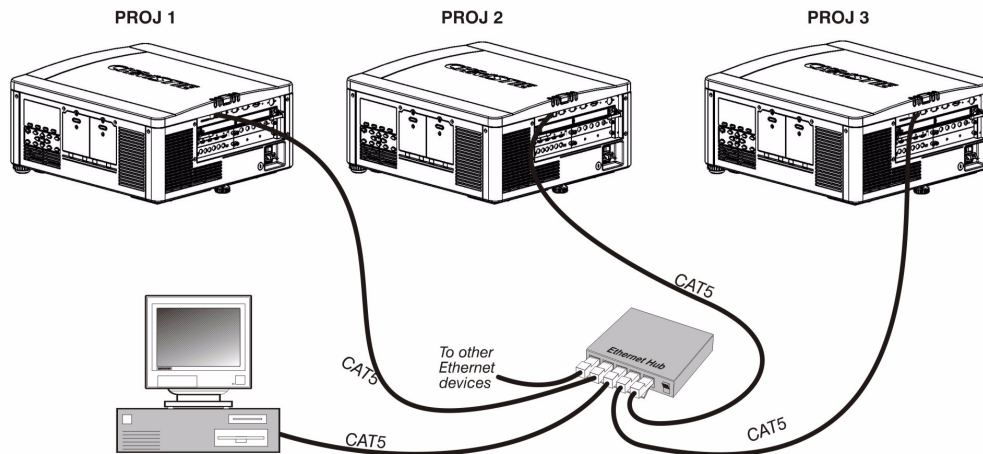

FIGURE 2-22 - ETHERNET NETWORK SETUP

**SETTING THE PROJECTOR'S IP ADDRESS, SUBNET MASK AND GATEWAY:** Refer to [Section 3.5 Configuration - Adjusting System Parameters and Advanced Controls](#).

**CHANGING THE PORT#:** On some Ethernet networks, firewall restrictions may require that the port number of the projector be changed from its default of 3002. If so, enter a new port number in the *Ethernet Settings* menu or include the new port#.

## SEPARATING NETWORKS

By default, communications originating from one type of serial controller—RS232 vs. RS422 vs. Ethernet—stay on the corresponding network path. A “Separate” setting indicates this separation for “*Network Routing*” in the **Communications** menu, refer to [Section 3 Operation](#). If you are using an RS422 controller, for example, it will communicate only with the projector to which it is connected unless you change this setting to either “RS232 and RS422 Joined” or “All Joined”.

## COMMUNICATING TO ALL PORTS

To relay all messages to all ports—RS232, RS422, and Ethernet—set the “*Network Routing*” option in the **Communications** menu for each projector to “All Joined”, refer to [Section 3 Operation](#). This configuration is useful if you are using a non-RS232 controller with the RS232 linking available between these projectors. For example, you may want to use both an RS422-compatible controller and an Ethernet-connected PC for working with a network of projectors linked via their RS232 in/out ports.

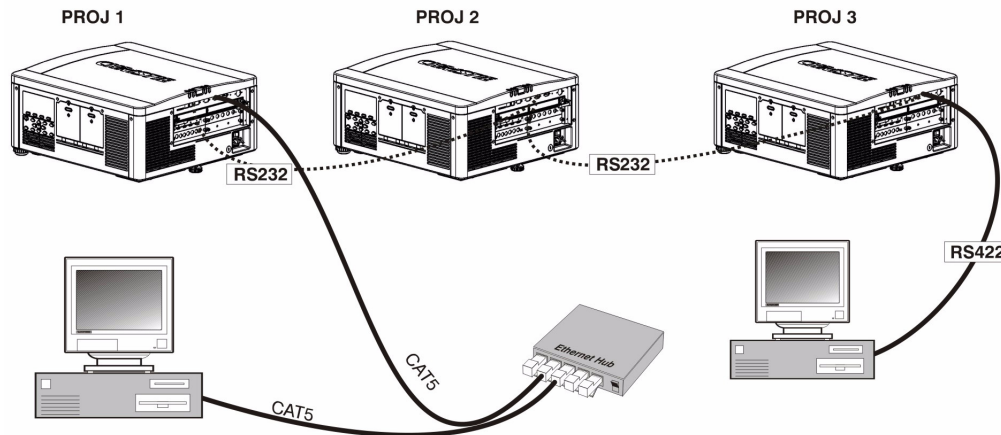

FIGURE 2-23 - COMMUNICATING TO ALL PORTS

To isolate just RS422 communications, select “RS232 and Ethernet Joined”. In Figure [Figure 2-24 - Input Panel](#), only projector #1 will respond to the RS422 controller.

To isolate just Ethernet communications, select “RS232 and RS422 Joined”—only projector #1 will respond via Ethernet.

### SYSTEM INTEGRATION - GPIO CONNECTOR

The GPIO connector on the input panel interface [Figure 2-19 - Connecting RS422](#), provides a method of interfacing a wide range of external I/O devices.

Refer to [Appendix A, Figure A-1 - GPIO Connector](#) for complete details on pin configuration and how to program the GPIO.

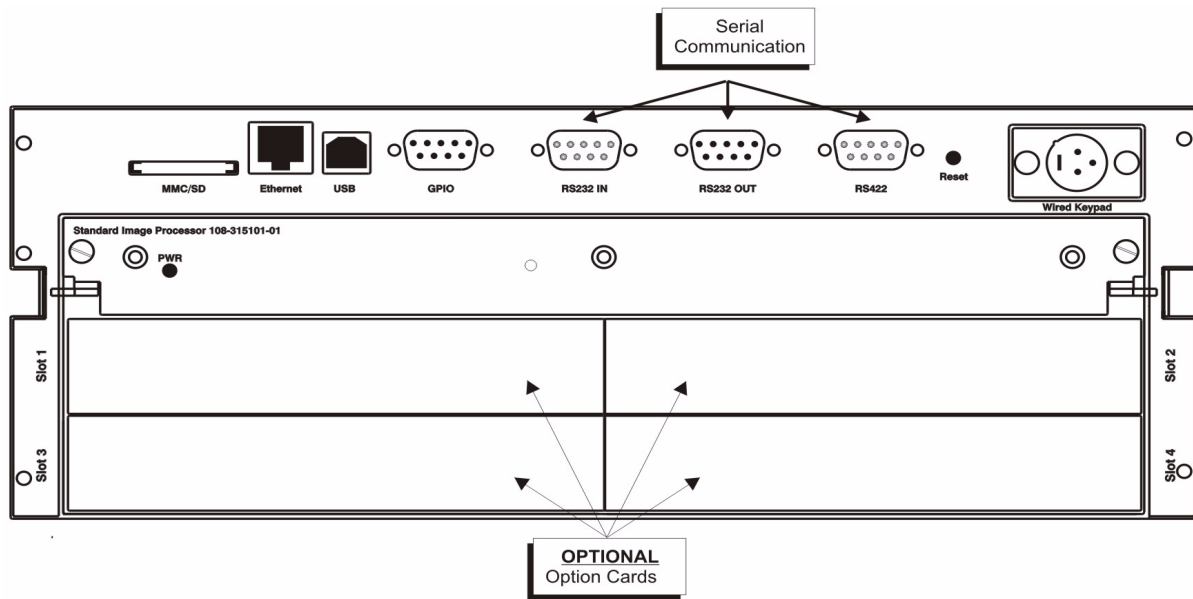

FIGURE 2-24 - INPUT PANEL

**STATUS LEDs**

Looking from the back of the projector, the LEDs represent, from left to right; Lamp 1, Lamp 2, Power, and Status. The LEDs will display the colors as shown below:

<b>Projector State</b>	<b>LEDs</b>	<b>LED State</b>
Hard Boot	All	All LEDs amber - means please wait
Standby Mode	Lamp 1 & 2	<b>Off</b> - lamps are off
	Power	<b>Amber</b> - AC is present but projector is off or standby
	Shutter	<b>Green</b> - shutter is open
<b>Amber</b> - shutter is closed		
Warm-up (Powering ON from standby)	All	LEDs cycle green from left to right
Normal Operation	Lamp 1 & 2	<b>Amber</b> - lamp time has expired and lamp should be replaced
	Power	<b>Green</b> - projector is powered up and operating normally
	Shutter	<b>Green</b> - shutter is open
<b>Amber</b> - shutter is closed		
Cool-down	All	LEDs cycle amber from left to right



Error	Lamp 1 & 2	<b>Amber</b> - lamp time has expired and lamp should be replaced
		<b>Flashing Red</b> - lamp has malfunctioned
	Power	<b>Flashing Red</b> - error has occurred. Details are displayed on the status display
Software Upgrade in progress	All	The pattern will alternate between: Amber, Off, Amber, Off and Off, Amber, Off, Amber
Lamp Regeneration in progress	Lamp 1 & 2	<b>Flashing Green</b> - the lamp is being switched off for its regeneration period to extend lamp life (typically 15 minutes every 24 hours)
	Power	<b>Green</b> - on or <b>Amber</b> - standby
	Shutter	<b>Green</b> - shutter is open

## 2.3 CONNECTING SOURCES

Sources are connected to the *Input Panel* located at the back of the projector. [Figure 2-24 - Input Panel](#). The Input Panel allows one image processor board and up to 4 input cards to be inserted. The input cards are hot swappable i.e.) they may be plugged in and out while the projector is running. The image processor should only be replaced when the projector is off or when it is in standby mode.

There are 5 option Input cards available:

- High-Definition Multimedia Interface/Twin HDMI (High-Definition Multimedia Interface)
- Analog BNC
- Dual SD/HD-SDI (Serial Digital Interface)
- Dual Link DVI
- Video Decoder

These cards slide into the option slots, shown in [Figure 2-24 - Input Panel](#). The option cards can be used in any slot. One or more of the option slots may be used with any combination of option cards, including multiples of the same card type. There may be up to 2 active inputs being displayed at any time, either from one card or from 2 cards. These 2 inputs can be routed to outputs or to the main or PIP video image.

### LEDS

LEDs are located on the faceplate of each input card and indicate the following:

- Power ON - Green
- Signal Valid - Green
- Signal Invalid - OFF

### TWIN HDMI INPUT CARD

This card accepts one or two HDMI inputs, and can route one or both inputs to the card's outputs. There are 5 LEDs on the module faceplate. The PWR on the left side indicates power is applied, and that the card is initialized. To the right side of the corresponding connectors indicate that a valid signal is detected. *NOTE: Refer to [6 Specifications](#) for more details.*

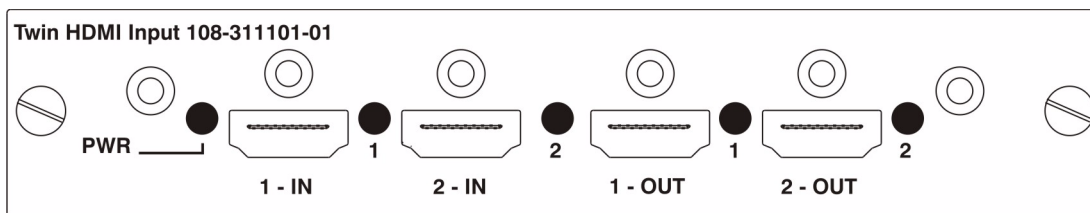

### ANALOG BNC INPUT CARD

This card accepts a graphic analog video signal input over a 5 BNC connector interface. It has no outputs. The input consists of 5 BNC connectors for RGBH & V. The input can accommodate 4-wire RGBC (C stands for composite sync, but note that "S" should be used on the panel, not "C"), and 3-wire RGSB (the "s" on G indicates sync-on-green). The RGB inputs can also accommodate YPbPr signals on the RGB inputs. There are 2 LED's on the module faceplate. PWR indicates power has been

applied and the card is initialized, signal indicates a valid signal has been detected. *NOTE: Refer to [6 Specifications](#) for more details.*

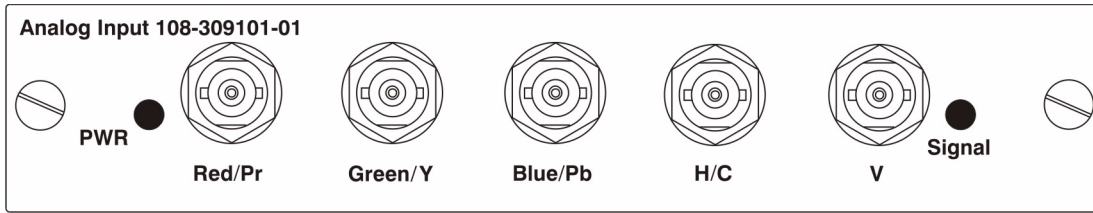

**DUAL SD/HD - SDI INPUT CARD**

This card accepts both standard-definition (SD) and high-definition (HD) serial-digital-interface (SDI) signals from 1 of 2 standard-definition (SD) or high-definition (HD) SDI sources. Both single-link HD and dual-link HD signals are accepted. The card has two SD/HD-SDI outputs, each of which is “loop through” for its respective input. There are 3 LEDs on the module faceplate. PWR indicates power has been applied and the card is initialized, and a second and signal indicates a valid signal has been detected. *NOTE: Refer to [6 Specifications](#) for more details.*

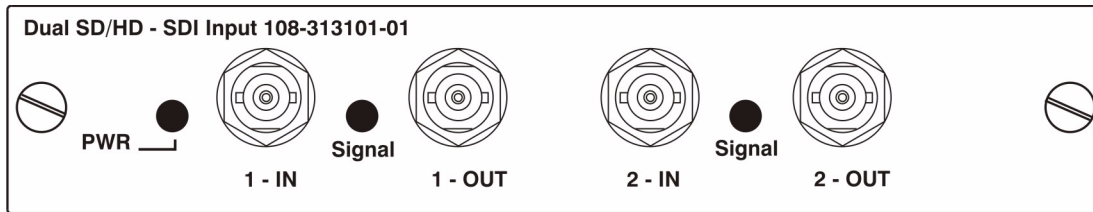

**DUAL LINK DVI INPUT CARD**

This card accepts a single or dual DVI signal with or without High-Bandwidth Digital Content Protection (HDCP) video signal over a DVI-I connector and analog video signals over the DVI-I or 15-pin VGA connector. The module can simultaneously support a digital signal on the DVI input and an analog signal on the VGA port, however it does not support 2 analog signals at the same time. The dual-link DVI has 2 channels and can support up to 330MPix/s. There are 4 LEDs on the module faceplate. PWR indicates power is applied and the card is initialized, and the other 3 on the right side of the corresponding connectors indicate that a valid signal has been detected. *NOTE: Refer to [6 Specifications](#) for more details.*

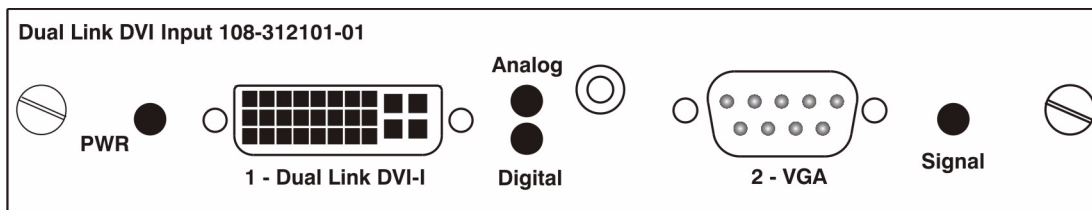

## VIDEO DECODER INPUT CARD

This card accepts and decodes standard definition (SD) video. This includes CVBS (composite video), S-Video, and component sources. It does not accept high-definition (HD) signals and will not support loop through directly. If active loop through is required, a Twin HDMI module must be used. This card supports as many as 6 video signals, four of them on BNC connectors and two on 4-pin mini-DIN connectors. Each mini-DIN connector accepts 1 S-Video signal. The first BNC accepts composite video (only), while the remaining three BNC's can be grouped to allow one of the following combinations:

- 3 CVBS sources on 4, 5 & 6
- 1 CVBS source, 1 S-Video source: Luma(Y) connected to 4(Sy) and Chroma(C) connected to 6(Sc)
- 1 YPbPr source: component signal on 4(Pr), 5(Y) & 6(Pb)

The video decoder input card has 8 LED indicators. The PWR LED indicates that the module is installed properly, and has been successfully configured. The YPbPr LED indicates that a valid component signal has been detected on inputs 4, 5, and 6 (Component input grouping must also be selected in the projector's menu - see Section [3 Operation](#)). The remaining LEDs are each associated with one of the inputs, and indicate a valid signal has been detected on that input. *NOTE: Refer to [6 Specifications](#) for more details.*

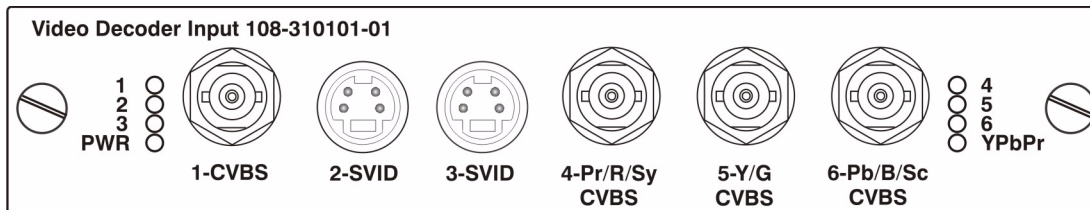

# 3

# Operation

This section explains how to operate the projector once it has been setup and installed. Read this section and familiarize yourself with the components and menu options before using your projector.

- *3.1 Using the Remote Keypad or Built-In Keypad*
- *3.2 Navigating the Menus*
- *3.3 Using Inputs and Channels*
- *3.4 Adjusting the Image*
- *3.5 Configuration - Adjusting System Parameters and Advanced Controls*
- *3.6 Working with PIP or Input Switching*
- *3.7 Lamp*
- *3.8 Status*
- *3.9 Using Multiple Projectors*
- *3.10 Remote Control of the Projector*
- *3.11 Alarm Conditions*



**WARNING**

Refer to Safety Warnings and Guidelines in Section 4.

### 3.1 USING THE REMOTE KEYPAD OR BUILT-IN KEYPAD

The projector is typically controlled using one of the following keypads:



- **Remote Keypad** for wired or wireless control up to 25 feet (8m) away (includes cable for use as a wired remote), see [Figure 3-1 - Remote Keypad](#).
- **Built-in Keypad** located at the side of the projector, see [Figure 3-2 - Built-In Keypad](#).

While each of the keypads provides complete control of the projector, they differ slightly in their arrangement of keys and in what functions can be accessed directly with a key press rather than requiring use of the menu system. You may find one keypad more convenient than another for your specific installation and application.

#### GUIDE TO KEYPADS

Keep in mind the following guidelines:

Press keys one-at-a-time; there are no simultaneous key combinations required.

*NOTE: Power,  Shutter,  and OSD function by: “press-and-hold” (2 seconds), press twice quickly, or press key and up arrow to switch on or press key and down arrow to switch off, see [Figure 3-1 - Remote Keypad](#).*

Hold arrow keys down for continuous adjustment/movement in one direction. In serial networks, pause briefly between adjustments to ensure that more distant projectors can “keep up” with the commands.

If you press a key while the projector is still responding to the previous action, such as during power-up, the second key press may not take effect. These are toggle keys, which require you to press and hold or press twice or press and use the up/down arrow keys.

The remote keypad controls the projector by way of wireless communications from a battery-powered infrared (IR) transmitter. Use the remote keypad the same way you would use a remote keypad supplied with a TV or VCR. When making key presses, direct the keypad toward the projector front or rear IR sensor. One of the two IR sensors on the projector will detect the signals and relay the commands for internal processing. A laser pointer is included in the remote keypad.

Refer to the key descriptions provided for the remote keypad, see [Figure 3-1 - Remote Keypad](#).



**WARNING**

*Laser radiation is emitted from the laser diode in the remote. Do not look directly into the beam of the laser.*

**REMOTE KEYPAD**

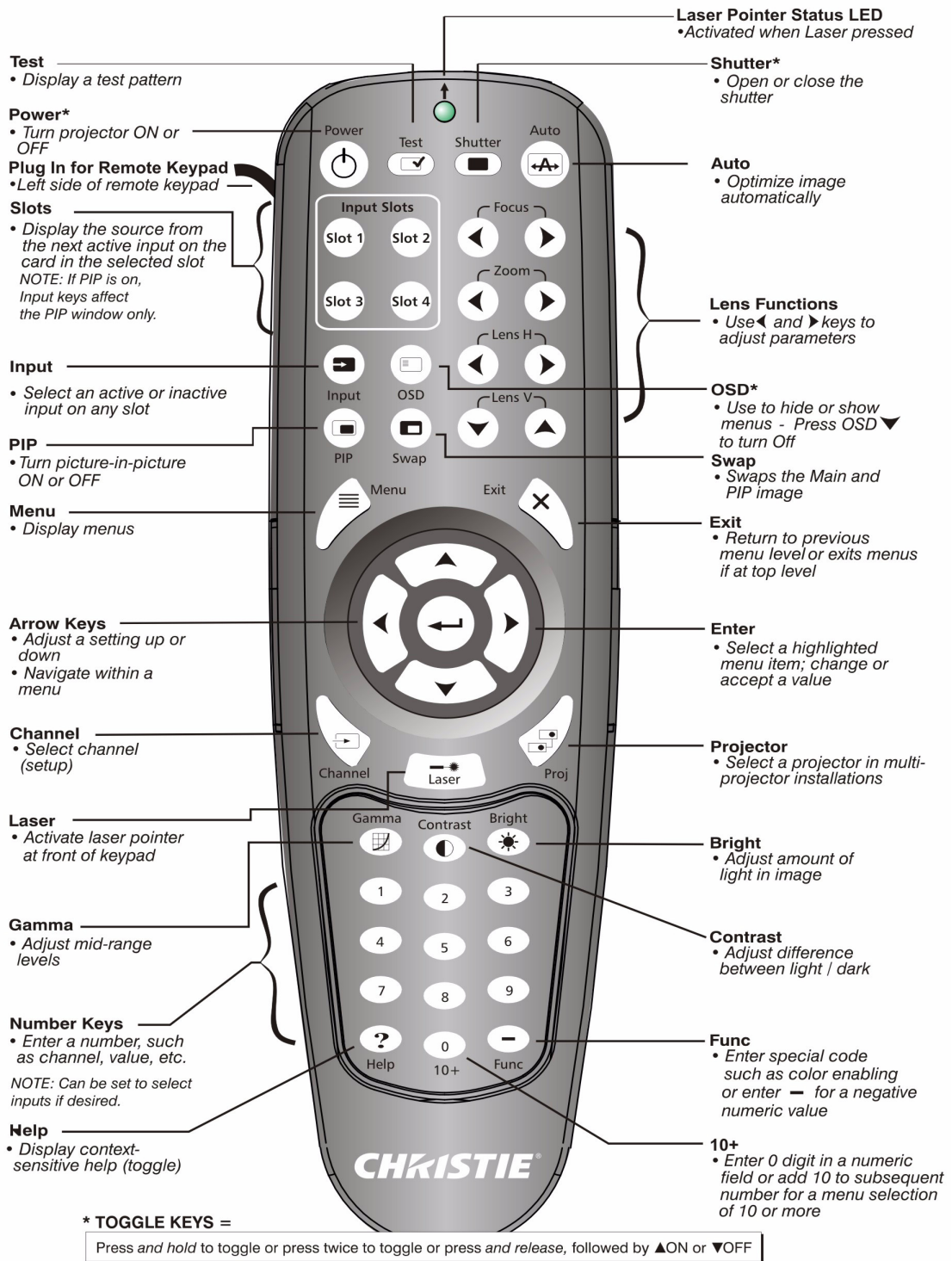

FIGURE 3-1 - REMOTE KEYPAD

**\*WIRED REMOTE**

You can convert the remote keypad into a wired remote keypad using the cable provided with the projector. Connect one end into the remote and the other to the XLR connector on the input panel labeled as wired keypad. The wired remote is recommended when:

- The built-in keypad is inaccessible
- The lighting conditions are unsuitable for proper IR transmission

*NOTE: Leave the batteries in the wired remote for the laser pointer key (☉) to work.*

**BUILT-IN KEYPAD**

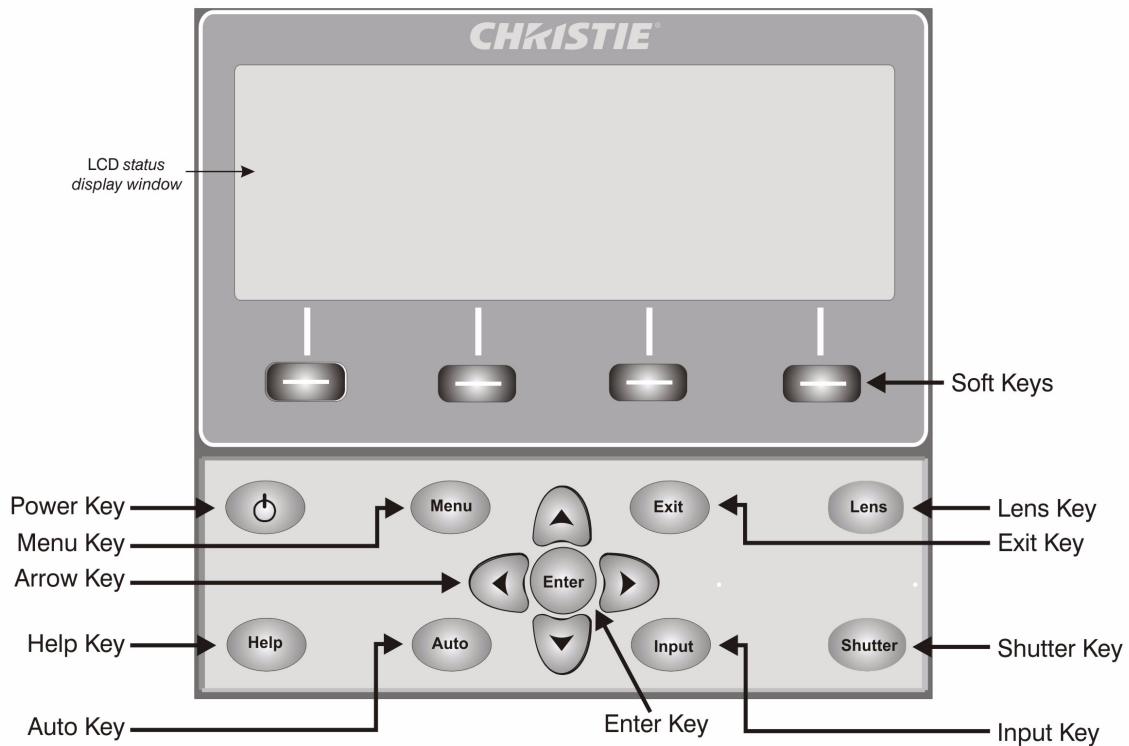

FIGURE 3-2 - BUILT-IN KEYPAD

The built-in keypad has a LCD status display window which displays all states of the keypad controls. The LCD displays status information when the projector is powering up “Warm up: Lamp is warming up” and when the projector is cooling down “Cool down: Lamp is cooling down.” The display shows the state of the keys, menu structure, and menu items.

**Overview of LED and Key States**

The LED color of the keys indicates that the key is in one of these states:

- **Amber**, a functionality is available which will affect the displayed image of the projector
- **Blue**, a functionality that is relevant to the built-in LCD only and will not affect the displayed image from the projector
- **Off**, the key is disabled in the current context







- **Power Key**, used to switch from Standby mode to ON, and from ON to Standby mode; LED always remains Amber
- **Help Key**, only available in the On Screen Display (OSD) context; LED is Amber when the menu is being displayed on the projected image display; when no menu is being displayed, the Help key is still enabled if the OSD is enabled. It is only disabled when the entire OSD is set to OFF.
- **Auto Key**, enabled state when the power is on and there are no test patterns on the screen. If the power is off or a test pattern is displayed the Auto key is disabled.
- **Exit Key**, is determined in the specific context of the screen being displayed.
- **Input Key**, enabled when the power is on. Disabled if the power is off.
- **Lens Key**, enabled when the power is on. Disabled if the power is off.
- **Shutter Key**, enabled when the power is on. Disabled if the power is off.
- **Menu Key**, always remains in the enabled state when the power is on. If the power is off the Menu key is disabled.
- **Soft Key**, used to select an action indicated by text above the key on the LCD. If no text is shown, the associated key is disabled.

### 3.1.1 Remote Keypad Commands

Specific keypad commands are explained, see [Figure 3-1 - Remote Keypad](#):





#### **POWER ON/OFF**

Press and hold  for two seconds or press twice quickly to action the projector ON or OFF. Or press and release  followed immediately by  (ON) or  (OFF) to guarantee the correct action (useful if you are unsure of the present state).

*NOTES: 1) After powering down, the lamp cooling fan remains on for approximately five minutes to cool the lamp. 2) Avoid turning the projector back on until it has been off for a few minutes. Hot re-strikes of the lamp will reduce lamp life.*

#### **TEST**

Steps forward through all internal test patterns. After stepping past the last test pattern, you will return to current input.

Press  and then cycle by using the  and  arrow keys, to cycle in either direction through the test patterns. Press  to return to the current input.

#### **AUTO**

Initiates an automated process in which the projector optimizes critical display parameters such as size, position, pixel tracking, etc., for the current source. These parameters are listed in [Table 3.1 - Auto Setup](#). An auto setup can save time in perfecting a display and you can modify the adjustments as desired.

Table 3.1 - Auto Setup

OPTIMIZES:	SETS TO DEFAULT:
Pixel Tracking	Contrast
Pixel Phase	Brightness
Size and Blanking	Auto Input Level (off)
Vertical Stretch	Detail (if video source)
Position	Filter
Input Levels	Luma Delay

*NOTE: You must have an unlocked channel present to use Auto Setup.*

The best auto setup will be obtained under the following conditions:

- Input levels, it is best to have an image with saturated (very Bright) colors.
- Phase, high contrast edges are needed.



To determine active window size:

- Video images should have whites and blacks in the image.
- Wide range video images should have content (including white) that extends to all edges of the image.

 **CHANNEL**

Select a specific source setup (channel) defined and stored in projector memory. Once you enter a two-digit channel number (or, if there is a list displayed, highlight it and press ) , the display will automatically change and update according to the numerous setup parameters defined for that channel.

*NOTE: A new channel is automatically created if you adjust an image from a new source.*

*NOTE: Channel () key behavior during a presentation depends on whether or not the Display Channel List option is enabled in the **Menu Preferences** menu. You can choose to use a scrollable list of channels when you press , or you may prefer to enter the desired channel number “blind”, i.e., without on-screen feedback. See **Menu Preferences** later in this section.*

 **SLOT 1, 2, 3, 4**

Press to display the next active input on the card in the slot.

 **INPUT**

Displays all inputs in all slots, both active and inactive. Scroll through the list to select an input for the main image. Press Input again to show the list and select the picture-in-picture (PIP) image.



 **PIP**

Turns PIP ON or OFF.



**SWAP**

Swaps the main and PIP images.

**CONTRAST**

Changes the level of peak white in your images. Use   keys until you reach the desired level of contrast—for best results, start low and increase so that whites remain bright but are not distorted or tinted and that light areas do not become fully white (i.e., “crushed”). Conversely, low contrast causes dim images.

**BRIGHT**

Increases or decreases the black level in the image. Use   keys until you reach the desired level of brightness. For best results, start high and decrease so that dark areas do not become fully black (i.e., “crushed”). Conversely, overly high brightness changes black to dark gray, causing washed-out images.

**GAMMA**



Determines how gray shades are displayed between minimum input (black) and maximum input (white) for a given amount of signal. The proper setting helps maintain optimized blacks and whites while ensuring a smooth transition for the “in-between” values utilized in grays. Unlike brightness and contrast controls, the overall tone of an image can be lightened or darkened without changing the two extremes and your images will be more vibrant yet with good detail in dark areas when using the Gamma control.

The normal gamma setting of 2.22 is correct for most signals and conditions. If excess ambient light washes out the image and it becomes difficult or impossible to see details in dark areas, lower the gamma setting to compensate.

 **NUMBER KEYS**

Press  to enter a value in a text box or to select a menu item.

**0 10+**

Press  before pressing another number to enter a number greater than 9, e.g. press  then  to enter the number 12 as a menu selection. *NOTE: When entering numbers in a text field, this button acts as 0.*



**? HELP**





Press  to display context-sensitive help. Press  again to toggle the help window OFF.

 **MENU**

Press  to enter or exit the projector’s menu system.

 **OSD (ON-SCREEN DISPLAY)**







Press   to hide the projector’s menu system during use. To see the menus again, do one of the following:

- Press and hold  for two seconds.
- Press and release  followed immediately by .
- Press  .

Invisible menus are fully functional, enabling “hidden” access to numbered features and image adjustments by entering the corresponding sequence of key presses on the keypad.

*NOTE: With OSD “on”, you can still hide error messages and slide bars by disabling these options in the **Menu Preferences** menu.*







 **SHUTTER**











Press and hold  for two seconds to toggle the internal mechanical shutter blade closed or open with a single keystroke. Or press and release  followed immediately by  (closed) or  (open) to guarantee the correct state (useful if you are unsure of the present state). Alternatively, press   to toggle from the present on/off state. A closed shutter blanks the display (turns it to black). Close the shutter to block the displayed image while maintaining access to projector functions. Opening the shutter restores the image.

*NOTES: 1) The LCD display shows the current state of the shutter. 2) The shutter is open upon power-up.*

 **FUNCTION KEY**

**IF WITHIN A NUMERIC FIELD IN A MENU:** Use  to enter a negative number.

**IF WITHIN A PRESENTATION:** Press Func  followed by two numeric numbers to enable a specific color or colors in the display (see right). For example,    will display only red, and    will display green data. Eliminating one or more colors can help with certain diagnostics and setups, such as when accurately overlaying one image on top of another from stacked projectors.

			= Red
			= Green
			= Blue
			= Yellow
			= Cyan
			= Magenta
			= White (all colors)



*NOTE: Color enabling can also be implemented from numerous locations within the menu system.*

**Proj PROJECTOR**

Press  to access a specific projector within a group of projectors or to confirm if the local projector is listening. The number in the “Enter Number” window indicates which projector is currently listening to commands, and will match the projector number that has been defined in the **Menu Preferences** menu.

The “Projector” checkbox (read-only) shows whether or not the projector physically connected to a keypad is listening to commands from that keypad. A checkmark means that connected projector is listening; if there is no checkmark, you are communicating with a different projector.

To control a specific projector with the keypad, press  and then enter the three-digit number assigned to the projector you want to use. If you switch to a projector other than the one you are currently using, the checkmark will disappear.

To broadcast to multiple projectors, press  and then  again without entering a projector number. Keypad commands will then effect all projectors present. *NOTE: There is no method of controlling a group of projectors within the same wired configuration using the wired keypad exclusively, since there is only one wired protocol available.*

*NOTE: 1) The projector's address can be set in the **Configuration Menu -> Communications Submenu.***

** ENTER**



Press  to select a highlighted item, to toggle a checkbox, or to accept a parameter adjustment and return to the previous menu or image.





**Exit EXIT**

Press  to return to the previous level, such as the previous menu.

*NOTE:  does not save changes within text editing boxes (including number editing of a slide bar value) or within pull-down lists. It acts as a “cancel” in these cases.*

**ARROW KEYS**

Use the   keys to change a slide bar value or to select a different option within a pull-down list without having to first scroll through options or navigate within a menu, pull-down list or text box.

  or  

**Lens H, Lens V LENS H AND LENS V**

When adjusting the image for focus, zoom or horizontal and vertical positioning, use the specific arrow keys (◀/▶ or ▲/▼) related to each function. A small window will appear to indicate the type of adjustment taking place. For example,

- Use the “Focus” ◀ or ▶ keys to improve image clarity as desired.
- Use the “Zoom” ◀ or ▶ keys to achieve a desired image size.
- Use the “Lens H” ◀ or ▶ keys to position the image horizontally.
- Use the “Lens V” ▲ or ▼ keys to position the image vertically.

Press **Exit** to return to a presentation level.

*NOTE: Use the **Lens** key (built-in keypad) with the general ▲ ▼ keys to get the same effect as if using the arrow keys related to “Lens V” or “Lens H” on the Remote Keypad. All 4 lens settings can be adjusted by using the soft keys.*

**➡ LASER**

Press **➡** to activate the laser pointer on the remote. Point the remote at the screen to highlight an area of your presentation.

*NOTE: Leave batteries in the wired remote keypad for the **➡** key to work.*

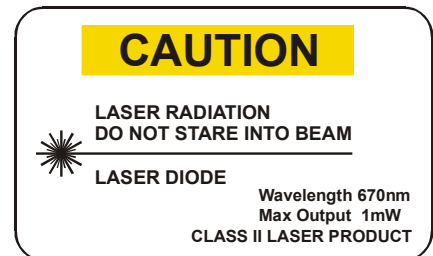

**3.2 NAVIGATING THE MENUS**

**MAIN MENU**

Most of the projector controls are accessed from within the projector’s menu system. There are several groups of related *functions*, with each group selectable from the

**Main** menu as shown at right. Press **Menu** at any time to display this **Main** menu.

On the remote keypad, enter the number corresponding to the function menu you wish to access, such as **2**

for the **Image Settings** menu. Or use the ▲ ▼ keys

on any keypad to highlight the desired option, then press **➡**. The corresponding function menu or pull-down list of further options will appear.

With a function menu displayed, enter a menu option number for any numbered option, or use the

▲ ▼ keys to highlight the desired option and then press **↵** (Enter). Long menus have a scroll

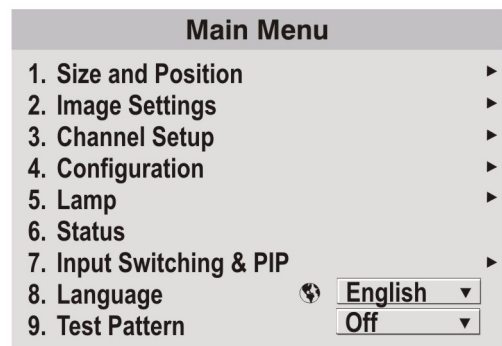

FIGURE 3-3 - MAIN MENU

bar on the right—use the arrow keys to access the remainder of the menu. Locked items or items that do not pertain to the current action or condition appear dimmed and cannot be selected.

When finished with a function menu:

- Press **Exit** to return to the previous screen.

OR

- Press **Menu** to leave the menu system and return to the presentation.

*NOTES: 1) If there is no signal present, all source-dependent adjustments are disabled. 2) After 15 minutes of inactivity, the projector leaves the menu system and returns to the presentation. 3) The **Status** menu is read-only.*

### ON-LINE HELP

Press **Help** to display summary information about the current menu or highlighted option. Press **Help** again to exit.

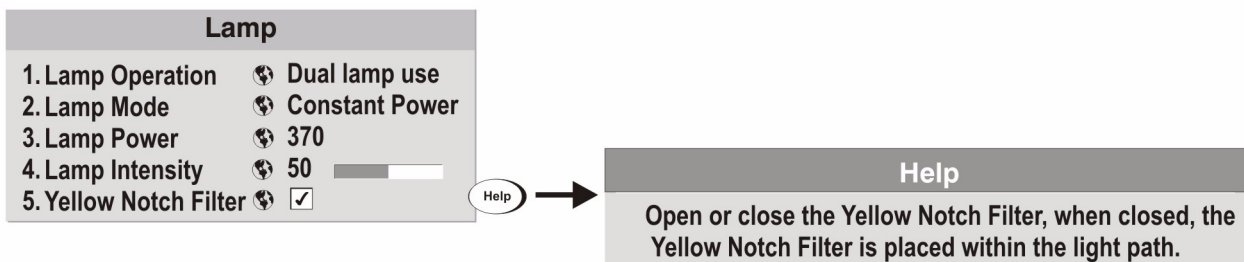

FIGURE 3-4 - ON-LINE HELP

### THE GLOBAL ICON



Menu options that include this icon apply universally. Menu options without this icon apply to the selected channel only.

### USING SLIDE BARS AND OTHER CONTROLS

Most of the function menus allow you to change settings by using slide bars, checkboxes, and pull-down lists. Navigating options:

- Enter the menu option number corresponding to the setting you wish to change (for example, press **Menu** **1** **3** to select “Vertical Stretch” in the **Size and Position** menu).
- Move the highlight to the option desired and press **Enter**.
- Move the highlight to the option desired and press **Left Arrow** **Right Arrow** to adjust immediately.

- You can bypass the menus entirely and use a single key to immediately access an adjustment during your presentation (applies only to options having their own key, such as Contrast, Brightness, Gamma, etc.).
- For “blind” access, hide the entire menu system (see OSD key, above) and access using the proper sequence of key presses.

**Slide bars in menus** – The current value for a given parameter, such as size or vertical stretch, appears to the left of its slide bar icon (adjustment window). This number often expresses a percentage, or it may have units associated with it (such as pixels), depending on the specific option. Press



FIGURE 3-5 - EXAMPLE OF SLIDE BAR

◀ ▶ to gradually adjust the setting up or down—both the number and the length of the bar change accordingly. Hold for continuous adjustment. Or press ⏪ to activate a slide bar text box for specific number entry via the keypad and then press ⏪ to save (or press Exit to cancel).

**“Direct” slide bars** - For quick access, to Gamma, Brightness, and Contrast slide bars without traveling the menu system. Press Gamma, Brightness, or Contrast to display the contrast slide bar.

Use the arrow keys to adjust a direct slide bar, or press ⏪ and enter a specific number from the keypad, then ⏪ or ◀ or ▶ to save (or Exit to cancel). When you are done, press Exit to save and return to your presentation.

*NOTES: 1) You can still adjust a direct slide bar as usual if the display is turned off (see OSD or Menu Preferences menu) — the slide bar just won't be visible. 2) A direct slide bar disappears if it is not used within five seconds.*

**Checkboxes** - Conditions are present if its adjacent checkbox contains a checkmark. To toggle the checkbox, highlight and press ⏪, or highlight and use ▶ to check and ◀ to uncheck. If a checkbox is numbered, enter its number to immediately toggle the checkbox.



FIGURE 3-6 - EXAMPLE OF A CHECKBOX

**Pull-down lists** – To see a pull-down list of options available for a given parameter:

- Highlight the list and press ⏪ (Enter); or
- Enter the menu option number

Use the ▲ or ▼ keys to navigate up and down within the list. Press ⏪ to choose an option from the list.



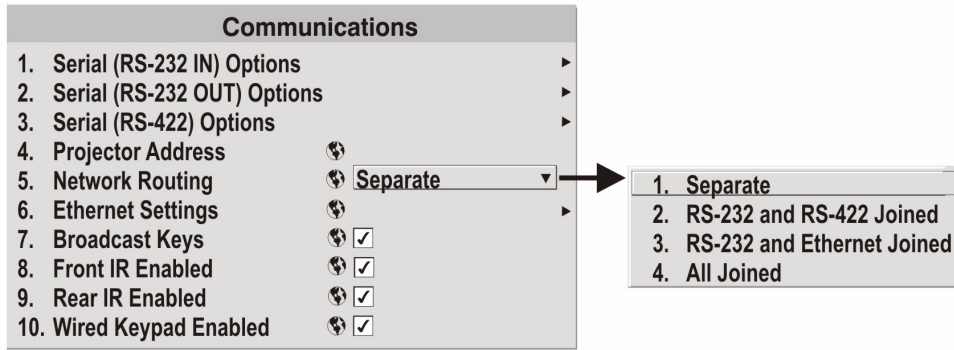

FIGURE 3-7 EXAMPLE OF PULL-DOWN LIST

If you prefer to quickly scroll through a list without first pulling it down, highlight the option and use **◀** or **▶**. Press **↵** when the desired choice appears.

*NOTES: 1) Press **◀** or **▶** to jump between pages in an extra long pull-down list. 2) Press **Exit** while in a pull-down list to **cancel** any change.*

**EDITING TEXT**

**Activate the Edit Window:** To enter or edit text, highlight the desired parameter (such as a channel name) and press **↵** to activate its adjacent edit window. Any previously entered text is displayed with its first character highlighted in a square cursor, signifying that this character is ready for editing.

**Navigate Within the Edit Window:** Press **▶** to move the cursor forward or **◀** to move the cursor backwards as desired.

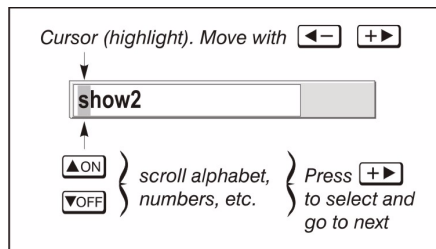

FIGURE 3-8 - ENTERING TEXT

**Edit a character:** To edit a highlighted character, use **▲** and **▼** to scroll through the alphabet, numbers, spaces and punctuation available. When the character you need appears, press **▶** to select it—the cursor will move to the next available character of current text. *NOTE: Also enter numbers directly from the keypad.*

**Add or Delete a Character or Space:** To insert a space at the cursor location, press **Func** **▶**. To delete a highlighted character (or space), press **Func** **◀**.

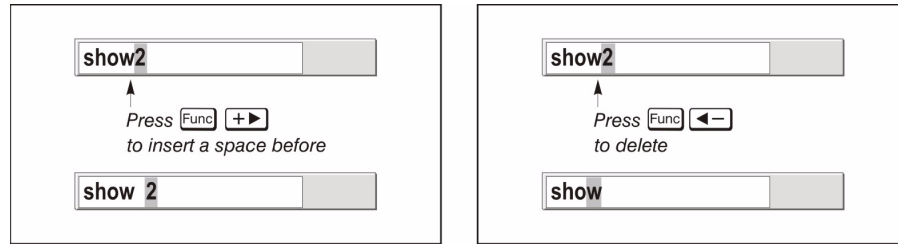



FIGURE 3-9 - ADD/DELETE CHARACTER OR SPACE

**Press**  **(Enter) When Finished:** To accept edits and leave the edit window, press  (Enter).

*NOTE:* Press  at any time to cancel changes and return to the previously defined text.

**Edit numerical values:**

Enter numbers directly from the keypad to specify numbers representing projectors, channels (source setups), or slots. As each digit is entered, it is inserted on the right of the field, and the numbers already in the field are shifted on the left. The channel numbers are defined with two digits—for example, if you enter only a single digit (such as “7”) for a channel number, the channel will automatically be defined as “07”. Enter “07” to utilize this channel. If you press any non-numbered key, the number entered up to that point is accepted and updated as the new value. Press  to cancel editing of numerical values.

### 3.3 USING INPUTS AND CHANNELS

The projector stores and recalls up to 99 different channels (source setups) for a variety of inputs. This memory feature allows you to define and use a variety of customized setups. Depending on what you have defined, each physical source connection (i.e., input at the projector) can have several different channels associated with it.

*NOTE:* See Section [2 Installation and Setup](#), for a full explanation of how to connect sources to the projector.

**HOW DO I SELECT AN INPUT OR A CHANNEL?**

**INPUT** – An input is a source physically connected to the projector.  describes the source signal and which input slot it is connected to.

**CHANNEL** - A channel is a collection of measurements, locations and settings that tailor the display of a signal to your specific needs. Since source types and applications can vary greatly, you will likely want to adjust and define a wide variety of parameters, such as brightness, contrast, size, etc., in order to customize and optimize the display from or for a particular source. For example, the display settings you choose for a VCR source may be very different from those you choose for a high-resolution computer source.

Once you have adjusted a display parameter, such as pixel tracking or contrast, all current settings are collectively stored in the projector's memory as a unique two-digit channel, such as 09. You can have numerous distinct channels available for the same input, any of which can be selected by using the Channel key on the keypad followed by the two-digit channel number.

Shown below is a sample channel list available from Channel. This is typically called the *channel list*.

*NOTE: The Channel key may display a channel list or not, depending on what you have defined for "Display Channel List" (see Menu Preferences later in this section).*

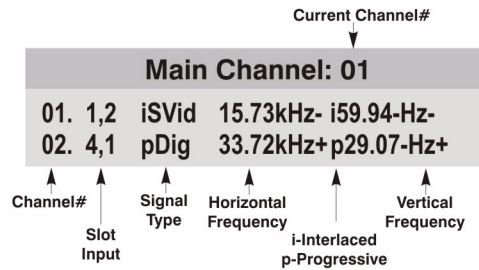

FIGURE 3-10 - CHANNEL LIST

**SWITCHING INPUTS** – There are 4 methods for selecting an input:

1. Press the INPUT key. This will display a list of the 4 slots, with the card type and input signal type in each slot. The currently selected input for the main image will be highlighted. Scroll up or down through the list and press ENTER to make a new selection. Press the INPUT key again to show the list and allow the selection for the PIP image. Repeatedly pressing the INPUT key will toggle between the main and PIP image.
2. Press the appropriate direct SLOT key to quickly display one of the inputs on the selected slot to the main image. This will not bring up any menu selection, and is only applicable for the main image.
3. Use the menu options **Menu -> Input Switching & PIP -> Main Input** and **Menu -> Input Switching & PIP -> PIP Input** to select the source of the image for the main or PIP image. The image will be displayed according to the following:

**If it is the first time you have used the source/input** (or if you used the input but did not define a channel by adjusting anything), the projector will recognize the new input signal based on its frequencies and polarities, automatically displaying an image according to default settings for that signal. In general, the image from the new source will be as large as possible without losing its aspect ratio. This and other default image settings depend on the incoming source.

**If you used the source once before and changed a display parameter** such as contrast, v-position, etc., then a channel was automatically created and still exists in projector memory (see CHANNEL below). Using one of the input or slot keys will automatically recall this channel—and all its setup parameters—and update the display accordingly.

**If more than one channel exists** for the input, the image will be displayed according to the setup parameters for the first channel with matching characteristics.

**CREATING A NEW CHANNEL**

To use a new source with the projector, a new channel must be created so that the projector will respond to an input signal from that source. A new channel can be created automatically, or it can be copied from an existing channel and then edited as necessary, refer to [- Copy A Channel](#) and [- Delete a Channel](#).

When you select a direct input (Slot 1, Slot 2, Slot 3, or Slot 4), any existing channels in the projector are searched for matching input and signal parameters – this only occurs if Auto Source is enabled on these channels. If no match to the incoming input signal is found in currently defined channels, a new channel is temporarily created based on factory-defined defaults for this type of signal. The channel number assigned is the lowest available number from 01-99.

*NOTES: 1) An automatic channel will be discarded unless one or more of its parameters are changed and will not appear in the channel list (see below). 2) If 2 channels have the same distinguishing source characteristics except for the reversal of sync connectors (i.e., H-sync and V-sync, are switched), they are still defined as distinct channels. 3) You cannot define a new channel without an incoming signal.*

**USING A CHANNEL:** You can normally select a channel at any time by pressing (see below). If you want to hide a channel from appearing in this list, you must edit the channel refer to [Channel Edit](#). Such a channel can still be selected by entering its number as shown below.

*NOTES: 1) The current channel is highlighted in the channel list, or, if the current channel is hidden, the first channel in the list is highlighted. 2) Channels created automatically do not appear in the channel list unless a parameter for the channel has been changed.*

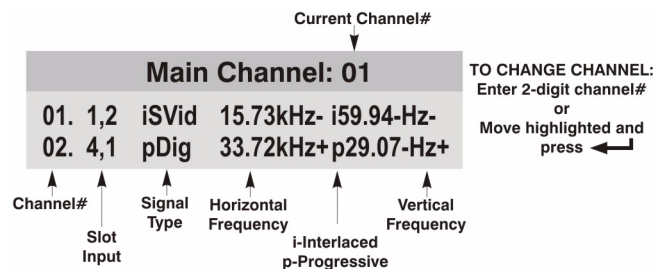

FIGURE 3-11 - USING A CHANNEL

### 3.3.1 Channel Setup Menu

All available channels are listed in the **Channel Setup** menu, which describes how each channel can be accessed and provides access for editing, copying and deleting channels.

Press from the presentation level to display the **Main** menu. To display the **Channel Setup** menu, press , or move the highlight to the **Channel Setup** option and press . The **Channel Setup** menu will appear (see sample below).

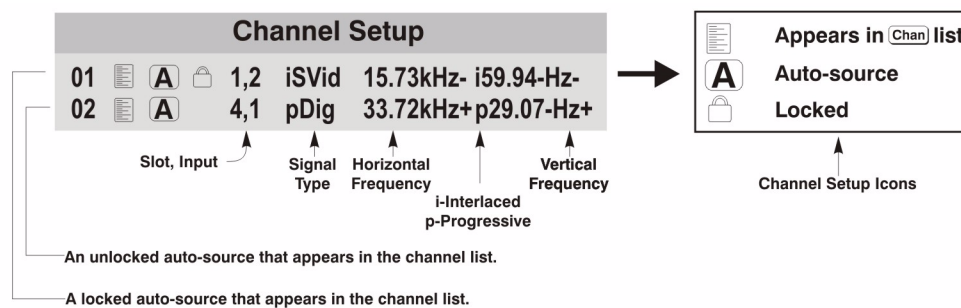



FIGURE 3-12 - CHANNEL SETUP MENU

The channel setup icons list all defined channels. The far left column lists channel numbers defined. The values in the far right columns indicate horizontal and vertical frequencies or if there is a defined name for a channel, it appears here. The H & V frequencies will not appear if a name has been defined for the channel; instead the name is only seen. The H & V frequencies are inserted as, the name when the channel is first created. The vertical frequency is displayed with the sync polarity. The remaining columns pertain to each signal type; such as, input number, slot location, a variety of icons indicating access to each channel, and an abbreviated description of each signal type.



*NOTE: Use  and  to see the remaining channels not visible in the initial display of channels.*

**SIGNAL TYPE** — The channel list or the **Channel Setup** menu, identifies signal types abbreviations as defined below in [Table 3.2 - Abbreviations for Signal Type](#). Composite Sync on the H/C input or the V input (4-wire). These abbreviations are preceded by either an “i” (interlaced signals) or “p” (progressive signal“).

*Table 3.2 - Abbreviations for Signal Type*

The first 5 items in this table is analog RGB with various sync combinations indicating Sync Source when editing the channel:

<b>Abbrev.</b>	<b>Signal Type</b>
4WH	Composite (4 wire) on HC input
4WV	Composite (4 wire) on V input
SG	Sync-on-green (4 wire)
5W	Separate H,V (5-wire)
5WR	Separate H,V swapped (5-wire)
SVid	S-Video
CVid	Composite Video
Dig	Digital
DigE	Digital Encrypted

**TO COPY A CHANNEL**, highlight the desired channel in the **Channel Setup** menu, then press  to go to the **Channel Copy/Delete** submenu. Select “Copy” and press —a new channel will be created. It is identical to original, which still remains, but it is identified with the next available number from 01-99. If you change your mind and do *not* want to copy the current channel, press  to cancel and return to the previous menu. Copying channels is a quick method for creating numerous channels, each of which can then be edited and adjusted for a variety of presentations in the future.

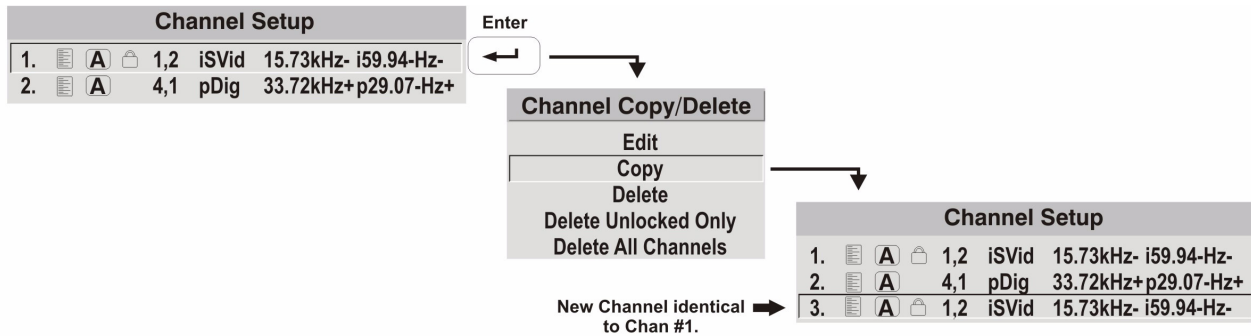

FIGURE 3-13 - COPY A CHANNEL

**TO DELETE A CHANNEL**, highlight the desired channel in the **Channel Setup** menu, then press **Enter** to activate the **Channel Copy/Delete** submenu. Select “Delete” and press **Enter**—a window will appear to confirm the deletion of this channel.

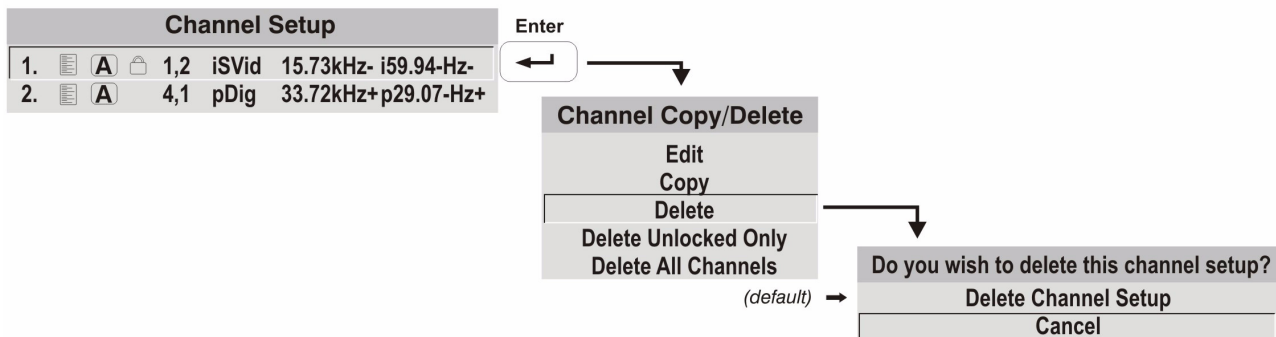

FIGURE 3-14 - DELETE A CHANNEL

**TO DELETE MULTIPLE CHANNELS** highlight any channel in the **Channel Setup** menu and press **Enter** to go to the **Channel Copy/Delete** submenu. Select “Delete Unlocked Only” and press **Enter** to delete all unlocked channels. Select “Delete All Channels” to delete all channels, even those that are locked. In either case, the current channel will remain but will be redefined from projector defaults.

*NOTE: For any deletion, a window will appear to confirm the deletion of the desired channel. Select “Cancel” (default) if you don’t want to delete after all.*

### CHANNEL EDIT — STEP 1

Press **Menu** from the presentation level to display the **Main** menu. To display the **Channel Setup** menu, press **3**, or move the highlight to the Channel Setup option and press **Enter**. The **Channel Setup** menu will appear.

**CHANNEL EDIT — STEP 2**

To edit parameters shown in the **Channel Setup** menu, select the relevant channel and press . The **Channel Edit** menu will appear similar to the sample shown below.

Channel Edit: 01		
Card Type	Video Decoder Input Card	
H-Frequency	15.73 kHz-	
V-Frequency	59.94 Hz-	
Interlaced	Yes	
Sync Source	S-Video	
1. Name	15.73kHz-	i59.94Hz-
2. Number	1	
3. Slot	1	
4. Input	1	
5. In Menu	<input checked="" type="checkbox"/>	
6. Auto Source	<input checked="" type="checkbox"/>	
7. Locked	<input checked="" type="checkbox"/>	
8. Previous Channel		
9. Next Channel		

FIGURE 3-15 CHANNEL EDIT

**CHANNEL EDIT — STEP 3**

If desired, review and/or edit the following channel setups in the **Channel Edit** menu:

• **NAME:**

An alphanumeric label can be defined and/or changed here. Channel names can be up to 12 characters in length. The default name is the horizontal and vertical sync frequencies.

• **NUMBER:**

A two-digit channel number can be changed here. *NOTES: 1) If you enter a channel number that already exists, a dialog message appears indicating that this number is already in use—assign a different channel number. 2) You can define up to 99 channels.*



• **SLOT:**

1-4, corresponding to which slot in the projector’s input panel the source is connected:

• **INPUT:**

1-6, corresponding to which input on the selected slot the source is connected to.

• **IN MENU:**

If checked (default, except for automatically defined channels with unchanged parameters), this defined channel will then appear in the list available when  key is pressed. If unchecked, the channel must be accessed via  on the keypad or via the Auto Source function. *NOTE: On-screen display of the channel list is an option that must be set in the **Menu Preferences** menu.*

• **AUTO SOURCE:**

If checked, (default), the projector can automatically locate this channel when an incoming input signal matches. If not checked, the projector can locate the selected channel only when it is directly selected via  on the keypad—and a change in input signal will not result in a channel change.

• **LOCKED:**

If checked, all of the image settings for this channel are locked. If unchecked (default), all available image settings can be adjusted as desired. You cannot use Auto Setup with a locked channel.



• **PREVIOUS CHANNEL:**



Select this option to see or change **Channel Edit** settings for the previous channel in the **Channel Setup** list.





• **NEXT CHANNEL:**

Select this option to see or change **Channel Edit** settings for the next channel in the **Channel Setup** list.

### 3.4 ADJUSTING THE IMAGE

The most commonly used options for image adjustments are accessed through two menus: **Size and Position** () and **Image Settings** (), both of which appear in the **Main** menu. From either of these two menus. You can change settings affecting the image from the current channel by working with the appropriate slide bars, checkboxes and pull-down lists.  will return to the previous menu (or to the presentation, if from the **Main** menu) and accept any changes you may have entered. Settings are saved with the current channel.

From your presentation, you can access any of the individual options in these menus by pressing  followed by the appropriate two-digit number representing their location in the menu system. For example, press   to quickly access the “Gamma” option in the **Image Settings** menu.

*NOTES: 1) For certain options, preference may be to use a “direct key” from presentation level to go directly to a particular option without traveling through the menu system (available for certain display parameters only). For example, press  to access the “contrast” slide bar immediately. Press  to return to your presentation. 2) To hide “direct” slide bars, disable the “Display Slide bars” checkbox in the **Menu Preferences** menu. 3) To hide the entire menu system from view, turn off the on-screen display by pressing  .*

For a good and efficient first step in perfecting the image, press Auto Setup . This optimizes critical display parameters such as size, position, pixel tracking, etc., based on the type of incoming source. An Auto Setup can save considerable setup time, and you can still adjust the image as described below.



Use Auto Setup (Auto)

The best auto setup will be obtained under the following conditions:

- Input levels, it is best to have an image with saturated (very Bright) colors.
- Phase, high contrast edges are needed.

To determine active window size:

- Video images should have whites and blacks in the image
- Wide range video images should have content (including white) that extends to all edges of the image.

### 3.4.1 Size and Position Menu

Increase or decrease the size of your image, change its proportion (aspect ratio), move the image to a specific area of the screen, and refine other related parameters. Use **Size and Position** controls to match the image precisely to the screen used at the site.

Refer to [Using Slide bars and Other Controls](#) if you need help using any of the options and controls. Changes made in the **Size and Position** menu are applied immediately and are saved when you exit the menu (press Exit or Menu).

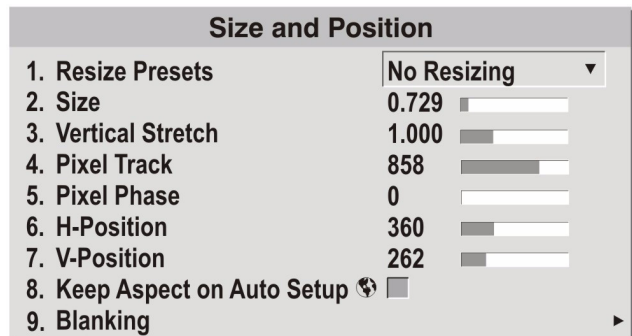

FIGURE 3-16 - SIZE AND POSITION MENU

#### • RESIZE PRESETS

*NOTE: The same resize presets are available to all HD and SXGA+ screen models. However, the graphics used to describe each preset in this section are of the SXGA+ models only.*

**Resize Presets** will display an image in its native resolution (no resizing) or will resize the image by maximizing either the height, width or both height and width, or will resize to the maximum size possible while keeping the original aspect ratio.

Size, Position and Blanking parameters will automatically adjust accordingly or, if Blanking is set first, which defines an Active Input Area; **Resize Preset** scaling will occur in this region of interest only. Resizing options are explained below.

Resize Presets	
1. Default	= maximize for current source
2. No Resizing	= display in native resolution
3. Full Size	= fill the screen (regardless of source)
4. Full Width	= fill display width & keep aspect ratio
5. Full Height	= fill display height & keep aspect ratio
6. Anamorphic	= retain 16:9 aspect ratio

Custom (not selectable) = non-preset values for Size, Vertical Stretch, H-Position, V-Position and/or Blanking

FIGURE 3-17 - RESIZE PRESETS

**WHAT IS THE RESIZING DEFAULT?** By default when displaying a new source, your image will utilize as much of the projector’s display area as possible for the type of incoming source data, but with minimal or no changes to aspect ratio. See *Select “Default”* below.

**WHEN “CUSTOM” APPEARS:** The “Custom” re-size descriptor automatically appears in the **Size and Position** menu when any of the values for *Size, Vertical Stretch, H-Position, V-Position* or *Blanking* do not correspond to those for a preset. This option is not offered in the *Resize Presets* pull-down list.

- Select **“DEFAULT”** for most sources (factory default). The image will be centered and displayed as large as possible *depending on the type of source*.

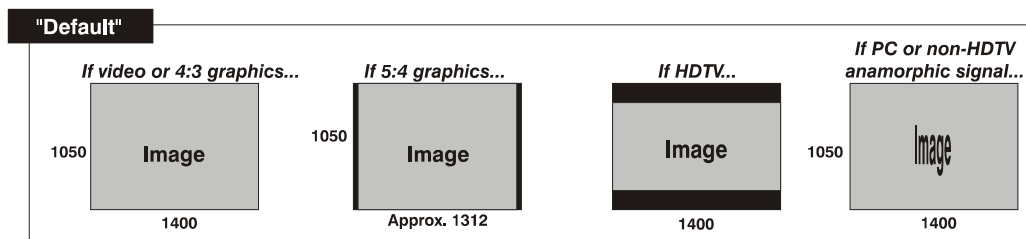

FIGURE 3-18 - RESIZING DEFAULT

- **“NO RESIZING”** displays the image in its native resolution, which may or may not match the projector’s resolution. For example, for a source with a native resolution of 800 x 600, “No Resizing” in an SXGA+ projector will use the central 800 x 600 pixels and have a black border—the black border areas are unused areas, see below.

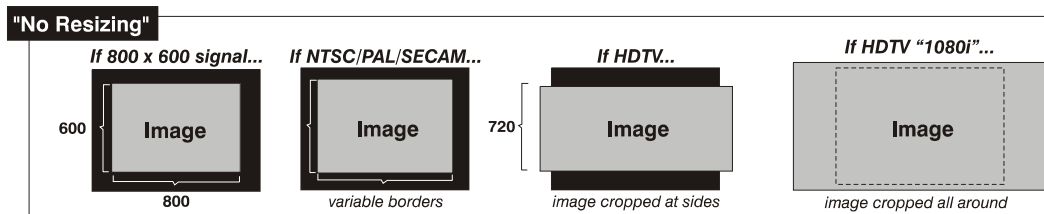

FIGURE 3-19 - NO RESIZING

- **“FULL SIZE”** uses *all pixels* for displaying the image, regardless of source or original aspect ratio. Incoming source material having a different aspect ratio than the projector will be stretched for display.

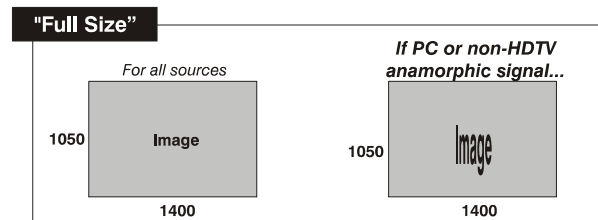

FIGURE 3-20 - FULL SIZE

- **“FULL WIDTH”** fills the projector’s display from left-to-right without changing the original aspect ratio of the image. Depending on the source, data at the top and bottom may be discarded (cropped), or the display may have black borders at the top and bottom (called “letter-boxed”).

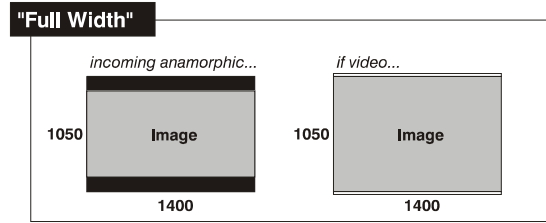

FIGURE 3-21 - FULL WIDTH

- **“FULL HEIGHT”** fills the display from top-to-bottom. Depending on the source, this may create borders.

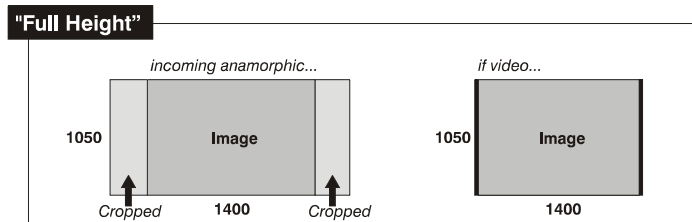

FIGURE 3-22 - FULL HEIGHT

- **“ANAMORPHIC”** displays an anamorphic image in its native 16:9 aspect ratio. The image will fill the screen from side-to-side and be centered between black bars at top and bottom.

- **SIZE:**

Controls both the image *width* and *height* in tandem, maintaining the current aspect ratio of the displayed signal data.

- **VERTICAL STRETCH:**

Adjusts the *height* of the image while keeping the width constant. Use “*Vertical Stretch*” to change the aspect ratio of the display.

- **PIXEL TRACK**

Steady flickering or several soft vertical stripes or bands across the entire image indicates poor pixel tracking. Proper pixel tracking ensures that the image quality is consistent across the screen, the aspect ratio is maintained, and that the pixel phase can be optimized (described below). Tracking determines the frequency of the pixel-sampling clock, indicated by the number of incoming pixels per line, so that all pixels generated by a particular source are sampled.

*NOTE: By default, the projector samples at the correct frequency for most sources.*

For best results, use a test pattern such as a smooth gray consisting of a clear pattern of black and white pixels, or a similar “half on, half off” graphic image, such as the *Windows 2000* shutdown

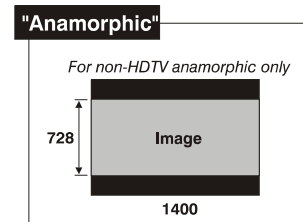

FIGURE 3-23 - ANAMORPHIC

screen. adjust the slide bar until the vertical stripes broaden to the point where one large stripe fills the image. If the image still exhibits some shimmer or noise, adjust *pixel phase* (below).

• **PIXEL PHASE:**

*NOTE: Adjust “Pixel Phase” after “Pixel Tracking”.*

Adjust pixel phase when the image (usually from an RGB source) still shows shimmer or “noise” after pixel tracking is optimized. Pixel phase adjusts the phase of the pixel-sampling clock relative to the incoming signal.

Adjust the slide bar until the image stabilizes and each pixel is clearly defined. You may notice that you can stabilize the image at more than one point—i.e., you may find that the image appearance at “11” is identical to the image appearance at “38”, thus you can use either setting.

If some shimmer from a video or HDTV source persists, use the “Filter” control to remove high-frequency noise from the signal.

• **H-POSITION:**

Moves the image right or left within the area of available pixels.

*NOTE: The value shown represents where the approximate center of the image lies in relation to the total number of pixels available horizontally. This varies widely according to the signal—watch the image while adjusting.*

• **V-POSITION:**

Moves the image up or down within the area of available pixels.

*NOTE: The value shown represents where the approximate center of the image lies in relation to the total number of pixels available vertically. This varies widely according to the signal—watch the image while adjusting.*

**BLANKING**

This submenu consists of the following options:

• **ACTIVE INPUT WINDOW:**

This read-only value indicates the current size of your displayed data or “region of interest” as defined by the blanking controls. By default, the projector automatically determines what portion of its full resolution to use, and pixels in the surrounding borders are turned off. To specify a specific active input window size by adjust one or more “Blank” settings. For example, if you have blanked (cropped) 100 pixels from both the left and right edges of an incoming source of 1400 x 1050, the remaining active input window will be reduced to 1200 x 1050.

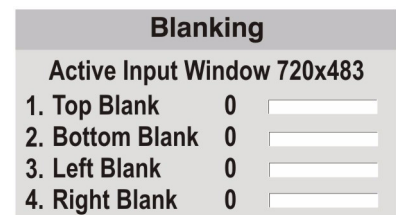

FIGURE 3-24 - BLANKING SUBMENU

**BLANKING (TOP, BOTTOM, LEFT, and RIGHT):** Crop the image so that unwanted edges are removed from the display (changed to black). Blanking defines the size of the *Active Input Window*, or area of interest. Range of adjustment depends on the source resolution and other factors.

*NOTE: Blanking a PIP image resembles zoom. For example, left Blanking zooms the right side of the PIP image; Right Blanking zooms the left side. There are no black bars.*

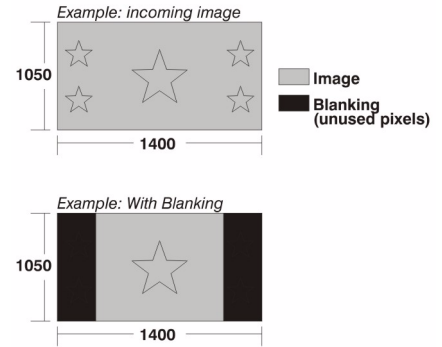

FIGURE 3-25 - BLANKING OF A PRIMARY IMAGE

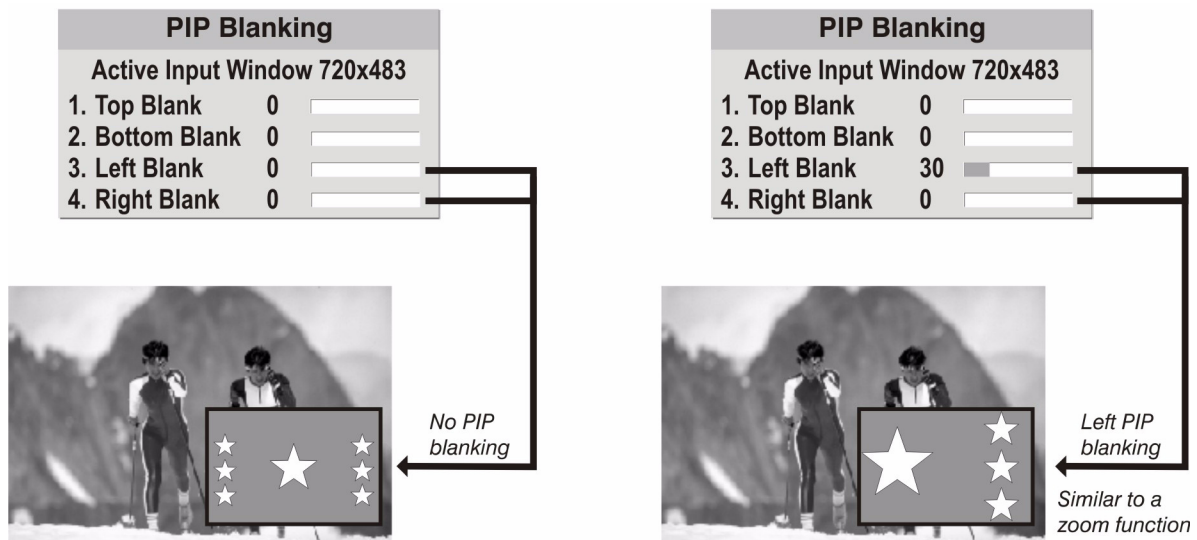

FIGURE 3-26 - BLANKING OF A PIP IMAGE

### 3.4.2 Image Settings Menu

Use the **Image Settings** menu to alter your main image without affecting its size or position. Changes made are applied immediately and are saved when you exit the menu (press **Exit** or **Menu**). Options not available for the projector model or source are disabled and appear dim (gray).

• **CONTRAST:**

“Contrast” increases or decreases the perceived difference between light and dark areas of your image (0-100). For best results, keep close to 50. For best results, start with a low value and increase so that

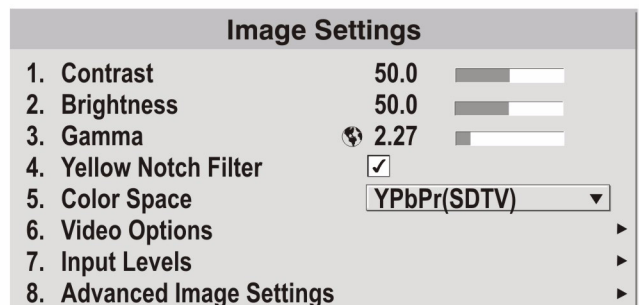

FIGURE 3-27 - IMAGE SETTINGS MENU

whites remain bright but are not distorted or tinted, and that light areas do not become white. *NOTE: If the environment lighting changes, an adjustment of Gamma is recommended (see below).*

• **BRIGHTNESS:**

Increases or decreases the amount of black in the image (0-100). For best results, keep close to 50. Start with a high value and decrease so that dark areas do not become black. Conversely, high brightness changes black to dark gray, causing washed-out images.

• **GAMMA:**

A global setting that determines what gray shades are displayed between minimum input (black) and maximum input (white) for all signals. A good gamma setting helps to optimize blacks and whites while ensuring smooth transitions for the “in-between” values utilized in other colors.

Gamma is used to fine-tune the gamma table currently in use, ranging from 1 – 3 (2.22 = default). If excess ambient light washes out the image and it becomes difficult or impossible to see details in dark areas, lower the gamma setting to compensate. This will improve contrast while maintaining good details for blacks. Conversely, if the image is washed out and unnatural, with excessive detail in black areas, increase the setting. In high ambient light conditions, lower gamma may produce better results than higher gamma. Gamma of 2.22 (default) indicates the gamma table has not been adjusted. For more information, refer to **Advanced Image Settings** submenu, **Gamma Table**.

• **YELLOW NOTCH FILTER (YNF):**

YNF is a channel based control with an additional global control. It works on a “last request gets served” basis. i.e. Enable YNF in the global control, YNF will be enabled. Thereafter; switch to a channel which does not use YNF, the YNF filter will be removed (or disabled). Then change the global control, the YNF filter will do whatever is requested; last request is honored.

• **COLOR SPACE:**

Determines how the color components of an analog input signal are decoded for accurate color in the display. Useful only for analog signals and certain digital sources. Although color space for these analog signals is automatically determined by the projector. You may wish to override this and manually set a specific color space.



FIGURE 3-28 - COLOR SPACE

*NOTE: For some signals, the color space function is entirely automatic and the pull-down list is disabled.*

The current color space appears in the **Image Settings** menu. Press  to select a different option:

- Select **RGB** unless you are using component video
- Select **YPbPr (Video)** with a standard definition televised signal (SDTV).
- Select **YPbPr (HDTV)** with a high definition televised signal (HDTV).

*NOTE: When certain RGB signals are first connected, the projector may not recognize them as RGB and will incorrectly decode their color information as YPbPr (video). These signals can include:*

- RGB signals in NTSC, PAL, SECAM frequency ranges.
- Scan-doubled sync-on-green.

- Scan-quadrupled sync-on-green.

For these signals, change the color Space to RGB, and then define a new channel for future use.

**VIDEO OPTIONS**

This submenu is used with video sources only.

• **AUTOMATIC GAIN CONTROL (AGC):**

AGC affects decoded video images only. Enter a checkmark (default) in most instances. Activate the decoder’s AGC circuit to ensure properly bright images. Delete the checkmark if a decoded video image exhibits strange color artifacts such as stripes in highly saturated colors, indicating an incompatibility between this source and the AGC.

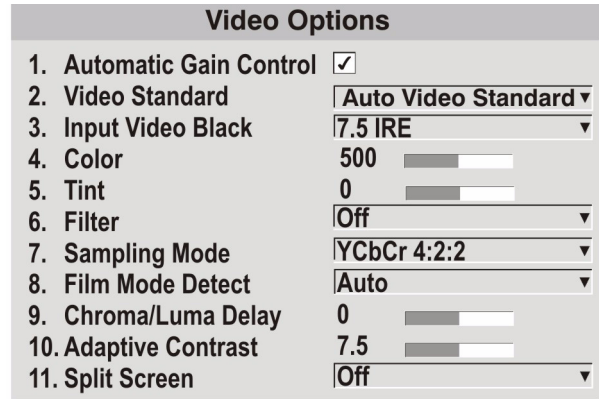

FIGURE 3-29 - VIDEO OPTIONS

• **VIDEO STANDARD:**

For most video standards available in the world, the projector automatically detects the incoming horizontal and vertical frequencies and sets the projector’s processing of this signal to the corresponding standard. The current video standard name appears in the **Video Options** submenu, and includes an “A” if it is auto-detected. Press to view or select a different video standard from those available to the projector—any that are disabled have frequency characteristics that differ from those of the incoming signal. Selecting a specific standard forces the projector to process the signal according to this standard.

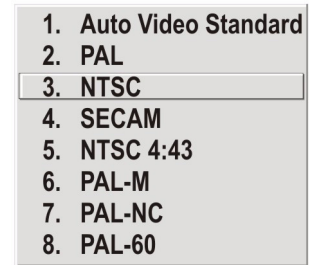

FIGURE 3-30 - VIDEO STANDARD

*NOTE: Best results are obtained with defined channels. Otherwise, switching from one video source to another can sometimes cause slight disturbances in the display, indicating that the Auto function is struggling. Recover by briefly selecting a different video standard, then going back.*

Table 3.3 - Regions and Video Standards: Summary

STANDARD	WHERE USED (Subject to Change)
PAL	Most of Europe, China, Australia, some of S. America, some of Africa
NTSC	N. America and Japan
SECAM	France, Eastern Europe, most of Africa
NTSC 4.43	A tape-only standard for partially-translated hybrid signals
PAL-M	Brazil
PAL-NC	Argentina, Chile, other Latin American countries
PAL 60	

*NOTE: Generally, use “Auto” for all instances except: 1) a poor quality input signal or 2) a black-and-white video signal. In order to detect and display such signals, select the relevant standard from the list.*

• **INPUT VIDEO BLACK:**

This control compensates for incoming elevated black levels present in certain video signals, and ensures that blacks in the display are neither crushed (i.e., where dark grays appear black) nor excessively elevated (i.e., where blacks appear dark gray). By default, the projector automatically determines the best setting according to the type of incoming video signal:



- **0 IRE** – Used for DVD output with “enhanced black”, SECAM, most PAL standards, and Japanese NTSC.
- **7.5 IRE** – Used for most NTSC video signals.

For some types of video, you can override the setting. The control is disabled for other types of video (and all graphics sources). Generally, if black appears crushed when brightness = 50, choose “0 IRE”. If black appears excessively elevated, use “7.5 IRE”.

• **COLOR:**

This slide bar adjusts the color saturation level. Lower settings produce less saturated colors, for example a setting of “0” produces a black and white image. If the color level is too high, colors will be overpowering and unrealistic.

• **TINT:**

Adjusts the red/green color hue for true color reproduction of video and HDTV signals connected to Input 3 or 4. For best results, adjust tint while displaying an external test pattern—it is recommended that tint remain at its default setting.

• **FILTER:**

The proper filter setting is automatically set for virtually all signals, and rarely needs to be changed. Override only if standard pixel tracking and phase adjustments do not adequately clear up a “noisy” video signal, or if a graphics signal appears overly “soft”. Both instances indicate that “Filter” may be set to the wrong option.

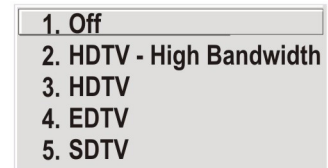

FIGURE 3-31 - FILTER

• **SAMPLING MODE:**

Sets the color sampling mode for a digital signal to either YCbCr 4:4:4, RGB or YCbCr 4:2:2. The proper sampling mode is determined automatically by the projector; you can override this setting.

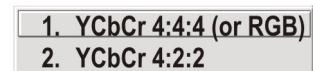

FIGURE 3-32 - SAMPLING MODE

• **FILM MODE DETECT:**

Enable or disable film motion detection. Only available for interlaced or segmented frame sources.

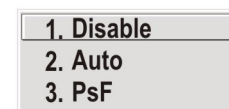

FIGURE 3-33 - FILM MODE DETECT



• **CHROMA/LUMA DELAY:**

Affects any incoming composite or S-video signal, delaying the luma signal (intensity) in relation to the chroma (color). In the image, increasing the luma delay will move luma (seen as a shadow where colors overlap) to the right slightly, with colors remaining in place. Decreasing this delay will move the shadow slightly to the left. If necessary for your current source, adjust so that no shadows occur with adjacent colors.

• **ADAPTIVE CONTRAST:**

Dynamically expands the contrast of the output image producing vibrant images with seamless response to scene changes and fades. The slide bar adjusts the amount of adaptive contrast to apply, with a setting of “0” producing no change.

• **SPLIT SCREEN:**

This control allows a snap shot of the main image to be presented on the right side or lower part of the screen, to allow evaluation of advanced image processing features. All resizing controls are honoured on both images. However, image processing controls (such as, Detail, Sharpness, Noise Reduction and Adaptive Contrast) only happen on the left side or top image. Changing inputs, channels or test patterns will disable this control. PIP operation must be disabled prior to enabling this control.

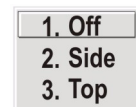

FIGURE 3-34 - SPLIT SCREEN

**INPUT LEVELS**

*NOTES: 1) Because the projector automatically optimizes input levels for all but the most unusual of sources, it is recommended that only experienced users use the **Input Levels** submenu. 2) Before beginning, check that overall contrast and brightness settings are near 50 **and** that color temperature is properly set up on an internal grayscale test pattern. 3) Refer to [Auto](#), on page 3-5.*

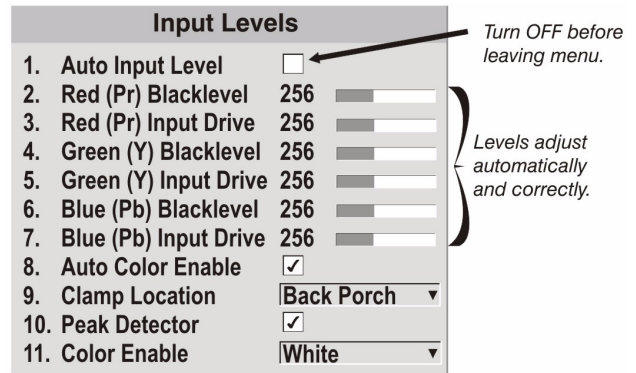

FIGURE 3-35 - INPUT LEVELS

Good RGB or input levels—that is, the *drives* and *black levels* for each of the three colors, red, green and blue—ensure that images from analog sources other than decoded video have maximum contrast without crushing black or white. By default (and in an “Auto Setup”), the projector automatically determines the best input levels by monitoring image content and adjusting the controls appropriately—further adjustment is typically not required to obtain proper blacks or whites.

*NOTE: This automatic adjustment requires at least **6-12 consecutive white pixels** in the image. Without these pixels, input levels may produce skewed colors, particularly in non-video images.*

For a source exhibiting overly high black levels (typically caused by a noisy source causing black level spikes) use the **Input Levels** menu (shown above). These adjustments, serve as a calibration process

compensating for differences in sources and cabling, to perfect the source image input levels and eliminate the “overshoot” and “undershoot”. *NOTES: 1) Input Levels are of limited use with digital signals, but do offer some ability to tweak poorly mastered source materials. 2) Input levels apply for the current source only, but for any color temperature used. 3) Assuming that color temperature has been set up based on the internal test patterns, you can then set up input levels for a given source so that it matches the color temperature of the internal test patterns.*

• **AUTO INPUT LEVEL:**

Use only if you are an experienced user and you have an unusual source that you feel needs further color temperature and/or input level adjustment. This compensates for incoming out-of-range drives (white) and black levels (black) that would cause “crushing” of light and dark colors in the image. After entering a checkmark, wait for the six slide bar values to stabilize, then delete the checkmark and exit. The Auto Input Level is automatically turned off upon exit from the **Input Levels** Menu.

• **BLACK LEVELS AND DRIVES:**

To check your image levels and adjust these controls:

1. Ensure overall “Contrast” and “Brightness” settings are both set to near 50. *NOTE: Not required for “Auto” adjustment.*

 = 50 (approx.)

 = 50 (approx.)

2. Check the color temperature setup using an internal grayscale test pattern, making sure to obtain a neutral grayscale.

*NOTE: Not required for “Auto” adjustment.*

3. Confirm that you are using input on an Analog BNC card or a Dual Link DVI card. Input Levels are not applicable for sources going through the decoder. A grayscale is recommended.
4. If black levels are too high (and/or whites are too low, which is rare), you likely have a noisy source that is producing skewed input levels. Enable “Auto” in the **Input Levels** menu. Wait for all six values to stabilize. Alternatively, do not use “Auto”—reduce black levels manually instead. Judge by eye and change one or more of the six levels as necessary to obtain proper blacks and whites. You may want to see only a certain color while adjusting—use the “Auto Color Enable” option (described below).
5. Delete the “Auto” checkmark and leave the **Input Levels** menu.

**IMPORTANT: Do not use Input Levels to adjust color temperature.** This will distort contrast and brightness functions as well as color temperature.

• **AUTO COLOR ENABLE:**

When a checkmark is present, selecting a specific black level or drive to adjust will automatically enable the corresponding color in the display. Delete the checkmark to see all colors, or to enable a different specific color through the Color Enable control.

• **CLAMP LOCATION:**

Brightens the image produced from certain high-resolution high-frequency graphic sources. The projector automatically selects the best clamp location for most sources. Use the normal **Back Porch** location if the image is either sufficiently bright or overly bright. Select **Sync Tip** if the image appears unusually dim, if there are horizontal streaks across the image, or if there is significant color drift. This moves the clamping pulse from the normal back porch location (which is likely too short) to the tip of the horizontal sync pulse. **Tri Level** is typically needed for an HDTV source.

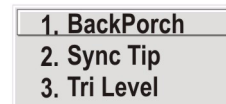

FIGURE 3-36 - CLAMP LOCATION

• **PEAK DETECTOR:**

A tool to assist with defining individual input levels, enabling you to accurately set the Input Levels for any particular source with the appropriate image. Enabling the Peak Detector activates a special operating mode for detecting *only* pixels that are considered black or white—all other levels are displayed as a mid-level gray. When used with a smooth grayscale pattern in which black and white are known to be at opposite edges of the image, you can watch these isolated areas while adjusting individual black levels and input drives until both black and white edges are *just* visible and distinguished from neighboring pixels. Images from this source will then display correct blacks and whites without crushing. See [Figure 3-37 - Adjusting Input Levels Using the Peak Detector \(RED EXAMPLE SHOWN\)](#).

1. Display a 16 level grayscale test pattern from the desired external source, and enter a checkmark in the **Peak Detector** checkbox. *NOTE: The “Peak Detector” will initially render the grayscale as a uniform gray field before adjustment or extreme crushing.*
2. Display one primary color. *NOTE: Select Auto Color Enable to ensure the correct color is displayed for each setting.*
3. For the current color, adjust its corresponding “**Black level**” slide bar *just* until a single band of black appears at one edge of the screen. This band represents the first band of the grayscale pattern, which should be 100% black.
4. With the same color still active, adjust its corresponding “**Input Drive**” slide bar *just* until a single band of color appears at the opposite edge of the screen. This band represents the last band of the grayscale pattern, which should be 100% white (or the current color, if a certain color is enabled).
5. Check the black band and adjust the black level slide bar if necessary.  
*NOTE: Adjusting the black levels affects the gain. Only adjust when necessary.*
6. Repeat Steps 3-5 with the two remaining primary colors. When each primary color shows one optimized black band and white (or colored) band, the input levels for this source are correctly set. Upon exiting the **Input Levels** menu, the Peak Detector checkbox will clear.

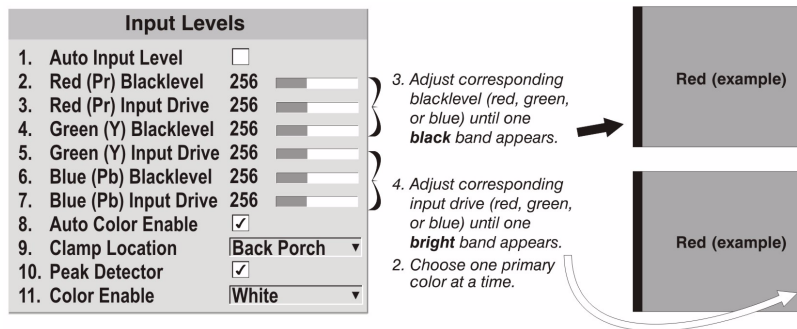

FIGURE 3-37 - ADJUSTING INPUT LEVELS USING THE PEAK DETECTOR (RED EXAMPLE SHOWN)

**COLOR ENABLE:**

Select which color or colors you want to see in the display, useful while working with color temperature white levels or input levels.

*NOTES: 1) Input levels apply for the current source only, but for any color temperature used. 2) If color temperature is set up based on the internal test patterns, you can set up input levels for a given source so that it matches the color temperature of the internal test patterns.*

- 1. White
- 2. Red
- 3. Green
- 4. Blue
- 5. Yellow
- 6. Cyan
- 7. Magenta

FIGURE 3-38 - COLOR ENABLE

**ADVANCED IMAGE SETTINGS**

Use the **Advanced Image Settings** submenu to make the adjustments necessary for lesser-used but more specialized applications on your projector.

- Advanced Image Settings
  - 1. Gamma Settings ▶
  - 2. Detail Settings ▶
  - 3. Noise Reduction Settings ▶
  - 4. Color Settings ▶
  - 5. Dynamic Iris ▶

FIGURE 3-39 - ADVANCED IMAGE SETTINGS

**GAMMA SETTINGS:**

These controls apply a default *video*, *graphics* or *simple* gamma table or “curve” to your images, controlling the intensity of mid-level colors and producing maximum contrast, brightness and color performance. As shown at right, the graphics curve is a modified power curve that will show more detail in darker areas of the projected content while the video curve has a linear segment near black to compensate for increased black levels typical of

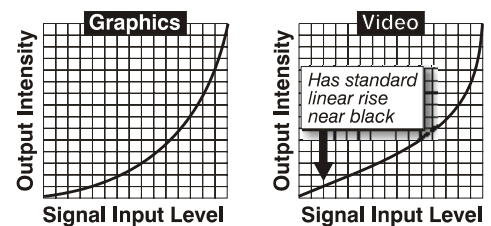

FIGURE 3-40 - GAMMA CURVE

video signals. A simple gamma curve is a true power curve that does not alter the contrast or the intensity of mid-level colors. Although the projector automatically applies either the graphics or video curve according to what type of incoming signal is detected, in some cases you may wish to override this default and use *graphics* gamma for a *video* source or video gamma for a graphics source. Alternatively, if neither default is ideal, you may prefer to apply the simple (non-optimized) gamma curve or a user-defined custom gamma curve that has been created externally, named, and downloaded to the projector (requires separate PC-based Arbitrary Gamma software application to create the table and the Web UI to download it). If any of these special user curves have been installed, their names will appear in the Gamma Table pull-down list.

Keep in mind that any *Gamma Table* choice sets the related *Gamma* value (shown in the **Image Settings** menu) to a 2.22 default, where it can be fine-tuned as desired. Different values (1-3) here indicate that the original gamma table has been adjusted with either the *Gamma* slide bar or direct key.

*NOTES: 1) If no user curves have been defined and downloaded to projector memory, only the 2.22 default gamma curve is available here – adjust as desired using gamma in the main Image Settings menu. 2) Some graphic material will look best with the video setting while some video material is best with the graphic setting.*

• **GAMMA:**

Affects the shape of the curve determining what grey shades are displayed for a given amount of signal input between minimum (black) and maximum (white). The normal curve has a gamma of 2.22 which is correct for most signals and conditions. If there is a lot of ambient light the image can become washed out so that it becomes difficult or impossible to see details in dark areas. Lowering the gamma setting can compensate for this.

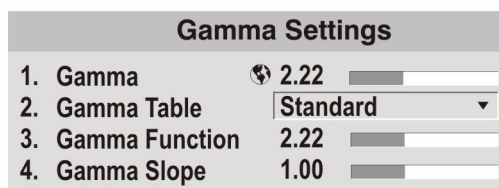

FIGURE 3-41 - GAMMA SETTINGS

• **GAMMA TABLE:**

Allows you to select the base gamma table. Select from one of the standard tables, or select an arbitrary gamma table that has been downloaded to the projector. A separate PC utility is needed to do this. When the Gamma control is not 2.22, the gamma curve used is an interpolated value between the selected table and either a 1.0 or 3.0 table. The 2.22 table is a simple power curve. The standard table is a modified 2.22 curve with an optimized linear portion in the low end of the curve.

• **GAMMA FUNCTION:**

Defines the base gamma power curve used when the base gamma table value is set to “custom”. This value, combined with gamma slope setting determines the base gamma table to be used as the custom base table. The curve is generally a power curve with a small linear segment at the bottom defined by the slope.

• **GAMMA SLOPE:**

This control defines a slope to be used for the base custom gamma table for a small section at the bottom of the curve. This slope can be used to bring in or out the low level blacks in the image. This slope combined with the gamma function, define the custom gamma table.

**DETAIL SETTINGS:**

• **DETAIL:**

Adjusts the sharpness of the image. Setting detail above the halfway point can introduce ‘noise’ in the image. Lower settings can improve a noisy signal.

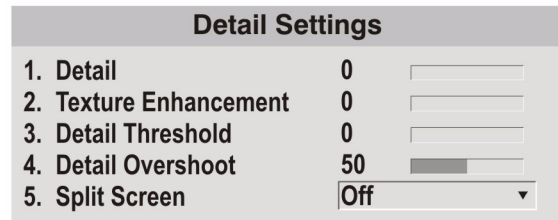

FIGURE 3-42 - DETAIL SETTINGS

• **TEXTURE ENHANCEMENT:**

Applies texture detail enhancement based on adaptive horizontal, vertical, and diagonal large edge and small edge enhancement processes.

• **DETAIL THRESHOLD:**

Selects a filter sensitivity to noise. A higher value may improve noisy sources especially for higher settings of detail.

• **DETAIL OVERSHOOT:**

Minimizes ringing on the enhanced edges detail and texture effects.

• **SPLIT SCREEN:**

Refer [Video Options](#).

**NOISE REDUCTION SETTINGS:**

• **NOISE REDUCTION:**

Selects a filter sensitivity to noise. A higher value may improve noisy sources, but it will soften the image.

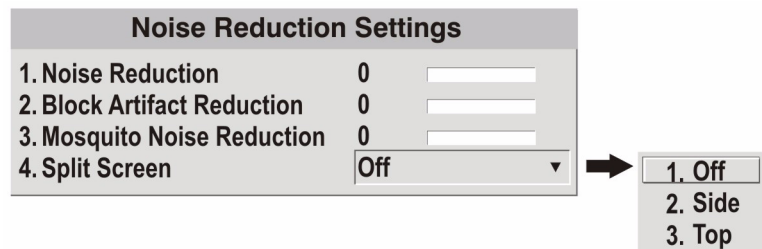

FIGURE 3-43 - NOISE REDUCTION SETTINGS

• **BLOCK ARTIFACT REDUCTION:**

Locates and reduces block edges produced by discrete cosine transform (DCT) based compression processing.

• **MOSQUITO NOISE REDUCTION:**

Reduces mosquito artifacts around sharp edges in DCT based compression by dynamically adapting to image content.

**SELECT COLOR ADJUSTMENT**

Select the output color adjustment most suited to this input signal. The options include the following:

**Max Drives** - All color adjustments are turned off allowing the projector to run at maximum brightness.

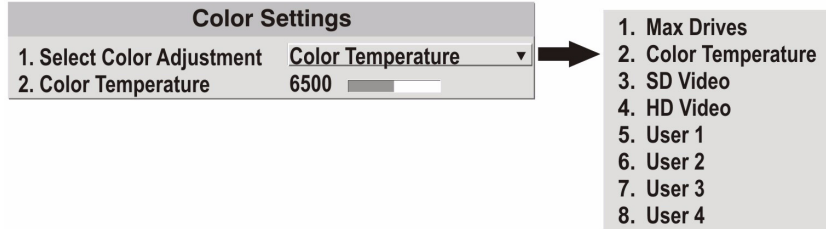

**Color Temperature** -

Allows you to specify a color temperature between 3200 and 9300 based on the setting of the color temperature slider.

FIGURE 3-44 - COLOR SETTINGS

Expressed in degrees Kelvin [3200K, 5400K, etc.]. Lower numbers appear reddish white and higher numbers appear bluish.

Standard settings are:

- 9300K, is close to the white of many computer monitors
- 6500K, is the standard for color video, in both standard and high definition forms
- 5400K, is a standard for graphics and black and white video
- 3200K, is useful if the projected image is to be filmed or shot as part of a studio set illuminated with incandescent lights

For all color temperatures the color primaries; red, green, and blue are unchanged and reflect the native colors of the projector.

**SD Video and HD Video** - Sets the output color to a specific standard value. Adjusts the colors; red, green, blue, and white.

**User#** - Select 1 of 4 user defined sets of color adjustments; defined in the **Configuration** menu.

**DYNAMIC IRIS**

The **Dynamic Iris** adjusts the aperture to allow more or less light through. This will allow for deeper blacks in dark scenes.

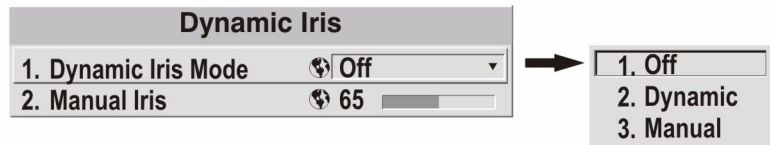

FIGURE 3-45 - DYNAMIC IRIS

**• DYNAMIC IRIS MODE:**

Enables either the **Dynamic** or **Manual Iris** operation of the Dynamic Iris. If set to **Dynamic**, the projector will automatically adjust the iris as the content of the image changes. If set to manual, then

set the **Manual Iris** control to set the iris to a fixed position, as a percentage of fully open. If **Dynamic Iris Mode** is set to OFF, the position of the iris will be fixed at fully open.

• **MANUAL IRIS:**

When the **Dynamic Iris** is set to manual, adjust the aperture for a fixed position where 100% represents fully open. Adjusting the aperture will increase or decrease the levels of blacks in dark scenes.

### 3.5 CONFIGURATION - ADJUSTING SYSTEM PARAMETERS AND ADVANCED CONTROLS

Use the **Configuration** menu to define general operating parameters and communications with other projectors and equipment, and to access other advanced processing and image adjustments affecting overall performance. The **Configuration** menu provides access to diagnostics, calibration tools and the Service submenu (password-protected).

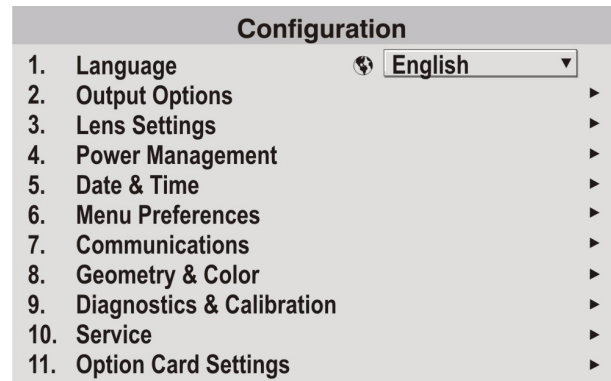

FIGURE 3-46 - CONFIGURATION MENU

The first six options in the **Configuration** menu are explained below:

• **LANGUAGE:**

Choose the available language to use in the projector’s menus. The change will take effect immediately.



#### OUTPUT OPTIONS

• **SCREEN IMAGE ORIENTATION**

Select the on screen image orientation from Front, Rear, Front Inverted, and Rear Inverted.

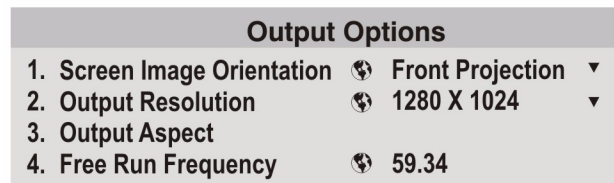

FIGURE 3-47 - OUTPUT OPTIONS



- **SCREEN IMAGE ORIENTATION:**

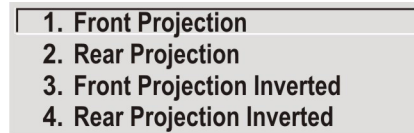

FIGURE 3-48 - SCREEN IMAGE ORIENTATION

- **OUTPUT RESOLUTION:**

Sets the output pixel resolution; default is the native resolution of the projector.

- **OUTPUT ASPECT:**

Allows custom output aspect ratios to be defined. By default the output ratio follows that of the platform.

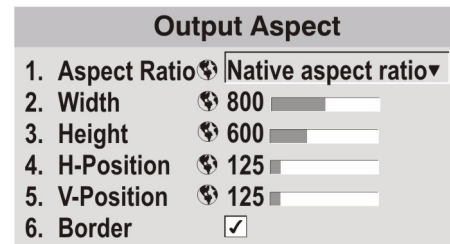

FIGURE 3-49 - OUTPUT ASPECT

- **ASPECT RATIO:**

This control allows the selection of one of the pre-defined aspect ratios, or the native aspect ratio of the platform.

- **WIDTH:**

The width of the aspect ratio in pixels.

- **HEIGHT:**

Defines the height of the aspect ratio in pixels.

- **H-POSITION:**

Defines the horizontal position of the output image in pixels.

- **V-POSITION:**

Defines the vertical position of the output image in pixels.

- **BORDER:**

This control toggles an OSD graphic rectangle that represents the current aspect ratio.

- **FREE RUN FREQUENCY:**

This control sets the output video vertical frequency.

**LENS SETTINGS**

• **INTELLIGENT LENS SYSTEM:**

Check this box to enable the **Intelligent Lens System (ILS)**. When enabled, the lens position (horizontal, vertical, focus, and zoom offsets) are stored per channel. If you change channels, the lens position will change as the new signal is being displayed. When ILS is not enabled, the lens is controlled independently of channels or input signals.





Lens Settings		
1. Intelligent Lens System		<input checked="" type="checkbox"/>
2. Manual Zoom/Focus		<input checked="" type="checkbox"/>
3. Manual Lens Calibration		<input checked="" type="checkbox"/>
4. Auto Lens Calibration		<input checked="" type="checkbox"/>
5. Auto Lens Reset		
6. Lens Home Position Calibration Status		

FIGURE 3-50 - LENS SETTINGS

• **MANUAL ZOOM/FOCUS:**

When this control is selected, the holding current is removed from the zoom and focus motors so that they can be changed manually. *NOTE: Zoom and Focus should not be adjusted manually when this control is not selected, as this will result in damage to the motors.*

• **MANUAL LENS CALIBRATION:**

The lens calibration procedure is needed each time a new lens is installed in order for the ILS feature to perform reliably. This procedure calibrates; horizontal, vertical, focus, and zoom offset movements.

• **AUTO LENS CALIBRATION:**

Check this box to prompt for a lens calibration each time a lens is inserted. The user will always be prompted before starting the calibration.

• **AUTO LENS RESET:**

Check this box to initiate a ‘Lens Reset’ procedure on every power-up. This is useful if the lens is subject to manual movement between power sessions.

• **LENS HOME POSITION:**

Return the lens to the horizontal and vertical home position. Focus and zoom are unaffected.

• **LENS STATUS:**

This control displays the current lens calibration status.

**POWER MANAGEMENT**

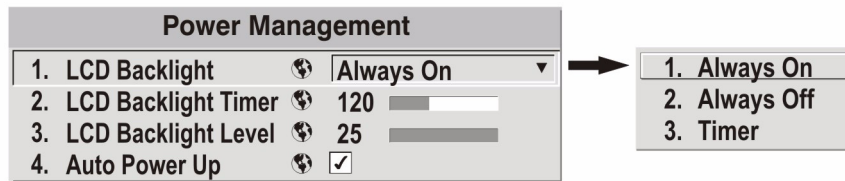

FIGURE 3-51 - POWER MANAGEMENT

• **LCD BACKLIGHT:**

The backlight for the LCD has 3 states. **Always On**, **Always Off**, or **Timer**. The backlight will turn on again when any key on the LCD is pressed or if an alarm is raised.

• **LCD BACKLIGHT TIMER:**

Set how long the LCD backlight stays on (in seconds) when in timer mode.

• **LCD BACKLIGHT LEVEL:**

Sets the LCD backlight brightness level. Maximum 25/Minimum 0.

• **AUTO POWER UP:**

When the A/C switch is turned on, the projector will automatically change from Stand-by Mode to Power On Mode. The projector will switch the lamp(s) on without waiting for further actions.

**DATE & TIME**

The current year-month-day, hour-minute-second, and timezone. Changes here reset the projector's real-time clock.

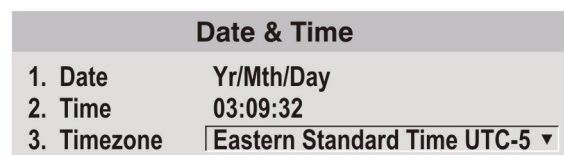

FIGURE 3-52 - DATE & TIME

**MENU PREFERENCES**

Adjust the appearance, content and/or location of on-screen menus and messages.

• **LARGE MENU FONT:**

Enter a checkmark to enlarge menus and their text. To adjust Menu Location to accommodate the increased menu area.

• **MENU LOCATION:**

Use the pull-down list to choose a pre-defined default or customized location for the display of all on-screen menus.



To create a custom menu location:

1. Choose a preset that is closest to the desired location.
2. Adjust “Horizontal Shift” and “Vertical Shift” slide bars to move the menu to the desired location.  
*NOTE: Avoid locations too close to a corner or edge to prevent cropping of larger menus.*



• **HORIZONTAL SHIFT AND VERTICAL SHIFT:**

Shift your menus as desired, creating a customized menu location.

• **DISPLAY CHANNEL LIST:**

Enter a checkmark to see a scrollable channel list whenever you press  from your presentation. Channels marked with a list icon  in the **Channel Setup** menu will appear here. The “Display Channel List” option also enables on-screen feedback when using the  key. To hide the channel list and input dialog box while switching channels and sources during a presentation clear the checkbox.  
*NOTE: The Channel List and input dialog box cannot be hidden during use of the menus.*

• **DISPLAY SLIDE BARS:**

Enter a checkmark to superimpose a small slide bar over the current image whenever an adjustable parameter is selected directly with a key such as  or . If “Display Slide bars” is unchecked, these slide bars can still be accessed, but will be hidden during adjustment. This option does not affect slide bars in menus.

• **DISPLAY ERROR MESSAGES:**

Choose how you want to be notified of errors detected in either the incoming signal or projector. Select “Screen” or “All” (default) to see brief on-screen messages. This is recommended during setup or testing of the projector. Or select “Serial Ports” to receive messages via RS232 or RS422 serial communication only. To hide error message displays, such as during shows and presentations, select “Off” or “Serial Ports”.

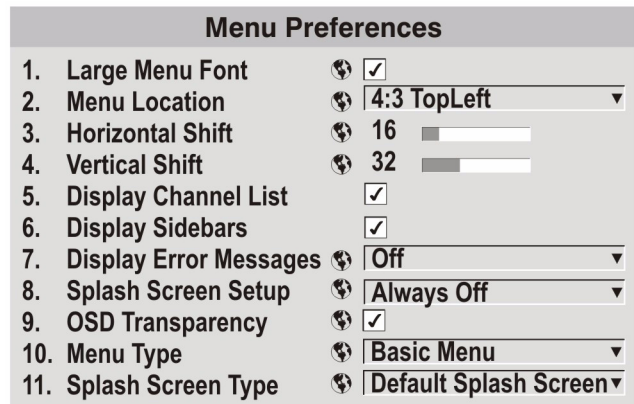

FIGURE 3-53 - MENU PREFERENCES

• **SPLASH SCREEN SETUP:**

Choose when to display a special introductory splash screen image, such as your company logo, graphic or message.

- **Always Off** – A splash screen never appears
- **Start-up Only** – The splash screen logo appears at projector start-up only.
- **Start-up And No Signal** – A splash screen appears at start-up and at any time when there is no signal.

To add your own splash screen in addition to the default “Christie logo” splash screen, use the Web UI to download the desired bitmap (.bmp) file to the projector. This will overwrite any other user splash screen that has been downloaded. *NOTE: Only one user splash screen can be saved in the projector.*

• **OSD TRANSPARENCY:**

Check this box if you want the OSD menu backgrounds to be transparent.

• **MENU TYPE:**

Select the **Basic** or **Advanced** menu type from this list box. The **Advanced** menu setting will give the menu options. The **Basic** menu setting will give a small number of the most frequently used menu items.

• **SPLASH SCREEN TYPE:**

Choose which splash screen is to be used; the default or user downloaded splash screen.



FIGURE 3-54 - SPLASH SCREEN TYPE

**SYSTEM CONFIGURATION - COMMUNICATIONS**

Defines and controls how single or multiple projectors are linked with each other and with a controlling device. For detailed information refer to *the Serial Command document provided in the Dealer Section of the Christie Website, PN 020-100224-XX.*

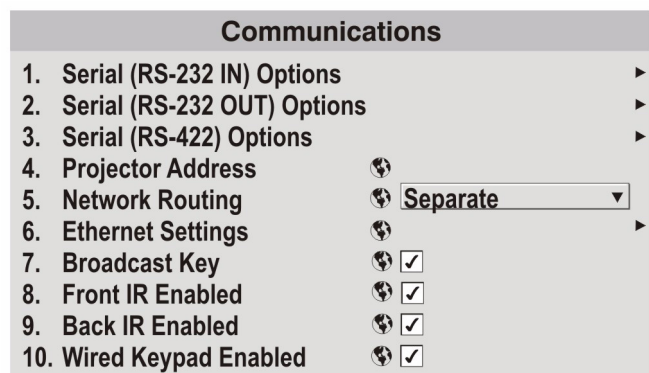





FIGURE 3-55 - COMMUNICATIONS

**SERIAL OPTIONS**

Serial (RS-232 IN) Options			
1. Baud Rate (RS-232 IN)	⊕	115200	▼
2. Serial Flow Control (RS-232 IN)	⊕	Software	▼
3. Serial Mode (RS-232 IN)	⊕	8N1	▼
4. Serial Protocol (RS-232 IN)	⊕	Christie Protocol	▼



FIGURE 3-56 - SERIAL OPTIONS

**Baud Rate**

Determines the speed of communication to and from the projector on the RS232 or RS422 links. The maximum rate for the RS232 is 115200; for RS422 it is 19200. Set the baud rate to match that of your controlling device, such as your PC. Refer to the documentation for the controlling device to determine the baud rate. In an existing network of projectors, if you discover that a projector has a different baud rate, use the pull-down list and select the correct baud rate using the  key. Do not scroll this control with  or  keys. Serial communication is always eight data bits, no parity.

**Serial Flow Control** - Determines whether software flow control or no flow control is used when transmitting and receiving data on the serial port.

**• PROJECTOR ADDRESS**

Enter a three-digit number (such as “001”) to assign or change a number to the projector currently in use. If the current projector already has a number assigned, that number will appear here (for example “004” in the menu shown below. Numerical identity for projectors enables you to communicate with a single projector within a multiple-projector application (see also  key in, [3.1 Using the Remote Keypad or Built-In Keypad](#)). If you make a mistake in assigning or changing the projector number, press  to cancel.

*NOTE: When multiple projectors are being used and you want to adjust the color for individual projectors to create one seamless image, you must assign different numbers for each projector to allow switching back and forth between projectors while adjustments are being made.*

• **NETWORK ROUTING**

*NOTE: Not applicable for stand-alone projectors or simple serial networks with only one type of controller and linking.*

1. <b>Separate</b>	= Networks do not communicate with one another
2. <b>RS-232 and RS-422 Joined</b>	= Serial networks are joined, but Ethernet is isolated
3. <b>RS-232 and Ethernet Joined</b>	= RS-232 and Ethernet are joined but RS-422 is isolated
4. <b>All Joined</b>	= Network communications travel all networks

FIGURE 3-57 - NETWORK ROUTING LIST

**Separate** - Select “**Separate**” (factory default) to keep RS232, RS422 and Ethernet messages on their respective paths instead of being broadcast to the other types of ports, refer to [2 Installation and Setup, Figure 2-18 - Connecting RS232, on page2-23](#) to [Figure 2-23 - Communicating To All Ports, on page2-27](#).

**RS232 and RS422 Joined** - Messages originating from an RS232 or RS422 controller will be relayed to all RS232or RS422 ports. Any Ethernet communication, however, will not.

**RS232 and Ethernet Joined** - Messages to and from the RS232 ports will also be relayed to the Ethernet port, and vice versa. Any RS422 communications will be isolated. In the case of multiple Ethernet sessions over the single Ethernet connector, input on the RS232 port will be relayed to all Ethernet sessions; however, input from any Ethernet session will only be relayed to the RS232 ports.

**All Joined** - All messages reach all ports, regardless of type in the case of multiple Ethernet sessions, input on one Ethernet session will be relayed to all other Ethernet sessions as well as to the RS232 and RS422 ports.

**ETHERNET SETTINGS**

*NOTE: Recommended for network administrators only.*

• **IP ADDRESS:**

Enter a valid and unique IP address for use on the network to which the projector is currently connected. This address will overwrite any previous IP address such as the projector’s factory-defined default. It takes approximately 10 seconds for the projector to respond at its new address.

Ethernet Settings	
1. IP Address	000.000.000.000
2. Port	3002
3. Subnet Mask	000.000.000.000
4. Gateway	000.000.000.000
5. Host Name	<input type="text"/>
6. Domain Name	<input type="text"/>
7. ArtNet Interface Settings	

FIGURE 3-58 - ETHERNET SETTINGS

• **PORT:**

On some Ethernet networks, firewall restrictions may require that the port number of the projector be changed from its default of 3002. If so, enter a new valid port number here. It is highly recommended not to use a port # below 1000, as these ports are typically reserved for and used by common IP applications.

• **SUBNET MASK:**

Subnet Mask determines the subnet for the IP address and must be set manually.

• **DEFAULT GATEWAY:**

This is the IP address of the gateway used to reach any non-local IP addresses; it must be set manually.

**ARTNET INTERFACE SETTINGS**

ArtNet is an Ethernet communication protocol that was developed by Artistic License. It is used for controlling lighting/staging equipment from a lighting console or PC application. It is based on the popular DMX512 control protocol.

• **ARTNET SUBNET:**

This is the highest level address for a device. Typically it is set to 0.

• **ARTNET UNIVERSE:**

Each packet of data is broadcasted to all devices plugged into a universe (up to 512 devices/channels).

• **ARTNET CHANNEL:**

There are 512 channels per universe. This control allows you to specify the starting channel for the projector.

• **ARTNET ADVANCED MODE:**

When this setting is enabled, each projector listens for data on 64 channels starting with the base channel. When advanced mode is not in use, the projector only listens on 10 channels. You can squeeze more devices per universe when the projector uses fewer channels.

DMX Channel	Function	Value	
Base	Shutter	0 - 64 65 - 192 193 - 255	Open No Action Closed
Base + 1	Slider Lock	0 - 254 255	Locked Unlocked*
Base + 2	Input*	1 - 8	Input #
Base + 3	Channel*	1 - 99	Channel #
Base + 4	Lens - Vertical*	0 1 - 254 255	Lens Down Stop Lens Up



Base + 5	Lens - Horizontal*	0 1 - 254 255	Lens Right Stop Lens Left
Base + 6	Lens - Focus*	0 1 - 254 255	Negative Focus Stop Positive Focus
Base + 7	Lens - Zoom*	0 1 - 254 255	Zoom Out Stop Zoom In
Base + 8	Power*	0 1 -254 255	Power Off No Action Power On
Base + 9	None		

*\* Functions are only active when the Slider Lock is set to Unlocked*

*NOTE: It is important the channels **DO NOT** overlap another device.*

**Example:**

<b>Good</b>	<b>Bad</b>
Proj1_ Base = 0	Proj1_ Base = 5
Proj2_ Base = 10	Proj2_ Base = 9
Proj3_ Base = 20	Proj3_ Base = 11

**DEVICE NAME:** This option is used to name each device. Some ArtNet servers support device queries.

**DEVICE DESCRIPTION:** More information that is returned when a “device query” has been done.

## SYSTEM CONFIGURATION - GEOMETRY AND COLOR

In the **Configuration** menu, select the **Geometry and Color** submenu when you need to modify overall color performance and/or image geometry for all sources.

- **TEST PATTERN:**

Choose the desired internal test pattern, or select OFF to turn off a test pattern. Alternatively, use the  key for cycling through test patterns.

- **RESERVED:**

No function.

- **COLOR ADJUSTMENTS BY X/Y:**

Enter known x/y coordinates from the chromaticity graph

*NOTES: 1) For defining or changing a User 1, 2, 3, or 4 color performance or “gamut”. Sometimes known as Comprehensive Color Adjustment™. 2) Factory-defined primary color levels, which ensure a specific color performance from projector-to-projector, can be calibrated in the **Service** menu only. The factory settings can be recovered with selection of “Reset to Factory Defaults?” in the **Color Primary Settings** submenu accessed via the **Service** menu (password-protected).*

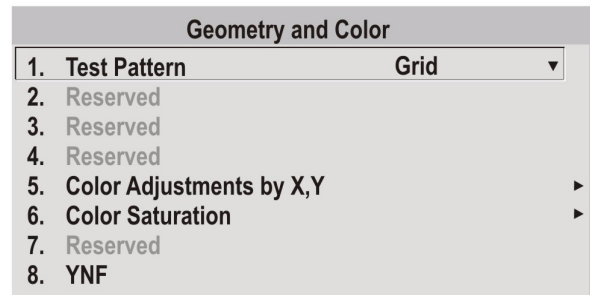
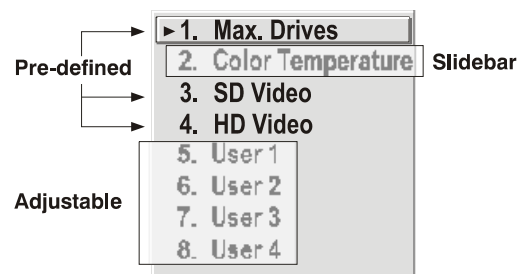

FIGURE 3-59 - GEOMETRY AND COLOR



From the factory, the projector can utilize any of the three pre-defined color performance settings identified at right (default=Max Drives), or colors can be driven on the basis of color temperature. For most applications, one of these gamuts will produce accurate and realistic colors from a variety of sources. They can be applied at any time in the **Advanced Image Settings** menu (“Select Color Adjustment”), and are not adjustable.

**DEFINING “USER” COLOR GAMUTS:** You may find the pre-defined “Select Color Adjustment” options do not suit your needs. For example, you may require a unique color gamut (range) for a single projector or application, or you may need to precisely match colors across multiple adjacent displays. In such cases, use the **Color Adjustments by X,Y** or **Color Saturation** submenu to define the precise *hue* of each primary color component (red, green, blue, and white) used to generate the millions of colors produced in displays. You can create up to four custom color gamuts (User 1, 2, 3, or 4) with these adjustments.

*NOTE: The two menus differ only in their user interface, so use whichever menu best suits your needs and application. A color meter can help with adjustments.*

**COLOR ADJUSTMENTS BY X, Y**

Use this submenu to create, alter or copy a color gamut (i.e., “color adjustment”). Controls in this menu define the precise hue of each primary color component (red, green, blue, and white) used to generate the millions of colors produced in displays. The x/y coordinates for each color define its location on the standard CIE chromaticity graph (see [Figure 3-61 - CIE 1931 Chromaticity Diagram \(without Yellow Notch Filter\)](#)). Changing either or both of these numbers will change the hue of the color, and relocate the “triangle” for possible colors. For example, changing the x/y coordinates for red may move the color closer to orange or closer to violet, which will in turn affect all displayed colors having a red component. Adjust the slide bars or enter new specific coordinates as desired to define or change up to four “User” color gamuts needed for your environment and applications. Apply at any time in the **Advanced Image Settings** menu.

Color Adjustments by X,Y	
1. Select Color Adjustment	User2
2. Color Temperature	6521 <input type="text"/>
Valid Color Space	Yes
3. Red X	<input type="text"/> 0.655
4. Red Y	<input type="text"/> 0.341
5. Green X	<input type="text"/> 0.332
6. Green Y	<input type="text"/> 0.575
7. Blue X	<input type="text"/> 0.144
8. Blue Y	<input type="text"/> 0.093
9. White X	<input type="text"/> 0.320
10. White Y	<input type="text"/> 0.330
11. Yellow Notch Filter	<input checked="" type="checkbox"/>
12. Auto Color Enable	<input checked="" type="checkbox"/>
13. Color Enable	Red <input type="text"/>
14. Copy From	Max Drives <input type="text"/>

FIGURE 3-60 - COLOR ADJUSTMENTS BY X, Y

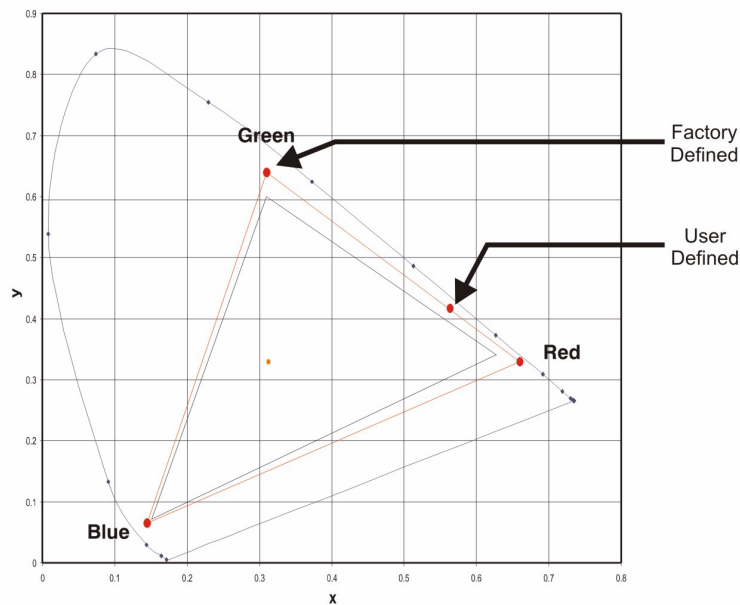

FIGURE 3-61 - CIE 1931 CHROMATICITY DIAGRAM (WITHOUT YELLOW NOTCH FILTER)

NOTE: Keep new x,y coordinates within the original color gamut triangle shown here.

### COLOR SATURATION

Adjust color slide bars and judge image color by eye or meter. A user-defined color “adjustment” can be applied by selecting it in the **Advanced Image Settings** menu (select ‘*Color Adjustment*’).

Use this submenu if you do not have specific color coordinates in mind and will judge color performance by eye or meter. Like the **Color Adjustment by X,Y** submenu, each color control actually defines new x/y coordinates for that color and changes its hue.

Adjust the hue of each primary color (red, green, blue, and white) by using more or less of it in relation to the other colors.

*NOTE: A Color Saturation adjustment defines the corresponding x/y coordinates shown in the Color Adjustment by X,Y submenu. These x/y coordinates will remain stable for this User gamut until they are changed again via either menu. Values displayed in the Color Saturation menu, will fluctuate as you use the projector, and will be different when you return to this menu in the future. These floating changes do not affect the x/y coordinates or gamut.*

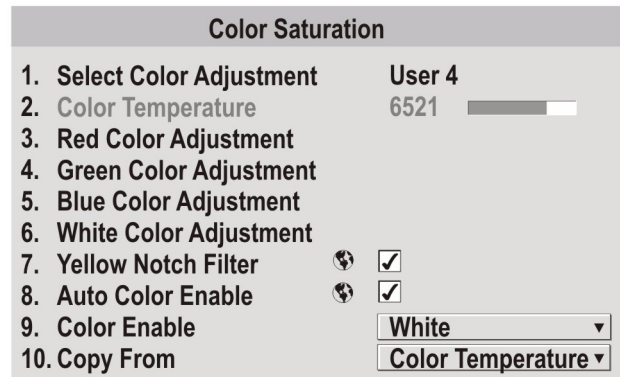

FIGURE 3-62 - COLOR SATURATION

#### Default Color Adjustments

Select the default values for the color adjustment without the Yellow Notch Filter. Refer to **System Configuration – Geometry and Color, Color Adjustments by X,Y** (below) for description.

- **DEFAULT COLOR ADJUSTMENT WITH YNF:**

Select the default values for the color adjustment with the Yellow Notch Filter. Refer to **System Configuration ->Geometry and Color ->Color Adjustments by X,Y**.

- **YELLOW NOTCH FILTER (YNF):**

Refer to [Image Settings Menu](#).

**SYSTEM CONFIGURATION - DIAGNOSTICS AND CALIBRATION**

• **TEST PATTERN:**

Choose the desired internal test pattern to display, or select OFF to turn off a test pattern.

Alternatively, use the  key for cycling through test patterns.

• **GREY LEVEL:**

Set the level of grey for displaying in the full gray field test pattern.

• **FREEZE IMAGE:**

Enter a check mark to freeze (stop) an image on a single frame. Use this diagnostic tool to examine in detail a still version of an incoming image that cannot be “frozen” at the source. For example, in moving images it is sometimes difficult to observe artifacts such as external de-interlacing/resizing and signal noise. Remove the checkmark to return to normal.

• **COLOR ENABLE:**

Select which color(s) you want to see. Use this while working with color temperature, input levels or other special setup parameters. Colors can be enabled/disabled by entering the corresponding function code listed on the back of the standard remote keypad.

• **RESERVED:**

No Function

• **INPUT PEAK DETECTOR:**

A fast method for defining individual input levels, and improving the accuracy of input levels set by the Auto Input Level function. Enabling the “**Peak Detector**” activates a special operating mode for detecting *only* pixels that are considered black or white—all other levels are displayed as a mid-level gray. When used with a 16-step grayscale pattern in which the two black and white bands are known to be at opposite edges of the image, you can watch these isolated areas while adjusting individual black levels and input drives until both bands are just visible. Images from this source will then display correct blacks and whites without crushing or washing out.

*NOTE: If using Peak Detector with PIP, both images must have the same color space.*

• **INPUT LEVEL DETECTOR:**

The “**Input Level Detector**” checkbox enables specific thresholds for blacks and whites. Input levels that fall below a specified level value (see below) are displayed as black, and all others are displayed as white. To use:

1. Enable “**Input Level Detector**” and display a continuous grayscale.
2. Set “**Input Level Value**” to near black (such as 200).

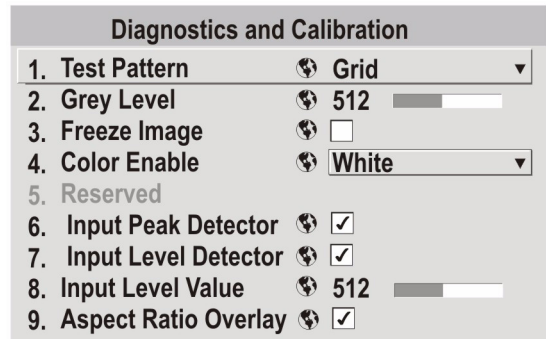

FIGURE 3-63 - DIAGNOSTICS AND CALIBRATION

3. Adjust Offsets to minimize area of black stripe.
4. Set “Input Level Value” to near white (such as 800).
5. Adjust Gains to minimize area of white stripe.

• **INPUT LEVEL VALUE:**

**Input Level Value** defines the value to be used by the **Input Level Detector** in recognizing blacks and whites. See **Input Level Detector**, above.

• **ASPECT RATIO OVERLAY:**

Check this box to display an overlay pattern over the image. The overlay shows the boxes corresponding to the size and shape of different aspect ratios.

### 3.6 WORKING WITH PIP OR INPUT SWITCHING

PIP and Input Switching are independent but related projector features that both utilize two image-processing paths within the projector. In the case of PIP, this double processing enables you to display two different images simultaneously – typically a smaller “secondary” image within a large “primary” background. In an input switch, the double processing occurs between displays so that a full image relayed from one source can smoothly transform into a full image from another source. This change can be instantaneous, or slowed so that the current image appears to dissolve or “fade” into the new image.

Options for enabling and controlling PIP and Input Switching reside in the same menu. Since both features utilize the projector’s double processing capability, PIP and Input Switching cannot be used together. For example, fading a pair of PIP images into a new display from a different source is not possible.

For best PIP or Input Switching results, use two *different* signal types as defined below. Do not mix two signals of the same type.

<u>SIGNAL TYPE</u>	<u>DESCRIPTION (INPUT LOCATION)</u>
#1	5 BNCs (RGBHV or YPbPr)
#2	DVI - I (analog or digital)
#3	Decoded signals (Composite video, S-Video, or any video signal via Input 1 BNC connectors or via an analog option card).
#4	Analog Option Cards
#5	Digital Option Cards
#6	Digital Option Cards

*NOTE: HD interlaced sources are not recommended for the PIP window.*

Tips to keep in mind:

- When using two digital signals or one analog and one digital, the pixel clock frequency of each must be no more than 165 megapixels.
- When using two analog signals, the pixel clock frequency of each must be no more than 90 megapixels.
- Input switching may affect image quality in some cases.

### 3.6.1 Input Switching & PIP Menu

Use the **Input Switching & PIP** menu to enable and define how you want to use PIP.

*NOTE: To control the primary image, access all picture controls through the **Main** menu. To control the secondary (PIP) image, access picture controls through the **Input Switching & Picture-in-Picture** menu.*

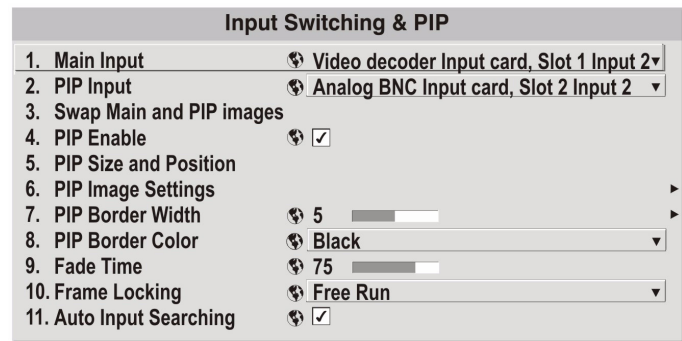

FIGURE 3-64 - INPUT SWITCHING & PIP MENU

- **MAIN INPUT:**

From the list of active inputs, select one to be used as the primary or main image.

- **PIP INPUT:**

From the list of active inputs, select one to be used as the secondary or PIP.

- **SWAP MAIN AND PIP IMAGES:**

Toggle the current PIP relationship so that the primary (main) image becomes secondary (PIP), and the secondary image becomes primary. Swapping is available only when PIP is enabled.

*NOTE: There may be a slight delay when swapping the Primary and Secondary images.*

- **PIP ENABLE:**

Short cut: Press **PIP** on the Remote if menu not present.

Toggle between displaying two sources at once (Main and PIP images) and the primary or main source only. This checkbox turns the secondary source on and off.

*NOTE: Disable PIP and Best Switching for Interlaced sources > 35kHz.*



### PIP SIZE AND POSITION

Most controls in the **PIP Size and Position** menu adjust the PIP (secondary) image in the same fashion as their counterparts in the main **Size and Position** menu.

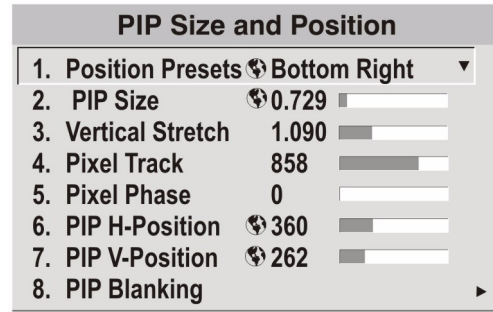

FIGURE 3-65 - PIP SIZE AND POSITION

- **POSITION PRESETS:**

Set the location of the PIP (secondary) image in the display.



FIGURE 3-66 POSITION PRESETS

### PIP BLANKING

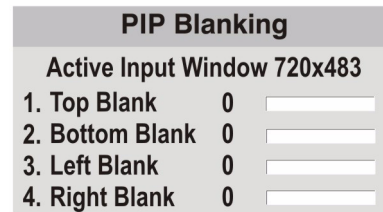

FIGURE 3-67 - PIP BLANKING

### PIP IMAGE SETTINGS

The controls adjust the PIP (secondary) image in the same fashion as their counterparts in the main **Image Settings** menu.

*Refer to [Image Settings Menu](#) for details of 1. Contrast to 7. Advanced Image Settings.*

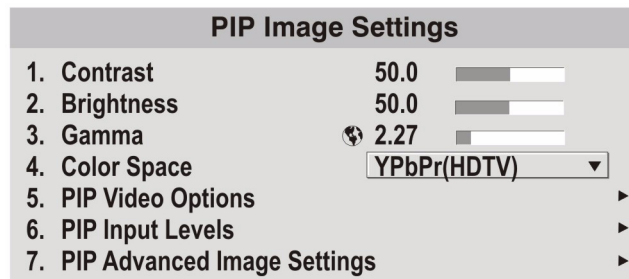

FIGURE 3-68 - PIP IMAGE SETTINGS

- **PIP BORDER WIDTH:**

Enables the optional border around the PIP image. When enabled, a one pixel-wide border will surround the PIP image. When disabled, no border will be displayed.

- **FADE TIME:**

Sets the amount of time (in seconds) it takes to fade between images on a source switch. If possible it fades in the PIP and OSD.



• **FRAME LOCKING:**

How the projector controls the output frame timing based on the input signal. When set to **FrameLock**, output image frames are locked to the input if possible. When Locked, the output is always locked to the primary input, never the PIP image. **Free Run** sets the output to close to 60Hz for all sources, This control must be set to Locked if a 3D-Stereo signal is used.



FIGURE 3-69 - FRAME LOCKING

• **AUTO INPUT SEARCHING:**

When enabled, the system will continually search for the next valid signal when no signal is present or when loss of sync occurs on the current user selected input. In the case of multiple signals to choose from, the order is based on slot, followed by inputs on that slot.

### 3.7 LAMP

• **LAMP OPERATION:**

Select the operational mode of the lamps. Auto-select mode will use the single lamp with the highest intensity. Lamp 1 and Lamp 2 Single Lamp modes will only use the lamp specified. Dual Lamp mode will use both lamps together.

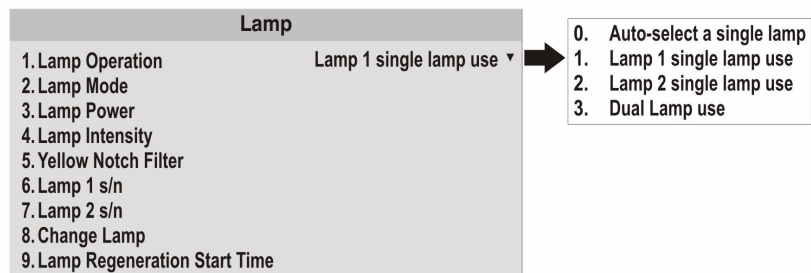

FIGURE 3-70 - LAMP MENU

If a lamp fails to strike on the first attempt, up to 3 more attempts to strike are made. In Dual Lamp operation, after 3 failed attempts to stay in Dual Lamp mode, it will switch to Single Lamp operation. In Auto-select Single Lamp operation, a failure will cause a switch to the other lamp. In Single Lamp operation, if the selected lamp will not strike, then the projector will not turn on.

• **LAMP MODE:**

Determines how the lamp power and intensity are controlled. If “**Maximum Brightness**” the lamp burns as brightly as possible. Select “**Constant Intensity**” mode to maintain a specific brightness level over time. As the lamp ages, the projector will increase power as needed to closely maintain the required output from the lamp. Select ‘**Constant Power**’ to specify the power level supplied to the lamp. Both ‘**Constant Intensity**’ and ‘**Constant Power**’ modes extend lamp life.



FIGURE 3-71 - LAMP MODE

• **LAMP POWER:**

Set the lamp power in Watts. The Power control represents the amount of power sent to the lamps. Power increases when operating in Intensity mode, until it reaches its maximum. The value remains stable when in Max Brightness or Power mode. If using Power mode, setting a lower power level reduces brightness and extends lamp life.

- **LAMP INTENSITY:**

Adjust the lamp intensity to % of full. This value is used as a target value by the LiteLOC™ system to maintain constant intensity.

- **YNF:**

Refer to [Image Settings Menu](#).

- **LAMP S/N (LAMP 1 and LAMP 2):**

Enter the serial number for the specified lamp. This will apply the serial number to the current lamp statistics file. It will not perform the archiving as done by the **CHANGE LAMP** function.

- **CHANGE LAMP:**

Informs the projector that a lamp has been changed. This allows the serial number of the new lamp to be entered.

Lamp serial numbers are used for keeping statistics on each lamp used in each lamp position. Entering of serial numbers is optional, but is recommended.

When using this function, the statistics for the previous lamp will be archived, and new statistics will be started for the new lamp. If this function is not used statistics will be cumulative, for both the new and old lamps combined.

- **LAMP REGENERATION START TIME:**

To extend lamp life, a lamp cannot operate continuously for more than 24 hours. Every 24 hours each lamp has to switch off for a regeneration period, by default a 15 minute period. This option allows you to set the time of day (hh:mm:ss) that the lamps can switch off. If operating with a specific single lamp, the lamp will switch off and there will be no image for the duration of the regeneration. If operating in Auto-select single lamp mode, the other lamp will be switched on for the duration of the regeneration, so that 24/7 operation may be maintained.

## 3.8 STATUS

The read-only **Status** menu lists a variety of details about the standard and optional components currently detected in the projector. Refer to the **Status** menu for versions of hardware and software installed, the type (size) of lamp, the hours logged in total and for a specific period (such as a rental period), and for your projector model name and serial number. In addition, the **Status** menu identifies the current channel, its location, its frequencies and other details.

### 3.9 USING MULTIPLE PROJECTORS

**IMPORTANT:** When working with more than two projectors, work left to right, top to bottom.

When an installation requires multiple projectors, use the RS232 serial ports to daisy chain the units together and control the group with a single keypad or a computer/controller connected to the first projector. In such a network, you can choose to broadcast commands to the entire group, or use the **[Proj]** key as desired to limit responses to an individual projector.

Alternatively, you may want to add projectors to a hub on an Ethernet network. See [Figure 2-21 - Mixed Network](#) for full routing details.

#### MATCHING COLORS IN MULTIPLE SCREENS

In a multiple-projector wall, you will likely want to precisely match color and intensity from image-to-image so that the full wall is as uniform as possible.

##### Preliminary Calibration

All primary colors in the projector are precisely set to pre-established values to ensure that overall color performance is optimized and is as accurate as possible. Lighting and other environmental factors may slightly change how these colors appear on your screen. While the change is negligible in most cases, you may prefer to recover the originally intended color performance before trying to match colors from several projectors.

To achieve consistency use a color meter to measure the native primary colors—red, green, blue, and white—as they appear at the screen. Record these as *Color Primary Settings* in the **Service** menu (password-protected) for each projector. On the basis of these new values, which are stored in memory, each projector will then automatically calculate any necessary corrections to reproduce the original factory colors under the current environmental conditions. This essentially calibrates a projector to its surroundings, compensating for factors such as screen type; lamp and/or ambient lighting and will improve color accuracy and consistency in a group of projectors. It ensures a good starting point for further customizing and matching; however, is not critical for all installations.

To access the **Service** menu (password-protected) return to the factory-set color primaries. Select the “Reset to Factory Defaults?” option in the **Color Primaries** submenu. Then repeat the calibration process describe above and continue with matching of colors.

##### Color Adjustment Procedure

Once the *Color Primary Settings* are calibrated for the site (see above), use the **Color Adjustments by X,Y** or **Color Saturation** menu to further refine each projector’s fundamental colors so that the hue and intensity of each color appears the same from one display to another. Once matched, you will have created a single new shared range of colors or “color gamut” that all of your projectors can produce. This palette—named User 1, 2, 3 or 4—can be applied or disabled for a source at any time throughout a bank of adjacent displays, simplifying both the setup and maintenance of a “seamless” wall.

1. Set up and optimize all projector settings. You can ignore color temperature, since you will be redefining color performance in this procedure, but do optimize each projector in every other aspect. Closely align all screen edges.
2. Assign projector numbers to make communications easier. Use desired keypad.
3. Use the same lamp mode for all projectors, and do the following:
  - Set *Select Color Adjustment* to “Max Drives”
  - Display a full white test pattern
  - Adjust lamp power and Optical Aperture until adjacent white fields appear the same brightness.
4. Display the **Color Adjustments by X,Y** menus for all projectors. Each menu shows the x/y coordinates defining the “Max Drives” color gamut for this projector. *NOTE: The values shown in one (any) of the displays. Use the “Copy From” function to copy them into a “User” gamut in one projector.*

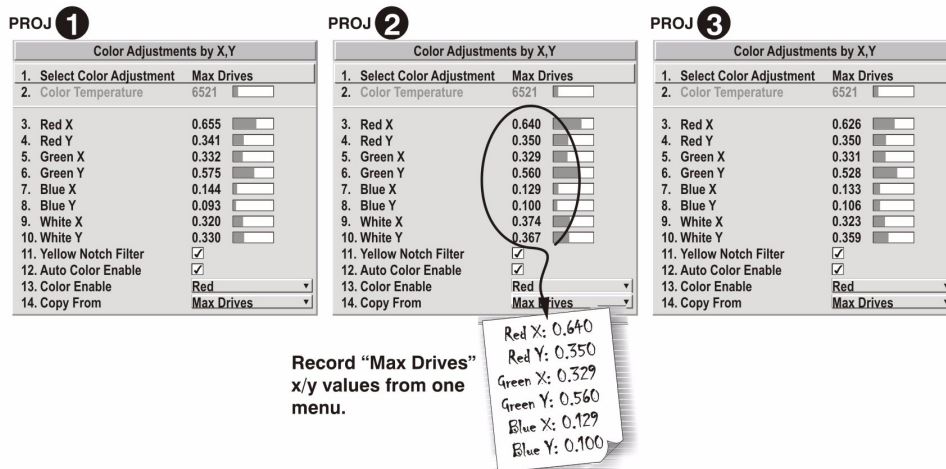

FIGURE 3-72 - JOT DOWN A SET OF “MAX DRIVES” X/Y VALUES

5. In each projector, select a “User” color adjustment (1-4) to enable *Color Adjustments by X,Y* changes. Then enter your recorded x/y values into each menu.

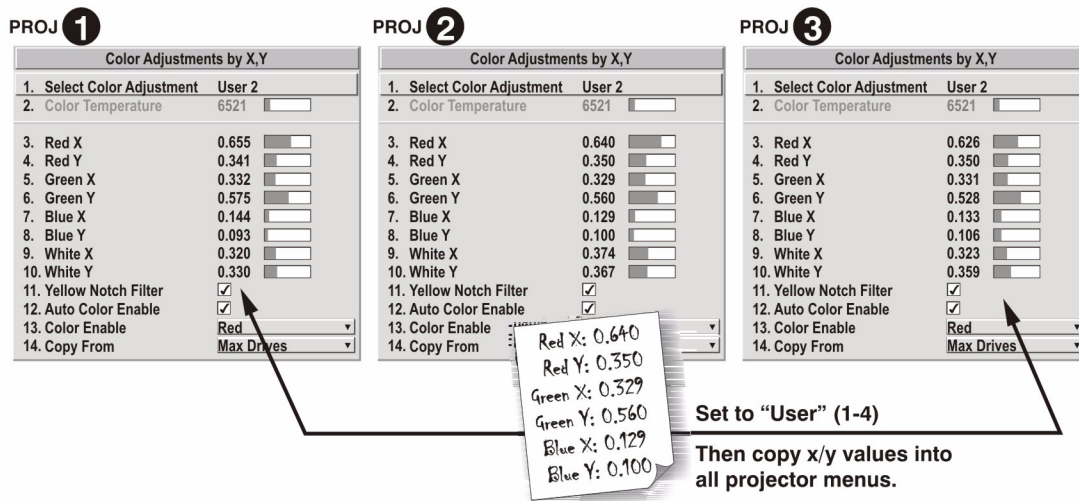

FIGURE 3-73 - COPY X/Y VALUES INTO ALL PROJECTORS

6. In each projector, judge by eye and adjust x/y coordinates slightly in the following manner:

- To match reds, decrease “Red X” until full field red screens match.
- To match greens, decrease “Green Y” until full field green screens match.
- To match blues, increase both “Blue X” and “Blue Y” until full field blue screens match.

*NOTE: For speed, enable the “Auto Color Enable” checkbox. Each color coordinate you select will then automatically trigger a full field display of the corresponding color.*

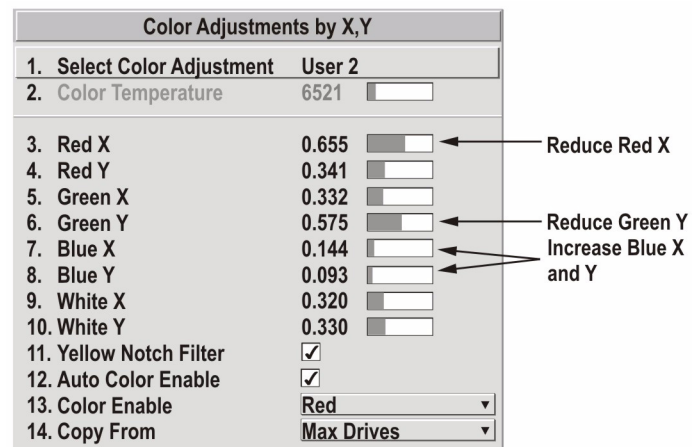

FIGURE 3-74 - COLOR ADJUSTMENT

Alternatively, use the **Color Saturation** menu for these adjustments or to fine tune.

These coordinate adjustments move the three color points closer together (see below) to establish a “shared” gamut attainable by all projectors in your group. Adjust only as necessary to ensure that the resulting color palette is as large as possible. When done, you may need to adjust lamp power slightly.

7. All screens should now be color-matched. Apply this new “User” gamut to a source at any time by selecting it in the “Select Color Adjustment” list accessed in the **Advanced Image Settings** menu.

### Using the Color Saturation Menu for Color Matching

To use the **Color Saturation** menu to match colors across multiple screens. In the three Color Adjustment submenus (Red, Green, Blue, and White—see right), set all main values to 1000 and the secondary values to 0, if applicable. Then judge by eye and adjust the slide bars as needed. *NOTE: Adjustments here define new x/y coordinates in the Color Adjustments by X,Y menu.*

For best results, use this menu after doing the color adjustment procedure.

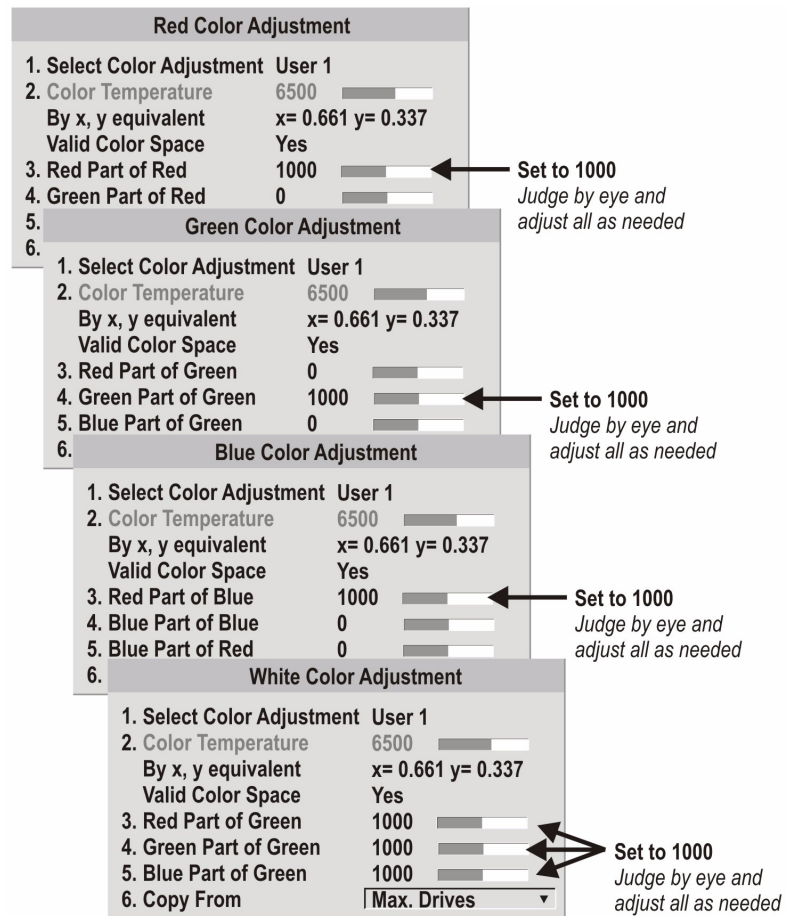

FIGURE 3-75 - COLOR MATCHING USING COLOR SATURATION MENU

## 3.10 REMOTE CONTROL OF THE PROJECTOR

As an alternative to using a keypad, most projector functions can be controlled remotely, typically at a controller such as a PC, via a web interface.

**VIA ASCII MESSAGING** — Connect a serial link between your controller and the RS232 or RS422 port (recommended), or open an Ethernet socket (i.e., Telnet) between your controller and the valid projector address. Valid ASCII codes and messages are documented in the *Christie Serial Communications* document available at the Christie website.

**VIA WEB INTERFACE** — Connect the PC to the projector's Ethernet port. In the web browser (i.e., Internet Explorer), enter the IP address of the projector you wish to control. This will prompt a login screen. The default login id and passwords are: admin; admin, service; service, guest; guest. Up to a maximum of 3 users can connect at any given time. Two users can use the same account to log in. Each user will see a different set of tabs. The default passwords can be edited by an administrator or a

service user in the Admin tab. Guest users will not see this tab. Basic operations of the projector can be controlled from this interface and the Virtual OSD can be accessed from here.

### 3.11 ALARM CONDITIONS

An alarm condition consists of a message that is on the LCD display located beside the built-in keypad, see [Figure 3-76 - Example of Alarm Condition](#).

There are two types of alarm conditions:

Warning Alarm; and

Critical Alarm

A warning alarm is shown when an error or a non-optimal condition has occurred. That will generally not prevent the projector from operating. An example is when a temperature is slightly elevated.

A critical alarm is shown when a condition occurs that could prevent the projector from operating and could cause damage to the projector. This may cause the projector to shut down automatically. An example would be a fan not running.

Both alarm types display:

- the item of alarm
- the status of the item

The item of the alarm can be either physical, i.e. fan or sensor, or the alarm can be a software issue, i.e. lamp driver. The LCD displays the status of the item and its units; if applicable. If the status of the item is out of normal range an alarm is created. When the status of the item is within normal range the alarm will clear.

*NOTES: 1) When an alarm is displayed in the LCD display, the built-in keypad is disabled. To confirm the alarm, press the OK soft key to enable the built-in keypad. 2) The alarm condition can also be viewed using the remote in the read only Status menu.*

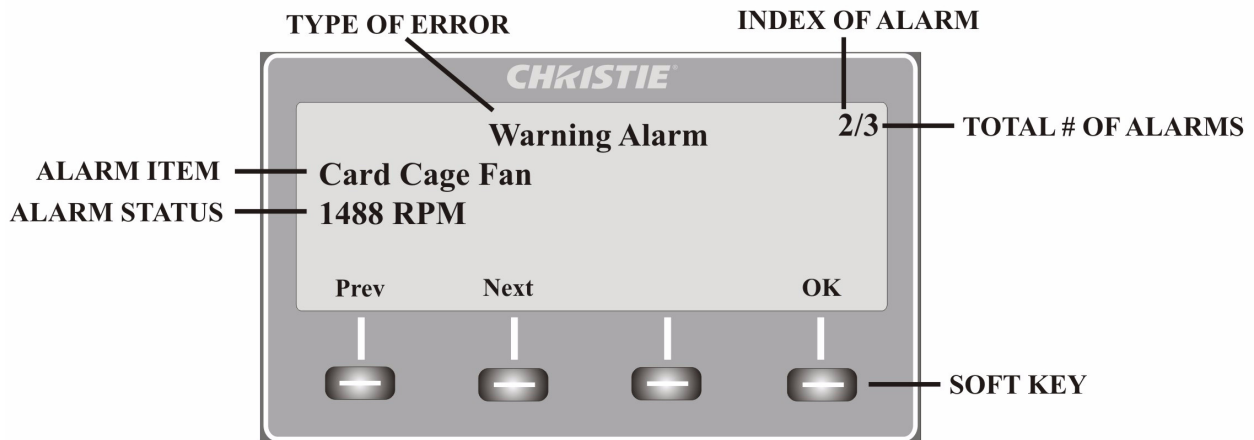

FIGURE 3-76 - EXAMPLE OF ALARM CONDITION

# 4

# *Maintenance*

Installers, service trained operators and all other users must maintain a safe operating environment at all times. Read through this section in its entirety and understand all warnings and precautions before attempting to operate this projector.

- *4.1 Safety Warnings and Guidelines*
- *4.2 Maintenance of the Cooling System*
- *4.3 Maintenance of Optics*
- *4.4 Replacing the Lamps*



## 4.1 SAFETY WARNINGS AND GUIDELINES

### 4.1.1 GENERAL PRECAUTIONS



Do **NOT** look into the lens

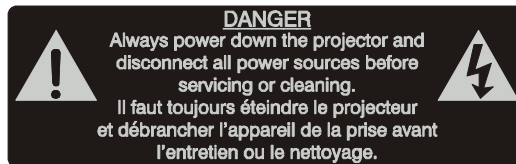

#### **WARNING**

**FIRE HAZARD.** Keep hands, clothes and all combustible material away from the concentrated light beam of the projector. Position all cables where they cannot contact hot surfaces or be pulled or tripped over.

#### **WARNING**

All installation and maintenance procedures must be performed by a qualified technician.

#### **WARNING**

Projector must be operated in an environment that meets operating specifications, as listed in Section [6 Specifications](#).

#### 4.1.2 AC /POWER PRECAUTIONS

 **WARNING**

Use only the AC power cord supplied. Do not attempt operation if the AC supply and cord are not within the specified voltage and power range. Refer to the license label on the back of the projector or Section [6 Specifications](#) for rated voltage and power.



**WARNING**

The projector is equipped with a 3-wire plug with a grounding pin. This is a safety feature. If you are unable to insert the plug into the outlet, contact an electrician to have the outlet replaced. **NEVER** defeat the safety purpose of the grounding-type plug.

 **WARNING**

Do not allow anything to rest on the power cord. Locate the power cord where persons walking on it or objects rolling over it cannot damage the cord.

#### 4.1.3 LAMP PRECAUTIONS



**DANGER: LAMPS MAY EXPLODE-POSSIBLE BODILY HARM OR DEATH**

The lamps are under pressure and may explode causing physical injury and/or property damage. Allow the lamps to cool before handling or unplugging the projector. Lamp replacement to be done by qualified service personnel; consult *User Manual* or lamp kit for instructions.

 **WARNING**

Never attempt to access the lamp while the lamp is ON. After turning the lamp OFF, it is crucial that you wait at least 10 minutes before handling the lamp. This provides sufficient time for the lamp cooling fans to properly cool the lamp. For all other precautions critical for safe removal and replacement of the lamp, refer to [4.4 Replacing the Lamps](#).

## 4.2 MAINTENANCE OF THE COOLING SYSTEM

The high-intensity lamps and electronics rely on a properly functioning cooling system. Regular maintenance of the cooling system is critical to prevent overheating and sudden projector failure and helps ensure reliable operation.

### 4.2.1 VENTILATION

Vents and louvers in the projector covers provide ventilation, both for intake and exhaust. Never block or cover these openings. Do not install the projector near a radiator or heat register, or within an enclosure. To ensure adequate airflow around the projector, with a minimum clearance of 25cm (10") on the left, right and rear sides of the projector from any walls or other obstructions. *NOTE: Do not obstruct the air exchange to the projector.*

### 4.2.2 OPTIONAL FILTERS



#### WARNING

**Use only special, high efficiency Christie approved filters.**

#### Dust Air Filter

*CHECK: Monthly*

Check projector air dust filters, at minimum, every month.

Dust air filters (if fitted), should be replaced whenever the lamp is replaced or between 200-500 hours, depending on use. A clogged air filter reduces air flow and can lead to overheating and failure of the projector. Check monthly by inspecting its color through the side vent grille with a flashlight. Replace grey colored filters. Leave the filters in their sealed packaging until ready for use.

#### Replace Filters:

1. Unscrew the 2 captive screws at the top of each filter door (Figure 4-1). Allow the door to rest down and away from the projector.
2. Slide the air filter out replace, vacuum or wash the filter. Wash using mild soap and water. *NOTE: Dry the filter before using.*
3. Insert the new or clean air filter.
4. Secure the filter door by tightening the 2 captive screws loosened in Step 1.

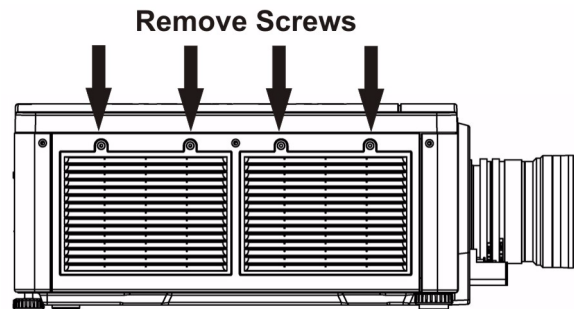

FIGURE 4-1 - REPLACE FILTER

### 'Fog Oil' Filter

'Fog Oil' filters should be replaced after each use of the projector to a maximum of 20 hours. The life of the filter is approximately 20 hours based on environmental conditions. Leave the filters in their sealed packaging until ready for use. *NOTE: The 'Fog Oil' filters cannot be re-used or they will clog up with oil and the projector will overheat and shutdown.*

#### REPLACE:

1. Unscrew the 2 captive screws at the top of each filter door (Figure 4-1). Allow the door to rest down, away from the projector.
2. Slide the filter (or dust air filter, if fitted) out.
3. Insert the new air fog oil filter with the white layer facing into the projector. *NOTE: Each filter is a two-stage filter; the black activated charcoal layer faces out, and the white layer faces the projector.*
4. Secure the filter door by tightening the 2 captive screws loosened in Step 1.

## 4.3 MAINTENANCE OF OPTICS

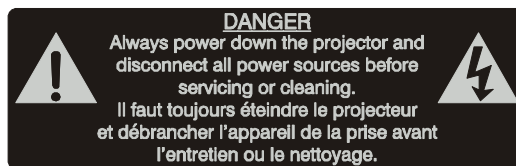

### 4.3.1 OPTICAL (EXCLUDING LENS)

Unnecessary cleaning of optics, increases the risk of degrading delicate coatings and surfaces. Only clean optics when dust, dirt, oil, fingerprints or other marks are obvious and are causing performance problems. Maintenance of optical components requires a qualified service technician. Inspect exposed optical surfaces periodically in a clean, dust-free environment using a flashlight. **Never touch** an optical surface with your bare hands. Always wear latex lab gloves.

#### Supplies or Cleaning Optical Surfaces

- Soft camel-hair brush
- Dust-free blower - filtered dry nitrogen blown through an anti-static nozzle.
- Dust-free lens tissue, such as Melles Griot Kodak tissues (18LAB020), Optowipes (18LAB022), Kim Wipes or equivalent
- *For lens only.* Lens cleaning solution, such as Melles Griot Optics Cleaning Fluid (18LAB011) or equivalent.
- Cotton swabs with wooden stems only
- Lens cleaning cloth/microfibre, such as Melles Griot (18LAB024) or equivalent

### 4.3.2 CLEANING THE LENS

Check periodically. A small amount of dust or dirt on the lens has minimal effect on image quality. To avoid the risk of scratching the lens, **clean only if absolutely necessary**.

Dust:

1. Brush most of the dust from the lens with a camel-hair brush and/or blow dust away with a dust-free blower.
2. Fold a microfibre cloth smooth and gently wipe remaining dust particles from the lens. Wipe evenly with the smooth portion of the cloth that has no folds or creases. Do not apply pressure with your fingers - use the tension in the folded cloth itself to collect dust.
3. If significant dust is still bound to the surface, dampen a clean microfibre cloth with coated optics cleaning solution (damp, not dripping). Wipe gently until clean.

Fingerprints, smudges, or oil:

1. Brush away most of the dust with a camel-hair brush and/or blow away using a dust-free blower.
2. Roll a lens tissue around a swab and soak it in coated optics cleaning solution. Tissue should be damp, but not dripping.
3. Gently wipe the surface using a figure-8 motion. Repeat this motion until the blemish is removed.

### 4.4 REPLACING THE LAMPS



**DANGER: LAMPS MAY EXPLODE-POSSIBLE BODILY HARM OR DEATH**

The lamps are under pressure and may explode causing physical injury and/or property damage. Allow the lamps to cool before handling or unplugging the projector. Lamp replacement to be done by qualified service personnel; consult *User Manual* or lamp kit for instructions.

**1. To turn off lamp:**

Turn off the lamp by a lamp **OFF** command or by opening the lamp door. *NOTE: The lamp will turn off automatically when the lamp door is open.*

**2. To open the lamp door:**

Using a Phillips screwdriver turn the 1 captive screw on the lamp door counter-clockwise to access the lamp compartment. *NOTE: When the door is open, the lamp will shut off.*

**3. Wait**

Wait at least 10 minutes before handling the lamp, to allow the lamps to cool.

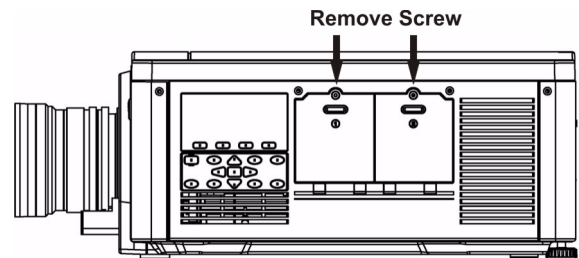

FIGURE 4-2 - REPLACE LAMP

**4. Remove the old lamp.**

- a. Unscrew the 3 captive screws securing the lamp using a #1 Phillips screwdriver.
- b. Carefully remove the lamp from the projector. Place the old lamp in a location where it cannot fall or be bumped.

 **WARNING**

**Handle lamps with extreme caution. Dispose of lamps according to safety regulations for your area.**

**5. To use lamp OFF command:**

- a. In the lamp menu, select **CHANGE LAMP**. This will prompt for the old lamp serial number (if it was not previously entered).
- b. Enter the new lamp serial number.

*NOTE: This action is not mandatory, it is recommended for accurate lamp statistics to be archived.*

**6. Install the new lamp:**

- a. Take precaution to align the new lamp properly in the correct orientation inside the projector.
- b. Press firmly to seat the lamps, ensuring the lamp is secure.
- c. Using the Phillips screwdriver and captive screws secure the lamp door and tighten the captive screw.

*NOTES: 1) If the lamp was turned off with the **OFF** command in step 1, it will have to be manually turned on. 2) If the lamp was turned off by opening the door, then it will automatically turn on again when the door is closed.*

# 5

# Troubleshooting

If the projector is not operating properly, note the symptoms and use this section as a guide to resolve the problem. If the problem cannot be resolved, contact your dealer for assistance. *NOTE: A qualified service technician is required when opening an enclosure to diagnose any “probable cause”.*

- [5.1 Power](#)
- [5.2 Lamp](#)
- [5.3 LCD](#)
- [5.4 Remote Keypad](#)
- [5.5 OSD](#)
- [5.6 Ethernet](#)
- [5.7 Displays](#)

## 5.1 POWER

### 5.1.1 Projector Does Not Power ON

1. **Ensure projector is plugged in?** Check power switch above power cord is in the ON position.
2. **Check that the Status LEDs are ON.** While the projector is busy initializing, the LEDs should be cycling. When finished initializing, the Power and Shutter LEDs (the two on the right) should be on.
3. **Check the LCD display.** While the projector is busy initializing, the display should show “Please wait”. When finished initializing, the display should show “Standby mode”.
4. Check the LCD display for any warnings or errors.

## 5.2 LAMP

### 5.2.1 Lamp Does Not Ignite

1. **Is there an interlock failure?** Check the LCD display for an error. If the other lamp has ignited and an image can be seen, use the remote keypad and check the **Status** menu for any errors and for the Lamp door interlock status. If not lamp has ignited, use the Virtual OSD on the web interface to check these items. The interlock failure could be an open lamp door or a failed lamp fan.
2. If a DMD temperature is too high, the lamp will not ignite. Cool the projector and try again. Ensure there is proper ventilation. If an optional exhaust is used ensure it has adequate airflow. Using the remote keypad or Virtual OSD as above, check the lamp mode in the **Lamp** menu. This may be set to a single lamp or dual lamp mode. Check in the **Status** menu what the reported mode is.
3. For suspected communication failures, power-down the projector and try again.
4. If the lamp does not ignite after the second attempt and after powering down and up again (complete AC power down, then replace the lamp.

### 5.2.2 Lamp Suddenly Turns OFF

1. Check lamp power through the remote keypad checking the **Lamp** menu or from the web user interface **Advanced: Lamp** menu. Try increasing lamp power.
2. The DMDs may be overheated. Check for an alarm condition on the LCD keypad display.
3. Replace the lamp.

### 5.2.3 Flicker, Shadows Or Dimness

1. Check lamp power through the remote keypad checking the **Lamp** menu or from the web user interface **Advanced: Lamp** menu. Try increasing lamp power.
2. Replace the lamp.



### 5.2.4 LiteLOC™ Does Not Seem to Work

1. Ensure LiteLOC™ is set and enabled in the **Advanced: Lamp** menu, via the web user interface or using the remote keypad check the **Lamp** menu.
2. If the lamp power has increased to its maximum in order to maintain a LiteLOC™ setting, LiteLOC™ is automatically terminated. If the values shown in the Lamp menu indicate that the lamp power has reached this “over-drive” state, either reduce your LiteLOC™ setting or install a new lamp.

## 5.3 LCD

### 5.3.1 Blank Screen, No Menu Displaying

1. The LCD should never be blank regardless of power state.
2. Press any arrow key on the built-in keypad. The backlight on the LCD and the backlight for the built-in keypad should turn on. If the LCD is still blank, restart the projector.

## 5.4 REMOTE KEYPAD

### 5.4.1 Remote Keypad Does Not Seem to Work

1. Replace the batteries.
2. Check if IR signals are received by the projector. Pressing any key on the remote control towards the front or rear sensor, the PWR status LED will blink, regardless if any command is executed. If the LED does not blink, restart the projector.
3. Ensure the remote keypad is enabled. If the projector is powered, using the built-in keypad, open the OSD menu and go to the Main Menu>Configuration>Communication submenu and check the checkboxes for Front IR Enabled and Rear IR Enabled are checked. Enable them if they were disabled and try again.
4. Projector is busy. If the projector is busy in a warm-up mode or in a cool-down mode, the commands from the remote keypad may be ignored. Wait until the projector reaches a stable state (Power ON or Stand By) and try again.
5. Press the *PROJ* key on the remote keypad. If this brings up a pop-up box on the OSD, ensure that the checkbox is marked to enable the projector.
6. Using the XLR connector, use the remote as a “wired” keypad. If it does work and all the IR sensors have been enabled, then there may be a problem with the IR sensors.

## 5.5 OSD

### 5.5.1 The OSD Menu does not display

1. Using the LCD, ensure that OSD Menu is enabled, scroll down until the item OSD is displayed. LCD read “OSD : off” press and hold the OSD soft key on the built-in keypad. The LCD will read “OSD on” and press Menu key

OR

2. Press and hold OSD key on the remote keypad for 2-3 seconds, then press the Menu key on the remote keypad.

## 5.6 ETHERNET

### 5.6.1 Trouble Establishing Communication with Projector

1. Ensure any address changes have been saved, and reboot to implement. If you still have trouble establishing communications with a projector added to an existing Ethernet network, the projector's IP address is likely in conflict with another address already in use. Contact your network administrator.
2. Ensure Ethernet settings are valid for the site. All devices should have the same subnet mask yet unique IP addresses.

## 5.7 DISPLAYS

### 5.7.1 The projector is on but there is no display

1. Was a lens cover accidentally left on? Remove lens cover.
2. On the LCD display, check that the shutter is open. This will also be indicated by the shutter LED being green.
3. Is the correct input selected. Check cable connections.
4. Check if menus appear on the screen.
5. Can you access test pattern? Ensure a full black test pattern has not been selected for display, press Menu to access test patterns, then cycle patterns with keys. Check your source connections again.

### 5.7.2 Severe Motion Artifacts

1. Most likely there is a synchronization problem with reversed 3-2 pull-down in 60Hz-to-24Hz film-to-digital conversion in your source. Correct at the source.
2. Set the projector to run in Free fun. Open OSD menu and go to Input Switching & PIP. Ensure that running mode is set to Free run not to Frame Lock.
3. Display a test pattern on the screen, pressing the Test button on the remote keypad. The test pattern should be displayed correctly. If not, contact your dealer for assistance.

### 5.7.3 Image Appears 'Squeezed' or Vertically Stretched into Center of Screen

1. Run auto setup, pressing Auto button on the remote keypad.
2. Check your Resizing selection.

#### **5.7.4 The Display is Jittery or Unstable**

1. If the display is jittery or blinking erratically, ensure that the source is properly connected and of adequate quality for detection. With poor quality or improperly connected source, the projector will repeatedly attempt to display an image, however briefly.
2. The horizontal and vertical scan frequency of the input signal may be out of range for the projector. Refer to Section [6 Specifications](#) for scan frequency ranges.
3. The sync signal may be inadequate. Correct the source problem.

#### **5.7.5 The Display is Faint**

1. Brightness and/or contrast and/or gamma may be set incorrectly.
2. The source may be double terminated. Ensure the source is terminated only once.
3. The source (if non-video) may need a different sync tip clamp location.

#### **5.7.6 The Upper Portion of the Display is Waving, Tearing or Jittering**

This can occur with video or VCR sources. Check your source.

#### **5.7.7 Portions of the Display are Cut OFF or Warped to the Opposite edge**

Resizing may need adjustment. Adjust until entire image is visible and centered.

#### **5.7.8 Display Appears Compressed (Vertically Stretched)**

1. The frequency of the pixel sampling clock is incorrect for the current source.
2. Sizing and positioning options may be adjusted poorly for the incoming source signal.
3. Use an anamorphic lens for typical HDTV and anamorphic DVD sources that have been re-sized and vertically stretched, via 3rd-party software.

#### **5.7.9 Data is Cropped from Edges**

To display the missing material, reduce image size to fill the display area available in the projector, then stretch vertically to fill the screen from top to bottom. Add the anamorphic lens to regain image width.

#### **5.7.10 Display Quality Appears to Drift from Good to Bad, Bad to Good**

1. The source input signal may be of low quality.
2. The H or V frequency of the input may have changed at the source end.

#### **5.7.11 Display has Suddenly Frozen**

If the screen blacks out inexplicably, it is possible that excessive voltage noise on the AC or ground input has interrupted the projector's ability to lock on to a signal. Power down the projector and disconnect from AC. Then plug in again and power up as usual.

### 5.7.12 Colors in the Display are Inaccurate

1. The color, tint, color space and/or color temperature settings may require adjustment at your input source.
2. Try Auto Setup.
3. Ensure signal connections are correct.
4. Ensure the proper channel for this source is being used.

### 5.7.13 Values in Color Saturation slide bars vary overtime

1. Once defined, Color Saturation slide bar values fluctuate over time and will likely be different upon subsequent visits to this menu. This is normal and should be ignored, as these changes do not redefine the x/y coordinates or color gamut.

### 5.7.14 Display is Not Rectangular

1. Check leveling of the projector. Ensure the lens surface and screen are parallel to one another.
2. Is the vertical offset correct? Make the necessary adjustments to the vertical offset on the lens mount.

### 5.7.15 Display is "Noisy"

1. Display adjustment at the input source may be required. Adjust pixel tracking, phase and filter. Noise is particularly common on YPbPr signals from a DVD player.
2. Ensure the video input is terminated (75 S). If it is the last connection in a loop-through chain, the video input should be terminated at the last source input only.
3. The input signal and/or signal cables carrying the input signal may be of poor quality.
4. If the distance between the input source device and the projector is greater than 25 feet, signal amplification/conditioning may be required.
5. If the source is a VCR or off-air broadcast, detail may be set too high.

# 6

# Specifications

This section provides detailed M-Series specifications, including:

- *6.1 Image Performance*
- *6.2 Feature Set*
- *6.3 Image Processor Performance*
- *6.4 Input (Source Signal) Compatibility*
- *6.5 Control Signal Compatibility*
- *6.6 Power Requirements*
- *6.7 Physical Specifications*
- *6.8 Reliability and Serviceability*
- *6.9 Environment*
- *6.10 Accessories and Service Components*
- *6.11 Regulatory*

*\*Due to continuing research, specifications are subject to change without notice.*

## 6.1 IMAGE PERFORMANCE

### 6.1.1 Pixel Format

1080p (H x V square pixels)	1920 x 1080
1080p Imaging Device & Configuration	Dark Metal 4 DMD, 3 chip, 0.95" diagonal
SXGA+ (H x V square pixels)	1400 x 1050
SXGA+ Imaging Device & Configuration	Dark Metal 4 DMD, 3 chip, 0.95" diagonal

### 6.1.2 Brightness (ANSI Lumens)

Projector Base Model	Lamp Power	Nominal Brightness
	370W	9500
350W 1080p	350W	9100
	300W	7700
350W SXGA+	370W	9435
	350W	9050
	300W	7600
200 W 1080p	200W	5100
	150W	3800
200W SXGA+	200W	5000
	150W	3700

Brightness loss 0-24 hours  
10% maximum

### 6.1.3 Contrast

ANSI: 16 pt checker pattern on black screen	450 :1 min
	650 :1 nominal
Full field: 9 pt average ON/OFF with background light subtraction	2000 :1 min (full open aperture)
	2500 :1 nominal (full open aperture)
	5000 :1 min (with dynamic aperture)
	10000 : 1 nominal (with dynamic aperture)

**6.1.4 Luminance Uniformity**

Dual lamp Full white ANSI 13-pt (w/o electronic corr.)	+15%, -23%
Single lamp Full white ANSI 13-pt (w/o electronic corr.)	+15%, -32%
Full white ANSI 13-pt (w/ electronic corr.)	+5%, -5%
Full black ANSI 13-pt	Negative uniformity shall be between -35% and 0% and positive uniformity shall be between 0% and +35%.

**6.1.5 Color Uniformity**

Full white ANSI 13-pt	+/-0.005 cluster on u',v' chart (CIE 1976)
Full black ANSI 13-pt	+/-0.075 cluster on u', v', chart (CIE 1976)

**6.1.6 Color Primaries**

ANSI 9 point measurement without YNF	x	y
Red	0.665 ± .025	0.335 ± .025
Green	0.343 ± .040	0.640 ± .040
Blue	0.145 ± .020	0.050 ± .025
White	0.300 ± .050	0.300 ± .050

ANSI 9 point measurement with YNF	x	y
Red	0.670+/-0.025	0.330+/-0.025
Green	0.300+/-0.040	0.673+/-0.040
Blue	0.148+/-0.020	0.045+/-0.025

**6.1.7 Gamma**

Default Gamma (all points from 10 to 90 IRE)	2.2 + linear segment
Adjustable Gamma range	1.0 to 3.0

**6.1.8 Grayscale/Color Resolution**

Resolution	10 bits (non-linear) min (Gamma encoded)
------------	--

**6.1.9 Color Temperature**

White Default CCT (without YNF)	7500 K ±1000K
White YNF CCT (with YNF activation, electronically corrected)	6500K ±1000K
Range of Adjustment	3200 K – 9300 K
Tracking (deviation from normal over full range from 0 – 100 IRE)	±500 K max
Stability (during rated lamp life)	±500 K max

**6.1.10 Convergence**

Convergence zones A, B, C are as defined in Figure 2. Zone A has a diameter of ¼ of the image height. Zone B has a diameter of full image height. All specified convergence errors are between any two colors after a minimum warm-up up of 30 minutes.

Convergence is specified with a 1.4-1.8 HD lens ( part number 118-100112-01) in the 1.4:1 position with zero offset. Bore-sight alignment must be adjusted for zero angular error. (Note: convergence error includes the effects of lateral color in the projection lens. Measurements must be done on horizontal and vertical test pattern lines that intersect the center of the image).

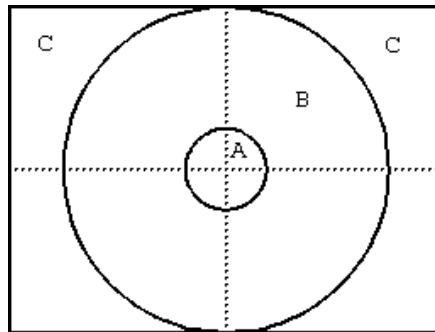

(Figure applicable to both 1080p and SXGA+)

Measurement Area	Maximum Convergence Error (Pixels)
Zone A	1/4
Zone B	1/2
Zone C	3/4

**6.1.11 Blemishes**

Blemishes are to be observed at 1 full screen height distance from the image for a period of 30 seconds. Screen size: 10 foot wide for 350W models, 8 foot wide for 200W models. Blemishes are defined as per TI Specification 2506811.

- |              |              |
|--------------|--------------|
| Red screen   | No blemishes |
| Green screen | No blemishes |
| Blue screen  | No blemishes |
| White screen | No blemishes |
| Black screen | No blemishes |



### 6.1.12 Pixel Defects

Red	0 bright, 1 dark
Green	0 bright, 0 dark
Blue	0 bright, 2 dark non-adjacent

### 6.1.13 Image Artifacts

Evaluate on multi-burst or fine grid test pattern	No visible artifacts with observer at 1 full screen height from image
---	---

### 6.1.14 Picture Centering

1080p centering error	±5% of vertical offset (32 pixels)
SXGA+ centering error	±5% of vertical offset (26 pixels)

## 6.2 FEATURE SET

### 6.2.1 Airflow

Air intakes	Right side of projector
Air exhaust	Hot lamp exhaust: rear of projector Cool light engine exhaust: left side of projector

### 6.2.2 Air Filters (Optional)

Filter media types	Coarse foam filter Fog filter
Filter access	Service-interchangeable via access panel

### 6.2.3 Dust Sealing

Dust sealed DMDs	Gasket sealed
Dust sealed illumination system	Sealed from lamp input to entrance face of prism when lamps are installed

**6.2.4 ILS (Intelligent Lens System)**

Motorized lenses and lens mount with position encoding	Zoom, focus, horizontal and vertical offsets
Accuracy	±2 pixel
Manual control	1/3 pixel fine movement control per button press on any applicable User Interface (e.g., remote).
Calibration	Automatic calibration on lens change detection
User Configurable Calibration Modes	Automatic calibration on power-up
	Manual calibration
Calibration time	< 10 secs when required
Bore sight	3-point +/- 4 degrees adjustment and lockable without removing covers
Travel time stop to stop	
Zoom and Focus	10 sec nominal (depends on lens type)
Offsets	5 sec (nominal (depends on lens type)
Manual Lens Movement	Manual over-ride permissible for zoom and focus

**6.2.5 Projection Lens Compatibility**

Lens type	Reverse Telecentric Internal-focus
Lens throw ratio	Motorized zoom and focus with position feedback
	Lens ILS 0.73:1SX+/0.67:1HD
	Lens ILS 1.25-1.6SX+/1.16-1.49HD
	Lens ILS 1.5-2.0SX+/1.4-1.8HD
	Lens ILS 2.0-2.8SX+/1.8-2.6HD
	Lens ILS 2.8-4.5SX+/2.6-4.1HD
	Lens ILS 4.5-7.5SX+/4.1-6.9HD
	Lens ILS 7.5-11.2SX+/6.9-10.4HD
Compatibility	Lens ILS 1.2SX+/1.1HD
	Lens ILS 1.2SX+/1.1HD SFL
Lens change-out	Easy Rider-type HD lenses with motor and mount change
Lens ID	Clamp type tool-less mount with built-in connector
	Each lens type is encoded with a unique ID code that is identified in the projector

**6.2.6 Dynamic Iris**

Motorized iris with position feedback	Scene controlled motorized iris automatically adjusts to image content
Max frequency open-close-open	20 Hz
Sound level	Within ambient noise level of projector
	Configurable per channel

**6.2.7 Automatic Fans**

Temperature sensitive fan speed control

Standby

Temperature range for variable fan speed  
Transition steps

Fans automatically adjust to required speed to maintain projector at proper operating range as function of outside ambient temperature  
All fans are off when projector is in standby and not running active loop-through on a Twin HDMI option card  
5 to 40 degrees C  
Smooth speed transitions with no abrupt audible changes

**6.2.8 Automatic Color Filtering**

Motorized yellow notch filter

User selectable optical color switch (in or out) to enhance color space  
Configurable per channel

**6.2.9 Constant Lamp Output Management**

LiteLOC™

Automatically adjusts lamp output to maintain constant lumens setting within operating range of lamp.

**6.2.10 Shutter**

Open  
Closed  
Activation

Light transmitted to projection lens  
All light blocked - no light on screen  
Operation in less than 0.25 seconds.

**6.2.11 Lamps**

Dual Mercury lamp system

Lamps are accessed from side of projector  
Lamps are individually swappable while the projector is running

**6.2.12 Status LED**

Status LED's	Located at back of projector
	<b>LED STATES</b>
Lamp 1, Lamp 2	<p><b>Off</b> – Lamps are off</p> <p><b>Yellow</b> – Lamp time has expired and lamp should be replaced</p> <p><b>Green</b> – Lamp is on and operating correctly</p> <p><b>Flashing red</b> – Lamp has malfunctioned</p>
Power	<p><b>Off</b> – AC power is off</p> <p><b>Yellow</b> – AC is present but projector is in standby</p> <p><b>Green</b> – Projector is powered up and operating normally</p> <p><b>Flashing green/yellow</b> – Projector communication in progress</p> <p><b>Flashing red</b> – Error has occurred. Details are displayed on the status display</p>
Shutter	<p><b>Green</b> – shutter is open</p> <p><b>Yellow</b> – shutter is closed</p>

**6.2.13 Electronics/SW**

<b>FEATURE</b>	<b>COMMENTS</b>
Imaging Device	Supports 3 chip DMD operation
Video Format Re-Sizing	All video formats can be resized to fill screen either horizontally or vertically while maintaining aspect ratio
Picture in Picture	
Seamless Switching	
Built-in 2D keystone and geometry correction	
Auto-scaling	
Auto-deinterlacing	
Edge blending	
Warping	
Tiling (support for up to 3x3 arrays)	
Blanking and Image positioning	
Brightness, contrast, color, and uniformity user settable control	
Image orientation	Can display image front/rear, normal/inverted (ceiling)
Electronics HW access	All accessible electronics are mounted from the back of the projector
Number of option cards	6 user inter-changeable – hot swappable
Number of processor cards	2 user inter-changeable
Number of option slots	4, located at back of projector for option cards; 1, located at back of projector for processor card
Native format adjustment	Optional global aspect ratio setting can be set for projector allowing for automatic scaling of all input images to required output format
Arbitrary Gamma	User definable gamma curves

### 6.3 IMAGE PROCESSOR PERFORMANCE

Min input pixel rate	13 Mpix/s	
Max input pixel rate	165 Mpix/s Standard mode	Single image processor (SIPC)
Max input resolution	2048x1536 (QXGA)	
Min input resolution	640x400	
Max input frame rate with Single Image Processor Card	50Hz at 2048x1536 (QXGA) *	* With sources that can output minimum blinking, otherwise lower vertical rates
Processing	10 bit throughput *	* Except Dual-DVI input in dual-link mode (dual 8 bit input paths into 10 bit processing)
Source switching time	Seamless switching with switch time less than 1 second	

### 6.4 INPUT (SOURCE SIGNAL) COMPATIBILITY

#### 6.4.1 Analog (Only) Input

Connectors	5 female BNC, 75 Ohm R/Pr G/Y B/Pb H/C V
Color spaces/signal types	RGB YPbPr
A/D conversion	10 bits
Sampling clock range	13 MHz – 165MHz (SIPC) / 300 MHz (DIPC)

#### 6.4.2 Twin HDMI Input

Connectors	2 independent HDMI inputs type A 2 loop-out connectors type A
Color spaces/signal types	RGB YCbCr (4:2:2) YCbCr (4:4:4) HDCP support HDMI 1.3 supported (not including audio) except: 12 bit color dithered to 10 bits; 16 bit color not supported

**6.4.3 Dual Link DVI Input**

Connectors	1 dual link DVI-I 1 analog 15-pin VGA
Color spaces/signal types	HDCP support
A/D conversion	10 bits for single link DVI input 8 bits for dual link DVI inputs
Frequency	165 MPixel/s analog 300 Mpix/s Dual link DVI (requires DIPC)

**6.4.4 Video Decoder Input**

Connectors	2 S-Video 4-pin miniature DIN 4 BNC, 75 Ohm 2 independent decoder channels for PIP
Color space/Signal types	Composite video Component video (SD and ED only) S-video
Video Standards	NTSC, NTSC 4.43, PAL, PAL M, PAL N, PAL 60, SECAM
A/D conversion	10 bits

**6.4.5 Dual Standard Definition, High Definition or Serial Digital Input**

Connectors	BNC, 75 Ohm
Color spaces/signal types	Dual HD input SDI, HDSDI

**6.5 CONTROL SIGNAL COMPATIBILITY**

**6.5.1 Remote Dual Frequency**

Number of transmitters	2 IR
Modulation frequency	Dual frequency (38 kHz, 455 kHz)
Wavelength (peak intensity)	950 nm
Range	Min 35 m
Wired Keypad	
Wire connection (option)	3 pin XLR
Max cable length	30 m
XLR Connections	Optional boot for remote with XLR connector built-in to avoid requirement to use phono-to-XLR adaptor cable

### 6.5.2 Control Receiver

Number of sensors	1 front, 1 rear
Coverage	130 degrees coverage in-line with lens at 3 m distance
Modulation (carrier) frequency	Dual frequency (38 kHz, 455 kHz)

### 6.5.3 RS232

Number of ports	2
Connector	1 female 9-pin Dsub (IN) 1 male 9-pin Dsub (OUT)
Max bit rate	115.2 kbps
Flow control	Xon/Xoff

### 6.5.4 RS422

Number of ports	1
Connector	1 female 9-pin Dsub
Max bit rate	115.2 kbps
Power output	12 V $\pm$ 5% @ 400mA maximum

### 6.5.5 Ethernet

Number of ports	1
Standard	10/100 Base-T
Connector	Female RJ-45

### 6.5.6 USB 2.0 Device Port

Number of ports	1
Standard	Supports: mass storage device type, Ethernet device type, and/or serial device type.
Connector	USB type B (full size)
Max bit rate	3-12 Mbps (high speed 480 Mbps not supported)

### 6.5.7 GPIO

Number of I/O Lines	7
Connector	Male 9-pin Dsub
Output sink current (logic low)	100 mA @ 1V typical
Power output	12 V $\pm$ 5% @ 400mA maximum

### 6.5.8 DMX512 Interface

Connectors	2 5-pin XLR 1 plug and 1 receptacle
Input/Output	Can be switched in or out via user setting

### 6.5.9 Built-In Keypad and Display

Key type	Soft-touch keys
Display type	Graphics LCD backlight

**6.5.10 AMX/Crestron Support**

AMX Device Discovery Partner  
 Crestron Integrated Partner

**6.6 POWER REQUIREMENTS**

Rated voltage	100 VAC – 240 VAC
Rated Current (dual lamp operation)	
370W 1080p	12 A @ 100 VAC
200 W 1080p	9 A @ 100 VAC
370W SXGA+	12 A @ 100 VAC
200W SXGA+	9 A @ 100 VAC
Line frequency	50/60 Hz
AC Input Coupler	15 A, 250 VAC
Type of connector	IEC 320-C14 with wire cable clamp
Line Cord	14AWG type FT1 with plug, NEMA 5-15P, 15A
Inrush Current	60 A max
Maximum Power Consumption	
370 W 1080p	1320 W (dual lamp) / 831 W (single lamp)
350 W 1080p	1267 W (dual lamp) / 805 W (single lamp)
300 W 1080p	1135 W (dual lamp) / 739 W (single lamp)
200 W 1080p	871 W (dual lamp) / 607 W (single lamp)
150 W 1080p	739 W (dual lamp) / 541 W (single lamp)
370 W SXGA+	1320 W (dual lamp) / 831 W (single lamp)
350 W SXGA+	1267 W (dual lamp) / 805 W (single lamp)
300 W SXGA+	1135 W (dual lamp) / 739 W (single lamp)
200 W SXGA+	871 W (dual lamp) / 607 W (single lamp)
150 W SXGA+	739 W (dual lamp) / 541 W (single lamp)
Maximum Current at 100V	
370 W 1080p	13.2 A (dual lamp) / 8.3 A (single lamp)
350 W 1080p	12.7 A (dual lamp) / 8.0 A (single lamp)
300 W 1080p	11.4 A (dual lamp) / 7.4 A (single lamp)
200 W 1080p	8.7 A (dual lamp) / 6.1 A (single lamp)
150 W 1080p	7.4 A (dual lamp) / 5.4 A (single lamp)
370 W SXGA+	13.2 A (dual lamp) / 8.3 A (single lamp)
350 W SXGA+	12.7 A (dual lamp) / 8.0 A (single lamp)
300 W SXGA+	11.4 A (dual lamp) / 7.4 A (single lamp)
200 W SXGA+	8.7 A (dual lamp) / 6.1 A (single lamp)
150 W SXGA+	7.4 A (dual lamp) / 5.4 A (single lamp)



**6.6.1 Lamp Specification**

Type	Mercury Lamp (Hg)
Power	
350 W HD/350 W SX+	300 W min, 370 W max (software adjustable)
200 W HD/200 W SX+	150 W min, 200 W max (software adjustable)
350W Lamp rated lamp life to 50% brightness (2 hrs on, 15 min off duty cycle)	1300 hrs typical @ 370W 1500 hrs typical @ 350W
200W Lamp rated lamp life to 50% brightness (2 hrs on, 15 min off duty cycle)	2000 hrs typical @ 300W 2000 hrs typical @ 200W
Warn-up time (to full output)	3000 hrs typical @ 150W 5 minutes max
Operating position	±20 deg max tilt of lamp axis from horizontal

**6.7 PHYSICAL SPECIFICATIONS**

**6.7.1 Size**

Maximum product dimensions (L x W x H) (with lens removed)	561mm (22.1”) x 500mm (19.7”) x 247mm (9.75”)
Maximum shipping dimensions (L x W x H)	680mm (26.5”) x 650mm (25.6”) x 458mm (18”)

**6.7.2 Adjustment**

Product Alignment	2” of vertical adjustment on 2 front feet 1” of vertical adjustment on single rear foot
-------------------	--

**6.7.3 Weight**

Maximum product weight (with lens removed)	25kg (55lb.)
Maximum shipping weight (includes packaging)	34kg (75lb.)

**6.7.4 Operating Position**

Horizontal	±20 degrees allowable rotation about lens axis
Inverted	±20 degrees allowable rotation about lens axis
Rotation	±180 degrees perpendicular to lens axis

**6.7.5 Cosmetics**

*PAINT AND COLORS*

Skins	Sandtek black F63TXB11783-8703 Sherwin-Williams, Polane-T polyurethane enamel. Pale grey text silkscreen Pantone 421 matte finish.
Option Cards Faceplates	Smooth black 63B12 10 to 15 degree gloss per 010-100594. Pale grey text silkscreen Pantone 421 matte finish.
Card cage Faceplate	Grand Century B711-T1856 gloss black. Pale grey text silkscreen Pantone 421 matte finish.

## 6.8 RELIABILITY AND SERVICEABILITY

### 6.8.1 Reliability

MTBF – excluding consumable components	15,000 hrs
Consumable components	Air filters, fans, lamps

### 6.8.2 Serviceability

Time to replace any option card	1 minute
Time to replace lamp	1 minute
Time to replace projection lens	30 seconds
Time to replace air filter	1 minute

## 6.9 ENVIRONMENT

### 6.9.1 Temperature/Humidity/Altitude

Operating temperature range	5 to 40 degrees C
Storage temperature range	-40 to 70 degrees C
Humidity range	10% to 80%, non condensing
Operating Altitude	10,000 ft maximum

## 6.10 ACCESSORIES AND SERVICE COMPONENTS

Product Name	Part Number	Sold With Product	Sold Separately
Standard Image Processor	108-315101-XX	X	X
Analog Card Input	108-309101-XX	X	X
Dual Link DVI Input	108-312101-XX	X	X
Video Decoder Input	108-310101-XX	X	X
Dual HDSDI Input	108-313101-XX	X	X
Twin HDMI Input	108-311101-XX	X	X
DMX512 Interface	108-314101-XX	X	X
Dust filter	118-100104-XX		X
Fog filter	118-100105-XX		X
Stacking frame	118-100107-XX		X
Ceiling mount	118-100108-XX		X
Lens ILS 0.73:1SX+/0.67:1HD	118-100110-XX		X
Lens ILS 1.25-1.5SX+/1.16-1.39HD	118-100111-XX		X
Lens ILS 1.5-2.0SX+/1.4-1.8HD	118-100112-XX		X
Lens ILS 2.0-2.8SX+/1.8-2.6HD	118-100113-XX		X
Lens ILS 2.8-4.5SX+/2.6-4.1HD	118-100114-XX		X
Lens ILS 4.5-7.3SX+/4.1-6.9HD	118-100115-XX		X
Lens ILS 7.5-11.2SX+/6.9-10.4HD	118-100116-XX		X
Lens ILS 1.2SX+/1.1HD	118-100117-XX		X
Lens ILS 1.2SX+/1.1HD SFL	118-101103-XX		
Portrait Mode Coupler	118-116109-XX		X
IR remote	002-120414-XX	X	X
IR remote harness	001-100704-XX	X	X
User Manual	020-100009-XX	X	
Service Manual	020-100010-XX		X

**6.10.1 Service Components**

<b>Service Item</b>	<b>Part Number</b>
Lamp (200W); DS+6K-M, HD6K-M, DLV1920-DL, DLV1400-DL	003-100856-XX
Lamp (350W); HD10K-M, Roadster HD10K-M, DS+10K-M, Roadster S+10K-M	003-100857-XX
Air Filter Dust M-Series (Package of 6)	118-100104-XX
Air Filter Fog M-Series (Package of 6)	118-100105-XX

**6.11 REGULATORY**

This product conforms to the following regulations related to product safety, environmental requirements and electromagnetic compatibility (EMC).

- FCC Part 15, Subpart B Class A; CISPR22/EN55022; CISPR24/EN55024
- UL 60950-1 First Edition; CAN/CSA-C22.2 No. 60950-1-03 First edition;
- IEC60950-1:2001
- 2002/95/EC RoHS

# Appendix A: GPIO

This section explains how to use a GPIO link from the projector to external equipment, such as devices for 3D synchronizing.

- [A.1 GPIO Port](#)

## A.1 GPIO PORT

The GPIO connector located on the input panel provides a flexible method of interfacing a wide range of external I/O devices to the projector. There are 7 GIO pins available on the 9pin D-Sub GPIO connector, which are configurable via RS232 commands. The other two pins are reserved for ground and power - see table below for pin identification.

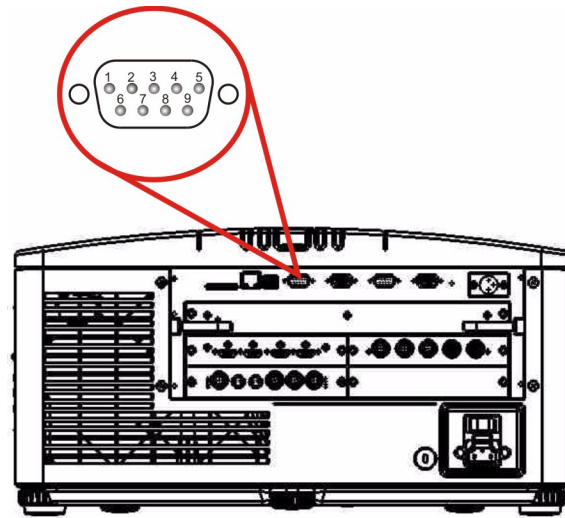

FIGURE A-1 - GPIO CONNECTOR

Table A.1 GPIO Pin

GPIO PINS	
PIN #	SIGNAL
Pin 1	+ 12V (200mA)
Pin 2	GPIO 1
Pin 3	GPIO 2
Pin 4	GPIO 3
Pin 5	Ground
Pin 6	GPIO 4
Pin 7	GPIO 5
Pin 8	GPIO 6
Pin 9	GPIO 7

The serial cable required for connecting the external device to the projector's GPIO connector, must be compatible with the external device.

### Configuring the GPIO

The GPIO connector can be configured to automate any number of events using the serial command code **GIO**. Each Pin is defined as either an *input* or *output* depending on the desired outcome. Configure the pin as an input if you want the projector to respond to something the device does and as an output if you want the external device to respond to an action taken by the projector. For example, configure the pin as an output if you want the lighting in a room to automatically dim when the projector is turned on.

By using the GIO command, you can also set the state of each pin as **high** or **low**. By default, the state of each pin is **high**. The voltage applied to pins in the high state is +3.3V.

**Example 1.** Turn room lighting on when the projector is turned off. (Assumes a control/automation unit is configured to turn the lights on when pin 2 of its input goes high.)

(GIO+CNFG "OOOllll")                      Set pin #2, 3 & 4 configuration to output and pin 6, 7, 8 & 9 to input

(GIO+STAT "10xxxxx")                      Set pin #2 to high, pin 3 to low and the state of all other pins unchanged

**Query Command**

(GIO+STAT)                                      Request the state of all pins

(GIO+STAT "1001001")                      Reply of pin states - 1 means pin is high, 0 means pin is low

(GIO+CNFG)                                      Request the configuration of all pins

(GIO+CNFG "lllOOOO")                      Reply of pin configurations - pins 2, 3 & 4 are Inputs, pins 6, 7, 8 & 9 are Outputs

*NOTE: The strings in the commands refer to pins 2, 3, 4, 6, 7, 8, 9 in order from left to right.*