

DWU951/DHD951/DWX951/DXG1051

**User's Manual (detailed)
Operating Guide**

020-000661-02

CHRISTIE[®]

DWU951/DHD951/DWX951/DXG1051

User's Manual (detailed) Operating Guide

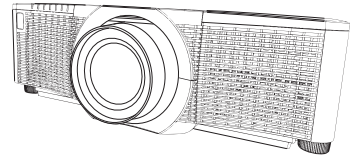

Thank you for purchasing this projector.

⚠ WARNING ▶ Before using this product, please read all manuals for this product. Be sure to read **Safety Guide** first. After reading them, store them in a safe place for future reference.

About this manual

Various symbols are used in this manual. The meanings of these symbols are described below.

- ⚠ WARNING** This symbol indicates information that, if ignored, could possibly result in personal injury or even death due to incorrect handling.
- ⚠ CAUTION** This symbol indicates information that, if ignored, could possibly result in personal injury or physical damage due to incorrect handling.

NOTICE This entry notices of fear of causing trouble.



Please refer to the pages written following this symbol.

- NOTE**
- The information in this manual is subject to change without notice.
 - The illustrations in this manual are for illustrative purposes. They may differ slightly from your projector.
 - The manufacturer assumes no responsibility for any errors that may appear in this manual.
 - The reproduction, transfer or copy of all or any part of this document is not permitted without express written consent.

Trademark acknowledgment

- Mac® is a registered trademark of Apple Inc.
- Windows®, DirectDraw® and Direct3D® are registered trademarks of Microsoft Corporation in the U.S. and/or other countries.
- VESA and DDC are trademarks of the Video Electronics Standard Association.
- HDMI™, the HDMI logo, and High-Definition Multimedia Interface are trademarks or registered trademarks of HDMI Licensing LLC in the United States and other countries.
- Trademark PJLink is a trademark applied for trademark rights in Japan, the United States of America and other countries and areas.
- Blu-ray Disc™ and Blu-ray™ are trademarks of Blu-ray Disc Association.
- DICOM® is the registered trademark of the National Electrical Manufacturers Association for its standards publications relating to digital communications of medical information.
- DLP® and the DLP logo are registered trademarks of Texas Instruments.
- HDBaseT™ and the HDBaseT Alliance logo are trademarks of the HDBaseT Alliance.



All other trademarks are the properties of their respective owners.

Contents



Introduction	3	Other buttons	41
Features	3	Geometry correction	42
Checking the contents of package	3	Correcting the distortion, Using the EDGE BLENDING feature, Using the WARPING feature, Using the Camera Feedback (BLENDING) feature,	
Part names	4	Using the magnify feature	50
Projector, Control panel and Indicators, Ports, Remote control		Temporarily freezing the screen	51
Setting up	9	Temporarily shading the screen	51
Installing the lens unit	9	PbyP (Picture by Picture) / PIP (Picture in Picture)	52
Arrangement	9	Using the menu function	56
Connecting with your devices	12	Indication in OSD, Containing items of each menu	
Fastening the cables		EASY MENU	59
Fastening the adapter cover	23	IMAGE SETTINGS menu	61
Using the security bar and slot	24	SIZE AND POSITION menu	66
Connecting to a power supply	25	INPUT menu	69
Remote control	26	SETUP menu	75
Installing the batteries	26	MENU PREFERENCES	83
Using the REMOTE ID function	26	OPTION menu	90
Changing the frequency of remote control signal	27	NETWORK menu	100
About the remote control signal	27	SECURITY menu	101
Status Monitor	28	Maintenance	107
Switching the display	29	Replacing the lamp	107
The current status (Warnings and Errors)	31	Cleaning and replacing the air filter	110
Error log	31	Replacing the internal clock battery	112
Lamp log	32	Other care	113
Filter log	33	Regarding the indicator lamps	114
Network Information	33	Resetting all settings	120
Power on/off	34	Troubleshooting	121
Operating	35	Specifications	130
Selecting an input signal	35		
Selecting an aspect ratio	36		
Adjusting the projector's elevator	37		
Adjusting the lens	38		
Adjusting the zoom and focus, Adjusting the lens position, Lens memory, Lens lock			
Using the automatic adjustment feature	40		

Introduction

Features

The projector provides you with the broad use by the following features.

- ✓ The **HDMI/DVI-D/HDBaseT™** ports can support various image equipment which have digital interface to get clearer pictures on a screen.
- ✓ Equipped with two COLOR WHEEL, to enhance brightness and color.
- ✓ Some optional lens units and the wide range of lens shift feature will give much more chances to install the product wherever you want.
- ✓ Has an HDCR feature which is original image stabilizer for a clearer image.
- ✓ The wealth of I/O ports is believed to support any business scene.
- ✓ Equipped with geometry correction which corresponds to aspect and different kinds of screen.

Checking the contents of package

Please see the **Contents of package** section in the **User's Manual (concise)** which is a book. Your projector should come with the items shown there.

Require of your dealer immediately if any items are missing.

⚠ WARNING ► Keep small parts away from children and pets. Take care not to put in the mouth. If swallowed, consult a physician immediately for emergency treatment.

NOTE • Keep the original packing materials, for future reshipment. Be sure to use the original packing materials when moving the projector. Use special caution for the lens.

• The projector may make a rattling sound when tilted, moved or shaken, since a flap to control the air flow inside of the projector has moved. Be aware that this is not a failure or malfunction.

Part names

Projector

- (1) Dust protector
- (2) Remote sensors (📖 27)
- (3) Elevator feet (x2) (📖 37)
- (4) **AC** (AC inlet) (📖 25)
- (5) Holes for Cable Tie (📖 22)
- (6) Security slot (📖 24)
- (7) Security bar (📖 24)
- (8) Control panel (📖 5)
- (9) Status Monitor (📖 28)
- (10) Ports (📖 6)
- (11) Indicators (📖 5)
- (12) Intake vents (📖 110)
- (13) Exhaust vents (📖 110)
- (14) LAMP - 1 lamp cover (📖 107)
- (15) LAMP - 2 lamp cover (📖 107)
- (16) Battery cover

The internal clock battery is inside (📖 112).

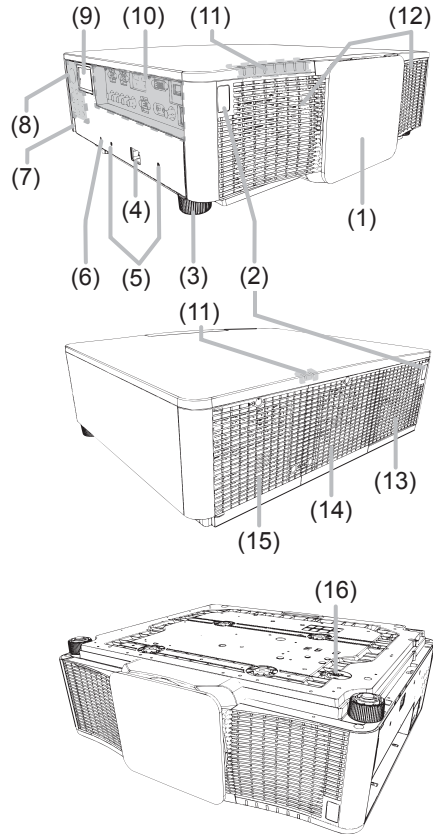

⚠️ WARNING ▶ Do not open or remove any portion of the product, unless the manuals direct it.

▶ Do not subject the projector to unstable conditions.

▶ Do not apply a shock or pressure to this product. Remove all the attachments including the power cord and cables, from the projector when carrying the projector.

▶ Do not look into the lens and the openings on the projector while the lamp is on.

▶ Do not touch around the lamp cover and the exhaust vents during use or just after use, since it is too hot.



⚠️ CAUTION ▶ Do not attach anything onto the lens, it could damage the lens, such as melting the lens.

Control panel and Indicators

- (1) **STANDBY/ON** button (📖 34)
- (2) **INPUT** button (📖 35)
- (3) **MENU** button (📖 56)
- (4) **LENS SHIFT** button (📖 38)
- (5) **ZOOM** button (📖 38)
- (6) **FOCUS - / +** buttons (📖 38)
- (7) **SHUTTER** button (📖 51)
- (8) **FUNCTION** button (📖 38, 39)
- (9) **FILTER** indicator (📖 118, 120)
- (10) **SHUTTER** indicator (📖 119)
- (11) **SECURITY** indicator (📖 119)
- (12) **LAMP-2** indicator (📖 117)
- (13) **LAMP-1** indicator (📖 117)
- (14) **TEMP** indicator (📖 115 to 119)
- (15) **POWER** indicator (📖 114 to 115)
- (16) **LAMP-2** indicator (📖 117)
- (17) **LAMP-1** indicator (📖 117)

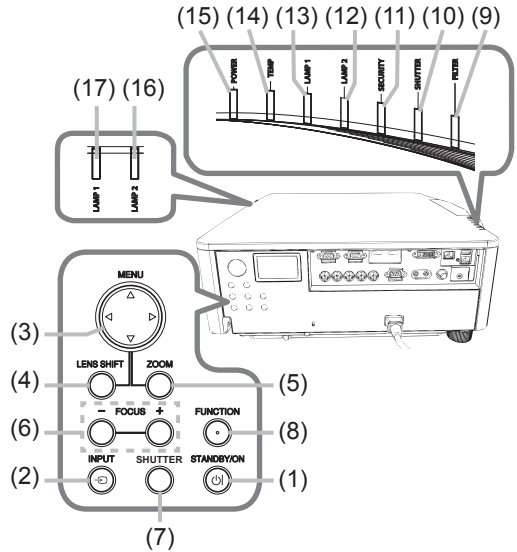

Ports

- (1) **MONITOR OUT** port
- (2) •DWU951/DWX951/DXG1051
COMPUTER IN1 port
- DHD951
COMPUTER IN port
- (3) **HDMI 2** port
- (4) **HDMI 1** port
- (5) **DVI-D** port
- (6) **HDBaseT™** port
- (7) **WIRELESS** port
- (8) **LAN**
- (9) •DWU951/DWX951/DXG1051
COMPUTER IN2 port
- (R/Cr/Pr, G/Y, B/Cb/Pb, H, V)
- DHD951
SDI/DIGITAL 1 port
- (10) **CONTROL** port
- (11) **REMOTE CONTROL IN** port
- (12) **REMOTE CONTROL OUT** port
- (13) **VIDEO** port

DWU951/DWX951/DXG1051

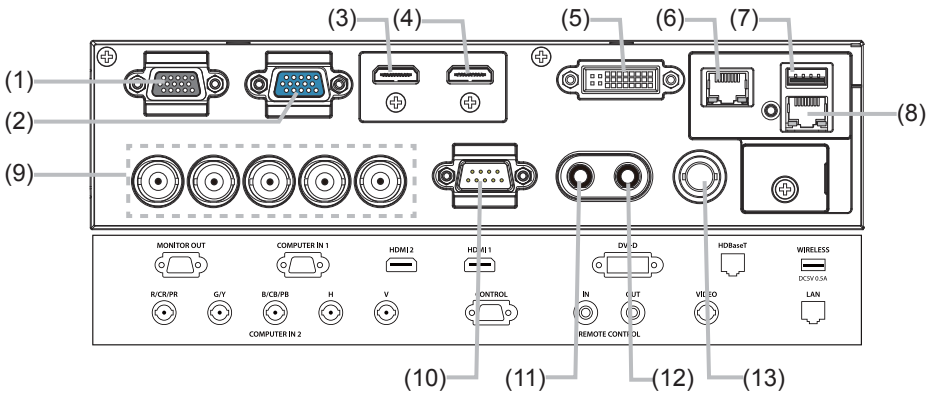

DHD951

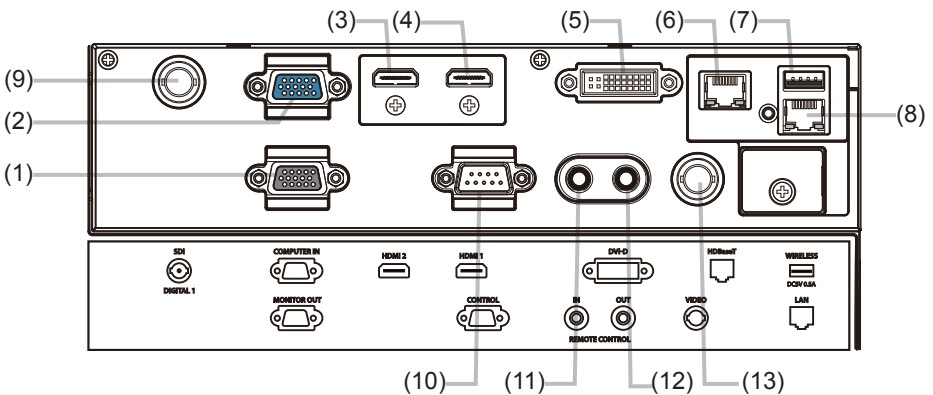

Remote control (DWU951/DWX951/DXG1051)

- (1) **STANDBY** button (📖 34)
- (2) **ON** button (📖 34)
- (3) **ID - 1 / 2 / 3 / 4** buttons (📖 26)
- (4) **COMPUTER 1** button (📖 35)
- (5) **COMPUTER 2** button (📖 35)
- (6) **COMPUTER 3** button *
- (7) **LAN** button (📖 35)
- (8) **USB TYPE A** button *
- (9) **USB TYPE B** button *
- (10) **HDBaseT** button (📖 35)
- (11) **COMPONENT** button *
- (12) **VIDEO** button (📖 35)
- (13) **HDMI 1** button (📖 35)
- (14) **HDMI 2** button (📖 35)
- (15) **DVI-D** button (📖 35)
- (16) **FOCUS + / -** buttons (📖 38)
- (17) **LENS MEMORY SAVE / LOAD** button (📖 39)
- (18) **ZOOM + / -** buttons (📖 38)
- (19) **LOCK** button (📖 40)
- (20) **LENS SHIFT** button (📖 38)
- (21) **SHUTTER** button (📖 51)
- (22) **ENTER** button (📖 56)
- (23) **▲/▼/◀/▶** cursor buttons
- (24) **FREEZE** button (📖 51)
- (25) **MENU** button (📖 56)
- (26) **HDCR** button (📖 41)
- (27) **ASPECT** button (📖 36)
- (28) **PbyP** button (📖 52)
- (29) **RESET** button (📖 56)
- (30) **C.WHEEL** button (📖 41)
- (31) **AUTO** button (📖 40)
- (32) **OSD** button (📖 41)
- (33) **MAGNIFY** buttons (📖 50)
- (34) **PICTURE** button (📖 41)
- (35) **KEystone** button (📖 42)
- (36) **LAMP** button (📖 41)
- (37) **MY BUTTON - 1, 2, 3, 4** buttons (📖 92)
- (38) Battery cover (📖 26)
- (39) Wired remote control port (📖 19)

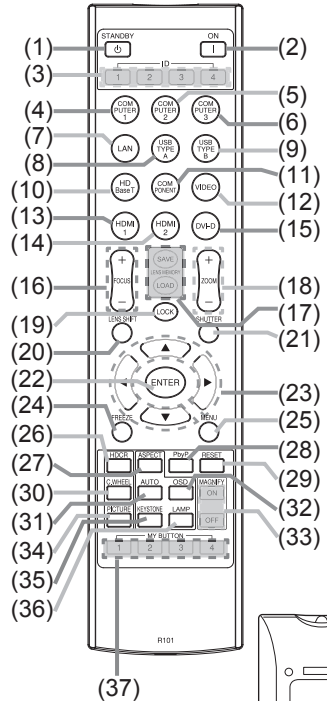

NOTE

- Any button marked with "*" is not supported on this projector (📖 35).
- Each time you press any button (except ID buttons), the ID button of current selected ID number will light (📖 26).

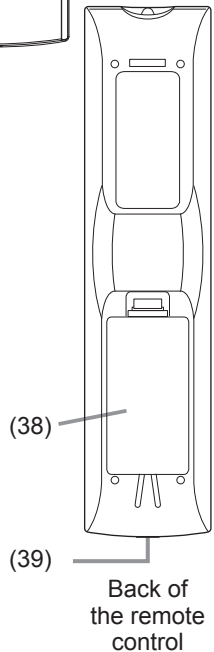

Remote control (DHD951)

- (1) **STANDBY** button (📖 34)
- (2) **ON** button (📖 34)
- (3) **ID - 1 / 2 / 3 / 4** buttons (📖 26)
- (4) **COMPUTER 1** button (📖 35)
- (5) **COMPUTER 2** button *
- (6) **VIDEO** button (📖 35)
- (7) **LAN** button (📖 35)
- (8) **USB TYPE A** button *
- (9) **USB TYPE B** button *
- (10) **HDBaseT** button (📖 35)
- (11) **DIGITAL 1** button (📖 35)
- (12) **DIGITAL 2** button *
- (13) **HDMI 1** button (📖 35)
- (14) **HDMI 2** button (📖 35)
- (15) **DVI-D** button (📖 35)
- (16) **FOCUS + / -** buttons (📖 38)
- (17) **LENS MEMORY SAVE / LOAD** button (📖 39)
- (18) **ZOOM + / -** buttons (📖 38)
- (19) **LOCK** button (📖 40)
- (20) **LENS SHIFT** button (📖 38)
- (21) **SHUTTER** button (📖 51)
- (22) **ENTER** button (📖 56)
- (23) **▲/▼/◀/▶** cursor buttons
- (24) **FREEZE** button (📖 51)
- (25) **MENU** button (📖 56)
- (26) **HDCR** button (📖 41)
- (27) **ASPECT** button (📖 36)
- (28) **PbyP** button (📖 52)
- (29) **RESET** button (📖 56)
- (30) **C.WHEEL** button (📖 41)
- (31) **AUTO** button (📖 40)
- (32) **OSD** button (📖 41)
- (33) **MAGNIFY** buttons (📖 50)
- (34) **PICTURE** button (📖 41)
- (35) **KEystone** button (📖 42)
- (36) **LAMP** button (📖 41)
- (37) **MY BUTTON - 1, 2, 3, 4** buttons (📖 92)
- (38) Battery cover (📖 26)
- (39) Wired remote control port (📖 19)

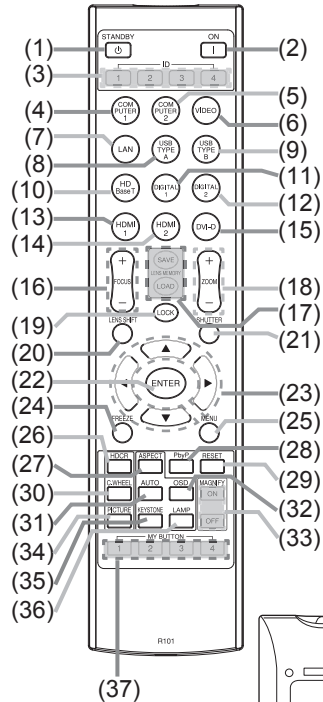

NOTE

- Any button marked with “**” is not supported on this projector (📖 35).
- Each time you press any button (except ID buttons), the ID button of current selected ID number will light (📖 26).

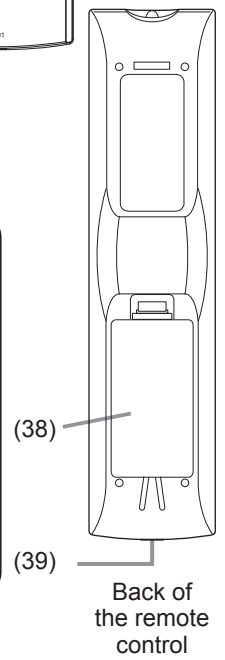

Setting up

Install the projector according to the environment and manner the projector will be used in.

For the case of installation in a special state such as ceiling mount, the specified mounting accessories ([Specifications](#) in the **User's Manual (concise)**) and service may be required. Before installing the projector, consult your dealer about your installation.

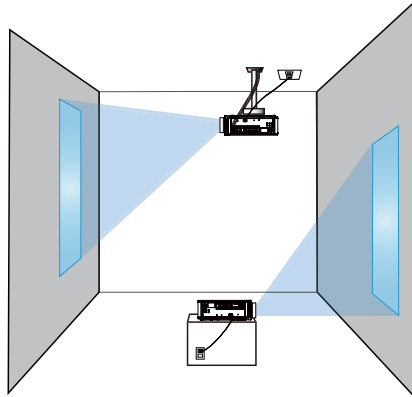

Installing the lens unit

See the manual of the optional lens.

Arrangement

Refer to tables **T-1** to **T-4** at the back of **User's Manual (concise)** as well as the following to determine the screen size and projection distance. The values shown in the table are calculated for a full size screen.

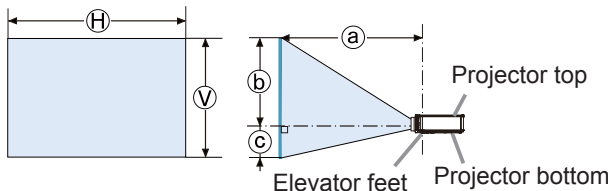

- \times : Screen size
- : Projection distance
(from the Elevator feet)
- , : Screen height

⚠ WARNING ▶ Install the projector where you can access the power outlet easily. If an abnormality should occur, unplug the projector urgently. Otherwise it could cause a fire or electric shock.

▶ Do not subject the projector to unstable conditions. If the projector falls or topples over, it could result in injury or damage to the projector and the surrounding things. Using a damaged projector could result in a fire and an electric shock.

- Do not place the projector in unstable places, such as an inclined surface, places subject to vibration, on top of a wobbly table or cart, or a surface that is smaller than the projector.
- Do not set the projector on the terminal side, rear end, or front.
- Do not attach nor place anything on the projector unless otherwise specified in the manual.
- Do not use any mounting accessories except the accessories specified by the manufacturer. Read and keep the manuals of the accessories used.
- For special installation such as ceiling mounting, be sure to consult your dealer beforehand.
- It is possible to install the projector for any direction with specified mounting accessories. Consult with your dealer about such a special installation.
- DLP chip(s) is/are precision-made parts. In rare cases, pixels may be missing or lit, but this is not a malfunction.
- Direct high-power laser beam onto the lens surface can damage the DLP chip(s).
- The projector is equipped with precision-made parts, handle with care while moving. Remove all the attachments including the power cord and cables, from the projector when carrying the projector.

▶ Do not install the projector near thermally conductive or flammable things. Such things when heated by the projector could result in a fire and burns.

- Do not place the projector on a metal stand.

▶ Do not place the projector where any oils, such as cooking or machine oil, are used. Oil may harm the product, resulting in malfunction, or falling from the mounted position.

▶ Do not place the projector in a place where it may get wet. Getting the projector wet or inserting liquid into the projector could cause a fire and an electric shock, and damage the projector.

- Do not place the projector near water, such as in a bathroom, kitchen, or poolside.
- Do not place the projector outdoors or by the window.
- Do not place anything containing liquid near the projector.

⚠ CAUTION ► **Place the projector in a cool place with sufficient ventilation.** The projector may shutdown automatically or may malfunction if its internal temperature is too high.

Using a damaged projector could result in a fire and an electric shock.

- Do not place the projector in direct sunlight or near hot objects such as heaters.
- Do not place the projector where the air from an air conditioner or similar unit will blow on it directly.
- Keep a space of 50 cm or more between a side of the projector and other objects such as walls.
- Do not place the projector on carpet, cushions or bedding.
- Do not stop up, block nor cover the projector's vent holes. Do not place anything around the projector that could be sucked in or stuck to the projector's intake vents.
- Do not place the projector at places that are exposed to magnetic fields, doing so can cause the cooling fans inside the projector to malfunction.

► **Avoid placing the projector in smoky, humid or dusty place.** Placing the projector in such places could cause a fire, an electric shock and malfunction of the projector.

- Do not place the projector near humidifiers. Especially for an ultrasonic humidifier, chlorine and minerals contained in tap water are atomized and could be deposited in the projector causing image degradation or other problems.
- Do not place the projector in a smoking area, kitchen, passageway or by the window.

NOTICE • Position the projector to prevent light from directly hitting the projector's remote sensor.

- Do not place the product in a place where radio interference may be caused.
- Set the ALTITUDE of the SERVICE item in the OPTION menu correctly. It is recommended to leave it at AUTO usually (📖 93). If the projector is used with a wrong setting, it may cause damage to the projector itself or the parts inside.
- Keep heat-sensitive things away from the projector. Otherwise, they may be damaged by the heat from the projector.

Connecting with your devices

Before connecting the projector to a device, consult the manual of the device to confirm that the device is suitable for connecting with this projector and prepare the required accessories, such as a cable in accord with the signal of the device. Consult your dealer when the required accessory did not come with the product or the accessory is damaged.

After making sure that the projector and the devices are turned off, perform the connection, according to the following instructions. Refer to the figures in subsequent pages.

Before connecting the projector to a network system, be sure to read **Network Guide** too.

⚠ WARNING ▶ Use only the appropriate accessories. Otherwise it could cause a fire or damage the projector and devices.

- Use only the accessories specified or recommended by the projector's manufacturer. It may be regulated under some standard.
- Neither disassemble nor modify the projector and the accessories.
- Do not use the damaged accessory. Be careful not to damage the accessories. Route a cable so that it is neither stepped on nor pinched out.

⚠ CAUTION ▶ For a cable with a core at only one end, connect the end with the core to the projector. That may be required by EMI regulations.

NOTE • Do not turn on or off the projector while connected to a device in operation, unless that is directed in the manual of the device. Otherwise it may cause malfunction in the device or projector.

- The function of some input ports can be selected according to your usage requirements. Check the reference page indicated beside each port in the following illustration.
- Be careful not to mistakenly connect a connector to a wrong port. Otherwise it may cause malfunction in the device or projector.
 - When connecting a connector to a port, make sure that the shape of the connector fits the port.
 - Tighten the screws to connect a connector equipped with screws to a port.
 - Use the cables with straight plugs, not L-shaped ones, as the input ports of the projector are recessed.

About Plug-and-Play capability

- Plug-and-Play is a system composed of a computer, its operating system and peripheral equipment (i.e. display devices). This projector is VESA DDC 2B compatible. Plug-and-Play can be used by connecting this projector to a computer that is VESA DDC (display data channel) compatible.
 - Take advantage of this feature by connecting a computer cable to the **COMPUTER IN1 (COMPUTER IN for DHD951)** port (DDC 2B compatible). Plug-and-Play may not work properly if any other type of connection is attempted.
 - Please use the standard drivers in your computer as this projector is a Plug-and-Play monitor.

DWU951/DWX951/DXG1051

Computer

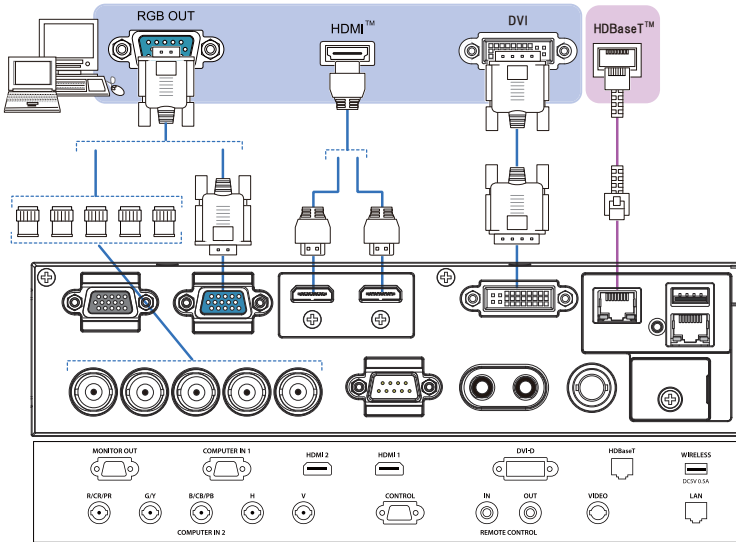

DHD951

Computer

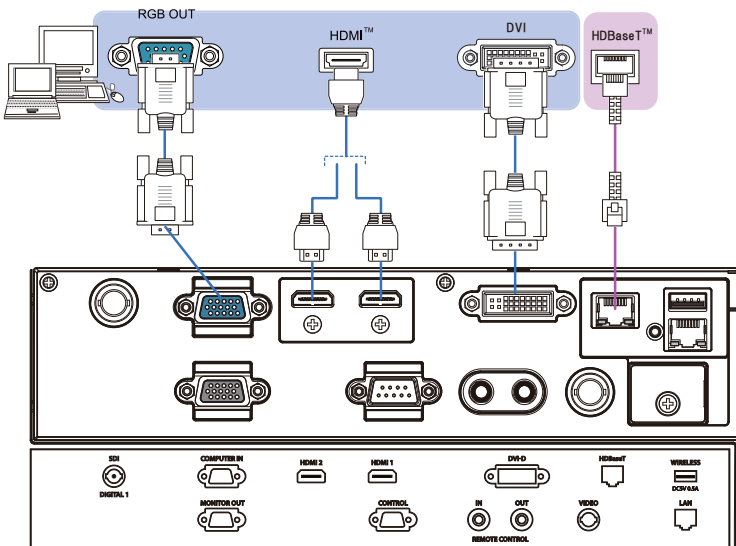

NOTE • Before connecting the projector to a computer, consult the computer's manual and check the compatibility of the signal level, the synchronization methods and the display resolution output to the projector.

- Some signal may need an adapter to input this projector.
- Some computers have multiple screen display modes that may include some signals which are not supported by this projector.
- Although the projector can display signals with a resolution up to UXGA (1600x1200) or up to W-UXGA (1920x1200) for **DWU951**, the signal will be converted to the projector's panel resolution before being displayed. The best display performance will be achieved if the resolutions of the input signal and the projector panel are identical.
- If you connect this projector and a notebook computer, you need output the display to an external monitor, or output simultaneously to the internal display and an external monitor. Consult the computer's manual for the setting.
- Depending on the input signal, the automatic adjustment function of this projector may take some time and not function correctly.
- Note that a composite sync signal or sync-on-green signal may confuse the automatic adjustment function of this projector (40).
- If the automatic adjustment function does not work correctly, you may not see the dialog to set the display resolution. In such a case, use an external display device. You may be able to see the dialog and set an appropriate display resolution.

DWU951/DWX951/DXG1051

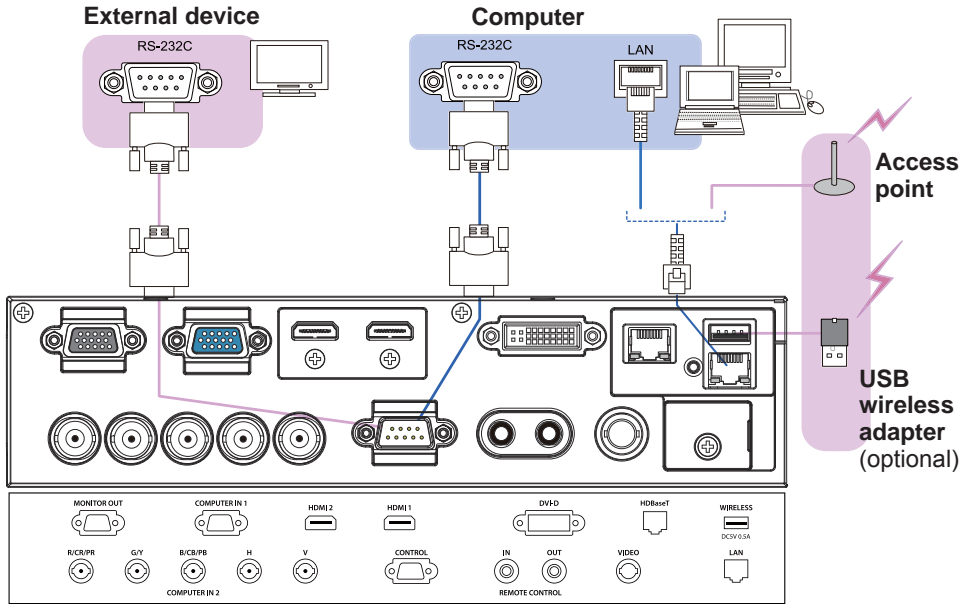

DHD951

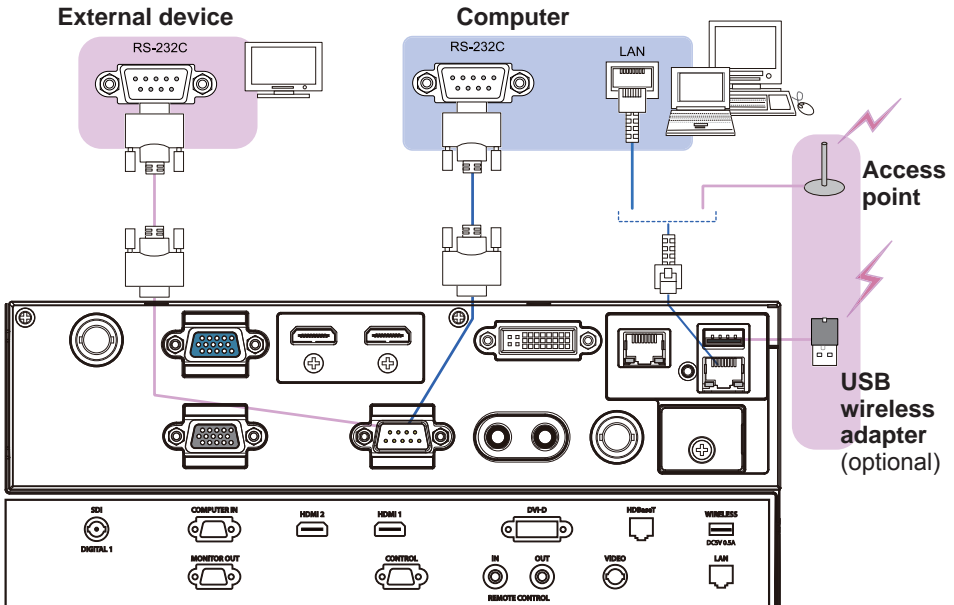

⚠ **WARNING** ▶ Heat may build up in the USB wireless adapter, to avoid possible burns disconnect the projector power cord for 10 minutes before touching the adapter.

⚠ **CAUTION** ▶ Before connecting the projector to a network system be sure to obtain the consent of the administrator of the network.

▶ Do not connect the **LAN** port to any network that might have the excessive voltage.

▶ The designated USB wireless adapter that is sold as an option is required to use the wireless network function of this projector. Before connecting the USB wireless adapter, turn off the power of the projector and disconnect the power cord. Do not use any extension cable or device when connecting the adapter to the projector.

DWU951/DWX951/DXG1051

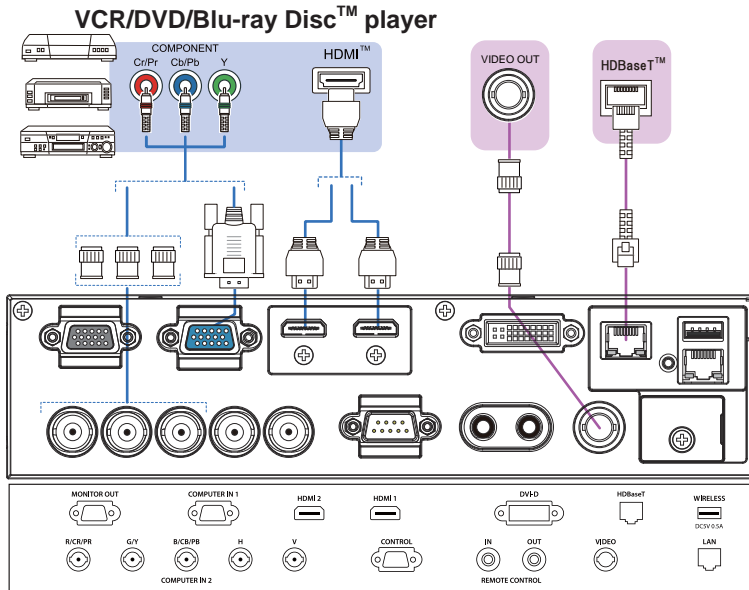

DHD951

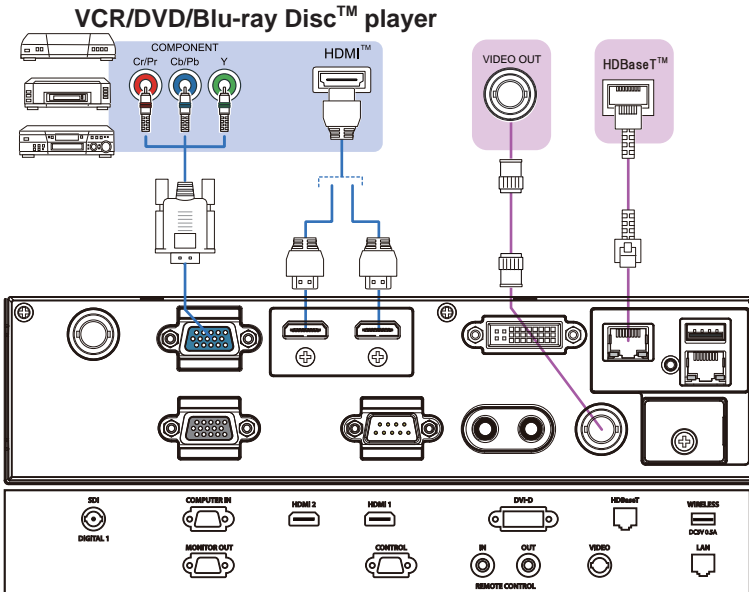

About HDBaseT™ connection

- HDBaseT is a technology to transmit image, sound, ethernet or serial control signal via LAN cable.
- Please go to the following URL regarding the device of other company that supports HDBaseT and has been confirmed compatible with this projector.

<http://www.christiedigital.com>

LAN or HDBaseT input port can be selected as ethernet signal input by switching in the menu.

- Use LAN cables of up to 100m long. Exceeding this length, the image and sounds will be deteriorated, and even experience malfunction on LAN transmission.

NOTE • The **HDMI** ports of this model are compatible with HDCP (High-bandwidth Digital Content Protection) and therefore capable of displaying video signals from HDCP compatible DVD players or the like.

- The **HDMI** ports support the following signals:

Video signal : 480i@60, 480p@60, 576i@50, 576p@50, 720p@50/60,
1080i@50/60, 1080p@50/60

PC signals : See User's Manual (detailed) Technical

- This projector can be connected with another equipment that has HDMI™ connector, but with some equipments the projector may not work properly, something like no video.
- Qualified cable is required for HDBaseT connection (📖 above).
- Be sure to use an HDMI™ cable that has the HDMI™ logo.
- Use a Category 2-certified HDMI™ cable to input 1080p@50/60 signal to the projector.
- The HDMI™ cables might come off easily due to the lack of a mechanical lock on the cables and connectors. It is recommended to fasten the cables to the projector to prevent the cables from coming off (📖22).

DWU951/DWX951/DXG1051

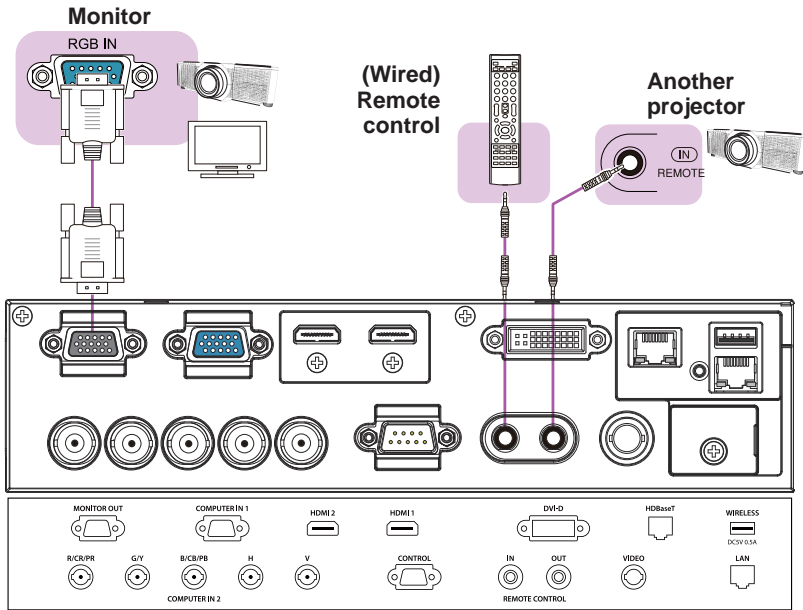

DHD951

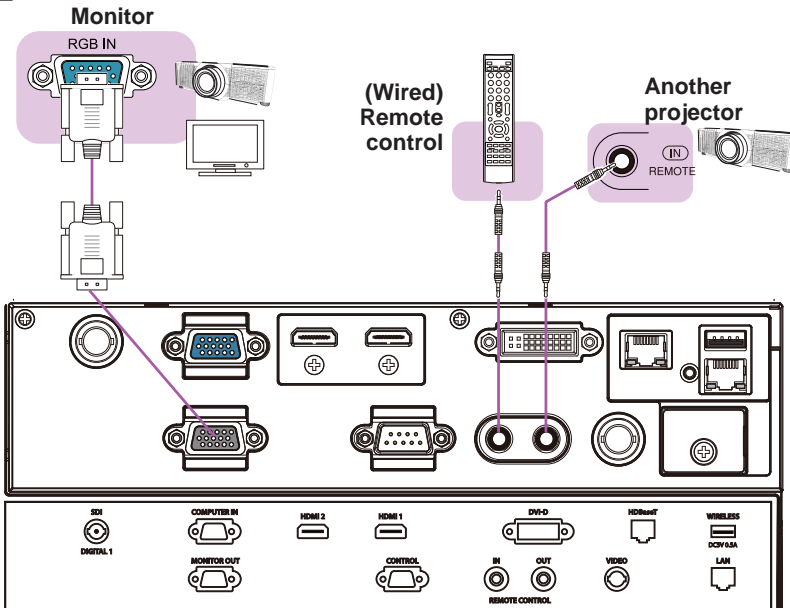

NOTE • To use a wired remote control, connect a wired remote control to the **REMOTE CONTROL IN** port. You can also connect another projector to the **REMOTE CONTROL OUT** port to control it from the wired remote control. You can utilize this projector as a remote control-relay with the **REMOTE CONTROL IN** and **OUT** ports. To connect the wired remote control or another projector to the **REMOTE CONTROL IN** or **OUT** ports, use audio cables with 3.5 mm diameter stereo mini plugs. This function is useful when a wireless remote signal may not reliably reach the projector.

DHD951

Camera for commercial use, etc.

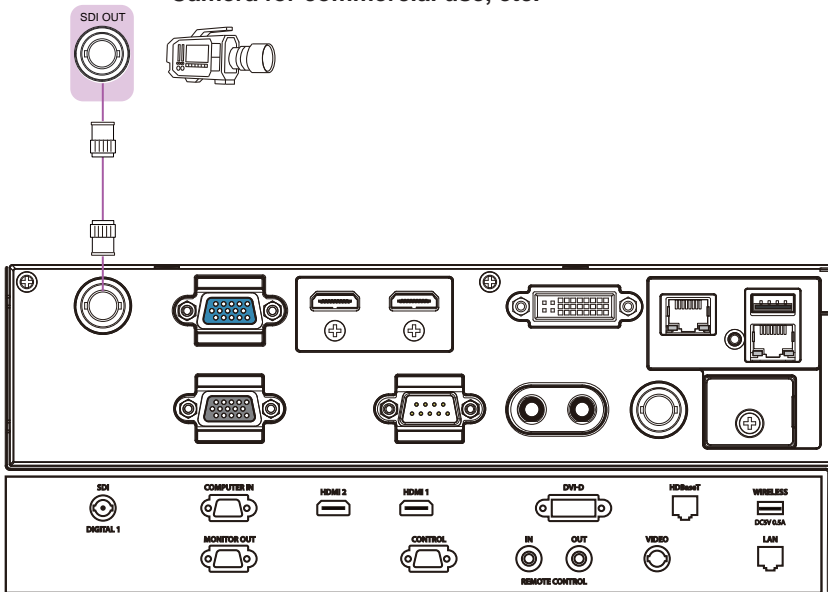

NOTE • The **SDI** port of this model supports the following SDI signals:

SD-SDI signal: conforming to SMPTE ST 259-C standard

YCBCR 4:2:2 10-bit

480i, 576i

Single link HD-SDI signal: conforming to SMPTE ST 292 standard

YPBPR 4:2:2 10-bit

720p@50/60, 1080i@50/60, 1080sf@25/30

3G-SDI Level-A signal: conforming to SMPTE ST 424 standard

YPBPR 4:2:2 10-bit

1080p@50/60

- This projector can be connected with another equipment that has SDI connector, but with some equipments the projector may not work properly.
- Use a cable of 5CFB or greater (5CFB, 7CFB, etc.), or Belden 1694A or greater to transmit the image properly. And use a cable with a length of 100m or less.
- Setting by MENU is necessary depending on a connected device.

Setting up

Fastening the cables

Use the supplied cable tie to fasten the cables.

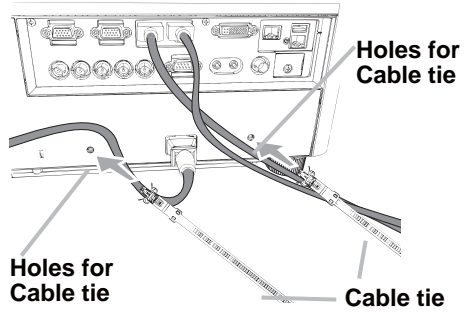

⚠ CAUTION ▶ Use only a plastic tie to get together or fasten the cables. A metallic tie may cause damage to the cables and tie holder.
▶ Do not bind the cables too tightly. The cables or the hole might be damaged.

Fastening the adapter cover

When using the USB wireless adapter, use the supplied adapter cover to avoid possible burns.

USB wireless adapter: USB-WL-11N-NS

Temperature range: 0 ~ 45°C(operating)

1. Loosen the screw (marked with triangle) on the bottom left of the **WIRELESS** port.

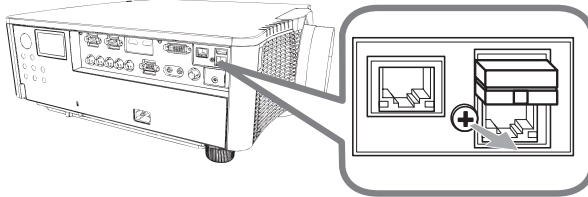

2. Insert the tab of the cover into the hole at the upper right of the **WIRELESS** port in the direction of the arrow.

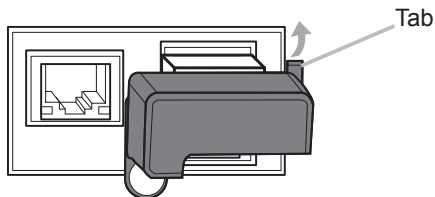

3. Align the screw holes on the projector and the cover. Then insert the screw removed from the projector into the hole and tighten the screw.

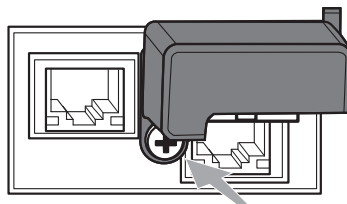

⚠ WARNING ▶ Keep small parts away from children and pets. Take care not to put in the mouth.

▶ Heat may build up in the USB wireless adapter, to avoid possible burns disconnect the projector power cord for 10 minutes before touching the adapter.

Using the security bar and slot

A commercially available anti-theft chain or wire can be attached to the security bar on the projector. Refer to the figure to choose an anti-theft chain or wire.

Also this product has the security slot for the Kensington lock.

For details, see the manual of the security tool.

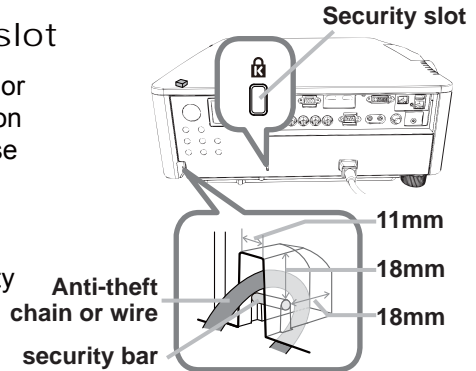

⚠ WARNING ► Do not use the security bars and slot to prevent the projector from falling down, since it is not designed for it.

⚠ CAUTION ► Do not place anti-theft chain or wire near the exhaust vents. It may become too hot.

NOTE

- The security bar and slot is not comprehensive theft prevention measures. It is intended to be used as supplemental theft prevention measure.
- The safety bar can be used for the same purpose as the security bar.

Connecting to a power supply

1. Insert the connector of the power cord into the **AC** (AC inlet) of the projector.
2. Firmly plug the power cord's plug into the outlet. In a couple of seconds after the power supply connection, the **POWER** indicator will light up in steady orange.

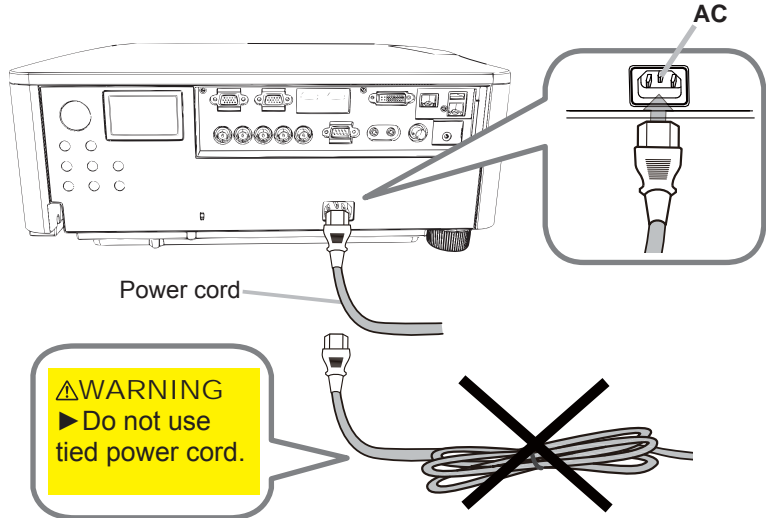

Please remember that when the DIRECT POWER ON function activated (📖 97), the connection of the power supply make the projector turn on.

⚠️ WARNING ▶ Do not connect the projector to a power supply while no lens unit is attached to it.

▶ Please use extra caution when connecting the power cord, as incorrect or faulty connections may result in fire and/or electrical shock.

- Do not touch the power cord with a wet hand.
- Only use the power cord that came with the projector. If it is damaged, consult your dealer to get a new one. Never modify the power cord.
- Only plug the power cord into an outlet whose voltage is matched to the power cord. The power outlet should be close to the projector and easily accessible. Remove the power cord for complete separation.
- Do not distribute the power supply to multiple devices. Doing so may overload the outlet and connectors, loosen the connection, or result in fire, electric shock or other accidents.
- Connect the ground terminal for the AC inlet of this unit to the ground terminal of the building using an appropriate power cord (bundled).

NOTICE • This product is also designed for IT power systems with a phase-to-phase voltage of 220 to 240 V.

Remote control

Installing the batteries

Please insert the batteries into the remote control before using it. If the remote control starts to malfunction, try to replace the batteries. If you will not use the remote control for long period, remove the batteries from the remote control and store them in a safe place.

1. Holding the hook part of the battery cover, remove it.
2. Align and insert the two AA batteries (**HITACHI MAXELL , Part No.LR6 or R6P**) according to their plus and minus terminals as indicated in the remote control. (Batteries not included.)
3. Replace the battery cover in the direction of the arrow and snap it back into place.

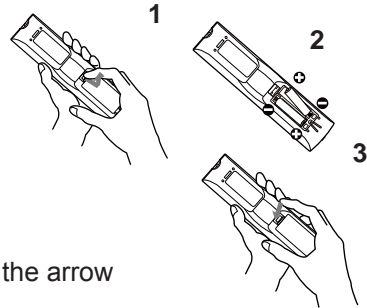

⚠ WARNING ▶ Always handle the batteries with care and use them only as directed. Improper use may result in battery explosion, cracking or leakage, which could result in fire, injury and/or pollution of the surrounding environment.

- Be sure to use only the batteries specified. Do not use batteries of different types at the same time. Do not mix a new battery with used one.
- Make sure the plus and minus terminals are correctly aligned when loading a battery.
- Keep a battery away from children and pets.
- Do not recharge, short circuit, solder or disassemble a battery.
- Do not place a battery in a fire or water. Keep batteries in a dark, cool and dry place.
- If you observe battery leakage, wipe out the leakage and then replace a battery. If the leakage adheres to your body or clothes, rinse well with water immediately.
- Obey the local laws on disposing the battery.

Using the REMOTE ID function

Utilize this function to control specific projectors by the remote control assigned the same ID number when you use multiple projectors of the same type at the same time.

Assign an ID number to each projector before using the REMOTE ID item in the SERVICE menu of the OPTION menu (📖 95). Press the **ID** button with the same ID number as assigned to the projector you are going to control. The **ID** button selected will light for several seconds.

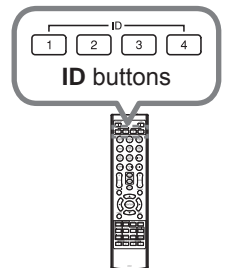

NOTE • Each time you press any button (except **ID** buttons), the **ID** button of current selected ID number will light.

- To confirm the projector's current ID, press any **ID** button for 3 seconds. Its number will be shown on each screen regardless of set ID of projector.

Changing the frequency of remote control signal

The accessory remote control has the two choices on signal frequency Mode 1:NORMAL and Mode 2:HIGH. If the remote control does not function properly, attempt to change the signal frequency.

In order to set the Mode, please keep pressing the combination of two buttons listed below simultaneously for about 3 seconds.

- (1) Set to Mode 1:NORMAL
SHUTTER and
MY BUTTON-4 buttons
- (2) Set to Mode 2:HIGH
LENS SHIFT and
MY BUTTON-1 buttons

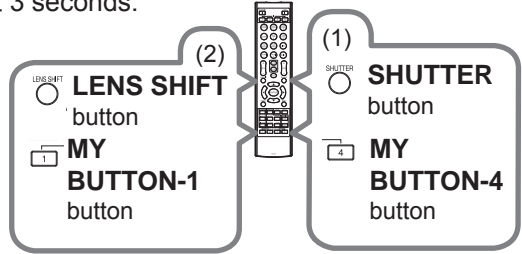

Please remember that the REMOTE FREQ. in the SERVICE item of the OPTION menu (☞ 95) of the projector to be controlled should be set to the same mode as the remote control.

About the remote control signal

The remote control works with the projector's remote sensor. This projector has two remote sensors on the front and back sides.

The sensors can sense signals within the following range:

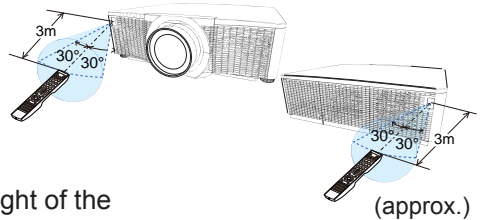

60 degrees (30 degrees to the left and right of the sensor) within 3 meters about.

- NOTE** • You can deactivate one of the sensors using the REMOTE RECEIV. item in the SERVICE menu of the OPTION menu (☞ 95) .
- The remote control signal reflected in the screen or the like may be available. If it is difficult to send the signal to the sensor directly, attempt to make the signal reflect.
 - The remote control uses infrared light to send signals to the projector (Class 1 LED), so be sure to use the remote control in an area free from obstacles that could block the remote control's signal to the projector.
 - The remote control may not work correctly if strong light (such as direct sun light) or light from an extremely close range (such as from an inverter fluorescent lamp) shines on the remote sensor of the projector. Adjust the position of projector avoiding those lights.
 - The projector cannot receive a remote signal from the connected equipments via HDBaseT™, while the projector is receiving a signal directly from the projector's remote sensor.
 - The projector cannot receive a remote signal from the connected equipments via HDBaseT™, right after turning the power on.

Status Monitor

The Status Monitor is the sub LCD in the side panel that displays the information in the following.

- Current status of the projector. (📖 31)
- Error log. (📖 31)
- Lamp log. (📖 32)
- Filter log. (📖 33)
- Network information. (📖 33)

You can execute the following operation in the Status Monitor.

- Lamp Time reset (📖 32)

Displaying the condition of the projector

If no buttons are pressed, the Status Monitor displays the current status (Normal, Warning or Error) as below.

•Normal (example).(📖 30)

```
COMPUTER IN 1
1600x1200@100
AC240V 35°C
```

•Warning (example).(📖 31)

```
A I R
```

•Error (example).(📖 31)

```
LAMP 1
```

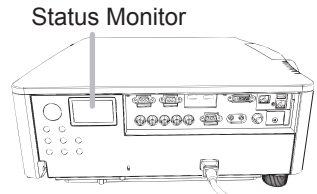

NOTE • The Status Monitor displays nothing while the projector is in standby mode if the STANDBY MODE item of SETUP menu is set to POWER SAVE (📖 79).
 • When INSTALLATION in the SETUP menu is set to FRONT / CEILING or REAR / CEILING, the contents on the Status Monitor are displayed upside down (📖 79).

Switching the display

You can switch the display to see Error log , Lamp log , Filter log and Network information.

•When Normal or Warning is displayed:

1.Press one of the following buttons.

- 1) FUNCTION button on the control panel
- 2) ENTER button on the remote control for 3 sec.
- 3) MY BUTTON button on the remote control which assigned as STATUS MONITOR. (92)

2. Backlight turns on, and you can switch the display by pressing the ▲/▼ or ◀/▶ buttons.

•When Error is displayed:

You can switch the display by pressing the ▲/▼ or ◀/▶ buttons.

NOTE • While the projector is warming up, buttons are not available.

- The Status Monitor and its backlight returns to the first state if the following occurs.
 - Any button except cursor buttons is pressed.
 - No button is pressed for about 30 seconds.
- The Status Monitor and the OSD menu cannot be operated at the same time.

1.The current status and error log (37)

2.Lamp log (32)

3.Filter log (33)

4.Network information (33)

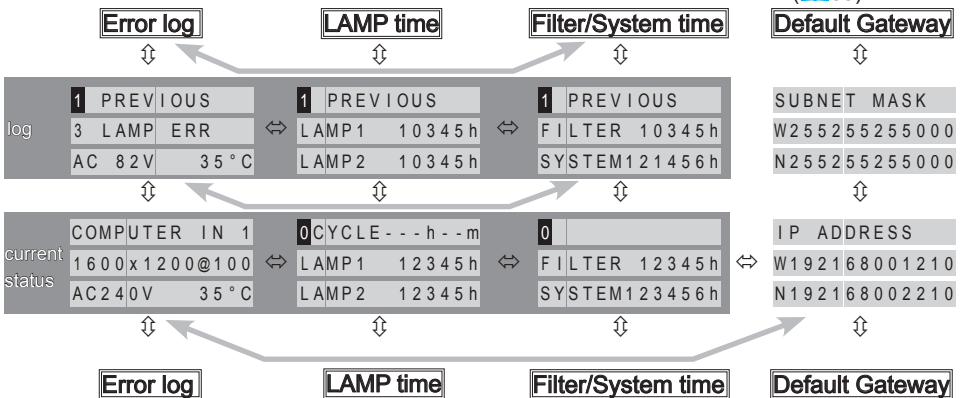

○ In a normal state

The Status Monitor displays the state of the projector in three lines.

1st line: Displays the condition of the projector. While the lamp is on, the selected port is displayed.

Displayed conditions are as below;

STANDBY: The projector is in standby mode.

WARM UP: The projector is warming up.

SEARCHING: The projector is searching an input signal.

COOL DOWN: The projector is cooling down.

2nd line: Displays the condition of the detected input signal while the lamp is on. Otherwise, displays the serial number of the projector.

Displayed conditions are as below;

SYNC OUT: Detected input signal is out of specified range.

NO SIGNAL: There is no input signal.

CONNECTED: The projector has connected to the network or the computer and some image is transferred to the projector while the LAN is selected.

HOLD: The projector has connected to the network but no image is transferred while the LAN port is selected.

NOT CONNECTED: The projector is not connected to the network or the computer while the LAN port is selected.

3rd line: Displays supplied voltage and peripheral temperature in Celsius while the lamp is on.

NOTE

- While the projector is searching an input signal in normal condition, nothing is displayed on the 2nd line of the monitor.
- Displayed temperature may be different from actual peripheral temperature because the displayed temperature is measured inside the projector.

The current status (Warnings and Errors)

The Status Monitor displays a warning or an error with larger letters. When it is displayed, refer to the table "Related messages" ([Troubleshooting](#)) or "Regarding the indicator lamps" ([114](#))

Warnings;

AIR (AIR FLOW): The internal temperature is rising.

Refer to the message "There is a possibility that the interior portion has become heated" in the table "Regarding the indicator lamps" ([114](#))

COLD: The inside of the projector is cooled excessively.

FILTR: It is time to clean the air filter.

SHUTR: Shutter Error

SHIFT: Lens Shift Error

LAMP1: Lamp 1 Warning

LAMP2: Lamp 2 Warning

HUMID: Humidity is too high.

C.WHL: Error of one of the two color wheels

IRIS: Dynamic Iris Error

Refer to the table "Regarding the indicator lamps". ([114](#))

Errors;

COVER: The lamp cover has not been fixed properly.

FAN: The cooling fan is not operating.

LAMP: Error of both lamps.

TEMP: The inside of the projector is overheating.

OTHER: Errors other than the above

Refer to the table "Regarding the indicator lamps". ([114](#))

NOTE • The backlight blinks when an error is displayed.

Error log

Press the ▲ button to display previous error log when the current status is displayed with the backlight on. Up to 10 error logs can be displayed. The log contains the log number, occurred error, the supplied voltage and peripheral temperature at that time. Press the ► button to display the usage time in the Lamp log ([32](#)) and the Filter log ([33](#)) when each error occurred.

NOTE • If no error or less than 10 errors have occurred, "NO DATA" is displayed in spite of occurred error in the error log.

Lamp log

Displays the usage time of the lamp1 & 2, and executes Lamp Time Reset. You can display previous logs by pressing the ▲ button.

Usage time;

- Displays remaining cycle time and the lamp 1 & 2 usage time.

Lamp Time Reset;

- The lamp 1 & 2 usage time shall be reset when changing the lamp(s).
1. Display the Lamp log and press INPUT button on the control panel or ENTER button on the remote control.
 2. Select LAMP1 or LAMP2 by pressing INPUT or ENTER button, and press the ► button.
 3. Select OK by pressing INPUT, ENTER or the ▲ button in the LAMP RESET display
 4. Press the ► button to execute the Lamp Time reset.

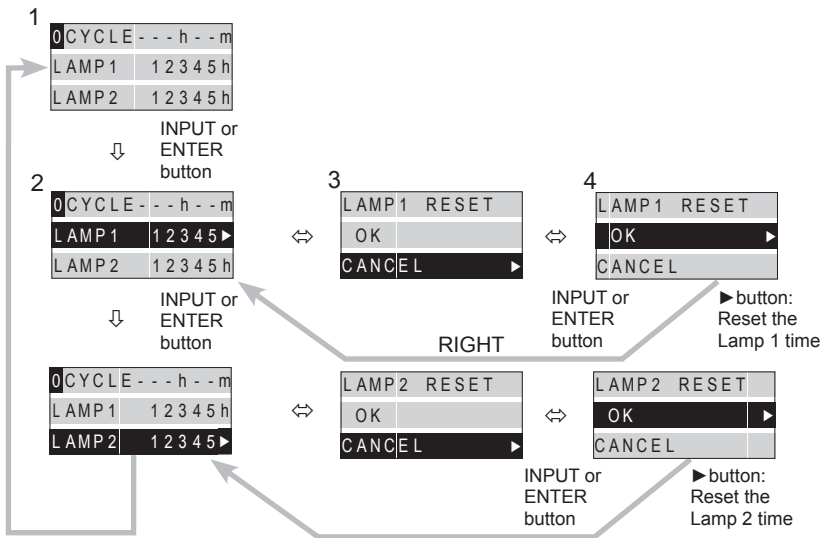

NOTE • Lamp Time Reset can also be executed in the SETUP of the ADVANCED MENU (77).

Filter log

Displays the usage time of the filter and projector. You can display previous logs by pressing the ▲ button.

NOTE • The system usage time is the total lamp time from the projector is manufactured. It cannot be reset.

Network information

The network information is displayed on three pages. You can refer IP address, Subnet mask and Default gateway each for wireless and wired settings. Use the ▲/▼ buttons to switch the page.

Displayed information in each page is as below;

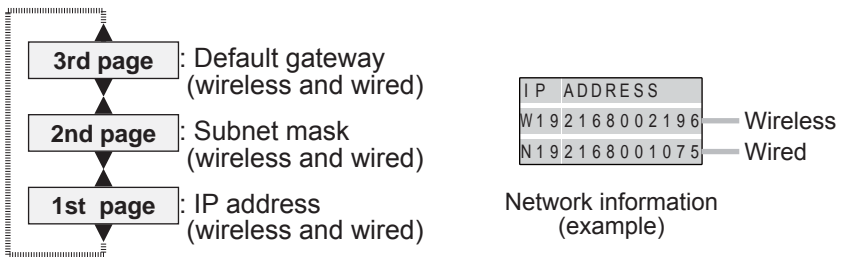

NOTE • Network information is available only by switching from the display of the Filter log with log number 0. Refer to the flow chart in “Switching the display”. (P.29)

Power on/off

Turning on the power

1. Make sure that the power cord is firmly and correctly connected to the projector and the outlet.
2. Make sure that the **POWER** indicator is lighted in steady orange (📖 114).
3. Press **STANDBY/ON** button on the projector or the **ON** button on the remote control.
The projection lamp will light up and **POWER** indicator will begin blinking in green. When the power is completely on, the indicator will stop blinking and light in steady green (📖 114).

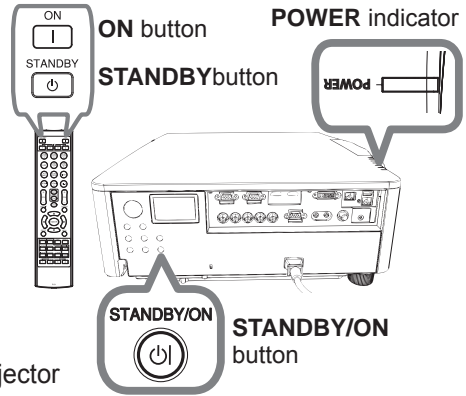

To display the picture, select an input signal according to the section **Selecting an input signal** (📖 35).

Turning off the power

1. Press the **STANDBY/ON** button on the projector or the **STANDBY** button on the remote control.
The message “Power off?” will appear on the screen for about 5 seconds.
2. Press the **STANDBY/ON** or **STANDBY** button again while the message appears.
The projector lamp will go off, and the **POWER** indicator will begin blinking in orange. Then the **POWER** indicator will stop blinking and light in steady orange when the lamp cooling is complete (📖 114).

Do not turn the projector on for about 10 minutes or more after turning it off. Also, do not turn the projector off shortly after turning it on. Such operations might cause the lamp to malfunction or shorten the lifetime of some parts including the lamp.

⚠️ WARNING ▶ A strong light is emitted when the projector’s power is on. Do not look into the lens of the projector or look inside of the projector through any of the projector’s openings.
▶ Do not touch around the lamp cover and the exhaust vents during use or just after use, since it is too hot.

NOTE • Turn the power on/off in right order. Please power on the projector prior to the connected devices.
• This projector has the function that can make the projector automatically turn on/off. Please refer to the **DIRECT POWER ON** (📖 97) and **AUTO POWER OFF** (📖 97) items of the **OPTION** menu.

Operating

Selecting an input signal

1. Activate your signal source. Turn the signal source on, to send signal to the projector.
2. Press the **INPUT** button on the projector.
Each time you press the button, the projector switches its input port in turn. You can also use the remote control to select an input signal. Select from the buttons for input ports as the following.

DWU951/DWX951/DXG1051

COMPUTER IN1 ⇨ COMPUTER IN2 ⇨ HDMI 1 ⇨ HDMI 2



LAN ⇨ VIDEO ⇨ HDBaseT ⇨ DVI-D

DHD951

COMPUTER IN ⇨ HDMI 1 ⇨ HDMI 2 ⇨ DVI-D



LAN ⇨ VIDEO ⇨ SDI/DIGITAL 1 ⇨ HDBaseT

DWU951/DWX951/DXG1051

DHD951

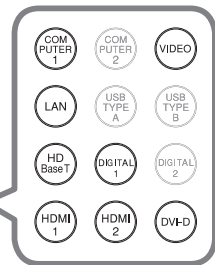
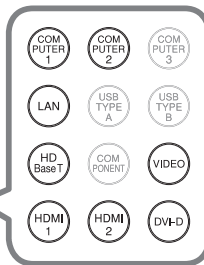
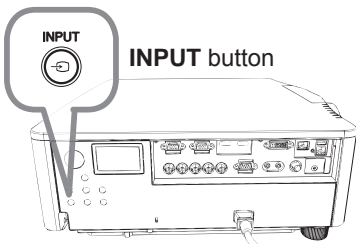

Buttons for input ports

NOTE • If you have set SKIP to some ports from SOURCE SKIP in the OPTION menu, the input from the ports cannot be selected (90).
• While ON is selected for AUTO SEARCH item in OPTION menu, the projector will keep checking the ports in above order repeatedly till an input signal is detected (90).

Selecting an aspect ratio

1. Press **ASPECT** button on the remote control.
 Each time you press the button, the projector switches the mode for aspect ratio in turn.

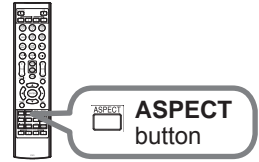

○ **For a computer signal**

DXG1051:

NORMAL → 4:3 → 16:9 → 16:10
 ↑

DWX951, DHD951, DWU951:

NORMAL → 4:3 → 16:9 → 16:10 → NATIVE
 ↑

○ **For an HDMI™ signal**

DXG1051:

NORMAL → 4:3 → 16:9 → 16:10 → 14:9
 ↑

DWX951, DHD951, DWU951:

NORMAL → 4:3 → 16:9 → 16:10 → 14:9 → NATIVE
 ↑

○ **For a video signal**

DXG1051:

4:3 → 16:9 → 14:9
 ↑

DWX951, DHD951, DWU951:

4:3 → 16:9 → 16:10 → 14:9 → NATIVE
 ↑

○ **For a SD/DIGITAL 1 signal (DHD951 only)**

NORMAL → 4:3 → 16:9 → NATIVE
 ↑

○ **For an input signal from the LAN, or if there is no signal**

DXG1051: 4:3 (fixed)

DWX951, DWU951: 16:10 (fixed)

DHD951: 16:9 (fixed)

NOTE • **ASPECT** button does not work when no proper signal is inputted.
 • **NORMAL** mode keeps the original aspect ratio setting.

Adjusting the projector's elevator

Lengthening or shortening the length of the elevator feet shifts the projection position and the projection angle.
Turn the elevator feet each to adjust their length.

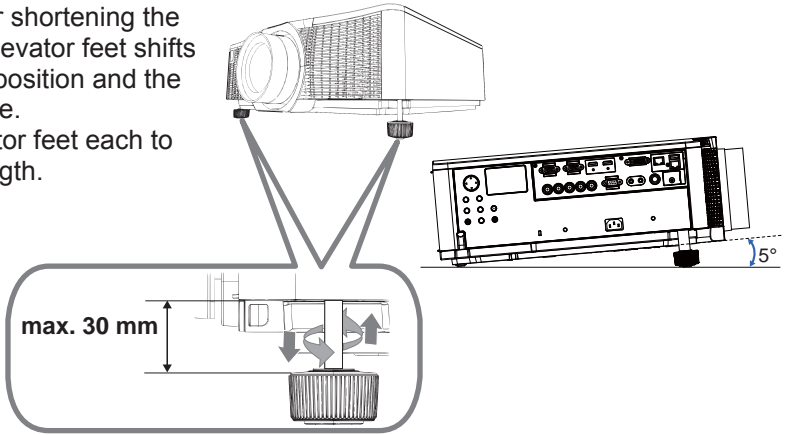

⚠ WARNING ▶ Do not lengthen the elevator feet exceeding 30 mm. The foot lengthened exceeding the limit may come off and drop the projector down, and result in an injury or damaging the projector.

⚠ CAUTION ▶ Do not place the projector with an inclination exceeding 5 degrees. The projector leaned exceeding the limit could cause malfunction and shorten the life of the projector.

Installation angle

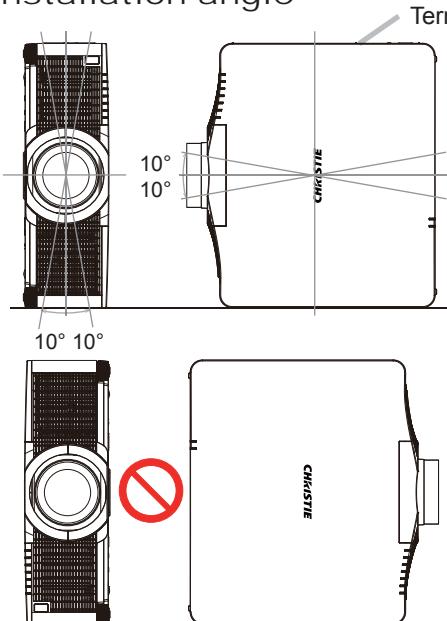

Vertical and horizontal direction in portrait mode

The projector may be installed at horizontal angle of $\pm 10^\circ$.

The projector may be installed at vertical angle of $\pm 10^\circ$.

NOTE

- The terminal side of the projector must face upward for vertical installations.
- If other error has occurred. Please check installation. Install the projector correctly, and restart it.
- When using portrait mode, the service life of a lamp becomes shorter.

Adjusting the lens

Adjusting the zoom and focus

The ZOOM or FOCUS dialog will appear when you press any of the buttons from **ZOOM**, **ZOOM -**, **ZOOM +**, **FOCUS +** and **FOCUS -**.

1. Use the **ZOOM + / -** buttons to adjust the screen size.
2. Use the **FOCUS + / -** buttons to focus the picture.

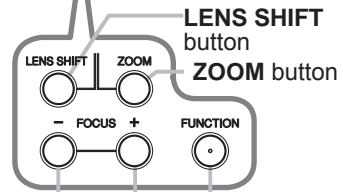
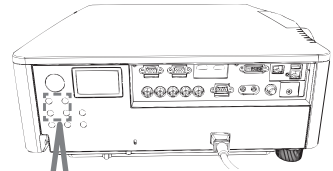
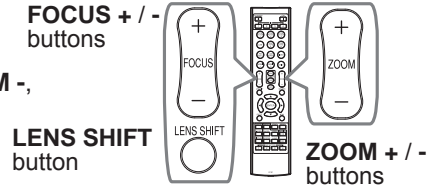

FOCUS - / + buttons **FUNCTION** button



NOTE • The projector may ignore operation by other buttons while the lens is moving.

Adjusting the lens position

Press the **LENS SHIFT** button. The LENS SHIFT dialog will appear. Using the **▲/▼/◀/▶** buttons while the dialog is displayed shifts the lens. Generally, better image quality can be got when the lens is set to the center.

Press the **LENS SHIFT** button again to exit the LENS SHIFT function.

CENTERING

Press the **ENTER** or **INPUT** button while the dialog is displayed to execute the CENTERING feature, which adjusts the lens to the center. A message dialog is displayed for confirmation. Pressing the **▶** button performs CENTERING. You can also perform CENTERING in the standby mode by pressing the **FUNCTION** and **LENS SHIFT** buttons on the control panel for 3 seconds at the same time.

⚠ CAUTION ▶ Do not put your fingers or any other things around the lens. The moving lens could catch them in the space around the lens and result in an injury.

NOTE • While the lens is moving to the center, the menu will disappear and an hourglass icon will appear on the screen. CENTERING may take some time till the lens reaches the center.

- The projector may ignore operation by buttons while moving the lens.
- The CENTERING feature while the projector is in the standby mode is disabled if the STANDBY MODE item of SETUP menu is set to POWER SAVE. Perform CENTERING before the projector's power is turned off, or set the STANDBY MODE to NORMAL.
- The adjustable range of LENS SHIFT varies depending on the lens unit mounted on the projector to maintain picture quality. Therefore LENS SHIFT adjustment may not reach the end of the indicator in the dialog, and that is not a failure.

Lens memory

This projector is equipped with memory functions for the lens adjustments (ZOOM, FOCUS, LENS SHIFT and LENS TYPE). Up to 3 sets of adjustments can be stored.

To utilize the lens memory feature, press the LOAD or FUNCTION button while the LENS SHIFT dialog is displayed, or press ▲ button while the ZOOM or FOCUS dialog is displayed. Then the LENS MEMORY dialog will appear. The current lens adjustments are displayed on the "CURRENT" line. The adjustments already stored in the lens memory are displayed on the lines of SAVE and LOAD-1 to 3.

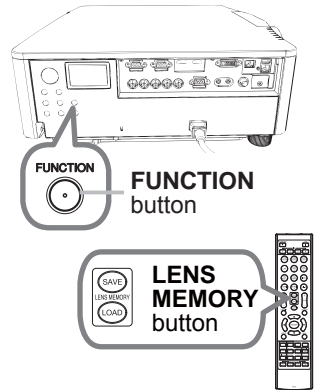

○ **SAVE:**

To utilize the save lens memory feature, press the ► button while CURRENT is selected on LENS MEMORY dialog or press the SAVE button on the remote control. To store the current lens adjustments, select one of the "SAVE" options numbered 1 to 3 (number of the lens memory) and press the ► or **ENTER** button, while LENS MEMORY OSD is displayed.

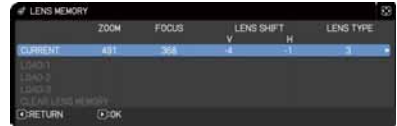

Remember that the current data being stored of a memory will be lost by saving new data into the memory.

○ **LOAD:**

To recall stored adjustments, select one of the "LOAD" options numbered 1 to 3 (number of the lens memory) and press the ► or **ENTER** button, while LENS MEMORY OSD is displayed.

Remember that the current adjusted condition will be lost by loading data. If you want to keep the current adjustment, please save it before performing a LOAD function.

○ **CLEAR LENS MEMORY:**

To clear the adjustment stored in a lens memory, select CLEAR LENS MEMORY and press the ► or **ENTER** button, while LENS MEMORY OSD is displayed. Press the ► button. A message dialog is displayed for confirmation. Press the ► button again to clear all of the lens memory.

NOTE • The projector may ignore operation by buttons while moving the lens.

Lens lock

Using the **LOCK** buttons turns on/off the lens lock feature. When ON is selected, the buttons (ZOOM, ZOOM + / -, FOCUS + / -, LENS SHIFT, LENS MEMORY) are locked.

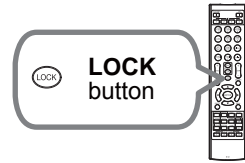

Using the automatic adjustment feature

1. Press **AUTO** button on the remote control.
- Pressing this button performs the following.

- **For a computer signal**

The vertical position, the horizontal position and the horizontal phase will be automatically adjusted.

Make sure that the application window is set to its maximum size prior to attempting to use this feature. A dark picture may still be incorrectly adjusted. Use a bright picture when adjusting.

- **For a video signal**

The video format best suited for the respective input signal will be selected automatically. This function is available only when the AUTO is selected for the VIDEO FORMAT item in the INPUT menu (📖 70). The vertical position and horizontal position will be automatically set to the default.

- **For a component video signal**

The vertical position and horizontal position will be automatically set to the default. The horizontal phase will be automatically adjusted.

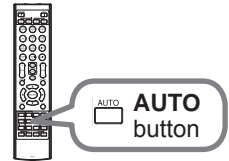

NOTE • The automatic adjustment operation requires approx. 10 seconds. Also please note that it may not function correctly with some input.

- When this function is performed for a video signal, a certain extra such as a line may appear outside a picture.
- When this function is performed for a computer signal, a black frame may be displayed on the edge of the screen, depending on the computer model.
- The items adjusted by this function may vary when the FINE or DISABLE is selected for the AUTO IMAGE ADJUST item of the SERVICE item in the OPTION menu (📖 93).

Other buttons

HDCR: Displays the HDCR menu (📖 64).

C.WHEEL: Displays the COLOR WHEEL menu (📖 65).

OSD: Displays the OSD MESSAGE menu (📖 86), and it switches the function by pressing the button again.

ON ⇄ OFF ⇄ HIDE

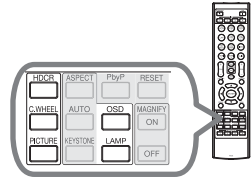
All message functions do not work by selecting HIDE.

• To change this function, follow the steps below.

1. Press the OSD button on the remote control for 3 sec.
2. The HIDE OSD will be displayed.
While this OSD is displayed, press the OSD button again on the remote control.
3. Toggle and change the function.

PICTURE: Switches the PICTURE MODE (📖 59).

Standard	⇄	Natural	⇄	Cinema	⇄	Dynamic
⇅						⇅
USER-3						BOARD(BLACK)
⇅						⇅
USER-2						BOARD(GREEN)
⇅						⇅
USER-1	⇄	DICOM SIM.	⇄	DAYTIME	⇄	WHITEBOARD

LAMP: Displays the LAMP & FILTER menu (📖 76).

Geometry correction

The projector is equipped with the Geometry correction feature as below.

- KEYSTONE
- 3D KEYSTONE
- BLENDING
- WARPING
- Camera Feedback

For details, refer to the following pages.

NOTE • KEYSTONE, 3D KEYSTONE, EDGE BLENDING and WARPING functions are mutually exclusive.

- When entering ▼ in [RETURN] or ▲ [EXIT] of KEYSTONE MENU, 3D KEYSTONE MENU, EDGE BLENDING MENU or WARPING MENU, it switches automatically to KEYSTONE, 3D KEYSTONE / EDGE BLENDING / WARPING.
- MENU is not available and an hour-glass icon is displayed to take effect the settings.

Correcting the distortion

To correct the distortion of projected screen, you can select from two options,KEYSTONE and 3D KEYSTONE. First press the **KEYSTONE** button to display the KEYSTONE menu, and select using the ▲/▼ buttons.

KEYSTONE: allows you to adjust the vertical and horizontal keystone.

3D KEYSTONE: allows you to adjust each of the screen corners and sides to correct the distortion.

Then follow the procedure shown below for the item you selected.

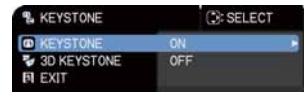

NOTE • The menu or dialog will automatically disappear after several seconds of inactivity. Press the **KEYSTONE** button again, or point the cursor at EXIT in the dialog and press the ◀ or **ENTER** button to end the operation and close the menu or dialog.

○ **KEYSTONE:**

When KEYSTONE is pointed at, pressing the ► or **ENTER** button displays the KEYSTONE dialog.



1. Select SETUP with the ▲/▼ buttons and press the ► or ENTER buttons.
2. Select the vertical or horizontal keystone (⏴ / ⏵) with the ▲/▼ buttons.
3. Use the ◀/▶ buttons to adjust the keystone distortion.

NOTE • When the zoom adjustment is set to the TELE (telephoto focus), this function may be excessive. This function should be used when the zoom adjustment is set to the full WIDE (wide-angle focus) whenever possible.
 • When the horizontal lens shift is not set to the center, this function may not work well.

○ **3D KEYSTONE:**

When 3D KEYSTONE is pointed at, pressing the ► or **ENTER** button displays the 3D KEYSTONE dialog.

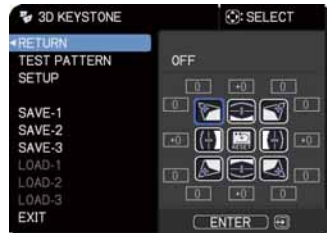

This projector is equipped with a test pattern for 3D KEYSTONE. Select TEST PATTERN with the ▲/▼ buttons, then press the ◀/▶ buttons to switch on and off.

1. Select SETUP with the ▲/▼ buttons and press the ► or ENTER button.
2. Select one of the corners or sides to be adjusted with the ▲/▼/◀/▶ buttons and press the **ENTER** or **INPUT** button.

3. Adjust the selected part as below.

- For adjusting a corner, use the ▲/▼/◀/▶ buttons to adjust the position of the corner.
- For adjusting the upper or lower side, use the ▲/▼ buttons to adjust the distortion of the side.
- For adjusting the left or right side, use the ◀/▶ buttons to adjust the distortion of the side.
- To adjust another corner or side, press the **ENTER** or **INPUT** button and follow the procedure from step 2.

4. This projector is equipped with a memory feature for 3D KEYSTONE adjustment. Up to 3 sets of adjustments can be stored.

• **SAVE1~3:**

To store the current 3D KEYSTONE adjustment, select one of the "SAVE" options numbered 1 to 3 (number of the memory) with the ▲/▼ buttons and press the ▶, **ENTER** or **INPUT** button.

Remember that the current data being stored of a memory will be lost by saving new data into the memory.

• **LOAD1~3:**

To recall stored adjustments, select one of the "LOAD" options numbered 1 to 3 (number of the memory) with the ▲/▼ buttons and press the ▶, **ENTER** or **INPUT** button.

Remember that the current adjusted condition will be lost by loading data. if you want to keep the current adjustment, please save it before performing a LOAD function.

NOTE • The LOAD functions whose linked memory has no data are skipped.
 • There may be some noise and the screen may flicker for a moment when loading data. This is not malfunction.

Using the EDGE BLENDING feature

NOTE • The cable connection for this feature is the same as the INSTANT STACK feature ([Instant Stack Guide](#)), but completely different function and concept. To use as an INSTANT STACK, the settings for this EDGE BLENDING feature should be turned OFF.
 The difference between INSTANT STACK and EDGE BLENDING is;
 INSTANT STACK : To superimpose images projected from two projectors.
 EDGE BLENDING : To superimpose a part of projected image from two projectors, then to one large image.

A part of projected image from two projectors can be superimposed to one large screen by EDGE BLENDING function([75](#)).

1. TEST PATTERN

Select TEST PATTERN with ▲/▼ buttons.

Displayed pattern [Off/1/2] can be switched with ◀/▶ buttons.

TEST PATTERN 1: Red Grid OFF: Displays the input signal.

TEST PATTERN 2: Blue Grid

Display different patterns for two projectors.

It is recommended to use TEST PATTERN, for easy setup.



TEST PATTERN 1 TEST PATTERN 2

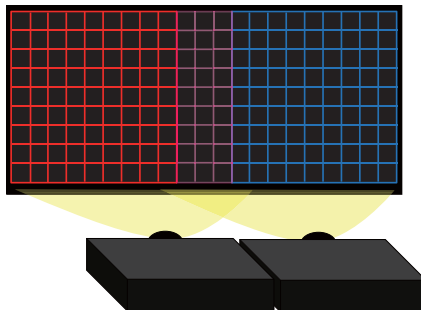

2. SETUP

2.1 Superimpose projected images from two projectors

Select SETUP with ▲/▼ buttons and press ►, ENTER or Input button.

Select 4 Corner with ▲/▼/◀/▶ buttons and press ENTER or Input button.

Adjust 4 Corner with ▲/▼/◀/▶ buttons to superimpose projected images from two projectors.

Press ENTER or Input button again to adjust other corners.

Adjust them referring to the guide displayed during the adjustment.

* Adjust them so that two projected images can be superimposed with over 200 dots.

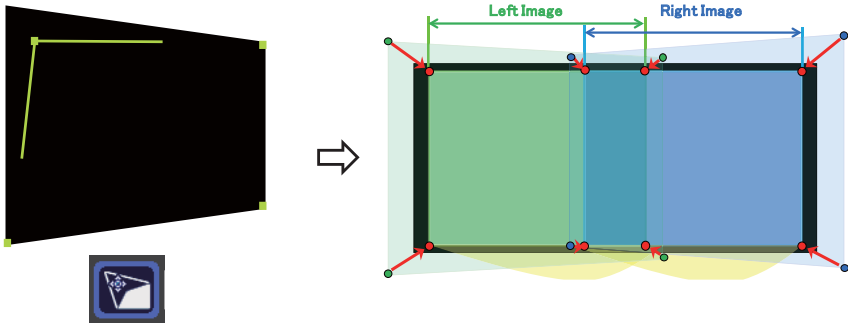

2.2 Specifying Blending Region

Select one of the four sides with ▲/▼/◀/▶ buttons and press ENTER or Input button. Blending Region can be specified for left and right sides with ◀/▶ buttons and for top and bottom sides with ▲/▼ buttons.

Specify Blending Region for each of two projectors.

Adjust them referring to the guide displayed during the adjustment of Blending Region.

* When one of the sides of Blending Region is other than [OFF], other sides of Blending Region cannot be adjusted.

* The minimum value of Blending Region is 200 dots.

* Blending Region of two projectors can be set at a time by just setting Blending Region of one projector. Refer to Instant Stack Guide for details.

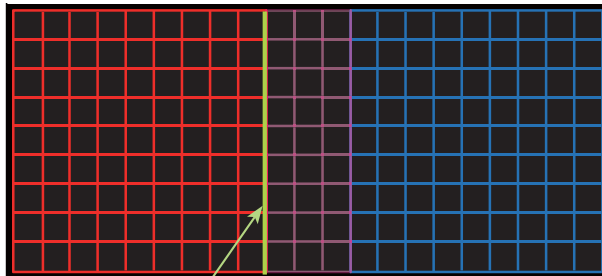

Guide line

3. Cropping

When inputting the same image to each of two projectors, Cropping function enables two projectors to cut out a part of input image and display one image on a large screen.

3.1 Displaying Cropping Menu

Select CROPPING with ▲/▼ buttons and press ►, ENTER or Input button to display Cropping Menu.



3.2 Setting Cropping

Select MODE with ▲/▼ buttons and select ON with ◀/▶ buttons.

Input image is automatically cut out according to the settings of Blending Region.

3.3 Adjusting Cropping Area

Adjust Cropping Area when cutting out a part of input image.

Select SETUP with ▲/▼ buttons and press ►, ENTER or Input button.

* MODE is set to [OFF] temporarily and the guide of Cropping Area is displayed.

Select [XY]/[WH] with ▲/▼ buttons and press ENTER or Input button.

Move the guide display with ▲/▼/◀/▶ buttons to select the region of the screen to be cut out.

Press ENTER or Input button and then press ◀ button to select SETUP, and MODE switches to ON automatically.

Input Image



3. Cropping (continued)

3.4 Adjust Cropping Area of the other projector.

Set Cropping Area of the other projector with the same value as one projector. Input image is automatically cut out according to the settings of Blending Region.

- * When you want to keep input image from not being seen while setting up, set BLANK to ON.
- * Cropping Area of two projectors can be set at a time by just setting Cropping Area of one projector. Refer to Instant Stack Guide for details.

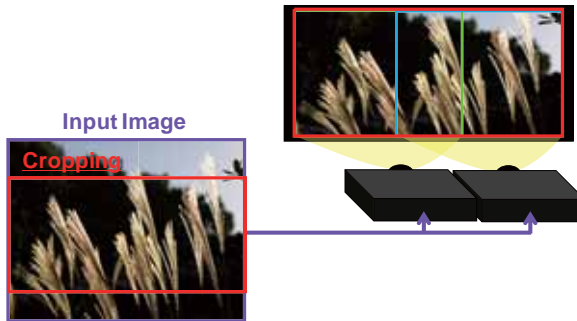

4. Selecting Blending Level

Select BLENDING LEVEL with ▲/▼ buttons.

[NORMAL/BRIGHT/DARK] can be selected with ◀/▶ buttons.

Adjust the brightness of Blending Region according to the settings.

Using the WARPING feature

Projection on several types of screen can be performed by WARPING function. This function is operated by using dedicated PC tool, "Warping Tool". PC and projector are required to be connected with LAN cable in order to use this function.

You can get the PC tool from the URL below.

<http://www.christiedigital.com>

Refer to Application Manual for operations.



Using the Camera Feedback (BLENDING) feature

Camera Feedback (BLENDING) function enables projected image from multiple projectors to be superimposed and displayed as one large screen. This function is operated by using dedicated PC tool, "Blending Tool". PC and projector are required to be connected with LAN cable in order to use this function.

You can get the PC tool from the URL below.

<http://www.christiedigital.com>

Refer to Application Manual for operations.

When operating this function, the following functions cannot be selected and adjusted. KEYSTONE, 3D KEYSTONE, BLENDING, WARPING

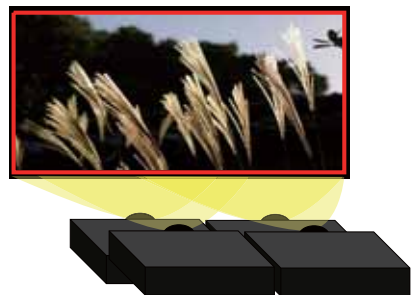

Using the magnify feature

1. Press the **MAGNIFY ON** button on the remote control.

The picture will be magnified, and the MAGNIFY dialog will appear on the screen. When the **MAGNIFY ON** button is pressed for the first time after the projector is turned on, the picture will be zoomed by 1.5 times. On the dialog, triangle marks to show each direction will be displayed.
2. The display magnification of the projector switches in order with every press of the **MAGNIFY ON** button.
 - For computer signals, HDMI™ (RGB) signals, input signals from the LAN ports
 1.5 times → 2 times → 3 times → 4 times → 1 time
 ↑
 - For video signals, component video signals or HDMI™ (Component) signals
 1.5 times → 2 times → 1 time
 ↑
3. While the triangles are displayed on the dialog, use the ▲/▼/◀/▶ cursor buttons to shift the magnifying area.
4. Press the **MAGNIFY OFF** button on the remote control to exit magnification.

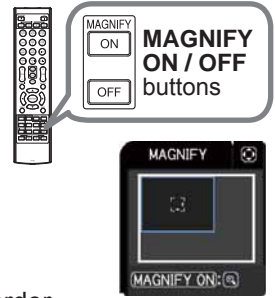

NOTE • The MAGNIFY dialog will automatically disappear in several seconds with no operation. The dialog will appear again if the **MAGNIFY ON** button is pressed when the dialog has automatically disappeared.

- The magnification is automatically disabled when the displaying signal or its display condition is changed.
- While the magnification is active, the keystone distortion condition may vary. It will be restored when the magnification is disabled.
- Some horizontal stripes might be visible on the image while magnification is active.
- This function is not available in the following cases:
 - A sync signal in the range not supported is input.
 - There is no input signal.

Temporarily freezing the screen

1. Press the **FREEZE** button on the remote control.
 The "FREEZE" indication will appear on the screen (however, the indication will not appear when the OFF is selected for the OSD MESSAGE item in the MENU PREFERENCES (📖 86)), and the projector will go into the FREEZE mode, which the picture is frozen.
 To exit the FREEZE mode and restore the screen to normal, press the **FREEZE** button again.



NOTE • The projector automatically exits from the FREEZE mode when some control buttons are pressed.
 • Images might appear degraded when this function is operated, but it is not a malfunction.

Temporarily shading the screen

1. Press the **SHUTTER** button on the control panel. or on the remote control.
 The mechanical lens shade closes and the screen turns to black. The **SHUTTER** indicator on the projector blinks in yellow while the shade is closed.
 To open the shade and restore the screen, press the **SHUTTER** button again.

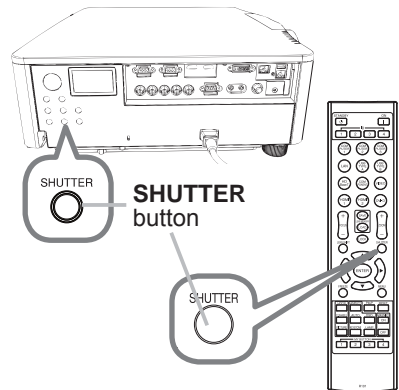

⚠ CAUTION ► If you wish to have a blank screen while the projector's lamp is on, use the lens **SHUTTER** function. Taking any other action may cause the damage on the projector.

NOTE • The projector will turn off automatically when the time set up by the SHUTTER TIMER passes (📖 97).
 • When turning off the power by the normal procedure, the shutter opens automatically. If AC power supply is disconnected while opening or closing the shutter, the moving of the shutter stops. However, the next time the projector is turned on, the shutter opens again automatically.

PbyP (Picture by Picture) / PIP (Picture in Picture)

The PbyP / PIP is a function for displaying two different picture signals on a screen that is separated into main and sub areas for each signal.

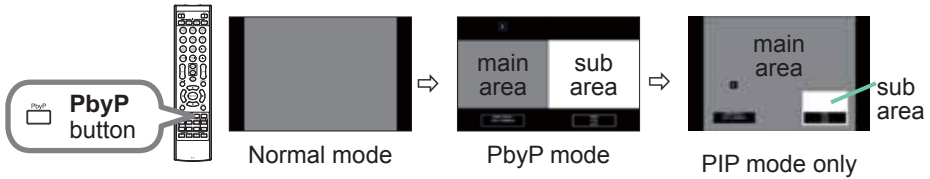

Press the **PbyP** on the remote control. This activates the PbyP mode. Then, press the **PbyP** button again. The projector goes into PIP mode. The screen displayed before the **PbyP** button was pressed will be displayed as the main area. Most of operations are effective for the main area only. To quit the PIP mode, press the **PbyP** button again.

- NOTE**
- If the **LAN** port is selected when the **PbyP** button is pressed, input from other port is displayed on the main area.
 - When in the PbyP / PIP mode, use the **MENU** button on the remote control or **▲/▼** buttons on the control panel to display the OSD menu.
 - There are certain functions that cannot be used when in the PbyP / PIP mode.
 - A message will be displayed when buttons that cannot be used are pressed ( 7, 8). However, note that there are certain unusable buttons for which messages are not displayed.
 - The functions on the OSD menu that cannot be used are displayed in gray and cannot be selected.

○ Setting information

The setting information will be appeared for several seconds when the PbyP / PIP function is started. Displays the input information for each area. A yellow frame around the main area will be displayed. The information can be redisplayed with the ◀/▶ buttons after it has been erased.

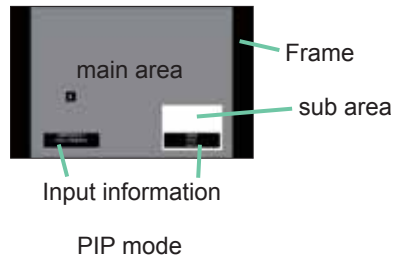
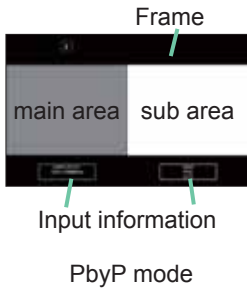

○ Changing the main area

The position of the main area can be toggled with the ◀/▶ buttons when the setting information is displayed on the screen. The yellow frame will move together with it.

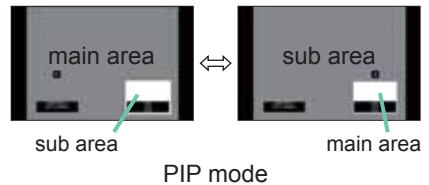
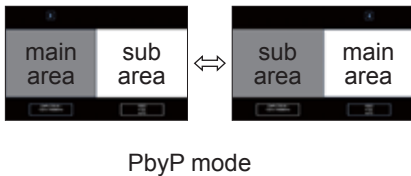

○ **Changing the picture input signal**

Press any button to select an input port on the remote control or press the **INPUT** button on the control panel. A dialog box to select the input signal for the main area will be displayed. Choose a signal using the ▲/▼ buttons. To change the signal in the sub area, switch temporarily across to the main area with the ◀/▶ buttons.

Displaying the same signal on the both areas is not allowed. Refer to the table for details on available input signal combinations. Any combinations marked with "X" can not be selected.

DWU951/DWX951/DXG1051

Sub area \ Main area	COMPUTER IN1	COMPUTER IN2	HDMI 1	HDMI 2	DVI-D	HDBaseT	VIDEO	LAN
COMPUTER IN1		O	O	O	O	O	O	X
COMPUTER IN2	O		O	O	O	O	O	X
HDMI 1	O	O		O	X	X	O	X
HDMI 2	O	O	O		O	O	O	X
DVI-D	O	O	X	O		X	O	X
HDBaseT	O	O	X	O	X		O	X
VIDEO	O	O	O	O	O	O		X
LAN	X	X	X	X	X	X	X	

DHD951

Sub area \ Main area	COMPUTER IN	HDMI 1	HDMI 2	DVI-D	HDBaseT	SDI/DIGITAL 1	VIDEO	LAN
COMPUTER IN		O	O	O	O	O	O	X
HDMI 1	O		O	X	X	X	O	X
HDMI 2	O	O		O	O	O	O	X
DVI-D	O	X	O		X	X	O	X
HDBaseT	O	X	O	X		X	O	X
SDI/DIGITAL 1	O	X	O	X	X		O	X
VIDEO	O	O	O	O	O	O		X
LAN	X	X	X	X	X	X	X	

PbyP mode

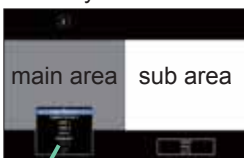

Input signal

PIP mode

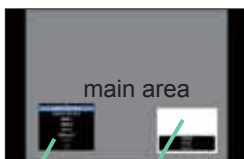

Input signal sub area

PbyP mode

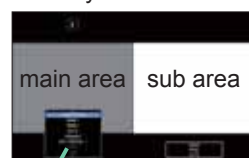

Input signal

PIP mode



Input signal sub area

NOTE • The combined input signals marked with an "O" can be selected and displayed in the PbyP / PIP mode even when the port is set to SKIP with the SOURCE SKIP on the OPTION menu (90).

○ **PbyP / PIP SWAP function**

Press the **MY BUTTON** assigned the PbyP / PIP SWAP (📖 92). The position of the both area is exchanged without any setting change.

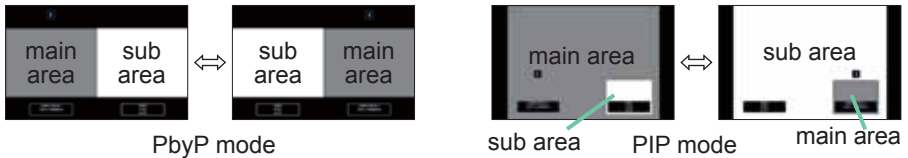

NOTE • For some signals, it may not be displayed correctly in the PbyP / PIP mode, even if it can be displayed properly in the normal mode.

○ **Changing the size of main area in PbyP mode**

Using ▲/▼ buttons on the remote control changes the size of main area in PbyP mode.

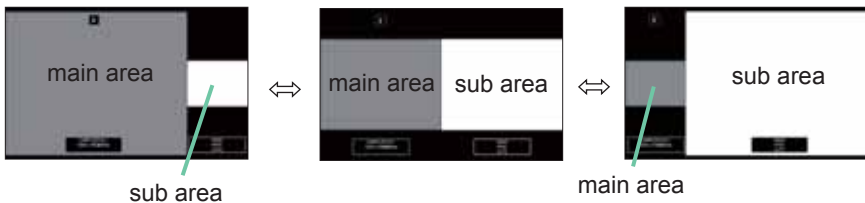

○ **Changing the position of sub area in PIP mode**

Press the PbyP button on the remote control or follow the procedure below.

- EASY MENU > ADVANCED MENU
- > INPUT > PbyP/PIP SETUP
- > PIP Position

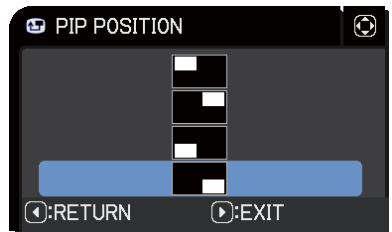

Using the menu function

This projector has the following menus:

IMAGE SETTINGS, SIZE AND POSITION, INPUT, SETUP, MENU PREFERENCES, OPTION, NETWORK, SECURITY and EASY MENU.

EASY MENU consists of functions often used, and the other menus are classified into each purpose and brought together as the ADVANCED MENU.

Each of these menus is operated using the same methods. While the projector is displaying any menu, the **MENU** button on the projector works as the cursor buttons. The basic operations of these menus are as follows.

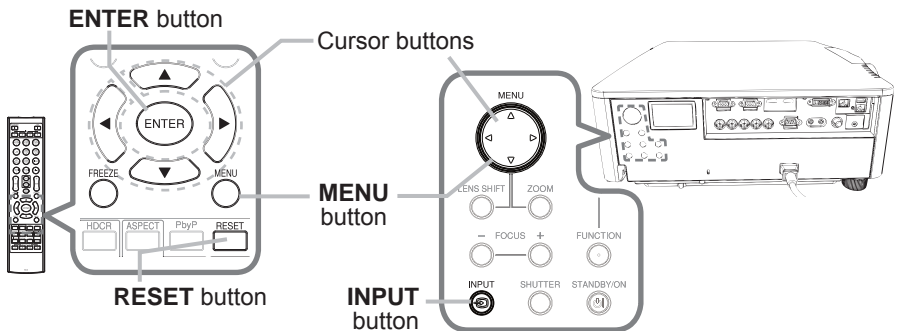

1. To start the MENU, press the **MENU** button. The MENU you last used (EASY or ADVANCED) will appear. EASY MENU has priority to appear just after powered on.

2. In the EASY MENU

- (1) Use the ▲/▼ cursor buttons to select an item to operate. If you want to change it to the ADVANCED MENU, select the ADVANCED MENU.
- (2) Use the ◀/▶ cursor buttons to operate the item.



In the ADVANCED MENU

- (1) Use the ▲/▼ cursor buttons to select a menu. If you want to change it to the EASY MENU, select the EASY MENU. The items in the menu appear on the right side.
- (2) Press the ▶ cursor button or **ENTER** button to move the cursor to the right side. Then use the ▲/▼ cursor buttons to select an item to operate and press the ▶ cursor button or **ENTER** button to progress. The operation menu or dialog of the selected item will appear.
- (3) Use the buttons as instructed in the OSD to operate the item.



- To close the MENU, press the **MENU** button again or select EXIT and press the ◀ cursor button or **ENTER** button. Even if you do not do anything, the dialog will automatically disappear after about 30 seconds.

NOTE • The functions on the OSD menu that cannot be used are displayed in gray and cannot be selected

Indication in OSD (On Screen Display)



The meanings of the general words on the OSD are as follows.

Indication	Meaning
EXIT	Selecting this word finishes the OSD menu. It's the same as pressing the MENU button.
RETURN	Selecting this word returns the menu to the previous menu.
CANCEL or NO	Selecting this word cancels the operation in the present menu and returns to the previous menu.
OK or YES	Selecting this word executes the prepared function or shifts the menu to the next menu.

Containing items of each menu

The items contained in the menus are as below;

Menu	Items
EASY MENU (📖 59)	ASPECT, KEYSTONE, 3D KEYSTONE, PICTURE MODE, ECO MODE, INSTALLATION, RESET, FILTER HOURS, LANGUAGE, ADVANCED MENU, EXIT
IMAGE SETTINGS (📖 61)	BRIGHTNESS, CONTRAST, COLOR, TINT, SHARPNESS, PICTURE QUALITY, HDCR, COLOR WHEEL, DYNAMIC IRIS, MY MEMORY
SIZE AND POSITION (📖 66)	ASPECT, OVER SCAN, V POSITION, H POSITION, H PHASE, H SIZE, AUTO IMAGE
INPUT (📖 69)	PROGRESSIVE, NOISE REDUCTION, COLOR SPACE, VIDEO FORMAT, DIGITAL FORMAT, DIGITAL RANGE, COMPUTER IN, FRAME LOCK, RESOLUTION, PbyP/PIP SETUP
SETUP (📖 75)	KEYSTONE, 3D KEYSTONE, EDGE BLENDING, WARPING, LAMP & FILTER, INSTALLATION, STANDBY MODE, MONITOR OUT, SCHEDULE
MENU PREFERENCES (📖 83)	LANGUAGE, MENU POSITION, BLANK, AUTO BLANK, START UP, My Screen, My Screen Lock, OSD MESSAGE, SOURCE NAME, TEMPLATE, Closed Caption C.C.
OPTION (📖 90)	SOURCE SKIP, AUTO SEARCH, DIRECT POWER ON, AUTO POWER OFF, SHUTTER TIMER, MY BUTTON, SERVICE
NETWORK (📖 100)	PROJECTOR NAME, WIRELESS SETUP, WIRED SETUP, NETWORK INFORMATION, SNTP SETUP, MY IMAGE, AMX D. D., PRESENTATION, WIRED NETWORK
SECURITY (📖 101)	SECURITY PASSWORD CHANGE, My Screen PASSWORD, PIN LOCK, MY TEXT PASSWORD, MY TEXT DISPLAY, MY TEXT WRITING, SECURITY INDICATOR, STACK LOCK

EASY MENU

From the EASY MENU, items shown in the table below can be performed.

Select an item using the ▲/▼ cursor buttons. Then perform it according to the following table.

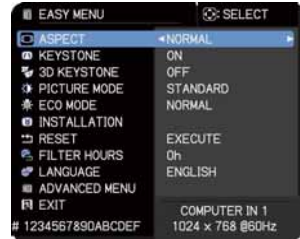

Item	Description
ASPECT	Using the ◀/▶ buttons switches the mode for aspect ratio. See the ASPECT item in SIZE AND POSITION menu (📖66).
KEYSTONE	Using the ▶ cursor button to start the settings. For details, see KEYSTONE in Correcting the distortion (📖42).
3D KEYSTONE	Pressing the ▶ button displays the 3D KEYSTONE dialog. For details, see 3D KEYSTONE in Correcting the distortion (📖42).
PICTURE MODE	<p>Using the ◀/▶ buttons switches the picture mode. The picture modes are combinations of GAMMA, COLOR TEMP and eClarity settings. Choose a suitable mode according to the projected source.</p> <p style="text-align: center;">Standard ⇔ Natural ⇔ Cinema ⇔ Dynamic</p> <p style="text-align: center;">⇕</p> <p style="text-align: center;">USER-3 BOARD(BLACK)</p> <p style="text-align: center;">⇕</p> <p style="text-align: center;">USER-2 BOARD(GREEN)</p> <p style="text-align: center;">⇕</p> <p style="text-align: center;">USER-1 ⇔ DICOM SIM. ⇔ DAYTIME ⇔ WHITEBOARD</p> <p>For more details of USER-1, -2 and -3, refer to PICTURE QUALITY.</p>

Item	Description
<p>PICTURE MODE (continued)</p>	<ul style="list-style-type: none"> • Lines or other noise might appear on the screen when this function is operated, but it is not a malfunction. • DICOM SIM. is the projector's DICOM® ("Digital Imaging and Communication in Medicine") simulation mode. This mode simulates the DICOM standard, which is a standard applicable to digital communications in medicine, and can be useful for displaying medical images, such as X-rays photos. This projector is not a medical device and is not compliant to the DICOM standard, and neither the projector nor the DICOM SIM. mode should be used for medical diagnosis.
<p>ECO MODE</p>	<p>Using the ◀/▶ buttons turns off/on the Eco mode. See the ECO MODE item in SETUP, then LAMP & FILTER menu (87).</p>
<p>INSTALLATION</p>	<p>Pressing the ▶ button displays the INSTALLATION dialog. See the INSTALLATION item in SETUP menu (79).</p>
<p>RESET</p>	<p>Performing this item resets all of the EASY MENU items except the FILTER HOURS and LANGUAGE. A dialog is displayed for confirmation. Selecting the OK using the ▶ button performs resetting.</p>
<p>FILTER HOURS</p>	<p>The usage time of the air filter is shown in the menu. Performing this item resets the filter hours which counts usage time of the air filter. A dialog is displayed for confirmation. Selecting the OK using the ▶ button performs resetting. See the FILTER HOURS item in SETUP, then LAMP & FILTER menu (78).</p>
<p>LANGUAGE</p>	<p>Using the ◀/▶ buttons changes the display language. See the LANGUAGE item in MENU PREFERENCES (83).</p>
<p>ADVANCED MENU</p>	<p>Press the ▶ or ENTER button to use the menu of IMAGE SETTINGS, SIZE AND POSITION, INPUT, SETUP, MENU PREFERENCES, OPTION, NETWORK or SECURITY.</p>
<p>EXIT</p>	<p>Press the ◀ or ENTER button to finish the OSD menu.</p>

IMAGE SETTINGS menu







From the IMAGE SETTINGS menu, items shown in the table below can be performed. Select an item using the ▲/▼ cursor buttons, and press the ► cursor button or **ENTER** button to execute the item. Then perform it according to the following table.



Item	Description
BRIGHTNESS	Using the ◀/▶ buttons adjusts the brightness. Dark ⇔ Light
CONTRAST	Using the ◀/▶ buttons adjusts the contrast. Weak ⇔ Strong
COLOR	Using the ◀/▶ buttons adjusts the strength of whole color. Weak ⇔ Strong <ul style="list-style-type: none"> • This item can be selected only for a video, and component video signal. • For an HDMI™, HDBaseT™, DVI-D and SDI/DIGITAL 1 signal, this item can also be selected if either (1) or (2) applies. <ul style="list-style-type: none"> (1) DIGITAL FORMAT item in the INPUT menu for selected port is set to VIDEO. (2) DIGITAL FORMAT item in the INPUT menu for selected port is set to AUTO, and the projector recognizes that it receives video signals.
TINT	Using the ◀/▶ buttons adjusts the tint. Reddish ⇔ Greenish <ul style="list-style-type: none"> • This item can be selected only for a video, and component video signal. • For an HDMI™, HDBaseT™, DVI-D and SDI/DIGITAL 1 signal, this item can also be selected if either (1) or (2) applies. <ul style="list-style-type: none"> (1) DIGITAL FORMAT item in the INPUT menu for selected port is set to VIDEO. (2) DIGITAL FORMAT item in the INPUT menu for selected port is set to AUTO, and the projector recognizes that it receives video signals.
SHARPNESS	Using the ◀/▶ buttons adjusts the sharpness. Weak ⇔ Strong <ul style="list-style-type: none"> • There may be some noise and/or the screen may flicker for a moment when an adjustment is made. This is not a malfunction.

Item	Description
<p>PICTURE QUALITY</p>	<p>Selecting this item displays the PICTURE QUALITY menu.</p> <p>Select an item using the ▲/▼ buttons, and press the ► button or the ENTER button on the remote control to execute the item.</p> 
	<p>PICTURE MODE</p> <p>Standard ⇄ Natural ⇄ Cinema ⇄ Dynamic</p> <p style="text-align: center;">⇕</p> <p>USER-3 BOARD(BLACK)</p> <p style="text-align: center;">⇕</p> <p>USER-2 BOARD(GREEN)</p> <p style="text-align: center;">⇕</p> <p>USER-1 ⇄ DICOM SIM. ⇄ DAYTIME ⇄ WHITEBOARD</p> <p>After selecting USER-1 / USER-2 / USER-3, the following features are adjustable.</p> <p>Gamma, Color Temp, eClarity</p>
	<p>GAMMA</p> <p>This feature is only available when USER-1 / USER-2 / USER-3 is selected.</p> <p>Using the ▲/▼ buttons switches the gamma mode.</p> <p>DEFAULT-1 ⇄ CUSTOM-1 ⇄ DEFAULT-2 ⇄ CUSTOM-2</p> <p style="text-align: center;">⇕</p> <p>CUSTOM-8 DEFAULT-3</p> <p style="text-align: center;">⇕</p> <p>DEFAULT-8 CUSTOM-3</p> <p style="text-align: center;">⇕</p> <p>CUSTOM-7 DEFAULT-4</p> <p style="text-align: center;">⇕</p> <p>DEFAULT-7 CUSTOM-4</p> <p style="text-align: center;">⇕</p> <p>CUSTOM-6 ⇄ DEFAULT-6 ⇄ CUSTOM-5 ⇄ DEFAULT-5</p>

Item	Description
PICTURE QUALITY (continued)	<p>GAMMA (continued)</p> <p>Selecting a mode whose name includes CUSTOM and then pressing the ► button or the ENTER button displays a dialog to aid you in adjusting the mode. This function is useful when you want to change the brightness of particular tones. Choose an item using the ◀/▶ buttons, and adjust the level using the ▲/▼ buttons.</p> <p>You can display a test pattern for checking the effect of your adjustment by pressing the ENTER button. Each time you press the ENTER button, the pattern changes as below.</p> <p>No pattern ⇨ Gray scale of 9 steps ⇩</p> <p>⇧ Ramp ⇩ Gray scale of 15 steps</p> <p>The eight equalizing bars correspond to eight tone levels of the test pattern (Gray scale of 9 steps) except the darkest in the left end. If you want to adjust the 2nd tone from left end on the test pattern, use the equalizing adjustment bar "1". The darkest tone at the left end of the test pattern cannot be controlled with any of equalizing adjustment bar.</p> <ul style="list-style-type: none"> • Lines or other noise might appear on the screen when this function is operated, but it is not a malfunction.
	<p>COLOR TEMP</p> <p>This feature is only available when USER-1 / USER-2 / USER-3 is selected.</p> <p>Using the ▲/▼ buttons switches the color temperature mode.</p> <p>HIGH ⇨ CUSTOM ⇨ MID-1 ⇨ CUSTOM ⇨ MID-2 ⇨ CUSTOM ⇨ LOW</p> <p>⇕ -1 -2 -3 ⇕</p> <p>CUSTOM-7 CUSTOM-4</p> <p>⇕</p> <p>HIGH-BRIGHT-3 ⇨ CUSTOM-6 ⇨ HIGH-BRIGHT-2 ⇨ CUSTOM-5 ⇨ HIGH-BRIGHT-1</p> <p>Selecting a mode whose name includes CUSTOM and then pressing the ► button or the ENTER button displays a dialog to aid you in adjusting the OFFSET and GAIN of the selected mode. OFFSET adjustments change the color intensity on the whole tones of the test pattern. GAIN adjustments mainly affect color intensity on the brighter tones of the test pattern. Choose an item using the ◀/▶ buttons, and adjust the level using the ▲/▼ buttons.</p> <p>You can display a test pattern for checking the effect of your adjustment by pressing the ENTER button. Each time you press the ENTER button, the pattern changes as below.</p> <p>No pattern ⇨ Gray scale of 9 steps ⇩</p> <p>⇧ Ramp ⇩ Gray scale of 15 steps</p> <ul style="list-style-type: none"> • Lines or other noise might appear on the screen when this function is operated, but it is not a malfunction.

Item	Description
<p>PICTURE QUALITY (continued)</p>	<p>eClarity This technology makes pictures look more real by enhancing (1) Sharpness, (2) Gloss and (3) Shade to make pictures as clear as pictures on a flat-panel device. You can also adjust the effects by three levels according to your surroundings so that the colors of projected images are the actual colors of the objects they represent.</p> <div style="display: flex; justify-content: space-around; align-items: center;"> <div style="text-align: center;">  <p>Sharpness</p> </div> <div style="text-align: center;">  <p>Gloss</p> </div> <div style="text-align: center;">  <p>Shade</p> </div> </div> <p>This feature is only available when USER-1 / USER-2 / USER-3 is selected.</p> <p>eClarity is a function to improve the legibility. Using the ◀/▶ buttons adjust the effect of sharpness, gloss and shade.</p> <p>Weak ↔ Strong</p> <ul style="list-style-type: none"> • There may be some noise and/or the screen may flicker for a moment when an adjustment is made. This is not a malfunction.
<p>HDCR</p>	<div style="display: flex; justify-content: space-around;"> <div style="text-align: center;">  <p>Bright room</p> </div> <div style="text-align: center;">  <p>HDCR OFF</p> </div> </div> <p>When average projectors are used in bright rooms, the darker colors of an image deteriorate and images become unclear.</p> <p>Using this function, blurred images caused by room lighting or outside light sources are corrected, and an effect similar to increasing contrast occurs.</p> <p>This results in clear images even in bright rooms.</p> <p>Using the ◀/▶ buttons adjusts the contrast.</p> <div style="text-align: center; margin-top: 10px;">  <p>HDCR ON</p> </div>

Item	Description
<p>COLOR WHEEL</p>	<p>Using the ▲/▼ buttons switches the Color Wheel.</p> <p>BRIGHT ⇄ RICH COLOR</p> <p>BRIGHT : Enhances the amount of light given out. RICH COLOR : Enhances the color.</p>
<p>DYNAMIC IRIS</p>	<p>Using the ▲/▼ cursor buttons changes the dynamic iris control mode.</p> <p>PRESENTATION ⇄ THEATER ⇄ OFF</p> <p style="text-align: center;">↑—————↑</p> <p><u>PRESENTATION</u> : The dynamic iris displays the best presentation image for both bright and dark scenes. <u>THEATER</u> : The dynamic iris displays the best theater image for both bright and dark scenes. <u>OFF</u> : The dynamic iris is always open.</p> <ul style="list-style-type: none"> • The screen may flicker when the PRESENTATION or THEATER modes are selected. If this occurs select OFF.
<p>MY MEMORY</p>	<p>This projector has 4 memories for adjustment data (for all the items of the IMAGE SETTINGS menu). Selecting a function using the ▲/▼ buttons and pressing the ► or ENTER button performs each function.</p> <p>SAVE-1 ⇄ SAVE-2 ⇄ SAVE-3 ⇄ SAVE-4 LOAD-4 ⇄ LOAD-3 ⇄ LOAD-2 ⇄ LOAD-1</p> <p><u>SAVE-1, SAVE-2, SAVE-3, SAVE-4</u> Performing a SAVE function saves the current adjustment data into the memory linked in the number included in the function's name.</p> <ul style="list-style-type: none"> • Remember that the current data being stored of a memory will be lost by saving new data into the memory. <p><u>LOAD-1, LOAD-2, LOAD-3, LOAD-4</u> Performing a LOAD function loads the data from the memory linked in the number included in the function's name, and adjusts the picture automatically depending on the data.</p> <ul style="list-style-type: none"> • The LOAD functions whose linked memory has no data are skipped. • Remember that the current adjusted condition will be lost by loading data. If you want to keep the current adjustment, please save it before performing a LOAD function. • There may be some noise and the screen may flicker for a moment when loading data. This is not malfunction. • You can perform the LOAD function using MY BUTTON. Please see MY BUTTON item in OPTION menu (92).

SIZE AND POSITION menu

From the SIZE AND POSITION menu, items shown in the table below can be performed.

Select an item using the ▲/▼ cursor buttons, and press the ► cursor button or **ENTER** button to execute the item. Then perform it according to the following table. for selected port



Item	Description
<p>ASPECT</p>	<p>Using the ▲/▼ buttons switches the mode for aspect ratio.</p> <p>For a computer signal</p> <p>DXG1051: NORMAL ⇔ 4:3 ⇔ 16:9 ⇔ 16:10 ↑—————↑</p> <p>DWX951, DHD951, DWU951: NORMAL ⇔ 4:3 ⇔ 16:9 ⇔ 16:10 ⇔ NATIVE ↑—————↑</p> <p>For an HDMI™ and HDBaseT™ signal</p> <p>DXG1051: NORMAL ⇔ 4:3 ⇔ 16:9 ⇔ 16:10 ⇔ 14:9 ↑—————↑</p> <p>DWX951, DHD951, DWU951: NORMAL ⇔ 4:3 ⇔ 16:9 ⇔ 16:10 ⇔ 14:9 ⇔ NATIVE ↑—————↑</p> <p>For a video signal or component video signal</p> <p>DXG1051: 4:3 ⇔ 16:9 ⇔ 14:9 ↑—————↑</p> <p>DWX951, DHD951, DWU951: 4:3 ⇔ 16:9 ⇔ 16:10 ⇔ 14:9 ⇔ NATIVE ↑—————↑</p> <p>For a SDI/DIGITAL 1 signal (DHD951 only) NORMAL ⇔ 4:3 ⇔ 16:9 ⇔ NATIVE ↑—————↑</p> <p>For an input signal from the LAN ports, or if there is no signal</p> <p>DXG1051: 4:3 (fixed) DWX951, DWU951: 16:10 (fixed) DHD951: 16:9 (fixed)</p> <p>• The NORMAL mode keeps the original aspect ratio of the signal.</p>

Item	Description
<p>OVER SCAN</p>	<p>Using the ◀/▶ buttons adjusts the over-scan ratio. Small (It magnifies picture) ⇔ Large (It reduces picture)</p> <ul style="list-style-type: none"> • This item can be selected only for a video and component video signal. • For an HDMI™, HDBaseT™, DVI-D and SDI/DIGITAL 1 signal, this item can also be selected if either (1) or (2) applies. (1) DIGITAL FORMAT item in the INPUT menu for selected port is set to VIDEO. (2) DIGITAL FORMAT item in the INPUT menu for selected port is set to AUTO, and the projector recognizes that it receives video signals.
<p>V POSITION</p>	<p>Using the ◀/▶ buttons adjusts the vertical position. Down ⇔ Up</p> <ul style="list-style-type: none"> • Over-adjusting the vertical position may cause noise to appear on the screen. If this occurs, please reset the vertical position to the default setting. Pressing the RESET button when the V POSITION is selected will reset the V POSITION to the default setting. • When this function is performed on a video signal the range of this adjustment depends on OVER SCAN (🔲 <i>above</i>) setting. It is not possible to adjust when OVER SCAN is set to 10. • This function is unavailable for a signal from the LAN, HDMI 1 / 2, HDBaseT™, DVI-D or SDI/DIGITAL 1 port.
<p>H POSITION</p>	<p>Using the ◀/▶ buttons adjusts the horizontal position. Right ⇔ Left</p> <ul style="list-style-type: none"> • Over-adjusting the horizontal position may cause noise to appear on the screen. If this occurs, please reset the horizontal position to the default setting. Pressing the RESET button when the H POSITION is selected will reset the H POSITION to the default setting. • When this function is performed on a video signal the range of this adjustment depends on OVER SCAN (🔲 <i>above</i>) setting. It is not possible to adjust when OVER SCAN is set to 10. • This function is unavailable for a signal from the LAN, HDMI 1 / 2, HDBaseT™, DVI-D or SDI/DIGITAL 1 port.

Item	Description
H PHASE	Using the ◀/▶ buttons adjusts the horizontal phase to eliminate flicker. Right ⇔ Left <ul style="list-style-type: none"> • This item can be selected only for a computer signal or a component video signal. This function is unavailable for a signal from the LAN, HDMI 1 / 2, HDBaseT™, DVI-D or SDI/DIGITAL 1 port.
H SIZE	Using the ◀/▶ buttons adjusts the horizontal size. Small ⇔ Large <ul style="list-style-type: none"> • This item can be selected only for a computer signal. This function is unavailable for a signal from the LAN, HDMI 1 / 2, HDBaseT™, DVI-D or SDI/DIGITAL 1 port. • When this adjustment is excessive, the picture may not be displayed correctly. In such a case, please reset the adjustment by pressing the RESET button on the remote control during this operation. • Images might appear degraded when this function is operated, but it is not a malfunction.
AUTO IMAGE	Selecting this item performs the automatic adjustment feature. <p>For a computer signal The vertical position, the horizontal position and the horizontal phase will be automatically adjusted. Make sure that the application window is set to its maximum size prior to attempting to use this feature. A dark picture may still be incorrectly adjusted. Use a bright picture when adjusting.</p> <p>For a video signal The video format best suited for the respective input signal will be selected automatically. This function is available only when the AUTO is selected for the VIDEO FORMAT item in the INPUT menu (📖 70). The vertical position and horizontal position will be automatically set to the default.</p> <p>For a component video signal The vertical position and horizontal position will be automatically set to the default. The horizontal phase will be automatically adjusted.</p> <ul style="list-style-type: none"> • The automatic adjustment operation requires approx. 10 seconds. Also please note that it may not function correctly with some input. • When this function is performed for a video signal, a certain extra such as a line may appear outside a picture. • When this function is performed for a computer signal, a black frame may be displayed on the edge of the screen, depending on the computer model. • The items adjusted by this function may vary when the FINE or DISABLE is selected for the AUTO IMAGE ADJUST item of the SERVICE item in the OPTION menu (📖 93).



INPUT menu



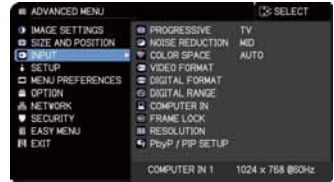

From the INPUT menu, items shown in the table below can be performed.



Select an item using the ▲/▼ cursor buttons, and press the ► cursor button or **ENTER** button to execute the item. Then perform it according to the following table.







Item	Description
<p>PROGRESSIVE</p>	<p>Using the ▲/▼ buttons switches the progress mode. TV ⇄ FILM ⇄ OFF ↑—————↑</p> <ul style="list-style-type: none"> • This function works only for a video signal, component video signal (of 480i@60 or 576i@50 or 1080i@50/60), an HDMI™ signal (of 480i@60 or 576i@50 or 1080i@50/60), HDBaseT™ signal (of 480i@60 or 576i@50 or 1080i@50/60), DVI-D signal (of 480i@60 or 576i@50 or 1080i@50/60) and SDI/DIGITAL signal (of 480i@60 or 576i@50 or 1080i@50/60). • When TV or FILM is selected, the screen image will be sharp. FILM adapts to the 2-3 Pull-Down conversion system. But these may cause a certain defect (for example, jagged line) of the picture for a quick moving object. In such a case, please select OFF, even though the screen image may lose sharpness.
<p>NOISE REDUCTION</p>	<p>Using the ▲/▼ buttons switches the noise reduction mode. HIGH ⇄ MID ⇄ LOW ↑—————↑</p> <ul style="list-style-type: none"> • This function works only for a video signal, component video signal (of 480i@60 or 576i@50 or 1080i@50/60), an HDMI™ signal (of 480i@60 or 576i@50 or 1080i@50/60), HDBaseT™ signal (of 480i@60 or 576i@50 or 1080i@50/60), DVI-D signal (of 480i@60 or 576i@50 or 1080i@50/60) and SDI/DIGITAL signal (of 480i@60 or 576i@50 or 1080i@50/60).
<p>COLOR SPACE</p>	<p>Using the ▲/▼ buttons switches the mode for color space. AUTO ⇄ RGB ⇄ SMPTE240 ⇄ REC709 ⇄ REC601 ↑—————↑</p> <ul style="list-style-type: none"> • This item can be selected only for a computer signal (except for signals from the LAN ports) or a component video signal. • The AUTO mode automatically selects the optimum mode. • The AUTO operation may not work well at some signals. In such a case, it might be good to select a suitable mode except AUTO.

Item	Description
<p>VIDEO FORMAT</p>	<p>The video format for VIDEO port can be set. Using the ◀/▶ buttons switches the mode for video format.</p>  <p>AUTO ⇔ NTSC ⇔ PAL ⇔ SECAM ↳ N-PAL ⇔ M-PAL ⇔ NTSC4.43 ↵</p> <ul style="list-style-type: none"> • This item is performed only for a video signal from the VIDEO port. • The AUTO mode automatically selects the optimum mode. • The AUTO operation may not work well for some signals. If the picture becomes unstable (e.g. an irregular picture, lack of color), please select the mode according to the input signal.
<p>DIGITAL FORMAT</p>	<p>The video format of digital input signals from the HDMI 1/2, DVI-D and HDBaseT™ ports can be set.</p> <p>(1) Use the ▲/▼ buttons to select the port to be set.</p>  <p>(2) Use the ◀/▶ buttons to select the video format.</p> <p>AUTO ⇔ VIDEO ⇔ COMPUTER</p> <p><u>AUTO</u>: automatically sets the optimum mode. <u>VIDEO</u>: sets the suitable mode for DVD signals. <u>COMPUTER</u>: sets the suitable mode for computer signals.</p> <ul style="list-style-type: none"> • When the COMPUTER is selected, the functions COLOR (IMAGE SETTINGS menu), TINT (IMAGE SETTINGS menu) and OVER SCAN (SIZE AND POSITION menu) are unavailable.

Item	Description
<p>DIGITAL RANGE</p>	<p>The video format of digital input signals from the HDMI 1/2, DVI-D, HDBaseT™ and SDI/DIGITAL 1 ports can be set.</p> <p>DWU951/DWX951/DXG1051 DHD951</p> <div style="display: flex; justify-content: space-around;">   </div> <p>(1) Use the ▲/▼ buttons to select the port to be set. (2) Use the ◀/▶ buttons to select the digital range. AUTO ⇔ NORMAL ⇔ ENHANCED</p> <p><u>AUTO</u>: automatically sets the optimum mode. <u>NORMAL</u>: sets the suitable mode for DVD signals. (16-235) <u>ENHANCED</u>: sets the suitable mode for computer signals. (0-255) ((1-254) for SDI)</p> <ul style="list-style-type: none"> • If the contrast of the screen image is too strong or too weak, try finding a more suitable mode.
<p>COMPUTER IN</p>	<p>The computer input signal type for COMPUTER IN1 and IN2 (for DHD951, COMPUTER IN only) ports can be set.</p> <p>DWU951/DWX951/DXG1051 DHD951</p> <div style="display: flex; justify-content: space-around;">   </div> <p>(1) Use the ▲/▼ buttons to select the COMPUTER IN port to be set. (Only COMPUTER IN port can be set for DHD951.) (2) Use the ◀/▶ buttons to select the computer input signal type. AUTO ⇔ SYNC ON G OFF</p> <ul style="list-style-type: none"> • Selecting the AUTO mode allows you to input a sync on G signal or component video signal from the port. • In the AUTO mode, the picture may be distorted with certain input signals. In such a case, remove the signal connector so that no signal is received and select the SYNC ON G OFF, and then reconnect the signal.

Item	Description
<p>FRAME LOCK</p>	<p>When ON is selected, moving pictures are displayed more smoothly Set the frame lock function on/off for each port.</p> <div style="display: flex; justify-content: space-around;"> <div style="text-align: center;"> <p>DWU951/DWX951/DXG1051</p>  </div> <div style="text-align: center;"> <p>DHD951</p>  </div> </div> <p>(1) Use the ▲/▼ buttons to select the input ports. (2) Use the ◀/▶ buttons to turn the frame lock function on/off . ON ⇔ OFF</p> <ul style="list-style-type: none"> • This item can be performed only on a signal with a vertical frequency of 49 to 51Hz, 59 to 61 Hz.

Item	Description
<p>RESOLUTION</p>	<p>The resolution for the COMPUTER IN1 and COMPUTER IN2 (for DHD951, COMPUTER IN only) input signals can be set on this projector.</p> <p>(1) In the INPUT menu select the RESOLUTION using the ▲/▼ buttons and press the ► button. The RESOLUTION menu will be displayed.</p>  <p>(2) In the RESOLUTION menu select the resolution you wish to display using the ▲/▼ buttons. Selecting AUTO SETUP will set a resolution appropriate to the input signal.</p> <p>(3) Pressing the ► or ENTER button when selecting a STANDARD resolution will automatically adjust the horizontal and vertical positions, clock phase and horizontal size. The INPUT INFORMATION dialog will be displayed.</p>  <p>(4) To set a custom resolution use the ▲/▼ buttons to select the CUSTOM and the RESOLUTION CUSTOM box will be displayed. Set the HORIZONTAL and VERTICAL resolutions using the ▲/▼/◀/▶ buttons. This function may not support all resolutions.</p>  <p>(5) Move the cursor to OK on screen and press the ► or ENTER button. The message "ARE YOU SURE YOU WISH TO CHANGE RESOLUTION?" appears. To save the setting, press the ► button. The horizontal and vertical positions, clock phase and horizontal size will be automatically adjusted. The INPUT INFORMATION dialog will be displayed.</p>  <p>(6) To revert back to the previous resolution without saving changes, move the cursor to CANCEL on screen and press the ◀ or ENTER button. The screen will then return to the RESOLUTION menu displaying the previous resolution.</p> <ul style="list-style-type: none"> • For some pictures, this function may not work well.

Item	Description
<p>PbyP / PIP SETUP</p>	<p>PIP Position Using ▲/▼ buttons on the remote control changes the position of sub area in PIP mode (see 55).</p>
	<p>PbyP / PIP FRAME LOCK Select the screen that enables FRAME LOCK function when using PbyP or PIP. LEFT / PRIMARY: Enables FRAME LOCK function for input on left screen of PbyP or on primary area of PIP. RIGHT / SECONDARY: Enables FRAME LOCK function for input on right screen of PbyP or on secondary area of PIP.</p>

SETUP menu

From the SETUP menu, items shown in the table below can be performed.

Select an item using the ▲/▼ cursor buttons, and press the ► cursor button or ENTER button to execute the item. Then perform it according to the following table.





Item	Description
<p>KEYSTONE</p>	<p>Selecting this item displays the KEYSTONE dialog. For details, see KEYSTONE in Correcting the distortion (42).</p> <ul style="list-style-type: none"> • When the zoom adjustment is set to the TELE (telephoto focus), this function may be excessive. This function should be used when the zoom adjustment is set to the full WIDE (wide-angle focus) whenever possible. • When the horizontal lens shift is not set to the center, this function may not work well. • This function is unavailable when the screen is activated by 3D KEYSTONE (42), EDGE BLENDING(45), and WARPING(49).
<p>3D KEYSTONE</p>	<p>Selecting this item displays the 3D KEYSTONE dialog. For details, see 3D KEYSTONE in Correcting the distortion (42).</p> <ul style="list-style-type: none"> • This function is unavailable when the screen is activated by KEYSTONE (42), EDGE BLENDING(45), and WARPING(49).
<p>EDGE BLENDING</p>	<p>Selecting this item displays the EDGE BLENDING dialog. For details, see EDGE BLENDING feature (45).</p>
<p>WARPING</p>	<p>Selecting this item displays the WARPING dialog. For details, see Application Manual of this feature.</p>

Item	Description
<p>LAMP & FILTER (continued)</p>	<p>CYCLE TIME Using the ▲/▼ cursor buttons changes the CYCLE TIME. 6h ⇄ 12h ⇄ 18h ⇄ 24h ⇄ 1 week </p> <p>Lamp switches according to the setting here.</p> <ul style="list-style-type: none"> • This function is only available if CYCLE TIME is selected at ALTERNATE of LAMP MODE.
	<p>LAMP-1 HOURS The lamp time is the usage time of the lamp-1, counted after the last resetting. It is shown in the LAMP & FILTER menu. Pressing the RESET button on the remote control or the ► button of the projector displays a dialog. To reset the lamp time, select the OK using the ► button. CANCEL ⇄ OK</p> <ul style="list-style-type: none"> • Please reset the lamp time only when you have replaced the lamp, for a suitable indication about the lamp. • For the lamp replacement, see the section Replacing the lamp (107). • The lamp time can be checked also with the Status Monitor (28)
	<p>LAMP-2 HOURS The lamp time is the usage time of the lamp-2, counted after the last resetting. It is shown in the LAMP & FILTER menu. Pressing the RESET button on the remote control or the ► button of the projector displays a dialog. To reset the lamp time, select the OK using the ► button. CANCEL ⇄ OK</p> <ul style="list-style-type: none"> • Please reset the lamp time only when you have replaced the lamp, for a suitable indication about the lamp. • For the lamp replacement, see the section Replacing the lamp (107). • The lamp time can be checked also with the Status Monitor (28)

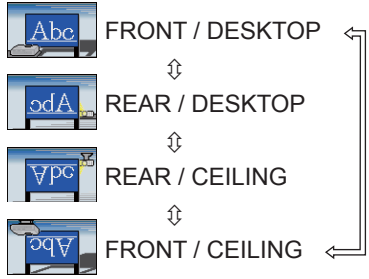
Item	Description
<p>LAMP & FILTER (continued)</p>	<p>FILTER HOURS The filter hours is the usage time of the air filter, counted after the last resetting. It is shown in the LAMP & FILTER menu. Pressing the RESET button on the remote control or the ► button of the projector displays a dialog. To reset the filter hours, select the OK using the ► button. CANCEL ⇨ OK</p> <ul style="list-style-type: none"> • Please reset the filter hours only when you have cleaned or replaced the air filter, for a suitable indication about the air filter. • For the air filter cleaning, see the section Cleaning and replacing the air filter (📖 110). • The filter hours can be checked also with the Status Monitor (📖 28).
	<p>FILTER MESSAGE Use the ▲/▼ button to set the timer for notifying by the message when to replace the filter unit 1000h ⇨ 2000h ⇨ 5000h ⇨ 10000h ⇨ 15000h ⇨ OFF After choosing an item except OFF, the message “REMINDER *** HRS PASSED” will appear after the timer reaches the interval time set by this feature. When the OFF is chosen, the message will not appear. Utilize this feature to keep the air filter clean, setting the suitable time according to your environment of this projector.</p> <ul style="list-style-type: none"> • Please take care of the filter unit periodically, even if there is no message. If the air filter becomes to be blocked by dust or other matter, the internal temperature will rise, which could cause malfunction, or reduce the lifetime of the projector. • Please be careful with the operating environment of the projector and the condition of the filter unit.

Item	Description
<p>INSTALLATION</p>	<p>Pressing the ► button displays the dialog for changing the INSTALLATION setting.</p> <div style="text-align: center;">  </div> <p>Use the ▲/▼ buttons to select the desired setting on the INSTALLATION dialog, and press the ENTER button of the remote control or the INPUT button of the projector to execute.:</p>
<p>STANDBY MODE</p>	<p>Using ▲/▼ buttons switches the standby mode setting between NORMAL and POWER SAVE.</p> <p>NORMAL ⇔ POWER SAVE</p> <p>When POWER SAVE is selected, the power consumption in the standby mode is lowered with some functional restriction as below:</p> <ul style="list-style-type: none"> • When POWER SAVE is selected, the RS-232C communication control except to turn the projector on and the network function are disabled while the projector is in the standby mode. If the COMMUNICATION TYPE in the COMMUNICATION menu is set to NETWORK BRIDGE, all of the RS-232C commands are disabled (9%). • When POWER SAVE is selected, STANDBY setting of MONITOR OUT is invalid, and no signal is output from MONITOR OUT port in the standby mode. • When POWER SAVE is selected, the CENTERING feature while the projector is in the standby mode is disabled. • When POWER SAVE is selected, the Status Monitor and its button operation are unavailable while the projector is in the standby mode. • When POWER SAVE is selected, the HDMI Link and HDBaseT™ functions are disabled while the projector is in the standby mode.

Item	Description
<p>MONITOR OUT</p>	<p>While the image signal from the input port chosen in step (1) is projected, the image signal from the input port selected in step (2) is output to MONITOR OUT port.</p> <p>(1) Choose a picture input port using ▲/▼ buttons. Choose STANDBY to select the picture output in the standby mode.</p> <p>(2) Select COMPUTER IN1 or COMPUTER IN2 (for DHD951, COMPUTER IN only) port using ◀/▶ buttons. Select OFF to disable the MONITOR OUT port for the input port or standby mode chosen in the step (1).</p> <div style="text-align: right;">  <p>DWU951/DWX951/DXG1051</p> </div> <div style="text-align: right;">  <p>DHD951</p> </div>
<p>SCHEDULE</p>	<p>Please refer to the next pages.</p>

SCHEDULE

Some functions can be operated automatically by setting up this menu.

Follow the steps below to select the SCHEDULE menu.

1. Use the ▲/▼/◀/▶ cursor buttons to select a menu.

EASY MENU ADVANCED MENU

SETUP **SCHEDULE** DATE & TIME
 SPECIFIC DATE
 PROGRAM EDIT

2. Press ▶ cursor button to select the item.

■ How to setup the item

1. Use the ▲/▼/◀/▶ cursor buttons to select or adjust.

2 Select OK to finish the settings.

NOTE • Please refer to the actual on-screen display(OSD) for appropriate operation.

Item	Description
DATE & TIME	Set the DATE(Year/Month/Date) and Time(24-hour scale).
SPECIFIC DATE	Set specific date from 1 to 5.
PROGRAM EDIT	The TIME and EVENT for Program 1 to 16 can be edited. (82)

■ How to activate

Place a check mark in the box.

Check mark in the box

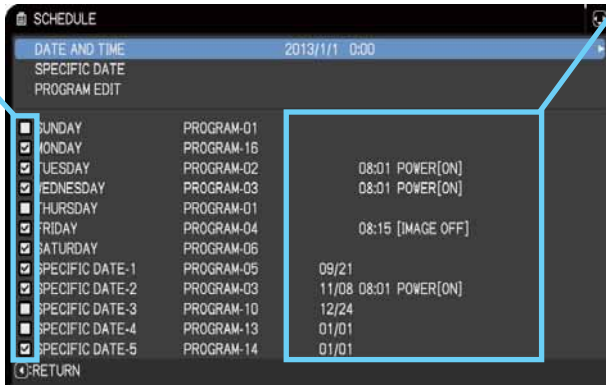

Date and first setup info could be seen with the check mark.

■ **PROGRAM EDIT**

The TIME and EVENT for Program 1 to 16 can be edited.

• **RETURN**

Select this to go back to the top menu of the SCHEDULE.

• **SELECT**

Select from PROGRAM-01 to 16 to edit. Each PROGRAM can be setup up to 20 settings

• **COPY TO**

The selected program (with the settings of TIME and EVENT) can be copied to other program.

• **APPLY**

Select this to apply and save all adjustments and settings.

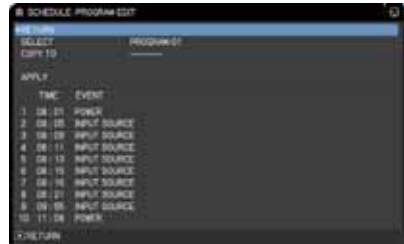

■ **How to edit the selected PROGRAM**

1. Select from 1 to 20 events.
Use the ▲/▼ cursor buttons to select. Press ► cursor button to set the TIME and EVENT.
2. Use the ◀/▶ cursor buttons to select.
3. Use the ▲/▼ cursor buttons to adjust.



EVENT can be selected as listed below.

- POWER – ON, STANDBY
- INPUT SOURCE – "input source"channel
- MY IMAGE – IMAGE-1 to 12, IMAGE OFF
- MESSENGER – TEXT-1 to 12, TEXT OFF
- ECO MODE – NORMAL, ECO
- BLANK – ON, OFF

4. Press ► cursor button to finish the settings.
5. Select APPLY to save the settings.



NOTE • Please refer to the actual on-screen display(OSD) for appropriate operation.

MENU PREFERENCES



From the MENU PREFERENCES, items shown in the table below can be performed.





Select an item using the ▲/▼ cursor buttons, and press the ► cursor button or **ENTER** button to execute the item. Then perform it according to the following table.







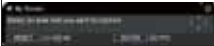



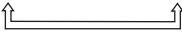

Item	Description
<p>LANGUAGE</p>	<p>Using the ▲/▼/◀/▶ buttons switches the OSD (On Screen Display) language.</p> <p>ENGLISH ⇄ FRANÇAIS ⇄ DEUTSCH ⇄ ESPAÑOL ↑ (shown in the LANGUAGE dialog) ↓</p> <p>Press the ENTER or INPUT button to save the language setting.</p>
<p>MENU POSITION</p>	<p>Using the ▲/▼/◀/▶ buttons adjusts the menu position. To quit the operation, press the MENU button on the remote control or keep no operation for about 10 seconds.</p>
<p>BLANK</p>	<p>Using the ▲/▼ buttons switches the mode for the blank screen. The blank screen is a screen for the temporarily blanking feature.</p> <p>My Screen ⇄ ORIGINAL ⇄ BLUE ⇄ WHITE ⇄ BLACK ↑ (shown in the BLANK dialog) ↓</p> <p><u>My Screen</u> : Screen can be registered by the My Screen item (85).</p> <p><u>ORIGINAL</u> : Screen preset as the standard screen.</p> <p><u>BLUE, WHITE, BLACK</u> : Plain screens in each color.</p> <ul style="list-style-type: none"> • To avoid remaining as an afterimage, the My Screen or ORIGINAL screen will change to the AUTO BLANK screen after several minutes.

MENU PREFERENCES



Item	Description
<p>AUTO BLANK</p>	<p>Using the ▲/▼ buttons switches the mode for the AUTO BLANK screen.</p> <p style="text-align: center;">BLUE ↔ WHITE ↔ BLACK </p> <ul style="list-style-type: none"> • To avoid remaining as an afterimage, displayed image will change to the designated blank color screen by AUTO BLANK after several minutes at the following conditions. <ul style="list-style-type: none"> - When My Screen or ORIGINAL is displayed as BLANK screen. - When start-up screen is displayed.
<p>START UP</p>	<p>Using the ▲/▼ buttons switches the mode for the start-up screen. The start-up screen is a screen displayed when no signal or an unsuitable signal is detected.</p> <p style="text-align: center;">My Screen ↔ ORIGINAL ↔ OFF </p> <p><u>My Screen</u> : Screen can be registered by the My Screen item (1085).</p> <p><u>ORIGINAL</u> : Screen preset as the standard screen.</p> <p><u>OFF</u> : Plain black screen.</p> <ul style="list-style-type: none"> • To avoid remaining as an afterimage, the START UP screen will change to the AUTO BLANK screen after several minutes. • When the ON is selected to the My Screen PASSWORD item in the SECURITY menu (1102), the START UP is fixed to My Screen.



Item	Description
<p>My Screen</p>	<p>This item allows you to capture an image for use as a My Screen image which can be used as the BLANK screen and START UP screen. Display the image you want to capture before executing the following procedure.</p> <p>(1) Selecting this item displays a dialog titled “My Screen”. It will ask you if you start capturing an image from the current screen.</p>  <p>Please wait for the target image to be displayed, and press the ENTER or INPUT button when the image is displayed. The image will freeze and the frame for capturing will appear.</p> <p>To stop performing, press the RESET button on the remote control.</p> <p>(2) Using the ▲/▼/◀/▶ buttons adjusts the frame position.</p>  <p>Please move the frame to the position of the image which you want to use. The frame may not be able to be moved for some input signals.</p>  <p>To start registration, press the ENTER or INPUT button on the remote control.</p>  <p>To restore the screen and return to the previous dialog, press the RESET button on the remote control.</p> <p>Registration may take several minutes.</p> <p>When the registration is completed, the registered screen and the following message is displayed for several seconds:</p> <p>“My Screen registration is finished.”</p> <p>If the registration failed, the following message is displayed:</p> <p>“A capturing error has occurred. Please try again.”</p> <ul style="list-style-type: none"> • This function cannot be selected when the ON is selected to the My Screen Lock item (86). • This function cannot be selected when the ON is selected to the My Screen PASSWORD item in SECURITY menu (102). • This function is unavailable for a signal from the LAN, HDMI 1 / 2, HDBaseT™, DVI-D or SDI/DIGITAL 1 port.

Item	Description
<p>My Screen Lock</p>	<p>Using the ▲/▼ buttons turns on/off the My Screen lock function. ON ⇄ OFF</p> <p>When the ON is selected, the item My Screen is locked. Use this function for protecting the current My Screen.</p> <ul style="list-style-type: none"> This function cannot be selected when the ON is selected to the My Screen PASSWORD item in SECURITY menu (102).
<p>OSD MESSAGE</p>	<p>Using the ▲/▼ buttons turns on/off the message function. ON ⇄ OFF ⇄ HIDE</p>  <p>■OFF : The following message functions does not work.</p> <ul style="list-style-type: none"> “AUTO IN PROGRESS” while automatically adjusting “NO INPUT IS DETECTED” “SYNC IS OUT OF RANGE” “INVALID SCAN FREQ.” “NOT AVAILABLE” “Searching....” while searching for the input “Detecting....” while an input signal is detected The indication of the ZOOM displayed by changing <ul style="list-style-type: none"> *While operating from the remote control only. The indication of the FOCUS displayed by changing The indication of the input signal displayed by changing The indication of the aspect ratio displayed by changing The indication of the PICTURE MODE displayed by changing The indication of the DYNAMIC IRIS displayed by changing The indication of the MY MEMORY displayed by changing The indication of “FREEZE” and “II” while freezing the screen by pressing the FREEZE button. The indication of the TEMPLATE displayed by changing. The indication of the ECO MODE displayed by changing. <p>■HIDE : All message functions does not work.</p> <p>The only buttons will function are as below.</p> <p>STANDBY, ON, SHUTTER, BLANK(MY BUTTON), FUNCTION Status Monitor can be operated.</p> <ul style="list-style-type: none"> To change this function, follow the steps below. <ol style="list-style-type: none"> Press the OSD button on the remote control for 3 sec. The HIDE OSD will be displayed. <ul style="list-style-type: none"> While this OSD is displayed, press the OSD button again on the remote control. Toggle and change the function. <p>ON ⇄ OFF ⇄ HIDE</p> 

Item	Description
<p>SOURCE NAME</p>	<p>Each input port for this projector can have a name applied to it.</p> <ol style="list-style-type: none"> (1) Use the ▲/▼ buttons on the MENU PREFERENCES to select SOURCE NAME and press the ► or ENTER button. The SOURCE NAME menu will be displayed. (2) Use the ▲/▼ buttons on the SOURCE NAME menu to select the port to be named and press the ► button. The SOURCE NAME dialog will be displayed. Right side of the menu is blank until a name is specified. (3) Select an icon you would like to assign to the port in the SOURCE NAME dialog. The name assigned to the port will also be automatically switched according to your icon selection. Press the ENTER or INPUT button to determine your icon selection. (4) Select a number you would like to assign to the port along with the icon. You can select the number either from blank (no number assigned), 1, 2, 3, or 4. Then press the ENTER or INPUT button. (5) If you would like to modify the name assigned to the port, select CUSTOM NAME and press the ENTER or INPUT button. <div style="display: flex; justify-content: space-around; margin-top: 20px;"> <div style="text-align: center;"> <p>DWU951/DWX951/DXG1051</p>     </div> <div style="text-align: center;"> <p>DHD951</p>     </div> </div>

Item	Description
<p>SOURCE NAME (continued)</p>	<p>(6) The current name will be displayed on the first line. Use the ▲/▼/◀/▶ buttons and the ENTER or INPUT button to select and enter characters. To erase 1 character at one time, press the RESET button or press the ◀ and INPUT button at the same time. Also if you move the cursor to DELETE or ALL CLEAR on screen and press the ENTER or INPUT button, 1 character or all characters will be erased. The name can be a maximum of 16 characters.</p> <p>(7) To change an already inserted character, press the ▲ button to move the cursor to the first line, and use the ◀/▶ buttons to move the cursor on the character to be changed.</p> <p>After pressing the ENTER or INPUT button, the character is selected. Then, follow the same procedure as described at the item (6) above.</p> <p>(8) To finish entering text, move the cursor to the OK on screen and press the ▶, ENTER or INPUT button. To revert to the previous name without saving changes, move the cursor to the CANCEL on screen and press the ◀, ENTER or INPUT button.</p> 
<p>TEMPLATE</p>	<p>Using the ▲/▼ cursor buttons switches the mode for the template screen.</p> <p>Press the ▶ cursor (or the ENTER) button to display the selected template, and press the ◀ cursor button to close the displayed screen.</p> <p>The last selected template is displayed when the MY BUTTON allocated to the TEMPLATE function is pressed (🔑 92).</p> <p>TEST PATTERN ⇔ DOT-LINE1 ⇔ DOT-LINE2 ⇔ DOT-LINE3 ⇕ ⇕</p> <p>STACK ⇔ MAP2 ⇔ MAP1 ⇔ CIRCLE2 ⇔ CIRCLE1 ⇔ DOT-LINE4</p> <p>You can turn a map upside down and scroll it horizontally when MAP1 or MAP2 is selected. To invert or scroll the map, display the guidance by pressing the RESET button on the remote three seconds or more when MAP1 or MAP2 appears.</p>



Item	Description
<p>Closed Caption C.C.</p>	<p>The Closed Caption C.C. is the function that displays a transcript or dialog of the audio portion of a video, files or other presentation or other relevant sounds. It is required to have NTSC format video or 480i@60 format component video source supporting Closed Caption C.C. feature to utilize this function. It may not work properly, depending on equipment or signal source. In this case, please turn off the Closed Caption.</p> 
	<p>DISPLAY Select Closed Caption DISPLAY setting from following options using ▲/▼ buttons. ON ⇔ OFF <u>ON</u> : Closed Caption is on. <u>OFF</u> : Closed Caption is off.</p> <ul style="list-style-type: none"> • The caption is not displayed when the OSD menu is active. • The Closed Caption is the function to display the dialogue, narration, and / or sound effects of a television program or other video sources. The Closed Caption availability is depending upon broadcaster and/or content.
	<p>MODE Select Closed Caption MODE setting from following options using ▲/▼ buttons. CAPTIONS ⇔ TEXT <u>CAPTIONS</u> : Display Closed Caption. <u>TEXT</u> : Display Text data, which is for additional information such as news reports or a TV program guide. The information covers the entire screen. Not all of the Closed Caption C.C. program has Text information.</p>
	<p>CHANNEL Select Closed Caption CHANNEL from following options using ▲/▼ buttons. 1 ⇔ 2 ⇔ 3 ⇔ 4 </p> <p>1: Channel 1, primary channel / language 2: Channel 2 3: Channel 3 4: Channel 4</p> <p>The channel data may vary, depending on the content. Some channel might be used for secondary language or empty.</p>

Item	Description
<p>DIRECT POWER ON</p>	<p>Using the ▲/▼ buttons turns on/off the DIRECT POWER ON function.</p> <p>ON ⇔ OFF</p> <p>When set to the ON, the lamp in projector will be automatically turned on without the usual procedure (34), only when the projector is supplied with the power after the power was cut while the lamp was on.</p> <ul style="list-style-type: none"> • This function does not work as long as the power has been supplied to the projector while the lamp is off. • After turning the lamp on by the DIRECT POWER ON function, if neither input nor operation is detected for about 30 minutes, the projector is turned off, even though the AUTO POWER OFF function (34) is disabled.
<p>AUTO POWER OFF</p>	<p>Using the ▲/▼ buttons adjusts the time to count down to automatically turn the projector off.</p> <p>Long (max. 99 minutes) ⇔ Short (min. 0 minute = DISABLE)</p> <div style="display: flex; justify-content: space-around;">   </div> <p>When the time is set to 0, the projector is not turned off automatically.</p> <p>When the time is set to 1 to 99, and when the passed time with no-signal or an unsuitable signal reaches at the set time, the projector lamp will be turned off.</p> <p>If one of the projector's buttons or the remote control buttons is pressed or one of the commands (except get commands) is transmitted to the CONTROL port during the corresponding time, projector will not be turned off.</p> <p>Please refer to the section Turning off the power (34).</p>
<p>SHUTTER TIMER</p>	<p>Using the ▲/▼ buttons sets the time from closing the lens shutter to automatically turning the projector off.</p> <p>1h ⇔ 3h ⇔ 6h</p> <p style="text-align: center;">↑—————↑</p> <ul style="list-style-type: none"> • The shutter will open automatically when turning the projector on again.

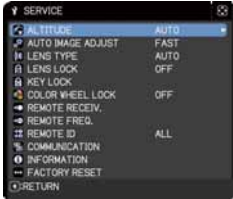

Item	Description
<p>MY BUTTON</p>	<p>This item is to assign one of the following functions to MY BUTTON (1 to 4) on the remote control (7, 8).</p> <p>(1) Use the ▲/▼ buttons on the MY BUTTON menu to select a button from MY BUTTON - 1 to 4 and press the ► or ENTER button to display the MY BUTTON setup dialog.</p> <p>(2) Then using the ▲/▼/◀/► buttons sets one of the following functions to the chosen button. Press the ENTER or INPUT button to save the setting.</p> <p><u>MY IMAGE</u>: Displays the MY IMAGE menu (7 MY IMAGE in the Network Guide).</p> <p><u>MESSENGER</u>: Turns the messenger text displayed on the screen on/off (7 Messenger Function in the Network Guide). When there is no transferred text data to display, the message "NO MESSENGER DATA" appears.</p> <p><u>BLANK</u>: Switches the BLANK function to on and off.</p> <p><u>PbyP / PIP SWAP</u>: Swaps the picture on the right with one on the left in the PbyP mode. Swaps the primary picture and the secondary picture in the PIP mode. (52)</p> <p><u>PIP Position</u>: Toggles the PIP position.</p> <p><u>STATUS MONITOR</u>: Turns on/off the back light of status monitor (28). This function is unavailable when POWER SAVE is selected in STANDBY MODE while the projector is in the standby mode.</p> <p><u>INFORMATION</u>: Displays SYSTEM INFORMATION, INPUT INFORMATION (99), WIRELESS INFORMATION, WIRED INFORMATION, OTHER INFORMATION or nothing.</p> <p><u>MY MEMORY</u>: Loads one of adjustment data stored (65). When more than one data are saved, the adjustment changes every time the MY BUTTON is pressed. When no data is saved in memory, the dialog "No saved data" appears. When the current adjustment is not saved to memory, the dialog as shown in the right appears.</p> <div data-bbox="815 991 981 1011" style="border: 1px solid black; padding: 2px; width: fit-content;"> <p>→ No saved data</p> </div> <div data-bbox="770 1031 1025 1086" style="border: 1px solid black; padding: 2px; width: fit-content;"> <p>Temporary condition My Button Reset saved parameters F Exit</p> </div> <p>If you want to keep the current adjustment, please press the ► button to exit. Otherwise loading a data will overwrite the current adjusted condition.</p> <p><u>DYNAMIC IRIS</u>: Changes the dynamic iris mode (65).</p> <p><u>FILTER RESET</u>: Displays the filter hours reset confirmation dialogue (78).</p> <p><u>TEMPLATE</u>: Makes the template pattern selected to the TEMPLATE item (88) appear or disappear.</p> <p><u>RESOLUTION</u>: Turns on/off the RESOLUTION dialog (73).</p>

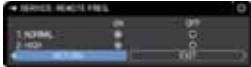
Item	Description
<p>SERVICE</p>	<p>Selecting this item displays the SERVICE menu. Select an item using the ▲/▼ buttons, and press the ► button or the ENTER button on the remote control to execute the item.</p> 
	<p>ALTITUDE Using the ▲/▼ buttons switches the rotation speed of the cooling fans. It is recommended to leave it at AUTO usually.</p> <p style="text-align: center;">HIGH-2 ⇄ HIGH-1 ⇄ NORMAL ⇄ AUTO ↑—————↑</p> <p><u>AUTO</u>: The projector changes the rotation speed automatically to suit the altitude and other environmental factors. Choose an option below when there is a trouble with the AUTO mode.</p> <p><u>NORMAL</u>: This mode can be used below 1600m (5250ft.). <u>HIGH-1</u>: This mode can be used between 1600 to 2300m (5250 to 7550ft.). <u>HIGH-2</u>: This mode can be used above 2300m (7550ft.).</p>
	<p>AUTO IMAGE ADJUST Using the ▲/▼ buttons to select one of the mode. When the DISABLE is selected, the automatic adjustment feature is disabled.</p> <p style="text-align: center;">FINE ⇄ FAST ⇄ DISABLE ↑—————↑</p> <p><u>FINE</u>: Finer tuning including H.SIZE adjustment. <u>FAST</u>: Faster tuning, setting H.SIZE to prearranged data for the input signal.</p> <ul style="list-style-type: none"> Depending on conditions, such as input image, signal cable to the projector, environment around the projector, etc., the automatic adjustment may not work correctly. In such a case, please choose DISABLE to disable the automatic adjustment, and make adjustment manually.

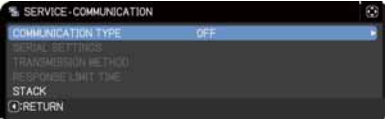

Item	Description
<p>SERVICE (continued)</p>	<p>LENS TYPE</p> <p>(1) Select the lens type currently used using the ▲/▼ buttons and press the ► or ENTER button. If AUTO is selected, the projector determines the lens type automatically.</p> <p>(2) A message dialog is displayed for confirmation. Press the ► or ENTER button to save the lens type.</p> <ul style="list-style-type: none"> • This setting has an influence on the keystone distortion etc. • The lens type determined by the projector will be displayed on the right of "AUTO". • If the projector cannot determine the lens type automatically when this item is set to AUTO, "UNKNOWN LENS" is displayed on the right of "AUTO". • About the optional lens, ask your dealer. <p>■ Lens for DXG1051 USL-901CH, SL-902CH, SD-903X CH, ML-904CH, LL-905CH, UL-906CH</p> <p>■ Lens for DWX951, DHD951, DWU951 USL-901CH, SL-902CH, SD-903W CH, ML-904CH, LL-905CH, UL-906CH</p> <p>* <u>SD-903X CH is for DXG1051 ONLY</u></p> <p>* <u>SD-903W CH is for DWX951, DHD951 and DWU951 ONLY</u></p> <p>The optical performance is decline, if a lens which is not compatible with the projector is used.</p> <p>A WARNING message will appear too, even if you select the incompatible lens type or AUTO in this function.</p> <p>A WARNING message will appear at start-up too.</p>
	<p>LENS LOCK</p> <p>Using the ▲/▼ buttons turns on/off the lens lock feature. When ON is selected, the buttons (ZOOM, ZOOM + / -, FOCUS + / -, LENS SHIFT, LENS MEMORY) are locked.</p> <p>ON ⇔ OFF</p>
	<p>KEY LOCK</p> <p>(1) Use the ▲/▼ buttons to choose the operations control. CONTROL PANEL ⇔ REMOTE CONTROL</p> <p>(2) Use the ◀/▶ buttons to select ON or OFF.</p> <p>ON ⇔ OFF</p> <p>Selecting ON in Step 2 locks the buttons except STANDBY, ON and STANDBY/ON on the operations control selected in Step 1. Selecting OFF releases the locked buttons on the operations control selected in Step 1.</p> <ul style="list-style-type: none"> • Please use this function to prevent tampering or accidental operation. • It's not possible to disable both options at the same time.

Item	Description
<p>SERVICE (continued)</p>	<p>COLOR WHEEL LOCK Using the ▲/▼ buttons turns off/on the COLOR WHEEL LOCK. ON ⇔ OFF ON : COLOR WHEEL is locked and the settings can not be changed from PICTURE MENU. OFF : COLOR WHEEL settings can be change from IMAGE SETTINGS MENU.</p>
	<p>REMOTE RECEIV. (1) Select a remote sensor using the ▲/▼ button. FRONT ⇔ REAR ⇔ HDBaseT</p> <div style="text-align: center;">  </div> <p>(2) Switch it using the ◀/▶ button. ON ⇔ OFF</p> <ul style="list-style-type: none"> •Both FRONT and REAR sensor can not be turned OFF at the same time.
	<p>REMOTE FREQ. (1) Use the ▲/▼ button to change the projector's remote sensor frequency setting (📖27). 1:NORMAL ⇔ 2:HIGH</p> <div style="text-align: right;">  </div> <p>(2) Use the ◀/▶ button to change the projector's remote sensor on or off. ON ⇔ OFF</p> <p>The factory default setting is for both 1:NORMAL and 2:HIGH to be on. If the remote control does not function correctly, disable either of them.</p> <ul style="list-style-type: none"> • It's not possible to disable both options at the same time.
	<p>REMOTE ID Use the ▲/▼ buttons on the REMOTE ID menu to select ID and press the ▶ button. ALL ⇔ 1 ⇔ 2 ⇔ 3 ⇔ 4</p> <div style="text-align: center;">  </div> <p>The projector is controlled by the remote control whose ID button is set the same number as this number. When the ALL is selected, the projector is controlled by a remote control irrespective of the ID setting.</p>

Item	Description
<p>SERVICE (continued)</p>	<p>COMMUNICATION</p> <p>Selecting this item displays COMMUNICATION menu. In this menu, you can configure the serial communication settings of the projector using the CONTROL port.</p>  <ul style="list-style-type: none"> • Select an item using the cursor buttons ▲/▼. Then pressing the ► button opens the submenu for the setting item you selected. Or, pressing the ◀ button instead of the ► button makes the menu back to the previous one without changing the setup. Each submenu can be operated as described above. • When COMMUNICATION TYPE (🔗 below) is set to OFF, the other items except STACK in COMMUNICATION menu are invalid. • For the function of serial communication, refer to the Network Guide.
	<p>COMMUNICATION TYPE</p> <p>Select the communication type for transmission via the CONTROL port.</p> <p>NETWORK BRIDGE (WIRELESS) ⇕ NETWORK BRIDGE (WIRED) ⇕ OFF</p> <p>NETWORK BRIDGE: Select this type, if it is required to control an external device as a network terminal, via this projector from the computer. Select WIRELESS or WIRED as your network connection mode. The CONTROL port doesn't accept RS-232C commands (🔗 Network Bridge Function in the Network Guide)</p> <p>OFF: Select this mode to receive RS-232C commands using the CONTROL port.</p> <ul style="list-style-type: none"> • OFF is selected as the default setting. • When you select the NETWORK BRIDGE, check the item, TRANSMISSION METHOD (🔗 97)

Item	Description	
<p>SERVICE (continued)</p>	<p>COMMUNICATION (continued)</p>	<p>SERIAL SETTINGS Select the serial communication condition for the CONTROL port.</p> <p>BAUD RATE 4800bps ⇔ 9600bps ⇔ 19200bps ⇔ 38400bps </p> <p>PARITY NONE ⇔ ODD ⇔ EVEN </p> <ul style="list-style-type: none"> • The BAUD RATE is fixed to 19200bps and PARITY is fixed NONE when the COMMUNICATION TYPE is set to OFF (OFF %).
		<p>TRANSMISSION METHOD Select the transmission method for communication by the NETWORK BRIDGE from the CONTROL port.</p> <p>HALF-DUPLEX ⇔ FULL-DUPLEX</p> <p><u>HALF-DUPLEX</u>: This method lets the projector make two way communication, but only one direction, either transmitting or receiving data, is allowed at a time.</p> <p><u>FULL-DUPLEX</u>: This method lets the projector make two way communication, transmitting and receiving data at the same time.</p> <ul style="list-style-type: none"> • HALF-DUPLEX is selected as the default setting. • If you select HALF-DUPLEX, check the setting of the item RESPONSE LIMIT TIME (RESP %).

Item	Description	
<p>SERVICE (continued)</p>	<p>COMMUNICATION (continued)</p>	<p>RESPONSE LIMIT TIME Select the time period to wait for receiving response data from other device communicating by the NETWORK BRIDGE and the HALF-DUPLEX through the CONTROL port.</p> <p>OFF ⇔ 1s ⇔ 2s ⇔ 3s </p> <p><u>OFF</u>: Select this mode if it is not required to check the responses from the device that the projector sends data to. In this mode, the projector can send out data from the computer continuously.</p> <p><u>1s /2s /3s</u>: Select the time period to keep the projector waiting for response from the device that the projector sends data to. While waiting the response, the projector does not send out any data from the CONTROL port.</p> <ul style="list-style-type: none"> • This menu is available only when the NETWORK BRIDGE is selected for the COMMUNICATION TYPE and the HALF-DUPLEX is selected for the TRANSMISSION METHOD (p. 97). • OFF is selected as the default setting.
		<p>STACK Selecting this item displays the STACK menu. For more information, please see Instant Stack Guide.</p> <ul style="list-style-type: none"> • When STACK MODE is set to MAIN or SUB, the other items in COMMUNICATION menu are invalid.

Item	Description
<p>SERVICE (continued)</p>	<p>INFORMATION</p> <p>Selecting this item displays a dialog titled “INPUT INFORMATION”. It shows the information about the current input.</p> <div style="display: flex; justify-content: space-around; align-items: center;">    </div> <ul style="list-style-type: none"> • The “FRAME LOCK” message on the dialog means the frame lock function is working. • This item can't be selected for no signal and sync out. • When the MY TEXT DISPLAY is set to ON, the MY TEXT is displayed together with the input information in the INPUT INFORMATION box (📖 105).
	<p>FACTORY RESET</p> <p>Selecting OK using the ► button performs this function. By this function, all the items in all of menus will collectively return to the initial setting.</p> <p>Note that the settings of the following items cannot be reset: LAMP TIME, FILTER HOURS, LANGUAGE, FILTER MESSAGE, STANDBY MODE, COMMUNICATION, NETWORK, SECURITY</p> <p>CANCEL ⇨ OK</p>

NETWORK menu

See the **Network Guide** for details of NETWORK operation.

Remember that incorrect network settings on this projector may cause trouble on the network. Be sure to consult with your network administrator before connecting to an existing access point on your network.

SECURITY menu

This projector is equipped with security functions.

From the SECURITY menu, items shown in the table below can be performed.

To use SECURITY menu: User registration is required before using the security functions.



Enter to the SECURITY menu

1. Press the ► button. The ENTER PASSWORD box will be displayed.
2. Use the ▲/▼/◀/▶ buttons to enter the registered password. The factory default password is as follows.

DXG1051: 7709
DWX951: 2107
DHD951: 4517
DWU951: 0120



This password can be changed (see below). Move the cursor to the right side of the ENTER PASSWORD box and press the ► button to display the SECURITY menu.





- It is strongly recommended the factory default password to be changed as soon as possible.
 - If an incorrect password is input, the ENTER PASSWORD box will be displayed again. If incorrect password is input 3 times, the projector will turn off. Afterwards the projector will turn off every time an incorrect password is input.
3. Items shown in the table below can be performed.





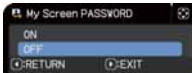



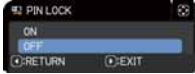

If you have forgotten your password





- (1) While the ENTER PASSWORD box is displayed, press and hold the **RESET** button on the remote control for about 3 seconds or press and hold the **INPUT** button for 3 seconds while pressing the ► button on the projector.
 - (2) The 10 digit Inquiring Code will be displayed. Contact your dealer with the 10 digit Inquiring Code. Your password will be sent after your user registration information is confirmed.
- If there is no key input for about 55 seconds while the Inquiring Code is displayed, the menu will close. If necessary, repeat the process from (1).

Item	Description
<p>SECURITY PASSWORD CHANGE</p>	<ol style="list-style-type: none"> (1) Use the ▲/▼ buttons on the SECURITY menu to select SECURITY PASSWORD CHANGE and press the ► button to display the ENTER NEW PASSWORD box.  (2) Use the ▲/▼/◀/▶ buttons to enter the new password. (3) Move the cursor to the right side of the ENTER NEW PASSWORD box and press the ► button to display the NEW PASSWORD AGAIN box, enter the same password again.  (4) Move the cursor to the right side of the NEW PASSWORD AGAIN box and press the ► button and the NOTE NEW PASSWORD box will be displayed for about 30 seconds, please make note of the password during this time. Pressing the ENTER button on the remote control or ► button on the projector will close the NOTE NEW PASSWORD box.  <ul style="list-style-type: none"> • Please do not forget your password.

Item	Description
<p style="text-align: center;">My Screen PASSWORD</p>	<p>The My Screen PASSWORD function can be used to prohibit access to the My Screen function and prevent the currently registered My Screen image from being overwritten.</p> <p>1 Turning on the My Screen PASSWORD</p> <p>1-1 Use the ▲/▼ buttons on the SECURITY menu to select My Screen PASSWORD and press the ► button to display the My Screen PASSWORD on/off menu.</p>  <p>1-2 Use the ▲/▼ buttons on the My Screen PASSWORD on/off menu to select ON. The ENTER NEW PASSWORD box (small) will be displayed.</p>  <p style="text-align: center;">ENTER NEW PASSWORD box (small)</p> <p>1-3 Use the ▲/▼/◀/▶ buttons to enter the password. Move the cursor to the right side of the ENTER NEW PASSWORD box (small) and press the ► button to display the NEW PASSWORD AGAIN box, enter the same PASSWORD again.</p>  <p>1-4 Move the cursor to the right side of the NEW PASSWORD AGAIN box and press the ► button to display the NOTE NEW PASSWORD box for about 30 seconds, please make note of the password during this time.</p>  <p>Pressing the ENTER button on the remote control or ► button on the projector will return to My Screen PASSWORD on/off menu.</p> <p>When a password is set for My Screen:</p> <ul style="list-style-type: none"> • The My Screen registration function (and menu) will be unavailable. • The My Screen Lock menu will be unavailable. • The START UP setting will be locked on My Screen (and the menu will be unavailable). <p>Turning the My Screen PASSWORD off will allow normal operation of these functions.</p> <ul style="list-style-type: none"> • Please do not forget your My Screen PASSWORD. <p>2 Turning off the My Screen PASSWORD</p> <p>2-1 Follow the procedure in 1-1 to display the My Screen PASSWORD on/off menu.</p> <p>2-2 Select OFF to display the ENTER PASSWORD box (large). Enter the registered password and the screen will return to the My Screen PASSWORD on/off menu.</p>  <p style="text-align: center;">ENTER PASSWORD box (large)</p> <p>If an incorrect PASSWORD is input, the menu will close. If necessary, repeat the process from 2-1.</p> <p>3 If you have forgotten your password</p> <p>3-1 Follow the procedure in 1-1 to display the My Screen PASSWORD on/off menu.</p> <p>3-2 Select OFF to display the ENTER PASSWORD box (large). The 10 digit Inquiring Code will be displayed inside the box.</p> <p>3-3 Contact your dealer with the 10 digit Inquiring Code. Your password will be sent after your user registration information is confirmed.</p>

Item	Description
<p>PIN LOCK</p>	<p>PIN LOCK is a function which prevents the projector from being used unless a registered Code is input.</p> <p>1 Turning on the PIN LOCK</p> <p>1-1 Use the ▲/▼ buttons on the SECURITY menu to select PIN LOCK and press the ► button or the ENTER button to display the PIN LOCK on/off menu.</p>  <p>1-2 Use the ▲/▼ buttons on the PIN LOCK on/off menu to select ON and the Enter PIN Code box will be displayed.</p>  <p>1-3 Input a 4 part PIN code using the ▲/▼/◀/▶, COMPUTER 1 or INPUT button. The PIN Code again box will appear. Reenter the same PIN code. This will complete the PIN code registration.</p>  <ul style="list-style-type: none"> • If there is no key input for about 55 seconds while the Enter PIN Code box or the PIN Code again box is displayed, the menu will close. If necessary, repeat the process from 1-1. <p>Afterwards, anytime the projector is restarted after AC power is turned off the Enter PIN Code box will be displayed. Enter the registered PIN code. The projector can be used after entering the registered PIN code. If an incorrect PIN code is input, the Enter PIN code box will be displayed again. If an incorrect PIN code is input 3 times, the projector will turn off. Afterwards the projector will turn off every time an incorrect PIN code is input. The projector will also turn off if there is no key input for about 5 minutes while the Enter PIN code box is displayed. This function will activate only when the projector is started after AC power is turned off.</p> <ul style="list-style-type: none"> • Please do not forget your PIN code. <p>2 Turning off the PIN LOCK</p> <p>2-1 Follow the procedure in 1-1 to display the PIN LOCK on/off menu.</p> <p>2-2 Use the ▲/▼ buttons to select OFF and the Enter PIN Code box will be displayed.</p> <p>Enter the registered PIN code to turn the PIN LOCK function off.</p> <p>If an incorrect PIN code is input 3 times, the projector will turn off.</p> <p>3 If you have forgotten your PIN code</p> <p>3-1 While the Enter PIN code box is displayed, press and hold the RESET button for three seconds or press and hold the INPUT button for 3 seconds while pressing the ► button on the projector. The 10 digit Inquiring Code will be displayed.</p> <ul style="list-style-type: none"> • If there is no key input for about 5 minutes while the Inquiring Code is displayed, the projector will turn off.  <p>3-2 Contact your dealer with the 10 digit Inquiring Code. Your PIN code will be sent after your user registration information is confirmed.</p>

Item	Description
<p>MY TEXT PASSWORD</p>	<p>The MY TEXT PASSWORD function can prevent the MY TEXT from being overwritten. When the password is set for the MY TEXT;</p> <ul style="list-style-type: none"> • The MY TEXT DISPLAY menu will be unavailable, which can prohibit changing the DISPLAY setting. • The MY TEXT WRITING menu will be unavailable, which can prevent the MY TEXT from being overwritten. <p>1 Turning on the MY TEXT PASSWORD</p> <p>1-1 Use the ▲/▼ buttons on the SECURITY menu to select the MY TEXT PASSWORD and press the ► button to display the MY TEXT PASSWORD on/off menu.</p>  <p>1-2 Use the ▲/▼ buttons on the MY TEXT PASSWORD on/off menu to select ON. The ENTER NEW PASSWORD box (small) will be displayed.</p>  <p>1-3 Use the ▲/▼/◀/▶ buttons to enter the password. Move the cursor to the right side of the ENTER NEW PASSWORD box (small) and press the ► button to display the NEW PASSWORD AGAIN box, and then enter the same password again.</p>  <p>1-4 Move the cursor to the right side of the NEW PASSWORD AGAIN box and press ► button to display the NOTE NEW PASSWORD box for about 30 seconds, then please make note of the password during this time.</p>  <p>Pressing the ENTER button on the remote control or ► button on the projector will return to the MY TEXT PASSWORD on/off menu.</p> <p>2 Turning off the MY TEXT PASSWORD</p> <p>2-1 Follow the procedure in 1-1 to display the MY TEXT PASSWORD on/off menu.</p> <p>2-2 Select OFF to display the ENTER PASSWORD box (large). Enter the registered password and the screen will return to the MY TEXT PASSWORD on/off menu.</p>  <p>If an incorrect password is input, the menu will close. If necessary, repeat the process from 2-1</p> <p>3 If you have forgotten your password</p> <p>3-1 Follow the procedure in 1-1 to display the MY TEXT PASSWORD on/off menu.</p> <p>3-2 Select OFF to display the ENTER PASSWORD box (large). The 10 digit inquiring code will be displayed inside the box.</p> <p>3-3 Contact your dealer with the 10 digit inquiring code. Your password will be sent after your user registration information is confirmed.</p>

Item	Description
<p>MY TEXT DISPLAY</p>	<p>(1) Use the ▲/▼ buttons on the SECURITY menu to select the MY TEXT DISPLAY and press the ► or ENTER button to display the MY TEXT DISPLAY on/off menu.</p>  <p>(2) Use the ▲/▼ buttons on the MY TEXT DISPLAY on/off menu to select on or off.</p> <p>ON ⇔ OFF</p> <p>When it is set ON, the MY TEXT will be displayed on the START UP screen and the INPUT INFORMATION when the INFORMATION on the SERVICE menu is chosen.</p>  <ul style="list-style-type: none"> • This function is available only when the MY TEXT PASSWORD function is set to the OFF.
<p>MY TEXT WRITING</p>	<p>(1) Use the ▲/▼ buttons on the SECURITY menu to select the MY TEXT WRITING and press the ► button. The MY TEXT WRITING dialog will be displayed.</p>  <p>(2) The current MY TEXT will be displayed on the first 3 lines. If not yet written, the lines will be blank.</p> <p>Use the ▲/▼/◀/▶ buttons and the ENTER or INPUT button to select and enter characters. To erase 1 character at one time, press the RESET button or press the ◀ and INPUT button at the same time. Also if you move the cursor to DELETE or ALL CLEAR on screen and press the ENTER or INPUT button, 1 character or all characters will be erased. The MY TEXT can be input up to 24 characters on each line.</p>  <p>(3) To change an already inserted character, press the ▲/▼ button to move the cursor to one of the first 3 lines, and use the ◀/▶ buttons to move the cursor on the character to be changed.</p> <p>After pressing the ENTER or INPUT button, the character is selected. Then, follow the same procedure as described at the item (2) above.</p>  <p>(4) To finish entering text, move the cursor to the OK on screen and press the ►, ENTER or INPUT button. To revert to the previous MY TEXT without saving changes, move the cursor to the CANCEL on screen and press the ◀, ENTER or INPUT button.</p> <ul style="list-style-type: none"> • The MY TEXT WRITING function is available only when the MY TEXT PASSWORD function is set to OFF.

Item	Description
SECURITY INDICATOR	<p>Selecting this item displays the SECURITY INDICATOR dialog. Use the ▲/▼ buttons to select ON or OFF.</p> <p>ON ⇄ OFF</p> <p>When ON is selected while PIN LOCK is ON, the SECURITY indicator blinks in yellow in the standby mode (📖 79, 103).</p>
STACK LOCK	<p>Selecting this item displays the STACK LOCK dialog. For more information, please see Instant Stack Guide.</p>

Maintenance

Replacing the lamp

A lamp has finite product life. Using the lamp for long periods of time could cause the pictures darker or the color tone poor. Note that each lamp has a different lifetime, and some may burst or burn out soon after you start using them.

Preparation of a new lamp and early replacement are recommended. To prepare a new lamp, make contact with your dealer and tell the lamp type number.

- DWU951/DWX951/DXG1051

Type number : DT01585

- DHD951

Type number : DT01735

1. Turn the projector off, and unplug the power cord. Allow the projector to cool for at least 45 minutes.
2. Prepare a new lamp. If the projector is mounted with specified mounting accessories, or if the lamp has broken, also ask the dealer to replace the lamp. In case of replacement by yourself, follow the following procedure.
3. Loosen the screw (marked by arrow) of the lamp cover and then slide down and lift the lamp cover to remove it. The lamp cover is tied to a short wire to prevent from falling.

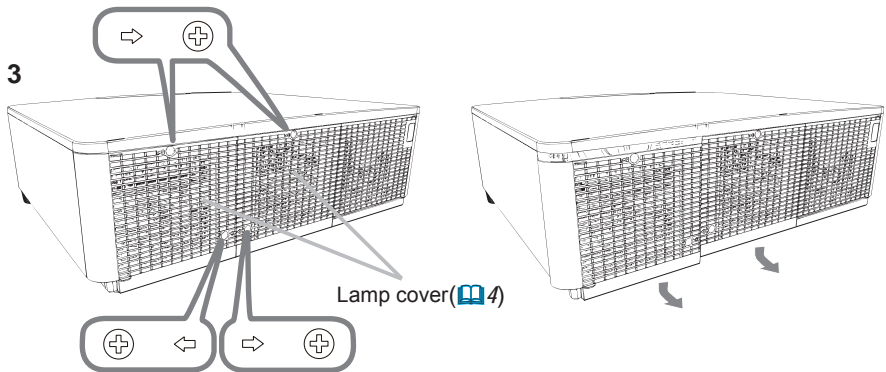

4. Loosen the 3 screws (marked by arrow) of the lamp, and slowly pull the lamp out by the handles. Never loosen any other screws.

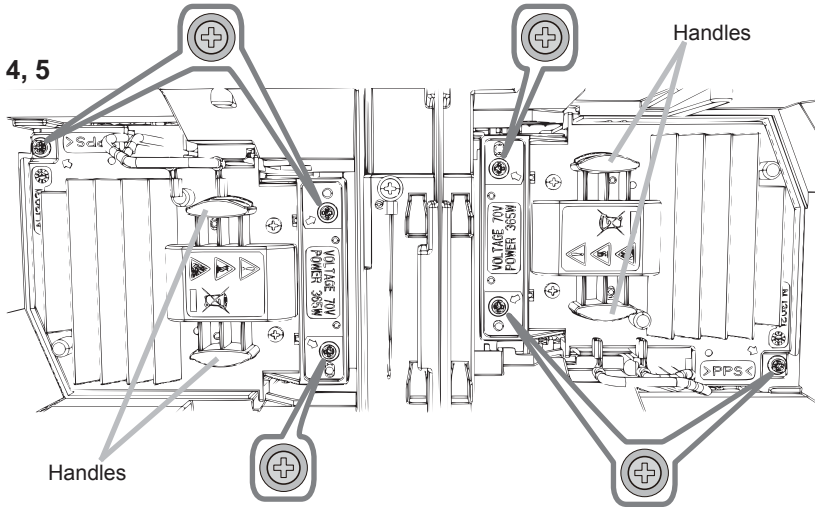

5. Insert the new lamp, and retighten firmly the 3 screws of the lamp that are loosened in the previous process to lock it in place.
6. While putting the interlocking parts of the lamp cover and the projector together, slide the lamp cover back in place. Then firmly fasten the screw of the lamp cover.
7. Turn the projector on and reset the lamp time using the LAMP TIME item in the OPTION menu.
 - (1) Press the **MENU** button to display a menu.
 - (2) Select as the following using the cursor button.
EASY MENU > ADVANCED MENU > SETUP > LAMP & FILTER
 - (3) Select LAMP-1 HOURS or LAMP-2 HOURS.
 - (4) Press the ► button to select “OK” on the dialog. It performs resetting the lamp time.

⚠ CAUTION ► Do not touch the interior of the projector, while the lamp is taken out.

NOTE • Please reset the lamp time only when you have replaced the lamp, for a suitable indication about the lamp.
Lamp cover is assembled with cooling fan, please handle with care.

Lamp warning

 **HIGH VOLTAGE**  **HIGH TEMPERATURE**  **HIGH PRESSURE**

⚠ WARNING ▶ The projector uses a high-pressure mercury glass lamp. The lamp can break with a loud bang, or burn out, if jolted or scratched, handled while hot, or worn over time. Note that each lamp has a different lifetime, and some may burst or burn out soon after you start using them. In addition, if the bulb bursts, it is possible for shards of glass to fly into the lamp housing, and for gas containing mercury and dust containing fine particles of glass to escape from the projector's vent holes.

▶ **About disposal of a lamp:** This product contains a mercury lamp; do not put it in a trash. Dispose of it in accordance with environmental laws.

- For lamp recycling, go to www.lamprecycle.org (in the US).
- For product disposal, consult your local government agency or www.eiae.org (in the US) or www.epsc.ca (in Canada).

For more information, call your dealer.



Disconnect the plug from the power outlet

- If the lamp should break (it will make a loud bang when it does), unplug the power cord from the outlet, and make sure to request a replacement lamp from your local dealer. Note that shards of glass could damage the projector's internals, or cause injury during handling, so please do not try to clean the projector or replace the lamp yourself.
- If the lamp should break (it will make a loud bang when it does), ventilate the room well, and make sure not to inhale the gas or fine particles that come out from the projector's vent holes, and not to get them into your eyes or mouth.
- Before replacing the lamp, turn the projector off and unplug the power cord, then wait at least 45 minutes for the lamp to cool sufficiently. Handling the lamp while hot can cause burns, as well as damaging the lamp.



- Never unscrew except the appointed (marked by an arrow) screws.
- Do not open the lamp cover while the projector is suspended from a ceiling. This is dangerous, since if the lamp's bulb has broken, the shards will fall out when the cover is opened. In addition, working in high places is dangerous, so ask your local dealer to have the lamp replaced even if the bulb is not broken.
- Do not use the projector with the lamp cover removed. At the lamp replacing, make sure that the screws are screwed in firmly. Loose screws could result in damage or injury.



- Use only the lamp of the specified type. Use of a lamp that does not meet the lamp specifications for this model could cause a fire, damage or shorten the life of this product.
- If the lamp breaks soon after the first time it is used, it is possible that there are electrical problems elsewhere besides the lamp. If this happens, consult your local dealer or a service representative.
- Handle with care: jolting or scratching could cause the lamp bulb to burst during use.
- Using the lamp for long periods of time, could cause it dark, not to light up or to burst. When the pictures appear dark, or when the color tone is poor, please replace the lamp as soon as possible. Do not use old (used) lamps; this is a cause of breakage.

Cleaning and replacing the air filter

Please check and clean the air filter periodically. When the indicators or a message prompts you to clean the air filter, comply with it as soon as possible.

Replace the filters when they are damaged or too soiled.

Request for a filter set with the following type number from your dealer when purchasing a new one.

Type number : UX39551

1. Turn the projector off, and unplug the power cord. Allow the projector to sufficiently cool down.
2. Use a vacuum cleaner on and around the filter cover.
3. Slide the filter unit downward to the lower end. Then, slightly lift to remove it.

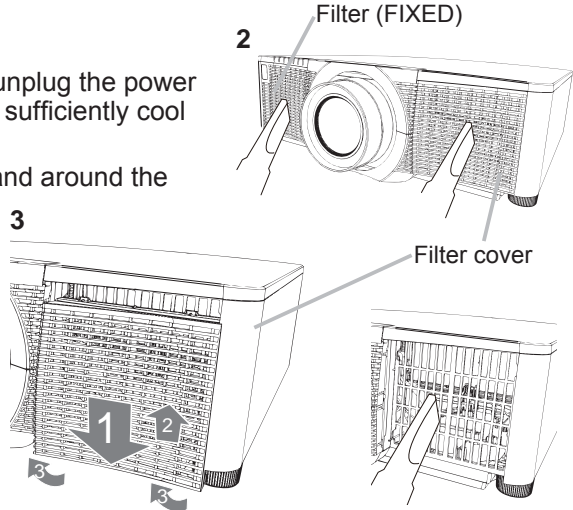

4. Take the fine meshed filter out while holding the filter cover. It is recommended to leave the coarse meshed filter in the filter cover as it is.

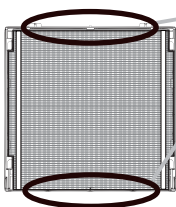

Remove the Filter(fine meshed) either from upper side or from lower side only. Do not remove the Filter(fine meshed) from the other sides to prevent from tearing apart.

5. Use a vacuum cleaner on both sides of the fine meshed filter while holding it so it will not be sucked in. Use a vacuum cleaner for the inside of the filter cover to clean up the coarse meshed filter. If the filters are damaged or heavily soiled, replace them with new ones.
6. Place the filter back into the filter cover, making sure the plastic band is on the upper side.
7. Install the filter unit back into the projector.

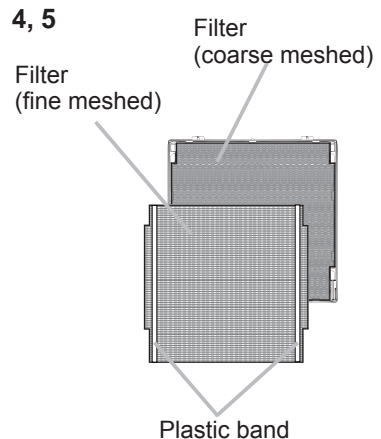

8. Turn the projector on and reset the filter hours using the FILTER HOURS item in the EASY MENU.
 - (1) Press the **MENU** button to display a menu.
 - (2) Point at the FILTER HOURS using the ▲/▼ cursor buttons, then press the ► cursor (or the **ENTER** / the **RESET**) button. A dialog will appear.
 - (3) Press the ► cursor button to select the “OK” on the dialog. It performs resetting the filter hours.

⚠ **WARNING** ► Before taking care of the air filter, make sure the power cable is not plugged in, then allow the projector to cool sufficiently.

► Use only the air filter of the specified type. Do not use the projector without the air filter or the filter cover. It could result in a fire or malfunction to the projector.

► Clean the air filter periodically. If the air filter becomes clogged by dust or the like, internal temperatures rise and could cause a fire, a burn or malfunction to the projector.

NOTE • Please reset the filter hours only when you have cleaned or replaced the air filter, for a suitable indication about the air filter.

• The projector may display the message such as the “CHECK THE AIR FLOW” or turn off the projector, to prevent the internal heat level rising.

Replacing the internal clock battery

Consumption of the battery makes the clock not to work correctly. When the clock is inaccurate or stopped, please replace the battery according to the following procedures.

1. Turn the projector off, and unplug the power cord. Allow the projector to cool sufficiently.
2. After making sure that the projector has cooled adequately, slowly turn over the projector, so that the bottom is facing.
3. Turn the battery cover fully in the direction indicated "OPEN" using a coin or the like, and pick the cover up to remove it.
4. Pry up the battery using a flathead screwdriver or the like to take it out. While prying it up, put a finger lightly on the battery since it may pop out of the holder.
5. Replace the battery with a new **HITACHI MAXELL**, Part No.**CR2032** or **CR2032H**. Slide the battery in under the plastic claw, and push it into the holder until it clicks.
6. Replace the battery cover in place, then turn it in the direction indicated "CLOSE" using such as coins, to fix.

Battery Cover

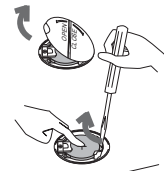
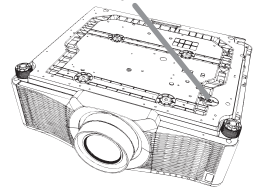

⚠WARNING ▶ Always handle the batteries with care and use them only as directed. Battery may explode if mistreated. Do not recharge, disassemble or dispose of in fire.

And also improper use may result in cracking or leakage, which could result in fire, injury and/or pollution of the surrounding environment.

- Be sure to use only the batteries specified.
- Make sure the plus and minus terminals are correctly aligned when loading a battery.
- Keep a battery away from children and pets. If swallowed consult a physician immediately for emergency treatment.
- Do not short circuit or solder a battery.
- Do not allow a battery in a fire or water. Keep batteries in a dark, cool and dry place.
- If you observe battery leakage, wipe out the leakage and then replace a battery. If the leakage adheres to your body or clothes, rinse well with water immediately.
- Obey the local laws on disposing a battery.

Other care

Inside of the projector

In order to ensure the safe use of your projector, please have it cleaned and inspected by your dealer about once every year.

Caring for the lens

If the lens is flawed, soiled or fogged, it could cause deterioration of display quality. Please take care of the lens, being cautious of handling.

1. Turn the projector off, and unplug the power cord. Allow the projector to cool sufficiently.
2. After making sure that the projector is cool adequately, lightly wipe the lens with a commercially available lens-cleaning wipe. Do not touch the lens directly with your hand.

Caring for the cabinet and remote control

Incorrect care could have adverse influence such as discoloration, peeling paint, etc.

1. Turn the projector off, and unplug the power cord. Allow the projector to cool sufficiently.
2. After making sure that the projector is cool adequately, lightly wipe with gauze or a soft cloth.
If the projector is extremely dirty, dip soft cloth in water or a neutral cleaner diluted in water, and wipe lightly after wringing well. Then, wipe lightly with a soft, dry cloth.

△WARNING ▶ Before caring, make sure the power cord is not plugged in, and then allow the projector to cool sufficiently. The care in a high temperature state of the projector could cause a burn and/or malfunction to the projector.

▶ Never try to care for the inside of the projector personally. Doing is so dangerous.

▶ Avoid wetting the projector or inserting liquids in the projector. It could result in a fire, an electric shock, and/or malfunction to the projector.

- Do not put anything containing water, cleaners or chemicals near the projector.
- Do not use aerosols or sprays.

△CAUTION ▶ Please take right care of the projector according to the following. Incorrect care could cause not only an injury but adverse influence such as discoloration, peeling paint, etc.

▶ Do not use cleaners or chemicals other than those specified in this manual.



▶ Do not polish or wipe with hard objects.

NOTICE ▶ Do not directly touch the lens surface with hands.

Regarding the indicator lamps

The indicators may differ from usual, check and cope with it according to the following table.

The indicators are described as below.

		
Lit Steady light	Blinking	Off

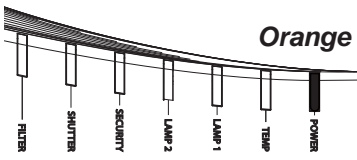
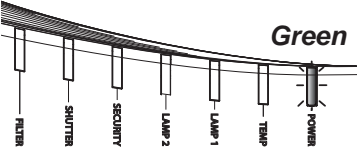
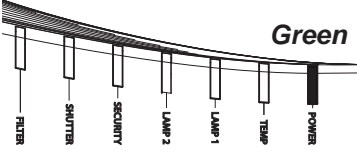
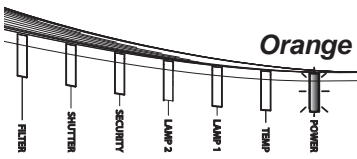
Indicator Status	Description
 <p>Orange</p>	<p>The projector is in a standby state. Please refer to the section "Power on/off".</p>
 <p>Green</p>	<p>The projector is warming up. Please wait.</p>
 <p>Green</p>	<p>The projector is in an on state. Ordinary operations may be performed.</p>
 <p>Orange</p>	<p>The projector is cooling down. Please wait.</p>

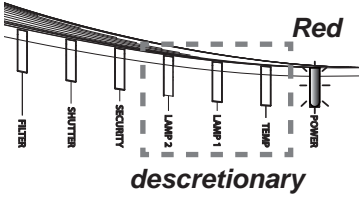
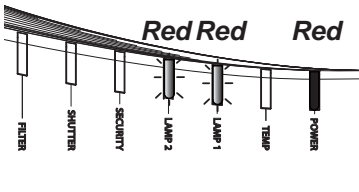
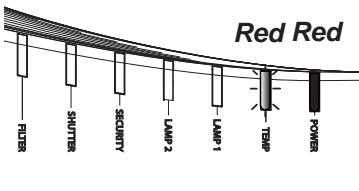
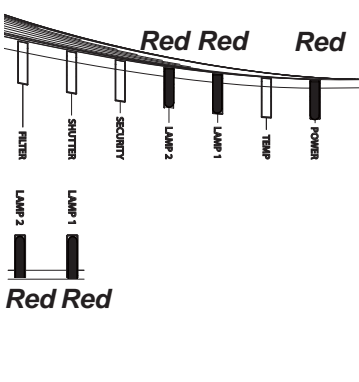
Indicator Status	Description
 <p style="text-align: right;"><i>Red</i></p> <p style="text-align: center;"><i>descretionary</i></p>	<p>The projector is cooling down. A certain error has been detected. Please wait until POWER indicator finishes blinking, and then perform the proper measure using the item descriptions below.</p>
 <p style="text-align: center;"><i>Red Red Red</i></p>	<p>The lamp cover has not been properly fixed. Please turn the power off, and allow the projector to cool down at least 45 minutes. After the projector has sufficiently cooled down, please make confirmation of the attachment state of the lamp cover. After performing any needed maintenance, turn the power on again. If the same indication is displayed after the remedy, please contact your dealer or service company.</p>
 <p style="text-align: center;"><i>Red Red</i></p>	<p>The cooling fan is not operating. Please turn the power off, and allow the projector to cool down at least 20 minutes. After the projector has sufficiently cooled down, please make confirmation that no foreign matter has become caught in the fan, etc., and then turn the power on again. If the same indication is displayed after the remedy, please contact your dealer or service company.</p>
 <p style="text-align: center;"><i>Red Red Red</i></p> <p style="text-align: center;"><i>Red Red</i></p>	<p>The lamp does not light, and there is a possibility that interior portion has become heated. Please turn the power off, and allow the projector to cool down at least 20 minutes. After the projector has sufficiently cooled down, please make confirmation of the following items, and then turn the power on again.</p> <ul style="list-style-type: none"> • Is there blockage of the air passage aperture? • Is the air filter dirty? • Please use the unit within the temperature range. NORMAL MODE: 0 to 45°C ECO MODE: 0 to 50°C HIGH ALTITUDE: 0 to 40°C <p>If the same indication is displayed after the remedy, please change the lamp referring to the section Replacing the lamp.</p>

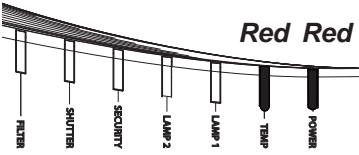
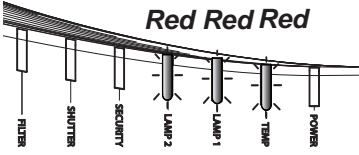
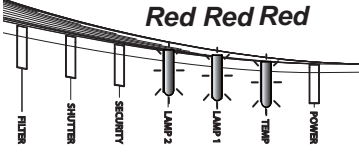
Indicator Status	Description
 <p style="text-align: right;">Red Red</p>	<p>There is a possibility that the interior portion has become heated.</p> <p>Please turn the power off, and allow the projector to cool down at least 20 minutes. After the projector has sufficiently cooled down, please make confirmation of the following items, and then turn the power on again.</p> <ul style="list-style-type: none"> • Is there blockage of the air passage aperture? • Is the air filter dirty? • Please use the unit within the temperature range. NORMAL MODE: 0 to 45°C ECO MODE: 0 to 50°C HIGH ALTITUDE: 0 to 40°C • Is the setting for ALTITUDE appropriate? • Is the exhaust air (hot/cold) from peripheral equipments blowing against the ventilation opening of projector? <p>For details on ALTITUDE, refer to ALTITUDE of SERVICE in the OPTION menu. If the projector is used with a wrong setting, it may cause damage to the projector itself or the parts inside.</p>
 <p style="text-align: right;">Red Red Red</p> <p style="text-align: center;">Blinking alternately</p>	<p>The interior portion is cold.</p> <p>Please use the unit within the temperature range.</p> <p>NORMAL MODE: 0 to 45°C ECO MODE: 0 to 50°C HIGH ALTITUDE: 0 to 40°C</p> <p>After the treatment, restart the projector.</p>
 <p style="text-align: right;">Red Red Red</p> <p style="text-align: center;">Blinking at the same time</p>	<p>It is time to clean the air filter.</p> <p>Please turn the power off immediately, and clean or change the air filter referring to the section Cleaning and replacing the air filter. After cleaning or changing the air filter, please be sure to reset the filter hours.</p> <p>After the remedy, restart the projector.</p>

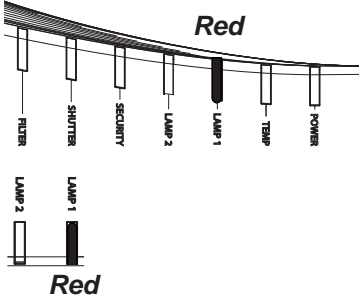
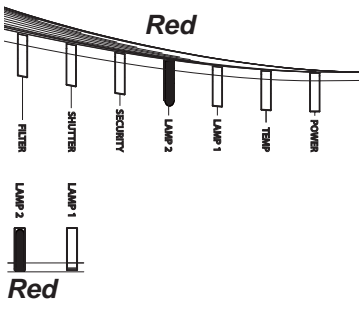
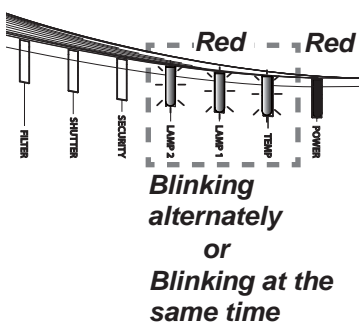
Indicator Status	Description
 <p style="text-align: center;">Red</p> <p style="text-align: center;">Red</p>	<p>This is a Lamp-1 warning. Lamp-1 is turned off. Please turn the power off, and allow the projector to cool down at least 45 minutes. Restart the projector. If the same indication is displayed, please contact your dealer or service company.</p>
 <p style="text-align: center;">Red</p> <p style="text-align: center;">Red</p>	<p>This is a Lamp-2 warning. Lamp-2 is turned off. Please turn the power off, and allow the projector to cool down at least 45 minutes. Restart the projector. If the same indication is displayed, please contact your dealer or service company.</p>
 <p style="text-align: center;">Red Red</p> <p style="text-align: center;">Blinking alternately or Blinking at the same time</p>	<p>Other error has occurred.</p> <ul style="list-style-type: none"> • Please use the unit within the temperature range. NORMAL MODE: 0 to 45°C ECO MODE: 0 to 50°C HIGH ALTITUDE: 0 to 40°C • Please check installation. Install the projector correctly, and restart it. <p>If the same indication is displayed after the remedy, please contact your dealer or service company.</p>

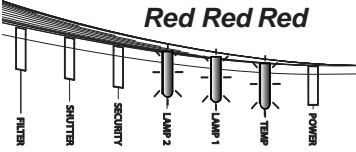
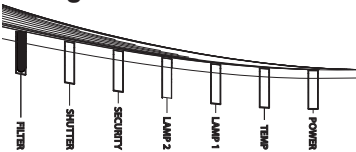
Indicator Status	Description
<p style="text-align: center;">Red Red Red</p>  <p style="text-align: center;">Blinking twice alternately</p>	<p>Color Wheel error occurred.</p> <p>If the same indication is displayed, please contact your dealer or service company.</p>
<p style="text-align: center;">Orange or Red</p> 	<p>The air filter is clogged or dirty. (📖 120)</p> <p>Please check and clean the air filter</p> <p>Make sure the power cable is not plugged in, then allow the projector to cool sufficiently.</p> <p>In addition, please see the section "There is a possibility that the interior portion has become heated" (📖 116).</p>

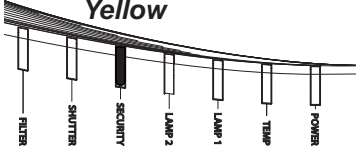
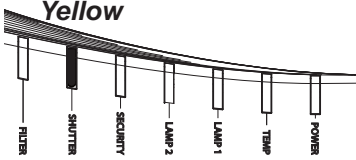
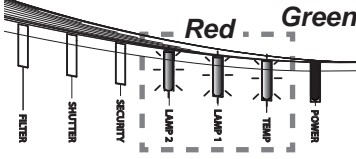
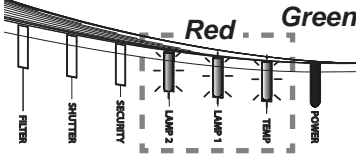
Indicator Status	Description
<p>Yellow</p>  <p>The diagram shows a row of indicator lamps labeled FILTER, SHUTTER, SECURITY, LAMP 2, LAMP 1, TEMP, and POWER. The SECURITY lamp is illuminated with a yellow bar, while all other lamps are unlit.</p>	<p>PIN LOCK function is active. Please see SECURITY menu > PIN LOCK(📖103).</p> <p>If the same indication is displayed after the remedy, please contact your dealer or service company.</p>
<p>Yellow</p>  <p>The diagram shows a row of indicator lamps labeled FILTER, SHUTTER, SECURITY, LAMP 2, LAMP 1, TEMP, and POWER. The SHUTTER lamp is illuminated with a yellow bar, while all other lamps are unlit.</p>	<p>The shutter is closed. Press the SHUTTER button on the remote control or on the control panel to open the shutter.</p>
<p>Red . . . Green</p>  <p>The diagram shows a row of indicator lamps labeled FILTER, SHUTTER, SECURITY, LAMP 2, LAMP 1, TEMP, and POWER. LAMP 1 and LAMP 2 are shown with dashed boxes around them, indicating they are blinking. The word 'Red' is positioned above LAMP 1 and 'Green' is positioned above LAMP 2.</p> <p>Blinking at the same time</p>	<p>This is the indication while cleaning or replacing the air filter . Please reset the filter hours for a suitable indication.</p>
<p>Red . . . Green</p>  <p>The diagram shows a row of indicator lamps labeled FILTER, SHUTTER, SECURITY, LAMP 2, LAMP 1, TEMP, and POWER. LAMP 1 and LAMP 2 are shown with dashed boxes around them, indicating they are blinking. The word 'Red' is positioned above LAMP 1 and 'Green' is positioned above LAMP 2.</p> <p>Blinking alternately</p>	<p>There is a possibility that the interior portion has become overcooled.</p> <ul style="list-style-type: none"> • Please use the unit within the temperature range. NORMAL MODE: 0 to 45°C ECO MODE: 0 to 50°C HIGH ALTITUDE: 0 to 40°C

NOTE • When the interior portion has become overheated, for safety purposes, the projector is automatically shut down, and the indicator lamps may also be turned off. In such a case, disconnect the power cord, and wait at least 45 minutes. After the projector has sufficiently cooled down, please make confirmation of the attachment state of the lamp and lamp cover, and then turn the power on again.

For the **SECURITY** indicator, see SECURITY INDICATOR in the SECURITY menu (📖 106).

For the **SHUTTER** indicator, see the section "Temporarily shading the screen" (📖 51).

The **FILTER** indicator shows the condition of the air filter. Utilize this feature to keep the interior of the projector in good condition.

FILTER indicator	Description
Turned off	The air filter is clean. No need to clean up.
Lighting In Orange	The air filter is going to be choked. It is recommended to clean it. In addition, please see the section "There is a possibility that the interior portion has become heated" (📖 115, 116).
Lighting In Red	The air filter is choked. It is required to turn the power off and clean the air filter immediately. In addition, please see the section "There is a possibility that the interior portion has become heated" (📖 115, 116).

NOTE • The **FILTER** indicator might light up in orange or red when something blocks the intake vents even though the air filter is clean.
• The **FILTER** indicator might light up differently from other indicators or display messages related to cleaning the air filter. Follow the prompt that is displayed earlier.

Resetting all settings

When it is hard to correct some wrong settings, the FACTORY RESET function of SERVICE item in OPTION menu (📖 99) can reset all settings (except settings such as LANGUAGE, LAMP TIME, FILTER HOURS, FILTER MESSAGE, STANDBY MODE, COMMUNICATION, SECURITY and NETWORK) to the factory default.

Troubleshooting

If an abnormal operation should occur, stop using the projector immediately.

⚠ WARNING ▶ Never use the projector if abnormal operations such as smoke, strange odor, excessive sound, damaged casing or elements or cables, penetration of liquids or foreign matter, etc. should occur. In such cases, immediately disconnect the power plug from the power outlet. After making sure that the smoke or odor has stopped, contact to your dealer or service company.

Otherwise if a problem occurs with the projector, the following checks and measures are recommended before requesting repair.



If this does not resolve the problem, please contact your dealer or service company. They will tell you what warranty condition is applied.





Warnings displayed on the Status Monitor



If an error occurs, a warning will be displayed on the Status Monitor ( *User's manual - Operating guide*). Resolve the errors referring to the table of the sections "**Related messages**" and "**Regarding the indicator lamps**" when the warning is displayed.

Related messages

When some message appears, check and cope with it according to the following table. Although these messages will be automatically disappeared around several minutes, it will be reappeared every time the power is turned on.

Message	Description
	<p>There is no input signal. Please confirm the signal input connection, and the status of the signal source.</p>
	<p>Projector is waiting for an image file. Check the hardware connection, settings on the projector and network-related settings.</p>
	<p>The computer-Projector network connection might be disconnected. Please re-connect them.</p>

Message	Description
	<p>The horizontal or vertical frequency of the input signal is not within the specified range. Please confirm the specs for your projector or the signal source specs.</p>
	<p>An improper signal is input. Please confirm the specs for your projector or the signal source specs.</p>
	<p>The internal temperature is rising. Please turn the power off, and allow the projector to cool down at least 20 minutes. After having confirmed the following items, please turn the power ON again.</p> <ul style="list-style-type: none"> • Is there blockage of the air passage aperture? • Is the air filter dirty? • Please use the unit within the temperature range; NORMAL MODE: 0 to 45 °C ECO MODE: 0 to 50 °C HIGH ALTITUDE : 0 to 40 °C (User's Manual (concise)). • Is the setting for ALTITUDE appropriate? • Is the exhaust air (hot/cold) from peripheral equipments blowing against the ventilation opening of projector? <p>For details of ALTITUDE, refer to ALTITUDE of SERVICE in the OPTION menu (User's Manual - Operating guide). If the projector is used with a wrong setting, it may cause damage to the projector itself or the parts inside.</p>
	<p>The installed lens is incompatible. Optical performance will decrease.</p> <ul style="list-style-type: none"> •The LENS TYPE is set to AUTO (OPTION > SERVICE > LENS TYPE), and the lens SD-903W is used at XGA model or SD-903X is used at WX/WUX/HD model which are not compatible. •The LENS TYPE may not be properly set. Check and set for appropriate LENS TYPE.

Message	Description
	<p>A note of precaution when cleaning the air filter. Please immediately turn the power off, and clean or change the air filter referring to the Cleaning and replacing the air filter section of this manual. After you have cleaned or changed the air filter, please be sure to reset the filter hours (User's Manual - Operating guide).</p>
	<p>The button operation is not available. Check the button you are going to use (User's Manual - Operating guide). Even when a usable button is pressed, all button operations are not available under the following conditions.</p> <ul style="list-style-type: none"> - While the lens is moving, button operation from the control panel or the remote control might be ignored. - Pressing the one of buttons to call a signal input might be ignored, when all the input ports belonging to the category the button's name shows are set to the "SKIP" by the item SOURCE SKIP of the OPTION menu.
	<p>The humidity around the projector exceeds the operating humidity range. Please turn the power off.</p> <ul style="list-style-type: none"> - Set up the projector in a location with a humidity of 0% to 80% (no condensation). <p>If the same indication is displayed after the remedy, please contact your dealer or service company.</p>

Phenomena that may be easy to be mistaken for machine defects

About the phenomenon confused with a machine defect, check and cope with it according to the following table.

Phenomenon	Cases not involving a machine defect
Power does not come on.	<p>The electrical power cord is not plugged in. Connect the power cord correctly.</p>
	<p>The main power source has been interrupted during operation such as by a power outage (blackout), etc. Please disconnect the power plug from the power outlet, and allow the projector to cool down at least 10 minutes, then turn the power on again.</p>
	<p>Either there is no lamp and/or lamp cover, or either of these has not been properly fixed. Please turn the power off and disconnect the power plug from the power outlet, and allow the projector to cool down at least 45 minutes. After the projector has sufficiently cooled down, please make confirmation of the attachment state of the lamp and lamp cover, and then turn the power on again.</p>
Pictures are not displayed	<p>Signal source does not correctly work. Set up the signal source device correctly by referring to the manual of the source device.</p>
	<p>The input changeover settings are mismatched. Select the input signal, and correct the settings.</p>

Phenomenon	Cases not involving a machine defect
<p>Pictures are not displayed. (continued)</p>	<p>The signal cables are not correctly connected. Correctly connect the connection cables.</p>
	<p>The brightness is adjusted to an extremely low level. Adjust BRIGHTNESS to a higher level using the menu function.</p>
	<p>The computer cannot detect the projector as a plug and play monitor. Make sure that the computer can detect a plug and play monitor using another plug and play monitor.</p>
	<p>The shutter is closed. Check whether the SHUTTER indicator is blinking. If it is blinking, press SHUTTER button on the control panel.</p>
<p>The remote control does not work.</p>	<p>Batteries in the remote control may be drained. Replace the batteries.</p>
	<p>The ID numbers set in the projector and the remote control are different. Press the ID button with the same ID number as the projector, then perform the desired operation. The ID number set in the projector can be displayed by pressing any of the ID buttons on the remote control for 3 seconds while the lamp is on.</p>
<p>Buttons does not work</p>	<p>OSD MESSAGE is set to HIDE. Press the OSD button on the remote control for 3sec. The HIDE OSD will be displayed. While this OSD is displayed, press the OSD button again on the remote control. Select ON.</p>
<p>Video screen display freezes.</p>	<p>The FREEZE function is working. Press FREEZE button to restore the screen to normal.</p>
<p>Colors have a faded- out appearance, or color tone is poor.</p>	<p>Color settings are not correctly adjusted. Perform picture adjustments by changing the COLOR TEMP, COLOR and/or TINT settings, using the menu functions.</p>
	<p>COLOR SPACE setting is not suitable. Change the COLOR SPACE setting to AUTO, RGB, SMPTE240, REC709 or REC601.</p>

Phenomenon	Cases not involving a machine defect
Pictures appear dark.	<p>The brightness and/or contrast are adjusted to an extremely low level. Adjust BRIGHTNESS and/or CONTRAST settings to a higher level using the menu function.</p>
	<p>The projector is operating in Eco mode. Set ECO MODE to NORMAL in the SETUP menu.</p>
	<p>The lamp is approaching the end of its product lifetime. Replace the lamp.</p>
	<p>Only one lamp is running. Check the LAMP MODE.</p>
	<p>The ambient temperature and humidity of the projector is too high. The projector will operate in ECO mode as the ambient temperature exceeds 45°C and humidity exceeds 80%.</p>
	<p>RICH COLOR mode is selected in COLOR WHEEL. Try to switch the COLOR WHEEL to BRIGHT mode.</p> <p>High humidity environment The brightness may decrease automatically, if the projector is used at high humidity environment. •Please use the unit within the humidity range. 0 to 80% (no condensation)</p>
Pictures appear blurry.	<p>Either the focus and/or horizontal phase settings are not properly adjusted. Adjust the focus using the FOCUS + / - buttons, and/or H PHASE using the menu function.</p>
	<p>The lens is dirty or misty. Clean the lens referring to the Optional Lens User's Manual.</p>

Phenomenon	Cases not involving a machine defect
<p>Some kind of image degradation such as flickering or stripes appear on screen.</p>	<p>Flicker may appear on screen Switch the lamp ON and OFF or try to switch the Lamp mode once from NORMAL to ECO.</p>
	<p>The OVER SCAN ratio is too big. Adjust OVER SCAN in the SIZE AND POSITION menu smaller.</p>
	<p>Excessive NOISE REDUCTION. Change the setting of NOISE REDUCTION in the INPUT menu.</p>
	<p>The FRAME LOCK function cannot work on the current input signal. Set FRAME LOCK in the INPUT menu to OFF.</p>
<p>The image is unstable or is output intermittently.</p>	<p>When LAN, HDBaseT port is selected, some parts of the output may be missing due to signal processing delay. Change the signal or use another port.</p>
<p>RS-232C does not work.</p>	<p>The SAVING function is working. Select NORMAL for STANDBY MODE item in the SETUP menu.</p>
	<p>The COMMUNICATION TYPE for the CONTROL port is set to NETWORK BRIDGE. Select OFF for COMMUNICATION TYPE item in the OPTION - SERVICE - COMMUNICATION menu.</p>
<p>Network does not work</p>	<p>The SAVING function is working. Select NORMAL for STANDBY MODE item in the SETUP menu.</p>
	<p>The same network address is set for both wireless and wired LAN. Change the network address setting for wireless or wired LAN.</p>
	<p>Wrong settings on WIRED NETWORK Select the correct port for LAN connection at the WIRED NETWORK under NETWORK menu.</p>
<p>The IR and RS-232C does not work on HDBaseT connection</p>	<p>The SAVING function is working. Select NORMAL for STANDBY MODE item in the SETUP menu.</p>

Phenomenon	Cases not involving a machine defect
HDBaseT connection does not work	<p>The SAVING function is working. Select NORMAL for STANDBY MODE item in the SETUP menu.</p>
	<p>The connected equipment may not be supported by HDBaseT. Refer to User's manual(detailed) for connection.</p>
IR and LAN does not work via HDBaseT	<p>Check if the IR setting is OFF under HDBaseT. EASY MENU > ADVANCED MENU > OPTION > SERVICE > REMOTE RECEIV.</p>
	<p>Check if the LAN setting is HDBaseT. EASY MENU > ADVANCED MENU > NETWORK > WIRED NETWORK</p>
LAN does not work, if LAN is connected to the projector while having an input signal from HDBaseT	<p>Check if the LAN setting is HDBaseT. EASY MENU > ADVANCED MENU > NETWORK > WIRED NETWORK</p>
	<p>This projector is compatible with 100BASE-T only. Check the specification of the connected equipments.</p>
	<p>If the LAN cable is connected with the hub, try to change the connected port at the hub</p>
	<p>If the LAN cable is connected directly to the computer, try to connect to other computer</p>
No image is displayed via HDBaseT	<p>Check the LAN cable if it is CAT5e certified or higher.</p>
	<p>Try to change the LAN cable.</p>
	<p>If the LAN cable is connected with more than 3 extension connector, the transmission of 100 meters may fail. Check if the extension connector is compatible with CAT5e. All LAN cable and extension connector connected with HDBaseT port must be CAT5e certified.</p>
No image is displayed via SDI (DHD951 only)	<p>Check if it is connected with a cable of 5CFB or greater, or Belden 1694A or greater.</p>
	<p>Check if a cable with a length of 100m or less is used.</p>
	<p>Try to change the cable.</p>
	<p>Check if a supported signal format is input.</p>

Phenomenon	Cases not involving a machine defect
<p>NETWORK BRIDGE function does not work</p>	<p>The NETWORK BRIDGE function is turned off. Select NETWORK BRIDGE for COMMUNICATION TYPE item in the OPTION - SERVICE - COMMUNICATION menu.</p>
<p>Schedule function does not work</p>	<p>The SAVING function is working. Select NORMAL for STANDBY MODE item in the SETUP menu.</p> <p>The internal clock has been reset. Once you turn off the projector in the SAVING mode or the AC power, the current date and time setting is reset. Check the DATE AND TIME setting for WIRELESS SETUP or WIRED SETUP in the NETWORK menu.</p>
<p>When the projector is connected to the network, it powers off and on as described below.</p> <p>Powers off ←</p> <p>↓</p> <p>POWER indicator blinks in orange a few times</p> <p>↓</p> <p>Goes into standby mode</p>	<p>Disconnect the LAN cable and check that the projector is working properly.</p> <p>If this phenomenon occurs after connecting to the network, there may be a loop between two Ethernet switching hubs within the network, as explained below.</p> <ul style="list-style-type: none"> - There are two or more Ethernet switching hubs in a network. - Two of the hubs are doubly connected by LAN cables. - This double connection forms a loop between the two hubs. <p>Such a loop may have an adverse effect on the projector as well as the other network devices.</p> <p>Check the network connection and remove the loop by disconnecting the LAN cables such that there is only one connecting cable between two hubs.</p>

Specifications

Please see the **Specifications** in the **User's Manual (concise)** which is a book.

End User License Agreement for the Projector Software

- Software in the projector consists of the plural number of independent software modules and there exist our copyright or/and third party copyrights for each of such software modules.
- Be sure to read “End User License Agreement for the Projector Software” which is separated document.

Corporate offices

USA – Cypress
ph: 714-236-8610
Canada – Kitchener
ph: 519-744-8005

Consultant offices

Italy
ph: +39 (0) 2 9902 1161

Worldwide offices

Australia
ph: +61 (0) 7 3624 4888
Brazil
ph: +55 (11) 2548 4753

China (Beijing)
ph: +86 10 6561 0240

China (Shanghai)
ph: +86 21 6278 7708

Eastern Europe and
Russian Federation
ph: +36 (0) 1 47 48 100

France
ph: +33 (0) 1 41 21 44 04

Germany
ph: +49 2161 664540

India
ph: +91 (080) 6708 9999

Japan
ph: 81-3-3509-7481

Korea (Seoul)
ph: +82 2 702 1601

Republic of South Africa
ph: +27 (0)11 510 0094

Singapore
ph: +65 6877-8737

Spain
ph: + 34 91 633 9990

United Arab Emirates
ph: +971 4 3206688

United Kingdom
ph: +44 118 977 8000



For the most current technical documentation,
please visit www.christiedigital.com

CHRISTIE