

***myprojectorlamps.com***

**The most trusted, dependable name  
in projector lamp sales.**



<http://www.myprojectorlamps.com>



<http://www.myprojectorlamps.ca>



<http://www.myprojectorlamps.eu>

The following projector manual has not been modified or altered in any way.

**Canon**

# MULTIMEDIA PROJECTOR LV-7575 User's Manual



**PJLink™**





# TO THE OWNER

Before operating this projector, read this manual thoroughly and operate the projector properly.

This projector provides many convenient features and functions. Operating the projector properly enables you to manage those features and maintain it in better condition for a considerable time.

Improper operation may result in not only shortening the product life, but also malfunctions, fire hazard, or other accidents.

If your projector seems to operate improperly, read this manual again, check operations and cable connections and try the solutions in the "Troubleshooting" section in the end of this booklet. If the problem still persists, contact the dealer where you purchased the projector or the service center.

	<b>CAUTION</b> <b>RISK OF ELECTRIC SHOCK</b> <b>DO NOT OPEN</b>	
<b>CAUTION: TO REDUCE THE RISK OF ELECTRIC SHOCK, DO NOT REMOVE COVER (OR BACK). NO USER-SERVICEABLE PARTS INSIDE EXCEPT LAMP REPLACEMENT. REFER SERVICING TO QUALIFIED SERVICE PERSONNEL.</b>		
	THIS SYMBOL INDICATES THAT DANGEROUS VOLTAGE CONSTITUTING A RISK OF ELECTRIC SHOCK IS PRESENT WITHIN THIS UNIT.	
	THIS SYMBOL INDICATES THAT THERE ARE IMPORTANT OPERATING AND MAINTENANCE INSTRUCTIONS IN THE USER'S MANUAL WITH THIS UNIT.	

## CAUTION

Not for use in a computer room as defined in the Standard for the Protection of Electronic Computer/Data Processing Equipment, ANSI/NFPA 75.

Ne peut être utilisé dans une salle d'ordinateurs telle que définie dans la norme ANSI/NFPA 75 Standard for Protection of Electronic Computer/Data Processing Equipment.

### NOTE FOR CUSTOMERS IN THE US

 LAMP(S) INSIDE THIS PRODUCT CONTAIN MERCURY AND MUST BE RECYCLED OR DISPOSED OF ACCORDING TO LOCAL, STATE OR FEDERAL LAWS.



## Safety Precaution

**WARNING: TO REDUCE THE RISK OF FIRE OR ELECTRIC SHOCK, DO NOT EXPOSE THIS APPLIANCE TO RAIN OR MOISTURE.**

- This projector produces intense light from the projection lens. Do not stare directly into the lens as much as possible. Eye damage could result. Be especially careful that children do not stare directly into the beam.
- Install the projector in a proper position. If not, it may result in a fire hazard.
- Provide appropriate space on the top, sides and rear of the projector cabinet for allowing air circulation and cooling the projector. Minimum clearances must be maintained. If the projector is to be built into a compartment or similarly enclosed, the minimum distances must be maintained. Do not cover the ventilation slots on the projector. Heat build-up can reduce the service life of your projector, and can also be dangerous.

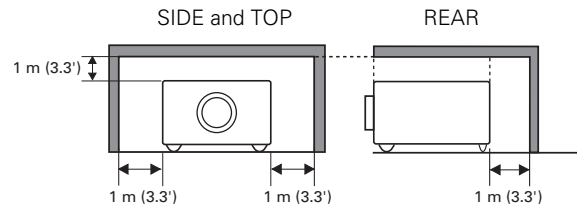

- If the projector is not to be used for an extended time, unplug the projector from the power outlet.



## CAUTION ON HANGING FROM THE CEILING

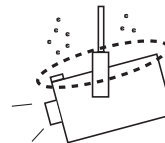

When hanging the projector from the ceiling, clean the air intake vents, air filters, and top of the projector periodically with a vacuum cleaner. If you leave the projector unclean for a long time, the dust will block the operation of the cooling function, and it may cause a breakdown or a disaster.

**DO NOT SET THE PROJECTOR IN GREASY, WET, OR SMOKY CONDITIONS SUCH AS IN A KITCHEN TO PREVENT A BREAKDOWN OR A DISASTER. IF THE PROJECTOR COMES IN CONTACT WITH OIL OR CHEMICALS, IT MAY BECOME DETERIORATED.**

**READ AND KEEP THIS USER'S MANUAL FOR LATER USE.**

# SAFETY INSTRUCTIONS

All the safety and operating instructions should be read before the product is operated.

Read all of the instructions given here and retain them for later use. Unplug this projector from AC power supply before cleaning. Do not use liquid or aerosol cleaners. Use a damp cloth for cleaning.

Follow all warnings and instructions marked on the projector.

For added protection to the projector during a lightning storm, or when it is left unattended and unused for long periods of time, unplug it from the wall outlet. This will prevent damage due to lightning and power line surges.

---

Do not expose this unit to rain or use near water... for example, in a wet basement, near a swimming pool, etc...

Do not use attachments not recommended by the manufacturer as they may cause hazards.

Do not place this projector on an unstable cart, stand, or table. The projector may fall, causing serious injury to a child or adult, and serious damage to the projector. Use only with a cart or stand recommended by the manufacturer, or sold with the projector. Wall or shelf mounting should follow the manufacturer's instructions, and should use a mounting kit approved by the manufacturers.

An appliance and cart combination should be moved with care. Quick stops, excessive force, and uneven surfaces may cause the appliance and cart combination to overturn.



---

Slots and openings in the back and bottom of the cabinet are provided for ventilation, to insure reliable operation of the equipment and to protect it from overheating.

The openings should never be covered with cloth or other materials, and the bottom opening should not be blocked by placing the projector on a bed, sofa, rug, or other similar surface. This projector should never be placed near or over a radiator or heat register.

This projector should not be placed in a built-in installation such as a book case unless proper ventilation is provided.

Never push objects of any kind into this projector through cabinet slots as they may touch dangerous voltage points or short out parts that could result in a fire or electric shock. Never spill liquid of any kind on the projector.

Do not install the projector near the ventilation duct of air-conditioning equipment.

This projector should be operated only from the type of power source indicated on the marking label. If you are not sure of the type of power supplied, consult your authorized dealer or local power company.

Do not overload wall outlets and extension cords as this can result in fire or electric shock. Do not allow anything to rest on the power cord. Do not locate this projector where the cord may be damaged by persons walking on it.

Do not attempt to service this projector yourself as opening or removing covers may expose you to dangerous voltage or other hazards. Refer all servicing to qualified service personnel.

Unplug this projector from wall outlet and refer servicing to qualified service personnel under the following conditions:

- a. When the power cord or plug is damaged or frayed.
- b. If liquid has been spilled into the projector.
- c. If the projector has been exposed to rain or water.
- d. If the projector does not operate normally by following the operating instructions. Adjust only those controls that are covered by the operating instructions as improper adjustment of other controls may result in damage and will often require extensive work by a qualified technician to restore the projector to normal operation.
- e. If the projector has been dropped or the cabinet has been damaged.
- f. When the projector exhibits a distinct change in performance-this indicates a need for service.

When replacement parts are required, be sure the service technician has used replacement parts specified by the manufacturer that have the same characteristics as the original part. Unauthorized substitutions may result in fire, electric shock, or injury to persons.

Upon completion of any service or repairs to this projector, ask the service technician to perform routine safety checks to determine that the projector is in safe operating condition.

# COMPLIANCE

## **Federal Communication Commission Notice**

Multimedia Projector, Model: LV-7575

This device complies with Part 15 of the FCC Rules. Operation is subject to the following two conditions:

- (1) This device may not cause harmful interference, and
- (2) this device must accept any interference received, including interference that may cause undesired operation.

Note: This equipment has been tested and found to comply with the limits for a Class B digital device, pursuant to Part 15 of the FCC Rules. These limits are designed to provide reasonable protection against harmful interference in a residential installation. This equipment generates, uses and can radiate radio frequency energy and, if not installed and used in accordance with the instructions, may cause harmful interference to radio communications. However, there is no guarantee that interference will not occur in a particular installation. If this equipment does cause harmful interference to radio or television reception, which can be determined by turning the equipment off and on, the user is encouraged to try to correct the interference by one or more of the following measures:

- Reorient or relocate the receiving antenna.
- Increase the separation between the equipment and receiver.
- Connect the equipment into an outlet on a circuit different from that to which the receiver is connected.
- Consult the dealer or an experienced radio/TV technician for help.

Use of shielded cable is required to comply with class B limits in Subpart B of Part of FCC Rules.

Do not make any changes or modifications to the equipment unless otherwise specified in the instructions. If such changes or modifications should be made, you could be required to stop operation of the equipment.

Canon U.S.A., Inc.  
One Canon Plaza, Lake Success, NY 11042-1198, U.S.A.  
Tel No. (516)328-5000

## **Canadian Radio Interference Regulations**

This Class B digital apparatus meets all requirements of the Canadian Interference-Causing Equipment Regulations.

## **AC POWER CORD REQUIREMENT**

The AC Power Cord supplied with this projector meets the requirement for use in the country you purchased it.

### **AC Power Cord for the United States and Canada:**

AC Power Cord used in the United States and Canada is listed by the Underwriters Laboratories (UL) and certified by the Canadian Standard Association (CSA).

AC Power Cord has a grounding-type AC line plug. This is a safety feature to be sure that the plug will fit into the power outlet. Do not try to defeat this safety feature. Should you be unable to insert the plug into the outlet, contact your electrician.

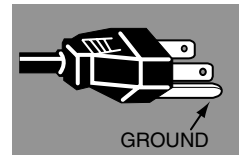

**THE SOCKET-OUTLET SHOULD BE INSTALLED NEAR THE EQUIPMENT AND EASILY ACCESSIBLE.**



### **European Union (and EEA) only.**

This symbol indicates that this product is not to be disposed of with your household waste, according to the WEEE Directive (2002/96/EC) and your national law. This product should be handed over to a designated collection point, e.g., on an authorized one-for-one basis when you buy a new similar product or to an authorized collection site for recycling waste electrical and electronic equipment (EEE). Improper handling of this type of waste could have a possible negative impact on the environment and human health due to potentially hazardous substances that are generally associated with EEE. At the same time, your cooperation in the correct disposal of this product will contribute to the effective usage of natural resources. For more information about where you can drop off your waste equipment for recycling, please contact your local city office, waste authority, approved WEEE scheme or your household waste disposal service. Your cooperation in the correct disposal of this product will contribute to the effective usage of natural resources and will avoid incurring administrative sanctions according to art. 50 and following of Italian legislative decree 22/97. For more information regarding return and recycling of WEEE products, please visit [www.canon-europe.com/environment](http://www.canon-europe.com/environment).

(EEA: Norway, Iceland and Liechtenstein)

# TABLE OF CONTENTS

## FEATURES AND DESIGN 6

## PREPARATION 7

NAME OF EACH PART OF PROJECTOR	7
SETTING-UP PROJECTOR	8
CONNECTING AC POWER CORD	8
POSITIONING PROJECTOR	9
ADJUSTABLE FEET	10
INSTALLING PROJECTOR IN PROPER POSITION	10
MOVING PROJECTOR	11

## CONNECTING PROJECTOR 12

TERMINALS OF PROJECTOR	12
CONNECTING TO COMPUTERS	13
CONNECTING TO VIDEO EQUIPMENT	14

## BEFORE OPERATION 15

REMOTE CONTROL OPERATION	15
LASER POINTER FUNCTION	15
REMOTE CONTROL BATTERIES INSTALLATION	16
TOP CONTROLS AND INDICATORS	17
ON-SCREEN MENU	18
HOW TO OPERATE ON-SCREEN MENU	18
FLOW OF ON-SCREEN MENU OPERATION	18
MENU BAR	19

## BASIC OPERATION 20

TURNING ON/OFF PROJECTOR	20
TURNING ON THE PROJECTOR	20
TURNING OFF THE PROJECTOR	21
ADJUSTING SCREEN	22
ZOOM ADJUSTMENT	22
FOCUS ADJUSTMENT	22
LENS SHIFT ADJUSTMENT	22
KEYSTONE CORRECTION	22
PICTURE FREEZE FUNCTION	23
NO SHOW FUNCTION	23
P-TIMER FUNCTION	23
SOUND ADJUSTMENT	23

## COMPUTER INPUT 24

SELECTING INPUT SOURCE	24
SELECTING COMPUTER SYSTEM	25
PC ADJUSTMENT	26
AUTO PC ADJUSTMENT	26
MANUAL PC ADJUSTMENT	27
PICTURE IMAGE SELECT	29
IMAGE LEVEL SELECT	29
PICTURE SCREEN ADJUSTMENT	30
PICTURE SCREEN SELECT	30

## VIDEO INPUT 31

SELECTING INPUT SOURCE	31
SELECTING VIDEO SYSTEM	32
PICTURE IMAGE SELECT	33
IMAGE LEVEL SELECT	33
PICTURE SCREEN ADJUSTMENT	34
PICTURE SCREEN SELECT	34

## PICTURE IMAGE 35

PICTURE IMAGE ADJUSTMENTS	35
---------------------------	----

## SETTING 38

SETTING MENU	38
--------------	----

## APPENDIX 45

WIRELESS MOUSE	45
MAINTENANCE	46
WARNING TEMP. INDICATOR	46
AIR FILTERS CARE AND CLEANING	47
CLEANING PROJECTION LENS	47
LAMP REPLACEMENT	48
LAMP REPLACE COUNTER	49
TROUBLESHOOTING	50
MENU TREE	52
COMPATIBLE COMPUTER SPECIFICATIONS	55
INDICATORS AND PROJECTOR CONDITION	56
TECHNICAL SPECIFICATIONS	58
CONFIGURATIONS OF TERMINALS	59
OPTIONAL PARTS	60
LENS REPLACEMENT	60
PJ LINK NOTICE	60
DIMENSIONS	61

### TRADEMARKS

- Apple, Macintosh, and PowerBook are trademarks or registered trademarks of Apple Computer, Inc.
- IBM and PS/2 are trademarks or registered trademarks of International Business Machines, Inc.
- Windows and PowerPoint are registered trademarks of Microsoft Corporation.
- Each name of corporations or products in the user's manual is a trademark or a registered trademark of its respective corporation.

# FEATURES AND DESIGN

This Multimedia Projector is designed with most advanced technology for portability, durability, and ease of use. This projector utilizes built-in multimedia features, a palette of 1.07 billion colors, and matrix liquid crystal display (LCD) technology.

## ◆ Compact Design

---

This projector is extremely compact in size and weight. It is designed to carry and work anywhere you wish to use.

## ◆ Compatibility

---

This projector accepts various video and computer input signals such as:

- Computers  
IBM-compatible or Macintosh computer up to 1600 x 1200 resolution.
- 6 Color Systems  
NTSC, PAL, SECAM, NTSC 4.43, PAL-M, or PAL-N color system can be connected.
- Component Video  
Component video signal, such as a DVD player output high definition TV signals including 480i, 480p, 575i, 575p, 720p, 1035i, or 1080i, can be connected.
- S-Video  
S-Video signal, such as a S-VHS VCR output signal, can be connected.

## ◆ High Resolution Image

---

This projector provides 1024 x 768 dots resolution for computer input and 800 horizontal TV lines. Resolution from a computer with more than XGA (1024 x 768) is compressed into 1024 x 768 dots. This projector cannot display an image of over 1920 x 1080 dots. When resolution of your computer is over 1920 x 1080, lower the resolution for a computer output.

## ◆ Multi-Scan System

---

This projector has the Multi-Scan System to conform to almost all computer output signals quickly. There is no need for a troublesome manual adjustment of frequency and other settings.

## ◆ One-Touch Auto PC Adjustment

---

Incoming computer video signals are recognized and the best adjustment is automatically set by the Auto PC Adjustment function. No complicated setup is necessary and the projection is always precise.

## ◆ Motor-driven Lens Shift

---

Projection lens can be moved up and down with the motor-driven lens shift function. This function makes it easy to provide projected image where you want. Zoom and focus can also be adjusted with a motor-driven operation.

## ◆ Digital Zoom (for Computer)

---

Digital Zoom function adjusts image size to approx. 1/4 ~ 49 times of an original image size, allowing you to focus on a crucial information at the presentation.

## ◆ Keystone Correction

---

Keystone correction function is provided to correct distortion of the projected image allowing you to use the projector without locational constraints.

## ◆ Power Management

---

Power management function is provided to reduce power consumption when the projector is not in use. The Power management function turns the projection lamp off when the projector detects a signal interruption or when no button is pressed for a certain period. The projection lamp is automatically turned on again when the projector detects a signal or any operation button is pressed.

This projector is shipped with this function "ON."

## ◆ Digital Visual Interface

---

This projector is equipped with the DVI 24-pin terminal for connecting DVI output from a computer.

## ◆ Laser Pointer Function

---

The supplied Remote Control Unit has the Laser Pointer function. This function helps you to make a smart presentation on a projected screen.

## ◆ Wireless Mouse

---

The supplied Remote Control Unit has the Wireless Mouse function for a connected computer. This function enables you to operate both projector and computer with the remote control unit only.

## ◆ Multilanguage Menu Display

---

Operation menu is available in 12 languages: English, German, French, Italian, Spanish, Portuguese, Dutch, Swedish, Russian, Chinese, Korean, or Japanese.

## ◆ Network Imager (Optional)

---

Equipped with the Network Imager, the projector can display the image of the computer screen and the image data stored in the computer via a network. The projector can also be controlled and maintained through a web browser.

# PREPARATION

## NAME OF EACH PART OF PROJECTOR

### FRONT OF CABINET



### CAUTION

Do not turn on the projector with the lens cap attached. High temperature from light beam may damage the lens cap and result in fire hazard.

LENS CAP

PROJECTION LENS

SPEAKERS

TOP CONTROLS AND INDICATORS

**Kensington Security Slot**  
This slot is for a Kensington lock used to deter theft of the projector. For more information, visit <http://www.kensington.com>.

\*Kensington is a registered trademark of ACCO Brands Corporation.

AIR INTAKE VENT

INFRARED REMOTE RECEIVER

### BACK OF CABINET

EXHAUST VENT



### HOT AIR EXHAUSTED !

Air blown from the exhaust vent is hot. When using or installing the projector, the following precautions should be taken.

- Do not put a flammable object near this vent.
- Keep the rear grills at least 1 m (3.3') away from any object, especially from heat-sensitive objects.
- Do not touch this area, especially screws and metallic parts. This area will become hot when the projector is in use.

This projector detects internal temperature and automatically controls operating power of the cooling fans.

POWER CORD CONNECTOR

TERMINALS AND CONNECTORS

INFRARED REMOTE RECEIVER

LAMP COVER

CARRYING HANDLE

When attaching the Network Imager (optional) to the projector, remove the these parts. Refer to the user's manual of the optional Network Imager.

### BOTTOM OF CABINET

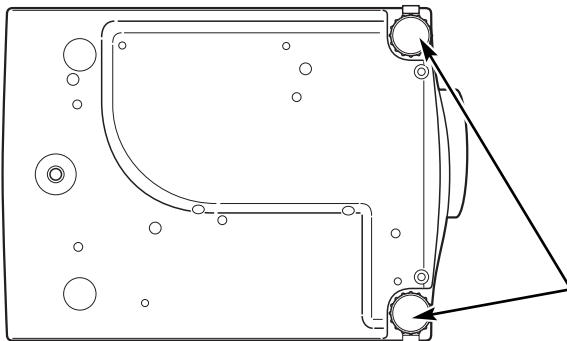

AIR INTAKE VENTS

This projector is equipped with cooling fans for protecting from overheating. Pay attention to the following matters to ensure proper ventilation and avoid a possible risk of fire and malfunction.

- Do not cover the vent slots.
- Keep this side clear of any objects. Obstructions may block cooling the air.

ADJUSTABLE FEET AND FEET LOCK LATCHES



# SETTING-UP PROJECTOR

## CONNECTING AC POWER CORD

This projector uses nominal input voltages of 100–120 V or 200–240 V AC and it automatically selects correct input voltage. It is designed to work with single-phase power systems having a grounded neutral conductor. To reduce risk of electrical shock, do not plug into any other type of power system.

If you are not sure of the type of power being supplied, consult your authorized dealer or service station.

Connect the projector with all peripheral equipment before turning it on. (See pages 12–14 for connection.)

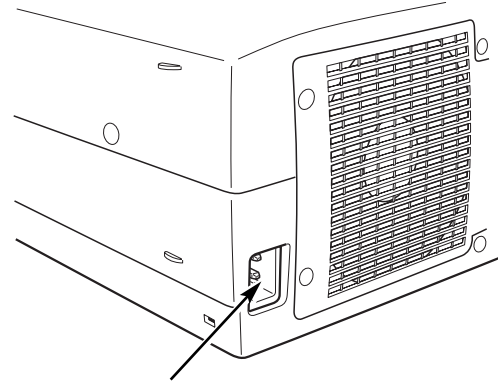

Connect AC power cord (supplied) to the projector.  
The AC outlet must be near this equipment and must be easily accessible.



### CAUTION

For safety, unplug the AC power cord when the projector is not in use. When the projector is connected to an outlet with AC power cord, an appliance is in stand-by mode and consumes a little electric power.

### NOTE ON POWER CORD

AC power cord must meet the requirements of the country where you use the projector. Confirm the AC plug type with the chart below and a proper AC power cord must be used. If the supplied AC power cord does not match your AC outlet, contact your sales dealer.

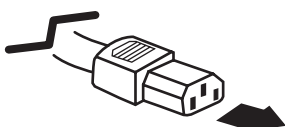
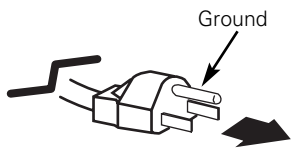
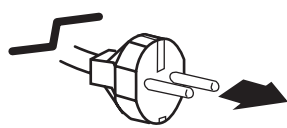
Projector side	AC Outlet side	
 <p data-bbox="341 1522 560 1596">To POWER CORD CONNECTOR on your projector.</p>	<p data-bbox="665 1323 966 1354"><b>For the U.S.A. and Canada</b></p>  <p data-bbox="771 1543 950 1596">To the AC Outlet. <b>(120 V AC)</b></p>	<p data-bbox="1047 1323 1339 1354"><b>For Continental Europe</b></p>  <p data-bbox="1136 1543 1323 1596">To the AC Outlet. <b>(200–240 V AC)</b></p>

## POSITIONING PROJECTOR

- This projector is designed to project on a flat projection surface.
- Projector can be focused from 1.4 m (4.6')–14.7 m (48.2').
- Refer to the figure below to adjust the screen size.

### A ROOM LIGHT

Brightness in a room has a great influence on the picture quality. It is recommended to limit ambient lighting in order to provide the best image.

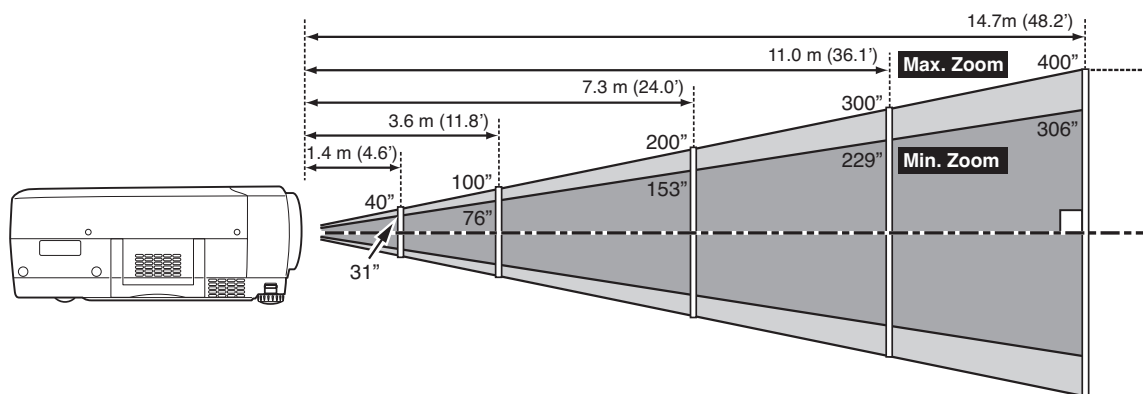

Screen Size	Max. Zoom	40"	100"	150"	200"	250"	300"	400"
	Min. Zoom	31"	76"	114"	153"	190"	229"	306"
Distance		1.4 m (4.6')	3.6 m (11.8')	5.4 m (17.7')	7.3 m (24.0')	9.1 m (29.9')	11.0 m (36.1')	14.7 m (48.2')

### LENS SHIFT ADJUSTMENT

Projection lens can be moved up and down with the motor-driven Lens shift function. This function makes it easy to provide projected image where you want. The U/D ratio can be adjusted 10:0–1:1 (see Figure below). See page 22 for operation.

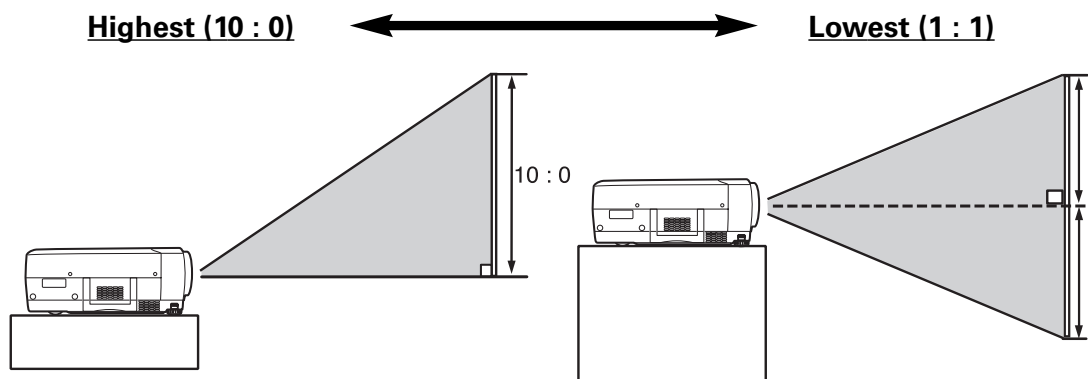

# PREPARATION

## ADJUSTABLE FEET

Projection angle can be adjusted up to 10.5 degrees with the ADJUSTABLE FEET.

- 1** Lift the front of the projector and pull the FEET LOCK LATCHES in each side of the projector.
- 2** Release the FEET LOCK LATCHES to lock the ADJUSTABLE FEET and rotate the ADJUSTABLE FEET to a proper height, and tilt.
- 3** To retract the ADJUSTABLE FEET, lift the front of the projector and pull and undo the FEET LOCK LATCHES.

Keystone distortion of the projected image can be corrected by the Menu Operation. (See pages 22, 38.)

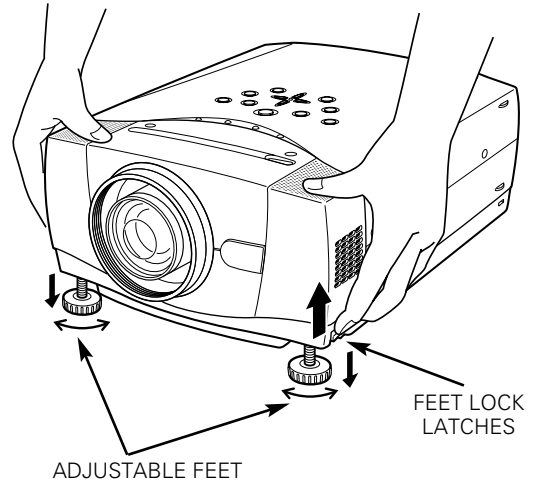

## INSTALLING PROJECTOR IN PROPER POSITION

Install the projector properly. Improper installation may reduce the lamp life and cause a fire hazard.

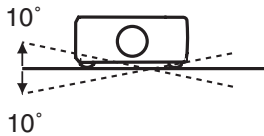

Do not tilt the projector more than 10 degrees from side to side.



**NO SIDWAYS**

Do not put the projector on either side to project an image.

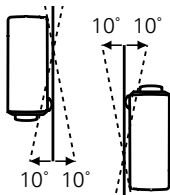

When projecting vertically (up or down), keep the projector's tilt within 10 degrees. Tilting more than 10 degrees in either direction may affect the projector life.

## MOVING PROJECTOR

Use the Carrying Handle when moving the projector.

Replace the lens cap and retract the ADJUSTABLE FEET when moving the projector to prevent damages to the lens and cabinet.

When this projector is not in use for an extended period, put it into a suitable case (not supplied with this projector).

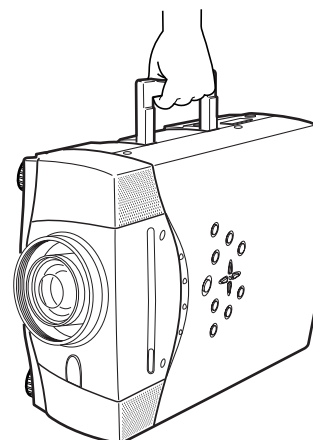

### CAUTION IN CARRYING OR TRANSPORTING A PROJECTOR

- Do not drop or bump the projector, otherwise damages or malfunctions may result.
- When carrying the projector, use a suitable carrying case.
- Do not transport the projector by courier or any other transport service in an unsuitable transport case. This may cause damage to the projector. To transport the projector by courier or any other transport service, consult your dealer for the best way.

# CONNECTING PROJECTOR

## TERMINALS OF PROJECTOR

This projector has input and output terminals on its back for connecting computers and video equipment. Refer to the figures on pages 12–14 and connect properly.

### COMPUTER AUDIO INPUT 1/ AUDIO MONITOR OUTPUT JACK

This terminal is switchable and can be used as Computer Audio Input 1 or Audio Monitor Output (variable). Set up the terminal as either Computer Audio Input 1 or Audio Monitor Output properly before using this terminal. (See pages 13, 24.)

Note: This terminal does not output audio from INPUT 3.

### COMPUTER INPUT/MONITOR OUTPUT TERMINAL (ANALOG)

This terminal is switchable and can be used as Computer Input or Monitor Output. Set up the terminal as either Computer Input or Monitor Output properly before using this terminal. (See pages 13–14, 24.)

Note: This terminal outputs from the 5 BNC type computer input on INPUT 2 jacks only.

### COMPUTER INPUT TERMINAL (DIGITAL)

Connect a computer output (Digital DVI-D type) to this terminal. The HD (HDCP Compatible) signal can also be connected. (See page 13.)

### COMPUTER AUDIO INPUT 2 JACK

Connect an audio output (stereo) from a computer to this jack. (See page 13.)

### USB CONNECTOR (Series B)

When controlling a computer with the remote control unit of this projector, connect USB terminal of your personal computer to this terminal. (See page 13.)

### RESET BUTTON

This projector uses a micro processor to control the unit, and only occasionally, this micro processor may malfunction and need to be reset. This can be done by pressing the RESET button with a pen, which will shut down and restart the unit. Do not use the RESET function excessively.

### 5 BNC INPUT JACKS

Connect component video output (Y, Cb, Cr or Y, Pb, Pr) from video equipment to VIDEO/Y, Cb/Pb, and Cr/Pr jacks or connect computer output {5 BNC Type (Green, Blue, Red, Horiz. Sync, and Vert. Sync.)} from computer to G, B, R, H/V, and V jacks. (See pages 13–14.)

### VIDEO INPUT JACKS

Connect composite video output from video equipment to VIDEO/Y jack or connect component video outputs to VIDEO/Y, Cb/Pb, and Cr/Pr jacks. (See page 14.)

### AUDIO INPUT JACKS

Connect an audio output from video equipment to these jacks. (See page 14.)

### S-VIDEO INPUT JACK

Connect S-VIDEO output from video equipment to this jack. (See page 14.)

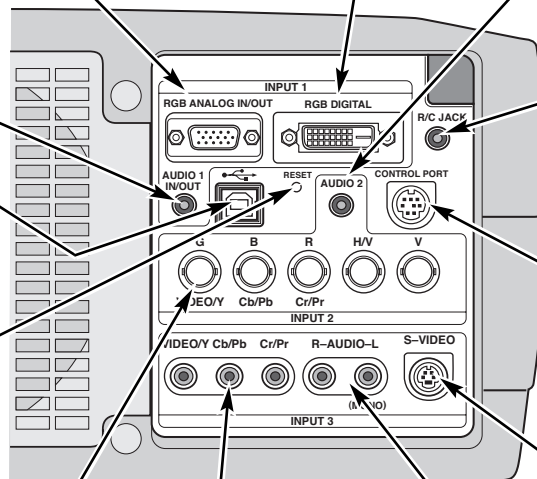

### R/C JACK

When using the Wired/Wireless remote control unit as wired, connect the Wired remote control unit to this jack with an Audio cable (Mini Plug [stereo]; not supplied).

### CONTROL PORT CONNECTOR

When controlling a computer with the remote control unit of this projector, connect the mouse port of your personal computer to this connector. (See page 13.)

# CONNECTING TO COMPUTERS

**Cables used for connection** (\* = Cables or adapters not supplied with this projector.)

- VGA Cable (HDB 15 pin)
- DVI-Digital Cable (for Single Link T.M.D.S.) \*
- BNC Cable \*
- Control Cable for Serial Port
- Control Cable for PS/2 Port \*
- Control Cable for ADB Port \*
- USB Cable
- Audio Cables (Mini Plug [stereo] x 2) \*

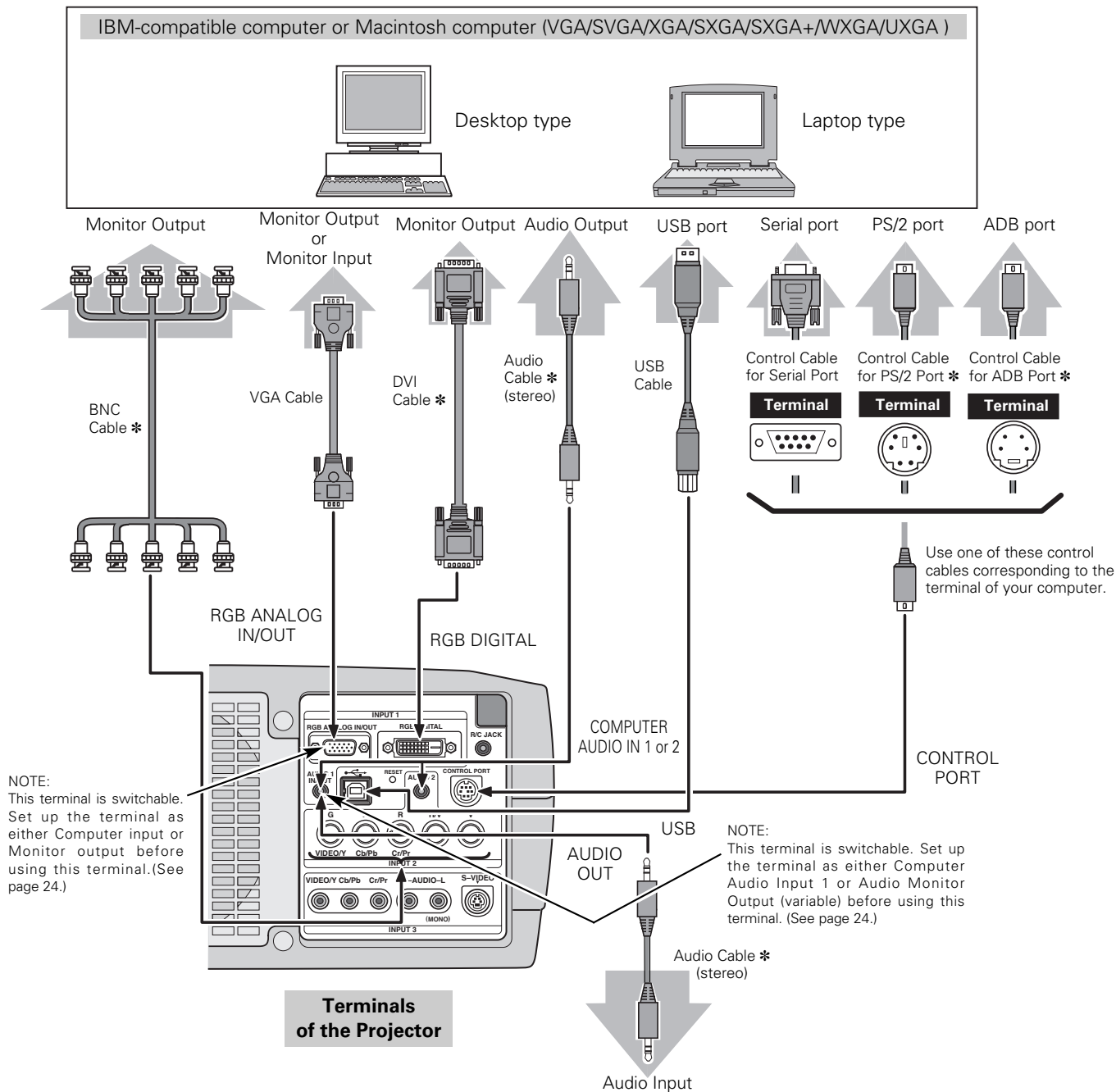

**NOTE:**  
This terminal is switchable. Set up the terminal as either Computer input or Monitor output before using this terminal. (See page 24.)

**NOTE:**  
This terminal is switchable. Set up the terminal as either Computer Audio Input 1 or Audio Monitor Output (variable) before using this terminal. (See page 24.)

**NOTE:**  
 Unplug the power cords of both the projector and external equipment from the AC outlet before connecting cables. Turn a projector and peripheral equipment on before computer is switched on.

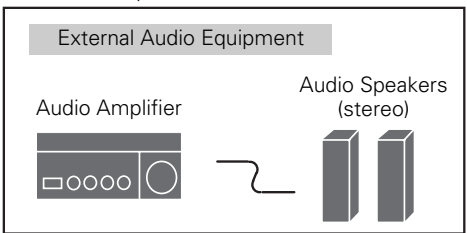

## CONNECTING TO VIDEO EQUIPMENT

**Cables used for connection** (\* = Cables not supplied with this projector.)

- Video Cable (RCA x 1 or RCA x 3) \*
- BNC Cable \*
- S-VIDEO Cable \*
- Audio Cable (RCA x 2) \*
- Audio Cable (Mini Plug [stereo]) \*
- Scart Cable \*

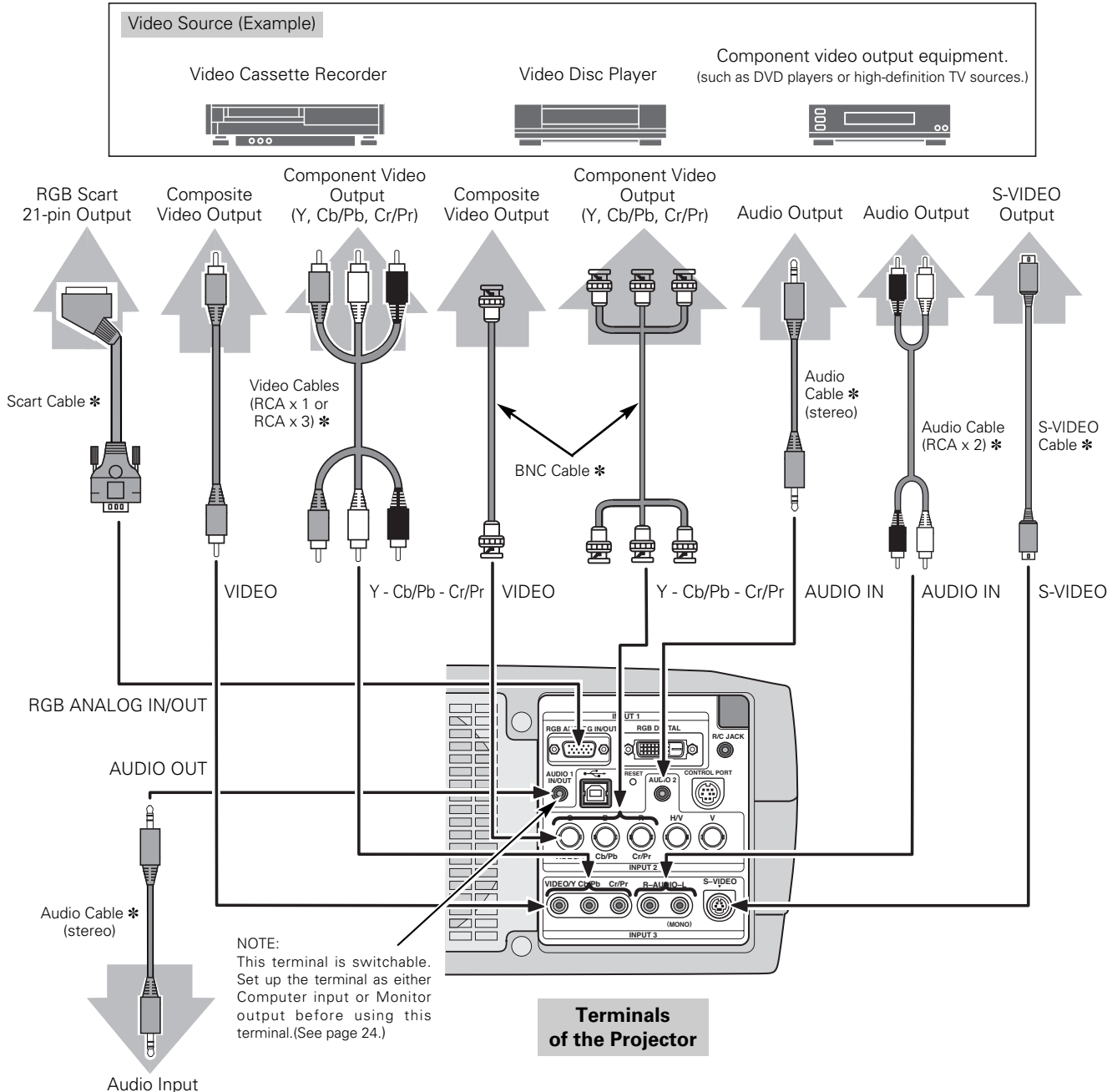

**NOTE:**  

 Unplug the power cords of both the projector and external equipment from the AC outlet before connecting cables.

# BEFORE OPERATION

## REMOTE CONTROL OPERATION

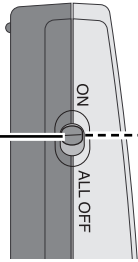
### Left Side



#### ALL OFF SWITCH

When using the remote control unit, turn this switch to "ON." And turn it to "ALL OFF" when it is not in use.

#### INSIDE THE BATTERY COMPARTMENT BOX

This remote control unit provides the DIP switches into the battery compartment box. Slide the SW4 (LASER ON/OFF switch) to the "OFF" position. The Laser Pointer function is not operated. Set the Switches 1-3 as shown in table below depending on the Code No. that you want to select as the remote control code. (See page 41.)

DIP SWITCH SETTING			
SW4 ..... LASER ON/OFF			
SW1	SW2	SW3	Code No.
ON	ON	ON	Code 1
ON	ON	OFF	Code 2
ON	OFF	ON	Code 3
ON	OFF	OFF	Code 4
OFF	ON	ON	Code 5
OFF	ON	OFF	Code 6
OFF	OFF	ON	Code 7
OFF	OFF	OFF	Code 8

#### LASER POINTER (DRAG ON) INDICATOR

Lights red while the laser beam is emitted from the Laser Light Window. Lights green when dragged to the "ON" position. (p.45)

#### MUTE BUTTON

Used to mute the sound. (p.23)

#### DRAG ON/OFF BUTTON

Used to select the DRAG ON/OFF position. (p.45)

#### LEFT CLICK BUTTON

Used as a PC mouse in Wireless Mouse Operation. Press this button and the mouse pointer button to drag the selected screen object. (p.45)

#### LASER BUTTON

Used to operate the Laser Pointer function. The laser beam is emitted when pressing this button for one minute. When using the Laser Pointer for more than one minute, release this button and press it again.

#### FOCUS BUTTON

Used to adjust focus. (p.22)

#### POWER BUTTON

Used to turn the projector on or off. (pp.20-21)

#### AUTO PC ADJ. BUTTON

Use to operate the AUTO PC Adjustment function. (p.26)

#### IMAGE BUTTON

Used to select the image level. (pp.29, 33)

#### KEystone BUTTON

Used to correct keystone distortion. (pp.22, 38)

#### MOUSE POINTER

Used as a PC mouse in Wireless Mouse Operation. (p.45)

#### RIGHT CLICK BUTTON

Used as a PC mouse in Wireless Mouse Operation. (p.45)

#### LENS SHIFT BUTTON

Used to select the Lens Shift function. (p.22)

#### WIRED REMOTE JACK

When using as a Wired remote control unit, connect an Audio cable (Mini Plug [stereo]; not supplied) to this jack. Battery installation is required when using as a Wired remote control unit.

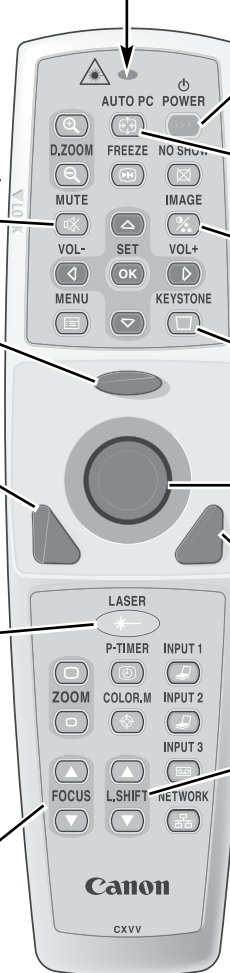

## LASER POINTER FUNCTION

This remote control unit emits laser beam from the Laser Light Window when used as a Laser Pointer. When the LASER button is pressed, the laser light goes on. When the LASER button is being pressed for more than one minute or it is released, the light goes off. The LASER POINTER INDICATOR lights RED and LASER is emitted with RED light to indicate the laser beam is being emitted.

The Laser emitted is the Cass II laser. Do not look into the Laser Light Window or shine laser beam onto yourself or other people. The three marks shown below are caution labels for the laser beam.

**CAUTION:** Use of controls, adjustments, or performance of procedures other than those specified herein may result in hazardous radiation exposure.

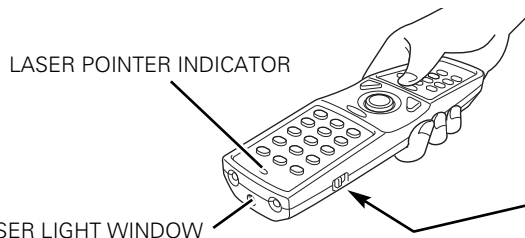

These caution labels are put on the remote control unit.

<b>CAUTION</b>	<b>LASER RADIATION</b>
LASER RADIATION- DO NOT STARE INTO BEAM	DO NOT STARE INTO BEAM CLASS 2 LASER PRODUCT
MAX OUTPUT : 1mW WAVE LENGTH : 650±20nm CLASS II LASER PRODUCT	LASER-STRAHLUNG NICHT IN DEN STRAHL BLICKEN LASER-KLASSE 2 レーザー放射 クラス2 レーザ製品 ビームをのぞき込まないこと IEC60825-1, Am.1 1997, Am.2 2001 MAX OUTPUT (最大出力) : 1mW WAVE LENGTH (波長) : 650±20nm
This product is complied with 21 CFR part 1040.10	



AVOID EXPOSURE-LASER  
RADIATION IS EMITTED  
FROM THIS APERTURE  
レーザー光の出口  
ビームをのぞき込まないこと



# BEFORE OPERATION

## D.ZOOM BUTTON

Used to select the DIGITAL ZOOM +/- mode and resize the image. (p.30)

## OK BUTTON

Used to execute the selected item, or expand/compress the image in the DIGITAL ZOOM +/- mode. (p.30)

## MENU BUTTON

Used to select the MENU Operation. (pp.18-19)

## P-TIMER BUTTON

Used to operate the P-TIMER function. (p.23)

## ZOOM BUTTON

Used to adjust zoom. (p.22)

## COLOR MANAGEMENT BUTTON

Used to operate the Color management function. (pp.35-36)



## NO SHOW BUTTON

Used to turn the picture into a black image. (p.23)

## FREEZE BUTTON

Used to freeze the picture. (p.23)

## POINT (VOLUME +/-) BUTTONS

Used to select an item or adjust a value in On-Screen Menu. They are also used to pan the image in the DIGITAL ZOOM +/- mode. (p.30)  
The POINT LEFT/RIGHT buttons are also used as VOLUME +/- buttons. (p.23)

## INPUT 1 BUTTON

Used to select an input source (INPUT 1). (p.24)

## INPUT 2 BUTTON

Used to select an input source (INPUT 2). (pp.25, 31)

## INPUT 3 BUTTON

Used to select an input source (INPUT 3). (p.31)

## NETWORK BUTTON

Used to select a network input (optional).

## Operating Range

Point the remote control unit toward the projector (a Receiver Window) when pressing any button. Maximum operating range for the remote control unit is about 5 m (16.4') and 60° in front and rear of the projector.

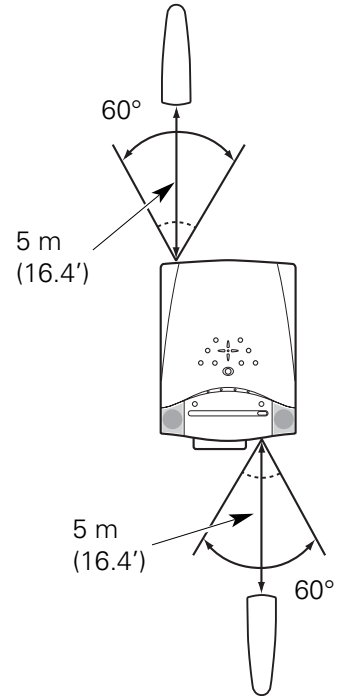

## REMOTE CONTROL BATTERIES INSTALLATION

- 1 Open the battery compartment lid.

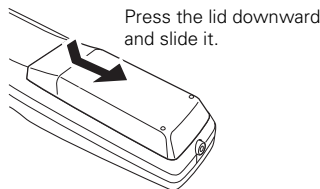

- 2 Install new batteries into the compartment.

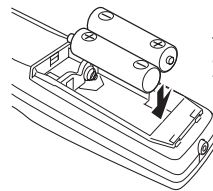

**Two AA size batteries**  
For correct polarity (+ and -), be sure battery terminals are in contact with pins in the compartment.

- 3 Replace the compartment lid.

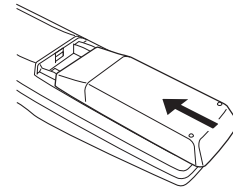

To insure safe operation, please observe following precautions:

- Use two (2) AA or LR6 type alkaline batteries.
- Always replace batteries in sets.
- Do not use a new battery with an used battery.
- Avoid contact with water or liquid.
- Do not expose the remote control unit to moisture, or heat.
- Do not drop the remote control unit.
- If a battery has leaked on the remote control unit, carefully wipe the case clean and install new batteries.
- Danger of explosion if battery is incorrectly replaced.
- Dispose of used batteries according to batteries manufacturers instructions and local rules.

# TOP CONTROLS AND INDICATORS

This projector has CONTROL BUTTONS (TOP CONTROLS) and INDICATORS on its top.

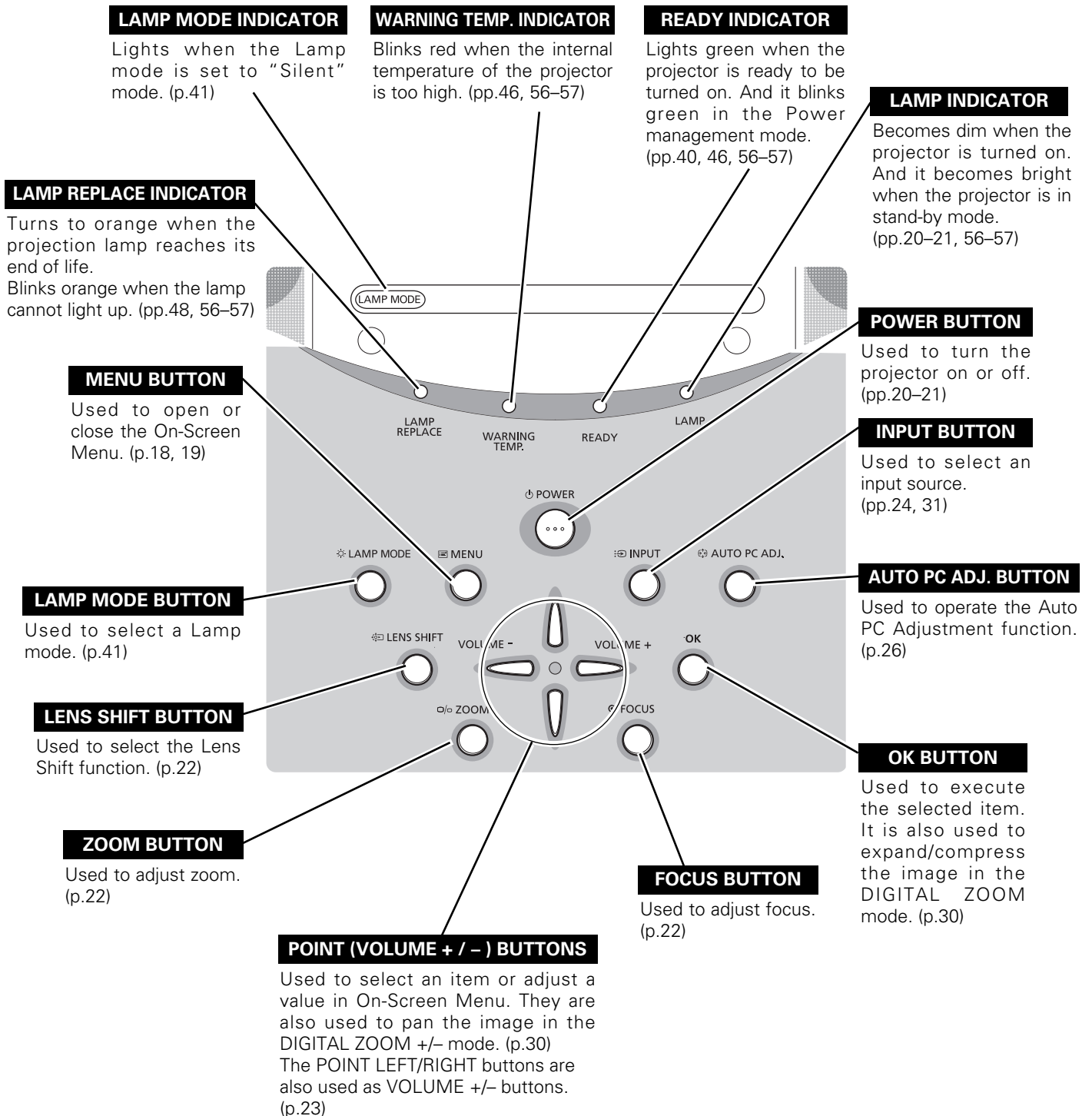

# ON-SCREEN MENU

## HOW TO OPERATE ON-SCREEN MENU

You can control and adjust this projector with On-Screen Menu. Refer to the relevant pages to operate each adjustment.

### 1. DISPLAY MENU

Press the MENU button to display the On-Screen Menu.

### 2. MOVING POINTER

Move the pointer (\* see below) or adjust a value of an item by pressing the POINT buttons on the top control or on the remote control unit.

\* The Pointer is an icon in the On-Screen Menu for selecting an item. See figures in "FLOW OF ON-SCREEN MENU OPERATION" below.

### 3. SELECT ITEM

Select an item or set the selected function by pressing the OK button.

#### REMOTE CONTROL UNIT

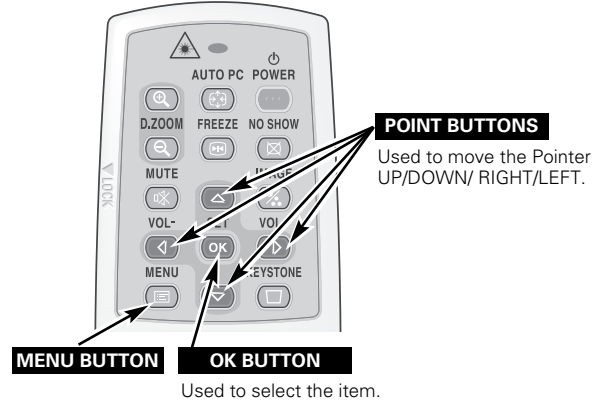

#### TOP CONTROL

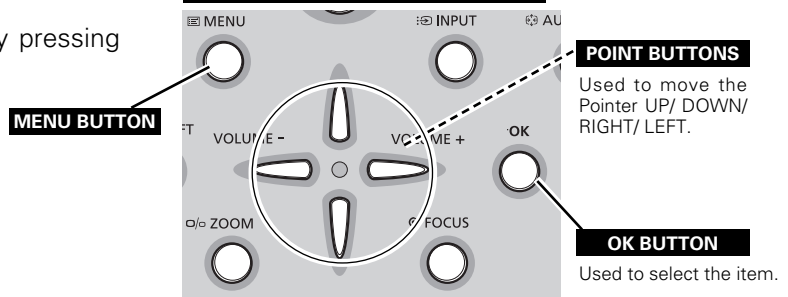

## FLOW OF ON-SCREEN MENU OPERATION

### Display ON-SCREEN MENU

1 Press the MENU button to display the On-Screen Menu (a MENU BAR). A red frame is a POINTER.

### Select Menu to be adjusted

2 Move the POINTER (red frame) to a MENU ICON that you want to select by pressing the POINT RIGHT/LEFT buttons.

### Control or adjust items through ON-SCREEN MENU

3 Press the POINT UP/DOWN buttons and move the POINTER (red frame or red arrow) to an ITEM that you want to adjust, and then press the OK button to show the ITEM DATA.

4 Adjust the ITEM DATA by pressing the POINT RIGHT/LEFT buttons. Refer to the relevant pages for details of respective adjustments.

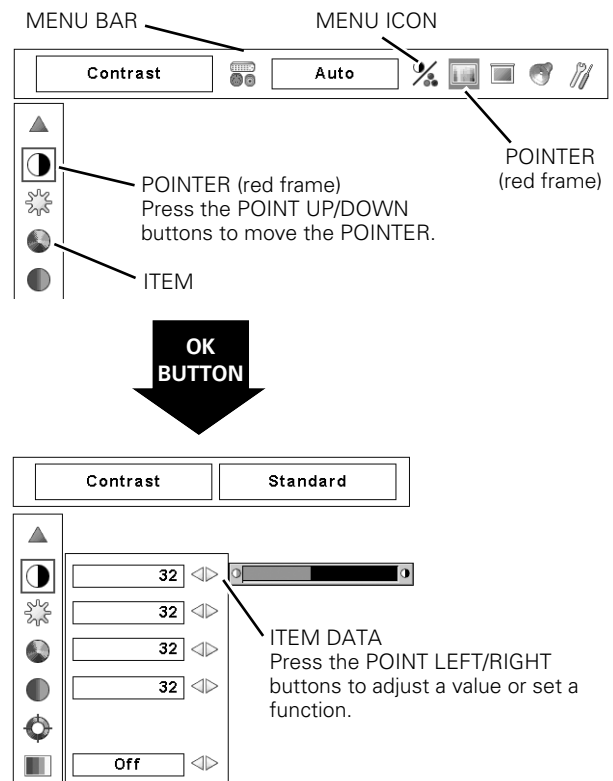

**MENU BAR**

**FOR PC SOURCE**

Press the MENU button when connecting to the PC input source.

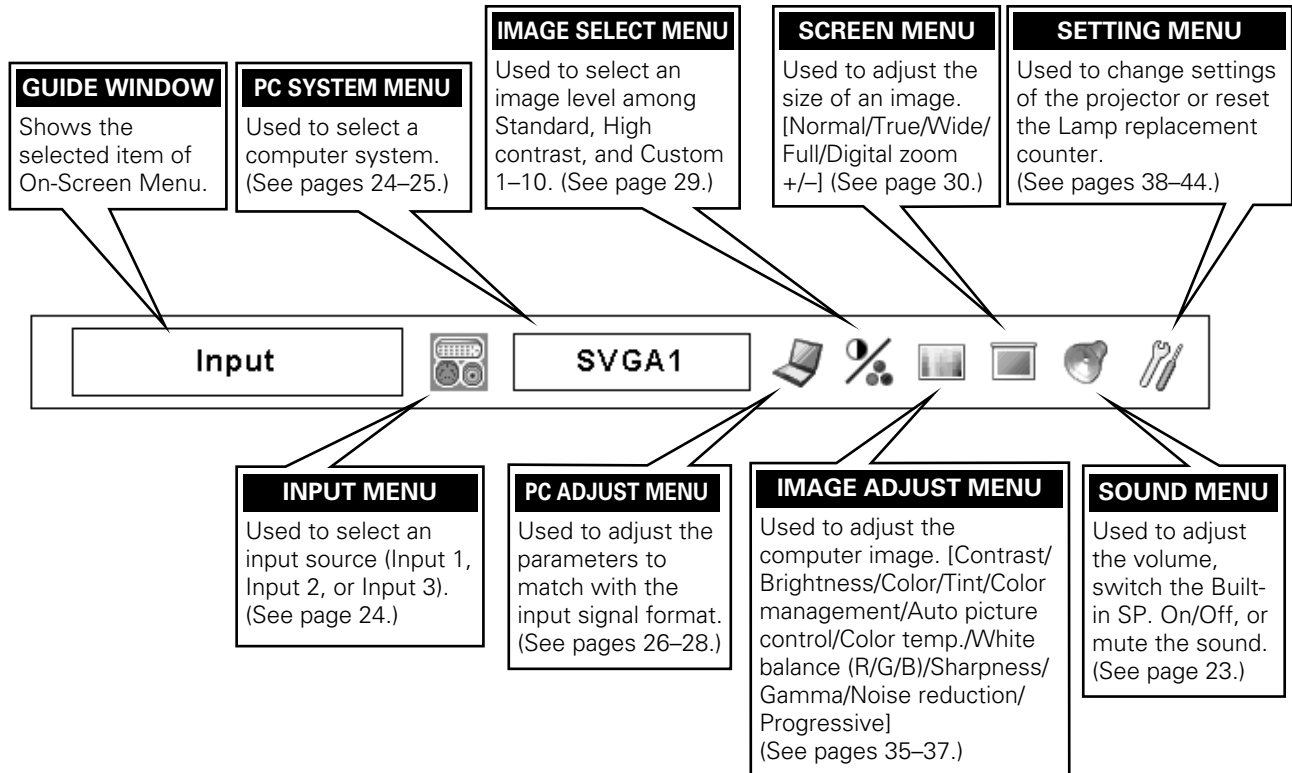

**FOR VIDEO SOURCE**

Press the MENU button when connecting to the VIDEO input source.

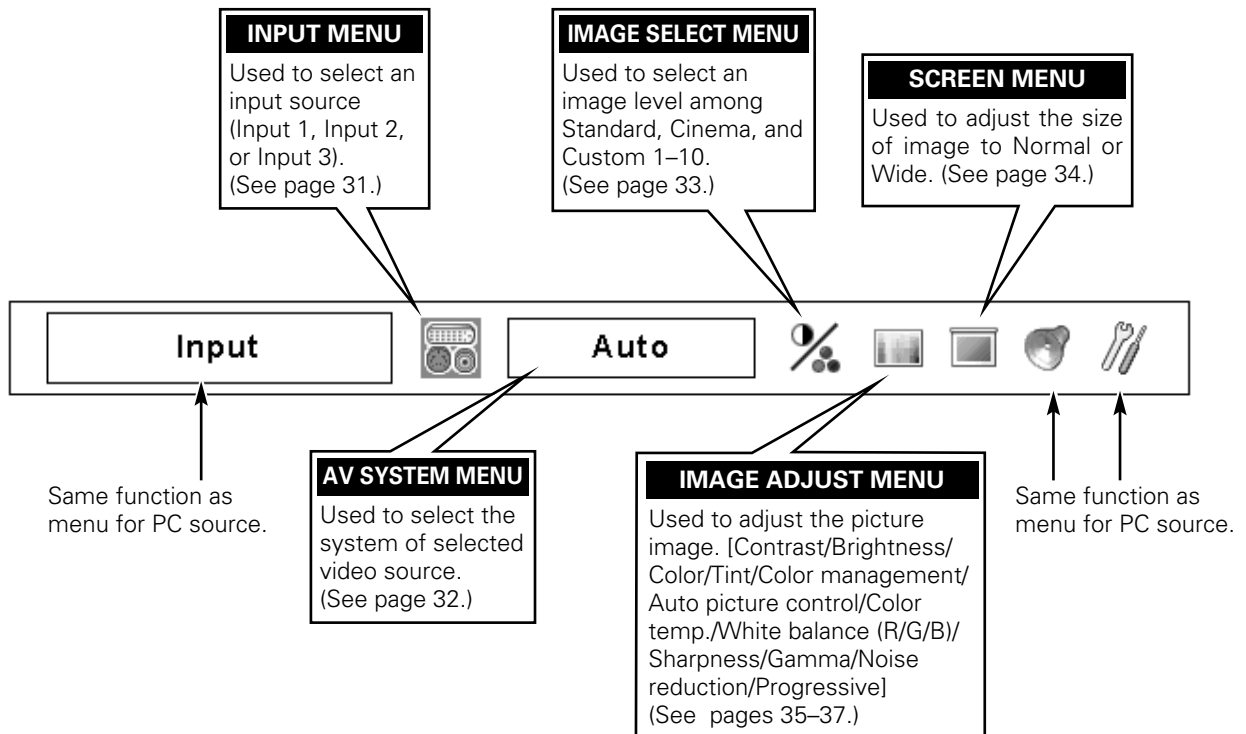

## TURNING ON / OFF PROJECTOR

### TURNING ON THE PROJECTOR

- 1 Complete peripheral connections (with a computer, VCR, etc.) before turning on the projector.
- 2 Connect the projector's AC power cord into an AC outlet. The LAMP indicator lights RED, and the READY indicator lights GREEN.
- 3 Press the POWER button on the top control or on the remote control unit. The LAMP indicator dims, and the cooling fans start to operate. The preparation display appears on the screen and the countdown starts.
- 4 After the countdown, the input source that was selected the last time and the Lamp mode status icon (see page 41) appear on the screen.

If the projector is locked with a PIN code, a PIN code Input Dialog Box appears. Enter the PIN code as instructed below.

#### To Enter a PIN code

Select a number by pressing the POINT LEFT/RIGHT button and fix the number with the OK button. The number changes to "\*." If you fixed a wrong number, move the pointer to "Set" or "Clear" once by pressing the POINT DOWN button, then return to "PIN code." Enter the correct number.

Repeat this step to complete entering a four-digit number.

When the four-digit number is fixed, the pointer automatically moves to "Set." Press the OK button so that you can start to operate the projector.

If you entered a wrong PIN code, "PIN code" and the number (\*\*\*\*) turn red and disappear. Enter a PIN code all over again.

#### What is PIN code?

PIN (Personal Identification Number) code is a security code that allows the person who knows it to operate the projector. Setting a PIN code prevents unauthorized use of the projector.

A PIN code consists of a four-digit number. Refer to the PIN code lock function in the SETTING Menu on page 43 for locking operation of the projector with your PIN code.

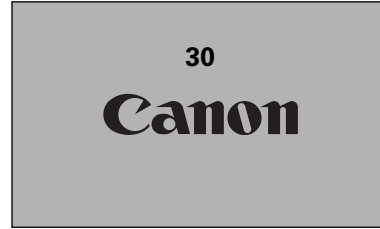

The preparation display disappears after 30 seconds.

#### Selected Input Source and Lamp mode

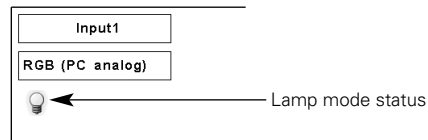

#### PIN code Input Dialog Box

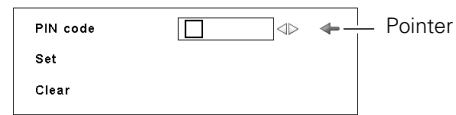

ok After the OK icon disappears, you can operate the projector.

## TURNING OFF THE PROJECTOR

- 1** Press the POWER button on the top control or on the remote control unit, and "Power off?" appears on the screen.
- 2** Press the POWER button again to turn off the projector. The LAMP indicator lights bright and the READY indicator turns off. After the projector is turned off, the cooling fans operate (for 90 seconds). During this "cooling down" period, the projector cannot be turned on.
- 3** When the projector has cooled down, the READY indicator lights GREEN again and you can turn projector on. After cooling down completely, unplug the AC power cord.

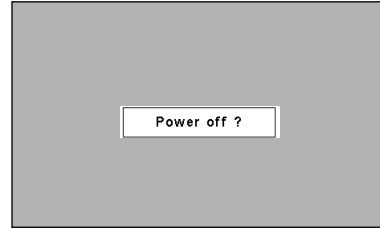

"Power off?" disappears after 4 seconds.



TO MAINTAIN THE LIFE OF LAMP, ONCE YOU TURN THE PROJECTOR ON, WAIT AT LEAST FIVE MINUTES BEFORE TURNING IT OFF. DO NOT UNPLUG THE AC POWER CORD WHILE COOLING FANS ARE RUNNING OR BEFORE THE READY INDICATOR LIGHTS GREEN AGAIN. OTHERWISE IT WILL RESULT IN SHORTENING THE LAMP LIFE.

### NOTE:

- The projector cannot be turned on during the cooling period with the READY indicator turned off. You can turn it on again after the READY indicator becomes GREEN again.
- When the On start function is "On," this projector is turned on automatically by connecting the AC power cord to an AC outlet. (See page 41 for the On start function.)
- Continuous use may result in shortening the lamp life. Turn off the projector and rest it for about an hour in every 24 hours.
- The running speed of cooling fans is changed according to the temperature inside the projector.
- If the WARNING TEMP indicator blinks RED, see "WARNING TEMP INDICATOR" on page 46.

## ADJUSTING SCREEN

### ZOOM ADJUSTMENT

- 1** Press the ZOOM button on the top control or ZOOM ▲/▼ buttons on the remote control unit. "Zoom" appears on the screen.
- 2** Press the ZOOM ▲ button or POINT UP button to make the image larger, and press the ZOOM ▼ button or POINT DOWN button to make the image smaller.



"Zoom" disappears after 4 seconds.

### FOCUS ADJUSTMENT

- 1** Press the FOCUS button on the top control or FOCUS ▲/▼ buttons on the remote control unit. "Focus" appears on the screen.
- 2** Adjust the focus of image by pressing the FOCUS ▲/▼ buttons or POINT UP/DOWN buttons.

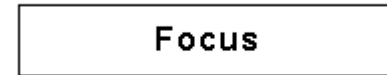

"Focus" disappears after 4 seconds.

**NOTE:**

- Focus adjustment may not function properly if the image is corrected by the Keystone function.

### LENS SHIFT ADJUSTMENT

- 1** Press the LENS SHIFT button on the top control or LENS SHIFT ▲/▼ buttons on the remote control unit. "Lens shift" appears on the screen.
- 2** Press the POINT UP button or LENS SHIFT ▲ button to move the image up, press the POINT DOWN or LENS SHIFT ▼ button to move the image down.

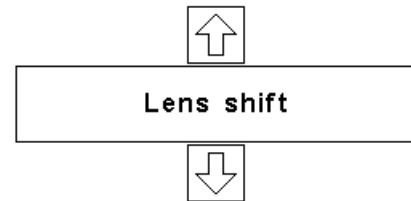

"Lens shift" disappears after 4 seconds.

### KEYSTONE CORRECTION

If a projected picture has keystone distortion, correct the image with the Keystone function.

- 1** Press the KEYSTONE button on the remote control unit or select Keystone in the SETTING Menu. (See page 38.) The Keystone dialog box appears.
- 2** Correct keystone distortion by pressing the POINT UP/DOWN/LEFT/RIGHT buttons. Press the POINT UP button to reduce the upper part of the image; press the POINT DOWN button to reduce the lower part. Press the POINT LEFT button to reduce the left part; press the POINT RIGHT button to reduce the right part.

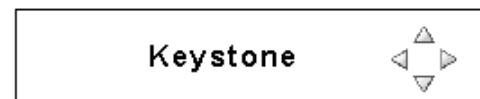

- Arrows are white when no correction.
- Arrow(s) in the corrected direction turn(s) red.
- Arrow(s) disappear(s) at the maximum correction.
- If you press the KEYSTONE button on the remote control unit once more while the Keystone dialog box is being displayed, the Keystone function is canceled.
- "Keystone" disappears after 10 seconds.

Reduce the upper width with POINT UP button.

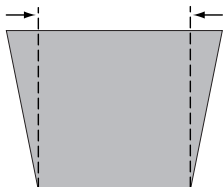

Reduce the lower width with POINT DOWN button.

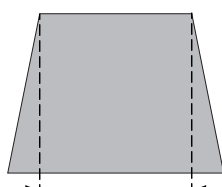

Reduce the left part with POINT LEFT button.

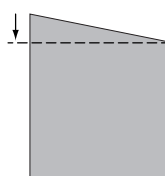

Reduce the right part with POINT RIGHT button.

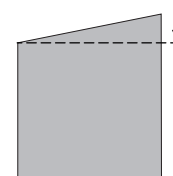

**PICTURE FREEZE FUNCTION**

Press the FREEZE button on the remote control unit to freeze the picture on the screen. To cancel the FREEZE function, press the FREEZE button again or press any other button.

**NO SHOW FUNCTION**

Press the NO SHOW button on the remote control unit to black out the image. To restore to normal, press the NO SHOW button again or press any other button.

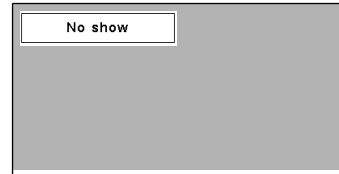

"No show" disappears after 4 seconds.

**P-TIMER FUNCTION**

Press the P-TIMER button on the remote control unit. A Timer display "00 : 00" appears on the screen and starts to count time (00 : 00–59 : 59).

To stop the P-TIMER, press the P-TIMER button. Press the P-TIMER button again to cancel the P-TIMER function.



**SOUND ADJUSTMENT**

**DIRECT OPERATION**

**Volume**

Press the VOLUME (+/-) buttons on the top control or on the remote control unit to adjust the volume. A Volume dialog box appears on the screen for a few seconds.

Press the VOLUME (+) button to increase the volume; press the VOLUME (-) button to decrease the volume.

**Mute**

Press the MUTE button on the remote control unit to turn off the sound. To restore the sound to its previous level, press the MUTE button again or press the VOLUME (+/-) buttons.

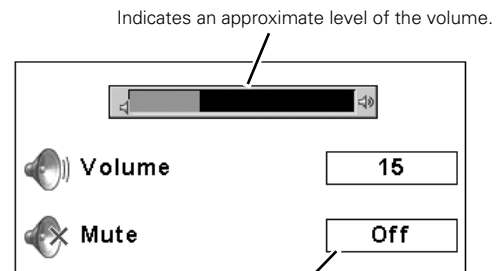

Press the MUTE button to set the Mute function On or Off.

The Volume dialog box disappears after 4 seconds.

**MENU OPERATION**

**1** Press the MENU button to display the On-Screen Menu. Press the POINT LEFT/RIGHT buttons to move the red frame pointer to the SOUND Menu icon.

**2** Press the POINT UP/DOWN buttons to move the red frame pointer to the desired item, and then press the OK button.



**Volume**

To increase the volume, press the POINT RIGHT button; to decrease the volume, press the POINT LEFT button.



**Built-in SP.**

Press the POINT LEFT/RIGHT buttons to switch the built-in speaker On or Off.



**Mute**

Press the POINT LEFT/RIGHT buttons to turn off the sound. The Dialog box display is changed to "On" and the sound is turned off. To restore the sound to its previous level, press the POINT LEFT/RIGHT buttons again.

**SOUND MENU**

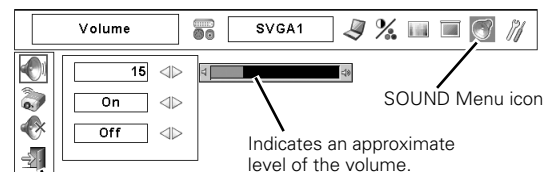

Closes the SOUND Menu



## SELECTING INPUT SOURCE

### DIRECT OPERATION

Select an INPUT source by pressing the INPUT button on the top control or the INPUT 1, INPUT 2, or INPUT 3 buttons on the remote control unit.

If the projector cannot reproduce proper image, select a correct input source with the MENU OPERATION (see below).

**NOTE:**

- Input 1 terminal is switchable and can be used as Computer Input or Monitor Output.

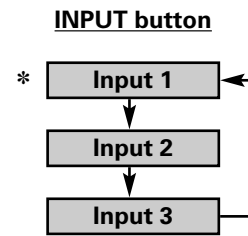

\*Input 1 is not displayed when the Input 1 is used as Monitor out.

### MENU OPERATION

#### WHEN SELECTING INPUT 1 (COMPUTER INPUT TERMINALS )

- 1 Press the MENU button to display the On-Screen Menu. Press the POINT LEFT/RIGHT buttons to move the red frame pointer to the INPUT Menu icon.
- 2 Press the POINT UP/DOWN buttons to move the red arrow pointer to Input 1 and then press the OK button. A Source Select Menu appears.
- 3 Move the pointer to a source that you want to select and then press the OK button.

#### INPUT MENU

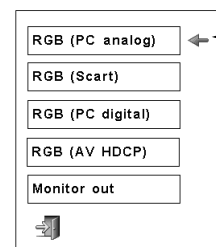
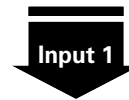
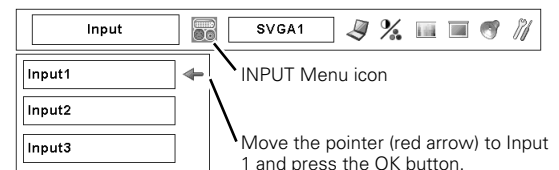

#### Source Select Menu

Move the pointer (red arrow) to a source and press the OK button.

#### RGB(PC analog)

When your computer is connected to the INPUT 1 (ANALOG) terminal, select RGB (PC analog).

#### RGB(Scart)

When scart video equipment is connected to the INPUT 1 (ANALOG) terminal, select RGB (Scart).

#### RGB(PC digital)

When your computer is connected to INPUT 1 (DIGITAL) terminal, select RGB (PC digital).

#### RGB(AV HDCP)

If a HDCP-compatible signal source is connected to the INPUT 1 (DIGITAL) terminal, select RGB (AV HDCP).

#### Monitor out

If the INPUT 1 ANALOG terminal is being used as a MONITOR OUT terminal, select Monitor out.

**NOTE:**

- INPUT SOURCE changes if the INPUT 1 button on the remote control unit is pressed.
- HDCP (High-bandwidth Digital Content Protection) is a system for protecting digital entertainment content which is delivered by DVI (Digital Visual Interface) from being copied. The specification of HDCP is decided and controlled by Digital Content Protection, LLC. Should the specification be changed, this projector may not display the digital content protected by HDCP.

## WHEN SELECTING INPUT 2 (5 BNC INPUT JACKS )

When connecting a computer output [5 BNC Type (Green, Blue, Red, Horiz. Sync, and Vert. Sync.)] from a computer to G, B, R, H/HV, and V jacks:

- 1** Press the MENU button to display the On-Screen Menu. Press the POINT LEFT/RIGHT buttons to move the red frame pointer to the INPUT Menu icon.
- 2** Press the POINT UP/DOWN buttons to move the red arrow pointer to Input 2 and then press OK button. A Source Select Menu appears.
- 3** Press the POINT UP/DOWN buttons and a red-arrow icon appears. Move the arrow to "RGB," and then press the OK button.

**NOTE:**

- INPUT SOURCE changes if the INPUT 2 button on the remote control unit is pressed.

### INPUT MENU

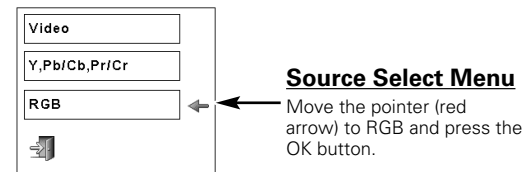
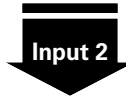
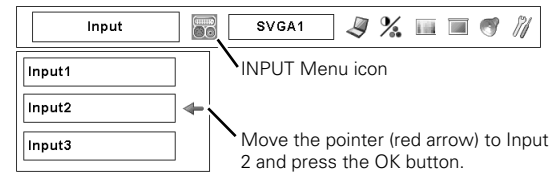

## SELECTING COMPUTER SYSTEM

### AUTOMATIC MULTI-SCAN SYSTEM

This projector automatically tunes to various types of computers based on VGA, SVGA, XGA, SXGA, SXGA+, WXGA, or UXGA (refer to "COMPATIBLE COMPUTER SPECIFICATIONS" on pages 55–56). When Computer is selected, this projector automatically detects the incoming signal and projects proper image without any additional setting. (Some computers need to be set manually.)

The projector displays one of these: Auto, —, Mode 1–10, or the system provided in the projector.

**Auto**

When the projector cannot recognize a connected signal as PC system provided in this projector, the Auto PC Adjustment function operates to adjust the projector and "Auto" is displayed on the SYSTEM Menu icon. When the image is not provided properly, a manual adjustment is required. (See pages 27–28.)

-----

There is no signal input from the computer. Make sure the connection of a computer and the projector is set correctly. (See "TROUBLESHOOTING" on page 50.)

**Mode 1**

The User preset adjustment in MANUAL PC ADJUSTMENT. The Adjusted data can be stored in the Mode 1–10.

**SVGA 1**

PC systems provided in this projector. The projector chooses proper system and displays it.

\* Mode 1 and SVGA 1 are examples.

### PC SYSTEM MENU

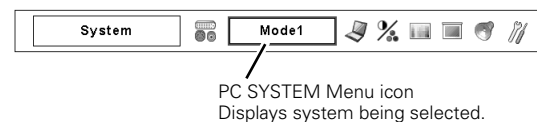

### SELECTING COMPUTER SYSTEM MANUALLY

This projector automatically selects PC system among those provided in this projector, however, PC system can be also selected manually.

- 1** Press the MENU button to display the On-Screen Menu. Press the POINT LEFT/RIGHT buttons to move the red frame pointer to the PC SYSTEM Menu icon.
- 2** Press the POINT UP/DOWN buttons to move the red arrow pointer to the desired system, and then press OK button.

### PC SYSTEM MENU

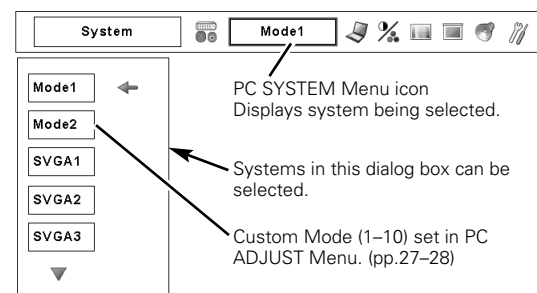

## PC ADJUSTMENT

### AUTO PC ADJUSTMENT

Auto PC Adjustment function is provided to automatically adjust Fine sync, Total dots, Horizontal and Vertical positions to conform to your computer. Auto PC Adjustment function can be operated as follows.



#### Auto PC adj.

- 1 Press the MENU button to display the On-Screen Menu. Press the POINT LEFT/RIGHT buttons to move the red frame pointer to the PC ADJUST Menu icon.
- 2 Press the POINT UP/DOWN buttons to move the red frame pointer to the AUTO PC adj. icon and then press the OK button.  
This Auto PC Adjustment can be also executed by pressing the AUTO PC ADJ. button on the top control or on the remote control unit.

#### To store the adjusted parameters.

The system parameters from Auto PC Adjustment can be memorized in this projector. Once the parameters are stored, the setting can be done just by selecting Mode in PC SYSTEM Menu (p.25). See MANUAL PC ADJUSTMENT on pages 27–28.

#### NOTE:

- Fine sync, Total dots, and Picture Positions of some computers can not be fully adjusted with the Auto PC Adjustment function. When the image is not provided properly with this function, manual adjustments are required. (See pages 27–28.)
- Auto PC Adjustment function cannot be operated in Digital Signal Input on the DVI terminal and “480p,” “575p,” “480i,” “575i,” “720p (HDTV),” “1035i (HDTV),” or “1080i (HDTV)” is selected on the PC SYSTEM Menu.

#### PC ADJUST MENU

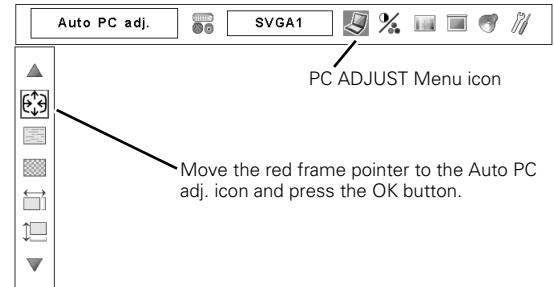

## MANUAL PC ADJUSTMENT

This projector can automatically tune to display signals from most personal computers currently distributed. However, some computers employ special signal formats which may not be tuned by the Multi-Scan system of this projector. If this happens, the projector cannot reproduce proper image and it may be recognized as a flickering; non-synchronized; non-centered; or skewed picture.

Manual PC Adjustment of this projector enables you to precisely adjust several parameters to match with those special signal formats. This projector has 10 independent memory areas to store those parameters manually adjusted, which allows you to recall setting for a specific computer whenever you use it.

Note: The PC ADJUST Menu cannot be operated when the digital signal input on the DVI terminal is selected on PC SYSTEM Menu. (p.25)

**1** Press the MENU button to display the On-Screen Menu. Press the POINT LEFT/RIGHT buttons to move the red frame pointer to the PC ADJUST Menu icon.

**2** Press the POINT UP/DOWN buttons to move the red frame pointer to the desired item, and then press the OK button. An Adjustment dialog box appears. Press the POINT LEFT/RIGHT buttons to adjust the value.

### **Fine sync**

Eliminate a flicker from the display. Press the POINT LEFT/RIGHT buttons to adjust the value (from 0 to 31).

### **Total dots**

Adjust the number of total dots in one horizontal period. Press the POINT LEFT/RIGHT buttons to adjust the number to match your PC image.

### **Position H**

Press the POINT LEFT/RIGHT buttons to adjust the horizontal picture position.

### **Position V**

Press the POINT LEFT/RIGHT buttons to adjust the vertical picture position.

### **Current mode**

Press the OK button to show H-sync freq. and V-sync freq. of the connected computer.

### **Clamp**

Adjusts the clamp level. When the image has a dark bars, try this adjustment.

### **Display area H**

Adjusts the horizontal area displayed by this projector. Press the POINT LEFT/RIGHT buttons to decrease/increase the value.

### **Display area V**

Adjusts the vertical area displayed by this projector. Press the POINT LEFT/RIGHT buttons to decrease/increase the value.

### PC ADJUST MENU

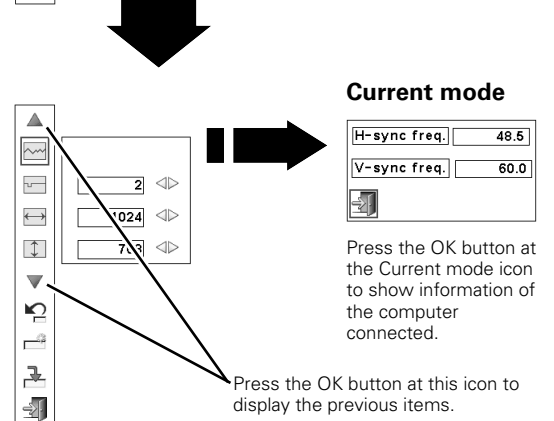
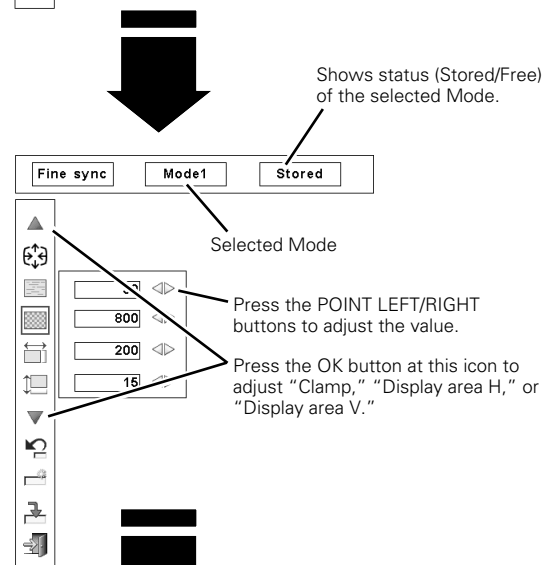
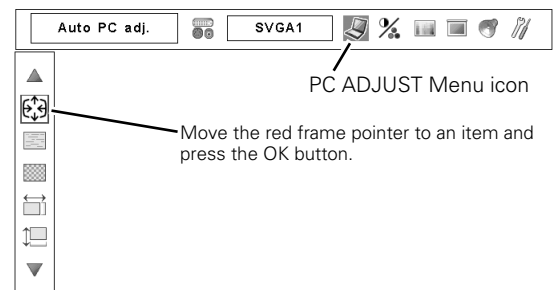

# COMPUTER INPUT



## Reset

To reset the adjusted parameters, select Reset and press the OK button. A confirmation box appears. Select [Yes]. All the adjustments return to their previous figures.



## Mode free

To clear adjusted parameters previously set, move the red frame pointer to the Mode free icon and then press the OK button. Move the red arrow pointer to a Mode that you want to clear and then press the OK button.



## Store

To store the adjusted parameters, move the red frame pointer to the Store icon and then press the OK button. Move the red arrow pointer to any of the Mode 1 to 10 in which you want to store the parameters and then press the OK button.



## Quit

Exit the PC ADJUST Menu.

### To store adjustment data.

This Mode has parameters being stored.

Where to store?

Mode1	Stored	0	0	0	0	0	←
Mode2	Free	0	0	0	0	0	
Mode3	Free	0	0	0	0	0	
Mode4	Free	0	0	0	0	0	
Mode5	Free	0	0	0	0	0	

Vacant

Close this dialog box.

Shows the values of "Total dots," "Position H," "Position V," "Display area H," and "Display area V."

OK?
Yes ←
No

A confirmation box appears and then select [Yes].

### To clear adjustment data.

Where to free?

Mode1	Stored	0	0	0	0	0	←
Mode2	Free	0	0	0	0	0	
Mode3	Free	0	0	0	0	0	
Mode4	Free	0	0	0	0	0	
Mode5	Free	0	0	0	0	0	

Close this dialog box.

OK?
Yes ←
No

A confirmation box appears and then select [Yes].

# PICTURE IMAGE SELECT

## IMAGE LEVEL SELECT

### DIRECT OPERATION

Select an image level from among Standard, High contrast, and Custom by pressing the IMAGE button on the top control or on the remote control unit.

#### Standard

Normal picture level preset on this projector.

#### High contrast

Picture level with improved halftone for graphics.

#### Custom 1-10

User preset picture adjustment in the IMAGE ADJUST Menu. (pp.35-37)

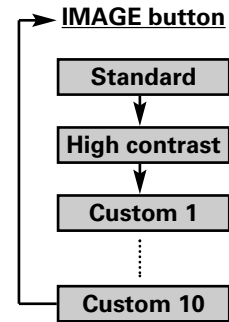

### MENU OPERATION

- 1 Press the MENU button to display the On-Screen Menu. Press the POINT LEFT/RIGHT buttons to move the red frame pointer to the IMAGE SELECT Menu icon.
- 2 Press the POINT UP/DOWN buttons to move the red frame pointer to the desired level and then press the OK button.

#### IMAGE SELECT MENU

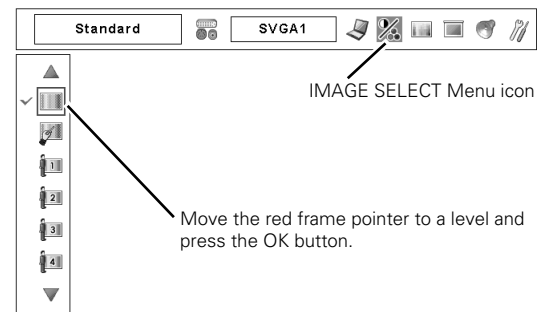

#### Standard

Normal picture level preset on this projector.



#### High contrast

Picture level with improved halftone for graphics.



#### Custom 1-10

User preset picture adjustment in the IMAGE ADJUST Menu. (pp.35-37)

# PICTURE SCREEN ADJUSTMENT

## PICTURE SCREEN SELECT

This projector has a picture screen resize function, which enables you to display the desirable image size.

**1** Press the MENU button to display the On-Screen Menu. Press the POINT LEFT/RIGHT buttons to move the red frame pointer to the SCREEN Menu icon.

**2** Press the POINT UP/DOWN buttons and move the red frame pointer to the desired function and then press the OK button.



**Normal**

Provides the image to fit the screen size.



**True**

Provides image in its original size.



**Wide**

Provides the image to fit the wide video aspect ratio (16:9) by expanding the image width uniformly. This function can be used to provide the squeezed video signal at 16:9.



**Full**

Provides the full screen image.



**Digital zoom +**

When the Digital zoom + is selected, the On-Screen Menu disappears and "D. Zoom +" appears. Press the OK button to expand the image size. Press the POINT UP/DOWN/LEFT/RIGHT buttons to pan the image. The Panning function can work only when the image is larger than the screen size.

The projected image can be also expanded by pressing the D.ZOOM ▲ button on the remote control unit.



**Digital zoom -**

When the Digital zoom - is selected, the On-Screen Menu disappears and "D. Zoom -" appears. Press the OK button to compress the image size.

The projected image can be also compressed by pressing the D.ZOOM ▼ button on the remote control unit.

To cancel the Digital Zoom +/- mode, press any button except D.ZOOM ▲/▼, OK, POINT, and LASER buttons.

### SCREEN MENU

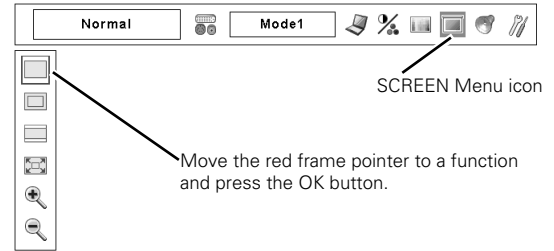

#### NOTE:

- True, Full, and Digital zoom +/- cannot be operated when "480i," "575i," "480p," or "575p" is selected on the PC SYSTEM Menu. (p.25)
- The Screen Menu cannot be operated when "720p (HDTV)," "1035i (HDTV)," or "1080i (HDTV)" is selected on the PC SYSTEM Menu. (p.25)
- This projector cannot display any resolution higher than 1600 x 1200. If your computer's screen resolution is higher than 1600 x 1200, lower the resolution before connecting the projector.
- The image data other than XGA (1024 x 768) is modified to fit the screen size in initial mode.
- The Panning function may not operate properly if the computer system prepared on the PC ADJUST Menu is used.

## SELECTING INPUT SOURCE

### DIRECT OPERATION

Select an INPUT source by pressing the INPUT button on the top control or the INPUT 1, INPUT 2, or INPUT 3 buttons on the remote control unit.

If the projector cannot reproduce proper image, select a correct input source with the MENU OPERATION (see below).

### INPUT button

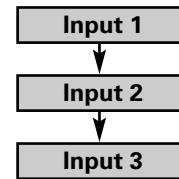

\*Input 1 is not displayed when the Input 1 is used as Monitor out.

### MENU OPERATION

#### WHEN SELECTING INPUT 2 (5 BNC INPUT JACKS )

When connecting to video equipment, select a type of Video source in the Source Select Menu.

- 1 Press the MENU button to display the On-Screen Menu. Press the POINT LEFT/RIGHT buttons to move the red frame pointer to the INPUT Menu icon.
- 2 Press the POINT UP/DOWN buttons to move the red arrow pointer to Input 2 and then press the OK button. A Source Select Menu appears.
- 3 Move the pointer to a source that you want to select and then press the OK button.

- Video** When the video input signal is connected to the VIDEO jack, select Video.
- Y, Pb/Cb, Pr/Cr** When the video input signal is connected to the Y-Pb/Cb-Pr/Cr jacks, select Y, Pb/Cb, Pr/Cr.

**NOTE:**  
• INPUT SOURCE changes if the INPUT 2 button on the remote control unit is pressed.

### INPUT MENU

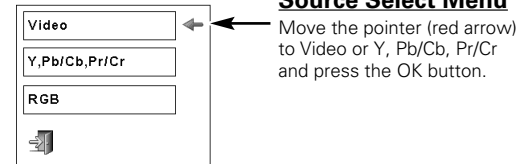
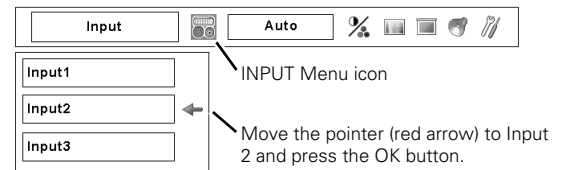

#### WHEN SELECTING INPUT 3 (AV TERMINALS )

When connecting to video equipment, select a type of Video source in the Source Select (Video) Menu.

- 1 Press the MENU button to display the On-Screen Menu. Press the POINT LEFT/RIGHT buttons to move the red frame pointer to the INPUT Menu icon.
- 2 Press the POINT UP/DOWN buttons to move the red arrow pointer to Input 3 and then press the OK button. A Source Select Menu appears.
- 3 Move the pointer to a source that you want to select and then press the OK button.

- Video** When the video input signal is connected to the VIDEO jack, select Video.
- Y, Pb/Cb, Pr/Cr** When the video input signal is connected to the Y-Pb/Cb-Pr/Cr jacks, select Y, Pb/Cb, Pr/Cr.
- S-Video** When the video input signal is connected to the S-VIDEO jack, select S-Video.

**NOTE:**  
• INPUT SOURCE changes if the INPUT 3 button on the remote control unit is pressed.

### INPUT MENU

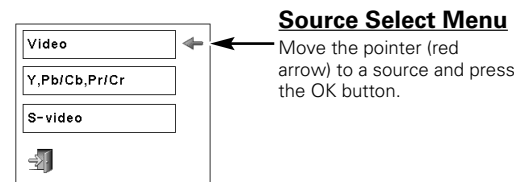
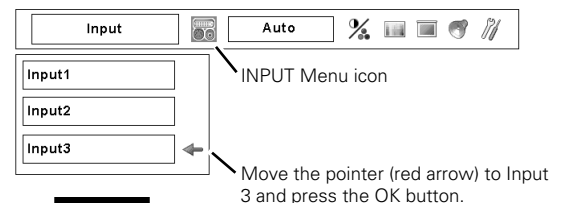



## SELECTING VIDEO SYSTEM

- 1** Press the MENU button to display the On-Screen Menu. Press the POINT LEFT/RIGHT buttons to move the red frame pointer to the AV SYSTEM Menu icon.
- 2** Press the POINT UP/DOWN buttons to move the red arrow pointer to the desired system and then press the OK button.

### VIDEO JACK OR S-VIDEO JACK

#### Auto

The projector automatically detects an incoming video system, and adjusts itself to optimize its performance.

#### PAL / SECAM / NTSC / NTSC4.43 / PAL-M / PAL-N

If the projector cannot reproduce proper video image, select a specific broadcast signal format from among PAL, SECAM, NTSC, NTSC 4.43, PAL-M, and PAL-N.

### Y, Pb/Cb, Pr/Cr JACKS

#### Auto

The projector automatically detects an incoming video signal, and adjusts itself to optimize its performance. When the Video System is 1035i or 1080i, select the system manually.

#### COMPONENT VIDEO SIGNAL FORMAT

If the projector cannot reproduce proper video image, select a specific component video signal format from among 480i, 575i, 480p, 575p, 720p, 1035i, and 1080i.

#### AV SYSTEM MENU (VIDEO OR S-VIDEO)

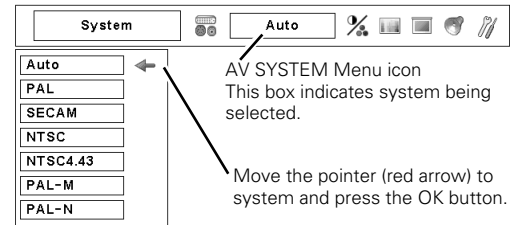

#### AV SYSTEM MENU (COMPONENT VIDEO)

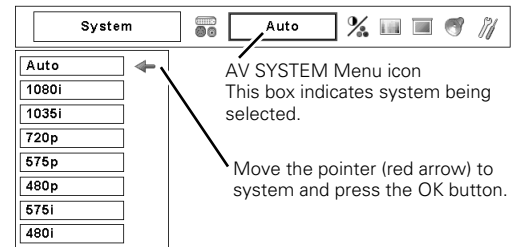

# PICTURE IMAGE SELECT

## IMAGE LEVEL SELECT

### DIRECT OPERATION

Select an image level from among Standard, Cinema, Custom by pressing the IMAGE button on the top control or on the remote control unit.

#### Standard

Normal picture level preset on this projector.

#### Cinema

Picture level adjusted for picture with fine tone.

#### Custom 1-10

User preset picture adjustment in the IMAGE ADJUST Menu. (pp.35-37)

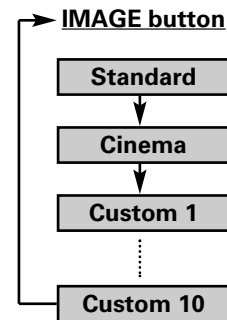

### MENU OPERATION

- 1 Press the MENU button to display the On-Screen Menu. Press the POINT LEFT/RIGHT buttons to move the red frame pointer to the IMAGE SELECT Menu icon.
- 2 Press the POINT UP/DOWN buttons to move the red frame pointer to the desired level and then press the OK button.

#### IMAGE SELECT MENU

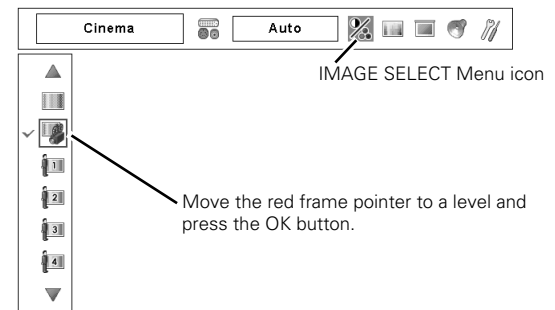

#### Standard

Normal picture level preset on this projector.



#### Cinema

Picture level adjusted for picture with fine tone.



#### Custom 1-10

User preset picture adjustment in the IMAGE ADJUST Menu. (pp.35-37)

# PICTURE SCREEN ADJUSTMENT

## PICTURE SCREEN SELECT

This projector has a picture screen resize function, which enables you to customize the image size.

**1** Press the MENU button to display the On-Screen Menu. Press the POINT LEFT/RIGHT buttons to move the red frame pointer to the SCREEN Menu icon.

**2** Press the POINT DOWN button and move the red frame pointer to the desired function and then press the OK button.



Provides image at the normal video aspect ratio of 4:3.



Provides image at the wide screen ratio of 16:9.

### SCREEN MENU



Move the red frame pointer to a function and press the OK button.

### NOTE:

- SCREEN Menu can not be operated when "720p," "1035i," or "1080i" is selected in the AV SYSTEM Menu (p.32).

## PICTURE IMAGE ADJUSTMENTS

- 1 Press the MENU button to display the On-Screen Menu. Press the POINT LEFT/RIGHT buttons to move the red frame pointer to the IMAGE ADJUST Menu icon.
- 2 Press the POINT UP/DOWN buttons to move the red frame pointer to the desired item and then press the OK button. The level of each item is displayed. Adjust each level by pressing POINT LEFT/RIGHT buttons.



### Contrast

Press the POINT LEFT button to decrease contrast; press the POINT RIGHT button to increase the contrast (from 0 to 63).



### Brightness

Press the POINT LEFT button to decrease the brightness; press the POINT RIGHT button to increase the brightness (from 0 to 63).



### Color

Press the POINT LEFT button decrease the intensity of the color; press the POINT RIGHT button to increase the intensity of the color (from 0 to 63).



### Tint

Press the POINT LEFT/RIGHT buttons to adjust the tint value to obtain proper color balance (from 0 to 63).



### Color Management

The Color management function can be used to adjust the LEVEL, PHASE, and GAMMA of the selected display colors (except for black, white, and gray) on the screen and replace these colors with other colors if required.

You can store up to eight (8) color management data.

- 1 Press the POINT UP/DOWN buttons to move the red frame pointer to Color management, and then press the OK button. The image being projected freezes, and the COLOR MANAGEMENT POINTER appears.
- 2 Use the POINT UP/DOWN/LEFT/RIGHT buttons to move the pointer to a spot where you want to adjust the color and then press the OK button. The COLOR SELECTION window appears, and the color in the center of the pointer is selected and you can adjust the color.
- 3 Use the POINT UP/DOWN/LEFT/RIGHT buttons to adjust the LEVEL and PHASE of the color, and then press the OK button to confirm the setting. Then use the POINT UP/DOWN buttons to adjust the GAMMA for the color and press the OK button to accept the setting. After adjusting, press the OK button to go to the COLOR MANAGEMENT LIST.

### COLOR SELECTION MODE

#### LIST

Go to the COLOR MANAGEMENT LIST.

### IMAGE ADJUST MENU

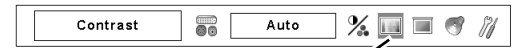

IMAGE ADJUST Menu icon

Move the red frame pointer to item to be selected and then press OK button.



Press the POINT LEFT/RIGHT buttons to adjust the value.

### POINTER MODE

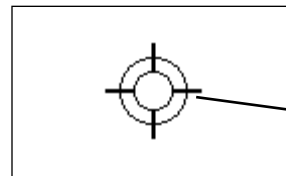

COLOR MANAGEMENT POINTER

#### NOTE:

Press the COLOR M. button on the remote control unit to display the COLOR MANAGEMENT POINTER.

If you would like to check or readjust the color management setting that has already been made, press the COLOR M. button on the remote control unit once more to display the COLOR MANAGEMENT LIST.

# PICTURE IMAGE

## COLOR SELECTION MODE (continued)

### COLOR M.

Return to the COLOR MANAGEMENT POINTER. (If you press the MENU button on the top control or the remote control unit, it returns to the COLOR MANAGEMENT POINTER and you will need to reselect and readjust the color.)

### MENU

Return to the IMAGE ADJUST Menu. But any settings that have been changed will not be stored. To store the changed settings, be sure to select "LIST" and go to the COLOR MANAGEMENT LIST.

- 4 In the COLOR MANAGEMENT LIST, the adjusted color data are check marked. You can decide whether or not to apply the adjusted color data in the list to the projected image (see below).

## LIST MODE



Clear the check mark if you do not want to apply the adjusted color data; select the check mark and then press the OK button. The check mark disappears.

### COLOR PALETTE

Return to the COLOR SELECTION mode so that you can readjust the setting for the color in that line. (This option is not available if the check mark is cleared.)

### DEL

Select the DEL box if you want to delete the adjusted data. Press the OK button and a confirmation box appears and then select [Yes]

### ALL DEL

Delete all the data in the list. Press the OK button and a confirmation box appears and then select [Yes].

### MENU

The same function as stated above.

### COLOR M.

The same function as stated above.



### Auto picture control

Press the POINT LEFT/RIGHT buttons to select the desired Auto picture control position. The part where the image is dark is emphasized. It is emphasized more strongly in order of Off, L1, L2.

- Off . . . . Auto picture control OFF position.
- L1 . . . . Auto picture control LEVEL 1 position.
- L2 . . . . Auto picture control LEVEL 2 position.



### Color temp.

Press either the POINT LEFT/RIGHT buttons to select the desired Color temp. level (XLow, Low, Mid, or High).

## COLOR SELECTION MODE

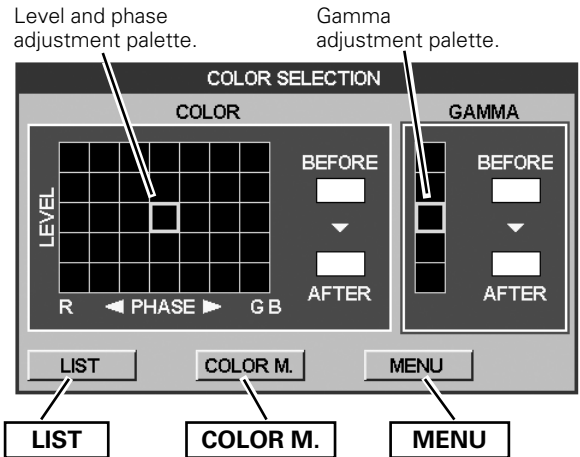

## LIST MODE

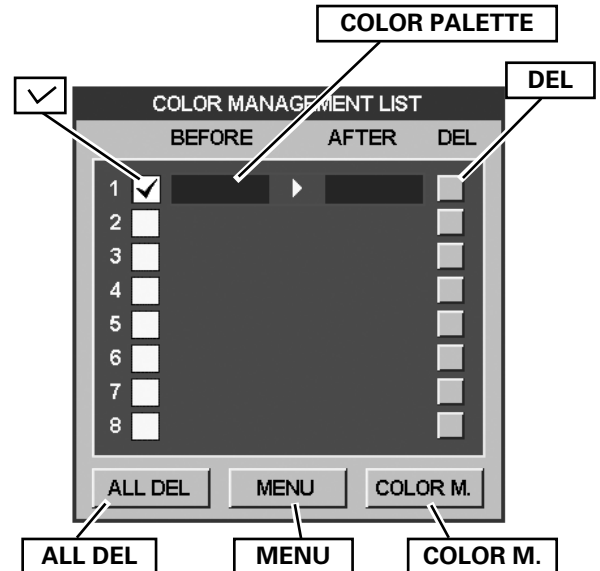

### NOTE:

If you press the COLOR M. button on the remote control unit, the display returns to the normal projection screen, but any settings that have been changed will not be stored. To store the changed settings, be sure to select "MENU" to return to the IMAGE ADJUST Menu and store the settings.



## White balance (Red)

Press the POINT LEFT button to lighten red tone; press the POINT RIGHT button to deepen red tone (from 0 to 63).



## White balance (Green)

Press the POINT LEFT button to lighten green tone; press the POINT RIGHT button to deepen green tone (from 0 to 63).



## White balance (Blue)

Press the POINT LEFT button to lighten blue tone; press the POINT RIGHT button to deepen blue tone (from 0 to 63).



## Sharpness

Press the POINT LEFT button to decrease the sharpness of the image; press the POINT RIGHT button to increase the sharpness of the image (from 0 to 31).



## Gamma

Press the POINT LEFT/RIGHT buttons to adjust the gamma value to obtain better balance of contrast (from 0 to 15).



## Noise reduction

Noise interference on the screen can be reduced. Press the POINT LEFT/RIGHT buttons to change the noise reduction mode.

- Off . . . . Noise reduction mode is "Off"
- L1 . . . . For lower reduction
- L2 . . . . For higher reduction



## Progressive

An interlaced video signal can be displayed in progressive. Press the POINT LEFT/RIGHT buttons to change the progressive scan mode.

- Off . . . . Progressive scan mode is "Off."
- On . . . . Progressive scan mode is "On."
- Film . . . Select for watching a film. With this function, the projector reproduces pictures faithful to the original film quality.

### NOTE:

- The Film mode in the Progressive function cannot be selected when the video signal format is 1080i or 1035i.



## Reset

To reset the adjusted parameters, select Reset and press the OK button. A confirmation box appears. Select [Yes]. All the adjustments return to their previous figures.



## Store

To store manually preset image, move the red frame pointer to the Store icon and press the OK button. The Image Level Menu appears. Move the red arrow pointer to the Custom 1 to 10 where you want to set and then press the OK button.



## Quit

Exit the IMAGE ADJUST Menu.

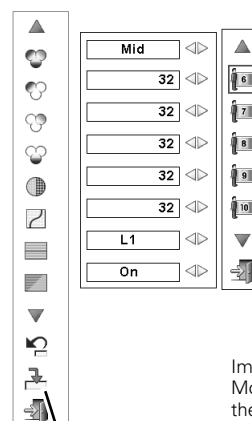
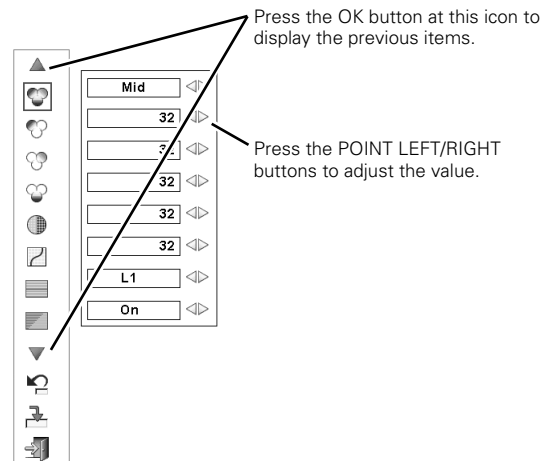
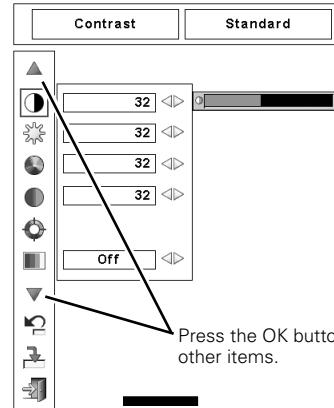

Store icon  
Press the OK button at this icon to store the adjustment.

## SETTING MENU

This projector has Setting menu that allows you to set up the other various functions described as follows:

- 1 Press the MENU button to display the On-Screen Menu. Press the POINT LEFT/RIGHT buttons to move the red frame pointer to the Setting Menu icon.
- 2 Press the POINT DOWN button to move the red frame pointer to the desired item that and then press the OK button. The Setting dialog box appears.

### Language

The language used in the On-Screen Menu is available in English, German, French, Italian, Spanish, Portuguese, Dutch, Swedish, Russian, Chinese, Korean, or Japanese.

### Keystone

This function corrects distortion of a projected image. Select either Store or Reset with the POINT LEFT/RIGHT buttons, and then press the OK button. The Keystone dialog box appears. Correct keystone with the POINT UP/DOWN/LEFT/RIGHT buttons. (p.22)

Store . . . stores the keystone correction even if the AC power cord is unplugged.

Reset . . . resets the keystone correction when the AC power cord is unplugged.

### Background

Three background settings are available in this projector. Select one of the following options when no input source is connected to the projector or no input signal is coming from the connected equipment.

Blue . . . blue colored background

User . . . the image you captured

Black . . . black colored background

### Display

This function decides whether to display On-Screen Displays.

On . . . . . shows all the On-Screen Display.

Count-down Off . . . hide the Count-down Display.

Off . . . . . hide the On-Screen Display except:

- On-Screen Menu
- "Power off?" (p.21)
- P-TIMER (p.23)
- "Please wait...."
- Color management operation screen (pp.35–36)
- "No signal" for Power management (p.40)

### SETTING MENU (LANGUAGE)

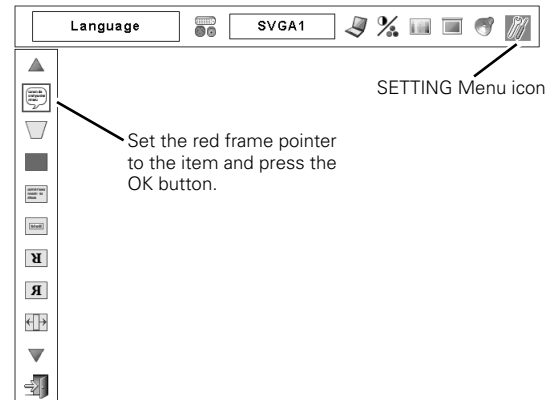

When pressing the OK button at Language, the Language Menu appears.

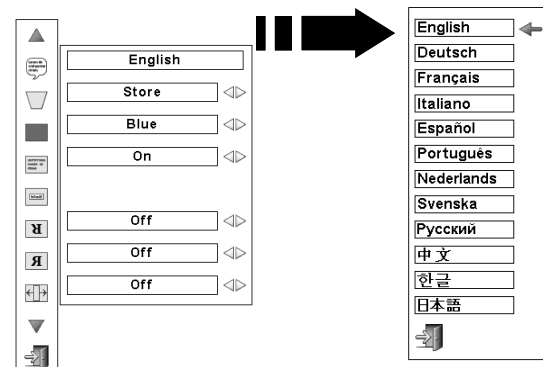



## Logo

This function allows you to customize the screen logo with Logo select, Capture, and Logo PIN code lock functions.



## Logo select

This function decides the start-up display as follows:

- User . . . the image you captured
- Default . the factory-set logo
- Off . . . . count-down only



## Capture

This function enables you to capture the image being projected and use it for a starting-up display.

After capturing the projected image, go to the Logo select function and set it to "User." Then the captured image will be displayed when turning on the projector the next time.

To capture the image, select [Yes]. To cancel the Capture function, select [No].

### NOTE:

- Before capturing an image, select Standard in the IMAGE SELECT Menu to capture proper image. (See pages 29, 33.)
- A signal from a computer can be captured up to XGA (1024 x 768).
- Certain signals may not be captured properly.
- When capturing the image that has been adjusted by the Keystone function, the adjusted data is automatically reset and the projector captures an image without keystone correction.
- When starting to capture a new image, the previously stored image is cleared even if you cancel the capturing.
- Once you exit the Logo Menu after setting the Logo lock to "On," you are required to enter the PIN code every attempting to change the Logo setting.



## Logo PIN code lock

This function prevents an unauthorized person from changing the Logo setting.

- Off . . . . the Logo setting can be changed freely from the Logo function.
- On . . . . the Logo setting cannot be changed without a Logo PIN code.

If you want to change the Logo PIN code lock setting, enter a Logo PIN code by following the steps below. The initial Logo PIN code is set to "4321" at the factory.

### To Enter a Logo PIN code

Select a number by pressing the POINT LEFT/RIGHT buttons and fix the number with the OK button. The number changes to "\*." If you fixed a wrong number, move the pointer to "Set" or "Clear" once by pressing the POINT DOWN button, then return to "Logo PIN code." Enter the correct number.

Repeat this step to complete entering a four-digit number.

When the four-digit number is fixed, the pointer automatically moves to "Set." Press the OK button so that you can change the Logo PIN code lock setting.

If you entered a wrong Logo PIN code, "Logo PIN code" and the number (\*\*\*\*) turn red and disappear. Enter a Logo PIN code all over again.

## Logo

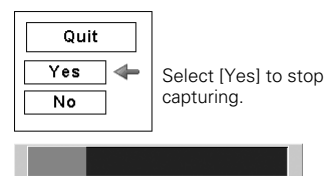
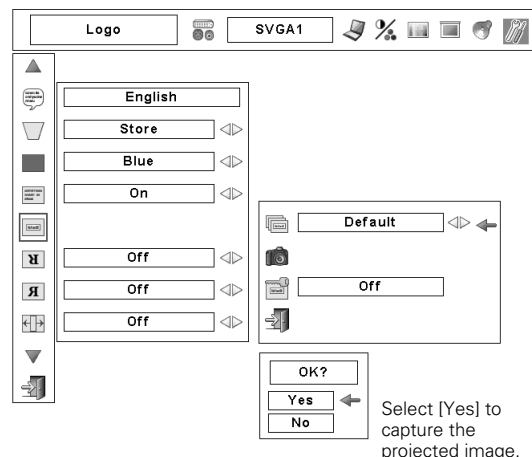

## Logo PIN Code Lock Dialog Box

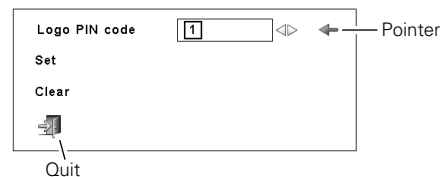

After a correct Logo PIN code is entered, the following dialog box appears.

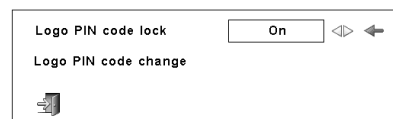

Select On/Off by pressing the POINT LEFT/RIGHT buttons or change the Logo PIN code.

### To Change the Logo PIN code

Logo PIN code can be changed to your desired four-digit number. Select "Logo PIN code change" with the POINT DOWN button and press the OK button. Set a new Logo PIN code. Be sure to write down the new Logo PIN code and keep it at hand.

### NOTE:

If you forget your Logo PIN code and unable to change it, the Logo PIN code can be reset to the factory default setting (4321) according to the following procedures.

When you reset the Logo PIN code, the PIN code and Key lock will be reset, as well.

1. Unplug the AC Power Cord from the AC outlet.
2. Hold down the OK button on the projector and connect the AC Power Cord into the outlet again. Keep holding down the OK button until the POWER indicator lights. The Logo PIN code returns to the factory default setting while the Logo PIN code lock state will remain the same as the previous set state.



## Ceiling

When this function is "On," the picture is top/bottom and left/right reversed. This function is used to project the image from a ceiling-mounted projector.

## Rear

When this function is "On," the picture is left/right reversed. This function is used to project the image to a rear projection screen.

## Anamorphic

When this function is "On," the screen image is forcibly changed to the 4:3 image, even if the input signal is HDTV.

## Simple menu

When this function is "On," the value adjustment bar in the picture IMAGE ADJUSTMENT Menu is displayed on the bottom left of the screen.

## Menu position

This function is used to adjust the On-Screen Menu display position. When the OK button is pressed, the adjustment screen is displayed (arrows appear). Use the POINT UP/DOWN/ LEFT/RIGHT button(s) to adjust the position. After making the adjustment, press the OK button to return to the Menu screen.

## Power management

For reducing power consumption as well as maintaining the lamp life, the Power management function turns off the projection lamp when the projector is not used for a certain period.

If the input signal is interrupted and no button is pressed for more than 30 seconds, the timer display with "No signal" appears on the screen to start the countdown. The countdown time can be set between 1 and 30 minutes.

Select one of the following operations:

- Ready . . . . . When the lamp has been fully cooled down, the READY indicator starts blinking. In this condition, the projection lamp is turned on if the input signal is reconnected or any button on the top control or remote control unit is pressed.
- Shutdown . . . . . When the lamp has been fully cooled down, the power is turned off.
- Off . . . . . The Power management function is off.

### Ceiling

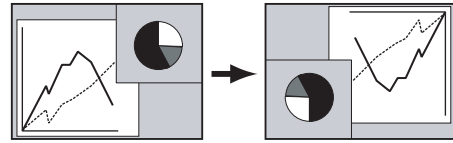

### Rear

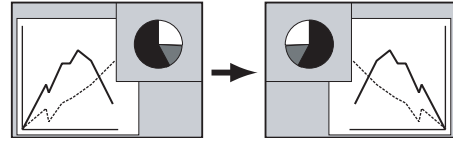

### Power management



Time left until lamp off

Power management

SVG A1

Off

Ready

Off

Off

Code 1

Ready

5 Min

Press the OK button at Power management and this box appears. Choose one of three settings with the POINT LEFT/RIGHT buttons, and go to the timer with the POINT DOWN button and set time with the POINT LEFT/RIGHT buttons.



## On start

When this function is "On," the projector is automatically turned on just by connecting the AC power cord to an AC outlet.

### NOTE:

- Be sure to turn the projector off properly (see "TURNING OFF THE PROJECTOR" on page 21). If the projector is turned off in the incorrect sequence, such as unplugging the AC power cord before completing the cool-down etc., the On start function does not operate properly.



## Lamp mode

This function allows you to change the brightness of the screen.

- Auto mode . . . . . brightness according to the input signal.
- Normal mode . . . . . normal brightness.
- Silent mode . . . . . lower brightness reduces the lamp power consumption and extends the lamp life.



## Remote control

The eight different remote control codes (Code 1–8) are assigned to this projector: the factory-set, initial code (Code 1) and the other seven codes (Code 2 to Code 8). This switching function prevents interference from other remote controls when several projectors or video equipment next to each other are operated at the same time. For example, when operating the projector in "Code 7," the code for both the projector and the remote control unit must be switched to "Code 7."

### **To change the code of the projector:**

Select from Code 1 to Code 8 in the SETTING Menu.

### **To change the code of the remote control unit:**

Set the DIP switches 1–3 inside the battery compartment of the remote control unit. (See page 15.)

## Remote control

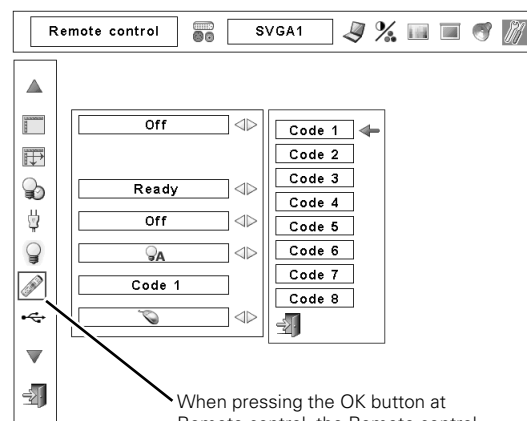

When pressing the OK button at Remote control, the Remote control code menu appears.

# SETTING

## **USB**

This Projector has a USB port for interactive operation between the projector and computers. Set the mode by following the steps below.

### **Wireless Mouse mode**

Select "" when controlling a computer with the remote control unit of this projector.

### **Projector mode:**

"" Not used.

## **Security**

### **Key lock**

This function locks operation of the top control and remote control unit. It helps to prevent operation by an unauthorized person.

 . . . . unlocked.

 . . . . locks operation of the top control.  
To unlock, use the remote control unit.

 . . . . locks operation of the remote control unit.  
To unlock, use the top control.

If the top control accidentally becomes locked and you do not have the remote control unit nearby, unplug the AC power cord from the AC outlet, and then hold down the OK button and reinsert the AC power cord. This will cancel the top control lock. Logo PIN code and PIN code will also be cancelled.

## **Security**

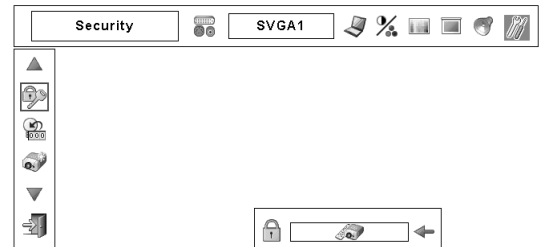

## **Key lock**

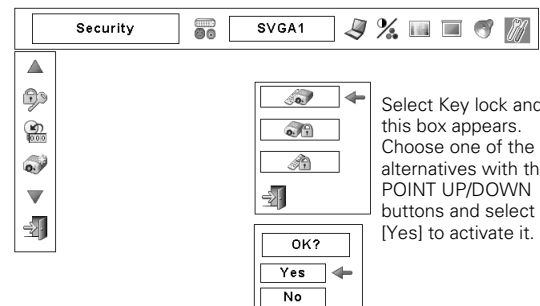



## PIN code lock

This function prevents the projector from being operated by an unauthorized person and provides the following settings for security options.

- Off . . . . the projector is not locked with the PIN code.
- On1 . . . requires to enter the PIN code every time turning on the projector.
- On2 . . . requires to enter the PIN code to operate the projector once the power cord is disconnected; as long as the AC power cord is connected, the projector can be operated without a PIN code.

Whenever you change the PIN Code Lock setting or the PIN code (the four-digit number), you are required to enter the PIN code. "1234" is set as the initial PIN code at the factory.

### To Enter a Logo PIN code

Select a number by pressing the POINT LEFT/RIGHT buttons and fix the number with the OK button. The number changes to "\*" . If you fixed a wrong number, move the pointer to "Set" or "Clear" once by pressing the POINT DOWN button, then return to "PIN code." Enter the correct number.

Repeat this step to complete entering a four-digit number.

When the four-digit number is fixed, the pointer automatically moves to "Set." Press the OK button so that you can change the PIN code lock settings.

If you entered a wrong PIN code, "PIN code" and the number (\*\*\*\*) turn red and disappear. Enter a Logo PIN code all over again.

### To Change the PIN Code Lock setting

Select "Off," "On1," or "On2" with the POINT LEFT/RIGHT buttons and then go to "Quit" with the POINT DOWN button. Press the OK button to close the dialog box.

### To Change the PIN Code

The PIN code can be changed to your desired four-digit number. Select "PIN code change" with the POINT DOWN button, and press the OK button. A New PIN code input dialog box appears.

Select a number with the POINT LEFT/RIGHT buttons and fix the number with the OK button. Repeat it to complete entering a four-digit number. When the four-digit number is fixed, the pointer automatically moves to "Set." Then press the OK button. Be sure to write down the new Logo PIN code and keep it at hand.

#### NOTE:

If you forget your PIN code and unable to change it, the PIN code can be reset to the factory default setting (1234) according to the following procedures.

When you reset the PIN code, the Logo PIN code and Key lock will be reset, as well.

1. Unplug the AC Power Cord from the AC outlet.
2. Hold down the OK button on the projector and connect the AC Power Cord into the outlet again. Keep holding down the OK button until the POWER indicator lights. The PIN code returns to the factory default setting while the PIN code lock state will remain the same as the previous set state.

## PIN code lock

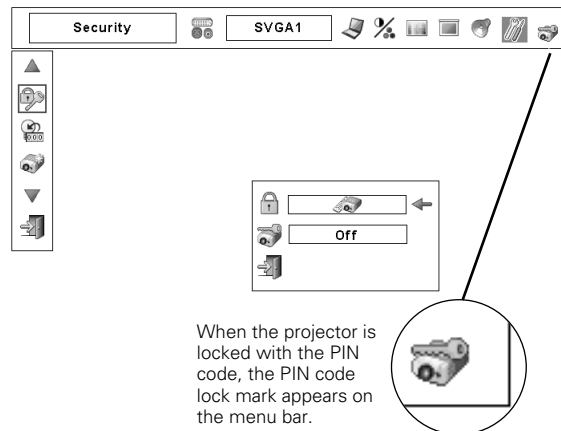

### Entering a PIN code

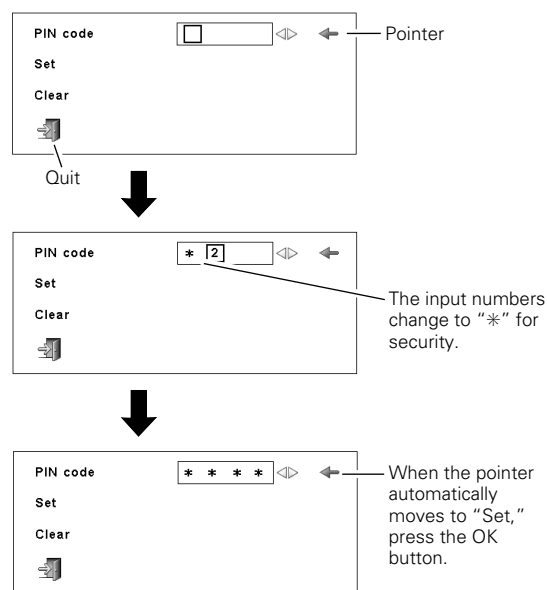

### Changing the PIN code lock setting

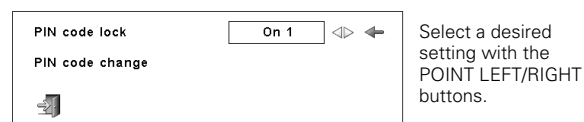

### Change the PIN code

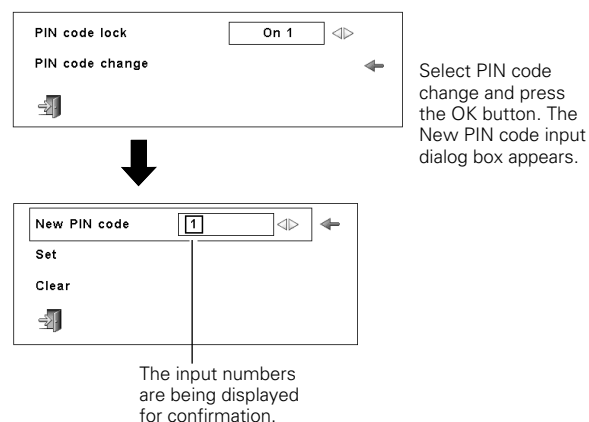

# SETTING



## Lamp counter

This function is used to reset the Lamp replacement counter. When replacing the projection lamp, reset the Lamp replacement counter with this function. See page 49 for operation.



## Factory default

This function returns all setting values except for the User logo, Key lock, PIN code lock, Logo PIN code lock, and the Lamp counter to the factory default settings.



## Quit

Exit the SETTING Menu.

## Factory default

Factory default    SVGA1

Return to Factory default ?

Yes    No

OK?

Yes    No

Select [Yes] to activate it.

## WIRELESS MOUSE

Remote control unit is not only able to operate this projector but also functions as a wireless mouse for most personal computers. The MOUSE POINTER, DRAG ON/OFF button, and two CLICK buttons are used for wireless mouse operation.

The Wireless mouse function is available only when the PC mouse pointer is displayed on the screen.

### INSTALLATION

To use the remote control unit as a wireless mouse for a computer, installation of a mouse driver (not supplied) is required. Make sure that the mouse driver is properly installed on your computer and that the mouse port (or USB port) of the computer is activated.

- 1** Connect the mouse port (or USB port) of your computer to the CONTROL PORT (or USB connector) of this projector with the Control cable (or USB cable). (See pages 12–13 for connection.)
- 2** Turn on the projector first, and then turn your computer on. If the computer is switched on first, the Wireless mouse function may not work properly.

Note: When your computer has no mouse port, connect the Serial port of your computer to the Control port of the projector with the Control cable for Serial port (supplied).

### OPERATING WIRELESS MOUSE

When controlling the PC mouse pointer, use the MOUSE POINTER, DRAG ON/OFF button, LEFT CLICK button, and RIGHT CLICK button on the remote control unit.

#### MOUSE POINTER

Used to move the PC mouse pointer. The pointer moves to the direction you are pressing.

#### LEFT CLICK button

This button has the same function as the left button in a PC mouse. To drag a selected screen object, hold down this button and press the MOUSE POINTER.

#### RIGHT CLICK button

This button has the same function as the right button in a PC mouse.

#### DRAG ON/OFF button

Use this button and the MOUSE POINTER to drag a selected screen object. Press and release the DRAG ON/OFF button, then the DRAG ON INDICATOR lights green and the remote control unit is in Drag mode. Use the MOUSE POINTER to drag an screen object. Press and release the DRAG ON/OFF button again or press any other button to drop the object.

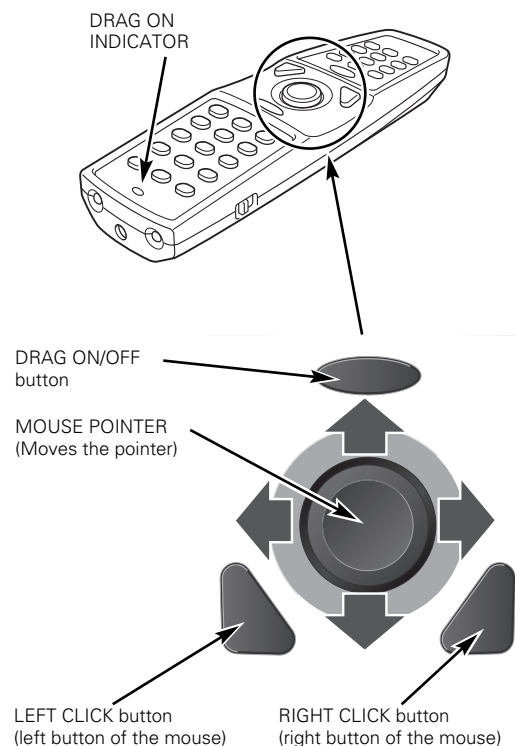

# MAINTENANCE

## WARNING TEMP. INDICATOR

The Warning Temp. indicator blinks red to let you know the internal temperature of the projector exceeds a normal level. If the temperature goes up further, the projector will be turned off automatically and the Ready indicator goes out. (The Warning Temp. indicator continues blinking.) After the cooling-off period, the Ready indicator lights on again and the projector can be turned on by pressing the POWER button on the top control or the remote control unit. When you turn on the projector, the Warning Temp. indicator goes out.

If the Warning Temp. indicator is still blinking, check the following matters:

- The ventilation slots of the projector may be blocked. In such a case, reposition the projector so that the ventilation slots are not obstructed.
- The air filters may be clogged with dust particles. Clean them by following the section "AIR FILTER CARE AND CLEANING" on the next page.
- If the WARNING TEMP. indicator remains on after performing above checks, the cooling fans or internal circuits may be malfunctioning. Contact the service station.

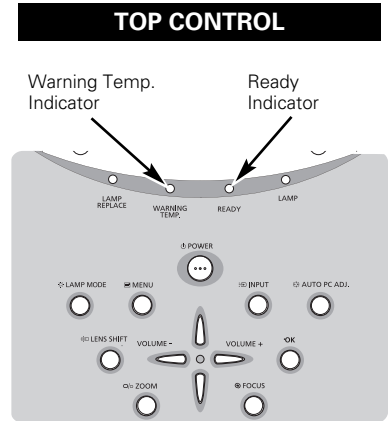

### When both of the Warning Temp. and Ready indicators are blinking:

When the projector detects an internal problem, it shuts down automatically and both the Warning Temp. and Ready indicators start blinking. In this condition, the projector cannot be turned on even if you press the POWER button on the top control or remote control unit. If this happens, unplug and reconnect the AC power cord, and then turn on the projector again to check the operation. If the projector shuts down again or cannot to be turned on, internal checking and repair is required. Unplug the AC power cord and contact the service station.

## AIR FILTERS CARE AND CLEANING

Air filters help prevent dust from accumulating on the optical elements inside the projector. To whatever extent the air filters become clogged with dust particles, the cooling fans' effectiveness is reduced, which may result in an internal heat build-up and adversely affect the life of the projector. Therefore, for appropriate care and use of the projector, regular cleaning of the air filters is necessary.

How often the air filters should be cleaned really depends upon the environment in which the projector is being operated. As a rough guide, under a normally clean operating environment, the air filters should be cleaned approximately every 200 hours of use. However, if the projector is being operated in a somewhat dusty or smoky environment, the air filters should be cleaned more often; for consistently good projector operation and performance, timely cleaning of the air filters is a very important factor. When appropriate, clean the air filters following the steps below.

- 1** Turn off the projector and unplug the AC power cord from an AC outlet.
- 2** Turn over projector and remove the air filters by pulling the latches upward.
- 3** Clean the air filters with a brush or rinse them softly. When rinsing the air filters, dry them well.
- 4** Replace the air filters properly. Make sure that the air filters are fully inserted to the projector.

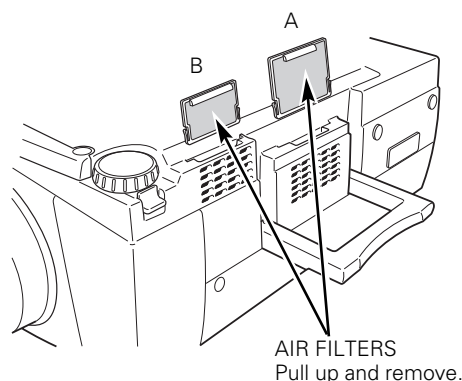

### CAUTION

Do not operate the projector with the air filters removed. Dust may accumulate on the LCD Panel and projection mirror degrading the picture quality. Do not put anything into the air intake vents. It may result in malfunction of the projector.

NOTE: If the dust cannot be removed by cleaning, it is probably time to replace the air filters with new ones. Please consult your dealer.

## RECOMMENDATION

**We recommend avoiding dusty/smoky environments when operating the projector. Usage in these environments may cause a poor image quality.**

When using the projector under dusty or smoky conditions, dust may accumulate on a lens, liquid crystal panels, or optical elements inside the projector. Such condition may degrade the quality of the projected image. When the symptoms above are noticed, contact your authorized dealer or service station for proper cleaning.

## CLEANING PROJECTION LENS

Follow these steps to clean the projection lens:

- 1** Turn off the projector and unplug the AC power cord from an AC outlet.
- 2** Apply a non-abrasive camera lens cleaner to a dry soft cleaning cloth. Avoid using an excessive amount of cleaner. Abrasive cleaners, solvents, or other harsh chemicals might scratch the surface of the lens.
- 3** Gently wipe with the cleaning cloth over the projection lens.
- 4** When the projector is not in use, put the lens cap.



# LAMP REPLACEMENT

When the projection lamp of this projector reaches its end of life, the LAMP REPLACE indicator lights orange. If this indicator lights orange, replace the projection lamp with a new one promptly.

This indicator lights orange when the projection lamp reaches its end of life. Replace the projection lamp with a new one promptly.

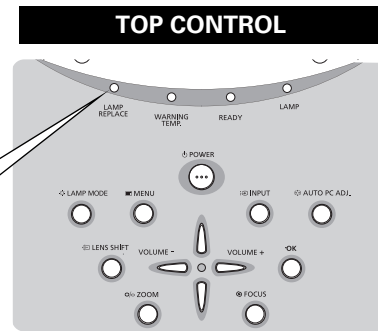

## CAUTION

Allow the projector to cool for at least 45 minutes before you open the lamp cover. The inside of the projector can become very hot.



## CAUTION

For continued safety, replace with a lamp assembly of the same type. Do not drop the lamp assembly or touch a glass bulb! The glass can shatter and may cause injury.

Follow these steps to replace lamp assembly.

- 1** Turn off the projector and unplug the AC power cord. Allow the projector to cool for at least 45 minutes.
- 2** Loosen the two (2) screws with a screwdriver and open the lamp cover.
- 3** Loosen the two (2) screws with a screwdriver and pull out the lamp assembly by using the built in handle.
- 4** Replace the lamp assembly with a new one and tighten the two (2) screws. Make sure that the lamp assembly is set properly. Put back the lamp cover and tighten the two (2) screws.
- 5** Connect the AC power cord to the projector and turn on the projector.
- 6** Reset the Lamp replacement counter (refer to "LAMP REPLACE COUNTER" on the next page).

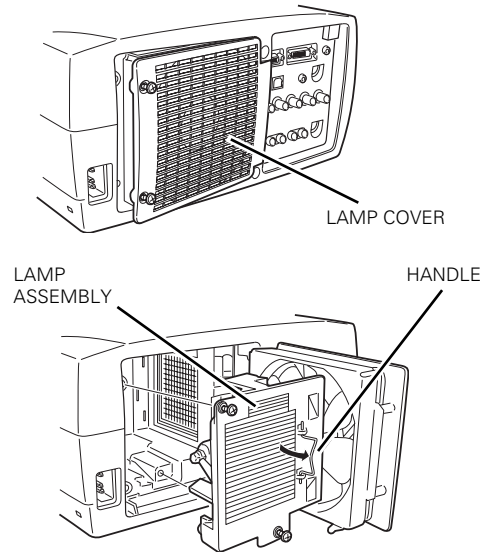

**NOTE:**

- Do not reset the Lamp replacement counter when the projection lamp is not replaced.

### ORDER REPLACEMENT LAMP

Replacement lamp can be ordered through your dealer. When ordering a projection lamp, give the following information to the dealer.

- **Model No. of your projector** : **LV-7575**
- **Replacement Lamp Type No.** : **LV-LP28**

(610 328 7362)

## LAMP REPLACE COUNTER

Be sure to reset the Lamp replacement counter after the lamp assembly is replaced. When the Lamp replacement counter is reset, the LAMP REPLACE indicator stops lighting.

- 1 Turn the projector on and press the MENU button to display the On-Screen Menu. Press the POINT LEFT/RIGHT buttons to move the red frame pointer to the SETTING Menu icon
- 2 Press the POINT UP/DOWN buttons to move the red frame pointer to Lamp counter and then press the OK button. The next box appears.
- 3 Press the POINT UP/DOWN buttons to select Reset and then press the OK button. The "Lamp replacement counter reset?" appears. Move the pointer to [Yes] and then press the OK button.
- 4 Another confirmation dialog box appears and select [Yes] to reset the Lamp replacement counter.

**NOTE:**

- Do not reset the Lamp replacement counter until after the projection lamp is replaced.

### Lamp counter

The screenshots show the following steps:

- The main menu with 'Lamp counter' selected.
- A box showing '100 Hour(s)' and a 'Reset' button.
- A confirmation box asking 'Lamp replacement counter Reset?' with 'Yes' and 'No' options.
- A final confirmation box asking 'OK?' with 'Yes' and 'No' options.

Select Lamp counter and this box appears. Select [Reset], and the next box appears.

Select [Yes], and then another confirmation box appears.

Select [Yes] again to reset the lamp counter.



## LAMP HANDLING PRECAUTIONS

This projector uses a high-pressure lamp which must be handled carefully and properly. Improper handling may result in accidents, injury, or create a fire hazard.

- Lamp lifetime may differ from lamp to lamp and according to the environment of use. There is no guarantee of the same lifetime for each lamp. Some lamps may fail or terminate their lifetime in a shorter period of time than other similar lamps.
- If the projector indicates that the lamp should be replaced, i.e., if the LAMP REPLACE indicator lights up, replace the lamp with a new one IMMEDIATELY after the projector has cooled down. (Follow carefully the instructions in the LAMP REPLACEMENT section of this manual.) Continuous use of the lamp with the LAMP REPLACE indicator lighted may increase the risk of lamp explosion.
- Lamp may explode as a result of vibration, shock or degradation as a result of hours of use as its lifetime draws to an end. Risk of explosion may differ according to the environment or conditions in which the projector and lamp are being used.

### IF A LAMP EXPLODES, THE FOLLOWING SAFETY PRECAUTIONS SHOULD BE TAKEN.

If a lamp explodes, disconnect the projector's AC plug from the AC outlet immediately and open the window or door for ventilation. Contact an authorized service station for a checkup of the unit and replacement of the lamp. Additionally, check carefully to ensure that there are no broken shards or pieces of glass around the projector or coming out from the cooling air circulation holes. Any broken shards found should be cleaned up carefully. No one should check the inside of the projector except those who are authorized trained technicians and who are familiar with projector service. Inappropriate attempts to service the unit by anyone, especially those who are not appropriately trained to do so, may result in an accident or injury caused by pieces of broken glass.

## TROUBLESHOOTING

Before calling your dealer or service center for assistance, check the items below once again.

1. Make sure you have connected the projector to your computer or video equipment as described in "CONNECTING PROJECTOR" on pages 12–14.
2. Check the cable connection. Make sure that all computers, video equipment, and power cords are properly connected.
3. Make sure that all power is switched on.
4. If the projector still does not produce an image, restart your computer.
5. If an image still does not appear, disconnect the projector from your computer and check your computer monitor's display. A problem may be noticed with your graphics controller rather than with the projector. (When you reconnect the projector, be sure to turn the computer and monitor off before you turn on the projector. Turn on equipment in the order of the projector and computer.)
6. If a problem still persists, check the following solutions.

Problem:	Try these Solutions
<b>No power.</b>	<ul style="list-style-type: none"> <li>● Plug the power cord of the projector into an AC outlet.</li> <li>● Make sure the READY indicator lights.</li> <li>● Wait 90 seconds after the projector is turned off to restart the projector.</li> </ul> <p>NOTE: After pressing the POWER button to "OFF," make sure the projector works as follows:</p> <ol style="list-style-type: none"> <li>1. LAMP indicator lights bright and the READY indicator turns off.</li> <li>2. After 90 seconds, the READY indicator lights green again and the projector may be turned on by pressing the POWER button.</li> </ol> <ul style="list-style-type: none"> <li>● Check the WARNING TEMP. and READY indicators. If both indicators blink, the projector cannot be turned on. (See "TURNING ON/OFF PROJECTOR" on pages 20–21.)</li> <li>● Check the projection lamp. (See page 48.)</li> </ul>
<b>Image is out of focus.</b>	<ul style="list-style-type: none"> <li>● Adjust the focus of the projector.</li> <li>● Make sure the projection screen is at least 1.4 m (4.6') away from the projector.</li> <li>● Check the projection lens to see if it needs cleaning.</li> </ul> <p>NOTE: Moving the projector from a cool to a warm place may result in moisture condensation on the projection lens. If this happens, leave the projector off and wait until condensation evaporates.</p>
<b>Picture is left/right reversed.</b>	<ul style="list-style-type: none"> <li>● Check the Ceiling/Rear function. (See page 40.)</li> </ul>
<b>Picture is top/bottom reversed.</b>	<ul style="list-style-type: none"> <li>● Check the Ceiling function. (See page 40.)</li> </ul>
<b>Some displays are not seen during operations.</b>	<ul style="list-style-type: none"> <li>● Check the Display function.(See page 38.)</li> </ul>
<b>No image.</b>	<ul style="list-style-type: none"> <li>● Check the connection between your computer or video equipment and the projector.</li> <li>● When turning the projector on, it takes about 30 seconds to display the image.</li> <li>● Check the system you selected is corresponding to your computer or video equipment.</li> <li>● Make sure the temperature is not out of specified operating temperature (5°C–35°C [41°F–95°F]).</li> </ul>
<b>No sound.</b>	<ul style="list-style-type: none"> <li>● Check the audio cable connection from an audio input source.</li> <li>● Adjust the audio source.</li> <li>● Press the VOLUME (+) button.</li> <li>● Press the MUTE button.</li> </ul>

Problem:	Try these Solutions
<b>Remote control unit does not work.</b>	<ul style="list-style-type: none"> <li>● Check the batteries.</li> <li>● Check if the ALL-OFF switch on the remote control unit is set to "ON."</li> <li>● Make sure there is no obstruction in between the Infrared remote receiver of the projector and the remote control unit.</li> <li>● Make sure you are not too far from the projector when using the remote control unit. Maximum operating range is 5 m (16.4').</li> <li>● Check the remote control code in the remote control unit. (See page 41.)</li> <li>● Check if the remote control keys are locked. (See page 42.)</li> </ul>
<b>Wireless mouse function does not work.</b>	<ul style="list-style-type: none"> <li>● Check the cable connection between the projector and your computer.</li> <li>● Check the mouse setting on your computer.</li> <li>● Turn the projector on before turning on a computer.</li> </ul>

**WARNING:**

**High voltages are used to operate this projector. Do not attempt to open the cabinet.**

If the problem still persists after following all operating instructions, contact the sales dealer where you purchased the projector or the service center. Specify the model number and explain the difficulty. We will advise you how to obtain service.

MENU TREE

Computer Input/Video Input

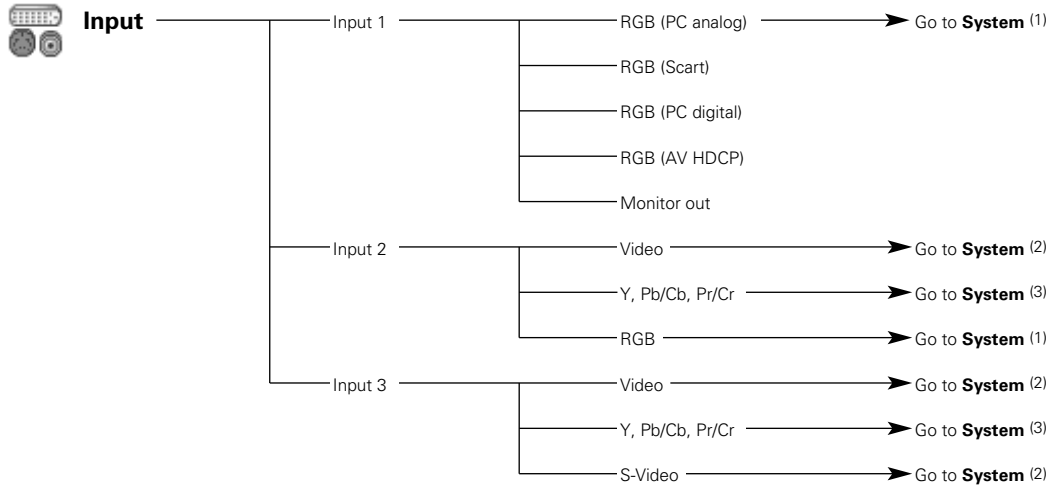

Computer Input

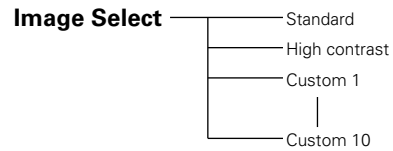
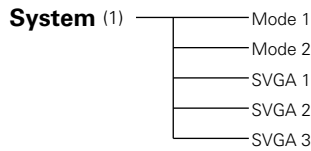
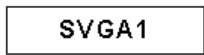

\* System displayed in the System Menu varies depending on the input signal.

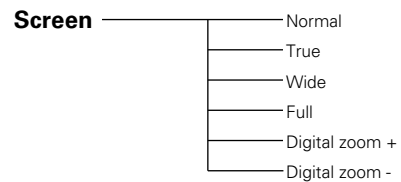
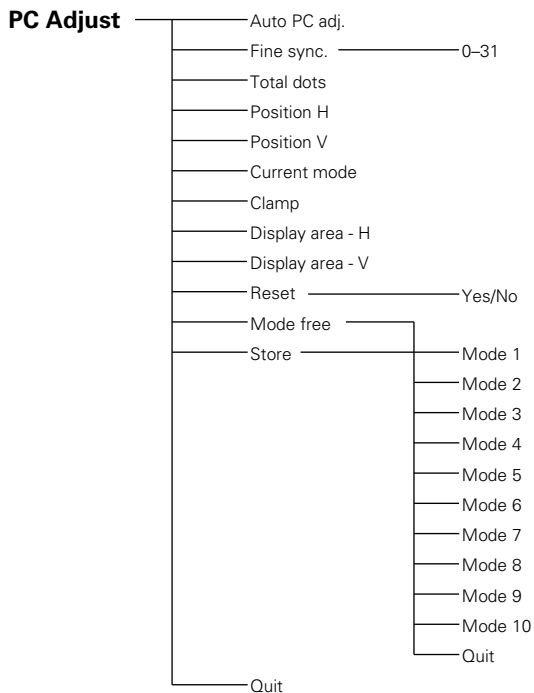

## Video Input

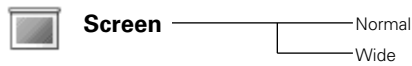
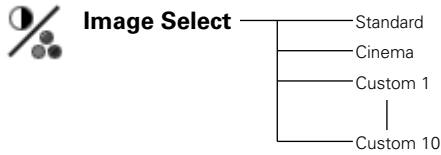
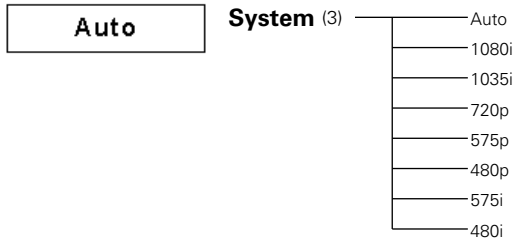
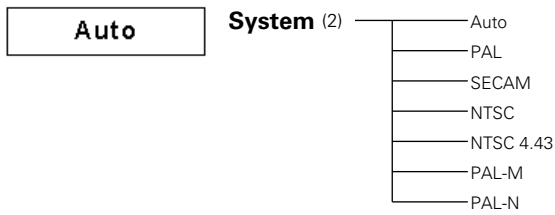

## Computer Input/Vide Input

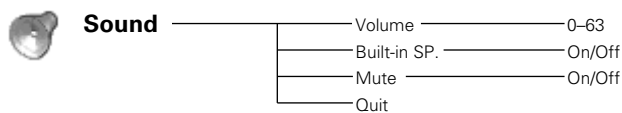
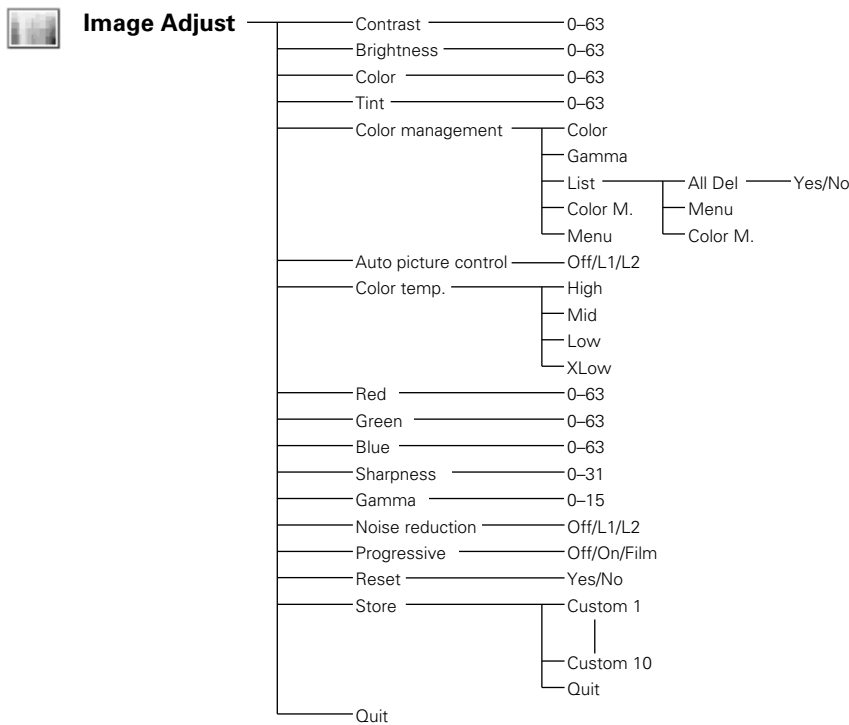

Computer Input/Vide Input



Setting

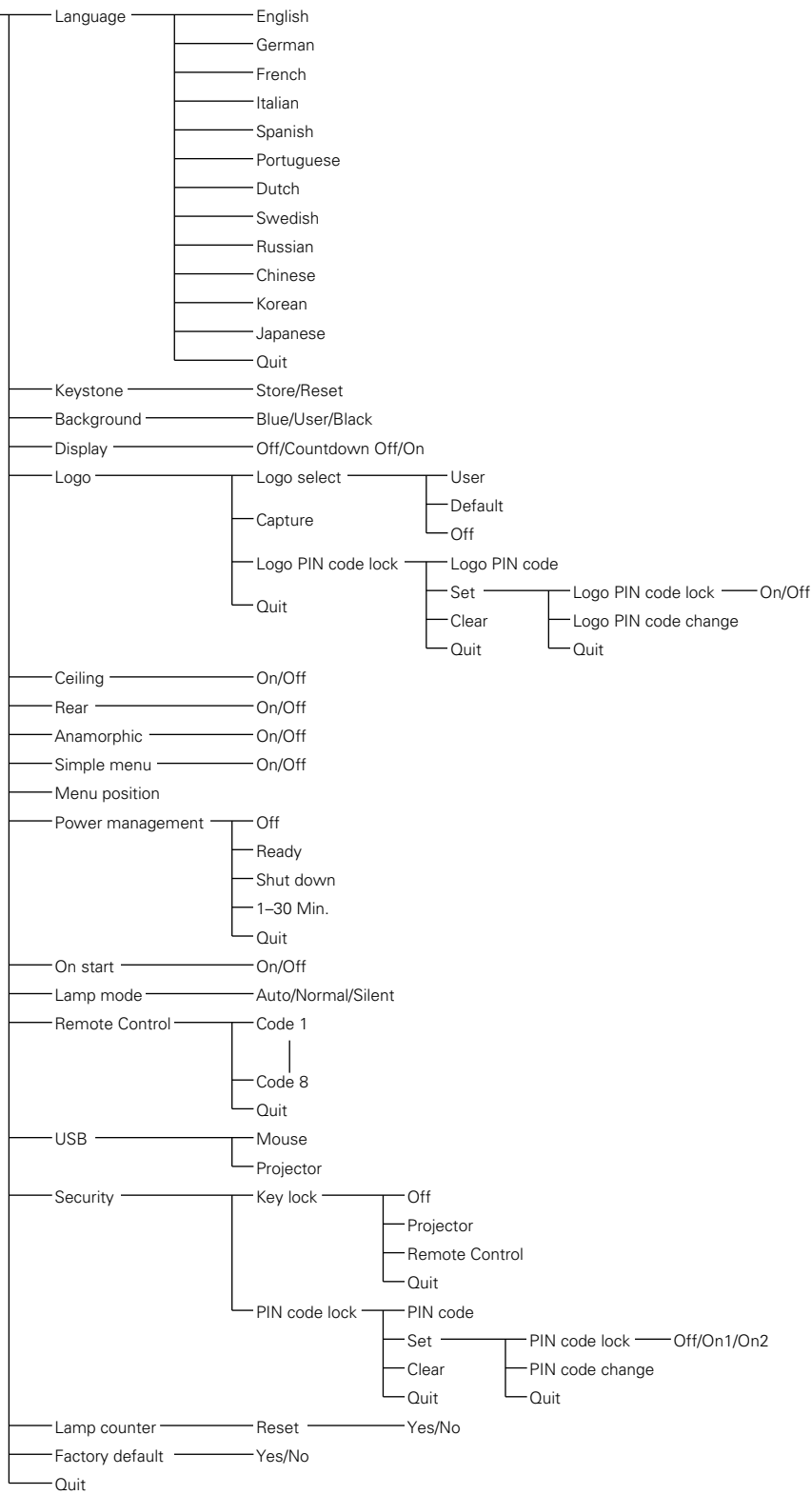

## COMPATIBLE COMPUTER SPECIFICATIONS

Basically this projector can accept a signal from all computers with V-, H-Frequency mentioned below, and less than 140 MHz of Dot Clock.

ON-SCREEN DISPLAY	RESOLUTION	H-Freq. (kHz)	V-Freq. (Hz)	ON-SCREEN DISPLAY	RESOLUTION	H-Freq. (kHz)	V-Freq. (Hz)
VGA 1	640 x 480	31.47	59.88	MAC 21	1152 x 870	68.68	75.06
VGA 2	720 x 400	31.47	70.09	SXGA 1	1152 x 864	64.20	70.40
VGA 3	640 x 400	31.47	70.09	SXGA 2	1280 x 1024	62.50	58.60
VGA 4	640 x 480	37.86	74.38	SXGA 3	1280 x 1024	63.90	60.00
VGA 5	640 x 480	37.86	72.81	SXGA 4	1280 x 1024	63.34	59.98
VGA 6	640 x 480	37.50	75.00	SXGA 5	1280 x 1024	63.74	60.01
VGA 7	640 x 480	43.269	85.00	SXGA 6	1280 x 1024	71.69	67.19
MAC LC13	640 x 480	34.97	66.60	SXGA 7	1280 x 1024	81.13	76.107
MAC 13	640 x 480	35.00	66.67	SXGA 8	1280 x 1024	63.98	60.02
480i	(Interlace)	15.734	60.00	SXGA 9	1280 x 1024	79.976	75.025
575i	(Interlace)	15.625	50.00	SXGA 10	1280 x 960	60.00	60.00
480p	(Progressive)	31.47	59.88	SXGA 11	1152 x 900	61.20	65.20
575p	(Progressive)	31.25	50.00	SXGA 12	1152 x 900	71.40	75.60
SVGA 1	800 x 600	35.156	56.25	SXGA 13	1280 x 1024 (Interlace)	50.00	86.00
SVGA 2	800 x 600	37.88	60.32	SXGA 14	1280 x 1024 (Interlace)	50.00	94.00
SVGA 3	800 x 600	46.875	75.00	SXGA 15	1280 x 1024	63.37	60.01
SVGA 4	800 x 600	53.674	85.06	SXGA 16	1280 x 1024	76.97	72.00
SVGA 5	800 x 600	48.08	72.19	SXGA 17	1152 x 900	61.85	66.00
SVGA 6	800 x 600	37.90	61.03	SXGA 18	1280 x 1024 (Interlace)	46.43	86.70
SVGA 7	800 x 600	34.50	55.38	SXGA 19	1280 x 1024	63.79	60.18
SVGA 8	800 x 600	38.00	60.51	SXGA 20	1280 x 1024	91.146	85.024
SVGA 9	800 x 600	38.60	60.31	SXGA+ 1	1400 x 1050	63.97	60.19
SVGA 10	800 x 600	32.70	51.09	SXGA+ 2	1400 x 1050	65.35	60.12
SVGA 11	800 x 600	38.00	60.51	SXGA+ 3	1400 x 1050	65.12	59.90
MAC 16	832 x 624	49.72	74.55	MAC	1280 x 960	75.00	75.08
XGA 1	1024 x 768	48.36	60.00	MAC	1280 x 1024	80.00	75.08
XGA 2	1024 x 768	68.677	84.997	WXGA 1	1366 x 768	48.36	60.00
XGA 3	1024 x 768	60.023	75.03	WXGA 2	1360 x 768	47.70	60.00
XGA 4	1024 x 768	56.476	70.07	WXGA 3	1376 x 768	48.36	60.00
XGA 5	1024 x 768	60.31	74.92	WXGA 4	1360 x 768	56.16	72.00
XGA 6	1024 x 768	48.50	60.02	UXGA1	1600 x 1200	75.00	60.00
XGA 7	1024 x 768	44.00	54.58	UXGA2	1600 x 1200	81.25	65.00
XGA 8	1024 x 768	63.48	79.35	UXGA3	1600 x 1200	87.50	70.00
XGA 9	1024 x 768 (Interlace)	36.00	87.17	UXGA4	1600 x 1200	93.75	75.00
XGA 10	1024 x 768	62.04	77.07	720p	(Progressive)	45.00	60.00
XGA 11	1024 x 768	61.00	75.70	720p	(Progressive)	37.50	50.00
XGA 12	1024 x 768 (Interlace)	35.522	86.96	1035i	(Interlace)	33.75	60.00
XGA 13	1024 x 768	46.90	58.20	1080i	(Interlace)	33.75	60.00
XGA 14	1024 x 768	47.00	58.30	1080i	(Interlace)	28.125	50.00
XGA15	1024 x 768	58.03	72.00				
MAC 19	1024 x 768	60.24	75.08				



# APPENDIX

When a input signal is digital from DVI terminal, refer to the chart below.

ON-SCREEN DISPLAY	RESOLUTION	H-Freq. (kHz)	V-Freq. (Hz)		ON-SCREEN DISPLAY	RESOLUTION	H-Freq. (kHz)	V-Freq. (Hz)
D-VGA	640 x 480	31.47	59.94	*	D-SXGA2	1280 x 1024	60.276	58.069
D-480p	720 x 480 (Progressive)	31.47	59.88	*	D-SXGA+ 1	1400 x 1050	63.97	60.19
D-575p	768 x 575 (Progressive)	31.25	50.00		D-720p	1280 x 720 (Progressive)	45.00	60.00
D-SVGA	800 x 600	37.879	60.32		D-720p	1280 x 720 (Progressive)	37.50	50.00
D-XGA	1024 x 768	43.363	60.00		D-1035i	1920 x 1035 (Interlace)	33.75	60.00
D-WXGA1	1366 x 768	48.36	60.00		D-1080i	1920 x 1080 (Interlace)	33.75	60.00
D-WXGA2	1360 x 768	47.70	60.00		D-1080i	1920 x 1080 (Interlace)	28.125	50.00
D-WXGA3	1376 x 768	48.36	60.00		D-1080psf/30	1920 x 1080	33.75	60.00
D-WXGA5	1368 x 768	46.50	50.00		D-1080psf/25	1920 x 1080	28.125	50.00
* D-SXGA1	1280 x 1024	63.98	60.02		D-1080psf/24	1920 x 1080	27.00	48.00

\* Depending on the condition of signals and the type and length of cables, these signals may not be properly viewed.

**NOTE:** Specifications are subject to change without notice.

## INDICATORS AND PROJECTOR CONDITION

Check the indicators for projector condition.

Indicators				Projector Condition
LAMP REPLACE orange	WARNING TEMP. red	READY green	LAMP red	
●	●	●	●	The projector is OFF. (The AC power cord is unplugged.)
*	●	○	○	The projector is ready to be turned on with the POWER button.
*	●	○	●	The projector is operating normally.
*	⚡	●	○	The Warning Temp. indicator blinks red to let you know the internal temperature of the projector exceeds a normal level. If the temperature goes up further, the projector will be turned off automatically and the Ready indicator goes out. When the projector is cooled down enough and the temperature returns to normal, the READY indicator lights green and the projector can be turned on again. (The WARNING TEMP. indicator keeps blinking.) Check and clean the air filters.
*	⚡	○	○	The projector is cooled down enough and the temperature returns to normal. When turning on the projector, the WARNING TEMP. indicator stops blinking. Check and clean the air filters.

○ ●●● on    ⚡ ●●● blinking    ● ●●● dim    ● ●●● off

Indicators				Projector Condition
LAMP REPLACE orange	WARNING TEMP. red	READY green	LAMP red	
*	●	●	○	The projector is in cooling mode. It cannot be turned on until the READY indicator lights green.
○ <sup>⚡</sup>	○ <sup>⚡</sup>	○ <sup>⚡</sup>	○	The projector detects an abnormal condition and cannot be turned on. Unplug the AC power cord and plug it again to turn on the projector. If the projector is turned off again, disconnect the AC power cord and contact the dealer or the service center for service and checkup. Do not leave the projector on. It may cause electric shock or a fire hazard.
*	●	○ <sup>⚡</sup>	●	The projector is in the Power management mode.
*	○ <sup>⚡</sup>	○	●	The temperature inside the projector is abnormally high.
○ <sup>⚡</sup>	●	●	○	The lamp cannot light up. (The projector is preparing for stand-by or the projection lamp is in cooling mode. The projector cannot be turned on until the cooling process is completed.)
○ <sup>⚡</sup>	●	○	○	The lamp cannot light up. (The lamp has been cooled down enough and the projector is in stand-by mode and ready to be turned on with the POWER button.)
○	*	●	●	The projection lamp reaches its end of life. Replace the lamp and then reset the Lamp replacement counter. The indicator is turned off.

○ ●●● on    ○<sup>⚡</sup> ●●● blinking    ● ●●● dim    ● ●●● off

\*When the projection lamp reaches its end of life, the LAMP REPLACE indicator lights orange. When this indicator lights orange, replace the projection lamp with a new one promptly. Reset the Lamp replacement counter after replacing the lamp.

## TECHNICAL SPECIFICATIONS

<b>Projector Type</b>	Multi-media Projector
<b>Dimensions (W x H x D)</b>	319.0 mm x 168.0 mm x 429.5 mm (12.6" x 6.61" x 16.8")
<b>Net Weight</b>	8.7 kg (19.2 lbs)
<b>LCD Panel System</b>	1.3" TFT Active Matrix type, 3 panels
<b>Panel Resolution</b>	1024 x 768 dots
<b>Number of Pixels</b>	2,359,296 (1024 x 768 x 3 panels)
<b>Color System</b>	PAL, SECAM, NTSC, NTSC4.43, PAL-M, and PAL-N
<b>High Definition TV Signal</b>	480i, 480p, 575i, 575p, 720p, 1035i, and 1080i
<b>Scanning Frequency</b>	H-sync. 15 kHz–100 kHz, V-sync. 48–100 Hz
<b>Projection Lens</b>	F1.8–2.1 lens with f=48.4 mm–62.8 mm Motor zoom and focus
<b>Throw distance</b>	1.4 m (4.6')–14.7 m (48.2')
<b>Motorized Lens Shift</b>	Up and Down (1:1 to 10:0)
<b>Projection Image Size (Diagonal)</b>	Adjustable from 31" to 400"
<b>Horizontal Resolution</b>	800 TV lines (HDTV)
<b>Projection Lamp</b>	318 watt type
<b>Input 1 Jacks</b>	DVI Terminal (Digital) HDCP Compatible, HDB 15-pin Terminal (Analog), and Stereo Mini Type Jack (Audio)
<b>Input 2 Jacks</b>	BNC Type x 5 (G or VIDEO/Y, B or Cb/Pb, R or Cr/Pr, H/V, and V) and Stereo Mini Type Jack (Audio)
<b>Input 3 Jacks</b>	RCA Type x 3 (VIDEO/Y, Cb/Pb and Cr/Pr), RCA Type x 2 (Audio R and L), and DIN 4-pin (S-Video)
<b>Other Jacks</b>	DIN 8-pin (Control port), USB port (Series B receptacle), Wired Remote Jack , and Network Imager Connector
<b>Built-in Speakers</b>	INT. SP. Stereo (R and L), 3 watt RMS (T.H.D. 10%)
<b>Feet Adjustment</b>	0° to 10.5°
<b>Voltage and Power Consumption</b>	AC 100–120 V (5.7 A Max. Ampere), 50/60 Hz (The U.S.A and Canada) AC 200–240 V (2.7 A Max. Ampere), 50/60 Hz (Continental Europe)
<b>Operating Temperature</b>	5°C–35°C (41°F ~ 95°F)
<b>Storage Temperature</b>	-10°C–60°C (14°F ~ 140°F)
<b>Remote Control Transmitter</b>	Power Source : AA or LR6 ALKALINE Type x 2 Operating Range : 5 m (16.4')/±30° Dimensions : 50 mm x 36 mm x 193 mm (2.0" x 1.4" x 7.6") Net Weight : 160 g (0.35 lbs) (including batteries) Laser Pointer : Class II Laser (Max. Output: 1mW/Wave length: 650±20nm)
<b>Accessories</b>	User's Manual (CD-ROM) Quick Start Guide AC Power Cord Wireless/Wired Remote Control Transmitter and Batteries VGA Cable USB Cable Control Cable for Serial Port Lens Cap Lens Replacement And Installation Manual PIN Code Label Warranty Card

- Specifications are subject to change without notice.
- LCD panels are manufactured to the highest possible standards. Even though 99.99% of the pixels are effective, a tiny fraction of the pixels (0.01% or less) may be ineffective by the characteristics of the LCD panels.
- Each projector has its own characteristics.  
When projecting with several projectors on the same screen or side by side, you may recognize different white balance and color uniformity on each projector.

## CONFIGURATIONS OF TERMINALS

### COMPUTER INPUT-1 TERMINALS (ANALOG)

Terminal: HDB15-PIN

**Pin Configuration**

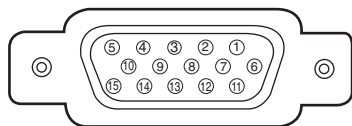

1	Red Input	9	+5V Power
2	Green Input	10	Ground (Vert. sync.)
3	Blue Input	11	Sense 0
4	Sense 2	12	DDC Data
5	Ground (Horiz.sync.)	13	Horiz. sync.
6	Ground (Red)	14	Vert. sync.
7	Ground (Green)	15	DDC Clock
8	Ground (Blue)		

### COMPUTER INPUT-1 TERMINAL (DIGITAL)

Terminal: DVI 24-pin

**Pin Configuration**

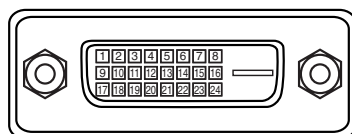

1	T.M.D.S. Data2-	9	T.M.D.S. Data1-	17	T.M.D.S. Data0-
2	T.M.D.S. Data2+	10	T.M.D.S. Data1+	18	T.M.D.S. Data0+
3	T.M.D.S. Data2 Shield	11	T.M.D.S. Data1 Shield	19	T.M.D.S. Data0 Shield
4	No Connect	12	No Connect	20	No Connect
5	No Connect	13	No Connect	21	No Connect
6	DDC Clock	14	+5V Power	22	T.M.D.S. Clock Shield
7	DDC Data	15	Ground (for +5V)	23	T.M.D.S. Clock+
8	No Connect	16	Hot Plug Detect	24	T.M.D.S. Clock-

### CONTROL PORT CONNECTOR

Terminal: Mini DIN 8-PIN

**Pin Configuration**

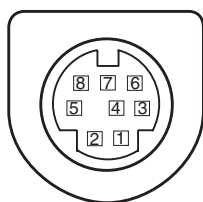

	PS/2	Serial	ADB
1	----	R X D	----
2	CLK	----	ADB
3	DATA	----	----
4	GND	GND	GND
5	----	RTS/CTS	----
6	----	T X D	----
7	GND	GND	----
8	----	GND	GND

### USB CONNECTOR (Series B)

**Pin Configuration**

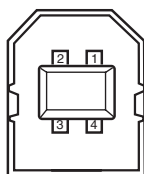

1	Vcc
2	- Data
3	+ Data
4	Ground

## OPTIONAL PARTS

The parts listed below are optionally supplied. When ordering those parts, specify the item name and its Type No. to the sales dealer.

- **HDB 15 pin-SCART 21 pin Cable**      **Type No. : LV-CA31**
- **Ultra Wide Angle Lens**                      **Type No. : LV-IL01**
- **Wide Angle Zoom Lens**                      **Type No. : LV-IL02**
- **Long Focus Zoom Lens**                      **Type No. : LV-IL03**
- **Ultra Long Focus Zoom Lens**              **Type No. : LV-IL04**
- **Network Imager**                                  **Type No. : LV-NI02**
- **Replacement Lamp**                              **Type No. : LV-LP28**
- **Ceiling Mounting Hanger**                      **Type No. : LV-CL07**

## LENS REPLACEMENT

The lens of this projector can be replaced with other optional lens. This feature enables you to use the projector for wide variety of uses.

For installation and replacement of the lens, always contact the sales dealer. The projector lens must be installed or replaced by well-trained sales or service engineers. Do not attempt to install and replace the lens by yourself as it may cause injury.



After installing the lens, attach the lens cap to the lens when setting up the projector.  
Do not hold the lens when carrying or lifting the projector. It may cause serious damage to the projector.

### To the sales and service engineers:

Referring to the attached lens replacement and installation manual, replace or install the lens properly.

## PJ LINK NOTICE

This projector is compliant with PJLink Standard Class 1 of JBMIA (Japan Business Machine and Information System Industries Association). The projector supports all commands defined by PJLink Class 1 and is verified conformance with PJLink Standard Class 1.

CANON Projector Input	PJLink Input	Parameter	
Input1	RGB(PC analog)	RGB 1	11
	RGB(Scart)	RGB 2	12
	RGB(PC digital)	DIGITAL 1	31
	RGB(AV HDCP)	DIGITAL 2	32
Input2	Video	VIDEO 1	21
	Y, Pb/Cb, Pr/Cr	VIDEO 2	22
	RGB	RGB 3	13
Input3	Video	VIDEO 3	23
	Y, Pb/Cb, Pr/Cr	VIDEO 4	24
	S-video	VIDEO 5	25

PJLink is a registered trademark of JBMIA.



DIMENSIONS

Unit : mm (inch)

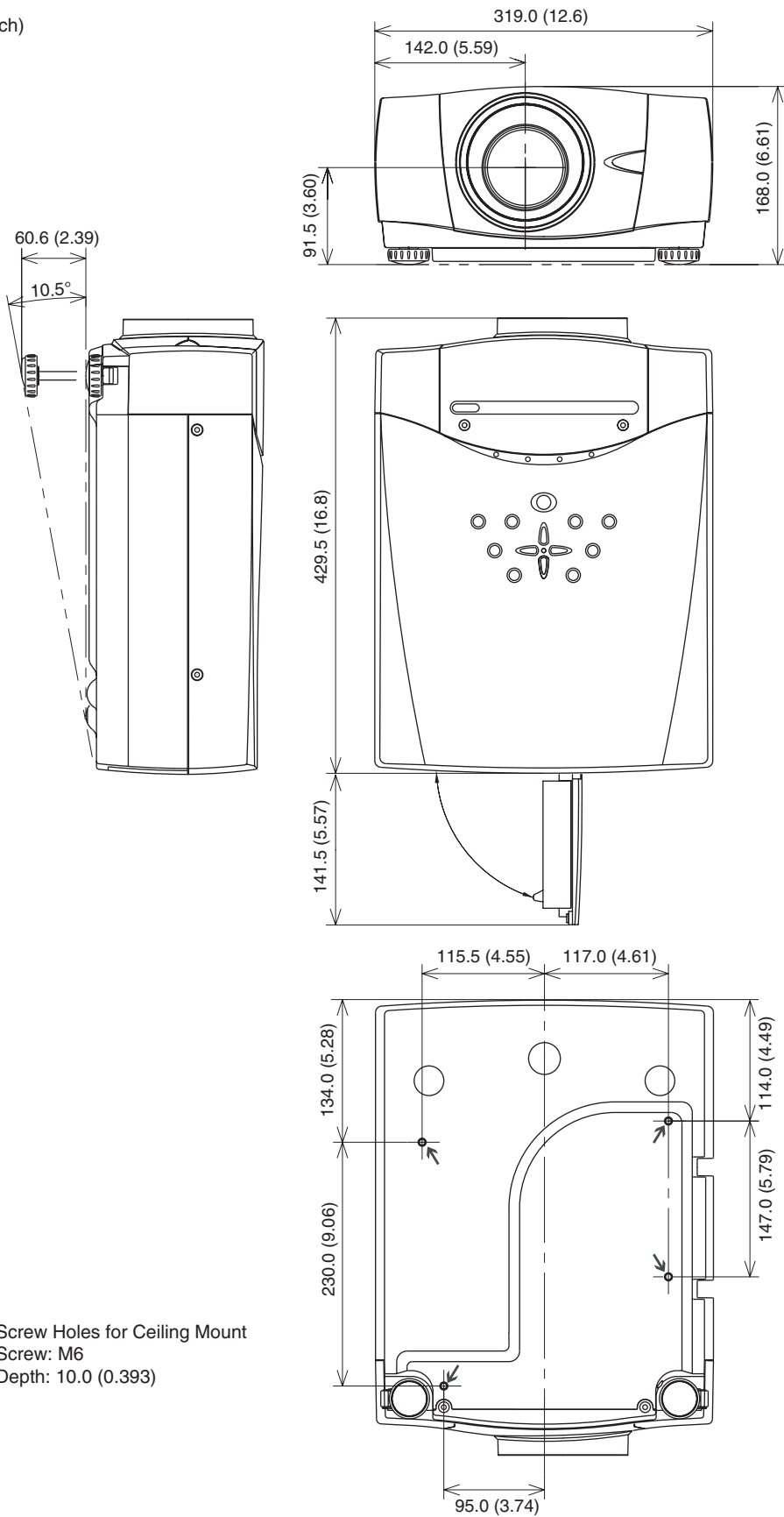

↙  
 Screw Holes for Ceiling Mount  
 Screw: M6  
 Depth: 10.0 (0.393)

## APPENDIX

### ***While the projector is locked with the PIN code....***

Put on the label below (supplied) in a prominent place of the projector's body while it is locked with a PIN code.

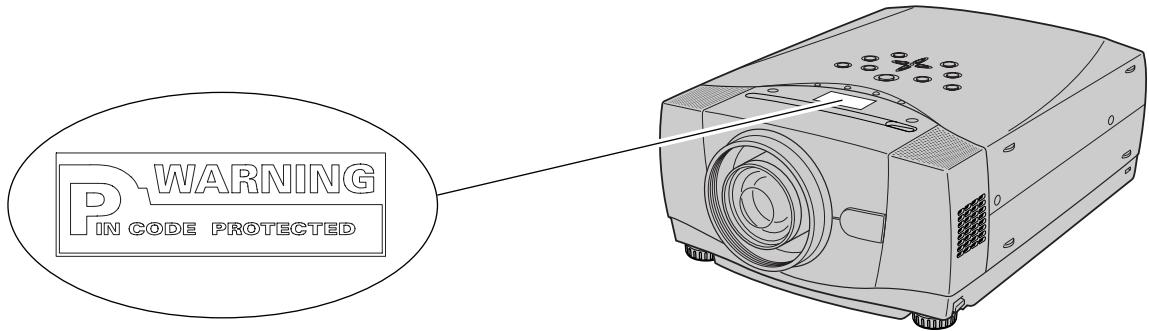

**CANON INC.**

30-2, Shimomaruko 3-chome, Ohta-ku,  
Tokyo 146-8501, Japan

**CANON U.S.A., INC.**

One Canon Plaza, Lake Success, NY 11042,  
U.S.A.

**CANON CANADA, INC.**

6390 Dixie Road Mississauga, Ontario L5T  
1P7 Canada

**CANON LATIN AMERICA, INC.**

703 Waterford Way Suite 400 Miami, Florida  
33126 U.S.A.

**CANON MEXICANA, S. de R.L. de C.V.**

Boulevard Manuel Avila Camacho, No. 138  
PB, Pisos 15, 16 y 17 Col. Lomas de  
Chapultepec, CP 11000, Mexico D.F., Mexico

**CANON EUROPA N.V.**

P.O.Box 2262, 1180 EG Amstelveen, The  
Netherlands

**CANON COMMUNICATION & IMAGE****FRANCE S.A.**

12 Rue De L'Industrie, 92414 Corbevoie,  
Cedex, France

**CANON (UK) LTD.**

Woodhatch, Reigate, Surrey RH2 8BF,  
United Kingdom

**CANON DEUTSCHLAND GmbH**

Europark Fichtenhain A 10, 47807 Krefeld,  
Germany

**CANON ITALIA S.p.A.**

Via Milano, 8 San Donato M. se-20097 (MI),  
Italy

**CANON (Schweiz) A.G.**

Industriestrasse 12, 8305 Dietlikon,  
Switzerland

**CANON BELGIUM N.V./S.A**

Bessenveldstraat 7, 1831 Diegem, Belgium

**CANON GmbH**

Zetschegasse 11, A-1230 Wien, Austria

**CANON ESPANA S.A.**

C/Joaquin Costa 41, 28002 Madrid, Spain

**CANON SVENSKA AB**

Gustav III:s, Boulevard 26, 169 88 Solna,  
Sweden

**CANON NORGE A/S**

Hallagerbakken 110, P.O. Box 33, Holmlia,  
N-1201 Oslo, Norway

**CANON OY**

Huopalahdentie 24, P.O. Box 1, FIN-00351  
Helsinki, Finland

**CANON HONGKONG CO., LTD.**

19/F., The Metropolis Tower, 10 Metropolis  
Drive, Hunghom, Kln., H.K.

**CANON SINGAPORE PTE. LTD.**

1 HarbourFront Avenue #04-01, Keppel Bay  
Tower Singapore 098632

**CANON AUSTRALIA PTY. LTD.**

1 Thomas Holt Drive, North Ryde, Sydney,  
N.S.W.2113, Australia

**CANON NEW ZEALAND LTD.**

Akoranga Business Park, Akoranga Drive,  
Northcote, Auckland, New Zealand

**CANON DANMARK A/S**

Knud Hoejgaards Vej 1, DK-2860 Soeborg,  
Denmark