

myprojectorlamps.com

**The most trusted, dependable name
in projector lamp sales.**



<http://www.myprojectorlamps.com>



<http://www.myprojectorlamps.ca>



<http://www.myprojectorlamps.eu>

The following projector manual has not been modified or altered in any way.

Canon

Multimedia Projector

LV-5200

Owner's Manual



E
English

TO THE OWNER

Before operating this projector, read this manual thoroughly to operate the projector properly. This projector provides many convenient features and functions. Operating the projector properly enables you to manage those features and maintain it in better condition for a considerable time. Improper operation may result in not only shortening the product-life, but also malfunctions, fire hazard, or other accidents. If your projector seems to operate improperly, read this manual again, check operations and cable connections and try the solutions in the "TROUBLESHOOTING" section in the end at this manual. If the problem still persists, contact the sales dealer where you purchased the projector or the service center.



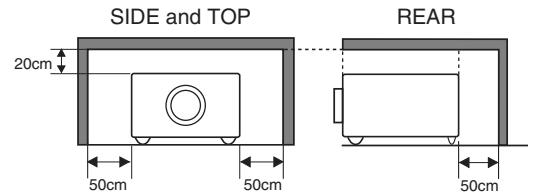

SAFETY PRECAUTIONS

WARNING : TO REDUCE THE RISK OF FIRE OR ELECTRIC SHOCK, DO NOT EXPOSE THIS APPLIANCE TO RAIN OR MOISTURE.

- This projector produces an intensive light from the projection lens. Do not look directly into the lens; it may damage your eyes. Be especially careful that children do not look directly into the beam.
- This projector should be set in the way indicated. If not, it may result in fire hazard.
- Provide appropriate space on the top, sides and rear of the projector cabinet for allowing air circulation and cooling the projector. Minimum clearance must be maintained. If the projector is to be built into a compartment or similarly enclosed, the minimum distances must be maintained. Do not cover the ventilation slot on the projector. Heat build-up can reduce the service life of your projector, and can also be dangerous.
- Do not put any flammable objects or spray cans near the projector, hot air is exhausted from the ventilation holes.
- The Remote Control Unit, supplied with this projector, emits a laser beam as the laser pointer function from the Laser Light Window while pressing the LASER button (for 1 minute / LASER POINTER INDICATOR lights red to indicate laser emission). To reduce the risk of injury, do not look into the Laser Light Window nor shine the laser beam on yourself or other people.
- If the projector is not to be used for an extended period of time, unplug the projector from the AC outlet.



READ AND KEEP THIS OWNER'S MANUAL FOR LATER USE.

	CAUTION RISK OF ELECTRIC SHOCK DO NOT OPEN	
CAUTION : TO REDUCE THE RISK OF ELECTRIC SHOCK, DO NOT REMOVE COVER (OR BACK). NO USER-SERVICEABLE PARTS INSIDE EXCEPT LAMP REPLACEMENT. REFER SERVICING TO QUALIFIED SERVICE PERSONNEL.		
 THIS SYMBOL INDICATES THAT DANGEROUS VOLTAGE CONSTITUTING A RISK OF ELECTRIC SHOCK IS PRESENT WITHIN THIS UNIT.	 THIS SYMBOL INDICATES THAT THERE ARE IMPORTANT OPERATING AND MAINTENANCE INSTRUCTIONS IN THE OWNER'S MANUAL WITH THIS UNIT.	

SAFETY INSTRUCTIONS

All the safety and operating instructions should be read before the product is operated.

Read all of the instructions given here and retain them for later use. Unplug this projector from AC power supply before cleaning. Do not use liquid or aerosol cleaners. Use a damp cloth for cleaning.

Follow all warnings and instructions marked on the projector.

For added protection to the projector during a lightning storm, or when it is left unattended and unused for long periods of time, unplug it from the wall outlet. This will prevent damage due to lightning and power line surges.

Do not expose this unit to rain or use near water... for example, in a wet basement, near a swimming pool, etc...

Do not use attachments not recommended by the manufacturer as they may cause hazards.

Do not place this projector on an unstable cart, stand, or table. The projector may fall, causing serious injury to a child or adult, and serious damage to the projector. Use only with a cart or stand recommended by the manufacturer, or sold with the projector. Wall or shelf mounting should follow the manufacturer's instructions, and should use a mounting kit approved by the manufacturers.

An appliance and cart combination should be moved with care. Quick stops, excessive force, and uneven surfaces may cause the appliance and cart combination to overturn.



Slots and openings in the back and bottom of the cabinet are provided for ventilation, to insure reliable operation of the equipment and to protect it from overheating.

The openings should never be covered with cloth or other materials, and the bottom opening should not be blocked by placing the projector on a bed, sofa, rug, or other similar surface. This projector should never be placed near or over a radiator or heat register.

This projector should not be placed in a built-in installation such as a book case unless proper ventilation is provided.

Never push objects of any kind into this projector through cabinet slots as they may touch dangerous voltage points or short out parts that could result in fire or electric shock. Never spill liquid of any kind on the projector.

This projector should be operated only from the type of power source indicated on the marking label. If you are not sure of the type of power supplied, consult your authorized dealer or local power company.

Do not overload wall outlets and extension cords as this can result in fire or electric shock. Do not allow anything to rest on the power cord. Do not locate this projector where the cord may be damaged by persons walking on it.

Do not attempt to service this projector yourself as opening or removing covers may expose you to dangerous voltage or other hazards. Refer all servicing to qualified service personnel.

Unplug this projector from wall outlet and refer servicing to qualified service personnel under the following conditions:

- a. When the power cord or plug is damaged or frayed.
- b. If liquid has been spilled into the projector.
- c. If the projector has been exposed to rain or water.
- d. If the projector does not operate normally by following the operating instructions. Adjust only those controls that are covered by the operating instructions as improper adjustment of other controls may result in damage and will often require extensive work by a qualified technician to restore the projector to normal operation.
- e. If the projector has been dropped or the cabinet has been damaged.
- f. When the projector exhibits a distinct change in performance-this indicates a need for service.

When replacement parts are required, be sure the service technician has used replacement parts specified by the manufacturer that have the same characteristics as the original part. Unauthorized substitutions may result in fire, electric shock, or injury to persons.

Upon completion of any service or repairs to this projector, ask the service technician to perform routine safety checks to determine that the projector is in safe operating condition.

Voor de klanten in Nederland



Bij dit product zijn batterijen geleverd. Wanneer deze leeg zijn, moet u ze niet weggooien maar inleveren als KCA.

COMPLIANCES

Federal Communication Commission Notice

Multimedia Projector, Model : LV-5200U, LV-5200E

This device complies with Part 15 of the FCC Rules. Operation is subject to the following two conditions:

- (1) This device may not cause harmful interference, and
- (2) this device must accept any interference received, including interference that may cause undesired operation.

Note : This equipment has been tested and found to comply with the limits for a Class B digital device, pursuant to part 15 of the FCC Rules. These limits are designed to provide reasonable protection against harmful interference in a residential installation. This equipment generates, uses and can radiate radio frequency energy and, if not installed and used in accordance with the instructions, may cause harmful interference to radio communications. However, there is no guarantee that interference will not occur in a particular installation. If this equipment does cause harmful interference to radio or television reception, which can be determined by turning the equipment off and on, the user is encouraged to try to correct the interference by one or more of the following measures :

- Reorient or relocate the receiving antenna.
- Increase the separation between the equipment and receiver.
- Connect the equipment into an outlet on a circuit different from that to which the receiver is connected.
- Consult the dealer or an experienced radio/TV technician for help.

Use of shielded cable is required to comply with class B limits in Subpart B of Part 15 of FCC Rules.

Do not make any changes or modifications to the equipment unless otherwise specified in the instructions. If such changes or modifications should be made, you could be required to stop operation of the equipment.

Canon U.S.A., Inc.

One Canon Plaza, Lake Success, NY 11042, U.S.A.

Tel No. (516)328-5600

For use in Germany

This product is intended for use in residential, commercial and light industry environment.

Canadian Radio Interference Regulations

This Class B digital apparatus meets all requirements of the Canadian Interference-Causing Equipment Regulations.

AC POWER CORD REQUIREMENT

The AC Power Cord supplied with this projector meets the requirement for use in the country you purchased it.

AC Power Cord for the United States and Canada :

AC Power Cord used in the United States and Canada is listed by the Underwriters Laboratories (UL) and certified by the Canadian Standard Association (CSA).

AC Power Cord has a grounding-type AC line plug. This is a safety feature to be sure that the plug will fit into the power outlet. Do not try to defeat this safety feature. Should you be unable to insert the plug into the outlet, contact your electrician.

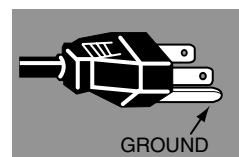

THE SOCKET-OUTLET SHOULD BE INSTALLED NEAR THE EQUIPMENT AND EASILY ACCESSIBLE.

TABLE OF CONTENTS

FEATURES AND DESIGN 6

PREPARATION 7

NOMENCHTOR	7
SETTING-UP THE PROJECTOR	8
CONNECTING AC POWER CORD	8
INSTALLING THE PROJECTOR IN PROPER POSITION	8
POSITIONING THE PROJECTOR	9
ADJUSTABLE FEET	9
MOUNTING THE LENS COVER	10
MOVING THE PROJECTOR	10

CONNECTING THE PROJECTOR 11

TERMINALS OF THE PROJECTOR	11
CONNECTING TO COMPUTER	12
CONNECTING TO VIDEO EQUIPMENT	13

BEFORE OPERATION 14

OPERATION OF THE REMOTE CONTROL UNIT	14
LASER POINTER FUNCTION	14
REMOTE CONTROL UNIT BATTERIES INSTALLATION	15
TOP CONTROLS AND INDICATORS	16
OPERATING THE ON-SCREEN MENU	17
HOW TO OPERATE THE ON-SCREEN MENU	17
FLOW OF ON-SCREEN MENU OPERATION	17
MENU BAR	18

BASIC OPERATION 19

TURNING ON / OFF THE PROJECTOR	19
TURNING ON THE PROJECTOR	19
TURNING OFF THE PROJECTOR	19
ADJUSTING THE SCREEN	20
ZOOM ADJUSTMENT	20
FOCUS ADJUSTMENT	20
KEystone ADJUSTMENT	20
PICTURE FREEZE FUNCTION	20
NO SHOW FUNCTION	21
P-TIMER FUNCTION	21
SOUND ADJUSTMENT	21

COMPUTER INPUT (RGB Scart 21-Pin Video Input) 22

SELECTING THE INPUT SOURCE	22
SELECTING THE COMPUTER SYSTEM	23
COMPATIBLE COMPUTER SPECIFICATIONS	24
PC ADJUSTMENT	25
AUTO PC ADJUSTMENT	25
MANUAL PC ADJUSTMENT	26
PICTURE IMAGE ADJUSTMENT	28
IMAGE LEVEL SELECT	28
IMAGE LEVEL ADJUSTMENT	29
PICTURE SCREEN ADJUSTMENT	30

VIDEO INPUT 31

SELECTING THE INPUT SOURCE	31
SELECTING THE VIDEO SYSTEM	32
PICTURE IMAGE ADJUSTMENT	33
IMAGE LEVEL SELECT	33
IMAGE LEVEL ADJUSTMENT	34
PICTURE SCREEN ADJUSTMENT	35

SETTING 36

SETTING MENU	36
--------------	----

APPENDIX 38

LAMP REPLACEMENT	38
LAMP REPLACE	38
LAMP REPLACE COUNTER	39
OPERATING WIRELESS MOUSE	40
INSTALLATION	40
OPERATING WIRELESS MOUSE	40
MAINTENANCE	41
WARNING TEMP. INDICATOR	41
AIR FILTER CARE AND CLEANING	41
CLEANING PROJECTION LENS	41
TROUBLESHOOTING	42
INDICATORS AND PROJECTOR CONDITION	44
TECHNICAL SPECIFICATIONS	45
CONFIGURATIONS OF TERMINALS	46
OPTIONAL PARTS	47

TRADEMARKS

- Apple, Macintosh, and PowerBook are trademarks or registered trademarks of Apple Computer, Inc.
- IBM, VGA, XGA, and PS/2 are trademarks or registered trademarks of International Business Machines, Inc.
- Windows and PowerPoint are registered trademarks of Microsoft Corporation.
- Each name of corporations or products in the owner's manual is a trademark or a registered trademark of its respective corporation.

FEATURES AND DESIGN

This Multimedia Projector is designed with the most advanced technology for portability, durability, and ease of use. It utilizes built-in multimedia features, a palette of 16.77 million colors, and matrix liquid crystal display (LCD) technology.

◆ Wide Zoom Lens

This projector is equipped with a Wide Zoom Lens with a 1.5 times optical zoom, and provides a 100" screen size at a range of 10.4' (3.2m) to 15.6' (4.8m).

◆ Compact Design

This projector is extremely compact in size and weight. It is designed to be carried and work anywhere.

◆ Lamp Mode

The Lamp Mode function can be switched into the silent mode and reduce the brightness and set into the lower power consumption.

◆ Compatibility

This projector accepts a wide range of video and computer input signals including;

- **Computers**
IBM-compatible or Macintosh computer up to 1024 x 768 resolution.
- **6 Color TV Systems**
NTSC, PAL, SECAM, NTSC 4.43, PAL-M or PAL-N color system can be connected.
- **Component Video**
Component video signal, such as a DVD player output high definition TV signals including 480i, 480p, 575i, 575p, 720p, 1035i or 1080i, can be connected.
- **S-Video**
S-Video signal, such as a S-VHS VCR or camcorder, can be connected.

◆ High Resolution Image

This projector provides 800 x 600 dots resolution for computer input and 500 horizontal TV lines. Resolution from a computer between SVGA (800 x 600) and XGA (1024 x 768) is compressed into 800 x 600 dots. This projector cannot display image of over 1024 x 768 dots. When the resolution of your computer is higher than 1024 x 768, reset it to a lower resolution.

◆ Multi-Scan System

This projector has the Multi-Scan System to conform to almost all computer output signals quickly. Making manual adjustment of frequency and other settings is unnecessary.

◆ One-Touch Auto PC Adjustment

Incoming computer video signals are recognized and the best adjustment is automatically set by Auto PC Adjustment.

◆ Digital Zoom (for Computer)

The Digital Zoom function expands (to approx. 16 times of screen size in SVGA) or compresses the image size, allowing you to focus on crucial information at a presentation.

◆ Keystone Correction

Positioning height of the projector may result in distorted image being displayed in a trapezoid shape. Keystone Correction solves this problem by digitally altering projection to produce undistorted images.

◆ Power Management

The Power Management function reduces the power consumption while the projector is not in use. This Power Management function operates to turn the Projection Lamp off when a signal has not been received or a button is not pressed over 5 minutes. The Projection Lamp is automatically turned on again when the projector detects a signal or a button is pressed. This projector is shipped with this function ON.

◆ Digital Visual Interface

This projector is equipped with DVI 29-pin terminal for connecting DVI output from a computer.

◆ Switchable Interface Terminal

This projector provides a switchable Interface terminal. You can use the terminal as computer input or monitor output conveniently. (Refer to page 36.)

◆ Laser Pointer Function

The Remote Control Unit supplied with this projector includes the Laser Pointer function. This function helps you to make a smart presentation on a projected screen.

◆ Wireless Mouse

The Remote Control Unit supplied with this projector has the Wireless Mouse function for a connected computer. This function enables you to operate both the projector and the computer with the Remote Control Unit only.

◆ Multilanguage Menu Display

Operation menu is displayed in; English, German, French, Italian, Spanish, Portuguese, Dutch, Swedish, Russian, Chinese, Korean or Japanese.

PREPARATION

NOMENCHTOR

FRONT

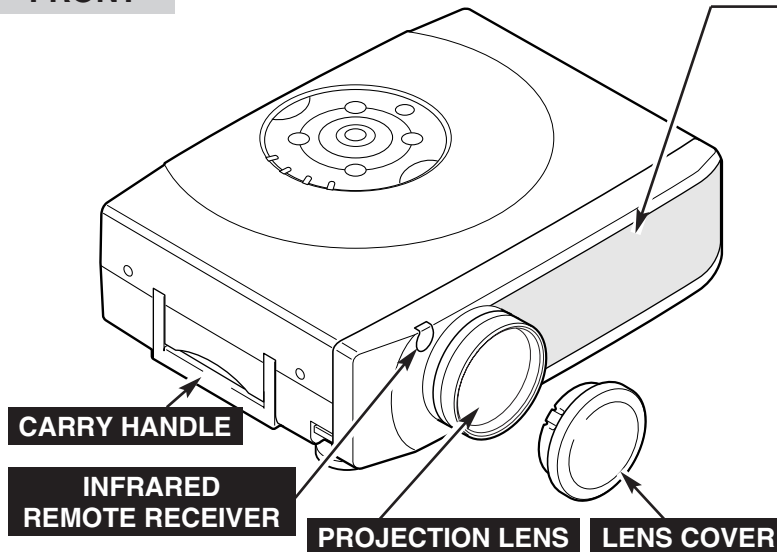

EXHAUST VENTS



HOT AIR EXHAUSTED !

Air blown from Exhaust Vents is hot. When using or installing the projector, the following precautions should be taken.

- Do not put any flammable object near these vents.
- Keep front grills at least 3'(1m) away from any object, especially heat-sensitive objects.
- Do not touch this area, especially screws and metallic parts. This area becomes hot while the projector is used.

This projector detects internal temperature and automatically controls operating power of Cooling Fans.

BACK

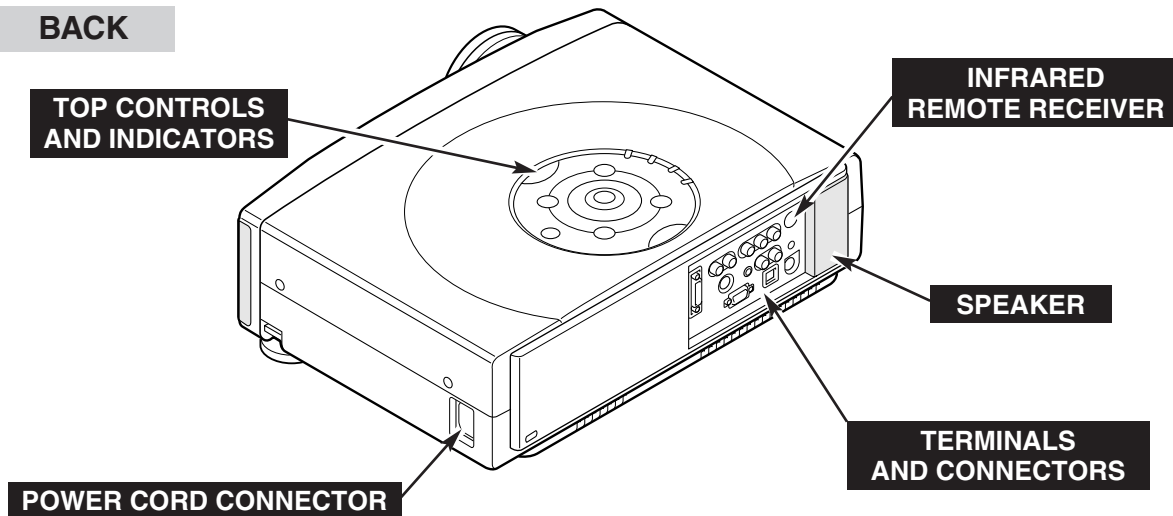

BOTTOM

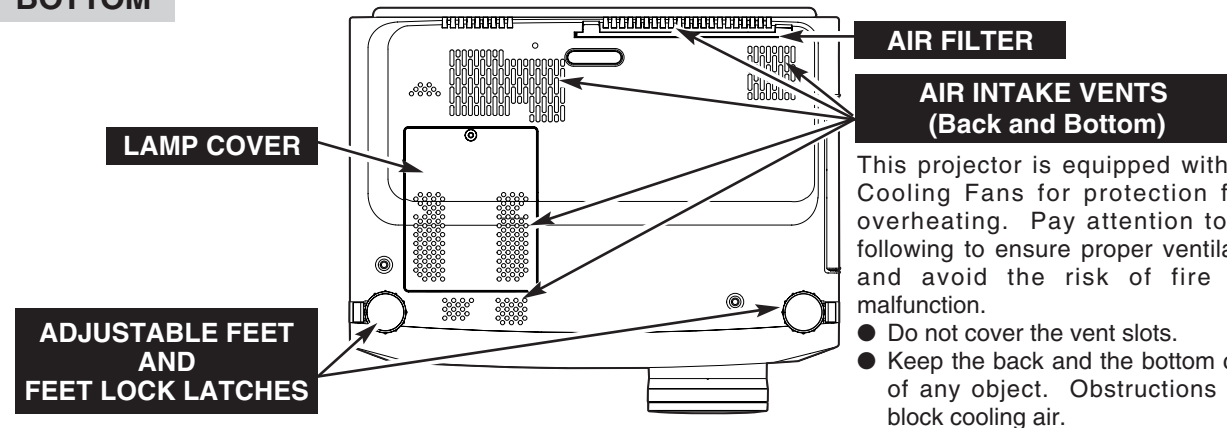

AIR FILTER

AIR INTAKE VENTS (Back and Bottom)

This projector is equipped with the Cooling Fans for protection from overheating. Pay attention to the following to ensure proper ventilation and avoid the risk of fire and malfunction.

- Do not cover the vent slots.
- Keep the back and the bottom clear of any object. Obstructions may block cooling air.

SETTING-UP THE PROJECTOR

CONNECTING AC POWER CORD

This projector uses nominal input voltages of 100-120 V or 200-240 V AC. This projector automatically selects the correct input voltage. It is designed to work with single-phase power systems having a grounded neutral conductor. To reduce the risk of electric shock, do not plug into any other type of power system. Consult your authorized dealer or service station if you are not sure of the type of power supply being supplied. Connect the projector with all peripheral equipment before turning the projector on. (Refer to pages 11 ~ 13 for connection.)

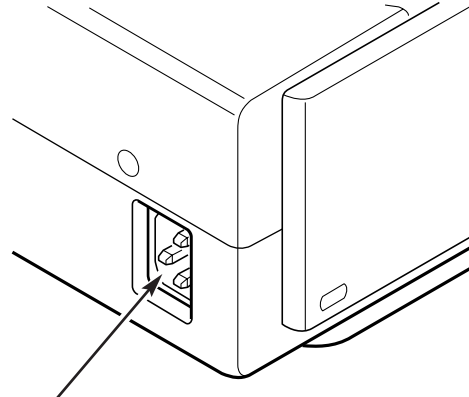

Connect the AC Power Cord (supplied) to the projector. The AC outlet must be near this equipment and must be easily accessible.



CAUTION

For safety, unplug the AC Power Cord when the projector is not in use. When this projector is connected to the AC outlet with the AC Power Cord, it is in Stand-by Mode and consumes a little electric power.

NOTE ON THE POWER CORD

The AC Power Cord must meet the requirements of the country where you use the projector. Confirm the AC plug type with the chart below. The proper AC power cord must be used. If the supplied AC Power Cord does not match the AC outlet, contact your sales dealer.

Projector side	AC Outlet side	
<p>To the POWER CORD CONNECTOR on the projector.</p>	<p>For the U.S.A. and Canada</p> <p>To the AC Outlet. (120 V AC)</p>	<p>For Continental Europe</p> <p>To the AC Outlet. (200 - 240 V AC)</p>

INSTALLING THE PROJECTOR IN PROPER POSITION

Install the projector properly. Improper installation may reduce the lamp lifetime and cause fire hazard.

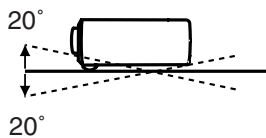

Do not tilt the projector more than 20 degrees above and below.



NO DOWNWARD

Do not point the projector down to project an image.



NO UPWARD

Do not point the projector up to project an image.



NO SIDEWAYS

Do not put the projector on either side to project an image.

POSITIONING THE PROJECTOR

- This projector is designed to project on a flat projection surface.
- The projector can be focused from 3.6'(1.1m) ~ 31.8'(9.7m).
- Refer to the figure below to adjust a screen size.

ROOM LIGHT

The brightness of a room has a great impact on picture quality. It is recommended to limit ambient lighting to provide the best image.

H1 : H2 = 9 : 1

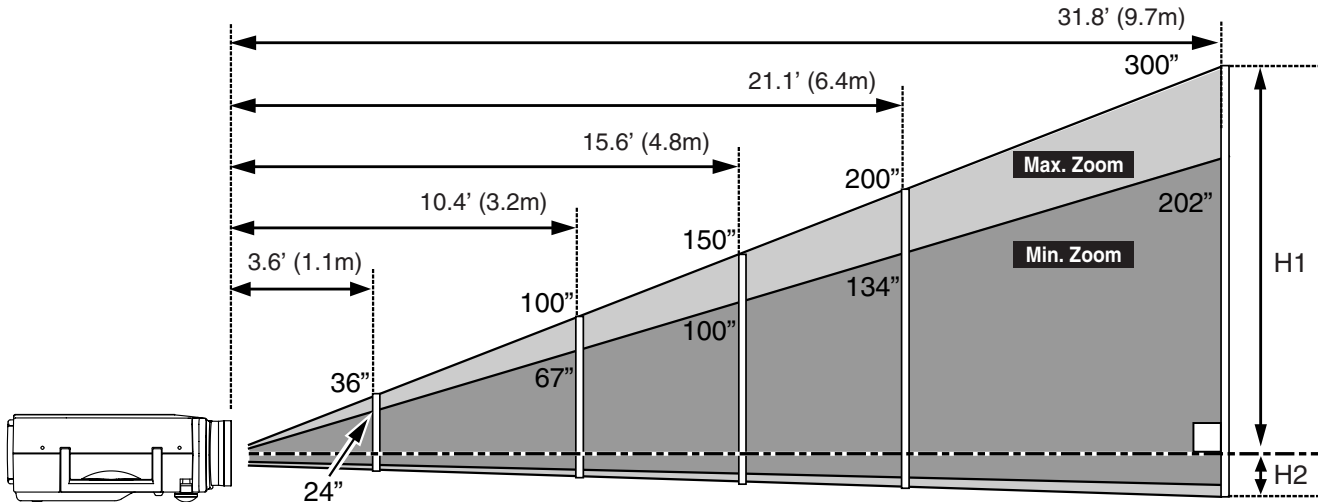

Screen Size (W x H) mm	24"	36"	100"	150"	200"	300"
Zoom (min)	3.6' (1.1m)	5.4' (1.7m)	15.6' (4.8m)	23.5' (7.2m)	31.4' (9.6m)	—
Zoom (max)	—	3.6' (1.1m)	10.4' (3.2m)	15.6' (4.8m)	21.1' (6.4m)	31.8' (9.7m)

ADJUSTABLE FEET

Picture tilt and projection angle can be adjusted by rotating the Adjustable Feet. Projection angle can be adjusted to approx. 16 degrees.

- 1 Lift the front of the projector and pull the Feet Lock Latches on both sides of the projector.
- 2 Release the Feet Lock Latches to lock the Adjustable Feet and rotate the Adjustable Feet to fine tune the position and the tilt.
- 3 To retract the Adjustable Feet, lift the front of the projector and pull the Feet Lock Latches and push to feet upward. Keystone distortion of a projected image can be adjusted by Menu Operation. (Refer to P20 and 36.)



CAUTION

Avoid positioning the projector with the angle of more than 20 degrees. The Projection Lamp may malfunction. Refer to page 8.

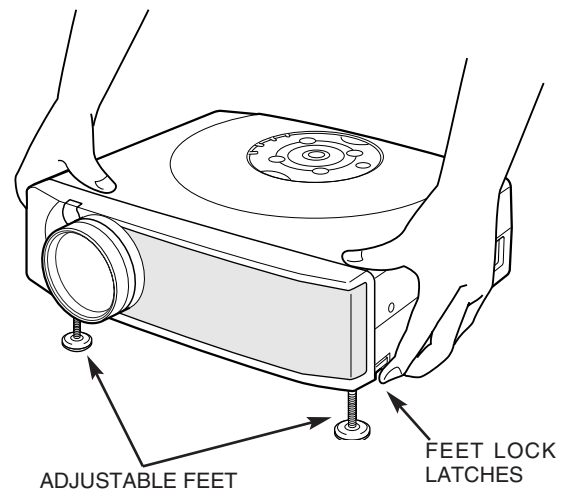

MOUNTING THE LENS COVER

When transporting the projector or when it is not in use for an extended period of time, attach the Lens Cover. Before attaching the Lens Cover, be sure to turn the projector off and disconnect the AC Power cord from the AC outlet.

- 1 Secure the Strap for the Lens Cover through the hole.
- 2 Turn the projector upside down and secure the Strap for the Lens Cover to the bottom of the projector with a screw.

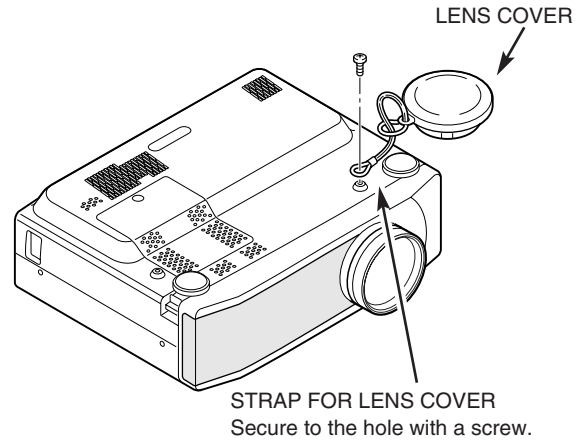

MOVING THE PROJECTOR

Use Carry Handle when moving the projector. When moving the projector, attach the Lens Cover and retract the Adjustable Feet to prevent damage to the lens and cabinet. When the projector is not in use for an extended period of time, put it into the case (carrying bag) supplied with the projector.

CAUTION

Carrying Bag (supplied) is intended for protection from dust and scratches on the surface of a cabinet, and it is not designed to protect the projector from external forces. Do not transport the projector through a courier or transport services with this bag. The projector can be damaged. When handling the projector, do not drop, bump, subject it to strong forces or put other things on the cabinet.

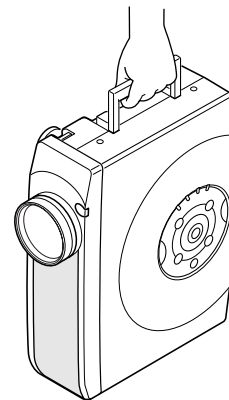

CAUTION IN CARRYING OR TRANSPORTING THE PROJECTOR

- Do not drop or bump the projector, otherwise damage or malfunction may result.
- When carrying the projector, use a suitable carrying case.
- Do not transport the projector by using a courier or transport service in an unsuitable transport case. This may cause damage to the projector. To transport the projector through a courier or transport service, consult your dealer.

CONNECTING THE PROJECTOR

TERMINALS OF THE PROJECTOR

This projector has input and output terminals on its back for connecting computer and video equipment. Refer to figures on pages 11 to 13 for these connections.

S-VIDEO INPUT JACK

Connect the S-VIDEO output from your video equipment to this jack.
(Refer to P13.)

AUDIO INPUT JACKS

Connect the audio output from your video equipment to these jacks.
(Refer to P13.)

● When the audio output is monaural, connect it to L (mono) jack.

VIDEO INPUT JACKS

Connect the composite video output from your video equipment to VIDEO/Y jack or connect the component video outputs to VIDEO/Y, Pb/Cb and Pr/Cr jacks.
(Refer to P13.)

AUDIO OUTPUT JACKS

Connect an external audio amplifier to these jacks.
(Refer to P12, 13.)

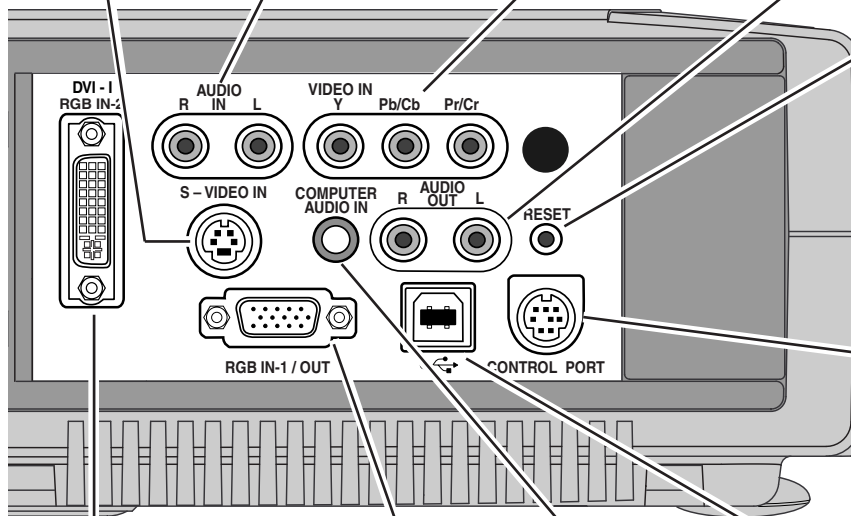

RESET BUTTON

The projector uses a micro processor for control, and occasionally, need to be reset. This can be done by pressing the RESET button with a pen, which will shut down and restart the unit. Do not use the RESET function excessively.

CONTROL PORT CONNECTOR

When controlling your computer with the Remote Control Unit of this projector, connect the mouse port of your computer to this connector. (Refer to P12.)

RGB INPUT 2 TERMINAL (DIGITAL/ANALOG)

Connect computer output (Digital / Analog DVI-I type) to this terminal.
(Refer to P12.)

RGB INPUT 1 / OUT TERMINAL (ANALOG)

This terminal is switchable and can be used as computer input or monitor output. Set the terminal up as either Computer input or Monitor output properly before using this terminal.
(Refer to P12, 36.)

Note: This terminal outputs analog signal from DVI-I RGB IN 2 terminal only.

COMPUTER AUDIO INPUT JACK

Connect the audio output (stereo) from your computer to this jack.
(Refer to P12.)

USB CONNECTOR (Series B)

When controlling your computer with the Remote Control Unit of this projector, connect the USB port of your computer to this connector.
(Refer to P12.)

CONNECTING TO COMPUTER

Cables used for connection (* = Cable or adapter is not supplied with this projector.)

- VGA Cable (HDB 15 pin)
- Control Cable for PS/2 Port
- DVI-Digital Cable (for Single Link T.M.D.S.) *
- Control Cable for Serial Port *, or ADB Port *
- USB Cable *
- MAC Adapter (When connecting to Macintosh computer) *
- DVI/VGA Adapter
- Audio Cables (RCA x 2 and Mini Plug (stereo) x 1) *

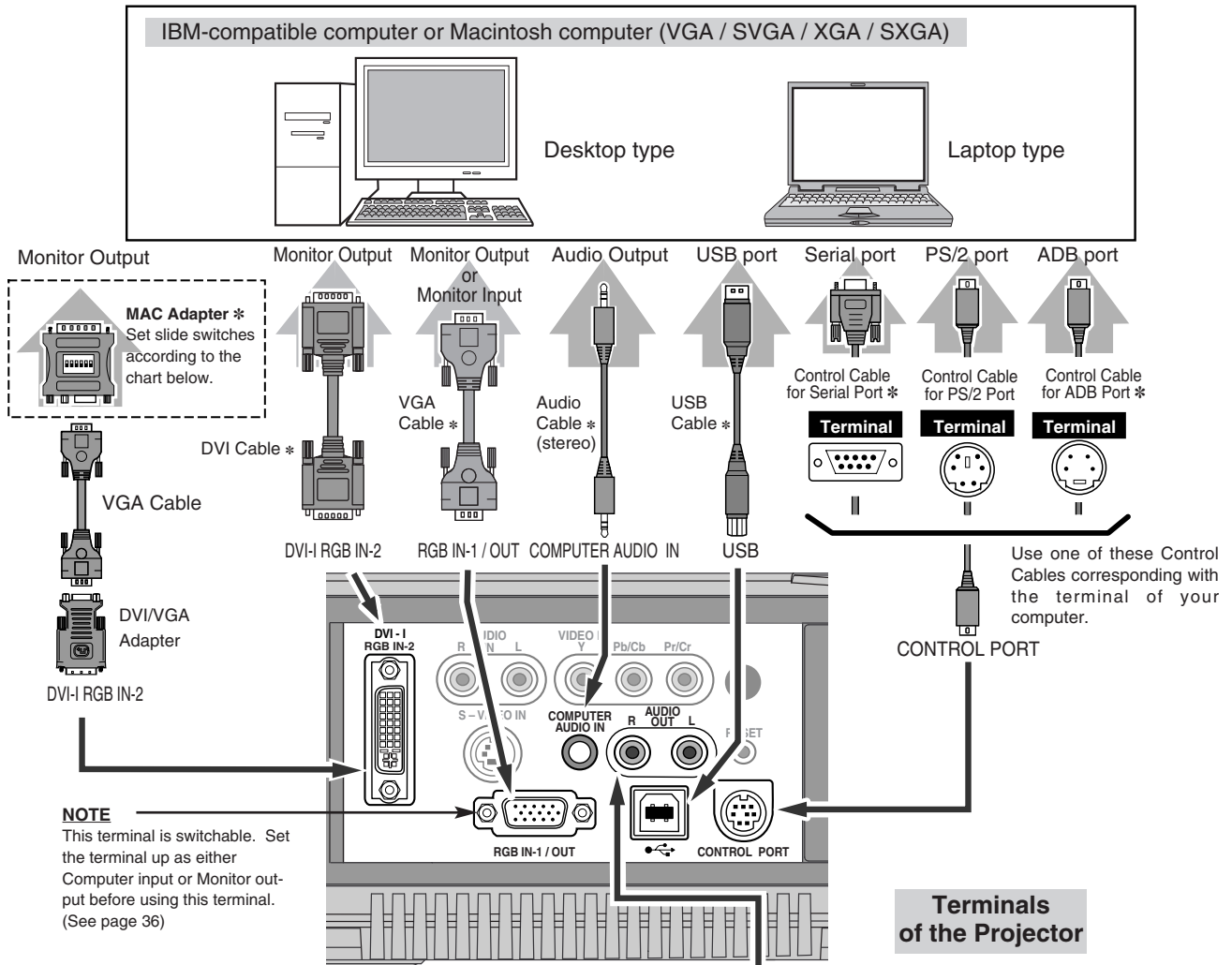

NOTE :
When connecting the cable, the power cords of both the projector and the external equipment should be disconnected from the AC outlet. Turn the projector and all peripheral equipment on before the computer is switched on.

MAC ADAPTER (Not supplied)

Set switches as shown in the table below depending on RESOLUTION MODE that you want to use before you turn on projector and computer.

	1	2	3	4	5	6
13" MODE (640 x 480)	ON	ON	OFF	OFF	OFF	OFF
16" MODE (832 x 624)	OFF	ON	OFF	ON	OFF	OFF
19" MODE (1024 x 768)	OFF	ON	ON	OFF	OFF	OFF
21" MODE (1152 x 870)	ON	ON	ON	ON	OFF	OFF

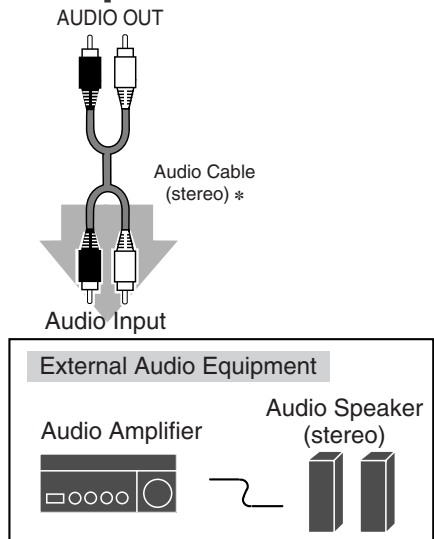

CONNECTING TO VIDEO EQUIPMENT

Cables used for connection (* = Cable is not supplied with this projector.)

- Video Cable (RCA x 1 or RCA x 3) *
- S-VIDEO Cable *
- Audio Cable (RCA x 2) *
- Scart-VGA Cable *

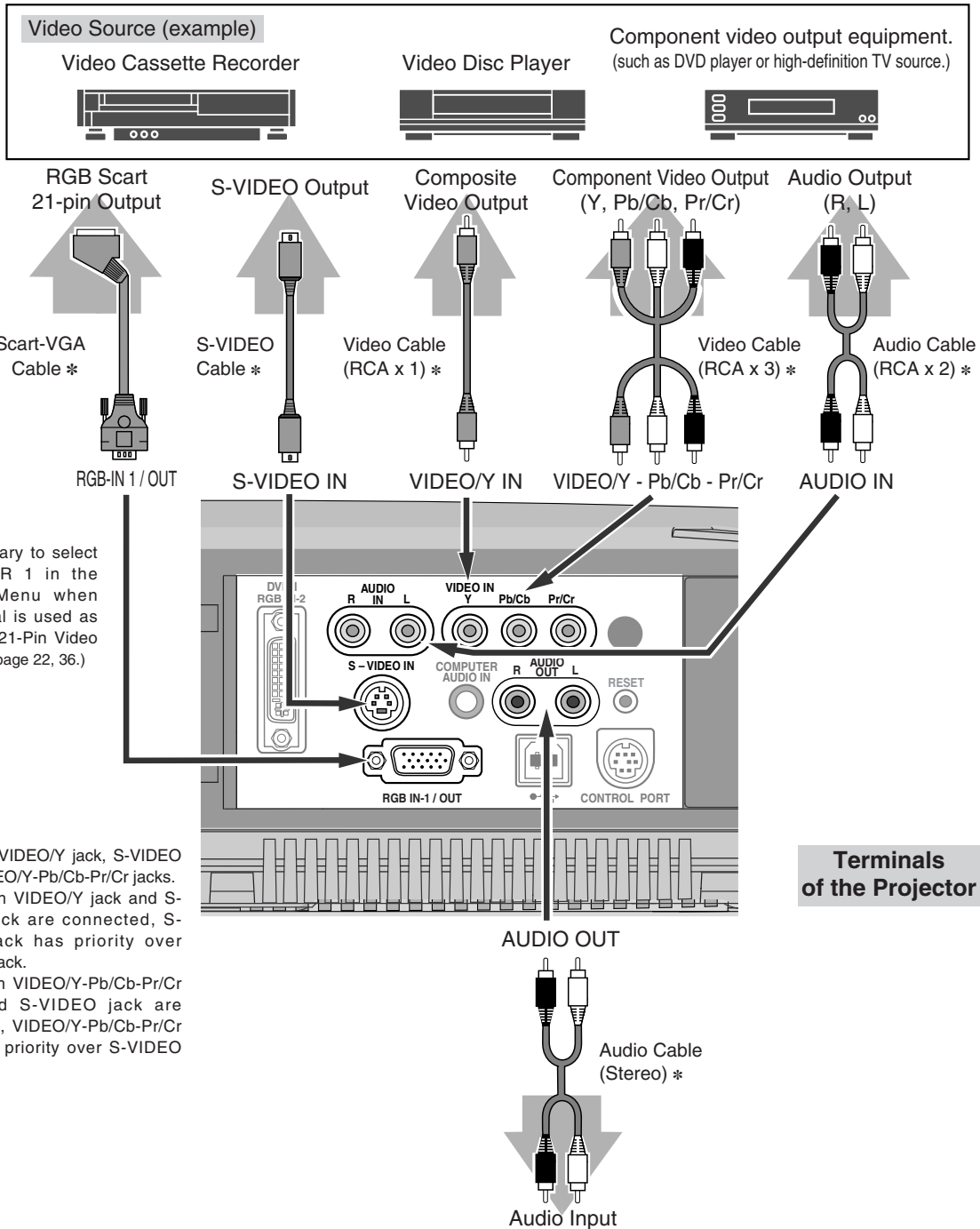

NOTE
It is necessary to select **COMPUTER 1** in the **SETTING Menu** when this terminal is used as RGB Scart 21-Pin Video Input. (See page 22, 36.)

- Use any of VIDEO/Y jack, S-VIDEO jack, or VIDEO/Y-Pb/Cb-Pr/Cr jacks.
- When both VIDEO/Y jack and S-VIDEO jack are connected, S-VIDEO jack has priority over VIDEO/Y jack.
 - When both VIDEO/Y-Pb/Cb-Pr/Cr jacks and S-VIDEO jack are connected, VIDEO/Y-Pb/Cb-Pr/Cr jacks has priority over S-VIDEO jack.



NOTE :
When connecting the cable, the power cords of both the projector and the external equipment should be disconnected from the AC outlet.

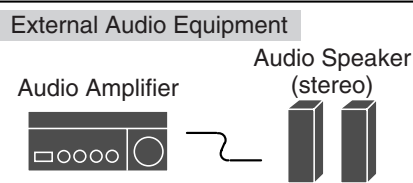

BEFORE OPERATION

OPERATION OF THE REMOTE CONTROL UNIT

Left Side

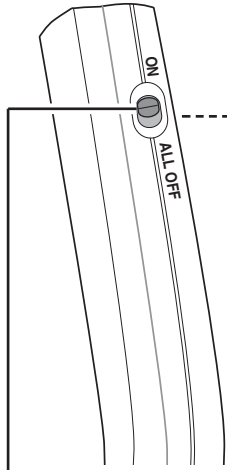

ALL-OFF SWITCH

When using the Remote Control Unit, turn this switch to "ON." Turn it to "ALL OFF" when not in use.

LASER POINTER INDICATOR

Lights red while laser beam is emitted from Laser Light Window.

MENU BUTTON

Used to open or close ON-SCREEN MENU operation. (P17, 18)

SET BUTTON

Used to execute the item selected, or to expand/compress the image in DIGITAL ZOOM +/- mode. (P30)
It is also used as a PC mouse in Wireless Mouse Operation. (P40)

LASER BUTTON

Used to operate Laser Pointer Function. Laser beam is emitted while pressing this button within 1 minute.
When using this Laser Pointer for more than 1 minute, release LASER button and press it again.

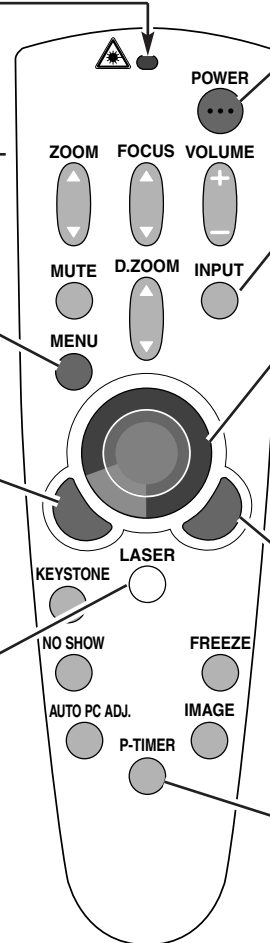

POWER ON-OFF BUTTON

Used to turn projector on or off. (P19)

INPUT BUTTON

Used to select input source. (P22, 31)

POINT BUTTON

Used to select an item or adjust value in ON-SCREEN MENU. They are also used to pan the image in DIGITAL ZOOM +/- mode. (P30)
It is also used as a PC mouse in Wireless Mouse Operation. (P40)

* When pressing the center of this button, it works as SET button.

RIGHT CLICK BUTTON

Used as a PC mouse in Wireless Mouse Operation. (P40)

P-TIMER BUTTON

Used to operate P-TIMER function. (P21)

LASER POINTER FUNCTION

This Remote Control Unit emits a laser beam as the laser pointer function from the Laser Light Window. When the LASER button is pressed, the laser light goes on. And when the LASER button is being pressed for more than 1 minute or the LASER button is released, the light goes off. The LASER POINTER INDICATOR lights red and the laser is emitted with red light to indicate that the laser beam is being emitted.

The laser emitted is a class II laser; do not look into the Laser Light Window nor shine the laser beam on yourself or other people. The caution labels for the laser beam are shown below.



CAUTION : Use of controls, adjustments or performance of procedures other than those specified herein may result in hazardous radiation exposure.

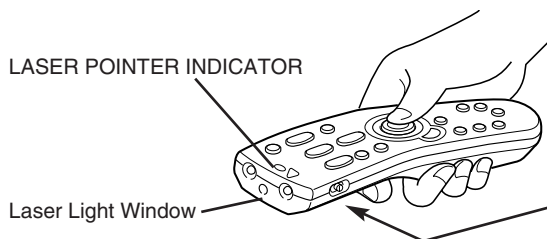

These caution labels are put on the remote control unit.

<p>CAUTION</p> <p>LASER RADIATION- DO NOT STARE INTO BEAM</p> <p>MAX OUTPUT : 1mW WAVE LENGTH : 650±20nm CLASS II LASER PRODUCT</p> <p>This product is complied with 21 CFR part 1040.10</p>	<p>LASER RADIATION DO NOT STARE INTO BEAM CLASS 2 LASER PRODUCT LASER-STRAHLUNG NICHT IN DEN STRAHL BLICKEN LASER-KLASSE 2 レーザ放射クラス2レーザ製品 ビームをのぞき込まないこと IEC60825-1, Am.1 1997 MAX OUTPUT (最大出力) : 1mW WAVE LENGTH (波長) : 650±20nm</p>
---	---



AVOID EXPOSURE-LASER RADIATION IS EMITTED FROM THIS APERTURE
レーザー光の出口
ビームをのぞき込まないこと

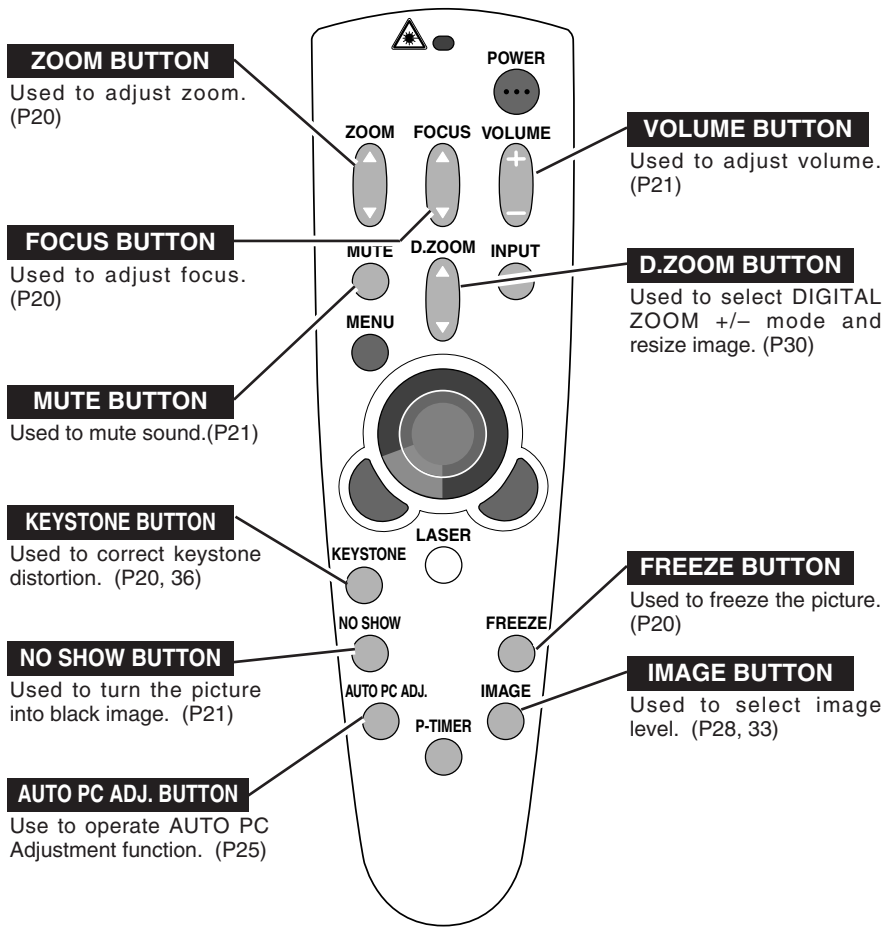

Operating Range

Point the Remote Control Unit toward the projector (Receiver Window) whenever pressing any button. Maximum operating range for the Remote Control Unit is about 16.4' (5m) and 60° in front and rear of the projector.

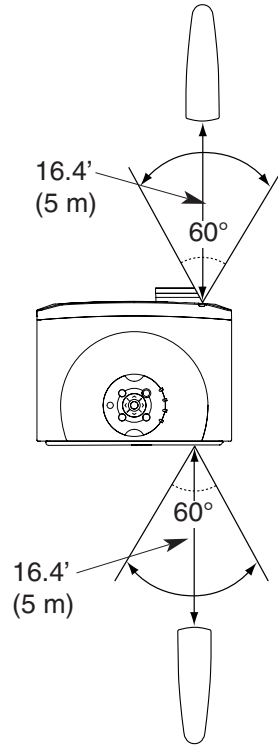

REMOTE CONTROL UNIT BATTERIES INSTALLATION

1 Remove the battery compartment lid.

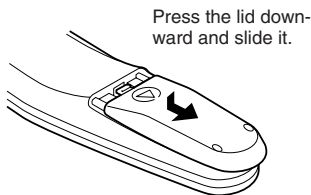

2 Slide the batteries into the compartment.

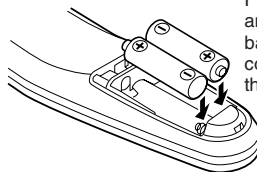

Two AA size batteries
For correct polarity (+ and -), be sure that the battery terminals are in contact with the pins in the compartment.

3 Replace the compartment lid.

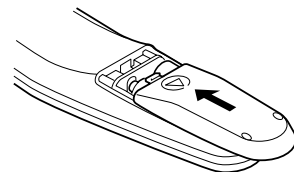

To insure safe operation, please observe the following precautions :

- Use (2) AA, UM3 or R06 type alkaline batteries.
- Replace both batteries at the same time.
- Do not use a new battery with a used battery.
- Avoid contact with water or liquid.
- Do not expose the Remote Control Unit to moisture, or heat.
- Do not drop the Remote Control Unit.
- If a battery has leaked on the Remote Control Unit, carefully wipe the case clean and install new batteries.
- Danger of explosion if battery is incorrectly replaced.
- Dispose of used batteries according to battery manufacturer's instructions and local rules.

TOP CONTROLS AND INDICATORS

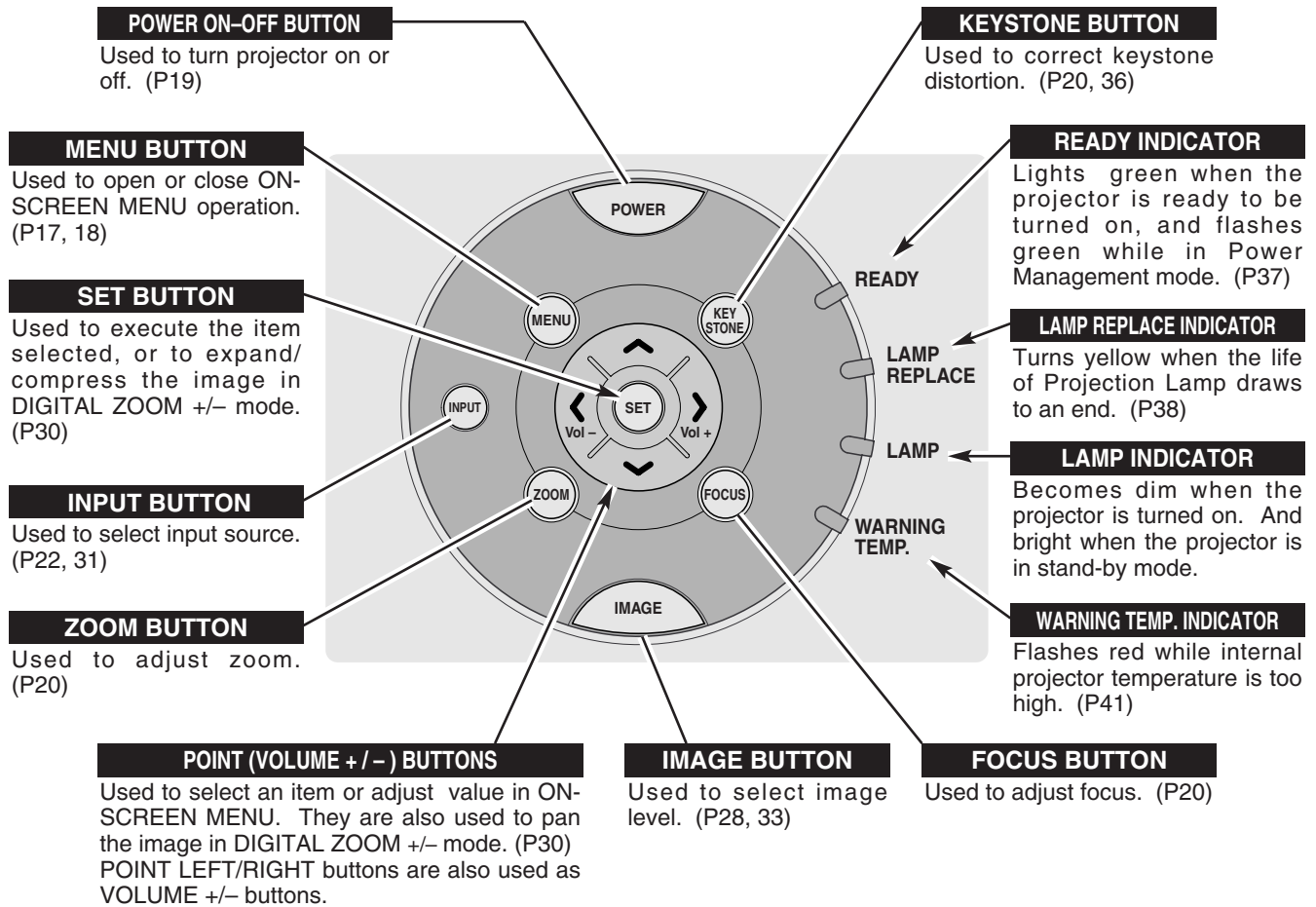

OPERATING THE ON-SCREEN MENU

HOW TO OPERATE THE ON-SCREEN MENU

You can control and adjust this projector through the ON-SCREEN MENU. Refer to the following pages to operate each adjustment on the ON-SCREEN MENU.

DISPLAY MENU

- 1 Press the MENU button to display the ON-SCREEN MENU.

MOVING POINTER

- 2 Move the pointer (* see below) or adjust the value of item by pressing the POINT button(s) on the Top Control or on the Remote Control Unit.

* Pointer is the icon on the ON-SCREEN MENU to select the item. See the section "FLOW OF ON-SCREEN MENU OPERATION" below.

SELECT ITEM

- 3 Select the item or set the selected function by pressing the SET button.

REMOTE CONTROL UNIT

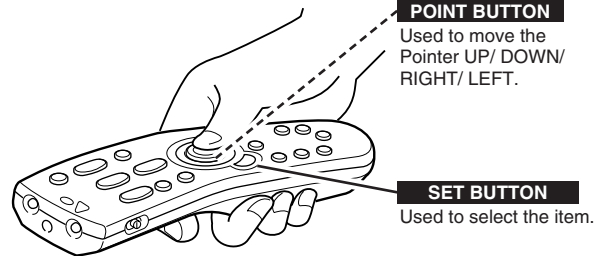

TOP CONTROL

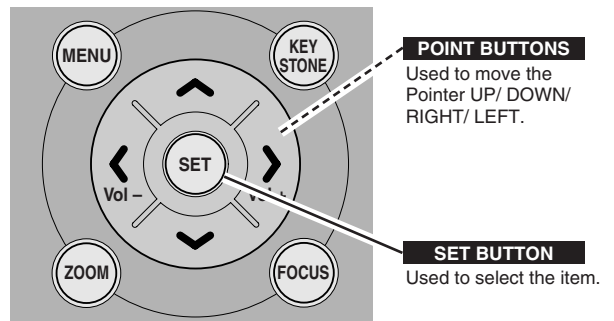

FLOW OF ON-SCREEN MENU OPERATION

Display ON-SCREEN MENU

- 1 Press the MENU button to display the ON-SCREEN MENU (MENU BAR). The red frame is the POINTER.

Select Menu to be adjusted

- 2 Move the POINTER (red frame) to the MENU ICON that you want to select by pressing the POINT RIGHT / LEFT buttons.

Control or adjust item through ON-SCREEN MENU

- 3 Press the POINT DOWN button and move the POINTER (red frame or red arrow) to the ITEM that you want to adjust, and then press the SET button to show the ITEM.

- 4 Adjust the ITEM by pressing the POINT RIGHT / LEFT buttons. Refer to the following pages for details of respective adjustments.

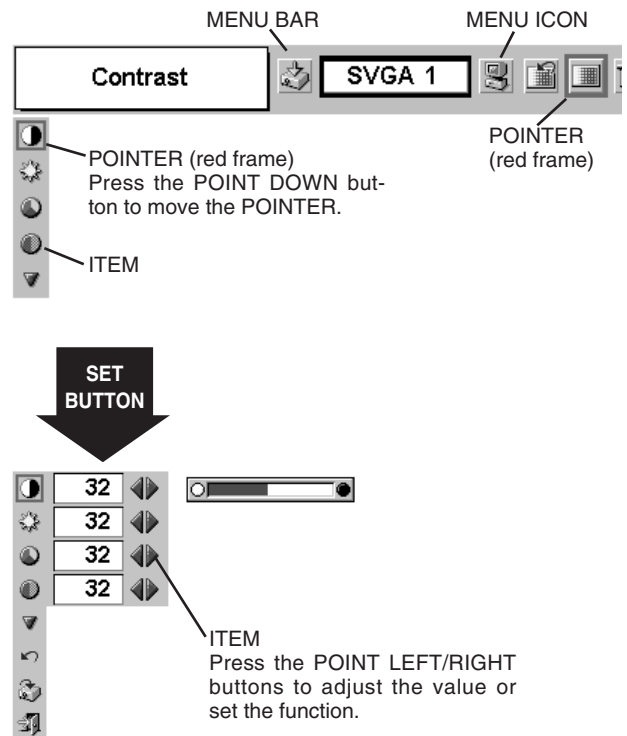

MENU BAR

FOR PC SOURCE

Press the MENU BUTTON while connected to the PC input source.

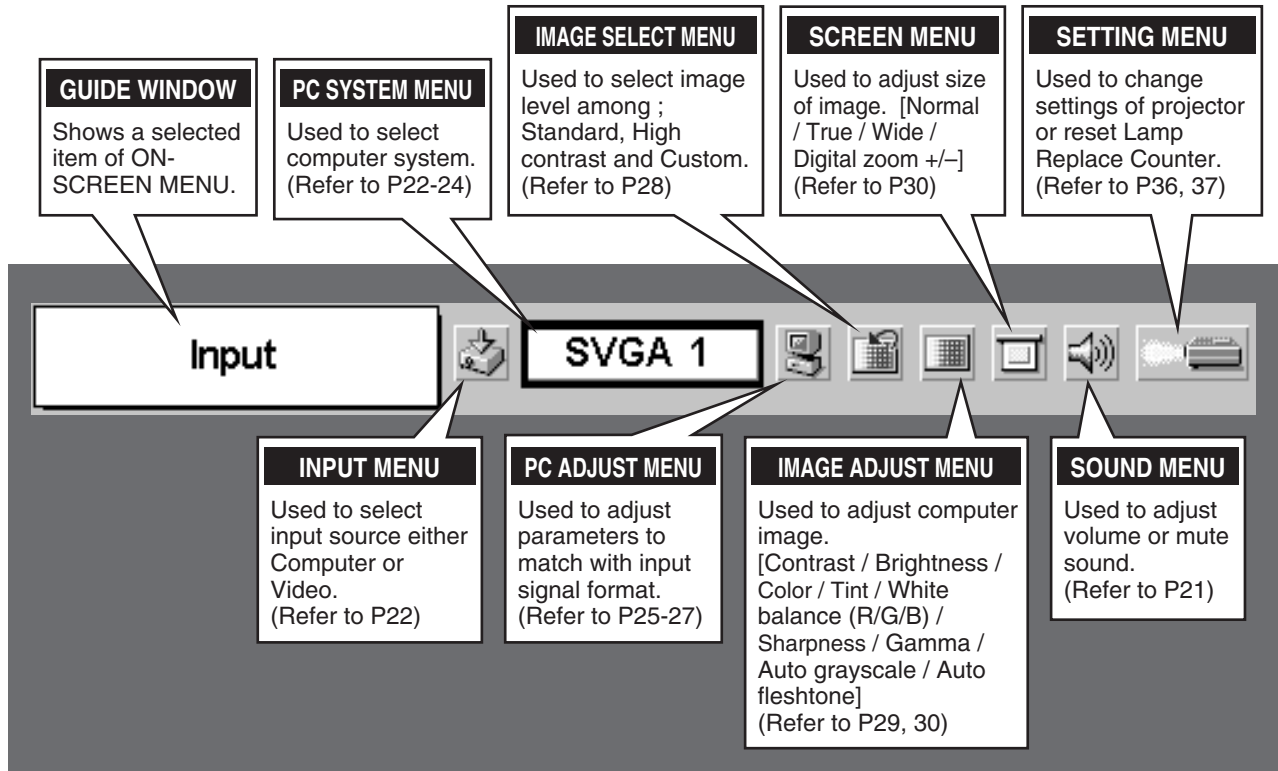

FOR VIDEO SOURCE

Press the MENU BUTTON while connected to the VIDEO input source.

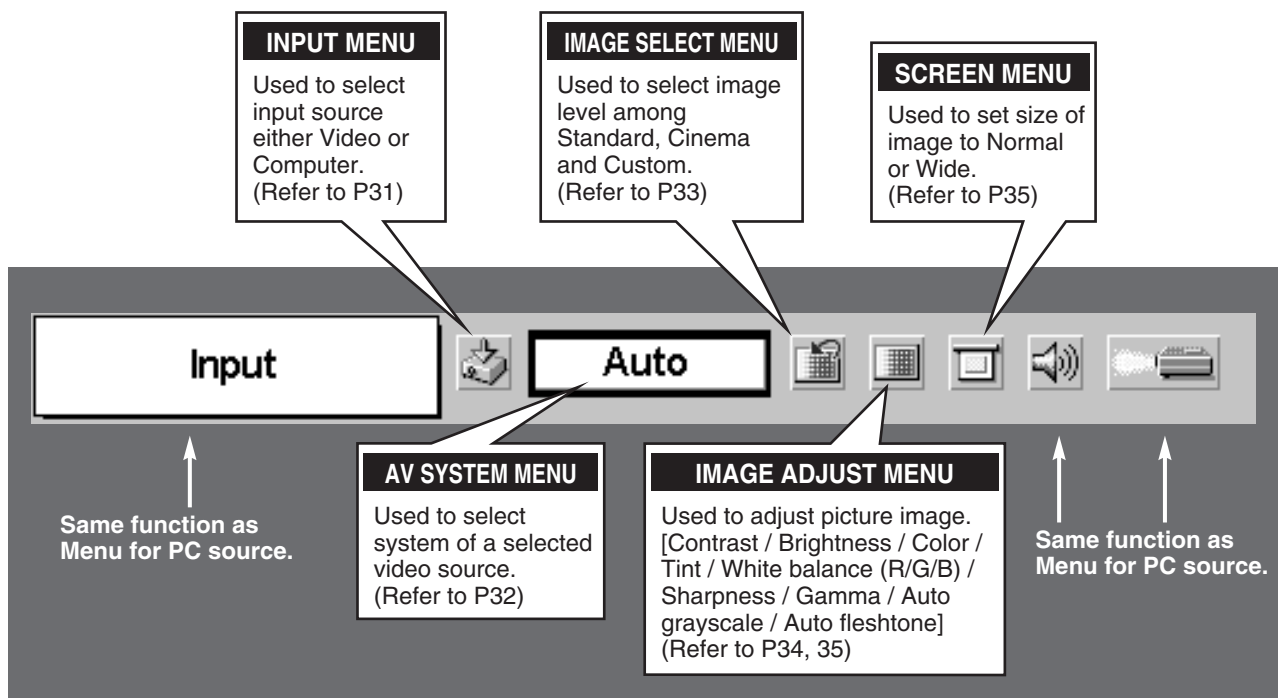

TURNING ON / OFF THE PROJECTOR

TURNING ON THE PROJECTOR

- 1 Complete all peripheral connections (with Computer, VCR, etc.) before turning on the projector. (Refer to the “CONNECTING THE PROJECTOR” on page 11~13.)
- 2 Connect the AC Power Cord into an AC outlet. The LAMP Indicator lights red, and the READY Indicator lights green.
- 3 Press the POWER ON-OFF button on the Top Control or on the Remote Control Unit to ON. The LAMP Indicator dims, and the Cooling Fans start to operate. The Preparation Display appears on the screen and the count-down starts.
- 4 The image level that was selected last and the Lamp mode status appear for 4 seconds, and the signal from PC or Video source appears.

NOTE : When the On start function is ON, this projector is turned on automatically by connecting the AC Power Cord to an AC outlet. (Refer to the menu item “On start” on page 37.)

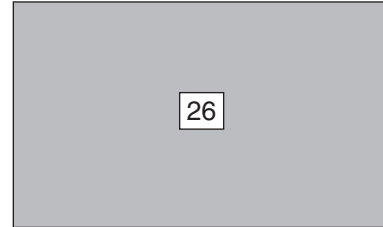

The Preparation Display disappears after 30 seconds.

Lamp mode

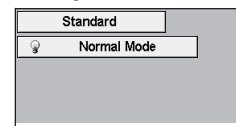

*Refer to page 37 for the Lamp mode.

TURNING OFF THE PROJECTOR

- 1 Press the POWER ON-OFF button on the Top Control or on the Remote Control Unit, and the message “Power off?” appears on a screen.
- 2 Press the POWER ON-OFF button again to turn off the projector. The LAMP Indicator lights bright and the READY Indicator turns off. After the projector is turned off, the Cooling Fans operate (for 90 seconds).
- 3 When the projector has cooled down, the READY Indicator lights green again.

NOTE : The projector cannot be turned on during cooling period with the READY Indicator off. You can turn it on again after the READY Indicator lights green.



TO MAINTAIN THE LIFE OF LAMP, ONCE YOU TURN PROJECTOR ON, WAIT AT LEAST 5 MINUTES BEFORE TURNING IT OFF.
DO NOT DISCONNECT AC POWER CORD BEFORE READY INDICATOR LIGHTS GREEN.

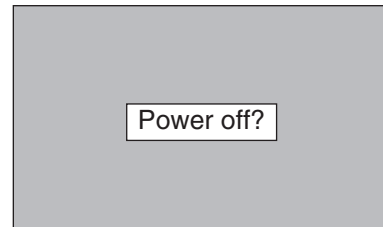

Message disappears after 4 seconds.

note on operation

When the Power management function is ON, the projector detects signal interruption and turns off the Projection Lamp automatically. Refer to the menu item “Power management” on page 37.

When the WARNING TEMP. Indicator flashes red, the projector is automatically turned off. Turn the projector on with the POWER ON-OFF button after the READY indicator lights green.

When the WARNING TEMP. Indicator continues to flash, refer to the section “MAINTENANCE” on page 41 and proper maintenance should be taken.

ADJUSTING THE SCREEN

ZOOM ADJUSTMENT

- 1 Press the ZOOM button on the Top Control or the ZOOM ▲/▼ button on the Remote Control Unit. The message “Zoom” is displayed.
- 2 Press the ZOOM ▲ button or the POINT UP button to make the image larger, and press the ZOOM ▼ button or the POINT DOWN button to make the image smaller.

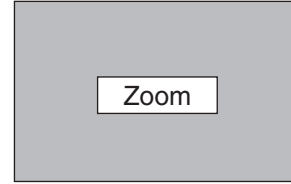

Message disappears after 4 seconds.

FOCUS ADJUSTMENT

- 1 Press the FOCUS button on the Top Control or the FOCUS ▲/▼ button on the Remote Control Unit. The message “Focus” is displayed.
- 2 Adjust the focus of the image by pressing the FOCUS ▲/▼ button or the POINT UP/DOWN button(s) .

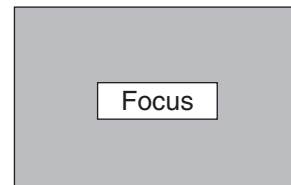

Message disappears after 4 seconds.

KEYSTONE ADJUSTMENT

If the projected picture has keystone distortion, correct the image with KEYSTONE adjustment.

- 1 Press the KEYSTONE button on the Remote Control Unit or select Keystone on the SETTING menu. (Refer to page 36.) The keystone dialog box appears.
- 2 Correct keystone distortion by pressing the POINT UP/DOWN button(s) on the Top Control or on the Remote Control Unit. Press the POINT UP button to reduce the upper part of the image, and press the POINT DOWN button to reduce the lower part.



- The arrows are blue in no correction.
- The arrow of direction being corrected turns light blue.
- The arrow disappears at the maximum correction.
- If you press the KEYSTONE button on the Remote Control Unit once more while the keystone dialog box is being displayed, the keystone adjustment will be set into no correction.

Reduce the upper width with the POINT UP button.

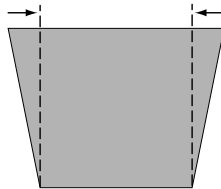

Reduce the lower width with the POINT DOWN button.

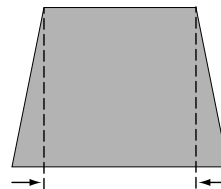

PICTURE FREEZE FUNCTION

Press the FREEZE button on the Remote Control Unit to freeze the picture on-screen. To cancel the FREEZE function, press the FREEZE button again or press any other button.

NO SHOW FUNCTION

Press the NO SHOW button on the Remote Control Unit to black out the image. To restore to normal, press the NO SHOW button again or press any other button.

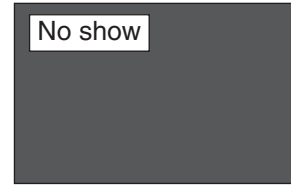

Message disappears after 4 seconds.

P-TIMER FUNCTION

Press the P-TIMER button on the Remote Control Unit. The timer display "00 : 00" appears and the timer starts to count time (00 : 00 ~ 59 : 59).

To stop the P-TIMER display, press the P-TIMER button. Press the P-TIMER button again to cancel the P-TIMER function.



SOUND ADJUSTMENT

DIRECT OPERATION

Volume

Press the VOLUME (+/-) button(s) on the Top Control or on the Remote Control Unit to adjust the volume. The volume dialog box appears. The VOLUME (+) button to increase the volume, and the VOLUME (-) button to decrease the volume.

Mute

Press the MUTE button on the Remote Control Unit to cut off the sound. To restore the sound to its previous level, press the MUTE button again or press the VOLUME (+/-) button(s).

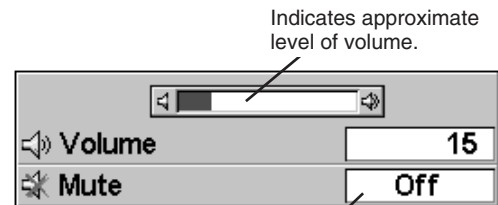

Press the MUTE button to set the Mute function On or Off.

Dialog box disappears after 4 seconds.

MENU OPERATION

- 1 Press the MENU button and the ON-SCREEN MENU will appear. Press the POINT LEFT/RIGHT buttons to move the red frame pointer to the SOUND Menu icon.
- 2 Press the POINT DOWN button to move the red frame pointer to the item that you want to select, and then press the SET button.



Volume

Press the POINT RIGHT button to increase the volume, and press the POINT LEFT button to decrease the volume.



Mute

Press the POINT LEFT/RIGHT button to cut off the sound. The dialog box display is changed to "On" and the sound is cut off. To restore the sound to its previous level, press the POINT LEFT/RIGHT button again.

SOUND MENU

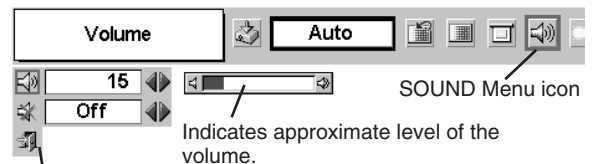

Close the SOUND Menu.

SELECTING THE INPUT SOURCE

DIRECT OPERATION

Choose either Computer 1 or Computer 2 by pressing the INPUT button on the Top Control or on the Remote Control Unit. If the projector cannot reproduce a proper image, select the correct input source through the "MENU OPERATION" (see below).

INPUT button

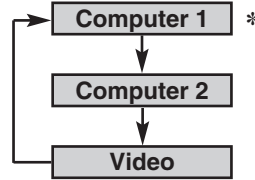

* Computer 1 is not displayed when RGB IN 1 / OUT terminal is used as MONITOR OUT.

MENU OPERATION

- 1 Press the MENU button and the ON-SCREEN MENU will appear. Press the POINT LEFT/RIGHT button to move the red frame pointer to the INPUT Menu icon.
- 2 Press the POINT DOWN button to move the red arrow pointer to either Computer 1 or Computer 2 (Computer 1 is not displayed when MONITOR OUT is selected in the SETTING Menu.), and then press the SET button. The Source Select Menu will appear.
- 3 Move the pointer to the correct input source and then press the SET button.

- | | |
|----------------------|--|
| RGB | When the input source is coming from a computer through RGB IN 1 / OUT terminal, select RGB. |
| RGB (Scart) | When the input source is coming from a DVD player through RGB IN 1 / OUT terminal, select RGB (Scart). |
| RGB (Digital) | When the digital signal is connected to DVI terminal, select RGB (Digital). |
| RGB (Analog) | When the analog signal is connected to DVI terminal, select RGB (Analog). |

INPUT MENU

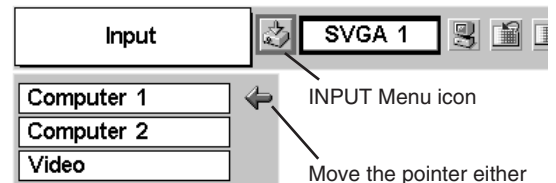

Move the pointer either Computer 1 or Computer 2 and press the SET button.

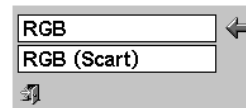

Source Select Menu
Move the pointer to RGB or RGB (Scart) and press the SET button.

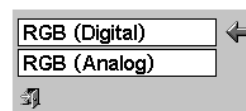

Source Select Menu
Move the pointer to RGB (Digital) or RGB (Analog) and press the SET button.

* Computer 1 is not displayed when RGB IN 1 / OUT terminal is used as MONITOR OUT.

NOTE

- Computer 1 can be selected when RGB IN 1 / OUT terminal is set as COMPUTER 1 at the menu item "Terminal" in the SETTING Menu. (Refer to page 36.)

SELECTING THE COMPUTER SYSTEM

This projector automatically tunes to most different types of computers based on VGA, SVGA, XGA, or SXGA (refer to the "COMPATIBLE COMPUTER SPECIFICATIONS" on page 24). When selecting Computer, this projector automatically tunes to the incoming signal and projects a proper image without any special setting. (Some computers need to be set manually.) The projector displays one of the Auto, ---, Mode 1/2/3/4/5, or the system provided in the projector.

Auto When the projector cannot recognize the connected signal, the Auto PC Adjustment function adjusts the projector, and the message "Auto" is displayed on the SYSTEM Menu icon. (Refer to page 25.) When the image is not provided properly, adjust the parameters manually. (Refer to page 26, 27.)

--- There is no signal input from the connected computer. Make sure the connection between the computer and the projector is set correctly. (Refer to the "TROUBLESHOOTING" on page 42.)

Mode 1 User preset adjustment in the "MANUAL PC ADJUSTMENT." Adjustment data can be stored in the Mode 1 - 5.

SVGA 1 Computer systems provided in the projector. The projector chooses a proper system and displays it.

*Mode 1 and SVGA 1 are examples.

PC SYSTEM MENU

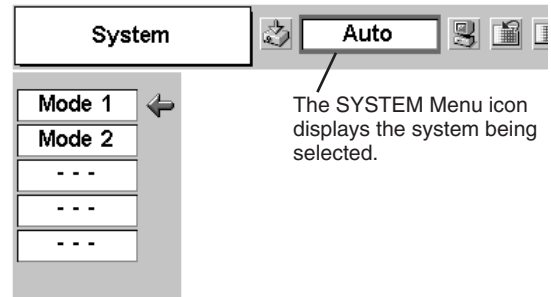

SELECT COMPUTER SYSTEM MANUALLY

This projector automatically selects the PC system among those provided in this projector and the PC system can also be selected manually.

- 1 Press the MENU button and the ON-SCREEN MENU will appear. Press the POINT LEFT/RIGHT buttons to move the red frame pointer to the PC SYSTEM Menu icon.
- 2 Press the POINT DOWN button to move the red arrow pointer to the system that you want to set, and then press the SET button.

PC SYSTEM MENU

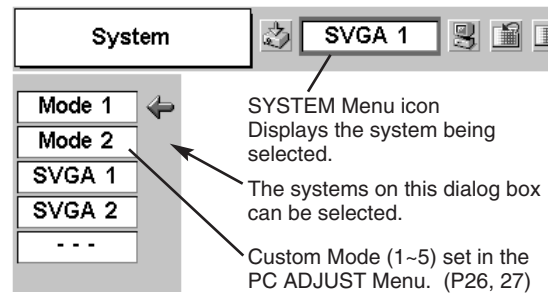

NOTE

- The PC SYSTEM Menu cannot be selected when the input signal is digital.

COMPATIBLE COMPUTER SPECIFICATIONS

This projector can accept the signal from all computers with the V, H-Frequency below mentioned and less than 100 MHz of Dot Clock.

ON-SCREEN DISPLAY	RESOLUTION	H-Freq. (kHz)	V-Freq. (Hz)	ON-SCREEN DISPLAY	RESOLUTION	H-Freq. (kHz)	V-Freq. (Hz)
VGA 1	640 x 480	31.47	59.88	XGA 4	1024 x 768	56.476	70.07
VGA 2	720 x 400	31.47	70.09	XGA 5	1024 x 768	60.31	74.92
VGA 3	640 x 400	31.47	70.09	XGA 6	1024 x 768	48.50	60.02
VGA 4	640 x 480	37.86	74.38	XGA 7	1024 x 768	44.00	54.58
VGA 5	640 x 480	37.86	72.81	XGA 8	1024 x 768	63.48	79.35
VGA 6	640 x 480	37.50	75.00	XGA 9	1024 x 768	36.00	87.17 (Interlace)
VGA 7	640 x 480	43.269	85.00	XGA 10	1024 x 768	62.04	77.07
MAC LC13	640 x 480	34.97	66.60	XGA 11	1024 x 768	61.00	75.70
MAC 13	640 x 480	35.00	66.67	XGA 12	1024 x 768	35.522	86.96 (Interlace)
RGB	————	15.625	50.00 (Interlace)	XGA 13	1024 x 768	46.90	58.20
RGB	————	15.734	60.00 (Interlace)	XGA 14	1024 x 768	47.00	58.30
SVGA 1	800 x 600	35.156	56.25	XGA 15	1024 x 768	58.03	72.00
SVGA 2	800 x 600	37.88	60.32	MAC 19	1024 x 768	60.24	75.08
SVGA 3	800 x 600	46.875	75.00	MAC 21	1152 x 870	68.68	75.06
SVGA 4	800 x 600	53.674	85.06	SXGA 1	1152 x 864	64.20	70.40
SVGA 5	800 x 600	48.08	72.19	SXGA 11	1152 x 900	61.20	65.20
SVGA 6	800 x 600	37.90	61.03	SXGA 13	1280 x 1024	50.00	86.00 (Interlace)
SVGA 7	800 x 600	34.50	55.38	SXGA 14	1280 x 1024	50.00	94.00 (Interlace)
SVGA 8	800 x 600	38.00	60.51	SXGA 17	1152 x 900	61.85	66.00
SVGA 9	800 x 600	38.60	60.31	SXGA 18	1280 x 1024	46.43	86.70 (Interlace)
SVGA 10	800 x 600	32.70	51.09	480p (HDTV)	————	31.47	59.88
SVGA 11	800 x 600	38.00	60.51	575p (HDTV)	————	31.25	50.00
MAC 16	832 x 624	49.72	74.55	720p (HDTV)	————	45.00	60.00
XGA 1	1024 x 768	48.36	60.00	1035i (HDTV)	————	33.75	60.00 (Interlace)
XGA 2	1024 x 768	68.677	84.997	1080i 60(HDTV)	————	33.75	60.00 (Interlace)
XGA 3	1024 x 768	60.023	75.03	1080i 50(HDTV)	————	28.125	50.00 (Interlace)

When an input signal is digital from DVI terminal, refer to the chart below.

ON-SCREEN DISPLAY	RESOLUTION	H-Freq. (kHz)	V-Freq. (Hz)	ON-SCREEN DISPLAY	RESOLUTION	H-Freq. (kHz)	V-Freq. (Hz)
D-VGA	640 x 480	31.47	59.94	D-SXGA 2	1280 x 1024	60.276	58.069
D-SVGA	800 x 600	37.879	60.32	D-SXGA 3	1280 x 1024	31.65	29.80
D-XGA	1024 x 768	43.363	60.00				

NOTE : The projector may not project a proper image for D-SXGA 2 and D-SXGA 3 depending on some computers. Specifications are subject to change without notice.

PC ADJUSTMENT

AUTO PC ADJUSTMENT

The Auto PC Adjustment function automatically adjusts Fine sync, Total dots, Horizontal and Vertical picture position to conform to your computer. The Auto PC Adjustment function can be operated as follows.



Auto PC Adj.

- 1 Press the MENU button and the ON-SCREEN MENU will appear. Press the POINT LEFT/RIGHT button to move the red frame pointer to the PC ADJUST Menu icon.
- 2 Press the POINT DOWN button to move the red frame pointer to the AUTO PC Adj. icon and then press the SET button twice. This Auto PC Adjustment can also be executed by pressing the AUTO PC ADJ. button on the Remote Control Unit.

Store adjustment parameters.

Adjustment parameters from Auto PC Adjustment can be memorized in this projector. Once parameters are memorized, setting can be done just by selecting Mode in the PC SYSTEM Menu (P23). Refer to step 3 of the "MANUAL PC ADJUSTMENT" section (P27).

PC ADJUST MENU

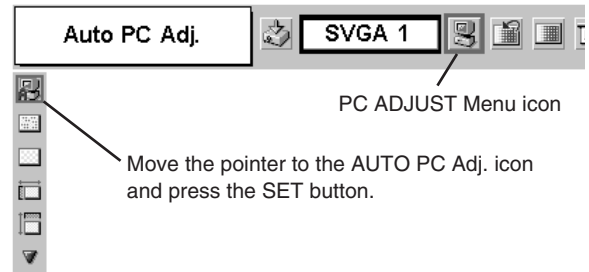

NOTE

- The PC ADJUST Menu cannot be operated when the input signal is digital or RGB is selected in the PC SYSTEM Menu (P23).
- Fine sync, Total dots, Horizontal, and Vertical of some computers cannot be fully adjusted with this Auto PC Adjustment function. When the image is not provided properly through this function, manual adjustments are required. (Refer to page 26, 27.)
- The Auto PC Adjustment function cannot be operated when "720p (HDTV)," "1035i (HDTV)," or "1080i (HDTV)" is selected in the PC SYSTEM Menu (P23).

MANUAL PC ADJUSTMENT

This projector can automatically tune to the display signals of most personal computers. However, some computers employ special signal formats which are different from the standard ones and may not be tuned by the Multi-Scan system of this projector. If this happens, the projector cannot reproduce a proper image and the image may be displayed as a flickering picture, a non-synchronized picture, a non-centered picture, or a skewed picture.

This projector has Manual PC Adjustment to enable you to precisely adjust several parameters to match those special signal formats. This projector has 5 independent memory areas to memorize those parameters manually adjusted. This enables you to recall the setting for a specific computer whenever you use it.

1 Press the MENU button and the ON-SCREEN MENU will appear. Press the POINT LEFT/RIGHT button to move the red frame pointer to the PC ADJUST Menu icon.

2 Press the POINT DOWN button to move the red frame pointer to the item that you want to adjust and then press the SET button. The adjustment dialog box will appear. Press the POINT LEFT/RIGHT button to adjust the value.

Fine sync

Adjusts an image as necessary to eliminate flicker from the display. Press the POINT LEFT/RIGHT button to adjust the value. (From 0 to 31.)

Total dots

The number of total horizontal dots in your picture. Press the POINT LEFT/RIGHT button(s) and adjust number to match your PC image.

Horizontal

Adjusts the horizontal picture position. Press the POINT LEFT/RIGHT button(s) to adjust the position.

Vertical

Adjusts the vertical picture position. Press the POINT LEFT/RIGHT button(s) to adjust the position.

Current mode

Press the SET button to show the information of your computer.

Clamp

Adjusts the clamp level. When the image has a dark bar(s), try this adjustment.

PC ADJUST MENU

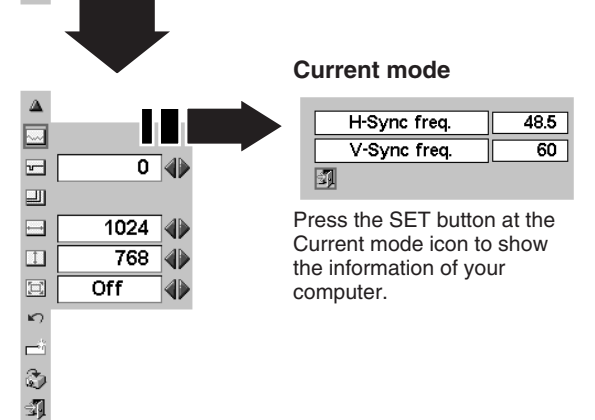
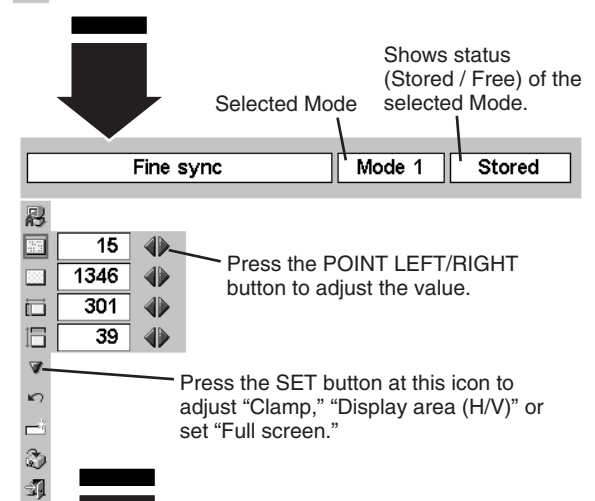
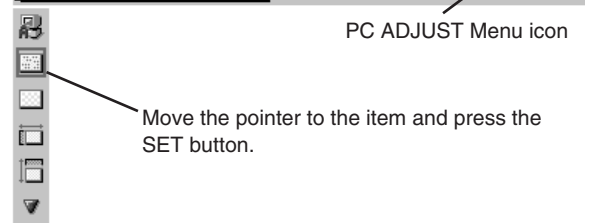

Display area

Selects the area displayed with this projector. Select the resolution at the display area dialog box.

Display area H

Adjustment of the horizontal area displayed with this projector. Press the POINT LEFT/RIGHT button(s) to decrease/increase the value.

Display area V

Adjustment of the vertical area displayed with this projector. Press the POINT LEFT/RIGHT button(s) to decrease/increase the value.

Full screen

Press the POINT LEFT/RIGHT button(s) to turn the Full screen function "On" or "Off." Set "On" to resize the image with 4 x 3 aspect ratio to fit the screen.

NOTE : Full screen cannot be selected after Display area, Display area H, and Display area V are adjusted.

3 Store

To store the adjustment parameters, move the red frame pointer to the Store icon and then press the SET button. Move the red arrow pointer to any of Mode 1 to 5 that you want to store and then press the SET button.

Mode free

To clear the adjustment parameters previously set, move the red frame pointer to the Mode free icon and then the SET button. Move the red arrow pointer to the Mode that you want to clear and then press the SET button.

Other icons operate as follows.

Reset

Reset all adjustment parameters on the adjustment dialog box to the previous figure.

Quit

Closes the PC ADJUST Menu.

NOTE

- Fine sync, Total dots, Display area (H/V) and Full screen cannot be adjusted when "1035i (HDTV)" or "1080i (HDTV)" is selected on PC SYSTEM Menu (P23).

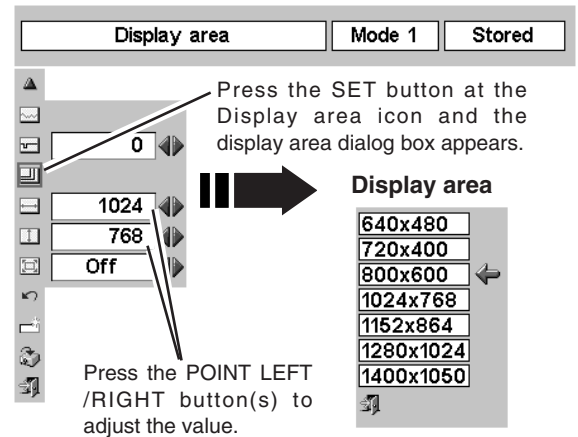

To store the adjustment data.

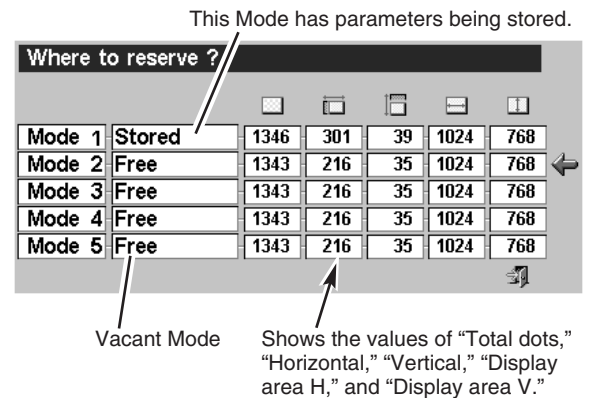

To clear the adjustment data.

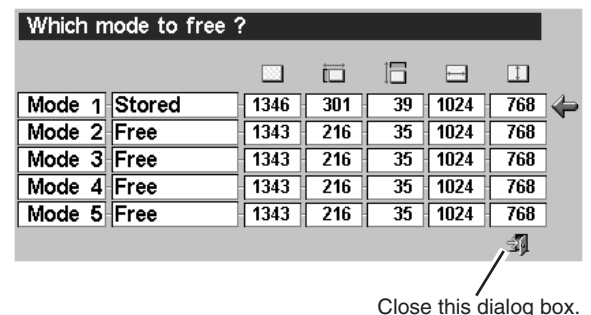

PICTURE IMAGE ADJUSTMENT

IMAGE LEVEL SELECT (DIRECT)

Select the image level among Standard, High contrast, and Custom by pressing the IMAGE button on the Remote Control Unit.

Standard

Normal picture adjustment preset on this projector.

High contrast

Picture adjustment improved in reproduction of the halftones. This adjustment is suitable for providing a better image in a brighter place.

Custom

User preset picture adjustment in the IMAGE ADJUST Menu (P29, 30).

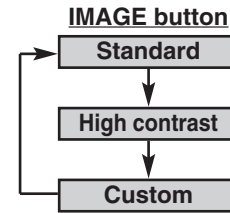

IMAGE LEVEL SELECT (MENU)

- 1 Press the MENU button and the ON-SCREEN MENU will appear. Press the POINT LEFT/RIGHT button to move the red frame pointer to the IMAGE SELECT Menu icon.
- 2 Press the POINT DOWN button to move the red frame pointer to the level that you want to set and then press the SET button.



Standard

Normal picture adjustment preset on this projector.



High contrast

Picture adjustment improved in reproduction of the halftones. This adjustment is suitable for providing a better image in a brighter place.



Custom

User preset picture adjustment in the IMAGE ADJUST Menu (P29, 30).

IMAGE SELECT MENU

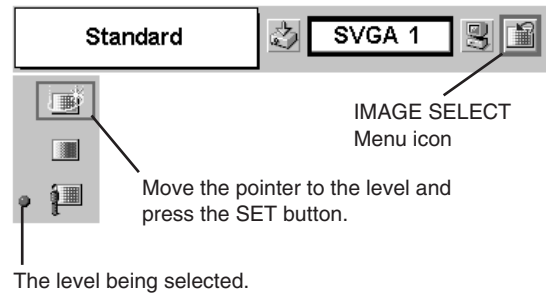

IMAGE LEVEL ADJUSTMENT

- 1 Press the MENU button and the ON-SCREEN MENU will appear. Press the POINT LEFT/RIGHT buttons to move the red frame pointer to the IMAGE ADJUST Menu icon.
- 2 Press the POINT DOWN button to move the red frame pointer to the item that you want to adjust, and then press the SET button. The level of each item is displayed. Adjust each level by pressing the POINT LEFT/RIGHT button(s).

Contrast

Press the POINT LEFT button to decrease the contrast, and the POINT RIGHT button to increase the contrast. (From 0 to 63.)

Brightness

Press the POINT LEFT button to adjust the image darker, and the POINT RIGHT button to adjust the image brighter. (From 0 to 63.)

Color

Press the POINT LEFT button to lighten the color, and the POINT RIGHT button to darken the color. (From 0 to 63.)

Tint

Press the POINT LEFT button or the POINT RIGHT button to obtain a proper color. (From 0 to 63.)

White balance (Red)

Press the POINT LEFT button to lighten the red tone and the POINT RIGHT button to darken the tone. (From 0 to 63.)

White balance (Green)

Press the POINT LEFT button to lighten the green tone and the POINT RIGHT button to darken the tone. (From 0 to 63.)

White balance (Blue)

Press the POINT LEFT button to lighten the blue tone and the POINT RIGHT button to darken the tone. (From 0 to 63.)

Sharpness

Press the POINT LEFT button to soften the image, and the POINT RIGHT button to sharpen the image. (From 0 to 15.)

Gamma

Press the POINT LEFT button or the POINT RIGHT button to obtain a better balance of the contrast. (From 0 to 15.)

Auto grayscale

When this function is "ON," it automatically enhances the contrast of the bright and dark part of image.

Auto fleshtone

When this function is "ON," it produces a more vivid image according to the image condition.

IMAGE ADJUST MENU

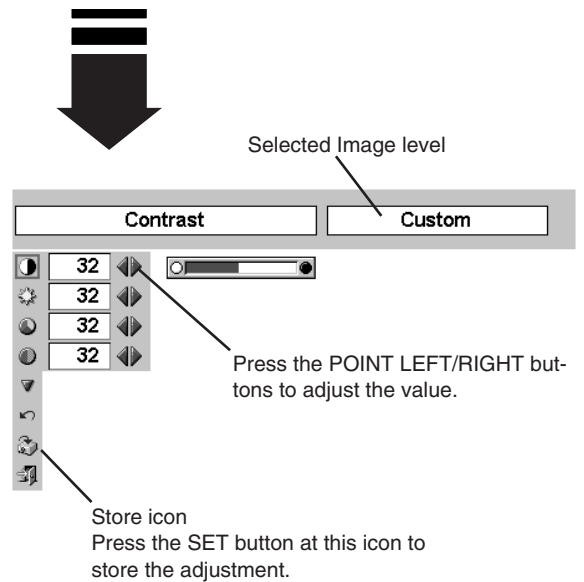
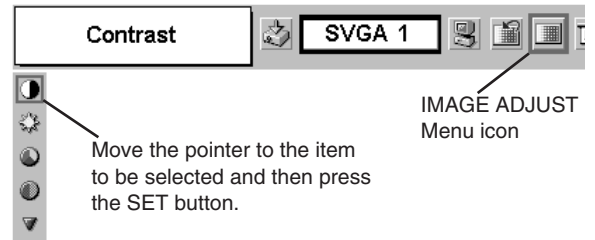

NOTE

- Auto grayscale cannot be operated when the input signal is digital.

3 **Store**

To store the manual image level, move the red frame pointer to the Store icon and press the SET button. The message “OK?” will appear. Select [Yes] to store manual adjustment. To set this manual adjustment, select Custom by pressing the IMAGE button or through the IMAGE SELECT Menu (refer to P28).

Other icons operate as follows.

Reset

Reset all adjustments to the previous figure.

Quit

Closes the IMAGE Menu.

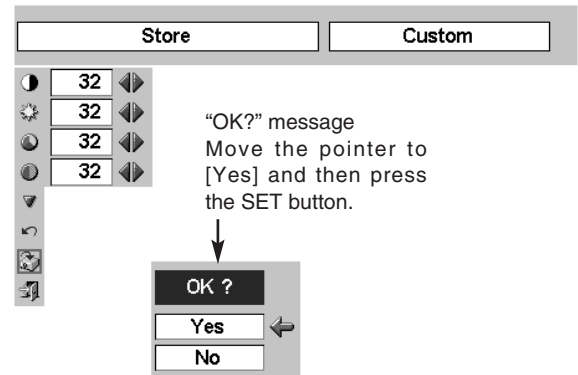

PICTURE SCREEN ADJUSTMENT

This projector has the picture screen resize function, which enables you to display the desirable image size.

- 1 Press the MENU button and the ON-SCREEN MENU will appear. Press the POINT LEFT/RIGHT button(s) to move the red frame pointer to the SCREEN Menu icon.
- 2 Press the POINT DOWN button and move the red frame pointer to the function that you want to select and then press the SET button.

Normal

Provides the image to fit the screen size.

True

Provides the image in its original size. When the original image size is larger than the screen size (800 x 600), this projector enters “Digital zoom +” mode automatically.

Wide

Provides the image to fit a wide video aspect ratio (16 : 9) by expanding the image width uniformly. This function can be used for providing a squeezed video signal at 16 : 9.

Digital zoom +

When Digital zoom + is selected, the ON-SCREEN MENU disappears and the message “D. Zoom +” is displayed. Press the SET button to expand the image size. And press the POINT UP/DOWN/LEFT/RIGHT button(s) to pan the image. The Panning function can work only when the image is larger than the screen size. A projected image can also be expanded by pressing the D.ZOOM ▲ button on the Remote Control Unit.

Digital zoom -

When Digital zoom - is selected, the ON-SCREEN MENU disappears and the message “D. Zoom -” is displayed. Press the SET button to compress the image size. A projected image can also be compressed by pressing the D.ZOOM ▼ button on the Remote Control Unit.

To cancel Digital zoom +/- mode, press any button except D.ZOOM ▲/▼, SET, POINT and LASER buttons.

SCREEN MENU

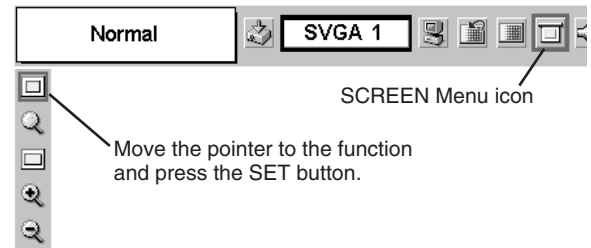

NOTE

- This SCREEN Menu cannot be operated when “1035i (HDTV)” or “1080i (HDTV)” is selected on the PC SYSTEM Menu (P23).
- Wide cannot be selected when “720p (HDTV)” is selected on the PC SYSTEM Menu (P23).
- True and Digital zoom +/- cannot be selected when “RGB” is selected on the PC SYSTEM Menu (P23).
- This projector cannot display any resolution higher than 1024 x 768. If your computer’s screen resolution is higher than 1024 x 768, lower the resolution before connecting the projector.
- The image data in other than SVGA (800 x 600) is modified to fit the screen size.
- The Panning function may not operate properly if the computer system set on the PC ADJUST Menu is used.

SELECTING THE INPUT SOURCE

DIRECT OPERATION

Choose Video by pressing the INPUT button on the Top Control or on the Remote Control Unit.

If the projector cannot reproduce a proper video source, select correct input source through the "MENU OPERATION" (see below).

RGB Scart Input

To select RGB Scart 21-Pin video input through RGB IN 1 / OUT terminal, see the "COMPUTER INPUT (RGB Scart 21-Pin Video Input)" on page 22.

INPUT button

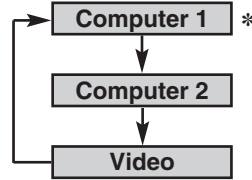

* Computer 1 is not displayed when RGB IN 1/ OUT terminal is used as MONITOR OUT.

MENU OPERATION

- 1 Press the MENU button and the ON-SCREEN MENU will appear. Press the POINT LEFT/RIGHT button to move the red frame pointer to the INPUT Menu icon.
- 2 Press the POINT DOWN button to move the red arrow pointer to Video and then press the SET button. The Source Select Menu will appear.
- 3 Move the pointer to the source that you want to select and then press the SET button.

INPUT MENU

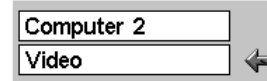

Move the pointer to Video and press the SET button.

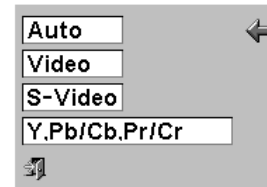

Source Select Menu (VIDEO)

Move the pointer to the source and press the SET button.

Auto When selecting Auto, the projector automatically detects the incoming video signal, and adjusts itself to optimize its performance. The projector selects the connection in the following order:
1st Y-Pb/Cb-Pr/Cr
2nd S-VIDEO
3rd VIDEO
Y-Pb/Cb-Pr/Cr has priority over S-VIDEO. S-VIDEO has priority over VIDEO.

Video When the video input signal is connected to VIDEO/Y jack, select Video.

S-Video When the video input signal is connected to S-VIDEO jack, select S-Video.

Y,Pb/Cb,Pr/Cr When the video input signal is connected to VIDEO/Y-Pb/Cb-Pr/Cr jacks, select Y, Pb/Cb, Pr/Cr.

* Computer 1 is not displayed when RGB IN 1/ OUT terminal is used as MONITOR OUT.

SELECTING THE VIDEO SYSTEM

- 1 Press the MENU button and the ON-SCREEN MENU will appear. Press the POINT LEFT/RIGHT buttons to move the red frame pointer to the AV SYSTEM Menu icon.
- 2 Press the POINT DOWN button to move the red arrow pointer to the system that you want to select and then press the SET button.

VIDEO/Y JACK OR S-VIDEO JACK

Auto

The projector automatically detects the incoming video system, and adjusts itself to optimize its performance. When the video system is PAL-M or PAL-N, select system manually.

PAL / SECAM / NTSC / NTSC4.43 / PAL-M / PAL-N

If the projector cannot reproduce a proper video image, it is necessary to select a specific broadcast signal format among PAL, SECAM, NTSC, NTSC 4.43, PAL-M, and PAL-N.

AV SYSTEM MENU (VIDEO OR S-VIDEO)

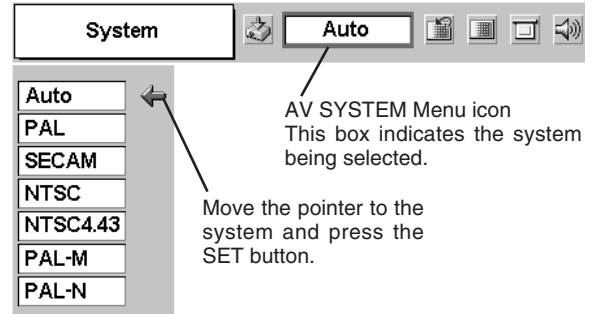

VIDEO/Y, Pb/Cb, Pr/Cr JACKS

Auto

The projector automatically detects the incoming video signal, and adjusts itself to optimize its performance.

COMPONENT VIDEO SIGNAL FORMAT

If the projector cannot reproduce a proper video image, it is necessary to select a specific component video signal format among 480i, 575i, 480p, 575p, 720p, 1035i and 1080i.

AV SYSTEM MENU (COMPONENT VIDEO)

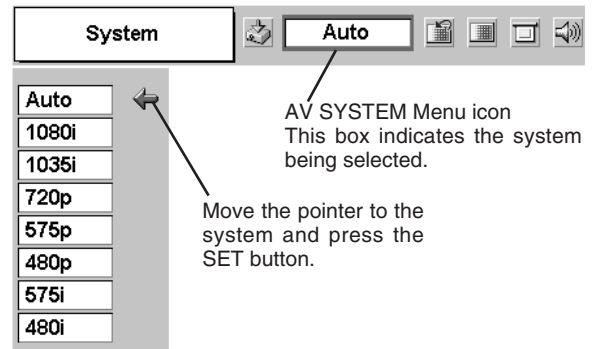

PICTURE IMAGE ADJUSTMENT

IMAGE LEVEL SELECT (DIRECT)

Select the image level among Standard, Cinema, and Custom by pressing the IMAGE button on the Remote Control Unit.

Standard

Normal picture level preset on this projector.

Cinema

Picture level adjusted for the picture with fine tone.

Custom

User preset picture adjustment in the IMAGE ADJUST Menu (P34, 35).

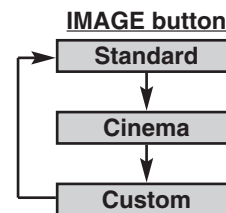

IMAGE LEVEL SELECT (MENU)

- 1 Press the MENU button and the ON-SCREEN MENU will appear. Press the POINT LEFT/RIGHT button to move the red frame pointer to the IMAGE SELECT Menu icon.
- 2 Press the POINT DOWN button to move the red frame pointer to the level that you want to set and then press the SET button.



Standard

Normal picture level preset on this projector.



Cinema

Picture level adjusted for the picture with fine tone.



Custom

User preset picture adjustment in the IMAGE ADJUST Menu (P34, 35).

IMAGE SELECT MENU

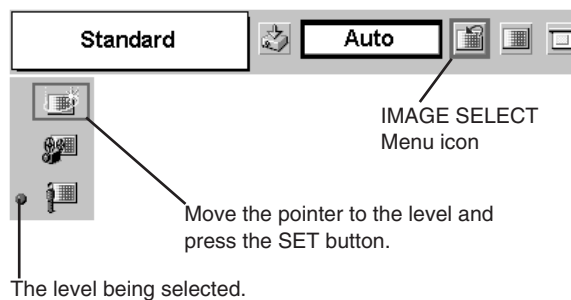

IMAGE LEVEL ADJUSTMENT

- 1 Press the MENU button and the ON-SCREEN MENU will appear. Press the POINT LEFT/RIGHT button(s) to move the red frame pointer to the IMAGE ADJUST Menu icon.
- 2 Press the POINT DOWN button to move the red frame pointer to the item that you want to adjust and then press the SET button. The level of each item is displayed. Adjust each level by pressing the POINT LEFT/RIGHT button(s).

Contrast

Press the POINT LEFT button to decrease the contrast, and the POINT RIGHT button to increase the contrast. (From 0 to 63.)

Brightness

Press the POINT LEFT button to adjust the image darker, and the POINT RIGHT button to adjust the image brighter. (From 0 to 63.)

Color

Press the POINT LEFT button to lighten the color, and the POINT RIGHT button to darken the color. (From 0 to 63.)

Tint

Press the POINT LEFT button or the POINT RIGHT button to obtain a proper color. (From 0 to 63.)

White balance (Red)

Press the POINT LEFT button to lighten the red tone and the POINT RIGHT button to darken the tone. (From 0 to 63.)

White balance (Green)

Press the POINT LEFT button to lighten the green tone and the POINT RIGHT button to darken the tone. (From 0 to 63.)

White balance (Blue)

Press the POINT LEFT button to lighten the blue tone and the POINT RIGHT button to darken the tone. (From 0 to 63.)

Sharpness

Press the POINT LEFT button to soften the image, and the POINT RIGHT button to sharpen the image. (From 0 to 15.)

Gamma

Press the POINT LEFT button or the POINT RIGHT button to obtain a better balance of the contrast. (From 0 to 15.)

Auto grayscale

When this function is "ON," it automatically enhances the contrast of the bright and dark part of image.

Auto fleshtone

When this function is "ON," it produces a more vivid image according to the image condition.

IMAGE ADJUST MENU

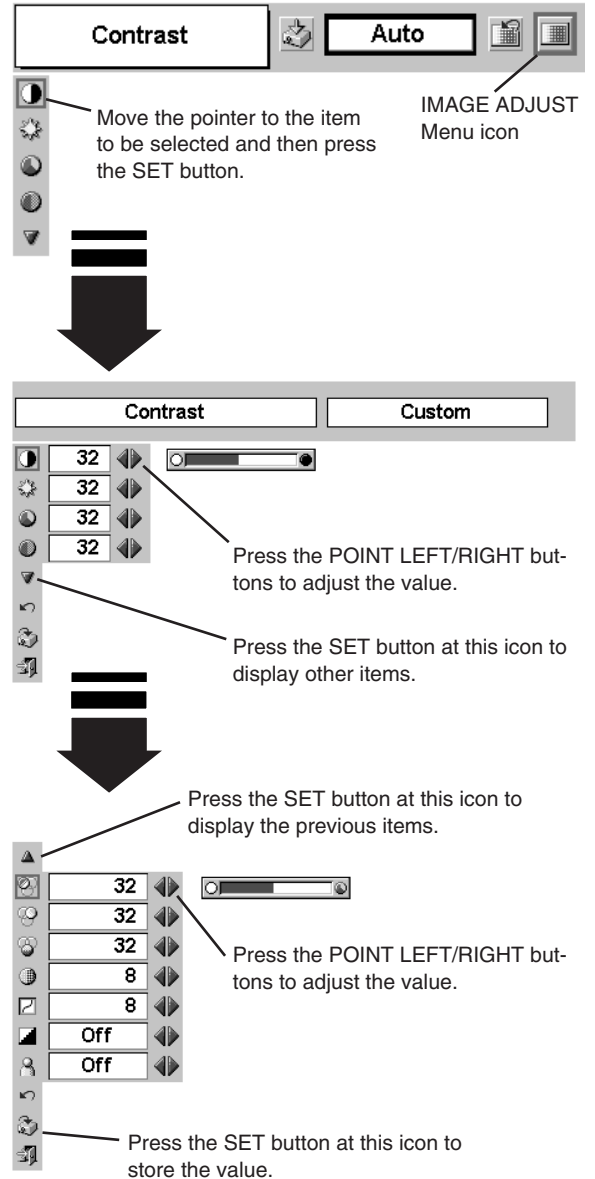

NOTE

- Tint cannot be adjusted when the video system is PAL, SECAM, PAL-M or PAL-N.

3  **Store**

To store the manual image level, move the red frame pointer to the Store icon and press the SET button. The message “OK?” will appear. Select [Yes] to store manual adjustment. To set this manual adjustment, select Custom by pressing the IMAGE button or through the IMAGE SELECT Menu (refer to P33).

Other icons operate as follows.

 **Reset**

Reset all adjustments to the previous figure.

 **Quit**

Closes the IMAGE Menu.

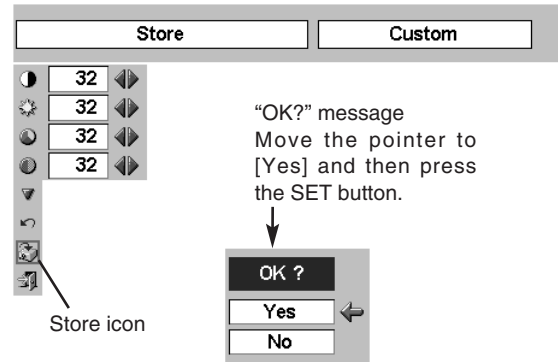

PICTURE SCREEN ADJUSTMENT

This projector has the picture screen resize function, which enables you to display the desirable image size.

- 1** Press the MENU button and the ON-SCREEN MENU will appear. Press the POINT LEFT/RIGHT button(s) to move the red frame pointer to the SCREEN Menu icon.
- 2** Press the POINT DOWN button and move the red frame pointer to the function that you want to select and then press the SET button.

SCREEN MENU

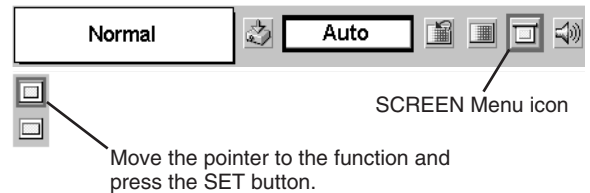

 **Normal**

Provides the image at a normal video aspect ratio of 4 : 3.

 **Wide**

Provides the image at a wide screen ratio of 16 : 9.

NOTE

- The SCREEN Menu cannot be operated when “720p,” “1035i,” or “1080i” is selected on the AV SYSTEM Menu (P32).

SETTING MENU

- 1 Press the MENU button and the ON-SCREEN MENU will appear. Press the POINT LEFT/RIGHT button(s) to move the red frame pointer to the SETTING icon.
- 2 Press the POINT DOWN button to move the red frame pointer to the item that you want to set and then press the SET button. The setting dialog box appears.

Language

The language used in the ON-SCREEN MENU is available in English, German, French, Italian, Spanish, Portuguese, Dutch, Swedish, Russian, Chinese, Korean, and Japanese.

Keystone

This function corrects the distorted image. Select either Store or Reset, and then press the SET button. The keystone dialog box appears. (Refer to page 20.)

- Store stores the keystone adjustment data when the AC Power Cord is disconnected.
- Reset resets the keystone adjustment data when the AC Power Cord is disconnected.

Blue back

When this function is "On," the projector produces a blue image while the input signal is not detected.

Display

This function decides whether to display the On-Screen Displays.

- On ... shows all the On-Screen Displays.
- Off sets the On-Screen Displays disappeared except;
 - ON-SCREEN MENU
 - "Power off?" message
 - P-TIMER
 - "No signal" message
 - "Wait a moment!" message

Logo

When this function is "On," the projector displays our logo when starting up.

Ceiling

When this function is "On," the picture is top / bottom and left / right reversed. This function is used to project the image from a ceiling mounted projector.

Rear

When this function is "On," the picture is left / right reversed. This function is used to project the image to a rear projection screen.

Terminal

RGB IN 1 / OUT terminal on the back of the projector can be used as computer input or monitor output by switching with the POINT LEFT/RIGHT button. (See the right Note.)

- To use the terminal as computer input, select Computer 1.
- To use the terminal as monitor out, select Monitor out.

SETTING MENU

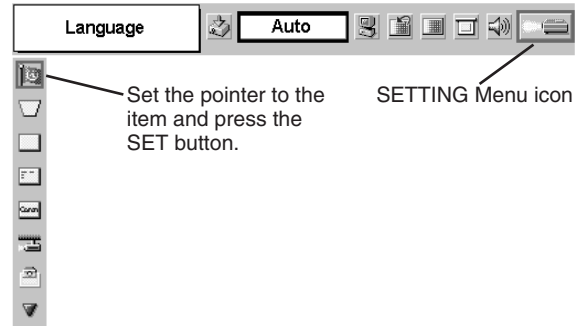

When pressing the SET button at Language, the Language Menu appears.

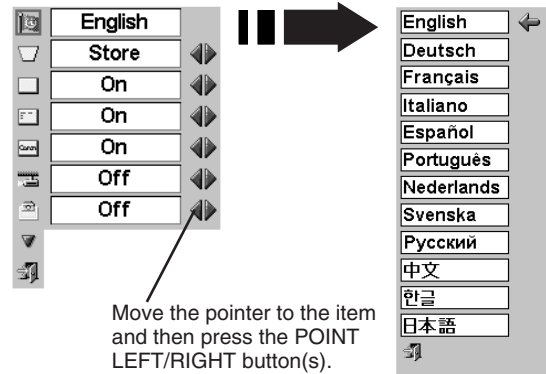

Ceiling function

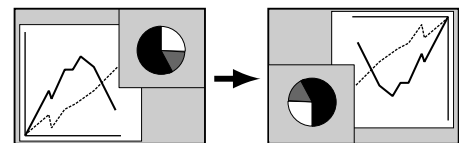

Rear function

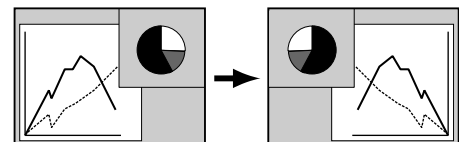

NOTE

- This Terminal item cannot be selected when the input source is selected as "Computer 1" in the "SELECTING THE INPUT SOURCE" (P22).

Power management

This function turns the Projection Lamp off when this projector detects a signal interruption and is not used for a certain period in order to reduce the power consumption and maintain the Lamp-life. (This projector is shipped with this function ON.)

The Power Management function operates to turn the Projection Lamp off when the input signal is interrupted and any button is not pressed over 5 minutes. This function operates as follows;

1. When any input signal is interrupted, "No signal" and the count down display appears (for 5 minutes).
2. After counting down for 5 minutes, the Projection Lamp and the READY Indicator are turned off. (Cooling Fans keep running.)
3. The READY Indicator starts to flash after cooling down the Projection Lamp about for 90 seconds (Power Management mode).

In this Power Management mode, the Projection Lamp is automatically turned on when the input signal is connected or the projector is operated with any button on the Top Control or on the Remote Control Unit again.

On start

When this function is "On," the projector is automatically turned on just by connecting the AC Power Cord to an AC outlet.

NOTE : Be sure to turn the projector off properly (refer to the section "TURNING OFF THE PROJECTOR" on P19). If the projector is turned off in the wrong steps, the On Start function does not operate properly.

Lamp mode

When selecting the "  " (Silent), the projector reduces the brightness and sets into the low power consumption mode.

Remote control

This projector has two different remote control codes; the factory-set normal code (Code 1) and the secondary code (Code 2). This switching function prevents remote control interference when operating several projectors or video equipment together.

When operating the projector in "Code 2," both the projector and the Remote Control Unit must be switched to "Code 2."

To change the code of the Projector;

Set the Remote control in the SETTING Menu to "Code 2."

To change the code of the Remote Control Unit;

Press both the MENU and the IMAGE buttons on the Remote Control Unit together for over 10 seconds.

After changing the code, make sure the Remote Control Unit operates properly.

To return to the normal code (Code 1), repeat the steps above.

NOTE : When the batteries of the Remote Control Unit are replaced or ALL-OFF switch is turned to "ALL-OFF," the remote control code automatically returns to the normal code (Code 1).

Lamp counter reset

This function is used to reset the Lamp Replace Counter. When replacing the Projection Lamp, reset the Lamp Replace Counter by using this function. Refer to page 39 for operation.

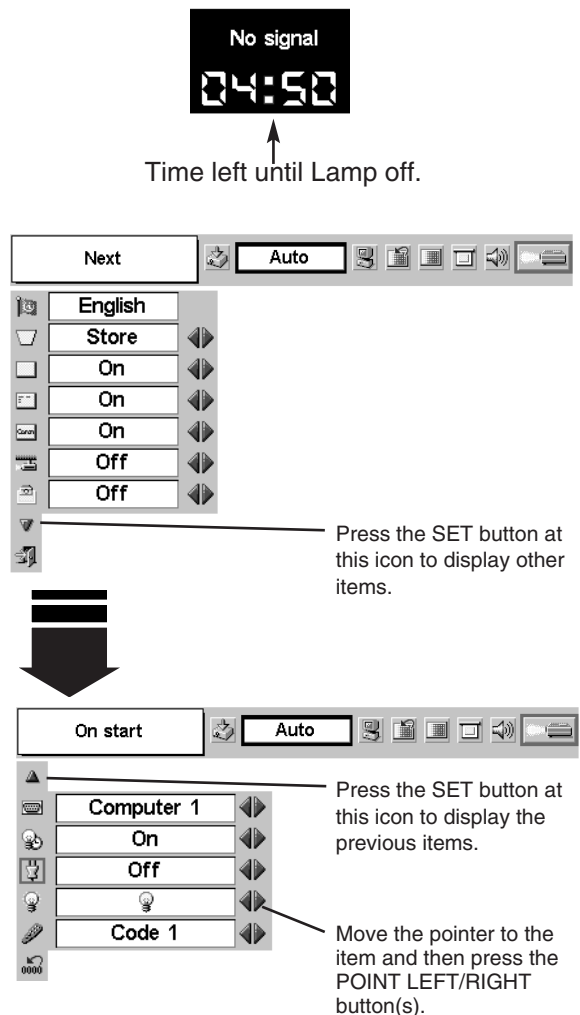

LAMP REPLACEMENT

LAMP REPLACE

When the life of the Projection Lamp of this projector draws to an end, the LAMP REPLACE indicator lights yellow. If this indicator lights yellow, replace the Projection Lamp with a new one promptly.

TOP CONTROL

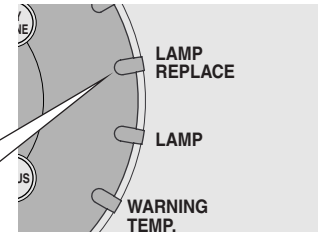

This indicator lights yellow when the life of the Projection Lamp draws to an end. Replace the Projection Lamp with a new one promptly.



Allow the projector to cool, for at least 45 minutes before you open the Lamp Cover. The inside of the projector can become very hot.



CAUTION

For continued safety, replace with a lamp assembly of the same type.

Do not drop the lamp assembly or touch the glass bulb! The glass can shatter and may cause injury.

Follow these steps to replace the lamp assembly.

- 1 Turn off the projector and disconnect the AC plug. Allow the projector to cool for at least 45 minutes.
- 2 To remove the Lamp Cover, remove the screw with a screwdriver.
- 3 Loosen 3 screws with a screwdriver and pull out the Lamp Assembly by grasping the Handle.
- 4 Replace the Lamp Assembly with a new one and tighten 3 screws back into position. Make sure the Lamp Assembly is set properly. Replace The Lamp Cover and tighten the screw.
- 5 Connect the AC Power Cord to the projector and turn on the projector.
- 6 **Reset the Lamp Replace Counter.**
Refer to the "LAMP REPLACE COUNTER" on the next page .

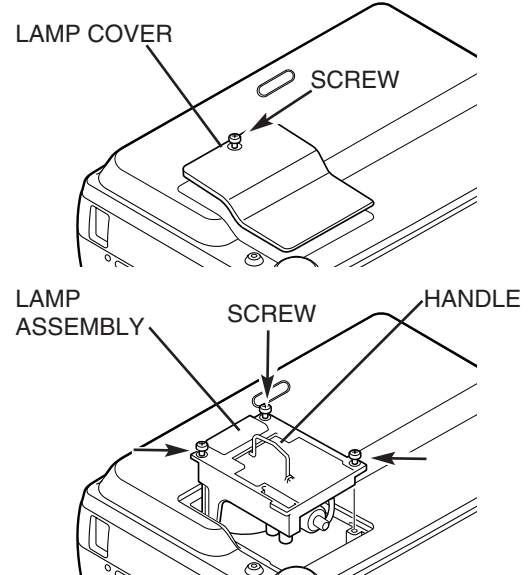

ORDER REPLACEMENT LAMP

The Replacement Lamp can be ordered through your dealer. When ordering a Projection Lamp, give the following information to the dealer.

- **Model No. of your projector** : **LV-5200**
- **Replacement Lamp Type No.** : **LV-LP16**
(610 303 5826)

LAMP REPLACE COUNTER

Be sure to reset the Lamp Replace Counter after the Lamp Assembly is replaced. When the Lamp Replace Counter is reset, the LAMP REPLACE Indicator stops lighting.

- 1 Turn the projector on, press the MENU button and the ON-SCREEN MENU will appear. Press the POINT LEFT/RIGHT button(s) to move the red frame pointer to the SETTING Menu icon (refer to page 36, 37).
- 2 Press the POINT DOWN button to move the red frame pointer to "Lamp counter reset" and then press the SET button. The message "Lamp replace counter reset?" is displayed. Move the red arrow pointer to [Yes] and then press the SET button.
- 3 Another confirmation dialog box appears and select [Yes] to reset the Lamp Replace Counter.

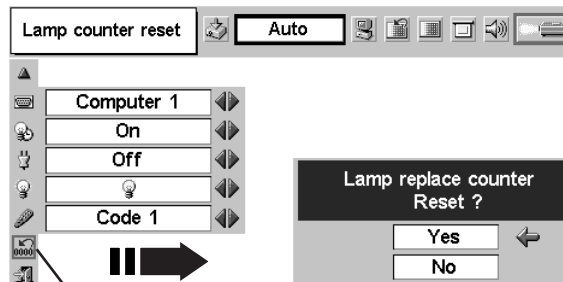

Move the pointer to the Lamp counter reset icon and then press the SET button. The message "Lamp replace counter reset?" is displayed.

NOTE : Do not reset the Lamp Replace Counter until after the Projection Lamp is replaced.



LAMP HANDLING PRECAUTIONS

This projector uses a high-pressure lamp which must be handled carefully and properly. Improper handling may result in accidents, injury, or create fire hazard.

- Lamp lifetime may differ from lamp to lamp and according to the environment of use. There is no guarantee of the same lifetime for each lamp. Some lamps may fail or terminate their lifetime in a shorter period of time than other similar lamps.
- If the projector indicates that the lamp should be replaced, i.e., if the LAMP REPLACE INDICATOR lights up, replace the lamp with a new one IMMEDIATELY after the projector has cooled down. (Follow carefully the instructions in the LAMP REPLACEMENT section of this manual.) Continuous use of the lamp with the LAMP REPLACE INDICATOR lighted may increase the risk of lamp explosion.
- A Lamp may explode as a result of vibration, shock or degradation as a result of hours of use as its lifetime draws to an end. Risk of explosion may differ according to the environment or conditions in which the projector and lamp are being used.

IF A LAMP EXPLODES, THE FOLLOWING SAFETY PRECAUTIONS SHOULD BE TAKEN.

If a lamp explodes, disconnect the projector's AC plug from the AC outlet immediately. Contact an authorized service station for a checkup of the unit and replacement of the lamp. Additionally, check carefully to ensure that there are no broken shards or pieces of glass around the projector or coming out from the cooling air circulation holes. Any broken shards found should be cleaned up carefully. No one should check the inside of the projector except those who are authorized trained technicians and who are familiar with projector service. Inappropriate attempts to service the unit by anyone, especially those who are not appropriately trained to do so, may result in an accident or injury caused by pieces of broken glass.

OPERATING WIRELESS MOUSE

The Remote Control Unit is not only able to operate this projector but also usable as a wireless mouse for most Personal Computers. The POINT buttons and two CLICK buttons are used for wireless mouse operation.

This Wireless Mouse function is available only when PC mouse pointer is displayed on a projected screen. When the ON-SCREEN MENU or any message / dialog box is displayed on the screen instead of PC mouse pointer, this Wireless Mouse function cannot be used.

INSTALLATION

To use the Remote Control Unit as Wireless Mouse for a Personal Computer, installation of the mouse driver (not supplied) is required. Make sure that the mouse driver is properly installed in your computer and that the mouse port (or USB port) of your computer is activated.

- 1 Connect the mouse port (or USB port) of your computer to Control Port (or USB connector) of this projector with the Control Cable (or USB cable). (Refer to page 11, 12 for connection.)
- 2 Turn the projector on first, and then turn on your computer. When the computer is switched on first, Wireless Mouse may not work properly.

Note : When your computer has no mouse port, connect the Serial Port of your computer to the Control Port of the projector with the Control Cable for the Serial Port (not supplied).

OPERATING WIRELESS MOUSE

When controlling a PC mouse pointer, operate Wireless Mouse with the POINT button, SET button, and RIGHT CLICK button on the Remote Control Unit.

POINT button

Used to move PC mouse pointer. The pointer is moved corresponding with the direction you are pressing.

SET (LEFT CLICK) button

This button has the same function as the left button in a PC mouse.

RIGHT CLICK button

This button has the same function as the right button in a PC mouse. This button is not available for controlling this projector.

POINT button (Move the pointer)

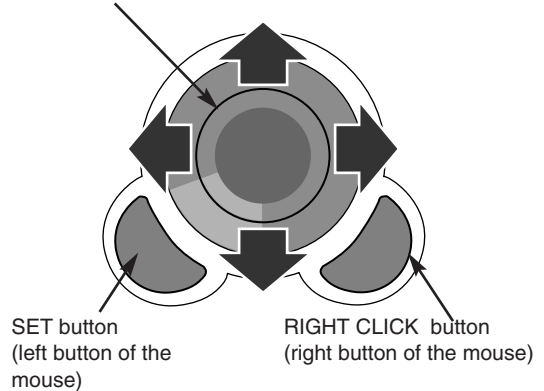

MAINTENANCE

WARNING TEMP. INDICATOR

The WARNING TEMP. Indicator flashes red when an internal temperature of the projector exceeds the normal temperature. When the WARNING TEMP. Indicator continues to flash, check the items listed below.

- 1 The Ventilation Slots of the projector may be blocked. In such an event, reposition the projector so that the Ventilation Slots are not obstructed.
- 2 The Air Filter may be clogged with dust particles. Clean the Air Filter by following the section "AIR FILTER CARE AND CLEANING" below.
- 3 If the WARNING TEMP. Indicator remains on after performing the above checks, the Cooling Fans or the Internal Circuits may be malfunctioning. Contact service personnel from an authorized dealer or a service station.

AIR FILTER CARE AND CLEANING

The Removable Air Filter prevents dust from accumulating on the surface of the Projection Lens and the Projection Mirror. Should Air Filter become clogged with dust particles, it will reduce the Cooling Fans' effectiveness and may result in internal heat build up and adversely affect the life of the projector. Clean the Air Filter following the steps below:

- 1 Turn off the projector, and disconnect the AC Power Cord from the AC outlet.
- 2 Turn the projector upside down and remove the Air Filter by pulling the latches upward.
- 3 Clean the Air Filter with a brush or wash out dust and particles.
- 4 Replace the Air Filter properly. Make sure the Air Filter is fully inserted.



CAUTION

Do not operate the projector with the Air Filter removed. Dust may accumulate on the LCD Panel and the Projection Mirror, and may degrade the picture quality. Do not put small parts into the Air Intake Vents. It may result in malfunction of the projector.

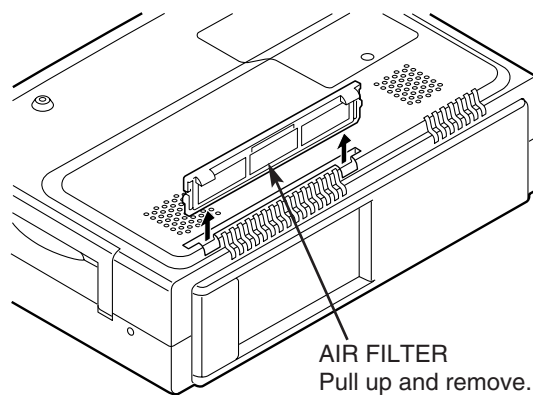

RECOMMENDATION

We recommend avoiding dusty/smoky environment when operating the projector. Operating in these environments may cause poor image quality.

When using under dusty or smoky conditions, dust may accumulate on the lens, liquid crystal panels, or optical elements inside the projector. This condition may degrade the quality of a projected image.

When the above symptoms are noticed, contact your authorized dealer or service station for proper cleaning.

CLEANING PROJECTION LENS

Follow these steps to clean the Projection Lens:

- 1 Apply a non-abrasive camera lens cleaner to a soft, dry cleaning cloth. Avoid using an excessive amount of cleaner. Abrasive cleaners, solvents or other harsh chemicals might scratch the lens.
- 2 Lightly wipe a cleaning cloth over the Projection Lens.
- 3 When the projector is not in use, attach the Lens Cover.

TROUBLESHOOTING

Before calling your dealer or service center for assistance, check the following:

- Make sure you have connected the projector to peripheral equipment as described properly in the section “CONNECTING THE PROJECTOR” on pages 11 ~ 13.
- Verify that all computer, video and power cord are properly connected and turn the equipment on.
- When you are operating the projector with a computer and it does not produce an image, restart the computer.
- Select the other input source.

Problem:	Try these Solutions
No power.	<ul style="list-style-type: none"> ● Plug the projector into an AC outlet. ● Make sure the READY Indicator lights. ● Wait 90 seconds after the projector is turned OFF before turning the projector back on. <p>NOTE : After pressing the Power ON-OFF button to OFF, make sure the projector works as follows:</p> <ol style="list-style-type: none"> 1. The LAMP indicator lights bright and the READY indicator turns off. 2. After 90 seconds, the READY indicator lights green again and the projector can be turned on by pressing the Power ON-OFF button. <ul style="list-style-type: none"> ● Check the WARNING TEMP. indicator. If this indicator flashes red, the projector cannot be turned on. (See the “TURNING ON/OFF THE PROJECTOR” section on page 19.) ● Check the Projection Lamp. (Refer to page 38.)
Image is out of focus.	<ul style="list-style-type: none"> ● Adjust the focus of the projector. ● Make sure a projection screen is at least 3.6' (1.1m) from the projector. ● Check the Projection Lens to see if it needs cleaning. <p>NOTE : Moving the projector from a cool temperature location to a warm temperature location may result in moisture condensation on the Projection Lens. In such an event, leave the projector OFF and wait until condensation disappears.</p>
Picture is Left/Right reversed.	<ul style="list-style-type: none"> ● Check Ceiling / Rear feature. (See the “SETTING” section on page 36.)
Picture is Top/Bottom reversed.	<ul style="list-style-type: none"> ● Check Ceiling feature. (See the “SETTING” section on page 36.)
Some displays are not seen during the Operation.	<ul style="list-style-type: none"> ● Check Display feature.(See the “SETTING” section on page 36.)
No image.	<ul style="list-style-type: none"> ● Check the connection between your computer or video equipment and the projector. ● Check the NO SHOW function. (Refer to P21.) ● When turning the projector on, it takes about 30 seconds to display an image. ● Check the system that you select is corresponding with your computer or video equipment. ● Make sure the temperature is not out of the Operating Temperature (5°C ~ 35°C).
No sound.	<ul style="list-style-type: none"> ● Check the audio cable connection from the audio input source. ● Adjust the audio source. ● Press the VOLUME (+) button. ● Press the MUTE button.
Computer 1 cannot be selected.	<ul style="list-style-type: none"> ● Check RGB IN 1 / OUT terminal is set as COMPUTER 1. (See the “SETTING” section on page 36.)

Problem:	Try these Solutions
Remote Control Unit does not work.	<ul style="list-style-type: none"> ● Check the batteries. ● Check ALL-OFF switch on the Remote Control Unit is set to "ON." ● Make sure nothing is between the Infrared Remote Receiver and the Remote Control Unit. ● Make sure you are not too far from the projector when using the Remote Control Unit. Maximum operating range is 16.4' (5m). ● Make sure the code of the Remote Control Unit is set to conform to the projector. (See the "SETTING" section on page 37.)
Wireless Mouse function does not work.	<ul style="list-style-type: none"> ● Check the cable connection between the projector and your computer. ● Check the mouse setting on your computer. ● Turn the projector on before turning on your computer.

**WARNING :**

High voltages are used to operate this projector. Do not attempt to open the cabinet.

If the problem still persists after following all operating instructions, contact the sales dealer where you purchased the projector or the service center. Give the model number and explain the problem in detail. We will advise you how to obtain service.



This symbol on the nameplate means the product is Listed by Underwriters Laboratories Inc. It is designed and manufactured to meet rigid U.L. safety standards against risk of fire, casualty and electrical hazards.



The CE Mark is a Directive conformity mark of the European Community. (EC)

INDICATORS AND PROJECTOR CONDITION

Check the Indicators for the projector condition.

Indicators				Projector Condition
LAMP REPLACE yellow	WARNING TEMP. red	READY green	LAMP red	
●	●	●	●	The projector is OFF. (The AC Power Cord is unplugged.)
*	●	○	○	The projector is READY to be turned on with the POWER ON-OFF button.
*	●	○	●	The projector is operating normally.
*	○ [⚡]	●	○	The temperature inside the projector is abnormally high. The projector cannot be turned on. When the projector is cooled down enough and the temperature returns to normal, the READY indicator lights green and the projector can be turned on. (The WARNING TEMP. indicator keeps flashing.) Check and clean the Air Filter.
*	○ [⚡]	○	○	The projector is cooled down enough and the temperature returns to normal. When turning on the projector, the WARNING TEMP. indicator stops flashing. Check and clean the Air Filter.
*	●	●	○	The projector is being cooled down. It cannot be turned on until the READY indicator lights green.
*	○ [⚡]	○ [⚡]	○	The projector detects an abnormal condition and cannot be turned on. Unplug the AC Power Cord and plug it again to turn on the projector. If the projector is turned off again, disconnect the AC Power Cord and contact the dealer or the service center for service and checkup. Do not leave the projector on. It may cause electric shock or fire hazard.
*	●	○ [⚡]	●	The projector is in the Power management mode.

○ ●●● on ○[⚡] ●●● flashing ●●● dim ●●● off

* When the life of the Projection Lamp draws to an end, the LAMP REPLACE indicator lights yellow. When this indicator lights yellow, replace the Projection Lamp with a new one promptly. Reset the Lamp Replace Counter after replacement of the lamp.

TECHNICAL SPECIFICATIONS

Projector Type	Multi-media Projector
Dimensions (W x H x D)	13.05" x 3.52" x 9.61" (331.5mm x 89.5mm x 244.1mm) (not including Adjustable Feet)
Net Weight	9.48 lbs (4.3 kg)
LCD Panel System	0.8" TFT Active Matrix type, 3 panels
Panel Resolution	800 x 600 dots
Number of Pixels	1,440,000 (800 x 600 x 3 panels)
Color System	PAL, SECAM, NTSC, NTSC4.43, PAL-M and PAL-N
High Definition TV Signal	480i, 480p, 575i, 575p, 720p, 1035i, and 1080i
Scanning Frequency	H-sync. 15 ~ 80 KHz, V-sync. 50 ~ 100 Hz
Projection Image size (Diagonal)	Adjustable from 24" to 300"
Horizontal Resolution	500 TV lines (S-Video)
Projection Lens	F 1.7 ~ 2.44 lens with f 25.7 mm ~ 37.9 mm with motor zoom and focus
Throw Distance	3.6' ~ 31.8' (1.1 m ~ 9.7 m)
Projection Lamp	180 W
Video Input Jacks	RCA Type x 3 (Video/Y, Pb/Cb, Pr/Cr) and Mini DIN 4 pin x 1 (S-Video)
Audio Input Jacks	RCA Type x 2
RGB Input Terminal	DVI-I Terminal (Digital/Analog)x 1
RGB Input / Output Terminal	(VGA) HDB 15 Terminal(Analog) x 1 (This terminal is switchable.)
Computer Audio Input Jack	Mini Jack (stereo) x 1
Control Port Connector	Mini DIN 8 pin x 1
USB Connector	USB Series B receptacle x 1
Audio Output Jacks	RCA Type x 2
Internal Audio Amp	1.0 W RMS
Built-in Speakers	1 speaker, 1.18" x 1.57" (30mm x 40mm)
Feet Adjustment	0° to 15.6°
Voltage and Power Consumption	AC 100 ~ 120 V (3.0 A Max. Ampere), 50 / 60 Hz (The U.S.A and Canada) AC 200 ~ 240 V (1.5 A Max. Ampere), 50 / 60 Hz (Continental Europe)
Operating Temperature	41 °F ~ 95 °F (5 °C ~ 35 °C)
Storage Temperature	14 °F ~ 140 °F (-10 °C ~ 60 °C)
Remote Control Unit	Power Source : AA, UM3 or R06 Type x 2 Operating Range : 16.4' (5m) / ±30° Dimensions : 2.2" x 1.3" x 7.6" (55mm x 34mm x 192mm) Net Weight : 0.36 lbs (165 g) (including batteries) Laser Pointer : Class II Laser (Max. Output : 1mW / Wave length : 650±20nm)
Accessories	Owner's Manual AC Power Cord Remote Control Unit and Batteries VGA Cable Control Cable for PS/2 port DVI/VGA Adapter Carrying Bag Lens Cover and Strap for Lens Cover

- The specifications are subject to change without notice.
- LCD panels are manufactured to the highest possible standards. Even though 99.99% of the pixels are effective, a tiny fraction of the pixels (0.01% or less) may be ineffective by the characteristics of the LCD panels.

CONFIGURATIONS OF TERMINALS

RGB INPUT 1 / OUT TERMINAL (ANALOG)

Terminal : HDB15-PIN

Pin Configuration

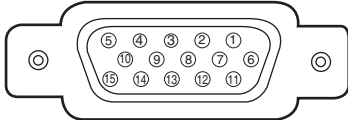

1	Red Input	9	+5V Power
2	Green Input	10	Ground (Vert.sync.)
3	Blue Input	11	Sense 0
4	Sense 2	12	DDC Data
5	Ground (Horiz.sync.)	13	Horiz. sync.
6	Ground (Red)	14	Vert. sync.
7	Ground (Green)	15	DDC Clock
8	Ground (Blue)		

RGB INPUT 2 TERMINAL (DIGITAL / ANALOG)

Terminal : DVI-I TERMINAL

Pin Configuration

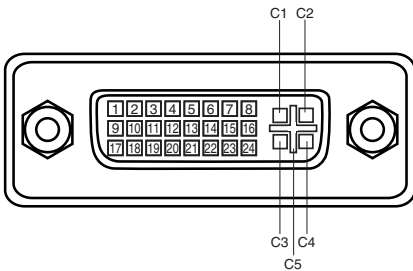

C1	Analog Red Input
C2	Analog Green Input
C3	Analog Blue Input
C4	Analog Horiz. sync
C5	Analog Ground (R/G/B)

1	T.M.D.S. Data2-	9	T.M.D.S. Data1-	17	T.M.D.S. Data0-
2	T.M.D.S. Data2+	10	T.M.D.S. Data1+	18	T.M.D.S. Data0+
3	T.M.D.S. Data2 Shield	11	T.M.D.S. Data1 Shield	19	T.M.D.S. Data0 Shield
4	No Connect	12	No Connect	20	No Connect
5	No Connect	13	No Connect	21	No Connect
6	DDC Clock	14	+5V Power	22	T.M.D.S. Clock Shield
7	DDC Data	15	Ground (for +5V)	23	T.M.D.S. Clock+
8	Analog Vert. sync	16	Hot Plug Detect	24	T.M.D.S. Clock-

CONTROL PORT CONNECTOR

Terminal : Mini DIN 8-PIN

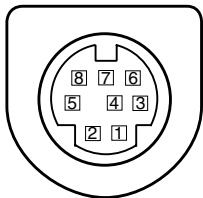
Pin Configuration

	PS/2	Serial	ADB
1	-----	R X D	-----
2	CLK	-----	ADB
3	DATA	-----	-----
4	GND	GND	GND
5	-----	RTS / CTS	-----
6	-----	T X D	-----
7	GND	GND	-----
8	-----	GND	GND

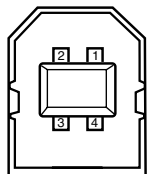
USB CONNECTOR (Series B)**Pin Configuration**

1	Vcc
2	- Data
3	+ Data
4	Ground

OPTIONAL PARTS

The parts listed below are optionally supplied. When ordering those parts, give the name and Type No. to the sales dealer.

- **Control Cable (Serial Port)** **Type No. : LV-CA26**
- **Control Cable (ADB Port)** **Type No. : LV-CA27**
- **MAC Adapter** **Type No. : LV-AD02**
- **SCART-VGA Cable** **Type No. : LV-CA31**

(This cable is used for RGB Scart
21-Pin output of video equipment.)



CANON INC. 30-2, Shimomaruko 3-chome, Ohta-ku, Tokyo 146-8501, Japan

CANON U.S.A., INC.

One Canon Plaza, Lake Success, NY 11042, U.S.A.

CANON CANADA, INC.

6390 Dixie Road Mississauga, Ontario L5T 1P7 Canada

CANON LATIN AMERICA, INC.

703 Waterford Way Suite 400 Miami, Florida 33126 U.S.A.

CANON EUROPA N.V.

P.O.Box 2262, 1180 EG Amstelveen, The Netherlands

CANON COMMUNICATION & IMAGE FRANCE S.A.

102, Avenue du General de Gaulle, 92250 La Garenne Colombes, France

CANON (UK) LTD.

Woodhatch, Reigate, Surrey RH2 8BF, United Kingdom

CANON DEUTSCHLAND GmbH

Europark Fichtenhain A 10, 47807 Krefeld, Germany

CANON ITALIA S.p.A.

Palazzo L, Strada 6, 20089 Milanofiori-Rozzano (MI), Italy

CANON (Schweiz) A.G.

Industriestrasse 12, 8305 Dietlikon, Switzerland

CANON BELGIUM N.V./S.A

Bessenveldstraat 7, 1831 Diegem, Belgium

CANON GmbH

Zetschegasse 11, A-1232 Wien, Austria

CANON ESPANA S.A.

C/Joaquin Costa 41, 28002 Madrid, Spain

CANON SVENSKA AB

Stensättravägen 13, S-127 88 Skarholmen 2, Sweden

CANON NORGE A/S

Hallagerbakken 110, P. O. Box 2-33, Holmlia 1201 Oslo 12, Norway

CANON OY

Kornetintie 3, 00381 Helsinki, Finland

CANON HONGKONG CO., LTD.

9/F, The Hong Kong Club Building, 3A Chater Road, Central, Hong Kong

CANON SINGAPORE PTE. LTD.

79 Anson Road #09-01/06, Singapore 079906

CANON AUSTRALIA PTY. LTD.

1 Thomas Holt Drive, North Ryde, Sydney, N.S.W.2113, Australia

CANON NEW ZEALAND LTD.

Akoranga Business Park, Akoranga Drive, Northcote, Auckland, New Zealand