

myprojectorlamps.com

**The most trusted, dependable name
in projector lamp sales.**



<http://www.myprojectorlamps.com>



<http://www.myprojectorlamps.ca>



<http://www.myprojectorlamps.eu>

The following projector manual has not been modified or altered in any way.

USER'S GUIDE

BOXLIGHT MP-56t



TO THE OWNER

Before operating this projector, read this manual thoroughly and operate the projector properly.

This projector provides many convenient features and functions. Operating the projector properly enables you to manage those features and maintains it in better condition for a considerable time.

Improper operation may result in not only shortening the product-life, but also malfunctions, fire hazard, or other accidents.

If your projector seems to operate improperly, read this manual again, check operations and cable connections and try the solutions in the "TROUBLESHOOTING" section at the end of this booklet. If the problem still persists, contact BOXLIGHT.



SAFETY PRECAUTIONS

WARNING : TO REDUCE THE RISK OF FIRE OR ELECTRIC SHOCK, DO NOT EXPOSE THIS APPLIANCE TO RAIN OR MOISTURE.

- This projector produces intense light from the projection lens. Do not stare directly into the lens as it could possibly damage your eyes. Be especially careful that children do not stare directly into the beam.
- Do not use projectors with whiteboards that produce a very bright glare or 'hot spot'. This is most common on shiny surfaces.
- This projector should be used as described in this manual. If not, it may result in a fire hazard.
- Provide appropriate space on the top, sides and rear of the projector cabinet for allowing air circulation and cooling the projector. If the projector is to be built into a compartment or similarly enclosed, the minimum distances must be maintained. Do not cover the ventilation openings on the projector. Heat build-up can reduce the service life of your projector, and can also be dangerous.
- Do not put any flammable objects such as spray cans near the projector, hot air is exhausted from the ventilation openings.
- The Remote Control, supplied with this projector, emits a laser beam from the Laser Light Window while pressing the LASER button (the LASER POINTER INDICATOR lights red to indicate laser emission). Do not look into the Laser Light Window or shine the laser beam on yourself or other people. Eye damage may result.
- If the projector is not to be used for an extended time, unplug the projector from the power outlet.

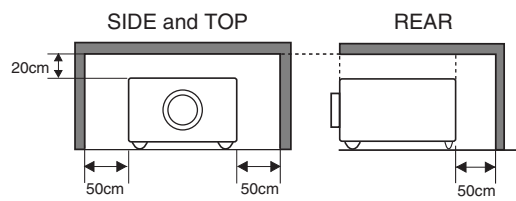

READ AND KEEP THIS USER'S GUIDE FOR LATER USE.

	CAUTION RISK OF ELECTRIC SHOCK DO NOT OPEN	
CAUTION : TO REDUCE THE RISK OF ELECTRIC SHOCK, DO NOT REMOVE COVER (OR BACK). NO USER-SERVICEABLE PARTS INSIDE EXCEPT LAMP REPLACEMENT. REFER SERVICING TO QUALIFIED SERVICE PERSONNEL.		
THIS SYMBOL INDICATES THAT DANGEROUS VOLTAGE CONSTITUTING A RISK OF ELECTRIC SHOCK IS PRESENT WITHIN THIS UNIT.	THIS SYMBOL INDICATES THAT THERE ARE IMPORTANT OPERATING AND MAINTENANCE INSTRUCTIONS IN THE USER'S GUIDE WITH THIS UNIT.	

SAFETY INSTRUCTIONS

All the safety and operating instructions should be read before the product is operated.

Read all of the instructions given here and retain them for later use. Unplug this projector from AC power supply before cleaning. Do not use liquid or aerosol cleaners. Use a damp cloth for cleaning.

Follow all warnings and instructions marked on the projector.

For added protection to the projector during a lightning storm, or when it is left unattended and unused for long periods of time, unplug it from the wall outlet. This will prevent damage due to lightning and power line surges.

Do not expose this unit to rain or use near water... for example, in a wet basement, near a swimming pool, etc...

Do not use attachments not recommended by the manufacturer as they may cause hazards.

Do not place this projector on an unstable cart, stand, or table. The projector may fall, causing serious injury to a child or adult, and serious damage to the projector. Use only with a cart or stand recommended by the manufacturer, or sold with the projector. Wall or shelf mounting should follow the manufacturer's instructions, and should use a mounting kit approved by the manufacturer.

An appliance and cart combination should be moved with care. Quick stops, excessive force, and uneven surfaces may cause the appliance and cart combination to overturn.



Slots and openings in the back and bottom of the cabinet are provided for ventilation, to insure reliable operation of the equipment and to protect it from overheating.

The openings should never be covered with cloth or other materials, and the bottom opening should not be blocked by placing the projector on a bed, sofa, rug, or other similar surface. This projector should never be placed near or over a radiator or heat register.

This projector should not be placed in a built-in installation such as a book case unless proper ventilation is provided.

Never push objects of any kind into this projector through cabinet slots as they may touch dangerous voltage points or short out parts that could result in a fire or electric shock. Never spill liquid of any kind on the projector.

This projector should be operated only from the type of power source indicated on the marking label. If you are not sure of the type of power supplied, consult your authorized dealer or local power company.

Do not overload wall outlets and extension cords as this can result in fire or electric shock. Do not allow anything to rest on the power cord. Do not locate this projector where the cord may be damaged by persons walking on it.

Do not attempt to service this projector yourself as opening or removing covers may expose you to dangerous voltage or other hazards. Refer all servicing to qualified service personnel.

Unplug this projector from wall outlet and refer servicing to qualified service personnel under the following conditions:

- a. When the power cord or plug is damaged or frayed.
- b. If liquid has been spilled into the projector.
- c. If the projector has been exposed to rain or water.
- d. If the projector does not operate normally according to the operating instructions. Adjust only those controls that are covered by the operating instructions as improper adjustment of other controls may result in damage and will often require extensive work by a qualified technician to restore the projector to normal operation.
- e. If the projector has been dropped or the cabinet has been damaged.
- f. When the projector exhibits a distinct change in performance-this indicates a need for service.

When replacement parts are required, be sure the service technician uses replacement parts specified by the manufacturer that have the same characteristics as the original part. Unauthorized substitutions may result in fire, electric shock, or injury to persons.

Upon completion of any service or repairs to this projector, ask the service technician to perform routine safety checks to determine that the projector is in safe operating condition.

Voor de klanten in Nederland



Bij dit product zijn batterijen geleverd. Wanneer deze leeg zijn, moet u ze niet weggooien maar inleveren als KCA.

COMPLIANCES

Federal Communication Commission Notice

Note : This equipment has been tested and found to comply with the limits for a Class B digital device, pursuant to part 15 of the FCC Rules. These limits are designed to provide reasonable protection against harmful interference in a residential installation. This equipment generates, uses and can radiate radio frequency energy and, if not installed and used in accordance with the instructions, may cause harmful interference to radio communications. However, there is no guarantee that interference will not occur in a particular installation. If this equipment does cause harmful interference to radio or television reception, which can be determined by turning the equipment off and on, the user is encouraged to try to correct the interference by one or more of the following measures :

- Reorient or relocate the receiving antenna.
- Increase the separation between the equipment and receiver.
- Connect the equipment into an outlet on a circuit different from that to which the receiver is connected.
- Consult the dealer or an experienced radio/TV technician for help.

Use of shielded cable is required to comply with class B limits in Subpart B of Part 15 of FCC Rules.

Do not make any changes or modifications to the equipment unless otherwise specified in the instructions. If such changes or modifications should be made, you could be required to stop operation of the equipment.

Model Number : BOXLIGHT MP-56t
Trade Name : Boxlight
Responsible party : BOXLIGHT
Address : 19332 Powder Hill Place Poulsbo, WA 98370-7407 USA
Telephone No. : (800)762-5757 or +1-360-779-7901

AC POWER CORD REQUIREMENT

The AC Power Cord supplied with this projector meets the requirement for use in the country you purchased it.

AC Power Cord for the United States and Canada :

The AC Power Cord used in the United States and Canada is listed by the Underwriters Laboratories (UL) and certified by the Canadian Standard Association (CSA).

The AC Power Cord has a grounding-type AC line plug. This is a safety feature to be sure that the plug will fit into the power outlet. Do not defeat this safety feature. Should you be unable to insert the plug into the outlet, contact your electrician.

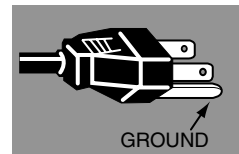

THE SOCKET-OUTLET SHOULD BE INSTALLED NEAR THE EQUIPMENT AND EASILY ACCESSIBLE.

TABLE OF CONTENTS

FEATURES AND DESIGN 6

PREPARATION 7

NAME OF EACH PART OF PROJECTOR	7
SETTING-UP PROJECTOR	8
CONNECTING AC POWER CORD	8
POSITIONING PROJECTOR	9
ADJUSTABLE FEET	10
MOVING PROJECTOR	10

CONNECTING PROJECTOR 11

TERMINALS OF PROJECTOR	11
CONNECTING TO COMPUTER	12
CONNECTING TO VIDEO EQUIPMENT	13

BEFORE OPERATION 14

OPERATION OF REMOTE CONTROL UNIT	14
LASER POINTER FUNCTION	14
REMOTE CONTROL BATTERIES INSTALLATION	15
TOP CONTROLS AND INDICATORS	16
OPERATING ON-SCREEN MENU	17
HOW TO OPERATE ON-SCREEN MENU	17
FLOW OF ON-SCREEN MENU OPERATION	17
MENU BAR	18

BASIC OPERATION 19

TURNING ON / OFF PROJECTOR	19
ADJUSTING SCREEN	20
ZOOM ADJUSTMENT	20
FOCUS ADJUSTMENT	20
LENS SHIFT ADJUSTMENT	20
KEystone ADJUSTMENT	20
PICTURE FREEZE FUNCTION	21
NO SHOW FUNCTION	21
P-TIMER FUNCTION	21
SOUND ADJUSTMENT	21

COMPUTER INPUT 22

SELECTING INPUT SOURCE	22
SELECTING COMPUTER SYSTEM	23
COMPATIBLE COMPUTER SPECIFICATIONS	24
PC ADJUSTMENT	25
AUTO PC ADJUSTMENT	25
MANUAL PC ADJUSTMENT	26
PICTURE IMAGE ADJUSTMENTS	28
IMAGE LEVEL SELECT	28
IMAGE LEVEL ADJUSTMENT	29
PICTURE SCREEN ADJUSTMENT	30

VIDEO INPUT 31

SELECTING INPUT SOURCE	31
SELECTING VIDEO SYSTEM	32
PICTURE IMAGE ADJUSTMENTS	33
IMAGE LEVEL SELECT	33
IMAGE LEVEL ADJUSTMENT	34
PICTURE SCREEN ADJUSTMENT	35

SETTING 36

SETTING MENU	36
--------------	----

APPENDIX 38

LAMP REPLACEMENT	38
LAMP REPLACE	38
LAMP REPLACE COUNTER	39
OPERATING WIRELESS MOUSE	40
MAINTENANCE	41
WARNING TEMP. INDICATOR	41
AIR FILTER CARE AND CLEANING	41
CLEANING PROJECTION LENS	41
TROUBLESHOOTING	42
TECHNICAL SPECIFICATIONS	44
CONFIGURATIONS OF TERMINALS	45
OPTIONAL PARTS	46

TRADEMARKS

- Apple, Macintosh, and PowerBook are trademarks or registered trademarks of Apple Computer, Inc.
- IBM, VGA, XGA, and PS/2 are trademarks or registered trademarks of International Business Machines, Inc.
- Windows and PowerPoint are registered trademarks of Microsoft Corporation.
- Each name of corporations or products in the user's guide is a trademark or a registered trademark of its respective corporation.

FEATURES AND DESIGN

This Multimedia Projector is designed with the most advanced technology for portability, durability, and ease of use. This projector utilizes built-in multimedia features, a palette of 16.77 million colors, and matrix liquid crystal display (LCD) technology.

◆ Compact Design

This projector is extremely compact in size and weight. It is designed to be portable and work anywhere you need it.

◆ Compatibility

This projector accepts various video and computer input signals including;

- **Computers**
IBM-compatible or Macintosh computer up to 1280 x 1024 resolution.
- **6 Color Systems**
NTSC, PAL, SECAM, NTSC 4.43, PAL-M or PAL-N color system can be displayed.
- **Component Video**
Component video signal, such as a DVD player output high definition TV signals including 480i, 480p, 575i, 575p, 720p, 1035i or 1080i, can be connected.
- **S-Video**
S-Video signal, such as a S-VHS VCR output signal, can be connected.

◆ High Resolution Image

This projector provides 1024 x 768 dots resolution for computer input and 800 horizontal TV lines. Resolution from a computer between XGA (1024 x 768) and SXGA (1280 x 1024) is compressed into 1024 x 768 dots. This projector cannot display image over 1280 x 1024 dots. When resolution of your computer is more than 1280 x 1024, lower the resolution.

◆ Multi-Scan System

This projector has a Multi-Scan System to conform to almost all computer output signals quickly. There is no need for troublesome manual adjustment of frequency and other settings.

◆ Progressive Scan Function

This function converts interlaced video signals into progressive scan signals to provide fine picture quality.

◆ One-Touch Auto PC Adjustment

Incoming computer video signals are recognized and automatically adjusted for by the Auto PC Adjustment feature. No complicated setup is necessary and projection is always precise.

◆ Digital Zoom (for Computer)

Digital Zoom function adjusts the image size to approx. 1/4 ~ 49 times original size, allowing you to focus on crucial information in your presentation.

◆ Motor-driven Lens Shift

The Projection lens can be moved up and down with the motor-driven lens shift function. This function makes it easy to place the image where you want it. Zoom and focus are also motor-driven functions.

◆ Keystone Correction

Certain projector positions can cause the image to be distorted into a trapezoid shape. Keystone Correction solves this problem by digitally altering the image to make it square.

◆ Power Management

The Power Management function is provided to reduce power consumption while the projector is not in use. The Power Management function turn the Projection Lamp off when the projector detects signal interruption and no buttons are pressed for over 5 minutes. Projection Lamp is automatically turned on again when a projector detects signal or any operation button is pressed. This projector is shipped with this function ON.

◆ Digital Visual Interface

This projector is equipped with DVI 29-pin terminal for connecting DVI output from a computer or other DVI source.

◆ Laser Pointer Function

The Remote Control supplied with the projector includes a Laser Pointer.

◆ Wireless Mouse

The Remote Control supplied with this projector has Wireless Mouse function for a connected computer. This function enables you to operate both projector and computer with the Remote Control only.

◆ Multilanguage Menu Display

Operation menu is displayed in; English, German, French, Italian, Spanish, Portuguese, Dutch, Swedish, Chinese, Korean or Japanese.

◆ Media Card Imager (Optional)

The Optional Media Card Imager is available for this projector. For the Media Card Imager, contact the sales dealer where you purchased this projector.

◆ Wireless Imager (Optional)

This projector can be operated through Wireless LAN by attaching Wireless imager that is optionally supplied. For the Wireless Imager, contact the sales dealer where you purchased the projector.

PREPARATION

NAME OF EACH PART OF PROJECTOR

FRONT

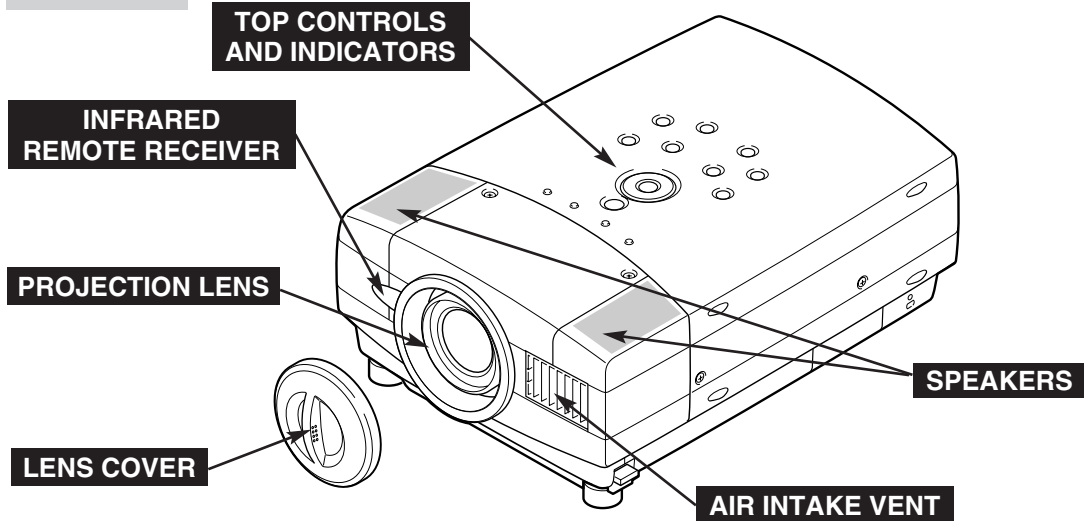

BACK

EXHAUST VENTS



HOT AIR EXHAUSTED !

Air blown from Exhaust Vents is hot. When using or installing projector, following precautions should be taken.

- Do not put any flammable object near this vent.
- Keep side grill at least 3'(1m) away from any object, especially heat-sensitive object.
- Do not touch this area, especially screws and metallic parts. This area will become hot while the projector is used.

This projector monitors the internal temperature and automatically controls operating speed of Cooling Fans.

TERMINALS AND CONNECTORS

INFRARED REMOTE RECEIVER

AIR INTAKE VENT

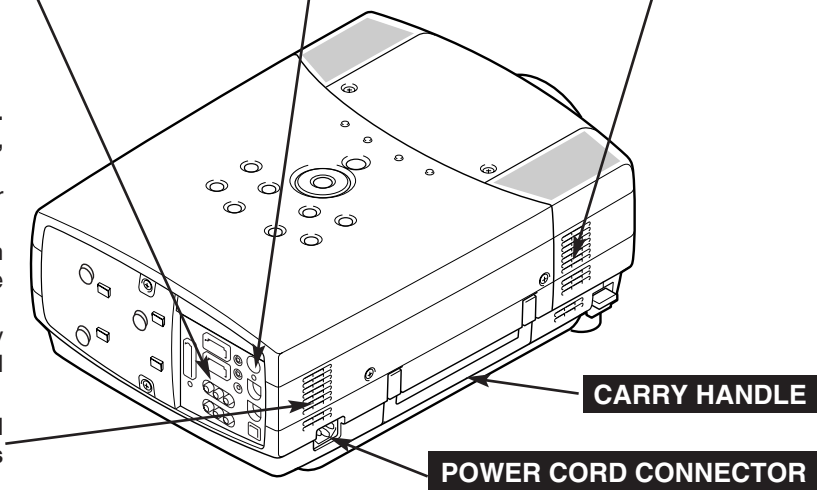

BOTTOM

AIR INTAKE VENTS

This projector is equipped with Cooling Fans for protection from overheating. Pay attention to the following to ensure proper ventilation and avoid a possible risk of fire and malfunction.

- Do not cover vent slots.
- Keep side and bottom clear of any obstructions that may block cooling air.

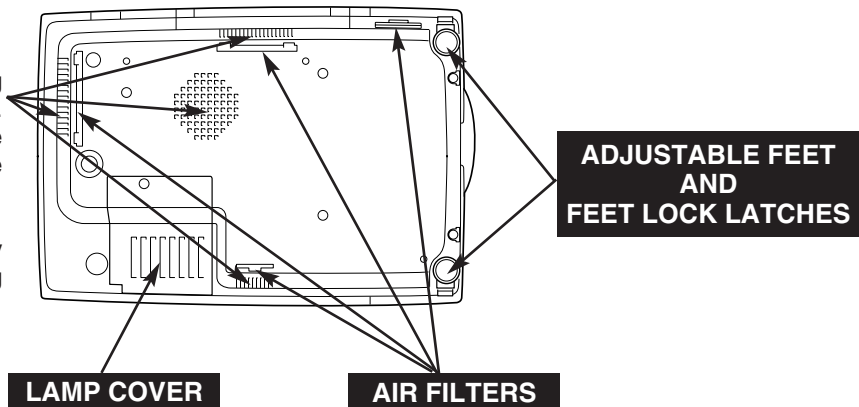

SETTING-UP PROJECTOR

CONNECTING AC POWER CORD

This projector uses nominal input voltages of 100-120 V or 200-240 V AC. This projector automatically selects the correct input voltage. It is designed to work with single-phase power systems having a grounded neutral conductor. To reduce risk of electrical shock, do not plug into any other type of power system. Consult your authorized dealer or service station if you are not sure of the type of power supply being in use. Connect the projector to peripheral equipment before turning the projector on. (Refer to pages 11 ~ 13 for connection.)

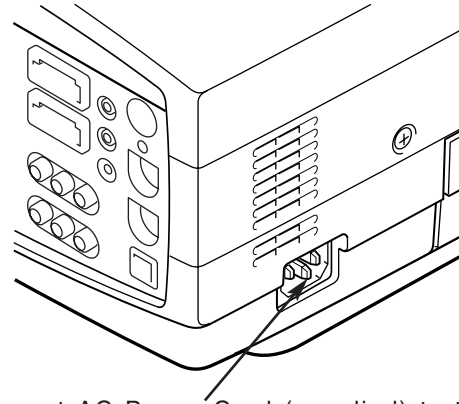

Connect AC Power Cord (supplied) to the projector. The AC outlet must be near this equipment and must be easily accessible.



CAUTION

For safety, unplug AC Power Cord when an appliance is not used. When this projector is connected to the outlet with AC Power Cord, an appliance is in Stand-by Mode and consumes a little electric power.

NOTE ON POWER CORD

The AC Power Cord must meet the requirements of the country where you use the projector. Confirm the AC plug type with the chart below to ensure the proper AC power cord is used. If the supplied AC Power Cord does not match your AC outlet, contact your sales dealer.

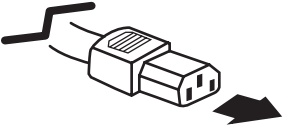
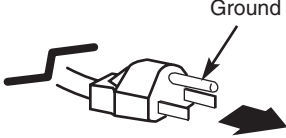
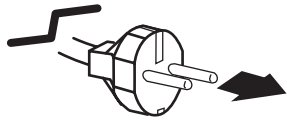
Projector side	AC Outlet side	
 <p data-bbox="365 1375 552 1449">To POWER CORD CONNECTOR on a projector.</p>	<p data-bbox="706 1171 966 1201">For U.S.A. and Canada</p>  <p data-bbox="747 1381 876 1438">To AC Outlet. (120 V AC)</p>	<p data-bbox="1079 1180 1372 1209">For Continental Europe</p>  <p data-bbox="1071 1407 1258 1459">To AC Outlet. (200 - 240 V AC)</p>

POSITIONING PROJECTOR

- This projector is designed to project on a flat projection surface.
- Projector can be focused from 4.1' (1.2m) ~ 32.8' (10.0m).
- Refer to figure below to adjust screen size.

ROOM LIGHT

Brightness in room has a great influence on picture quality. It is recommended to limit ambient lighting in order to provide best image.

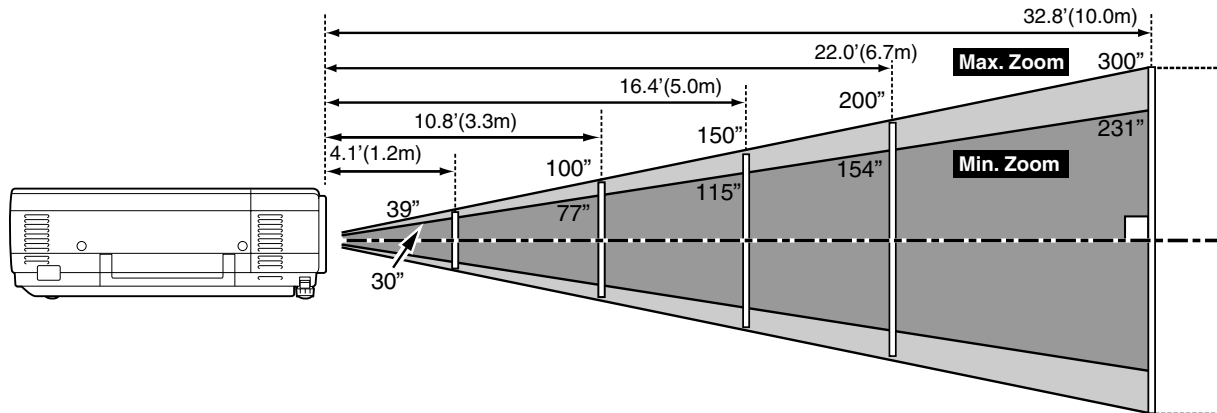

Screen Size (Diag.)	Max. Zoom	39"	100"	150"	200"	250"	300"
	Min. Zoom	30"	77"	115"	154"	192"	231"
Distance		4.1' (1.2m)	10.8' (3.3m)	16.4' (5.0m)	22.0' (6.7m)	27.6' (8.4m)	32.8' (10.0m)

LENS SHIFT ADJUSTMENT

Projection lens can be moved up and down using the motor-driven lens shift function. This function makes it easy to position the image where you need it. U/D ratio can be adjusted 10 : 0 ~ 1 : 1 (refer to figure below.). Refer to P20 for operation.

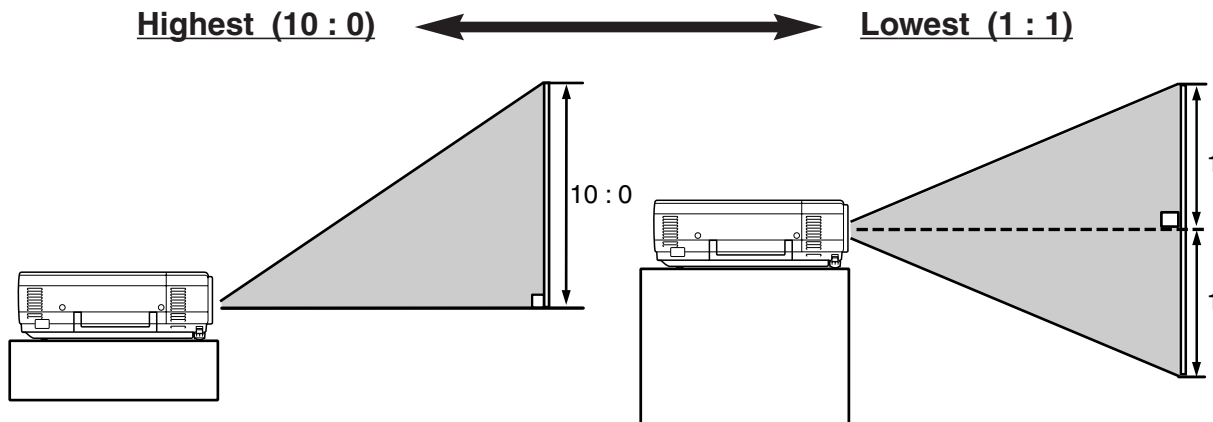

ADJUSTABLE FEET

Picture tilt and projection angle can be adjusted by rotating the ADJUSTABLE FEET. Projection angle can be adjusted up to 10 degrees.

- 1** Lift the front of the projector and pull the FEET LOCK LATCHES on both sides of the projector.
- 2** Release the FEET LOCK LATCHES to lock the ADJUSTABLE FEET. Rotate the ADJUSTABLE FEET to fine tune position and tilt.
- 3** To retract the ADJUSTABLE FEET, lift the front of the projector and pull the FEET LOCK LATCHES. Keystone distortion of the image can be adjusted using the On Screen Menu. (Refer to P20 and 36.)



NOTE :
DO NOT TILT THE PROJECTOR MORE THAN 10 DEGREES. EXCESSIVE ANGLES CAN CAUSE THE PROJECTION LAMP TO MALFUNCTION.

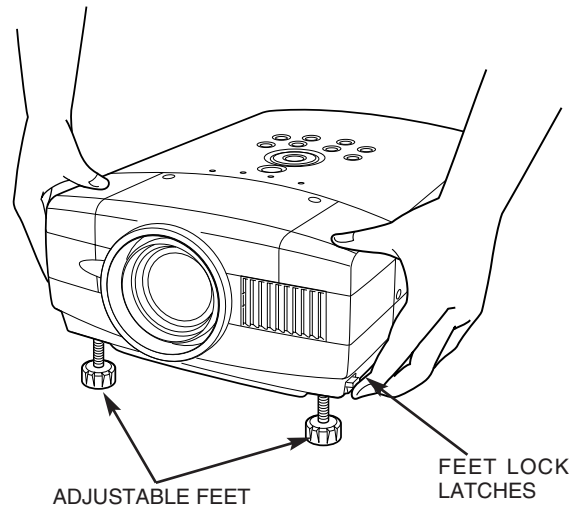

MOVING PROJECTOR

Use the Carry Handle when moving the projector.
Replace the Lens Cover and retract the Adjustable Feet to prevent damage to the lens and cabinet.
When the projector will not be used for an extended period, put it into the case (dust cover) supplied with the projector.



CAUTION

The supplied Dust Cover is intended for protection from dust and scratches on the surface of the projector, it is not designed to protect the projector from impact. Do not transport the projector through a courier or transport service with this cover, the projector will be damaged. When handling the projector, do not drop, bump, or subject the projector to strong forces. Do not stack or place items on top of the projector.

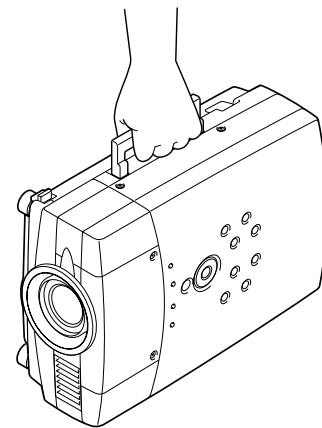

CAUTION IN CARRYING OR TRANSPORTING THE PROJECTOR

- Do not drop or bump the projector, damage and malfunctions may result.
- When carrying the projector, use a suitable carrying case.
- Do not transport the projector using a courier or transport service in an unsuitable transport case. This may cause damage to the projector. To transport the projector through a courier or transport service, consult your dealer for more information.

CONNECTING PROJECTOR

TERMINALS OF PROJECTOR

This projector has input and output terminals on its back for connecting computers and video equipment. Refer to figures on pages 11 to 13 and connect properly.

COMPUTER INPUT 2 (DIGITAL/ANALOG) Media Card Imager / Wireless Imager TERMINAL

Connect computer output (Digital / Analog DVI-I type), Media Card Imager*, or Wireless Imager* to this terminal. (Refer to P12)

*optional accessories

MONITOR OUTPUT TERMINAL

Connect an external monitor to this terminal. This terminal outputs the analog computer signal from Computer Input. (Refer to P12.)

COMPUTER INPUT 1 TERMINAL

Connect computer output (Analog HDB 15-pin type) or 21-pin Scart (RGB) output from video equipment to this terminal. (Refer to P12, 13.)

COMPUTER AUDIO INPUT (1 and 2) JACKS

Connect an audio output (stereo) from computer to these jacks. (Refer to P12.)

RESET BUTTON

This projector uses a micro-processor, occasionally the micro-processor may need to be reset.

To reset the processor, press the RESET button with a pen. The projector will shut down and restart. If this needs to be done too often contact your dealer the projector may need service.

AUDIO OUTPUT JACK

Connect an external audio amplifier to this jack. (Refer to P12, 13.)

CONTROL PORT CONNECTOR

To control computer mouse functions with the Remote Control connect the computer mouse port to this connection. (Refer to P12.)

* Do not press this button. This button is used for our optional accessories.

S-VIDEO INPUT JACK

Connect the S-VIDEO output from video equipment to this jack. (Refer to P13.)

AUDIO INPUT JACKS

Connect the audio output from video equipment to these jacks. (Refer to P13.)

● When the audio output is monaural, connect it to L (MONO) jack.

VIDEO INPUT JACKS

Connect the component video output from video equipment the Y, Pb/Cb and Pr/Cr jacks. (Refer to P13.)

VIDEO INPUT JACK

Connect the composite video output from video equipment to connect this jack. (Refer to P13.)

USB CONNECTOR (Series B)

To control computer mouse functions with the Remote Control, connect the USB port to this connector. (Refer to P12.)

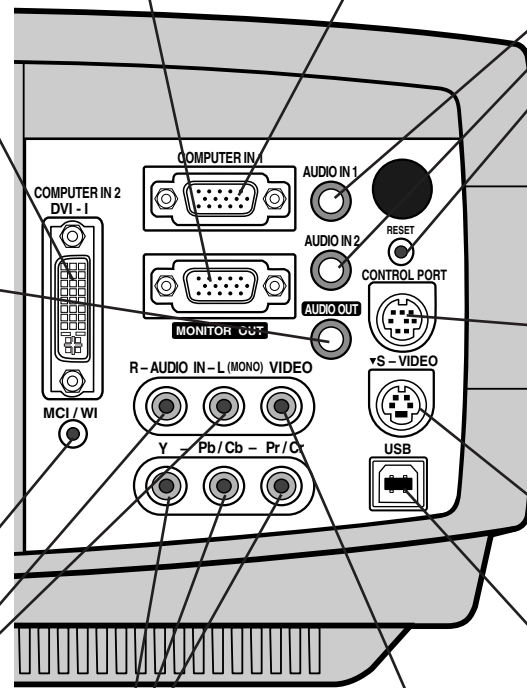

CONNECTING TO COMPUTER

Cables used for connection (* = Cable or adapter is not supplied with this projector.)

- VGA Cable (HDB 15 pin)
- Control Cable for SERIAL Port
- DVI-Digital Cable (for Single Link T.M.D.S.) *
- Control Cable for PS2 Port *, or ADB Port *
- USB Cable
- MAC Adapter (When connecting to Macintosh computer) *
- DVI/VGA Adapter
- Audio Cables {Mini Plug (stereo) x 2} *

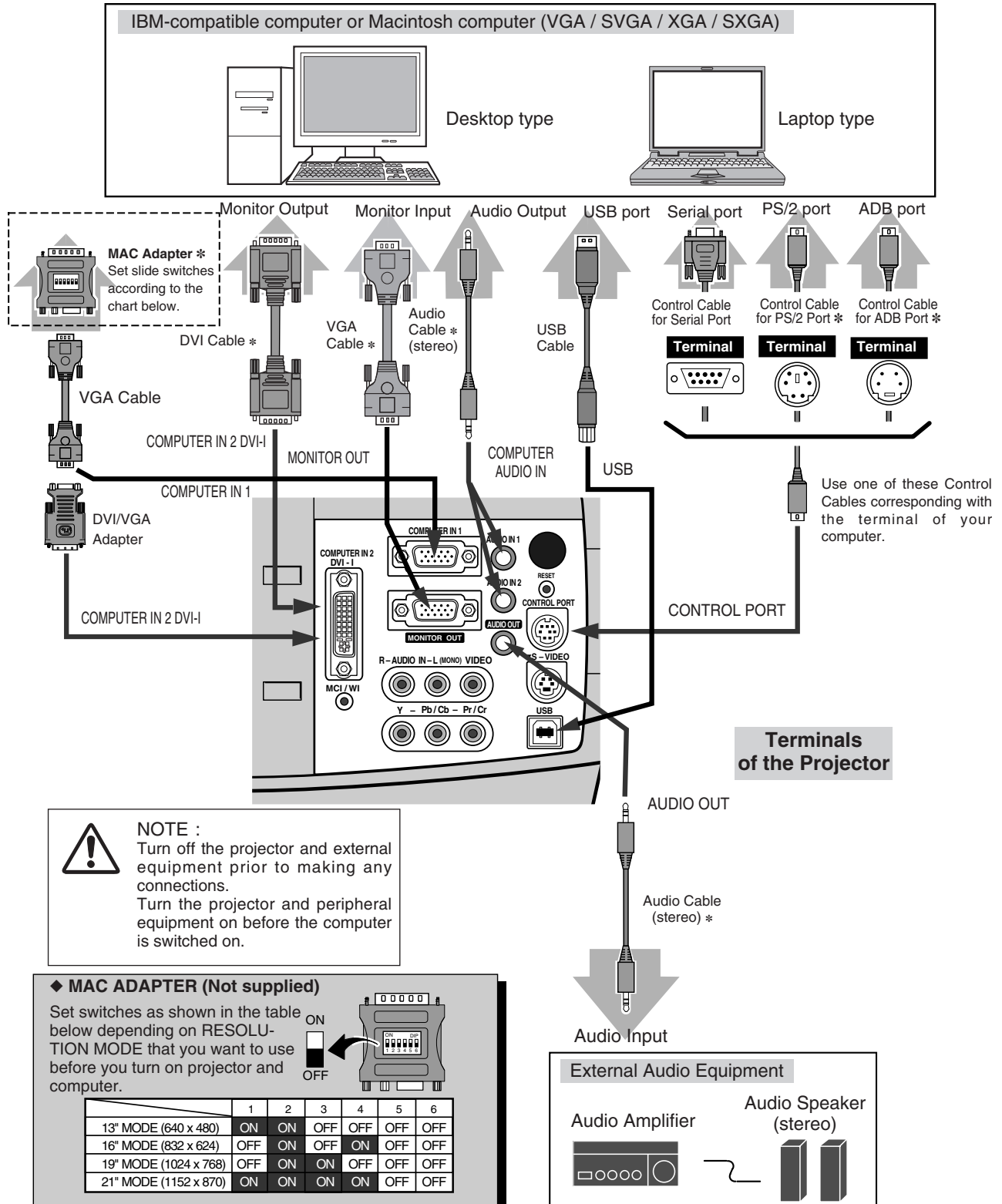

CONNECTING TO VIDEO EQUIPMENT

Cables used for connection (* = Cable is not supplied with this projector.)

- Video Cable (RCA x 1 or RCA x 3) *
- S-VIDEO Cable *
- Audio Cable (RCA x 2) *
- Audio Cable {Mini Plug (stereo)} *
- Scart Cable *

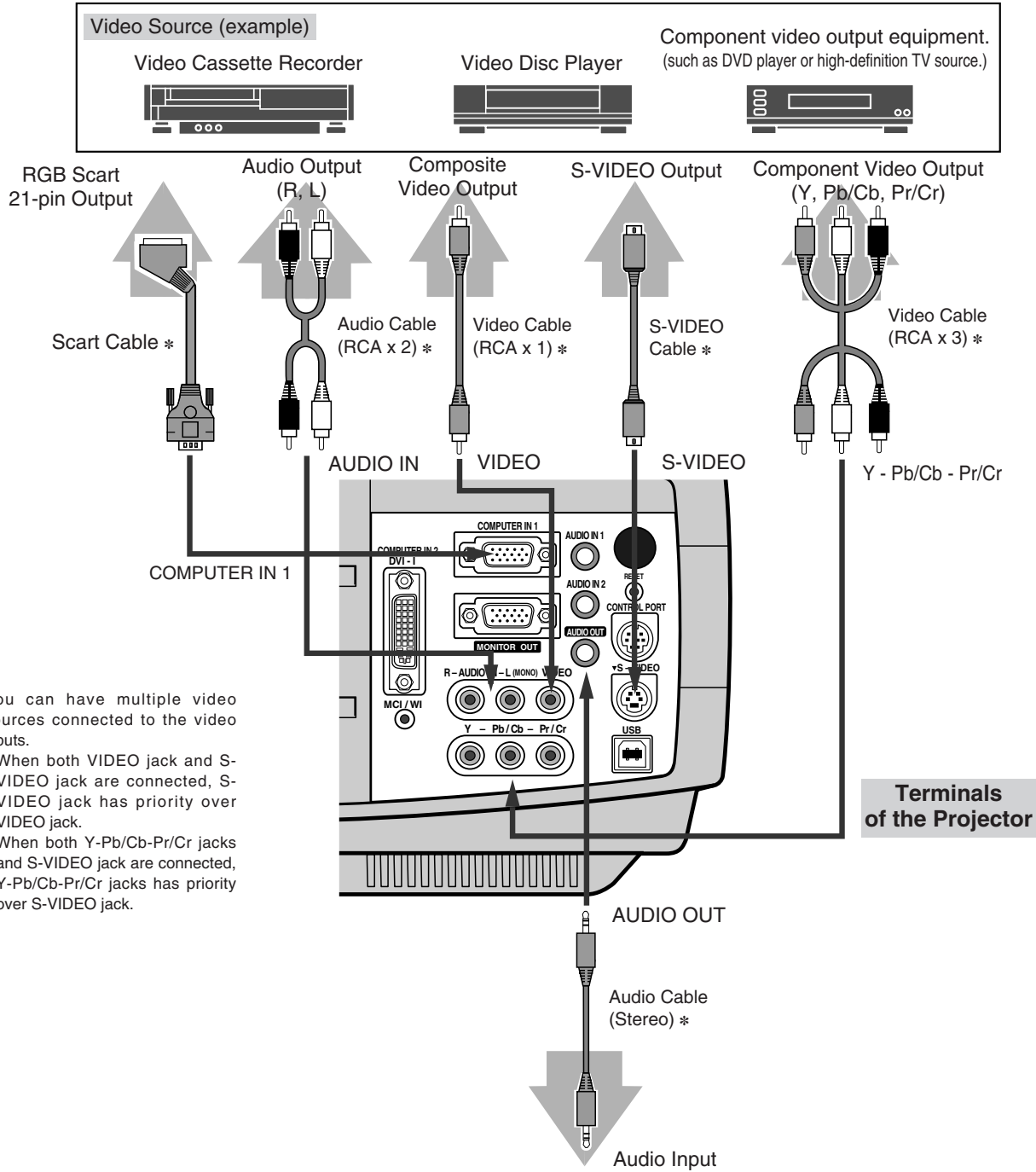

You can have multiple video sources connected to the video inputs.

- When both VIDEO jack and S-VIDEO jack are connected, S-VIDEO jack has priority over VIDEO jack.
- When both Y-Pb/Cb-Pr/Cr jacks and S-VIDEO jack are connected, Y-Pb/Cb-Pr/Cr jacks has priority over S-VIDEO jack.

NOTE :
Turn off the projector and external equipment before making any connections.

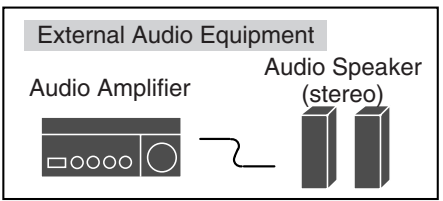

BEFORE OPERATION

OPERATION OF REMOTE CONTROL

Left Side

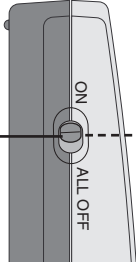

ALL-OFF SWITCH

When using Remote Control Unit, turn this switch to "ON." And turn it to "ALL OFF" when it is not used.

INSIDE THE BATTERY COMPARTMENT

The remote control has DIP switches in the battery compartment to control the laser pointer and code features.

Setting SW4 (LASER ON/OFF switch) to "OFF" disables the laser pointer on the remote.

Set switches 1-3 as shown in the table below to select the remote control code. (Refer to P37.)

DIP SWITCH SETTING			
SW4 LASER ON/OFF			
SW1	SW2	SW3	Code No.
ON	ON	ON	Code 1
ON	ON	OFF	Code 2
ON	OFF	ON	Code 3
ON	OFF	OFF	Code 4
OFF	ON	ON	Code 5
OFF	ON	OFF	Code 6
OFF	OFF	ON	Code 7
OFF	OFF	OFF	Code 8

LASER POINTER (Drag ON) INDICATOR

Lights red while laser beam is emitted from Laser Light Window.

Lights green when drag feature is active. (P40)

MUTE BUTTON

Used to mute sound. (P21)

DRAG ON/OFF BUTTON

Used to set drag feature ON/OFF. (P40)

LEFT CLICK BUTTON

Used as a PC mouse in Wireless Mouse Operation. Press this button and the mouse pointer button to drag a selected screen object. (P40)

LASER BUTTON

Used to operate Laser Pointer Function. Laser beam is emitted while pressing this button within 1 minute. When using this Laser Pointer for more than 1 minute, release LASER button and press it again.

FOCUS BUTTON

Used to adjust focus. (P20)

POWER ON-OFF BUTTON

Used to turn projector on or off. (P19)

AUTO PC ADJ. BUTTON

Use to operate AUTO PC Adjustment function. (P25)

IMAGE BUTTON

Used to select image level. (P28, 33)

KEystone BUTTON

Used to correct keystone distortion. (P20, 36)

MOUSE POINTER

Used as a PC mouse in Wireless Mouse Operation. (P40)

RIGHT CLICK BUTTON

Used as a PC mouse in Wireless Mouse Operation. (P40)

LENS SHIFT BUTTON

Used to select LENS SHIFT function. (P20)



LASER POINTER FUNCTION

This Remote Control Unit emits a laser beam as a laser pointer function from the Laser Light Window. When LASER button is pressed, laser light goes on. And when LASER button is pressed for more than 1 minute or LASER button is released, light goes off. LASER POINTER INDICATOR lights RED and Laser is emitted with RED light to indicate laser beam is being emitted.

Laser emitted is a class II laser; therefore, do not look into Laser Light Window or shine laser beam on yourself or other people. Below are the caution labels for the laser beam.

CAUTION : Use of controls, adjustments or performance of procedures other than those specified herein may result in hazardous radiation exposure.

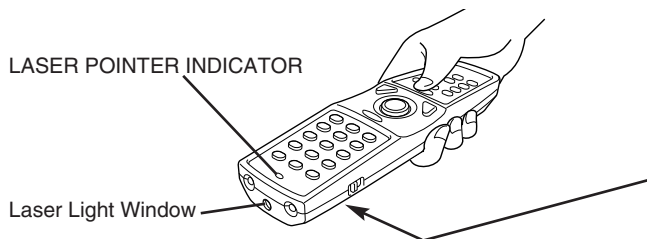

These caution labels are on remote control.

CAUTION	LASER RADIATION DO NOT STARE INTO BEAM
MAX OUTPUT : 1mW WAVE LENGTH : 650±20nm CLASS II LASER PRODUCT	LASER RADIATION DO NOT STARE INTO BEAM CLASS 2 LASER PRODUCT LASER-STRAHLUNG NICHT IN DEN STRAHL BLICKEN LASER KLASSE 2 レーザー放射 クラス2レーザー製品 ビームをのぞき込まないこと IEC60825-1, Am.1 1997 MAX OUTPUT (最大出力) : 1mW WAVE LENGTH (波長) : 650±20nm
This product is complied with 21 CFR part 1040.10	AVOID EXPOSURE-LASER RADIATION IS EMITTED FROM THIS APERTURE レーザー光の出口 ビームをのぞき込まないこと



AVOID EXPOSURE-LASER RADIATION IS EMITTED FROM THIS APERTURE
レーザー光の出口
ビームをのぞき込まないこと

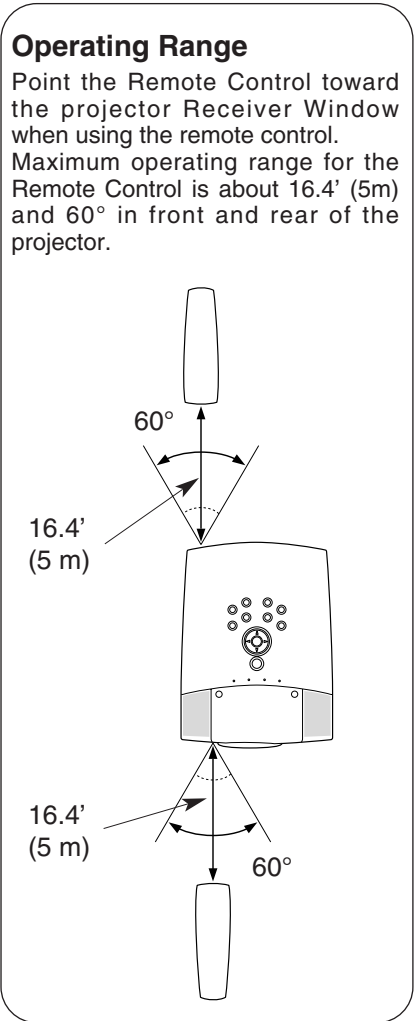
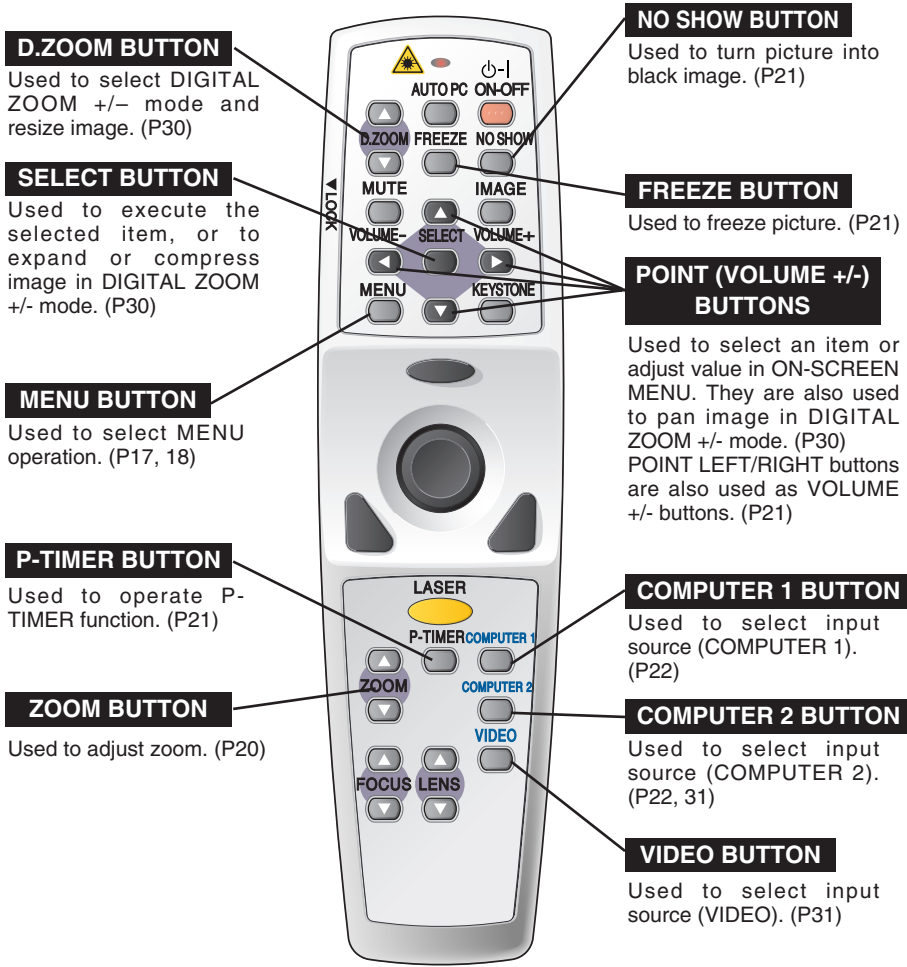

Remote Control Batteries Installation

1 Remove battery compartment lid.

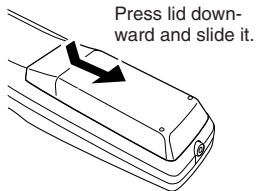

2 Slide batteries into compartment.

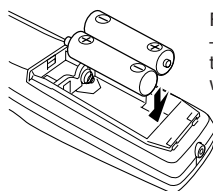

Two AA size batteries
For correct polarity (+ and -), be sure battery terminals are in contact with pins in compartment.

3 Replace compartment lid.

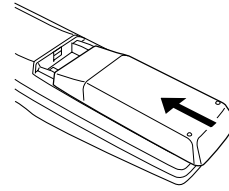

To ensure safe operation, please observe following precautions :

- Use (2) AA, UM3 or R06 type alkaline batteries.
- Replace both batteries at the same time.
- Do not mix new batteries with used batteries.
- Avoid contact with water or liquid.
- Do not expose the Remote Control to moisture, or heat.
- Do not drop the Remote Control.
- If a battery has leaked in the Remote Control, carefully wipe case clean and install new batteries.
- Danger of explosion if batteries are incorrectly installed.
- Dispose of used batteries according to the battery manufacturer's instructions and local rules.

TOP CONTROLS AND INDICATORS

This projector has CONTROL BUTTONS (TOP CONTROLS) and INDICATORS on its top.

TOP CONTROLS AND INDICATORS

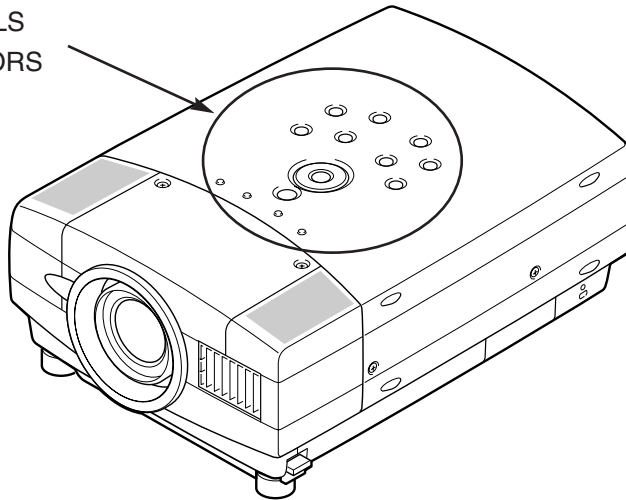

LAMP REPLACE INDICATOR

Turns yellow when the life of the projection lamp draws to an end. (P38)

WARNING TEMP. INDICATOR

Flashes red when internal projector temperature is too high. (P41)

READY INDICATOR

Lights green when the projector is ready to be turned on. Flashes green in Power Management mode. (P37)

LAMP INDICATOR

Becomes dim when the projector is turned on. It is bright when the projector is in stand-by mode.

POINT (VOLUME +/-) BUTTONS

Used to select an item or adjust values in the ON-SCREEN MENU. They are also used to pan the image in DIGITAL ZOOM +/- mode. (P30)
POINT LEFT/RIGHT buttons are also used as VOLUME +/- buttons. (P21)

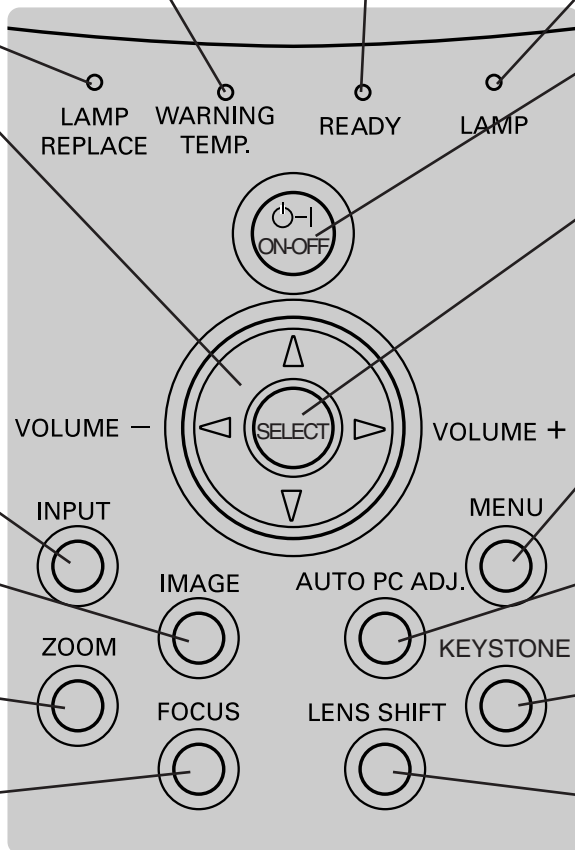

POWER ON-OFF BUTTON

Used to turn the projector on or off. (P19)

SELECT BUTTON

Used to execute the item selected. It is also used to expand / compress the image in DIGITAL ZOOM mode. (P30)

INPUT BUTTON

Used to select input source. (P22, 31)

MENU BUTTON

Used to open or close MENU operation. (P17, 18)

IMAGE BUTTON

Used to select image level. (P28, 33)

AUTO PC ADJ. BUTTON

Use to operate AUTO PC Adjustment function. (P25)

ZOOM BUTTON

Used to adjust zoom. (P20)

KEystone BUTTON

Used to correct keystone distortion. (P20, 36)

FOCUS BUTTON

Used to adjust focus. (P20)

LENS SHIFT BUTTON

Used to select LENS SHIFT function. (P20)

OPERATING ON-SCREEN MENU

HOW TO OPERATE ON-SCREEN MENU

You can control and adjust the projector through the ON-SCREEN MENU system. Refer to the following pages for details on operating the ON-SCREEN MENUS.

1 DISPLAY MENU

Press MENU to display ON-SCREEN MENU.

2 MOVING POINTER

Move the pointer (* see below) or adjust the value of an item by pressing the POINT on Top Control or on Remote Control.

* The Pointer is the icon on the ON-SCREEN MENU that highlights the selected item. See the figures in the section "FLOW OF ON-SCREEN MENU OPERATION" below.

3 SELECT ITEM

Select the item or set the selected function by pressing SELECT.

REMOTE CONTROL UNIT

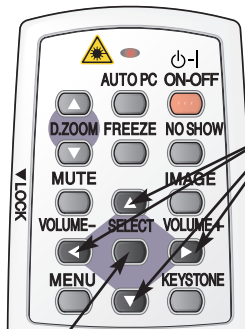

POINT BUTTONS

Used to move the Pointer UP/ DOWN/ RIGHT/ LEFT.

SELECT BUTTON

Used to select the item.

TOP CONTROL

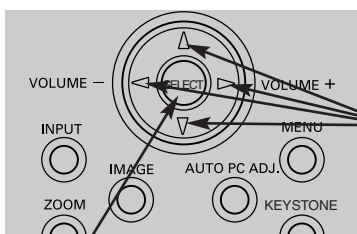

POINT BUTTONS

Used to move the Pointer UP/ DOWN/ RIGHT/ LEFT.

SELECT BUTTON

Used to select the item.

FLOW OF ON-SCREEN MENU OPERATION

Display ON-SCREEN MENU

1 Press MENU to display ON-SCREEN MENU (MENU BAR). The red frame is the POINTER.

Select Menu to be adjusted

2 Move POINTER (red frame) to MENU ICON that you want to select by pressing POINT RIGHT / LEFT.

Control or adjust item through ON-SCREEN MENU

3 Press POINT DOWN and move POINTER (red frame or red arrow) to the ITEM that you want to adjust, and then press SELECT to show ITEM DATA.

4 Adjust ITEM DATA by pressing POINT RIGHT/LEFT. Refer to the following pages for details of respective adjustments.

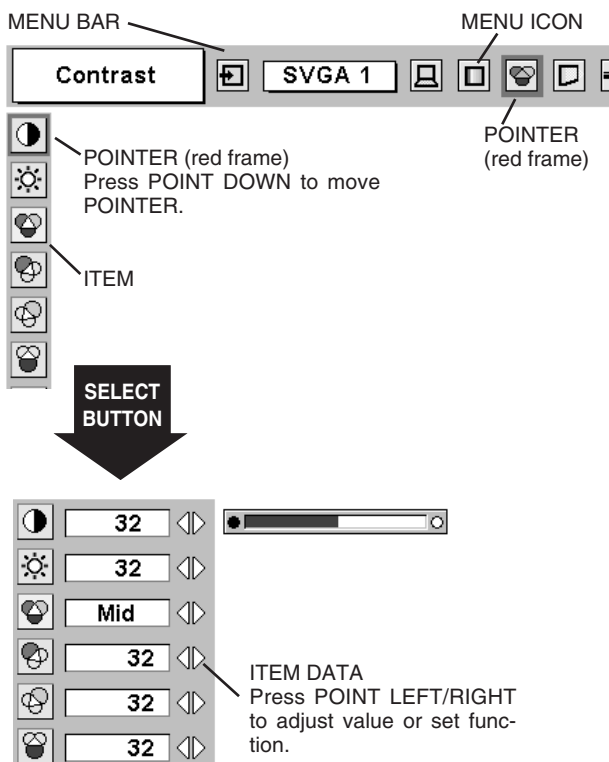

MENU BAR

FOR PC SOURCE

Press MENU BUTTON while connected to PC input source.

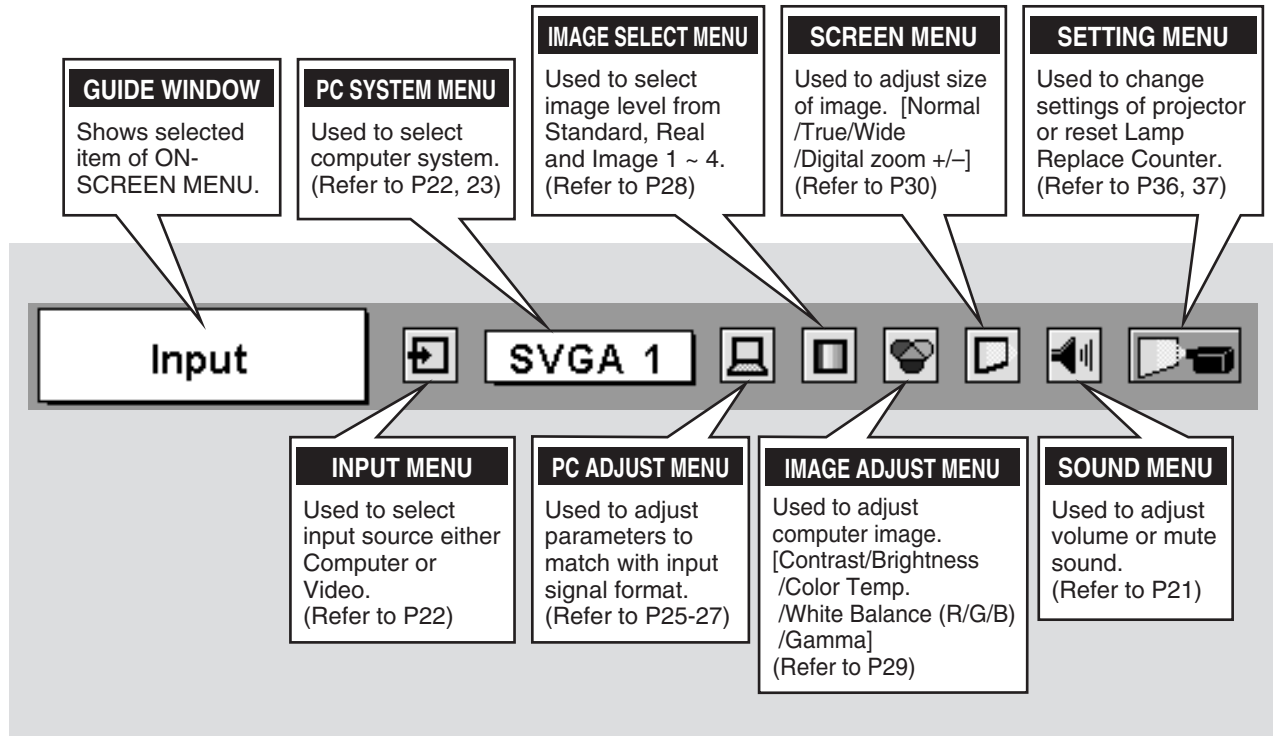

FOR VIDEO SOURCE

Press MENU BUTTON while connected to VIDEO input source.

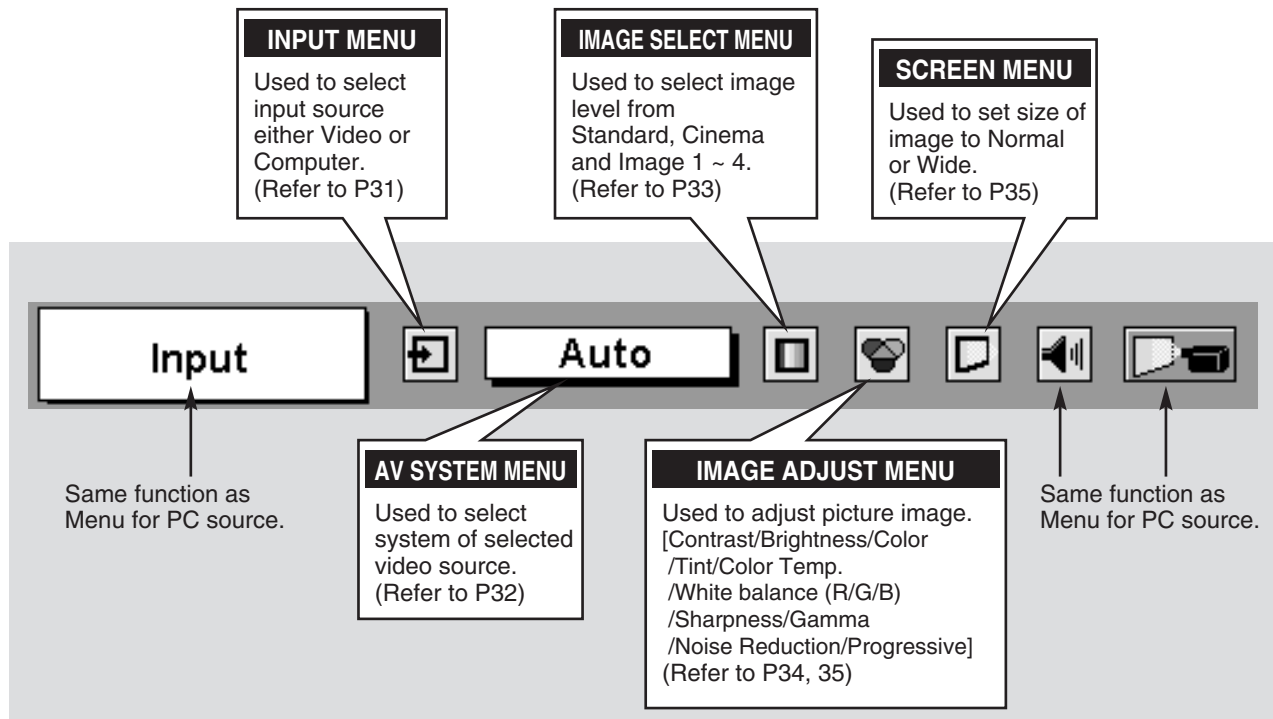

BASIC OPERATION

TURNING ON / OFF PROJECTOR

TURNING ON PROJECTOR

- 1 Complete peripheral connections (with Computer, VCR, etc.) before turning on projector. (Refer to "CONNECTING PROJECTOR" on pages 11~13 for connecting the equipment.)
- 2 Connect the projector's AC Power Cord into an AC outlet. LAMP Indicator lights RED, and READY Indicator lights GREEN.

NOTE : When "On start" function is ON, this projector is turned on automatically by connecting AC Power Cord to an AC outlet. (Refer to page 37.)
- 3 Press POWER ON-OFF on Top Control or on Remote Control. LAMP Indicator dims, and Cooling Fans start to operate. Preparation Display appears on screen and count-down starts. The signal from PC or Video source appears after 30 seconds. Current Input position and Lamp mode status are also displayed on screen for 5 seconds. (Refer to "LAMP MODE" on page 37.)

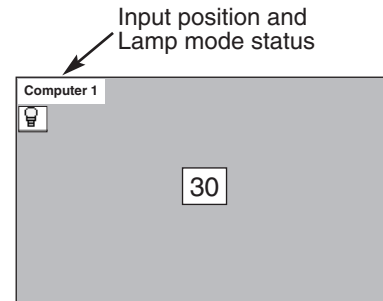

Preparation Display disappears after 30 seconds.

TURNING OFF PROJECTOR

- 1 Press POWER ON-OFF on Top Control or on Remote Control, and a "Power off?" message appears on a screen.
- 2 Press POWER ON-OFF again to turn off the projector. The LAMP Indicator lights bright and READY Indicator turns off. After the lamp is turned off, the Cooling Fans operate (for 90 seconds). During this "Cooling Down" period, the projector cannot be turned on and will not respond to user input.
- 3 When the projector has cooled down, the READY Indicator lights GREEN again and you can turn the projector back on or disconnect the AC Power Cord.

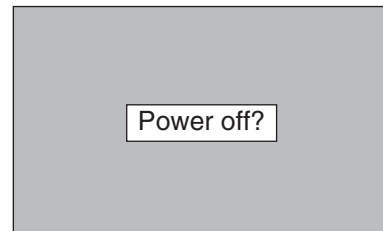

Message disappears after 4 seconds.



TO MAINTAIN THE LIFE OF LAMP, ONCE YOU TURN PROJECTOR ON, WAIT AT LEAST 5 MINUTES BEFORE TURNING IT OFF.

When "Power Management" is ON, the projector detects signal interruption and turns off the Projection Lamp automatically. Refer to "Power management" on page 37.

When the WARNING TEMP. indicator flashes red, the projector automatically shuts off. Wait at least 5 minutes, when the READY indicator lights green the projector may be turned on by pressing the POWER ON-OFF button.

When both WARNING TEMP. and READY indicators are flashing, the projector cannot be turned on by pressing the POWER ON-OFF. In this case, follow procedures below:

1. Disconnect AC Power Cord from the AC outlet.
2. Turn the projector on again. (Refer to steps 2-3 of TURNING ON PROJECTOR on this page.)

When the WARNING TEMP. indicator continues to flash, follow procedures below:

1. Disconnect AC Power Cord from the AC outlet.
2. Check Air Filters for dust accumulation.
3. Clean Air Filters. (See "AIR FILTER CARE AND CLEANING" section on page 41.)
4. Turn the projector on again. (Refer to steps 2-3 of TURNING ON PROJECTOR on this page.)

If the WARNING TEMP. Indicator should still continue to flash, call Boxlight Corporation at 1-800-762-5757 or 360-779-7901.

ADJUSTING SCREEN

ZOOM ADJUSTMENT

- 1** Press ZOOM on Top Control or ZOOM ▲/▼ on Remote Control. The message “Zoom” is displayed.
- 2** Press ZOOM ▲ or POINT UP to make image larger, and press ZOOM ▼ or POINT DOWN to make image smaller.

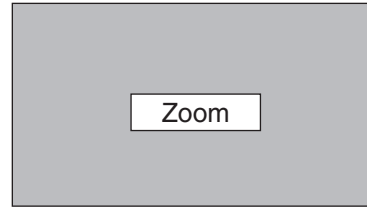

Message disappears after 4 seconds.

FOCUS ADJUSTMENT

- 1** Press FOCUS on Top Control or FOCUS ▲/▼ on Remote Control. The message “Focus” is displayed.
- 2** Adjust focus of image by pressing FOCUS ▲/▼ or POINT UP/DOWN.

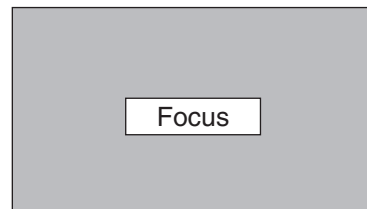

Message disappears after 4 seconds.

LENS SHIFT ADJUSTMENT

- 1** Press LENS SHIFT on Top Control or LENS SHIFT ▲/▼ on Remote Control. Message “Lens shift” is displayed.
- 2** Press POINT UP or LENS SHIFT ▲ to move image up, press POINT DOWN or LENS SHIFT ▼ to move image down.

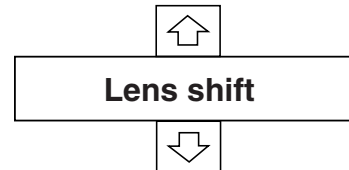

KEYSTONE ADJUSTMENT

If the projected picture has keystone distortion, correct the image with the KEYSTONE adjustment.

- 1** Press KEYSTONE on Top Control or Remote Control or select Keystone on SETTING menu. (Refer to page 36.) Keystone dialog box appears.
- 2** Correct keystone distortion by pressing POINT UP/DOWN/LEFT/RIGHT. Press POINT UP to reduce the upper part of the image, and press POINT DOWN to reduce the lower part. Press POINT LEFT to reduce the left part, and press POINT RIGHT to reduce the right part.



- Arrows are white in no correction.
- Arrow(s) of direction being corrected turn(s) red.
- Arrow(s) disappear(s) at the maximum correction.
- If you press the KEYSTONE on Top Control or on Remote Control while the keystone dialog box is being displayed, the keystone adjustment will be canceled.

Reduce the upper width with POINT UP.

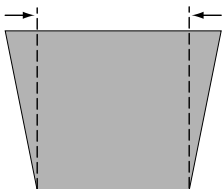

Reduce the lower width with POINT DOWN.

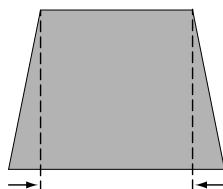

Reduce the left part with POINT LEFT.

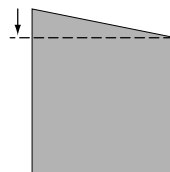

Reduce the right part with POINT RIGHT.

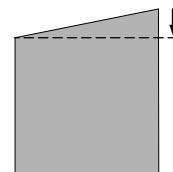

PICTURE FREEZE FUNCTION

Press FREEZE on Remote Control to freeze the picture on-screen. To cancel FREEZE function, press FREEZE again or press any other button.

NO SHOW FUNCTION

Press NO SHOW on Remote Control to black out the image. To restore to normal, press NO SHOW again or press any other button.

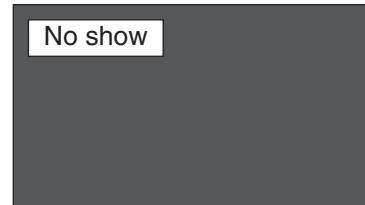

Message disappears after 4 seconds.

P-TIMER FUNCTION

Press P-TIMER on Remote Control. The timer display "00:00" appears on the screen and the timer starts to count time (00:00 ~ 59:59). To stop P-TIMER display, press P-TIMER. And then, press P-TIMER again to cancel P-TIMER function.



SOUND ADJUSTMENT

DIRECT OPERATION

Volume

Press VOLUME (+/-) on Top Control or on Remote Control to adjust volume. Volume dialog box appears on the screen for a few seconds. (+) button to increase volume, and (-) button to decrease.

Mute

Press MUTE on Remote Control to cut off sound. To restore sound to its previous level, press MUTE again or press Volume (+/-).

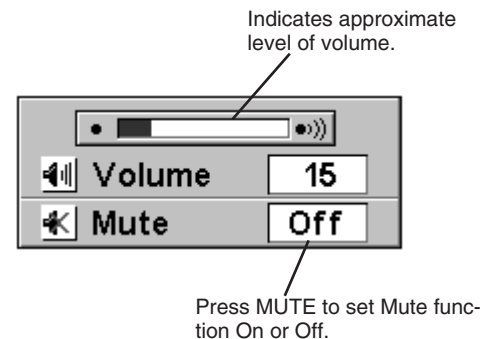

The display disappears after 4 seconds.

MENU OPERATION

- 1 Press MENU and ON-SCREEN MENU will appear. Press POINT LEFT/RIGHT to move the red frame pointer to SOUND.
- 2 Press POINT DOWN to move the red frame pointer to the item that you want to select, and then press SELECT.

Volume

To increase volume, press POINT RIGHT, press POINT LEFT to decrease volume.

Mute

Press POINT LEFT/RIGHT to cut off sound. Dialog box display is changed to "On" and sound is cut off. To restore sound to its previous level, press POINT LEFT/RIGHT again.

SOUND MENU

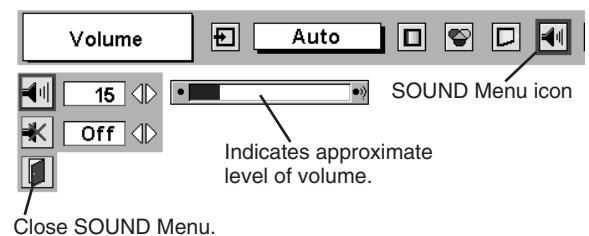

SELECTING INPUT SOURCE

DIRECT OPERATION

Select INPUT source by pressing INPUT button on Top Control.
Select INPUT source by pressing COMPUTER 1 or COMPUTER 2 on Remote Control.
If projector cannot reproduce proper image, select correct input source through MENU OPERATION (see below).

MENU OPERATION

When the analog output from a computer is connected to the Computer 1 (HDB 15-pin) terminal on the projector.

- 1 Press MENU and the ON-SCREEN MENU appears. Press POINT LEFT/RIGHT to move the red frame pointer to INPUT.
- 2 Press POINT DOWN to move the red arrow pointer to Computer 1 and then press SELECT. Source Select Menu will appear.
- 3 Press POINT DOWN and a red-arrow icon will appear. Move arrow to "RGB" and press SELECT.

- | | |
|--------------------|---|
| RGB | When computer is connected to Computer 1, select RGB. |
| RGB (Scart) | When video equipment is connected to Computer 1 terminal, select RGB (Scart). Refer to P31. |

When the digital or analog output from a computer is connected to the Computer 2 (DVI-I) terminal on the projector.

- 1 Press MENU and ON-SCREEN MENU will appear. Press POINT LEFT/RIGHT to move the red frame pointer to INPUT.
- 2 Press POINT DOWN to move the red arrow pointer to Computer 2 and then press SELECT. Source Select Menu will appear.
- 3 Move pointer to either RGB (Digital) or RGB (Analog) and then press SELECT.

- | | |
|----------------------|---|
| RGB (Digital) | When digital signal is connected to DVI terminal, select Digital. |
| RGB (Analog) | When analog signal is connected to DVI terminal, select Analog. |

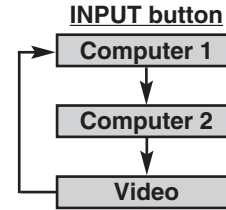

INPUT MENU

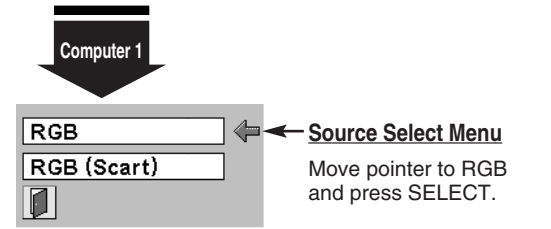
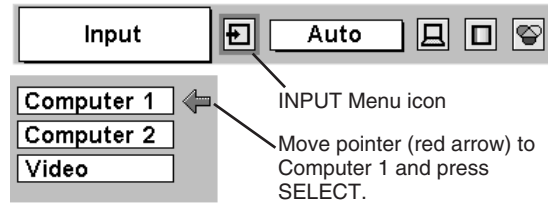

INPUT MENU

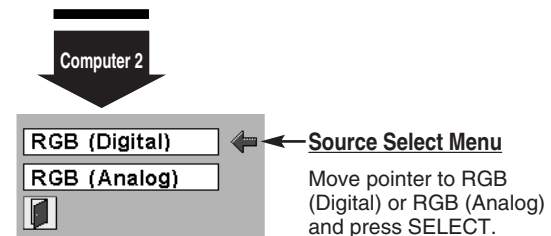
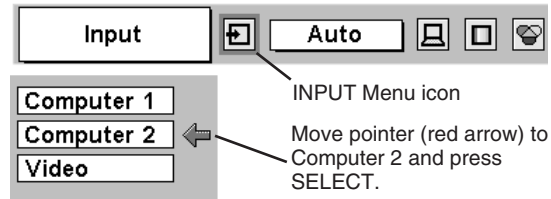

SELECTING COMPUTER SYSTEM

This projector automatically tunes to most different types of computers based on VGA, SVGA, XGA or SXGA (refer to "COMPATIBLE COMPUTER SPECIFICATIONS" on page 24). When a computer input is selected, the projector automatically tunes to the incoming signal and projects the proper image without any special setting. (Some computers may need to be set up manually.)

Note : Projector may display one of the following messages.

Auto When the projector cannot recognize the PC signal as a system programmed into the projector, the Auto PC Adjustment function attempts to adjust the projector and the message "Auto" is displayed on the SYSTEM Menu icon. (Refer to P25.) If the image is not displayed properly, manual adjustment is required. (Refer to P26 and 27.)

--- There is no signal input from computer. Make sure the computer and projector are connected and configured properly. (Refer to TROUBLESHOOTING on page 42.)

D-VGA, D-SVGA or D-XGA

When a digital computer signal is received on the DVI terminal, one of the above messages will be displayed on the PC SYSTEM Menu icon.

SELECT COMPUTER SYSTEM MANUALLY

This projector automatically selects PC system among those provided in this projector. The PC system can be also selected manually.

- 1 Press MENU and ON-SCREEN MENU will appear. Press POINT LEFT/RIGHT to move the red frame pointer to PC SYSTEM.
- 2 Press POINT DOWN to move the red arrow pointer to the system that you want to set, and then press SELECT.

PC SYSTEM MENU

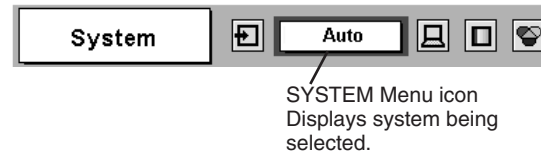

PC SYSTEM MENU

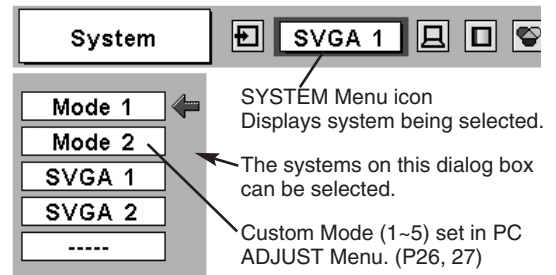

COMPATIBLE COMPUTER SPECIFICATIONS

This projector can accept signals from all computers with the V, H-Frequency mentioned below and less than 140 MHz Dot Clock.

ON-SCREEN DISPLAY	RESOLUTION	H-Freq. (kHz)	V-Freq. (Hz)	ON-SCREEN DISPLAY	RESOLUTION	H-Freq. (kHz)	V-Freq. (Hz)
VGA 1	640 x 480	31.47	59.88	XGA 11	1024 x 768	61.00	75.70
VGA 2	720 x 400	31.47	70.09	XGA 12	1024 x 768	35.522	86.96 (Interlace)
VGA 3	640 x 400	31.47	70.09	XGA 13	1024 x 768	46.90	58.20
VGA 4	640 x 480	37.86	74.38	XGA 14	1024 x 768	47.00	58.30
VGA 5	640 x 480	37.86	72.81	XGA 15	1024 x 768	58.03	72.00
VGA 6	640 x 480	37.50	75.00	MAC 19	1024 x 768	60.24	75.08
VGA 7	640 x 480	43.269	85.00	MAC 21	1152 x 870	68.68	75.06
MAC LC13	640 x 480	34.97	66.60	SXGA 1	1152 x 864	64.20	70.40
MAC 13	640 x 480	35.00	66.67	SXGA 2	1280 x 1024	62.50	58.60
RGB	————	15.625	50 (Interlace)	SXGA 3	1280 x 1024	63.90	60.00
RGB	————	15.734	60 (Interlace)	SXGA 4	1280 x 1024	63.34	59.98
SVGA 1	800 x 600	35.156	56.25	SXGA 5	1280 x 1024	63.74	60.01
SVGA 2	800 x 600	37.88	60.32	SXGA 6	1280 x 1024	71.69	67.19
SVGA 3	800 x 600	46.875	75.00	SXGA 7	1280 x 1024	81.13	76.107
SVGA 4	800 x 600	53.674	85.06	SXGA 8	1280 x 1024	63.98	60.02
SVGA 5	800 x 600	48.08	72.19	SXGA 9	1280 x 1024	79.976	75.025
SVGA 6	800 x 600	37.90	61.03	SXGA 10	1280 x 960	60.00	60.00
SVGA 7	800 x 600	34.50	55.38	SXGA 11	1152 x 900	61.20	65.20
SVGA 8	800 x 600	38.00	60.51	SXGA 12	1152 x 900	71.40	75.60
SVGA 9	800 x 600	38.60	60.31	SXGA 13	1280 x 1024	50.00	86.00 (Interlace)
SVGA 10	800 x 600	32.70	51.09	SXGA 14	1280 x 1024	50.00	94.00 (Interlace)
SVGA 11	800 x 600	38.00	60.51	SXGA 15	1280 x 1024	63.37	60.01
MAC 16	832 x 624	49.72	74.55	SXGA 16	1280 x 1024	76.97	72.00
XGA 1	1024 x 768	48.36	60.00	SXGA 17	1152 x 900	61.85	66.00
XGA 2	1024 x 768	68.677	84.997	SXGA 18	1280 x 1024	46.43	86.70 (Interlace)
XGA 3	1024 x 768	60.023	75.03	SXGA 19	1280 x 1024	63.79	60.18
XGA 4	1024 x 768	56.476	70.07	SXGA 21	1400 x 1050	63.93	60.00
XGA 5	1024 x 768	60.31	74.92	MAC	1280 x 960	75.00	75.08
XGA 6	1024 x 768	48.50	60.02	MAC	1280 x 1024	80.00	75.08
XGA 7	1024 x 768	44.00	54.58	720p (HDTV)	————	45.00	60.00
XGA 8	1024 x 768	63.48	79.35	1035i (HDTV)	————	33.75	60.00 (Interlace)
XGA 9	1024 x 768	36.00	87.17 (Interlace)	1080i 60(HDTV)	————	33.75	60.00 (Interlace)
XGA 10	1024 x 768	62.04	77.07	1080i 50(HDTV)	————	28.125	50.00 (Interlace)

When the input signal is digital from DVI terminal, refer to the chart below.

ON-SCREEN DISPLAY	RESOLUTION	H-Freq. (kHz)	V-Freq. (Hz)	ON-SCREEN DISPLAY	RESOLUTION	H-Freq. (kHz)	V-Freq. (Hz)
D-VGA	640 x 480	31.469	59.940	D-XGA	1024 x 768	48.363	60.004
D-SVGA	800 x 600	37.879	60.317				

NOTE : Specifications are subject to change without notice.

PC ADJUSTMENT

AUTO PC ADJUSTMENT

Auto PC Adjustment function is provided to automatically adjust Fine sync, Total dots and Picture Position to conform to your computer. Auto PC Adjustment function can be operated as follows.



Auto PC Adj.

- 1 Press MENU and ON-SCREEN MENU will appear. Press POINT LEFT/RIGHT to move the red frame pointer to PC ADJUST.
- 2 Press POINT DOWN to move the red frame pointer to AUTO PC Adj. and then press SELECT twice.
This Auto PC Adjustment can be also executed by pressing AUTO PC ADJ. on Top Control or on Remote Control.

Store adjustment parameters.

Adjustment parameters from Auto PC Adjustment can be memorized in this projector. Once parameters are memorized, the setting can be recalled just by selecting that Mode from the PC SYSTEM Menu (P23). Refer to step 3 of MANUAL PC ADJUSTMENT section (P27).

NOTE

- Fine sync, Total dots and Picture Position of some computers can not be fully adjusted with the Auto PC Adjustment function. When the image is not displayed properly through this function, manual adjustments are required. (Refer to page 26, 27.)
- The Auto PC Adjustment function cannot be selected for Digital Signal inputs on the DVI terminal or if "RGB", "1035i (HDTV)", "1080i50 (HDTV)" or "1080i60 (HDTV)" is selected on the PC SYSTEM Menu (P23).

PC ADJUST MENU

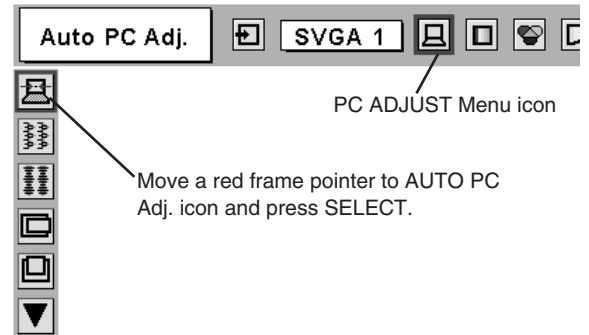

MANUAL PC ADJUSTMENT

This projector can automatically tune to the display signals from most personal computers currently distributed. However, some computers employ special signal formats which are different from the standard ones and may not be tuned by Multi-Scan system of this projector. If this happens, the projector cannot reproduce a proper image, the image may be flickering, non-synchronized, non-centered or skewed.

This projector has a Manual PC Adjustment to enable you to precisely adjust several parameters to match those special signal formats. The projector has 5 independent memory areas to store the manually adjusted parameters. This enables you to recall the setting for a specific computer whenever you use it.

Note : This PC ADJUST Menu cannot be operated when DVI is selected on PC SYSTEM MENU (P23).

1 Press MENU and ON-SCREEN MENU will appear. Press POINT LEFT/RIGHT to move the red frame pointer to PC ADJUST.

2 Press POINT DOWN to move the red frame pointer to the item that you want to adjust and then press SELECT. Adjustment dialog box will appear. Press POINT LEFT/RIGHT to adjust value.



Fine sync

Adjusts image as necessary to eliminate flicker from the display. Press POINT LEFT/RIGHT to adjust value. (From 0 to 31.)



Total dots

The number of total dots in one horizontal period. Press POINT LEFT/RIGHT and adjust number to match your PC output.



Horizontal

Adjusts horizontal picture position. Press POINT LEFT/RIGHT to adjust the position.



Vertical

Adjusts vertical picture position. Press POINT LEFT/RIGHT to adjust the position.



Current mode

Press SELECT to show the information of computer selected.



Clamp

Adjusts clamp level. When the image has a dark bar(s), try this adjustment.

PC ADJUST MENU

Auto PC Adj. [SVGA 1] [PC ADJUST Menu icon]

PC ADJUST Menu icon

Move red frame icon to the item and press SELECT.

Fine sync [Mode 1] [Stored] (Shows status (Stored / Free) of the selected Mode.)

15 (Press POINT LEFT/RIGHT to adjust the value.)

Press SELECT at this icon to adjust "Clamp," "Display area (H/V)" or set "Full screen."

Current mode

H-Sync freq.	48.5
V-Sync freq.	60

Press SELECT at Current mode icon to show the information of computer connected.

Display area

Selects area displayed with this projector. Select the resolution at Display area dialog box.

Display area H

Adjustment of horizontal area displayed with this projector. Press POINT LEFT/RIGHT to decrease/increase value and then press SELECT.

Display area V

Adjustment of vertical area displayed with this projector. Press POINT LEFT/RIGHT to decrease/increase value and then press SELECT.

Full screen

Press POINT LEFT/RIGHT to switch Full screen function to "On" or "Off." Set "On" to resize the image with 4 x 3 aspect ratio to fit the screen.

NOTE : Fine sync, Display area, Display area H, Display area V and Full screen cannot be adjusted when "RGB", "1035i (HDTV)", "1080i50(HDTV)" or "1080i60 (HDTV)" is selected on PC SYSTEM Menu (P23).

3 Store

To store adjustment parameters, move red frame pointer to Store icon and then press SELECT. Move red arrow pointer to any of Mode 1 to 5 that you want to store to and then press SELECT.

Mode free

To clear adjustment parameters previously set, move red frame pointer to Mode free icon and then press SELECT. Move red arrow pointer to the Mode that you want to clear and then press SELECT.

Other icons operate as follows.

Reset

Reset all adjust parameters on adjustment dialog box to previous values.

Quit

Closes PC ADJUST MENU.

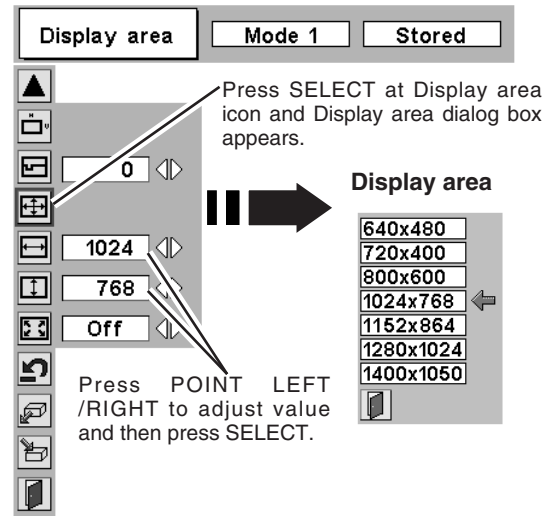

To store adjustment data.

This Mode has parameters being stored.

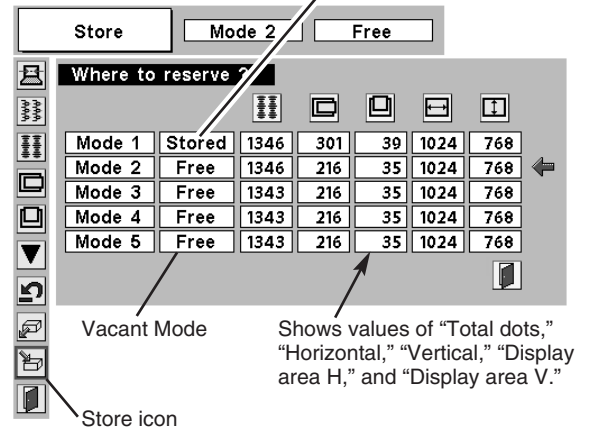

To clear adjustment data.

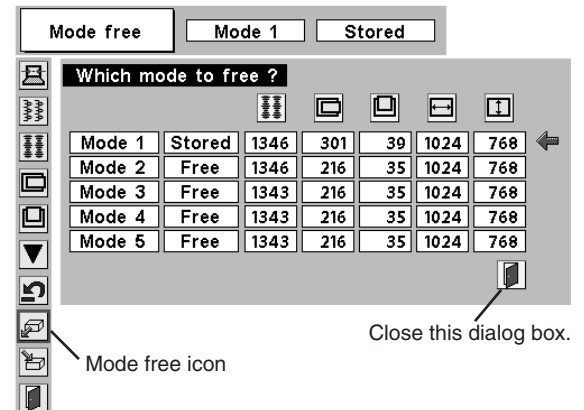

PICTURE IMAGE ADJUSTMENTS

IMAGE LEVEL SELECT (DIRECT)

Select image level from Standard, Real, Image 1, Image 2, Image 3 and Image 4 by pressing IMAGE on Top Control or on Remote Control.

Standard

Normal picture level preset on this projector.

Real

Picture level with improved halftone for graphics.

IMAGE 1~4

User preset picture adjustment in IMAGE ADJUST Menu (P29).

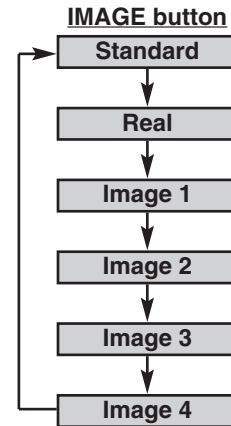

IMAGE LEVEL SELECT (MENU)

1 Press MENU and ON-SCREEN MENU will appear. Press POINT LEFT/RIGHT to move the red frame pointer to IMAGE SELECT.

2 Press POINT DOWN to move the red frame pointer to the level that you want to set and then press SELECT.



Standard

Normal picture level preset on this projector.



Real

Picture level with improved halftone for graphics.



IMAGE 1~4

User preset picture adjustment in IMAGE ADJUST Menu (P29).

IMAGE SELECT MENU

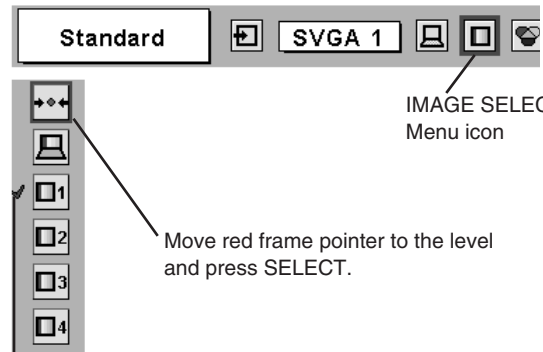

IMAGE LEVEL ADJUSTMENT

1 Press MENU and ON-SCREEN MENU will appear. Press POINT LEFT/RIGHT to move the red frame pointer to IMAGE ADJUST.

2 Press POINT DOWN to move the red frame pointer to the item that you want to adjust and then press SELECT. The level of each item is displayed. Adjust each level by pressing POINT LEFT/RIGHT.

 **Contrast**

Press POINT LEFT to decrease contrast, and POINT RIGHT to increase contrast. (From 0 to 63.)

 **Brightness**

Press POINT LEFT to adjust image darker, and POINT RIGHT to adjust brighter. (From 0 to 63.)

 **Color temp.**

Press either POINT LEFT or POINT RIGHT to Color temp. level that you want to select. (XLow, Low, Mid or High)

 **White balance (Red)**

Press POINT LEFT to lighten red tone and POINT RIGHT to deepen tone. (From 0 to 63.)

 **White balance (Green)**

Press POINT LEFT to lighten green tone and POINT RIGHT to deepen tone. (From 0 to 63.)

 **White balance (Blue)**

Press POINT LEFT to lighten blue tone and POINT RIGHT to deepen tone. (From 0 to 63.)

 **Gamma**

Press either POINT LEFT or POINT RIGHT to obtain better balance of contrast. (From 0 to 15.)

3  **Store**

To store manually preset image, move red frame pointer to Store icon and press SELECT. Image Level Menu will appear. Move red frame pointer to the Image 1 to 4 where you want to store and then press SELECT.

Other icons operates as follows.

 **Reset**

Reset all adjustment to previous values.

 **Quit**

Closes IMAGE MENU.

IMAGE ADJUST MENU

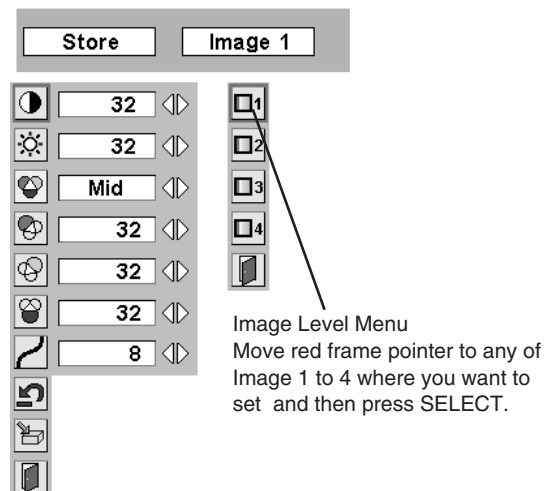
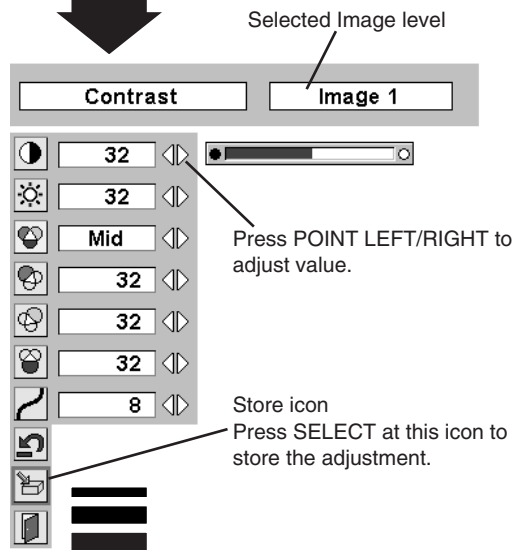
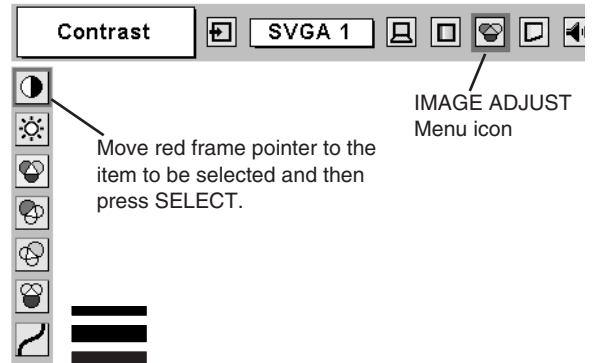

PICTURE SCREEN ADJUSTMENT

This projector has a picture screen resize function, which enables you to choose how the projector displays computer images.

- 1 Press MENU and ON-SCREEN MENU will appear. Press POINT LEFT/RIGHT to move the red frame pointer to SCREEN.
- 2 Press POINT DOWN and move the red frame pointer to the function that you want to select and then press SELECT.



Normal

Provides image to fit screen size.



True

Provides image in its original size. When the original image size is larger than screen size (1024 x 768), this projector enters “Digital zoom +” mode automatically.



Wide

Provides image to fit wide video aspect ratio (16 : 9) by expanding image width uniformly. This function can be used for providing a squeezed video signal at 16 : 9.



Digital zoom +

When Digital zoom + is selected, ON-SCREEN MENU disappears and the message “D. Zoom +” is displayed. Press SELECT to expand image size. And press POINT UP/DOWN/LEFT/RIGHT to pan the image. Panning function can work only when the image is larger than screen size.

The projected image can also be expanded by pressing D.ZOOM ▲ on Remote Control.



Digital Zoom -

When Digital zoom - is selected, ON-SCREEN MENU disappears and the message “D. Zoom -” is displayed. Press SELECT to compress image size.

The projected image can also be compressed by pressing D.ZOOM ▼ on Remote Control.

To cancel Digital Zoom +/- mode, press any button except D.ZOOM ▲/▼, SELECT, POINT and LASER.

SCREEN MENU

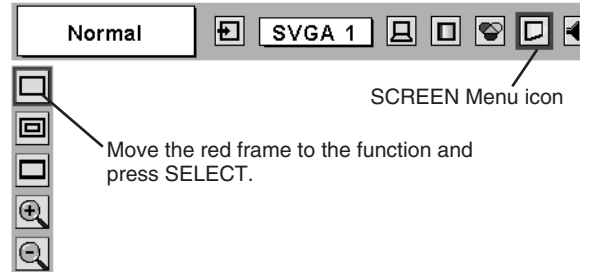

NOTE

- Picture screen adjustment cannot be operated when “1035i (HDTV)”, “1080i50 (HDTV)” or “1080i60 (HDTV)” is selected on PC SYSTEM Menu (P23).
- Wide cannot be selected when “720p (HDTV)” is selected on PC SYSTEM Menu (P23).
- True and Digital zoom +/- cannot be operated when “RGB” is selected on PC SYSTEM Menu (P23).
- This projector cannot display any resolution higher than 1280 X 1024. If your computer’s screen resolution is higher than 1280 X 1024, reset the resolution to the lower before connecting projector.
- The image data in other than XGA (1024 x 768) is modified to fit the screen size in initial mode.
- Panning function may not operate properly if the computer system prepared on PC ADJUST Menu is used.

SELECTING INPUT SOURCE

DIRECT OPERATION

Select INPUT source by pressing INPUT on Top Control.
 Select INPUT source by pressing COMPUTER 1 or VIDEO on Remote Control.
 If projector cannot reproduce proper image, select correct input source through MENU OPERATION (see below).

MENU OPERATION

When connecting to video equipment, select the type of connection in the SOURCE SELECT MENU.

- 1 Press MENU and ON-SCREEN MENU will appear. Press POINT LEFT/RIGHT to move the red frame pointer to INPUT.
- 2 Press POINT DOWN to move the red arrow pointer to Video and then press SELECT. Source Select Menu will appear.
- 3 Move pointer to the source that you want to select and then press SELECT.

- Auto** Projector automatically detects incoming Video signal, and adjusts itself to optimize its performance.
 - When both VIDEO jack and S-VIDEO jack are connected, S-VIDEO jack has priority over VIDEO jack.
 - When both Y-Pb/Cb-Pr/Cr jacks and S-VIDEO jack are connected, Y-Pb/Cb-Pr/Cr jacks have priority over S-VIDEO jack.
- Video** When video input signal is connected to VIDEO jack, select Video.
- S-Video** When video input signal is connected to S-VIDEO jack, select S-Video.
- Y,Pb/Cb,Pr/Cr** When video input signal is connected to Y-Pb/Cb-Pr/Cr jacks, select Y, Pb/Cb, Pr/Cr.

When connecting a 21-pin Scart (RGB) output from video equipment to computer 1 (HDB 15-pin) terminal on the projector.

- 1 Press MENU and ON-SCREEN MENU will appear. Press POINT LEFT/RIGHT to move the red frame pointer to INPUT.
- 2 Press POINT DOWN to move the red arrow pointer to Computer 1 and then press SELECT. Source Select Menu will appear.
- 3 Press POINT DOWN and a red-arrow icon will appear. Move arrow to "RGB (Scart)" and press SELECT.

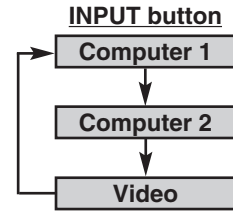

INPUT MENU

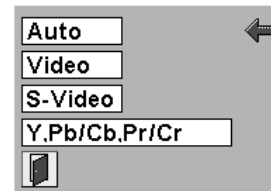
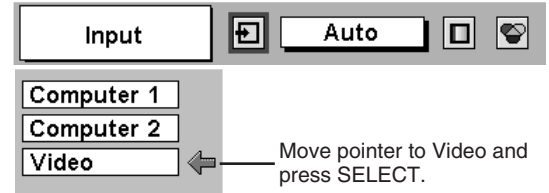

Source Select Menu (VIDEO)
 Move pointer to the source and press SELECT.

INPUT MENU

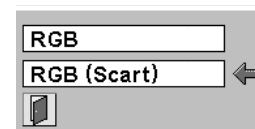
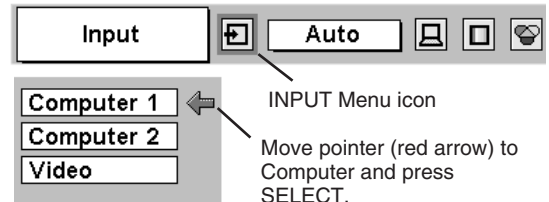

Source Select Menu
 Move pointer to RGB (Scart) and press SELECT.

SELECTING VIDEO SYSTEM

- 1 Press MENU and ON-SCREEN MENU will appear. Press POINT LEFT/RIGHT to move the red frame pointer to AV SYSTEM.
- 2 Press POINT DOWN to move the red arrow pointer to the system that you want to select and then press SELECT.

VIDEO JACK OR S-VIDEO JACK

Auto

Projector automatically detects incoming Video system, and adjusts itself to optimize its performance.
When Video System is PAL-M or PAL-N, select system manually.

PAL / SECAM / NTSC / NTSC4.43 / PAL-M / PAL-N

If projector cannot reproduce proper video image, it is necessary to select a specific broadcast signal format from PAL, SECAM, NTSC, NTSC 4.43, PAL-M, and PAL-N.

AV SYSTEM MENU (VIDEO OR S-VIDEO)

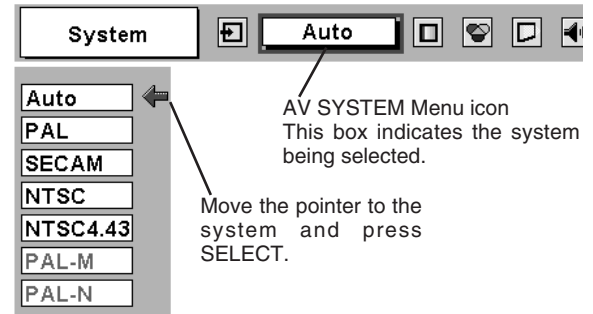

Y, Pb/Cb, Pr/Cr JACKS

Auto

Projector automatically detects incoming Video signal, and adjusts itself to optimize its performance.

COMPONENT VIDEO SIGNAL FORMAT

If projector cannot reproduce proper video image, it is necessary to select a specific component video signal format from 480i, 575i, 480p, 575p, 720p, 1035i and 1080i.

AV SYSTEM MENU (COMPONENT VIDEO)

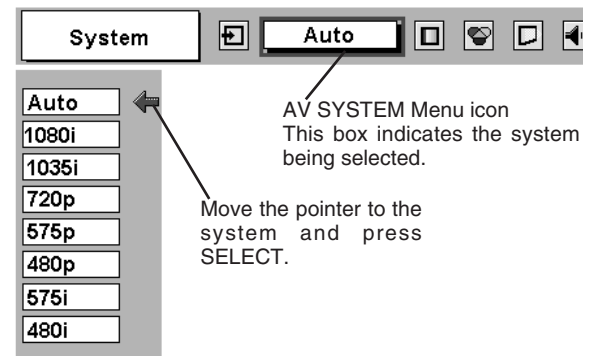

PICTURE IMAGE ADJUSTMENTS

IMAGE LEVEL SELECT (DIRECT)

Select image level from Standard, Cinema, Image 1, Image 2, Image 3 and Image 4 by pressing IMAGE on Top Control or on Remote Control.

Standard

Normal picture level preset on this projector.

Cinema

Picture level adjusted for the picture with fine tone.

IMAGE 1~4

User preset picture adjustment in IMAGE ADJUST Menu (P34, 35).

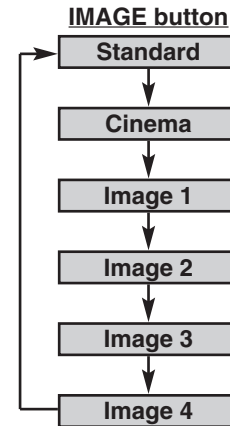

IMAGE LEVEL SELECT (MENU)

- 1 Press MENU and ON-SCREEN MENU will appear. Press POINT LEFT/RIGHT to move the red frame pointer to IMAGE SELECT.
- 2 Press POINT DOWN to move the red frame pointer to the level that you want to set and then press SELECT.

Standard

Normal picture level preset on this projector.

Cinema

Picture level adjusted for the picture with fine tone.

IMAGE 1~4

User preset picture adjustment in IMAGE ADJUST Menu (P34, 35).

IMAGE SELECT MENU

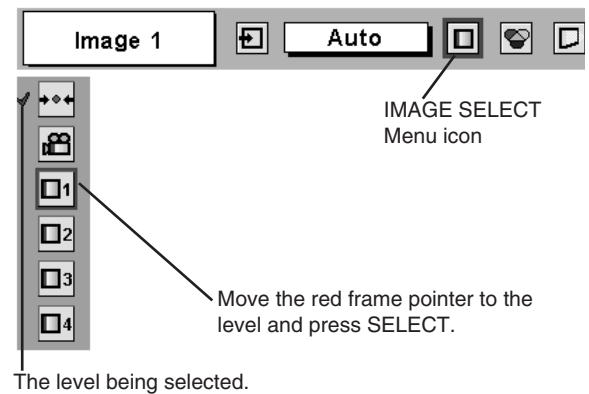

IMAGE LEVEL ADJUSTMENT

- 1 Press MENU and ON-SCREEN MENU will appear. Press POINT LEFT/RIGHT to move the red frame pointer to IMAGE ADJUST.
- 2 Press POINT DOWN to move the red frame pointer to the item that you want to adjust and then press SELECT. The level of each item is displayed. Adjust each level by pressing POINT LEFT/RIGHT.

Contrast

Press POINT LEFT to decrease contrast, POINT RIGHT to increase contrast. (From 0 to 63.)

Brightness

Press POINT LEFT to adjust image darker, POINT RIGHT to adjust brighter. (From 0 to 63.)

Color

Press POINT LEFT to lighten color, POINT RIGHT to deepen color. (From 0 to 63.)

Tint

Press POINT LEFT or POINT RIGHT to obtain proper color. (From 0 to 63.)

Color temp.

Press either POINT LEFT or POINT RIGHT to Color temp. level that you want to select. (XLow, Low, Mid or High)

White balance (Red)

Press POINT LEFT to lighten red tone and POINT RIGHT to deepen tone. (From 0 to 63.)

White balance (Green)

Press POINT LEFT to lighten green tone and POINT RIGHT to deepen tone. (From 0 to 63.)

White balance (Blue)

Press POINT LEFT to lighten blue tone and POINT RIGHT to deepen tone. (From 0 to 63.)

Sharpness

Press POINT LEFT to soften the image, and POINT RIGHT to sharpen the image. (From 0 to 31.)

Gamma

Press either POINT LEFT or POINT RIGHT to obtain better balance of contrast. (From 0 to 15.)

Noise reduction

Press POINT LEFT/RIGHT to change noise reduction mode. Dialog box display is changed to "On" to reduce noise (rough parts) of image. Press POINT LEFT/RIGHT again, to change noise reduction mode to off.

Progressive scan

Press POINT LEFT/RIGHT to change progressive scan mode. Dialog box display is changed to "Off", "L1", "L2".

Off ... Progressive scan mode to OFF.

L1 ... Progressive scan mode to ON (for active picture).

L2 ... Progressive scan mode to ON (for still picture).

IMAGE ADJUST MENU

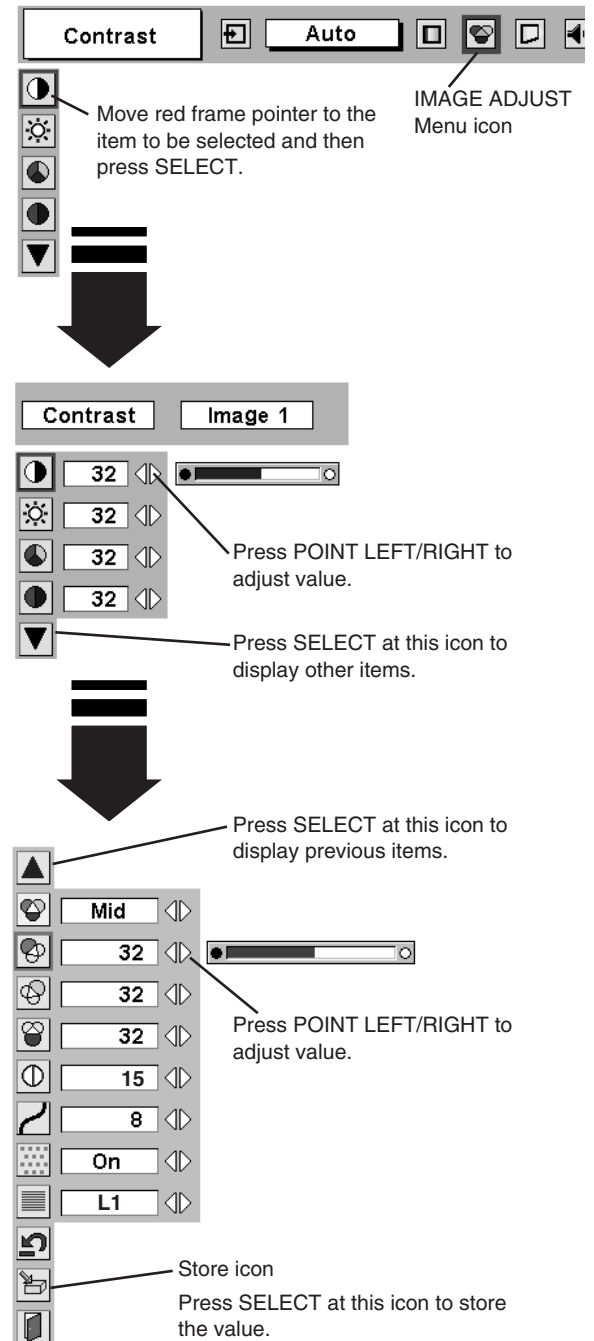

Move red frame pointer to the item to be selected and then press SELECT.

IMAGE ADJUST Menu icon

Press POINT LEFT/RIGHT to adjust value.

Press SELECT at this icon to display other items.

Press SELECT at this icon to display previous items.

Press POINT LEFT/RIGHT to adjust value.

Store icon
Press SELECT at this icon to store the value.

NOTE :

Tint cannot be adjusted when the video system is PAL, SECAM, PAL-M or PAL-N.

Progressive cannot be operated when "480p", "575p", "720p", "1035i" or "1080i" is selected on AV SYSTEM MENU (P32).

3  **Store**

To store the adjustment data, move red frame pointer to Store icon and press SELECT. Image Level Menu will appear. Move red frame pointer to the Image Level 1 to 4 and then press SELECT.

Other icons operates as follows.

 **Reset**

Reset all adjustment to previous values.

 **Quit**

Closes IMAGE MENU.

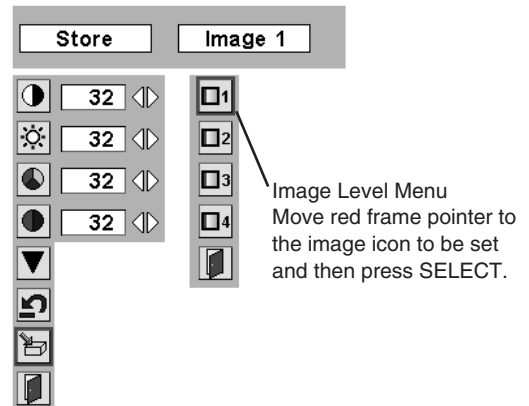

PICTURE SCREEN ADJUSTMENT

This projector has a picture screen resize function, which enables you to control how the projector displays 16:9 images.

1 Press MENU and ON-SCREEN MENU will appear. Press POINT LEFT/RIGHT to move the red frame pointer to SCREEN.

2 Press POINT DOWN and move the red frame pointer to the function that you want to select and then press SELECT.

 **Normal**

Provides image at a normal video aspect ratio of 4 : 3.

 **Wide**

Provides image at a wide screen ratio of 16 : 9.

SCREEN MENU

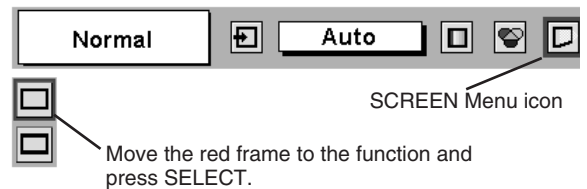

NOTE : SCREEN Menu cannot be operated when "720p," "1035i," or "1080i" is selected on AV SYSTEM Menu (P32).

SETTING MENU

- 1 Press MENU and ON-SCREEN MENU will appear. Press POINT LEFT/RIGHT to move the red-frame pointer to SETTING.
- 2 Press POINT DOWN to move the red-frame pointer to the item that you want to set and then press SELECT. Setting dialog box appears.

Language

Language used in ON-SCREEN MENU is selectable from among English, German, French, Italian, Spanish, Portuguese, Dutch, Swedish, Chinese, Korean and Japanese.

Keystone

When the image is distorted, select Keystone. ON-SCREEN MENU disappears and Keystone dialog box is displayed.

Store ... The keystone settings will be stored and loaded automatically when the projector is turned on.

Reset ... The keystone settings will not be stored, the default settings will be loaded when the projector is turned on.

Correct keystone distortion by pressing POINT UP/DOWN/LEFT/RIGHT. Refer to KEYSTONE ADJUSTMENT on page 20.

Blue back

When this function is "On," and the projector is not receiving any input, a blank, blue screen will be displayed instead of video noise.

Display

This function decides whether to display On-Screen Displays.

On ... shows all the On-Screen Displays.

Off ... No On-Screen Displays will show except;

- ON-SCREEN MENU
- "Power off?" message

Logo

When this function is "On," projector displays our logo when starting up.

Ceiling

When this function is "On," picture is top/bottom and left/right reversed. This function is used when the projector is mounted upside down e.g. hanging from a ceiling mount.

Rear

When this function is "On," picture is left/right reversed. This function is used to project the image onto a rear projection screen.

SETTING MENU

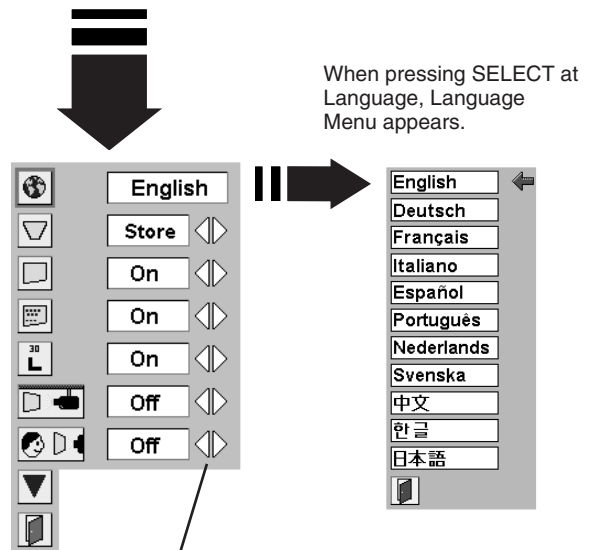
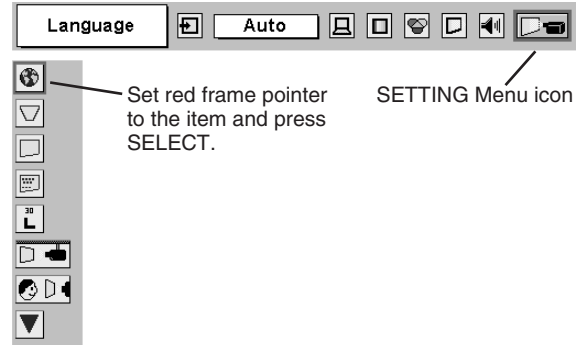

Ceiling function

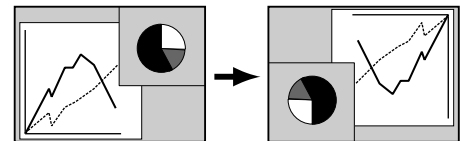

Rear function

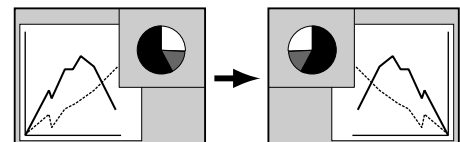

Power management

This function turns the Projection Lamp off when the projector detects signal interruption and is not used for a certain period. This reduces power consumption and helps extend Lamp-life. (This projector is shipped with this function ON.)

This function operates as follows;

1. When the input signal is interrupted, a "No signal" message and 5 minute count-down are displayed.
2. When the count-down is complete, The Projection Lamp and READY Indicator are turned off. (Cooling Fans keep running.)
3. The READY Indicator starts to flash after the cool-down sequence is complete (about 90 seconds)
The Projection Lamp will be turned on automatically when an input signal is connected or if any button on the Top Control or Remote Control is pressed.

On start

When this function is "On," the projector will turn on automatically when it is connected to AC Power.

Note ; Be sure to turn the projector off properly (refer to the section "TURNING OFF PROJECTOR" on P19). If the projector is turned off incorrectly, the On Start function may not operate properly.

Lamp mode

When selecting the "Eco" mode, the projector reduces the brightness of the lamp and reduces the cooling fan speed to conserve power and extend lamp life.

Remote control

This projector has eight different remote control codes; the factory-set normal code (Code 1) and seven additional codes (Code 2 to Code 8). This switching function allows several projectors in the same area to be controlled via remote control without interfering with each other.

For example operating projector in "Code 7," both projector and Remote Control must be switched to "Code 7."

To change the code of Projector;

To change the Remote control code of the projector use the ON-SCREEN MENU to select from Code 1 to Code 8.

To change the code of the Remote Control;

To change the remote control code of the Remote Control, set the DIP switches 1-3 inside the battery compartment box of the Remote Control. (Refer to P14.)

Lamp counter reset

This function is used to reset the Lamp Replace Counter. When replacing the Projection Lamp, reset the Lamp Replace Counter using this function. Refer to page 38 for operation.

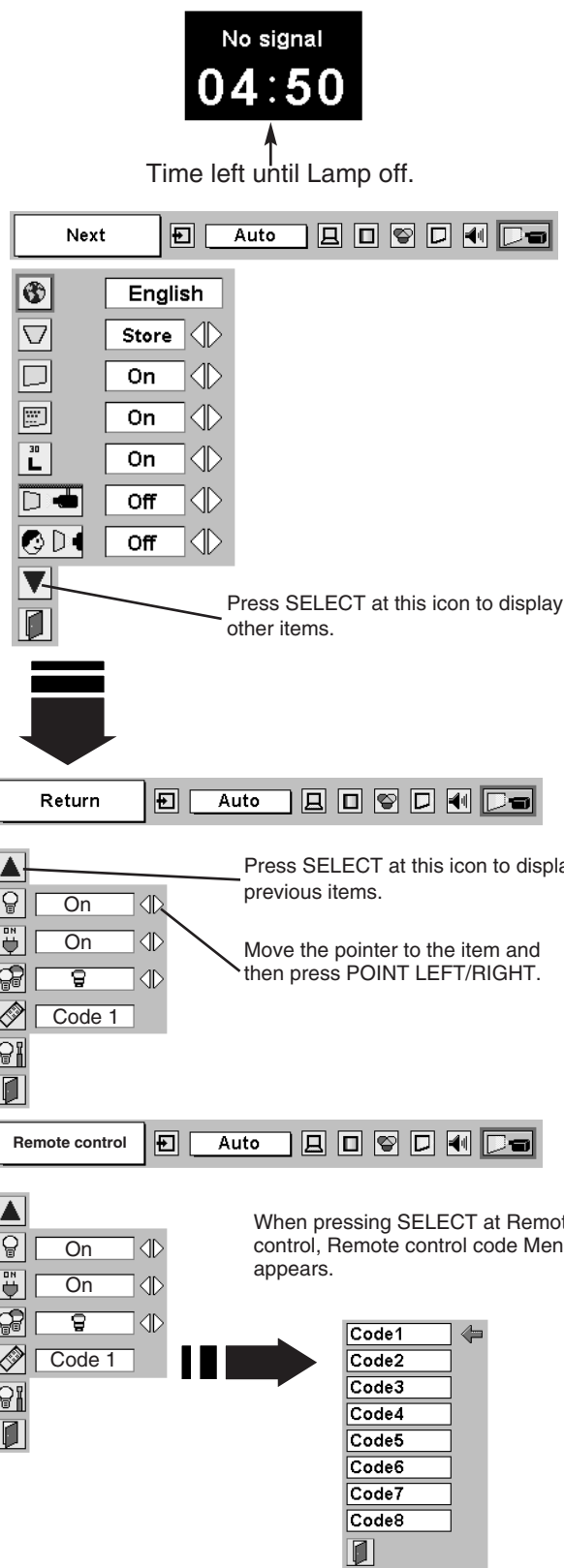

The image shows a series of screenshots from the projector's on-screen menu. At the top, a black box displays "No signal" and a 5-minute countdown timer "04:50". Below this, a control bar shows "Next" and "Auto" buttons. The main menu lists various settings: "English", "Store", "On", "On", "On", "Off", and "Off". A large downward arrow indicates the next screen, which shows "Return" and "Auto" buttons. Below that, a menu lists "On", "On", "Code 1", and "Code 1". A large rightward arrow indicates the final screen, which is the "Remote control" menu, showing "Code1" through "Code8" options. Text annotations explain that pressing SELECT at the top icon displays other items, and moving the pointer to an item and pressing POINT LEFT/RIGHT selects it. Another annotation states that pressing SELECT at the Remote control menu displays the Remote control code menu.

LAMP REPLACEMENT

LAMP REPLACE

When the life of the Projection Lamp draws to an end, the LAMP REPLACE indicator lights yellow. When this indicator lights yellow, replace the projection lamp with a new one promptly.

This indicator lights yellow when the life of the projection lamp draws to an end. Replace the Projection Lamp with a new one promptly.

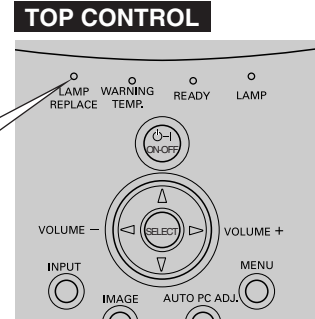

Allow a projector to cool, for at least 45 minutes before you open Lamp Cover. The inside of a projector can become very hot.



CAUTION

For continued safety, replace with a lamp assembly of the same type.

Do not drop the lamp assembly or touch the glass bulb! The glass can shatter and may cause injury.

Follow these steps to replace the lamp assembly.

- 1 Turn off the projector and disconnect the AC plug. Allow the projector to cool for at least 45 minutes.
- 2 Remove the Lamp Cover screw and remove the Lamp Cover.
- 3 Loosen the 2 lamp assembly screws with a screwdriver and pull out the Lamp Assembly by grasping the Handle and pulling up.
- 4 Replace the Lamp Assembly with a new one and replace the 2 screws. Make sure that the Lamp Assembly is set properly. Replace Lamp Cover and tighten the screw.
- 5 Connect AC Power Cord to the projector and turn on the projector.
- 6 **Reset the Lamp Replace Counter.**
Refer to "LAMP REPLACE COUNTER" on the next page.

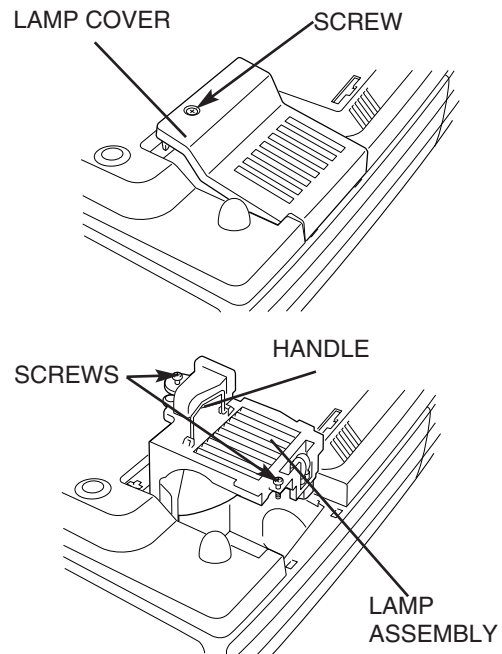

ORDER REPLACEMENT LAMP

Replacement Lamp can be ordered through Boxlight Corporation at 1-800-762-5757 or 360-779-7901. When ordering Projection Lamp, give following information to dealer.

- **Model No. of your projector** : **BOXLIGHT MP-56t**
- **Replacement Lamp Type No.** : **POA-LMP59**

(Service Parts No. 610 305 5602)

LAMP REPLACE COUNTER

Be sure to reset the Lamp Replace Counter after the Lamp Assembly is replaced. When the Lamp Replace Counter is reset, the LAMP REPLACE Indicator stops lighting.

- 1 Turn projector on, press MENU and ON-SCREEN MENU will appear. Press POINT LEFT/RIGHT to move the red frame pointer to SETTING (refer to page 36, 37).
- 2 Press POINT DOWN to move the red frame pointer to "Lamp counter reset" and then press SELECT. The message "Lamp replace counter reset?" is displayed. Move the pointer to [Yes] and then press SELECT.
- 3 Another confirmation dialog box appears select [Yes] to reset Lamp Replace Counter.

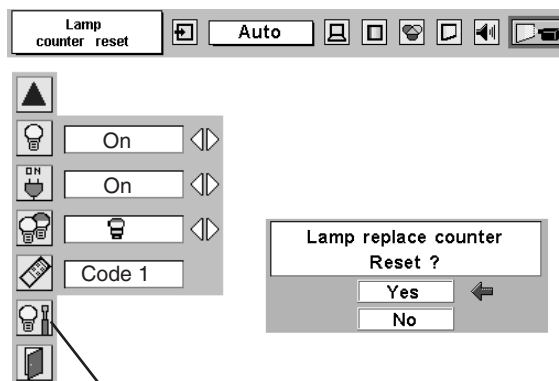

Move the pointer to Lamp counter reset and then press SELECT. The message "Lamp replace counter reset?" is displayed.

NOTE : Do not reset the Lamp Replace Counter until after the Projection Lamp is replaced.



LAMP HANDLING PRECAUTIONS

This projector uses a high-pressure lamp which must be handled carefully and properly. Improper handling may result in accidents, injury, or create a fire hazard.

- Lamp lifetime may differ from lamp to lamp and according to the environment of use. There is no guarantee of the same lifetime for each lamp. Some lamps may fail or terminate their lifetime in a shorter period of time than other similar lamps.
- If the projector indicates that the lamp should be replaced, i.e., if the LAMP REPLACE INDICATOR lights up, replace the lamp with a new one IMMEDIATELY after the projector has cooled down. (Follow carefully the instructions in the LAMP REPLACEMENT section of this manual.) Continuous use of the lamp with the LAMP REPLACE INDICATOR lighted may increase the risk of lamp explosion.
- A Lamp may explode as a result of vibration, shock or degradation as a result of hours of use as its lifetime draws to an end. Risk of explosion may differ according to the environment or conditions in which the projector and lamp are being used.

IF A LAMP EXPLODES, THE FOLLOWING SAFETY PRECAUTIONS SHOULD BE TAKEN.

If a lamp explodes, disconnect the projector's AC plug from the AC outlet immediately. Contact an authorized service station for a checkup of the unit and replacement of the lamp. Additionally, check carefully to ensure that there are no broken shards or pieces of glass around the projector or coming out from the cooling air circulation holes. Any broken shards found should be cleaned up carefully. No one should check the inside of the projector except those who are authorized trained technicians and who are familiar with projector service. Inappropriate attempts to service the unit by anyone, especially those who are not appropriately trained to do so, may result in an accident or injury caused by pieces of broken glass.

OPERATING WIRELESS MOUSE

The Wireless Remote Control not only operates the projector but can also function as a wireless mouse for most Personal Computers. The POINT, drag ON/OFF and two CLICK buttons are used for wireless mouse operation.

The Wireless Mouse function is available only when PC mouse pointer is displayed on the screen. When ON-SCREEN MENU or any message/dialog box is displayed on the screen instead of PC mouse pointer, the Wireless Mouse function cannot be used.

INSTALLATION

To use Wireless Remote Control as Wireless Mouse for a Personal Computer, installation of the mouse driver (not supplied) is required. Make sure that the mouse driver is properly installed in your computer. And make sure that the mouse port (or USB port) of a Personal Computer is activated.

- 1 Connect the mouse port (or USB port) of your computer to Control Port (or USB connector) of this projector with Control Cable (or USB cable). (Refer to page 11, 12 for connection.)
- 2 Turn the projector on first, and then turn on your computer. When the computer is switched on first, Wireless Mouse may not work properly.

Note : When your computer has no mouse port, connect Serial Port of your computer to Control Port of the projector with Control Cable for Serial Port (supplied).

OPERATING WIRELESS MOUSE

Use the POINT, Drag ON/OFF, LEFT CLICK and RIGHT CLICK buttons on the Remote Control to control the mouse functions on your computer.

POINT button

Used to move PC mouse pointer. The pointer is moved corresponding with the direction you are pressing.

LEFT CLICK button

This button has the same function as the left button in a PC mouse. Press this button and the POINT button to drag a selected screen object.

RIGHT CLICK button

This button has the same function as the right button in a PC mouse.

DRAG ON/OFF button

Use this button and the POINT button to drag a selected screen object. Press and release the Drag ON/OFF button, DRAG ON INDICATOR lights green and the remote control is in Drag mode. Use the POINT button in the direction that you want to drag the screen object. Press and release the Drag ON/OFF button again or press any other button, to drop the object at the new screen location.

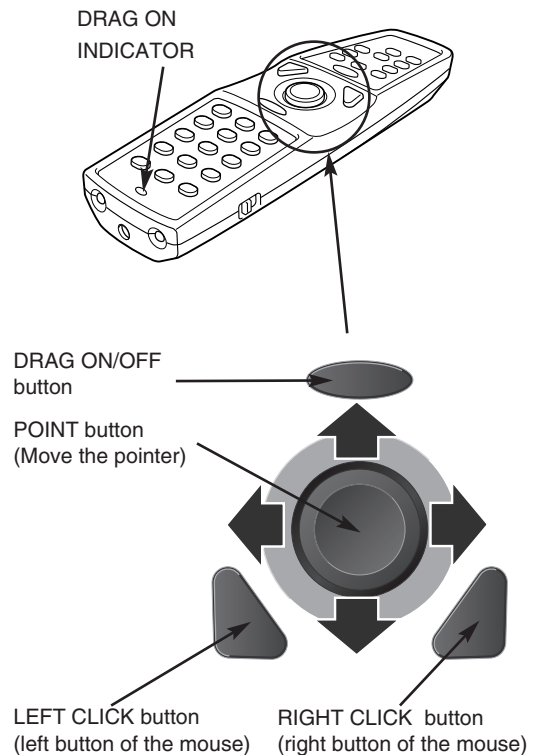

MAINTENANCE

WARNING TEMP. INDICATOR

The WARNING TEMP. Indicator flashes red and the projector automatically turned off when the internal temperature exceeds normal temperature. Wait at least 5 minutes before turning on the projector again.

If the WARNING TEMP. Indicator continues to flash, check the items listed below.

- 1 Ventilation Slots of the projector may be blocked. In such an event, reposition the projector so that Ventilation Slots are not obstructed.
- 2 Air Filter may be clogged with dust particles. Clean Air Filter by following the section AIR FILTER CARE AND CLEANING below.
- 3 If WARNING TEMP. Indicator remains on after performing the above checks, Cooling Fans or the Internal Circuits may be malfunctioning. Contact service personnel from an authorized dealer or a service station.

AIR FILTER CARE AND CLEANING

The Removable Air Filters prevent dust from accumulating on the surface of optical components inside the projector. Should the Air Filters become clogged with dust particles, it will reduce the effectiveness of the Cooling Fans and may result in excessive internal heat build up and adversely affect the life of the projector. Clean Air Filters by following the steps below:

- 1 Turn off the projector and disconnect AC power cord from the AC outlet.
- 2 Turn the projector upside down and remove four Air Filters by pulling the latches upward.
- 3 Clean Air Filters with a brush or wash out dust and particles.
- 4 Replace four Air Filters properly. Make sure that Air Filters are fully inserted.

AIR FILTER
Pull up and remove.

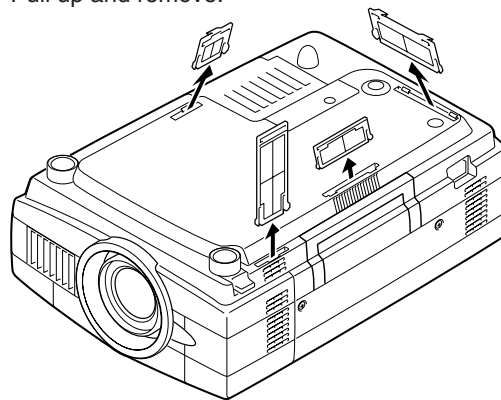

CAUTION

Do not operate the projector with Air Filter removed. Dust may accumulate on LCD Panel and Projection Mirror degrading picture quality.

Do not put small parts into Air Intake Vents. It may result in malfunction of the projector.

RECOMMENDATION

We recommend avoiding dusty/smoky environments when operating the projector. Usage in these environments may cause poor image quality and greatly reduce the life of the lamp and the projector itself.

When using in dusty or smoky conditions, dust may accumulate on the lens, liquid crystal panels, or optical elements inside the projector. This condition may degrade the quality of a projected image.

If any of these symptoms are noticed, contact a Boxlight Corporation at 1-800-762-5757 or 360-779-7901 for cleaning.

CLEANING PROJECTION LENS

Follow these steps to clean Projection Lens:

- 1 Apply a non-abrasive camera lens cleaner to a soft, dry cleaning cloth. Avoid using an excessive amount of cleaner. Abrasive cleaners, solvents or other harsh chemicals might scratch the lens.
- 2 Lightly wipe the cleaning cloth over the Projection Lens.
- 3 When the projector is not in use, replace Lens Cover.

TROUBLESHOOTING

Before calling your dealer or service center for assistance, check the following:

1. Make sure the projector is connected to your computer or video equipment as described in the section "CONNECTING PROJECTOR" on pages 11 ~ 13.
2. Check cable connections. Verify that all computer, video and power cords are properly connected.
3. Verify that all power is switched on.
4. If the projector still does not produce an image, re-start your computer.
5. If an image still does not appear, unplug the projector from your computer and check your computer monitor display. The problem may be with your graphics controller rather than with the projector. (When you reconnect the projector, be sure to turn the computer and monitor off before you power up the projector. Power the equipment back on in this order: Projector then computer.)
6. If the problem still exists, check the following chart.

Problem:	Try these Solutions
No power.	<ul style="list-style-type: none"> ● Plug the projector into your AC outlet. ● Make sure READY Indicator lights. ● Wait 90 seconds after the projector is turned OFF before turning the projector back on. <p>NOTE : After pressing Power ON-OFF button to OFF, make sure a projector works as follows:</p> <ol style="list-style-type: none"> 1. LAMP indicator lights bright and READY indicator turns off. 2. After 90 seconds, READY indicator lights green again and a projector may be turned on by pressing Power ON-OFF button. <ul style="list-style-type: none"> ● Check WARNING TEMP. and READY indicator. If both WARNING TEMP. and READY indicator are flashing, the projector cannot be turned on. (See "TURNING ON/OFF PROJECTOR" section on page 19.) ● Check Projection Lamp. (Refer to page 38.)
Image is out of focus.	<ul style="list-style-type: none"> ● Adjust the focus. ● Make sure the projection screen is at least 4.1' (1.2m) from the projector. ● Check Projection Lens to see if it needs cleaning. <p>NOTE : Moving a projector from a cool temperature location to a warm temperature location may result in moisture condensation on Projection Lens. In such an event, leave the projector OFF and wait until condensation disappears.</p>
Picture is Left/Right reversed.	<ul style="list-style-type: none"> ● Check Ceiling / Rear feature. (See "SETTING" section on page 36.)
Picture is Top/Bottom reversed.	<ul style="list-style-type: none"> ● Check Ceiling feature. (See "SETTING" section on page 36.)
Some displays are not seen during the Operation.	<ul style="list-style-type: none"> ● Check Display feature.(See "SETTING" section on page 36.)
No image.	<ul style="list-style-type: none"> ● Check the connection between your computer or video equipment and the projector. ● When turning the projector on, it takes about 30 seconds to display an image. ● Check that the selected system corresponds with your computer or video equipment. ● Make sure the temperature is not out of the Operating Temperature (5°C ~ 35°C).
No sound.	<ul style="list-style-type: none"> ● Check audio cable connection from audio input source. ● Adjust the audio source. ● Press VOLUME (+) button. ● Press MUTE button.

Problem:	Try these Solution
Remote Control does not work.	<ul style="list-style-type: none"> ● Check the batteries. ● Check ALL-OFF switch on Remote Control is set to "ON." ● Make sure nothing is between Infrared Remote Receiver and Remote Control. ● Make sure you are not too far from a projector when using Remote Control. Maximum operating range is 16.4' (5m). ● Make sure the code of Remote Control is set to conform to projector. (See "SETTING" section on page 36, 37.)
Wireless Mouse function does not work.	<ul style="list-style-type: none"> ● Check cable connection between the projector and your computer. ● Check the mouse setting on your computer. ● Turn the projector on before turning on the computer.

SERVICE

WARNING: High voltages are used to operate this projector. Do not attempt to open the cabinet.

Boxlight Service is easily obtained. If after following instructions above, you find that service is necessary, contact Boxlight for assistance at 1-800-762-5757 or 360-779-7901.

Give the model number and explain the difficulty. We will advise you how to obtain service.

Please have the following information available:

- Serial Number of Projector.
- Resolution of Computer.
- Refresh rate of Computer.



This symbol on the nameplate means the product is Listed by Underwriters Laboratories Inc. It is designed and manufactured to meet rigid U.L. safety standards against risk of fire, casualty and electrical hazards.



The CE Mark is a Directive conformity mark of the European Community (EC).

TECHNICAL SPECIFICATIONS

Projector Type	Multi-media Projector
Dimensions (W x H x D)	11.9" x 6.4" x 16.6" (302mm x 162mm x 422mm)
Net Weight	17.2 lbs (7.8 kg)
LCD Panel System	0.99" TFT Active Matrix type, 3 panels
Panel Resolution	1024 x 768 dots
Number of Pixels	2,359,296 (1024 x 768 x 3 panels)
Color System	PAL, SECAM, NTSC, NTSC4.43, PAL-M and PAL-N
High Definition TV Signal	480i, 480p, 575i, 575p, 720p, 1035i, and 1080i
Scanning Frequency	H-sync. 15 ~ 100 KHz, V-sync. 50 ~ 100 Hz
Projection Image size (Diagonal)	Adjustable from 30" to 300"
Horizontal Resolution	800 TV lines
Projection Lens	F 1.7 ~ 2.1 lens with f 34 mm ~ 44 mm with motor zoom and focus
Throw Distance	4.1' ~ 32.8' (1.2 m ~ 10.0 m)
Projection Lamp	250 W
Computer 1 Input Terminal	(VGA) HDB 15-pin Terminal x 1
Computer 2 Input Terminal	DVI-I Terminal (Digital/Analog)
Computer Audio Input Jacks	Mini Jack (stereo) x 2 (Computer 1 and Computer 2)
Video Input Jacks	RCA Type x 1 (Video), RCA Type x 3 (Y, Pb/Cb, Pr/Cr), Mini DIN 4 pin x 1 (S-Video) and RCA x 2 (Audio R and L)
Monitor Out Terminal	(VGA) HDB 15-pin Terminal x 1
Audio Output Jack	Mini Jack (stereo) x 1
Control Port Connector	Mini DIN 8 pin x 1
USB Connector	USB Series B receptacle x 1
Built-in Speakers	INT. SP. Stereo (R and L), 2 watt RMS (T.H.D. 10%)
Feet Adjustment	0° to 10°
Voltage and Power Consumption	AC 100 ~ 120 V (4.6 A Max. Ampere), 50 / 60 Hz (The U.S.A and Canada) AC 200 ~ 240 V (2.3 A Max. Ampere), 50 / 60 Hz (Continental Europe)
Operating Temperature	41 °F ~ 95 °F (5 °C ~ 35 °C)
Storage Temperature	14 °F ~ 140 °F (-10 °C ~ 60 °C)
Remote Control Unit	Power Source : AA, UM3 or R06 Type x 2 Operating Range : 16.4' (5m) / ±30° Dimensions : 2.0" x 1.4" x 7.6" (50mm x 36mm x 193mm) Net Weight : 0.35 lbs (160 g) (including batteries) Laser Pointer : Class II Laser (Max. Output : 1mW / Wave length : 650±20nm)
Accessories	User's Guide AC Power Cord Remote Control Unit and Batteries VGA Cable USB Cable Control Cable for Serial port DVI/VGA Adapter Protective Dust Cover Lens Cover

● The specifications are subject to change without notice.

● LCD panels are manufactured to the highest possible standards. Even though 99.99% of the pixels are effective, a tiny fraction of the pixels (0.01% or less) may be ineffective by the characteristics of the LCD panels.

CONFIGURATIONS OF TERMINALS

COMPUTER INPUT-1 and MONITOR OUT TERMINALS (ANALOG)

Terminal : HDB15-PIN

Pin Configuration

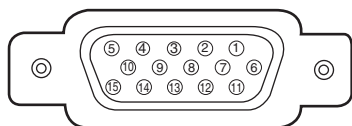

1	Red Input	9	+5V Power
2	Green Input	10	Ground (Vert.sync.)
3	Blue Input	11	Sense 0
4	Sense 2	12	DDC Data
5	Ground (Horiz.sync.)	13	Horiz. sync.
6	Ground (Red)	14	Vert. sync.
7	Ground (Green)	15	DDC Clock
8	Ground (Blue)		

COMPUTER INPUT-2 TERMINAL (DIGITAL/ANALOG)

Terminal : DVI-I 29-PIN

Pin Configuration

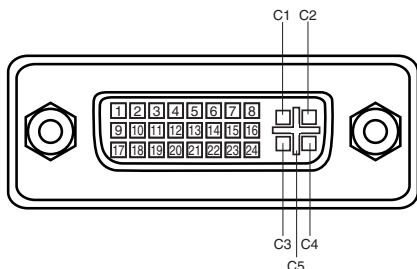

C1	Analog Red Input
C2	Analog Green Input
C3	Analog Blue Input
C4	Analog Horiz. sync
C5	Analog Ground (R/G/B)

1	T.M.D.S. Data2-	9	T.M.D.S. Data1-	17	T.M.D.S. Data0-
2	T.M.D.S. Data2+	10	T.M.D.S. Data1+	18	T.M.D.S. Data0+
3	T.M.D.S. Data2/4 Shield	11	T.M.D.S. Data1/3 Shield	19	T.M.D.S. Data0/5 Shield
4	+3.3V MCI	12	+5V MCI	20	Viewer RXD
5	W-LAN	13	Card In	21	Viewer TXD
6	DDC Clock	14	+5V Power	22	T.M.D.S. Clock Shield
7	DDC Data	15	Ground (for +5V)	23	T.M.D.S. Clock+
8	Analog Vert. sync	16	Hot Plug Detect	24	T.M.D.S. Clock-

CONTROL PORT CONNECTOR

Terminal : Mini DIN 8-PIN

Pin Configuration

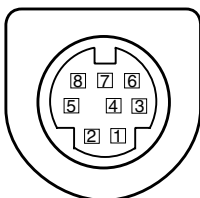

	PS/2	Serial	ADB
1	-----	R X D	-----
2	CLK	-----	ADB
3	DATA	-----	-----
4	GND	GND	GND
5	-----	RTS / CTS	-----
6	-----	T X D	-----
7	GND	GND	-----
8	-----	GND	GND

USB CONNECTOR (Series B)

Pin Configuration

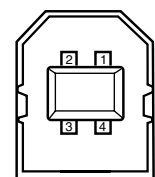

1	Vcc
2	- Data
3	+ Data
4	Ground

OPTIONAL PARTS

The parts listed below are optionally supplied. When ordering those parts, give the name and Type No. to the sales dealer.

- **Control Cable (PS2 Port)** **Type No. : POA-MCPS2**
- **Control Cable (ADB Port)** **Type No. : POA-MCMAC**
- **MAC Adapter** **Type No. : POA-MACAP**
- **HDB 15 pin-SCART 21 pin Cable** **Type No. : POA-CA-SCART**
- **Media Card Imager Kit** **Type No. : PCMCIA-MOD1**
- **Wireless Imager Kit** **Type No. :** Available models are different in each country. Contact the sales dealer for details.

When using Wireless Imager, set the following model name to PJ Controller.

Model Name : 10-2-1

INDICATORS AND PROJECTOR CONDITION

Check the Indicators for projector condition.

Indicators				Projector Condition
LAMP REPLACE yellow	WARNING TEMP. red	READY green	LAMP red	
●	●	●	●	The projector is OFF. (The AC Power Cord is unplugged.)
*	●	○	○	The projector is READY to be turned on with the POWER ON-OFF button.
*	●	○	◐	The projector is operating normally.
*	○ ⚡	●	○	The temperature inside the projector is abnormally high. The projector cannot be turned on. When the projector is cooled down enough and the temperature returns to normal, the READY indicator lights green and the projector can be turned on. (The WARNING TEMP. indicator keeps flashing.) Check and clean the Air Filter.
*	○ ⚡	○	○	The projector is cooled down enough and the temperature returns to normal. When turning on the projector, the WARNING TEMP. indicator stops flashing. Check and clean the Air Filter.
*	●	●	○	The projector is being cooled down. It cannot be turned on until the READY indicator lights green.
*	○ ⚡	○ ⚡	○	The projector has detected an abnormal condition and cannot be turned on. Unplug the AC Power Cord and plug it again to turn on the projector. If the projector is turned off again, disconnect the AC Power Cord and contact the dealer or the service center for service and checkup. Do not leave the projector on. It may cause electric shock or a fire hazard.
*	●	○ ⚡	◐	The projector is in the Power management mode.

○ ●●● on ○
⚡ ●●● flashing ◐ ●●● dim ● ●●● off

* When the life of the projection lamp draws to an end, the LAMP REPLACE indicator lights yellow. When this indicator lights yellow, replace the projection lamp with a new one promptly. Reset the Lamp Replace Counter after replacement of the lamp.

LIMITED WARRANTY

BOXLIGHT CORPORATION ("BOXLIGHT") warrants that each Boxlight MP-56t ("the Product") sold hereunder will conform to and function in accordance with the written specifications of BOXLIGHT. Said limited warranty shall apply only to the first person or entity that purchases the Product for personal or business use and not for the purpose of distribution or resale. Said warranty shall continue for a period of two (2) years from the date of such purchase. BOXLIGHT does not warrant that the Product will meet the specific requirements of the first person or entity that purchases the Product for personal or business use. Lamp is warranted for 120 days or 500 hours (whichever comes first). Accessories are warranted for 1 year from date of purchase.

BOXLIGHT CORPORATION's liability for the breach of the foregoing limited warranty is limited to the repair or replacement of the Product or refund of the purchase price of the Product, at BOXLIGHT's sole option. To exercise the Purchaser's rights under the foregoing warranty, the Product must be returned at the Purchaser's sole cost and expense, to BOXLIGHT or any authorized service center provided, however, that the Product must be accompanied by a written letter explaining the problem and which includes (i) proof of purchase; (ii) the dealer's name; and (iii) the model and serial number of the Product. **A return authorization number, issued by the BOXLIGHT customer service department, must also be clearly displayed on the outside of the shipping carton containing the Product.**

WARRANTY LIMITATION AND EXCLUSION

BOXLIGHT CORPORATION shall have no further obligation under the foregoing limited warranty if the Product has been damaged due to abuse, misuse, neglect, accident, unusual physical or electrical stress (unusual physical and electrical stress includes unusually long operation, exposure to smoke and other airborne contaminants), unauthorized modification, tampering, alterations, or service other than by BOXLIGHT or its authorized agents, causes other than from ordinary use or failure to properly use the Product in the application for which said Product is intended.

DISCLAIMER OR UNSTATED WARRANTIES

The warranty printed above is the only warranty applicable to this purchase.

All other warranties express or implied, including, but not limited to, the implied warranties of merchantability and fitness for a particular purpose are disclaimed. There are no warranties that extend beyond the face hereof and the foregoing warranty shall not be extended, altered or varied except by written instrument signed by BOXLIGHT CORPORATION.

LIMITATION OF LIABILITY

It is understood and agreed that BOXLIGHT's liability whether in contract, in tort, under any warranty, in negligence or otherwise shall not exceed the return of the amount of the purchase price paid by purchaser and under no circumstances shall BOXLIGHT be liable for special, indirect or consequential damages. The price stated for the Product is a consideration in limiting BOXLIGHT's liability. No action regardless of form, arising out of the agreement to purchase the product may be brought by purchaser more than one year after the cause of action has accrued.



Boxlight
19332 Powder Hill Place
Poulsbo, WA 98370-7407 USA
www.boxlight.com
U.S. and Canada 800-762-5757
International 1-360-779-7901