

***myprojectorlamps.com***

**The most trusted, dependable name  
in projector lamp sales.**



<http://www.myprojectorlamps.com>



<http://www.myprojectorlamps.ca>



<http://www.myprojectorlamps.eu>

The following projector manual has not been modified or altered in any way.

# USER'S GUIDE

## BOXLIGHT MP-45t



## TO THE OWNER

Before operating this projector, read this manual thoroughly and operate the projector properly.

This projector provides many convenient features and functions. Operating the projector properly enables you to manage those features and maintains it in better condition for a considerable time.

Improper operation may result in not only shortening the product-life, but also malfunctions, fire hazard, or other accidents.

If your projector seems to operate improperly, read this manual again, check operations and cable connections and try the solutions in the "TROUBLESHOOTING" section at the end of this booklet. If the problem still persists, contact BOXLIGHT.



### SAFETY PRECAUTIONS

**WARNING : TO REDUCE THE RISK OF FIRE OR ELECTRIC SHOCK, DO NOT EXPOSE THIS APPLIANCE TO RAIN OR MOISTURE.**

- This projector produces intense light from the projection lens. Do not stare directly into the lens as it could damage your eyes. Be especially careful that children do not stare directly into the beam.
- Do not use projectors with whiteboards that produce a very bright glare or 'hot spot'. This is most common on shiny surfaces.
- This projector should be used as described in this manual. If not, it may result in a fire hazard.
- Provide appropriate space on the top, sides and rear of the projector cabinet for allowing air circulation and cooling the projector. If the projector is to be built into a compartment or similarly enclosed, the minimum distances must be maintained. Do not cover the ventilation openings on the projector. Heat build-up can reduce the service life of your projector, and can also be dangerous.
- Do not put any flammable objects such as spray cans near the projector, hot air is exhausted from the ventilation openings.
- The Remote Control, supplied with this projector, emits a laser beam from the Laser Light Window while pressing the LASER button (the LASER POINTER INDICATOR lights red to indicate laser emission). Do not look into the Laser Light Window or shine the laser beam on yourself or other people. Eye damage may result.
- If the projector is not to be used for an extended time, unplug the projector from the power outlet.

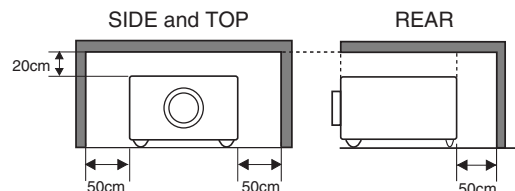

**READ AND KEEP THIS USER'S GUIDE FOR LATER USE.**



**CAUTION**  
**RISK OF ELECTRIC SHOCK**  
**DO NOT OPEN**



**CAUTION : TO REDUCE THE RISK OF ELECTRIC SHOCK, DO NOT REMOVE COVER (OR BACK). NO USER-SERVICEABLE PARTS INSIDE EXCEPT LAMP REPLACEMENT. REFER SERVICING TO QUALIFIED SERVICE PERSONNEL.**



THIS SYMBOL INDICATES THAT DANGEROUS VOLTAGE CONSTITUTING A RISK OF ELECTRIC SHOCK IS PRESENT WITHIN THIS UNIT.



THIS SYMBOL INDICATES THAT THERE ARE IMPORTANT OPERATING AND MAINTENANCE INSTRUCTIONS IN THE USER'S GUIDE WITH THIS UNIT.

# SAFETY INSTRUCTIONS

All the safety and operating instructions should be read before the product is operated.

Read all of the instructions given here and retain them for later use. Unplug this projector from AC power supply before cleaning. Do not use liquid or aerosol cleaners. Use a damp cloth for cleaning.

Follow all warnings and instructions marked on the projector.

For added protection to the projector during a lightning storm, or when it is left unattended and unused for long periods of time, unplug it from the wall outlet. This will prevent damage due to lightning and power line surges.

---

Do not expose this unit to rain or use near water... for example, in a wet basement, near a swimming pool, etc...

Do not use attachments not recommended by the manufacturer as they may cause hazards.

Do not place this projector on an unstable cart, stand, or table. The projector may fall, causing serious injury to a child or adult, and serious damage to the projector. Use only with a cart or stand recommended by the manufacturer, or sold with the projector. Wall or shelf mounting should follow the manufacturer's instructions, and should use a mounting kit approved by the manufacturer.

An appliance and cart combination should be moved with care. Quick stops, excessive force, and uneven surfaces may cause the appliance and cart combination to overturn.



---

Slots and openings in the back and bottom of the cabinet are provided for ventilation, to insure reliable operation of the equipment and to protect it from overheating.

The openings should never be covered with cloth or other materials, and the bottom opening should not be blocked by placing the projector on a bed, sofa, rug, or other similar surface. This projector should never be placed near or over a radiator or heat register.

This projector should not be placed in a built-in installation such as a book case unless proper ventilation is provided.

Never push objects of any kind into this projector through cabinet slots as they may touch dangerous voltage points or short out parts that could result in a fire or electric shock. Never spill liquid of any kind on the projector.

This projector should be operated only from the type of power source indicated on the marking label. If you are not sure of the type of power supplied, consult your authorized dealer or local power company.

Do not overload wall outlets and extension cords as this can result in fire or electric shock. Do not allow anything to rest on the power cord. Do not locate this projector where the cord may be damaged by persons walking on it.

Do not attempt to service this projector yourself as opening or removing covers may expose you to dangerous voltage or other hazards. Refer all servicing to qualified service personnel.

Unplug this projector from wall outlet and refer servicing to qualified service personnel under the following conditions:

- a. When the power cord or plug is damaged or frayed.
- b. If liquid has been spilled into the projector.
- c. If the projector has been exposed to rain or water.
- d. If the projector does not operate normally according to the operating instructions. Adjust only those controls that are covered by the operating instructions as improper adjustment of other controls may result in damage and will often require extensive work by a qualified technician to restore the projector to normal operation.
- e. If the projector has been dropped or the cabinet has been damaged.
- f. When the projector exhibits a distinct change in performance-this indicates a need for service.

When replacement parts are required, be sure the service technician uses replacement parts specified by the manufacturer that have the same characteristics as the original part. Unauthorized substitutions may result in fire, electric shock, or injury to persons.

Upon completion of any service or repairs to this projector, ask the service technician to perform routine safety checks to determine that the projector is in safe operating condition.

---

## Voor de klanten in Nederland



Bij dit product zijn batterijen geleverd. Wanneer deze leeg zijn, moet u ze niet weggooien maar inleveren als KCA.

# COMPLIANCES

## Federal Communication Commission Notice

Note : This equipment has been tested and found to comply with the limits for a Class B digital device, pursuant to part 15 of the FCC Rules. These limits are designed to provide reasonable protection against harmful interference in a residential installation. This equipment generates, uses and can radiate radio frequency energy and, if not installed and used in accordance with the instructions, may cause harmful interference to radio communications. However, there is no guarantee that interference will not occur in a particular installation. If this equipment does cause harmful interference to radio or television reception, which can be determined by turning the equipment off and on, the user is encouraged to try to correct the interference by one or more of the following measures :

- Reorient or relocate the receiving antenna.
- Increase the separation between the equipment and receiver.
- Connect the equipment into an outlet on a circuit different from that to which the receiver is connected.
- Consult the dealer or an experienced radio/TV technician for help.

Use of shielded cable is required to comply with class B limits in Subpart B of Part 15 of FCC Rules.

Do not make any changes or modifications to the equipment unless otherwise specified in the instructions. If such changes or modifications should be made, you could be required to stop operation of the equipment.

Model Number : BOXLIGHT MP-45t  
Trade Name : Boxlight  
Responsible party : BOXLIGHT  
Address : 19332 Powder Hill Place Poulsbo, WA 98370-7407 USA  
Telephone No. : (800)762-5757 or +1-360-779-7901

## AC POWER CORD REQUIREMENT

The AC Power Cord supplied with this projector meets the requirements for use in the country you purchased it.

### AC Power Cord for the United States and Canada :

The AC Power Cord used in the United States and Canada is listed by the Underwriters Laboratories (UL) and certified by the Canadian Standard Association (CSA).

The AC Power Cord has a grounding-type AC line plug. This is a safety feature to be sure that the plug will fit into the power outlet. Do not defeat this safety feature. Should you be unable to insert the plug into the outlet, contact your electrician.

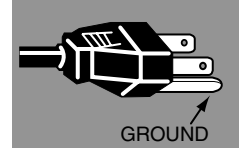

**THE SOCKET-OUTLET SHOULD BE INSTALLED NEAR THE EQUIPMENT AND EASILY ACCESSIBLE.**

# TABLE OF CONTENTS

<b>FEATURES AND DESIGN</b>	<b>6</b>	<b>COMPUTER INPUT</b>	<b>23</b>
<b>PREPARATION</b>	<b>7</b>	SELECTING INPUT SOURCE	23
NAME OF EACH PART OF PROJECTOR	7	SELECTING COMPUTER SYSTEM	23
SETTING-UP PROJECTOR	8	PC ADJUSTMENT	25
CONNECTING AC POWER CORD	8	AUTO PC ADJUSTMENT	25
POSITIONING PROJECTOR	9	MANUAL PC ADJUSTMENT	26
ADJUSTABLE FEET	10	PICTURE IMAGE SELECT	28
PROPER PROJECTOR INSTALLATION	10	IMAGE LEVEL SELECT	28
MOVING PROJECTOR	11	PICTURE SCREEN ADJUSTMENT	29
<b>CONNECTING PROJECTOR</b>	<b>12</b>	<b>VIDEO INPUT</b>	<b>30</b>
TERMINALS OF PROJECTOR	12	SELECTING INPUT SOURCE	30
CONNECTING TO COMPUTER	13	SELECTING VIDEO SYSTEM	31
CONNECTING TO VIDEO EQUIPMENT	14	PICTURE IMAGE SELECT	32
<b>BEFORE OPERATION</b>	<b>15</b>	IMAGE LEVEL SELECT	32
OPERATION OF REMOTE CONTROL	15	PICTURE SCREEN ADJUSTMENT	33
LASER POINTER FUNCTION	15	<b>PICTURE IMAGE</b>	<b>34</b>
REMOTE CONTROL BATTERIES INSTALLATION	16	PICTURE IMAGE ADJUSTMENTS	34
TOP CONTROLS AND INDICATORS	17	<b>SETTING</b>	<b>37</b>
OPERATING ON-SCREEN MENU	18	SETTING MENU	37
HOW TO OPERATE ON-SCREEN MENU	18	<b>APPENDIX</b>	<b>41</b>
FLOW OF ON-SCREEN MENU OPERATION	18	OPERATING WIRELESS MOUSE	41
MENU BAR	19	MAINTENANCE	42
<b>BASIC OPERATION</b>	<b>20</b>	WARNING TEMP. INDICATOR	42
TURNING ON / OFF PROJECTOR	20	AIR FILTER CARE AND CLEANING	43
ADJUSTING SCREEN	21	CLEANING PROJECTION LENS	43
ZOOM ADJUSTMENT	21	LAMP REPLACEMENT	44
FOCUS ADJUSTMENT	21	LAMP REPLACE COUNTER	45
LENS SHIFT ADJUSTMENT	21	<b>TROUBLESHOOTING</b>	<b>46</b>
KEystone ADJUSTMENT	21	INDICATORS AND PROJECTOR CONDITION	48
PICTURE FREEZE FUNCTION	22	COMPATIBLE COMPUTER SPECIFICATION	49
NO SHOW FUNCTION	22	MENU TREE	50
P-TIMER FUNCTION	22	<b>TECHNICAL SPECIFICATIONS</b>	<b>52</b>
SOUND ADJUSTMENT	22	CONFIGURATIONS OF TERMINALS	53
		OPTIONAL PARTS	54
		LENS REPLACEMENT	54

## TRADEMARKS

- Apple, Macintosh, and PowerBook are trademarks or registered trademarks of Apple Computer, Inc.
- IBM and PS/2 are trademarks or registered trademarks of International Business Machines, Inc.
- Windows and PowerPoint are registered trademarks of Microsoft Corporation.
- Each name of corporations or products in the user's guide is a trademark or a registered trademark of its respective corporation.

# FEATURES AND DESIGN

This Multimedia Projector is designed with advanced technology for portability, durability, and ease of use. This projector utilizes built-in multimedia features, a palette of 16.77 million colors, and matrix liquid crystal display (LCD) technology.

## ◆ Compact Design

---

This projector is extremely compact in size and weight. It is designed to be portable and work anywhere you need it.

## ◆ Compatibility

---

This projector accepts various video and computer input signals including;

- **Computers**  
IBM-compatible or Macintosh computer up to 1280 x 1024 resolution.
- **6 Color Systems**  
NTSC, PAL, SECAM, NTSC 4.43, PAL-M or PAL-N color system can be displayed.
- **Component Video**  
Component video signals, such as a DVD player output, including high definition TV signals (480i, 480p, 575i, 575p, 720p, 1035i or 1080i) can be displayed.
- **S-Video**  
S-Video signals, such as an S-VHS VCR output signal, can be displayed.

## ◆ High Resolution Image

---

This projector provides 1024 x 768 dots resolution for computer input and 800 horizontal TV lines. Resolution from a computer between XGA (1024 x 768) and SXGA (1280 x 1024) is compressed into 1024 x 768 dots. This projector cannot display image of over 1280 x 1024 dots. When the resolution of your computer is more than 1280 x 1024, lower the resolution.

## ◆ Multi-Scan System

---

This projector has a Multi-Scan System to conform to almost all computer output signals quickly. There is no need for troublesome manual adjustment of frequency and other settings.

## ◆ One-Touch Auto PC Adjustment

---

Incoming computer video signals are recognized and automatically adjusted for by the Auto PC Adjustment feature. No complicated setup is necessary and projection is always precise.

## ◆ Motor-driven Lens Shift

---

The Projection lens can be moved up and down with the motor-driven lens shift function. This function makes it easy to place the image where you want it. Zoom and focus are also motor-driven functions.

## ◆ Digital Zoom (for Computer)

---

The Digital Zoom function adjusts image size to approx. 1/4 ~ 49 times original size, allowing you to focus on crucial information in your presentation.

## ◆ Keystone Correction

---

Certain projector positions can cause the image to be distorted into a trapezoid shape. Keystone Correction solves this problem by digitally altering the image to make it square.

## ◆ Power Management

---

The Power Management function is provided to reduce power consumption while the projector is not in use. The Power Management function turns the Projection Lamp off when the projector has no signal input and no buttons are pressed. The Projection Lamp is automatically turned on again when the projector detects a signal or any operation button is pressed. This projector is shipped with this function ON.

## ◆ Digital Visual Interface

---

The projector is equipped with DVI 24-pin terminal for connecting DVI output from a computer or other DVI source.

## ◆ Laser Pointer Function

---

The Remote Control supplied with the projector includes a Laser Pointer.

## ◆ Wireless Mouse

---

The Remote Control supplied with this projector has Wireless Mouse function for a connected computer. This function enables you to operate both projector and computer with the Remote Control.

## ◆ Multilanguage Menu Display

---

Operation menu is displayed in; English, German, French, Italian, Spanish, Portuguese, Dutch, Swedish, Russian, Chinese, Korean or Japanese.

# PREPARATION

## NAME OF EACH PART OF PROJECTOR

### FRONT OF CABINET

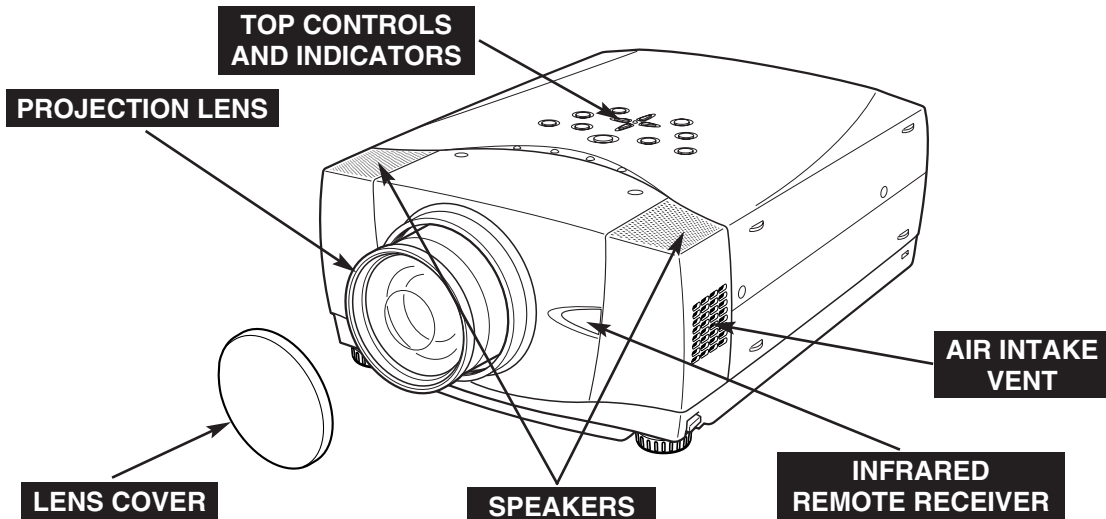

### BACK OF CABINET

#### EXHAUST VENT



**HOT AIR EXHAUSTED !**

Air blown from exhaust vent is hot. When using or installing a projector, following precautions should be taken.

- Do not put flammable objects near this vent.
- Do not place anything within 3.3'(1 m) of this vent, especially heat-sensitive objects.
- Do not touch this area, especially screws and metallic parts. This area will become hot while the projector is used.

The projector monitors internal temperature and automatically adjusts cooling fan speed.

#### POWER CORD CONNECTOR

#### TERMINALS AND CONNECTORS

#### INFRARED REMOTE RECEIVER

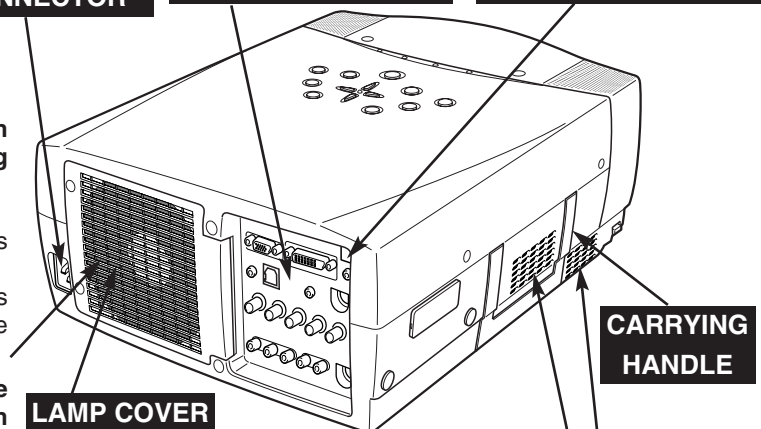

### BOTTOM OF CABINET

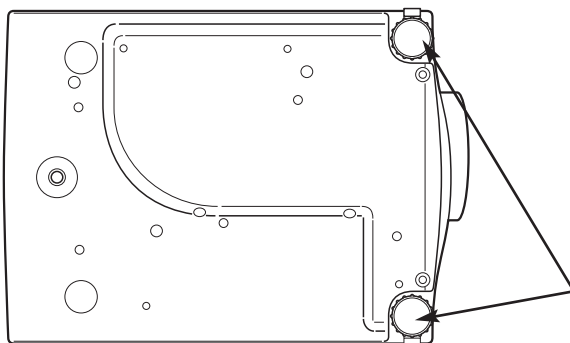

#### AIR INTAKE VENTS

The projector is equipped with cooling fans to prevent overheating. Pay attention to the following precautions to ensure proper ventilation and avoid possible risk of fire and malfunction.

- Do not cover vent slots.
- Keep side clear of any objects. Obstructions may block cooling air.

#### ADJUSTABLE FEET AND FEET LOCK LATCHES



# SETTING-UP PROJECTOR

## CONNECTING AC POWER CORD

This projector uses nominal input voltages of 100-120 V or 200-240 V AC. This projector automatically selects correct input voltage. It is designed to work with single-phase power systems having a grounded neutral conductor. To reduce risk of electrical shock, do not plug into any other type of power system. Consult your authorized dealer or service station if you are not sure of type of power supply being in use. Connect a projector with a peripheral equipment before turning a projector on. (Refer to pages 12 ~ 14 for connection.)

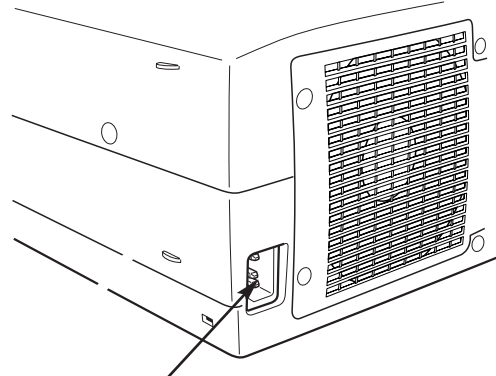

Connect AC Power Cord (supplied) to projector. AC outlet must be near this equipment and must be easily accessible.



### CAUTION

For safety, unplug AC Power Cord when the appliance is not in use. When the projector is turned off, but still connected to input power, the projector is in Stand-by Mode and still consumes a small amount of electricity.

### NOTE ON POWER CORD

The AC Power Cord must meet the requirements of the country where you use a projector. Confirm the AC plug type with the chart below and use the proper AC power cord. If supplied AC Power Cord does not match AC outlet, contact your sales dealer.

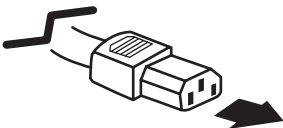
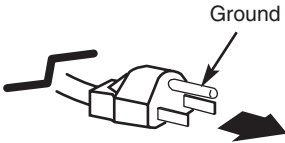
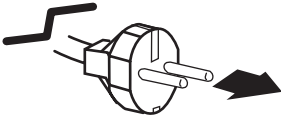
Projector side	AC Outlet side	
 <p data-bbox="345 1377 535 1451">To POWER CORD CONNECTOR on a projector.</p>	<p data-bbox="686 1173 946 1201">For U.S.A. and Canada</p>  <p data-bbox="729 1383 862 1436">To AC Outlet. (120 V AC)</p>	<p data-bbox="1060 1180 1357 1207">For Continental Europe</p>  <p data-bbox="1053 1409 1235 1461">To AC Outlet. (200 - 240 V AC)</p>

**POSITIONING PROJECTOR**

- This projector is designed to project on a flat projection surface.
- Projector can be focused from 4.6' (1.4m) ~ 48.3' (14.7m).
- Refer to figure below to determine screen size.

**ROOM LIGHT**  
 Brightness in room has a great influence on picture quality. It is recommended to limit ambient lighting in order to provide best image.

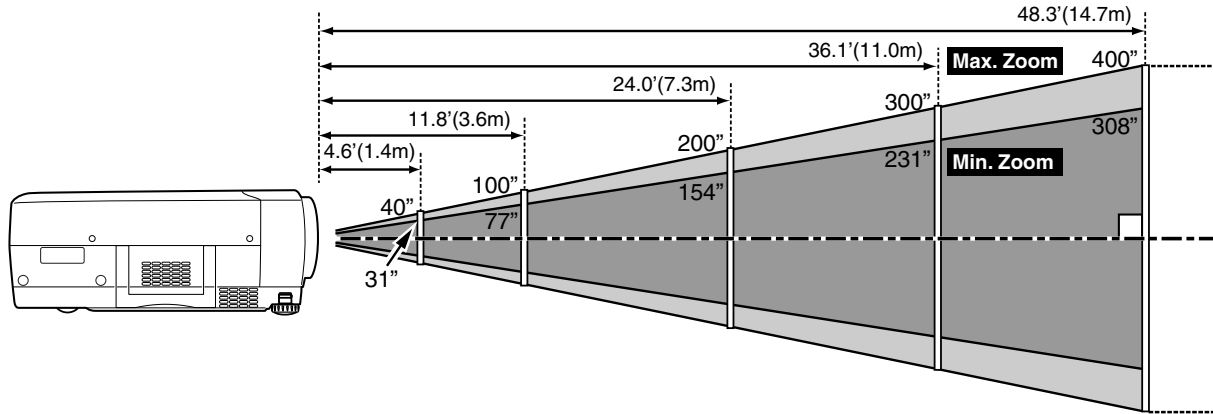

Screen Size (Diag.)	Max. Zoom	40"	100"	150"	200"	250"	300"	400"
	Min. Zoom	31"	77"	115"	154"	192"	231"	308"
Distance		4.6' (1.4m)	11.8' (3.6m)	17.7' (5.4m)	24.0' (7.3m)	30.2' (9.2m)	36.1' (11.0m)	48.3' (14.7m)

**LENS SHIFT ADJUSTMENT**

The Projection lens can be moved up and down using the motor-driven lens shift function. This function makes it easy to position the image where you want. U/D ratio can be adjusted 10 : 0 ~ 1 : 1 (refer to figure below). Refer to P21 for operation.

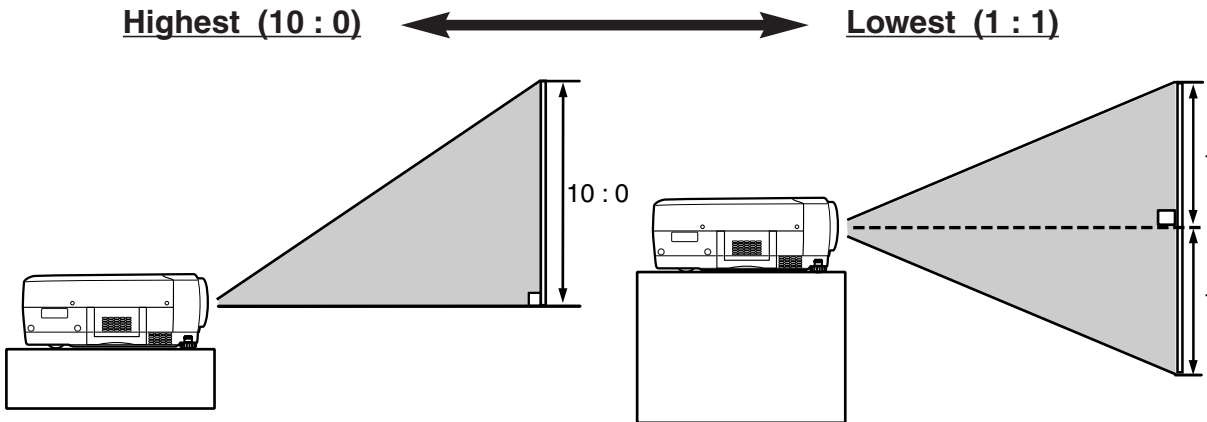

# PREPARATION

## ADJUSTABLE FEET

Picture tilt and projection angle can be adjusted using the ADJUSTABLE FEET. The projection angle can be adjusted up to 10.5 degrees.

- 1** Lift the front of the projector and pull the FEET LOCK LATCHES on both sides of the projector.
- 2** Release the FEET LOCK LATCHES to lock the ADJUSTABLE FEET. Rotate the ADJUSTABLE FEET to fine tune the position and or tilt.
- 3** To shorten the ADJUSTABLE FEET, lift the front of the projector and pull the FEET LOCK LATCHES.

Image position and keystone distortion can be adjusted using the projector menus. (Refer to P 21 and 37.)

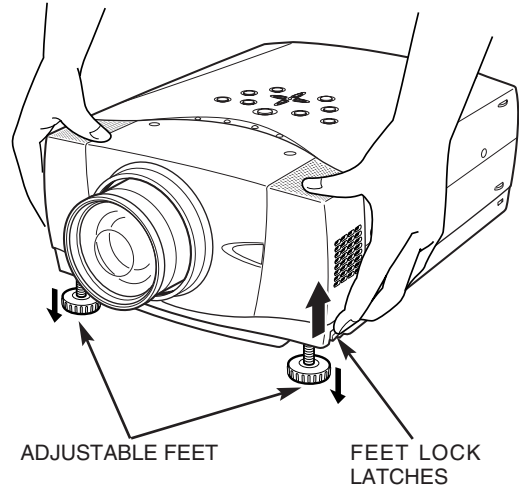

## PROPER PROJECTOR INSTALLATION

Install the projector properly. Improper installation may reduce the lamp lifetime and cause a fire hazard.

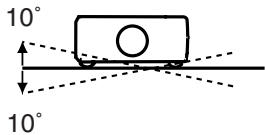

Do not tilt the projector more than 10 degrees.



**NO UPWARD**

Do not point the projector up.



**NO DOWNWARD**

Do not point the projector down.



**NO SIDEWAYS**

Do not put the projector on either side.

## MOVING PROJECTOR

Use the Carry Handle when moving the Projector.  
When moving the projector, replace the lens cover and retract the adjustable feet to prevent damage to the lens and projector case.  
When the projector is not in use for an extended period, put it in the case (dust cover) supplied with the projector.

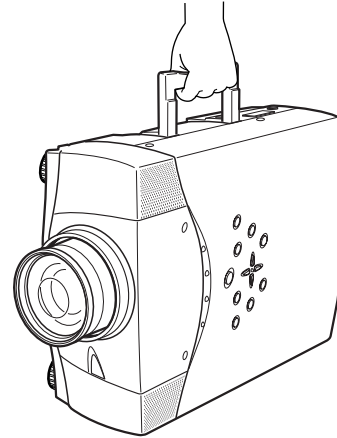

### CAUTION WHILE CARRYING OR TRANSPORTING THE PROJECTOR

- Do not drop or bump the projector, otherwise damage or malfunctions may result.
- When carrying the projector, use a suitable carrying case.
- Do not transport the projector by using a courier or transport service in an unsuitable transport case. This may cause damage to the projector. To transport the projector through a courier or transport service, consult your dealer for instructions.

# CONNECTING PROJECTOR

## TERMINALS OF PROJECTOR

This projector has input and output terminals on the rear panel for connecting computers and video equipment. Refer to the figures on pages 12 to 14 for connection details.

### COMPUTER AUDIO INPUT 1/AUDIO MONITOR OUTPUT JACK

This connection is switchable and can be used as an audio input for computer 1 or an audio output (variable). Configure this connection using the projector menu. (Refer to P13, P23 for more details.)

### COMPUTER INPUT/MONITOR OUTPUT TERMINAL (ANALOG)

This connection is switchable and can be used as computer input or monitor output. Configure this connection using the projector menu (Refer to P13, P23 for more details.)

Note: The monitor loop-through shows only the 5 wire computer input from the Input 2 BNC jacks.

### COMPUTER INPUT TERMINAL (DIGITAL)

Connect a Digital DVI-D output to this connection. (Refer to P13 for more details) Note: The MP-45t is HDCP compliant for HD DVI inputs.

### COMPUTER AUDIO INPUT 2 JACK

Connect the audio output (stereo) from the computer or DVI source to this jack. (Refer to P13 for more details.)

### R/C JACK

Use the supplied cable to connect the Remote Control directly to the projector. This will allow the Remote Control to operate over longer distances and through interference.

### USB CONNECTOR (Series B)

To control computer mouse functions with the projector Remote Control, connect the USB terminal of the computer to this connection. (Refer to P13 for more details.)

### CONTROL PORT CONNECTOR

To control computer mouse functions with the Remote Control connect the computer mouse port to this connection. (Refer to P13 for more details.)

### RESET BUTTON

This projector uses a microprocessor occasionally, the microprocessor may need to be reset. To reset the microprocessor, press the RESET button with a pen. The projector will shut down and restart. If this needs to be done too often, contact your dealer, the projector may need service.

### 5 BNC INPUT JACKS

Connect component video output (Y, Cb, Cr or Y, Pb, Pr) from video equipment to VIDEO/Y, Cb/Pb and Cr/Pr jacks or connect computer output {5 BNC Type (Green, Blue, Red, Horiz. Sync and Vert. Sync.)} from computer to G, B, R, H/V and V jacks. (Refer to P13 and 14.)

### VIDEO INPUT JACKS

Connect composite video output from video equipment to VIDEO/Y jack or connect component video outputs to VIDEO/Y, Cb/Pb and Cr/Pr jacks. (Refer to P14.)

### AUDIO INPUT JACKS

Connect an audio output from video equipment to these jacks. (Refer to P14.)

### S-VIDEO INPUT JACK

Connect S-VIDEO output from video equipment to this jack. (Refer to P14.)

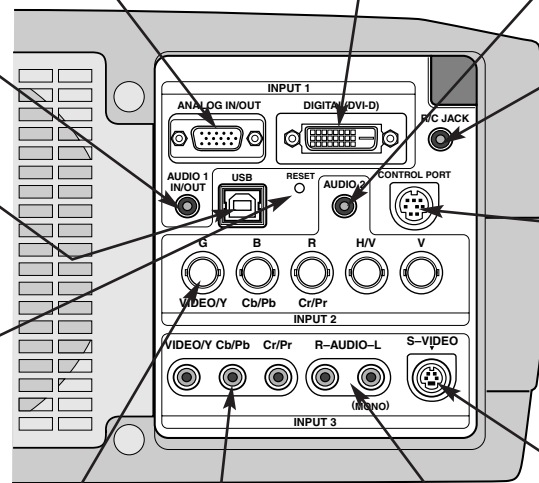

# CONNECTING TO COMPUTER

## Cables used for connection (\* = Cable or adapter is not supplied with this projector.)

- VGA Cable (HDB 15 pin)
- DVI-Digital Cable (for Single Link T.M.D.S.) \*
- BNC Cable \*
- Control Cable for Serial Port
- Control Cable for PS/2 Port \*
- USB Cable
- MAC Adapter (When connecting to Macintosh computer) \*
- Audio Cables (Mini Plug (stereo) x 2) \*

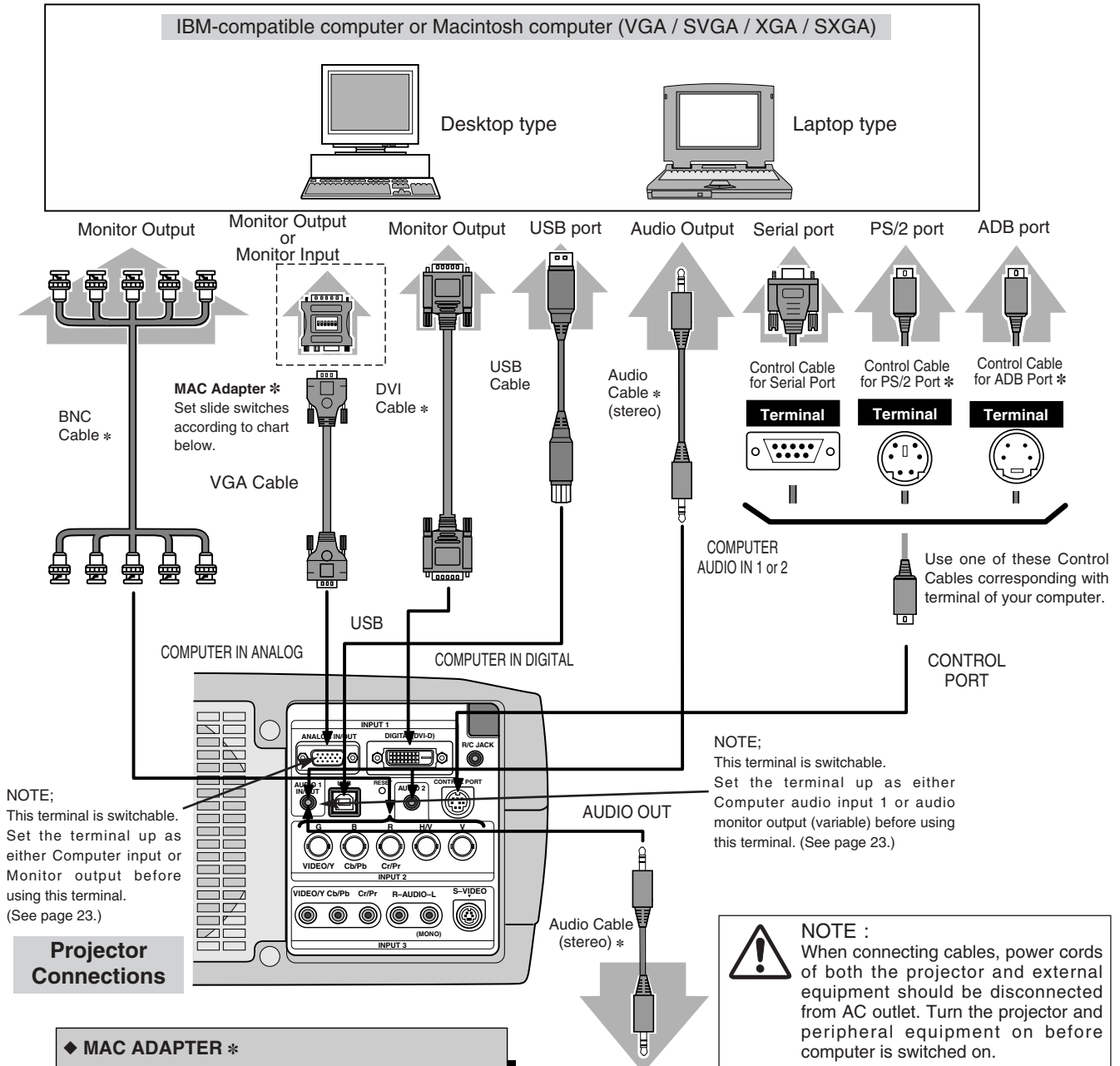

### Projector Connections

#### ◆ MAC ADAPTER \*

Set switches as shown in table below depending on RESOLUTION MODE that you want to use before you turn on projector and computer.

	1	2	3	4	5	6
13" MODE (640 x 480)	ON	ON	OFF	OFF	OFF	OFF
16" MODE (832 x 624)	OFF	ON	OFF	ON	OFF	OFF
19" MODE (1024 x 768)	OFF	ON	ON	OFF	OFF	OFF
21" MODE (1152 x 870)	ON	ON	ON	ON	OFF	OFF

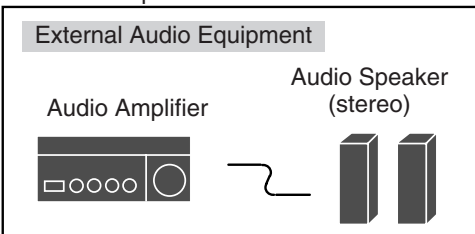

# CONNECTING TO VIDEO EQUIPMENT

**Cables used for connection** (\* = Cable is not supplied with this projector.)

- Video Cable (RCA x 1 or RCA x 3) \*
- BNC Cable \*
- S-VIDEO Cable \*
- Audio Cable (RCA x 2) \*
- Audio Cable {Mini Plug (stereo)} \*
- Scart Cable \*

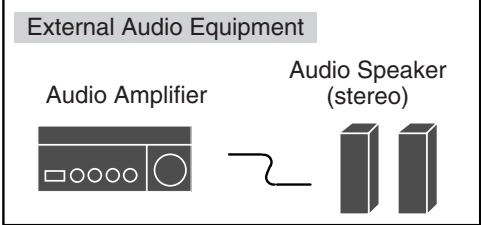
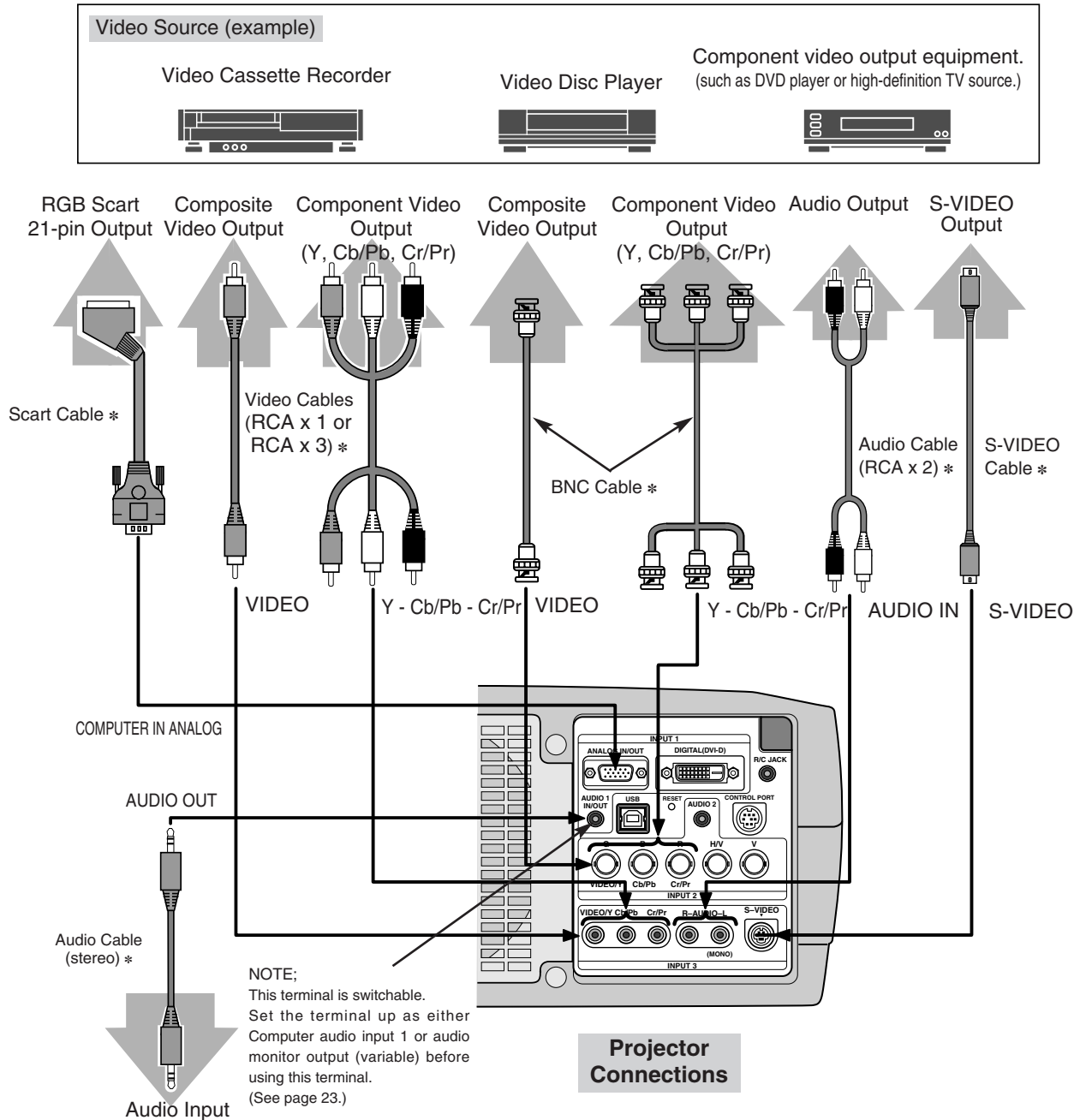

**NOTE :** When connecting cables, the power cords of the projector and external equipment should be disconnected from AC outlet.

# BEFORE OPERATION

## OPERATION OF REMOTE CONTROL

### Left Side

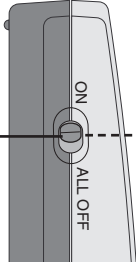

#### ALL-OFF SWITCH

When using Remote Control, turn this switch to "ON." And turn it to "ALL OFF" when it is not used.

#### INSIDE THE BATTERY COMPARTMENT

The remote control has DIP switches in the battery compartment to control the laser pointer and code features. Setting SW4 (LASER ON/OFF switch) to "OFF" disables the laser pointer on the remote. Set switches 1-3 as shown in the table below to select the remote control code. (Refer to P39.)

DIP SWITCH SETTING			
SW4 ..... LASER ON/OFF			
SW1	SW2	SW3	Code No.
ON	ON	ON	Code 1
ON	ON	OFF	Code 2
ON	OFF	ON	Code 3
ON	OFF	OFF	Code 4
OFF	ON	ON	Code 5
OFF	ON	OFF	Code 6
OFF	OFF	ON	Code 7
OFF	OFF	OFF	Code 8

#### LASER POINTER (Drag ON) INDICATOR

Lights red while laser beam is emitted from Laser Light Window. Lights green when drag feature is active. (P41)

#### MUTE BUTTON

Used to mute sound. (P22)

#### DRAG ON/OFF BUTTON

Used to set drag feature ON/OFF. (P41)

#### LEFT CLICK BUTTON

Used as a PC mouse in Wireless Mouse Operation. Press this button and the mouse pointer button to drag a selected screen object. (P41)

#### LASER BUTTON

Used to operate Laser Pointer Function. Laser beam is emitted while pressing this button within 1 minute. When using this Laser Pointer for more than 1 minute, release LASER button and press it again.

#### FOCUS BUTTON

Used to adjust focus. (P21)



#### POWER ON-OFF BUTTON

Used to turn projector on or off. (P20)

#### AUTO PC ADJ. BUTTON

Use to operate AUTO PC Adjustment function. (P25)

#### IMAGE BUTTON

Used to select image level. (P28, 32)

#### KEystone BUTTON

Used to correct keystone distortion. (P21, 37)

#### MOUSE POINTER

Used as a PC mouse in Wireless Mouse Operation. (P41)

#### RIGHT CLICK BUTTON

Used as a PC mouse in Wireless Mouse Operation. (P41)

#### LENS SHIFT BUTTON

Used to select LENS SHIFT function. (P21)

#### WIRED REMOTE JACK

When using as Wired Remote Control, connect Remote Control Cable to this jack. Battery installation is required when using as Wired Remote Control.

## LASER POINTER FUNCTION

This Remote Control emits a laser beam as a laser pointer function from the Laser Light Window. When LASER button is pressed, laser light goes on. And when LASER button is pressed for more than 1 minute or LASER button is released, light goes off. LASER POINTER INDICATOR lights RED and Laser is emitted with RED light to indicate laser beam is being emitted.

Laser emitted is a class II laser; therefore, do not look into Laser Light Window or shine laser beam on yourself or other people. Below are the caution labels for the laser beam.

**CAUTION :** Use of controls, adjustments or performance of procedures other than those specified herein may result in hazardous radiation exposure.

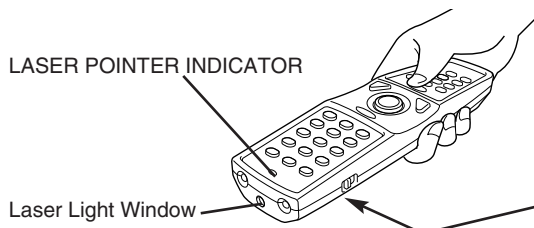

These caution labels are on the remote control.

<p><b>CAUTION</b></p> <p>LASER RADIATION- DO NOT STARE INTO BEAM</p> <p>MAX OUTPUT : 1mW WAVE LENGTH : 650±20nm CLASS II LASER PRODUCT</p> <p>This product is complied with 21 CFR part 1040.10</p>	<p>LASER RADIATION DO NOT STARE INTO BEAM CLASS 2 LASER PRODUCT LASER-STRAHLUNG NICHT IN DEN STRAHL BLICKEN LASER KLASSE 2 レーザー放射 クラス2 レーザ製品 ビームをのぞき込まないこと IEC60825-1, Am.1 1997 MAX OUTPUT (最大出力) : 1mW WAVE LENGTH (波長) : 650±20nm</p>
---	--



AVOID EXPOSURE-LASER RADIATION IS EMITTED FROM THIS APERTURE  
レーザー光の出口  
ビームをのぞき込まないこと



# BEFORE OPERATION

## D.ZOOM BUTTON

Used to select DIGITAL ZOOM +/- mode and resize image. (P29)

## SELECT BUTTON

Used to execute the selected item, or to expand or compress image in DIGITAL ZOOM +/- mode. (P29)

## MENU BUTTON

Used to select MENU operation. (P18, 19)

## P-TIMER BUTTON

Used to operate P-TIMER function. (P22)

## ZOOM BUTTON

Used to adjust zoom. (P21)

## COLOR MANAGEMENT BUTTON

Used to operate COLOR MANAGEMENT. (P34)



## NO SHOW BUTTON

Used to turn picture into black image. (P22)

## FREEZE BUTTON

Used to freeze picture. (P22)

## POINT (VOLUME +/-) BUTTONS

Used to select an item or adjust value in ON-SCREEN MENU. They are also used to pan image in DIGITAL ZOOM +/- mode. (P29) POINT LEFT/RIGHT buttons are also used as VOLUME +/- buttons. (P22)

## INPUT 1 BUTTON

Used to select input source (INPUT 1). (P23)

## INPUT 2 BUTTON

Used to select input source (INPUT 2). (P24, 30)

## INPUT 3 BUTTON

Used to select input source (INPUT 3). (P30)

## Operating Range

Point the Remote Control toward the projector Receiver Window when using the remote control. Maximum operating range for the Remote Control is about 16.4' (5m) and 60° in front and rear of the projector.

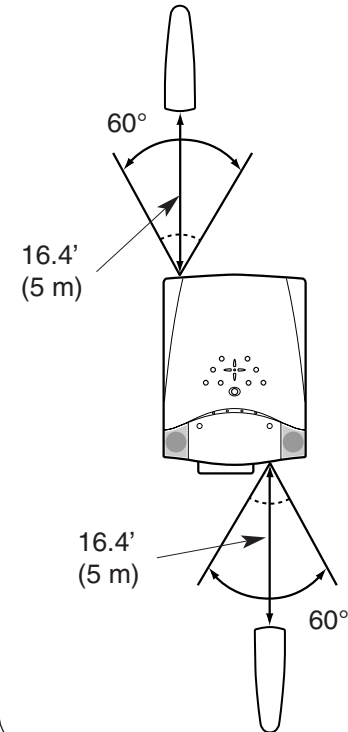

## Remote Control Batteries Installation

**1** Remove battery compartment lid.

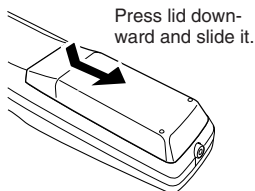

**2** Slide batteries into compartment.

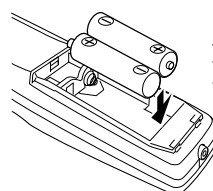

**Two AA size batteries**  
For correct polarity (+ and -), be sure battery terminals are in contact with pins in compartment.

**3** Replace compartment lid.

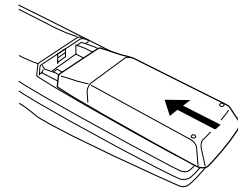

To ensure safe operation, please observe following precautions :

- Use (2) AA, UM3 or R06 type alkaline batteries.
- Replace both batteries at the same time.
- Do not mix new batteries with used batteries.
- Avoid contact with water or liquid.
- Do not expose the Remote Control to moisture, or heat.
- Do not drop the Remote Control.
- If a battery has leaked in the Remote Control, carefully wipe case clean and install new batteries.
- Danger of explosion if batteries are incorrectly installed.
- Dispose of used batteries according to the battery manufacturer's instructions and local rules.

# TOP CONTROLS AND INDICATORS

This projector has CONTROL BUTTONS (TOP CONTROLS) and INDICATORS on the top panel.

**LAMP REPLACE INDICATOR**

Turns to yellow when life of projection lamp draws to an end. (P44)

**WARNING TEMP. INDICATOR**

Flashes red when internal projector temperature is too high. (P42)

**READY INDICATOR**

Lights green when the projector is ready to be turned on. It flashes green in Power Management mode. (P39)

**LAMP INDICATOR**

Becomes dim when the lamp is lit, and bright when the projector is in stand-by mode.

**POWER ON-OFF BUTTON**

Used to turn the projector on or off. (P20)

**INPUT BUTTON**

Used to select input source. (P23, 24, 30)

**AUTO PC ADJ. BUTTON**

Used to operate AUTO PC Adjustment function. (P25)

**IMAGE BUTTON**

Used to select image level. (P28, 32)

**SELECT BUTTON**

Used to execute the selected item. It is also used to expand/compress image in DIGITAL ZOOM mode. (P29)

**POINT (VOLUME +/-) BUTTONS**

Used to select an item or adjust value in ON-SCREEN MENU. They are also used to pan image in DIGITAL ZOOM +/- mode. (P29) POINT LEFT/RIGHT buttons are also used as VOLUME +/- buttons.

**FOCUS BUTTON**

Used to adjust focus. (P21)

**ZOOM BUTTON**

Used to adjust zoom. (P21)

**MENU BUTTON**

Used to open or close MENU operation. (P18, 19)

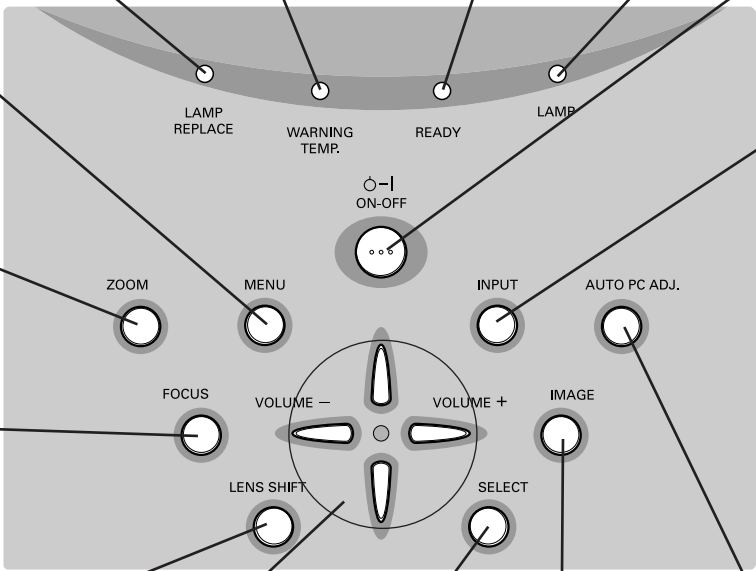

# OPERATING ON-SCREEN MENU

## HOW TO OPERATE ON-SCREEN MENU

You can control and adjust this projector through the ON-SCREEN MENU. Refer to the following pages to operate each adjustment on the ON-SCREEN MENU.

### 1 DISPLAY MENU

Press MENU button to display the ON-SCREEN MENU.

### 2 MOVING POINTER

Move pointer (\* see below) or adjust value of item by pressing POINT on Top Control or the Remote Control.

\* The Pointer is the icon on the ON-SCREEN MENU used to select an item. See figures in "FLOW OF ON-SCREEN MENU OPERATION" section below.

### 3 SELECT ITEM

Select an item or set the selected function by pressing SELECT.

#### REMOTE CONTROL

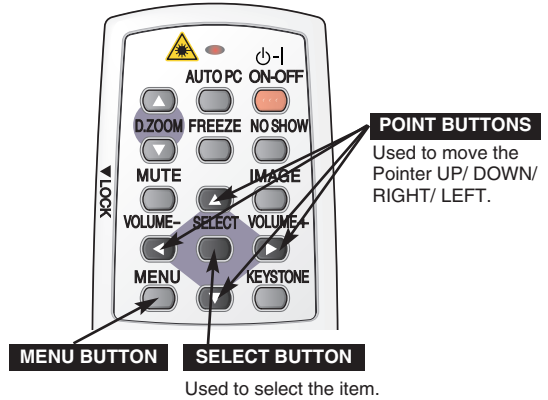

#### TOP CONTROL

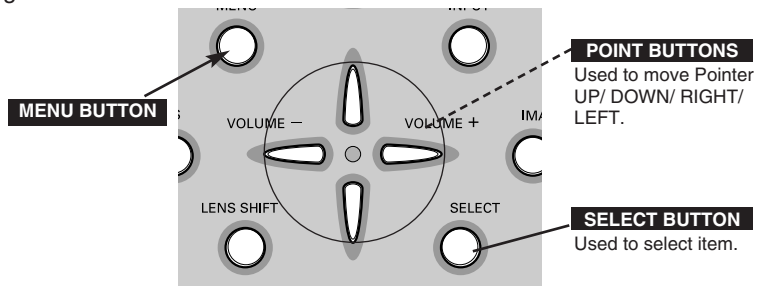

## FLOW OF ON-SCREEN MENU OPERATION

### Display ON-SCREEN MENU

1 Press MENU to display the ON-SCREEN MENU (MENU BAR). The red frame is the POINTER.

### Select Menu to be adjusted

2 Move the POINTER (red frame) to the MENU ICON that you want to select by pressing the POINT RIGHT / LEFT.

### Control or adjust item through ON-SCREEN MENU

3 Press POINT UP/DOWN and move the POINTER (red frame or red arrow) to the ITEM that you want to adjust, and then press SELECT to show ITEM DATA.

4 Adjust ITEM DATA by pressing POINT RIGHT / LEFT. Refer to the following pages for details of respective adjustments.

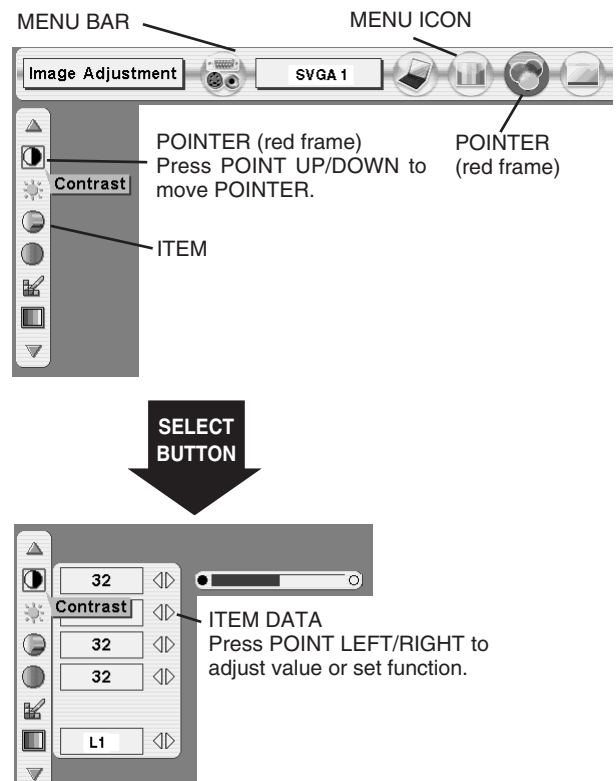

**MENU BAR**

**FOR PC SOURCE**

Press MENU while connected to a PC input source.

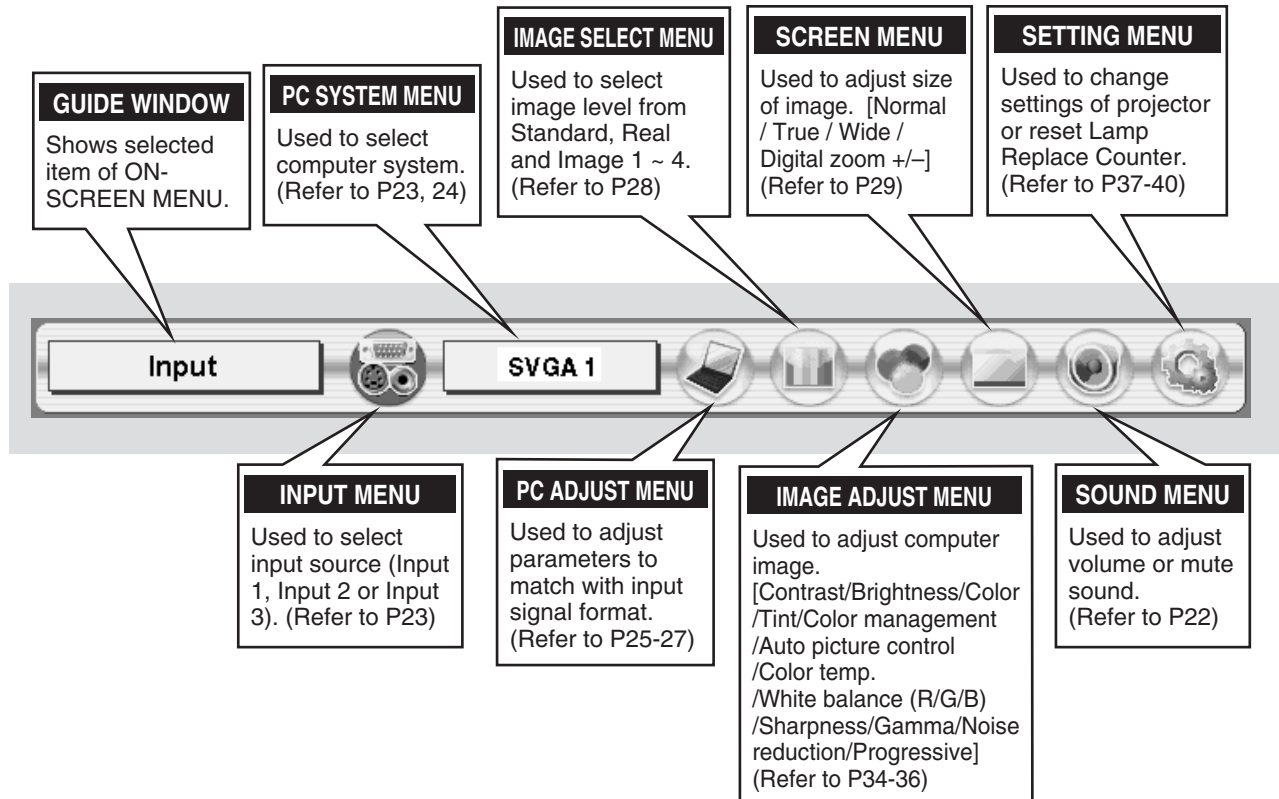

**FOR VIDEO SOURCE**

Press MENU while connected to a VIDEO input source.

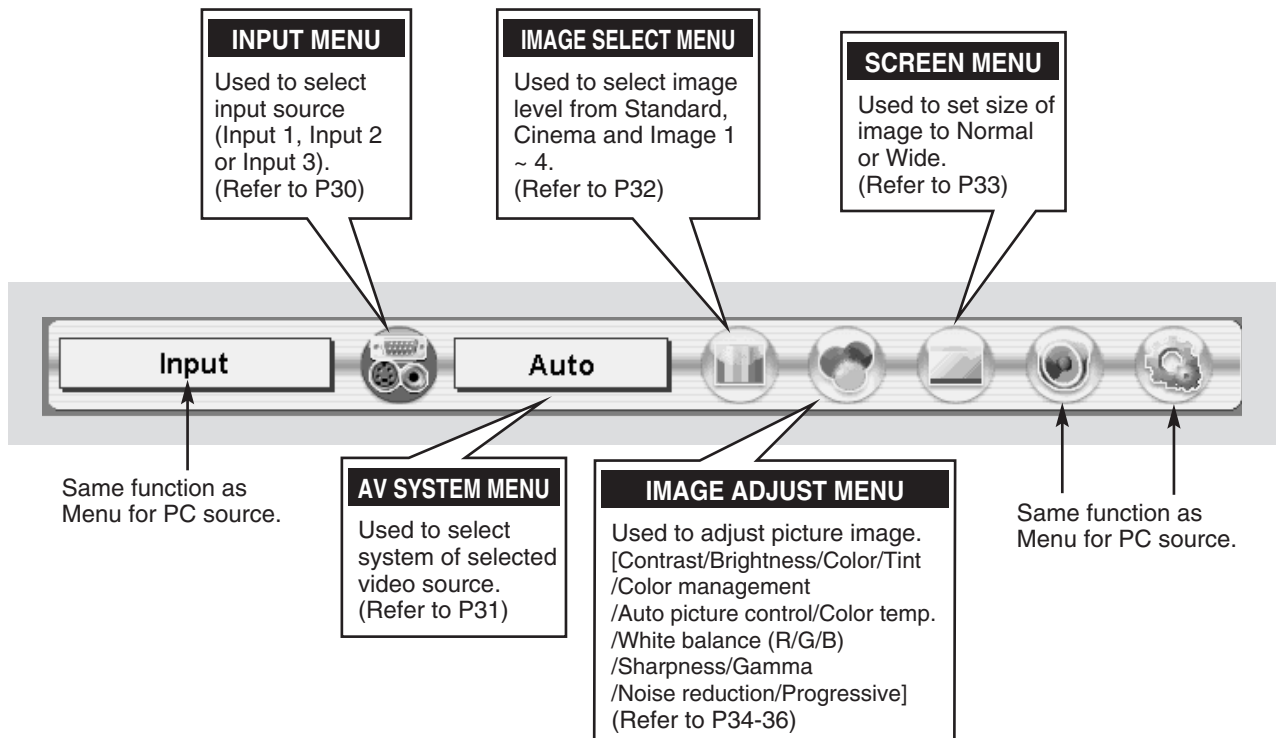

## TURNING ON / OFF PROJECTOR

### TURNING ON PROJECTOR

- 1 Complete peripheral connections (with Computer, VCR, etc.) before turning on projector. (Refer to "CONNECTING TO PROJECTOR" on pages 12~14 for connecting that equipment.)
- 2 Connect the projector's AC Power Cord into an AC outlet. LAMP Indicator lights RED, and READY Indicator lights GREEN.  
NOTE : When the "On start" function is ON, the projector turns on automatically when the AC Power Cord is connected to an AC outlet. (Refer to page 39.)
- 3 Press POWER ON-OFF on Top Control or on Remote Control. The LAMP Indicator dims, and the Cooling Fans start to operate. The Start Display appears on the screen and a count-down starts. The signal from the PC or Video source appears after 30 seconds.  
The currently selected Input and the Lamp mode status are also displayed on screen for 5 seconds. (Refer to "LAMP MODE" on page 37.)

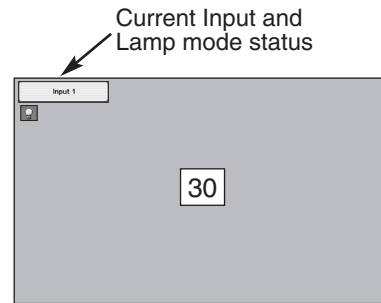

Start Display disappears after 30 seconds.

### TURNING OFF PROJECTOR

- 1 Press POWER ON-OFF on Top Control or on Remote Control, and a "Power off?" message appears on the screen.
- 2 Press POWER ON-OFF again to turn off projector. The LAMP Indicator lights bright and the READY Indicator turns off. After projector is turned off, Cooling Fans operate (for 90 seconds). During this "Cooling Down" period, projector cannot be turned on.
- 3 When the projector has cooled down, the READY Indicator lights GREEN again and you can turn projector on or disconnect the AC Power Cord.



Message disappears after 4 seconds.



TO MAINTAIN LIFE OF LAMP, ONCE YOU TURN PROJECTOR ON, WAIT AT LEAST 5 MINUTES BEFORE TURNING IT OFF.

When the "Power Management" function is enabled, the projector detects signal interruption and turns off the Projection Lamp automatically. Refer to "Power management" on page 39.

When the WARNING TEMP. Indicator is flashing, the projector cannot be turned on, refer to the section "MAINTENANCE" on page 42. When both the WARNING TEMP. and READY Indicators are flashing, refer to the section "MAINTENANCE" on page 42.



Do not use the projector continuously for 24 hours or more. If using the projector continuously for long periods, turn it off and leave it for one hour at least once during a 24 hour period.  
If you use the projector continuously for long period, it can greatly shorten the life of the lamp.

## ADJUSTING SCREEN

### ZOOM ADJUSTMENT

- 1 Press ZOOM on Top Control or ZOOM ▲/▼ on Remote Control. "Zoom" message is displayed.
- 2 Press ZOOM ▲ or POINT UP to make image larger, and press ZOOM ▼ or POINT DOWN to make image smaller.



Message disappears after 4 seconds.

### FOCUS ADJUSTMENT

- 1 Press FOCUS on Top Control or FOCUS ▲/▼ on Remote Control. "Focus" message is displayed.
- 2 Adjust focus of image by pressing FOCUS ▲/▼ or POINT UP/DOWN.

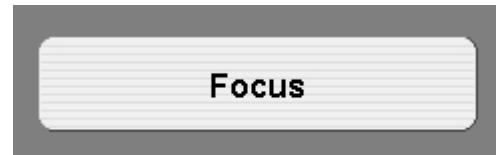

Message disappears after 4 seconds.

### LENS SHIFT ADJUSTMENT

- 1 Press LENS SHIFT on Top Control or LENS SHIFT ▲/▼ on Remote Control. "Lens shift" message is displayed.
- 2 Press POINT UP or LENS SHIFT ▲ to move image up, press POINT DOWN or LENS SHIFT ▼ to move image down.

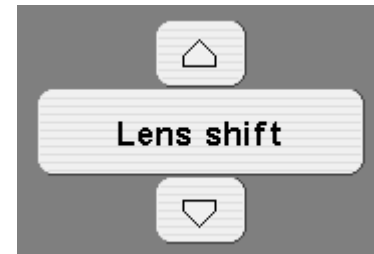

### KEystone ADJUSTMENT

If the projected image has keystone distortion, correct it with the KEYSTONE adjustment.

- 1 Press KEYSTONE on Remote Control or select Keystone on SETTING menu. (Refer to page 37.) Keystone dialog box appears.
- 2 Correct keystone distortion by pressing POINT UP/DOWN/LEFT/RIGHT. Press POINT UP to reduce the upper part of the image, and press POINT DOWN to reduce the lower part. Press POINT LEFT to reduce the left part, and press POINT RIGHT to reduce the right part.

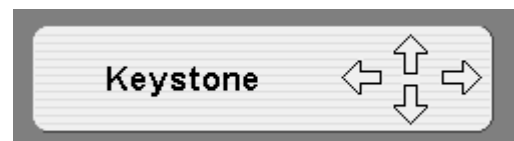

- Arrows are white in no correction.
- Arrow(s) of direction being corrected turn(s) red.
- Arrow(s) disappear(s) at the maximum correction.
- If you press the KEYSTONE on Top Control or on Remote Control once more while the keystone dialog box is being displayed, the keystone adjustment will be canceled.

Reduce the upper width with POINT UP.

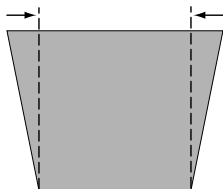

Reduce the lower width with POINT DOWN.

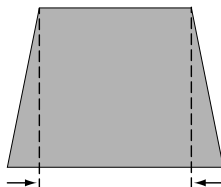

Reduce the left part with POINT LEFT.

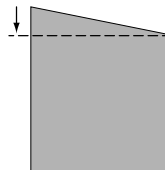

Reduce the right part with POINT RIGHT.

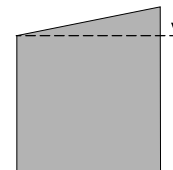

## PICTURE FREEZE FUNCTION

Press FREEZE on Remote Control to freeze picture on-screen. To cancel FREEZE function, press FREEZE again or press any other button.

## NO SHOW FUNCTION

Press NO SHOW on Remote Control to black out image. To restore to normal, press NO SHOW again or press any other button.

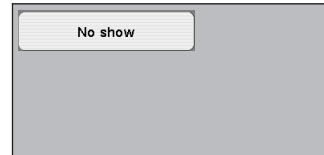

Message disappears after 4 seconds.

## P-TIMER FUNCTION

Press P-TIMER on Remote Control. Timer display "00:00" appears on screen and timer starts to count time (00:00 ~ 59:59). To stop P-TIMER display, press P-TIMER. Press P-TIMER again to cancel P-TIMER function.



# SOUND ADJUSTMENT

## DIRECT OPERATION

### Volume

Press VOLUME (+/-) on Top Control or on Remote Control to adjust volume. Volume dialog box appears on screen for a few seconds. (+) button to increase volume, and (-) button for decrease.

### Mute

Press MUTE on Remote Control to cut off sound. To restore sound to its previous level, press MUTE again or press Volume (+/-).

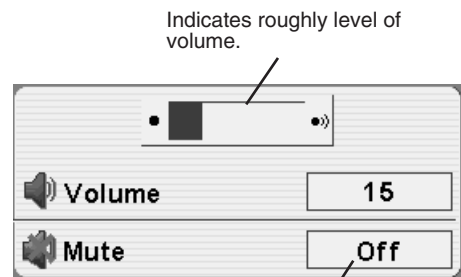

Indicates roughly level of volume.

Press MUTE to set Mute function On or Off.

Display disappears after 4 seconds.

## MENU OPERATION

**1** Press MENU and ON-SCREEN MENU will appear. Press POINT LEFT/RIGHT to move the red frame pointer to SOUND.

**2** Press POINT UP/DOWN to move the red frame pointer to the item that you want to select, and then press SELECT.



### Volume

To increase volume, press POINT RIGHT, press POINT LEFT to decrease.



### Built-in SP.

Press POINT LEFT/RIGHT to switch built-in speaker on and off.



### Mute

Press POINT LEFT/RIGHT to cut off sound. Dialog box display is changed to "On" and sound is cut off. To restore sound to its previous level, press POINT LEFT/RIGHT again.

## SOUND MENU

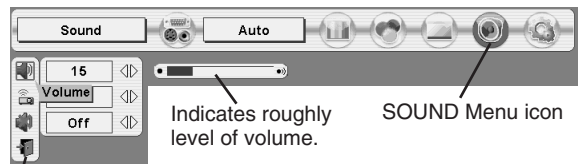

Indicates roughly level of volume.

SOUND Menu icon

Close SOUND Menu.



## SELECTING INPUT SOURCE

### DIRECT OPERATION

Select INPUT source by pressing INPUT on Top Control.  
Select INPUT source by pressing INPUT 1, INPUT 2 or INPUT 3 on Remote Control.  
If the projector cannot reproduce proper image, manually select the correct input source using the On Screen MENU (see below).

#### NOTE

- Input 1 terminal is switchable and can be used as computer input or monitor output.

#### INPUT button

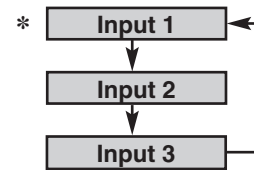

- \* Input 1 is not displayed when the Input 1 is used as Monitor out.

### MENU OPERATION

- 1 Press MENU and ON-SCREEN MENU will appear. Press POINT LEFT/RIGHT to move the red frame pointer to INPUT Menu.
- 2 Press POINT UP/DOWN and a red-arrow icon will appear. Move arrow to INPUT source that you want to select, and then press SELECT.

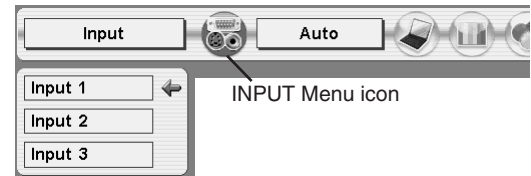

## SELECTING COMPUTER SYSTEM

### SELECTING INPUT 1 (COMPUTER INPUT TERMINALS)

- 1 Press MENU and ON-SCREEN MENU will appear. Press POINT LEFT/RIGHT to move the red frame pointer to INPUT.
- 2 Press POINT UP/DOWN to move the red arrow pointer to Input 1 and then press SELECT. Source Select Menu will appear.
- 3 Move the pointer to the source that you want to select and then press SELECT.

#### RGB(Analog)

When your computer is connected to INPUT 1 (ANALOG) terminal, select RGB(Analog).

#### RGB(Scart)

When video equipment is connected to INPUT 1 (ANALOG) terminal, select RGB(Scart).

#### RGB(PC Digital)

When your computer is connected to INPUT 1 (DIGITAL) terminal, select RGB(PC Digital).

#### RGB(AV HDCP)

If a HDCP-compatible signal source is connected to the INPUT 1 (DIGITAL) terminal, select RGB(AV HDCP).

#### Monitor out

If the INPUT 1 ANALOG terminal is being used as a MONITOR OUT terminal, select Monitor out.

#### INPUT MENU

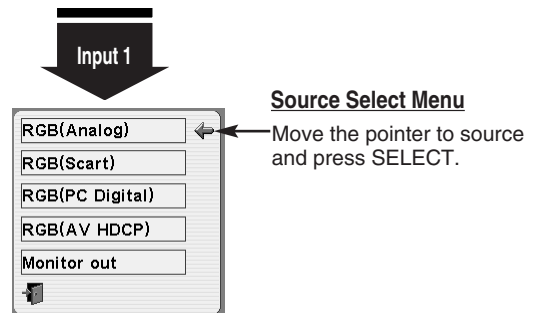
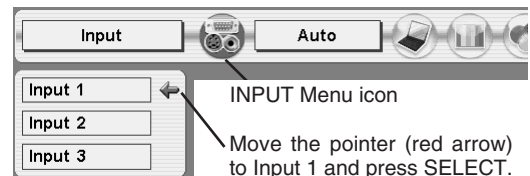

NOTE;  
HDCP (High-bandwidth Digital Content Protection) is a system for protecting digital entertainment content which is delivered by DVI (Digital Visual Interface) from being copied. The specification of HDCP is decided and controlled by Digital Content Protection, LLC. Should the specification be changed, this projector may not display the digital content protected by HDCP.



## SELECTING INPUT 2 (5 BNC INPUT JACKS )

Connecting a computer output [5 BNC Type (Green, Blue, Red, Horiz. Sync and Vert. Sync.)] from a computer to G, B, R, H/HV and V jacks.

- 1 Press MENU and ON-SCREEN MENU will appear. Press POINT LEFT/RIGHT to move the red frame pointer to INPUT.
- 2 Press POINT UP/DOWN to move the red arrow pointer to Input 2 and then press SELECT. Source Select Menu will appear.
- 3 Press POINT UP/DOWN and a red-arrow icon will appear. Move arrow to "RGB", and then press SELECT.

### INPUT MENU

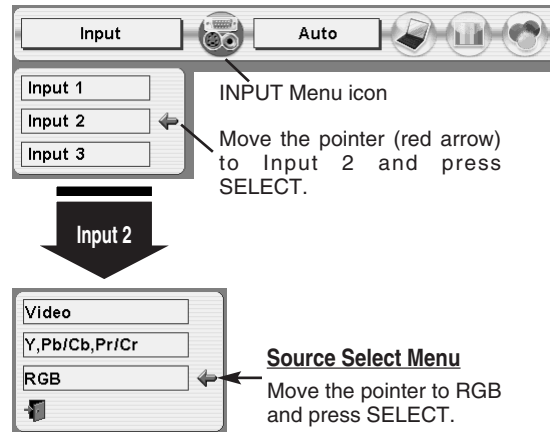

## AUTOMATIC MULTI-SCAN SYSTEM

This projector automatically tunes to most different types of computers based on VGA, SVGA, XGA or SXGA (refer to "COMPATIBLE COMPUTER SPECIFICATION" on page 49). When a computer input is selected, the projector automatically tunes to the incoming signal and projects the proper image without any special setting. (Some computers need to be set manually.)

The projector displays either Auto, -----, Mode 1/2/3/4/5, or the system provided by the projector.

### Auto

When the projector cannot recognize the PC signal as a system programmed into this projector, the Auto PC Adjustment function attempts to adjust the projector and the message "Auto" is displayed on the SYSTEM Menu icon.

If the image is not displayed properly, manual adjustment is required. (Refer to P26 and 27.)

### ---

There is no signal input from computer. Make sure the computer and projector are connected and configured correctly. (Refer to TROUBLESHOOTING on page 46.)

### Mode 1

User preset adjustment in MANUAL PC ADJUSTMENT. Adjustment data can be stored in the Mode 1-5.

### SVGA 1

Computer systems provided in the projector. The projector chooses proper system and displays it.

\* Mode 1 and SVGA 1 are examples.

### PC SYSTEM MENU

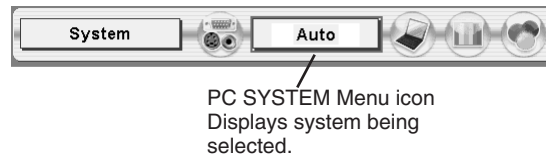

## SELECT COMPUTER SYSTEM MANUALLY

This projector automatically selects PC system among those provided in this projector. The PC system can be also selected manually.

- 1 Press MENU and the ON-SCREEN MENU will appear. Press POINT LEFT/RIGHT to move the red frame pointer to PC SYSTEM.
- 2 Press POINT UP/DOWN to move the red arrow pointer to the system that you want to set, and then press SELECT.

### PC SYSTEM MENU

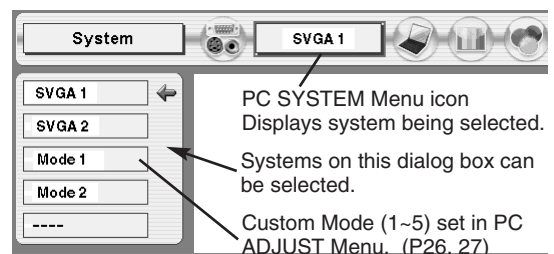

## PC ADJUSTMENT

### AUTO PC ADJUSTMENT

Auto PC Adjustment function is provided to automatically adjust Fine sync, Total dots and Picture Position to conform to your computer. Auto PC Adjustment function can be operated as follows.



#### Auto PC Adj.

- 1 Press MENU and the ON-SCREEN MENU will appear. Press POINT LEFT/RIGHT to move the red frame pointer to PC ADJUST.
- 2 Press POINT UP/DOWN to move the red frame pointer to AUTO PC Adj. icon and then press SELECT.  
This Auto PC Adjustment can be also executed by pressing AUTO PC ADJ. on Top Control or on Remote Control.

Store adjustment parameters.

Adjustment parameters from Auto PC Adjustment can be memorized in the projector. Once the parameters are memorized, they can be recalled just by selecting the Mode in the PC SYSTEM Menu (P24). Refer to step 3 of MANUAL PC ADJUSTMENT section (P27).

#### NOTE

- Fine sync, Total dots and Picture Position of some computers can not be fully adjusted with the Auto PC Adjustment function. When the image is not displayed properly through this function, manual adjustments are required. (Refer to page 26, 27.)
- The Auto PC Adjustment function cannot be selected for Digital Signal inputs on the DVI terminal or if “480p”, “575p”, “480i”, “575i”, “720p (HDTV)”, “1035i (HDTV)” or “1080i (HDTV)” is selected on the PC SYSTEM Menu.

#### PC ADJUST MENU

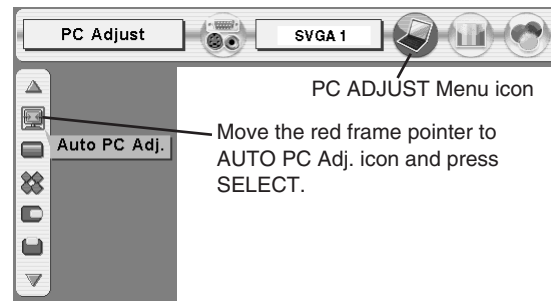

## MANUAL PC ADJUSTMENT

This projector can automatically tune to display signals from most personal computers currently distributed. However, some computers employ special signal formats which are different from standard ones and may not be tuned by Multi-Scan system of this projector. If this happens, the projector cannot reproduce a proper image, the image may be flickering, non-synchronized, non-centered or skewed.

This projector has a Manual PC Adjustment to enable you to precisely adjust several parameters to match those special signal formats. This projector has 5 independent memory areas to store the manually adjusted parameters. This enables you to recall the settings for a specific computer whenever you use it.

Note : The PC ADJUST Menu cannot be operated when DVI is selected on PC SYSTEM MENU (P24).

**1** Press MENU and ON-SCREEN MENU will appear. Press POINT LEFT/RIGHT to move the red frame pointer to PC ADJUST.

**2** Press POINT UP/DOWN to move the red frame pointer to the item that you want to adjust and then press SELECT. Adjustment dialog box will appear. Press POINT LEFT/RIGHT to adjust value.



### Fine sync

Adjusts the image as necessary to eliminate flicker from display. Press POINT LEFT/RIGHT to adjust value. (From 0 to 31.)



### Total dots

Adjusts the number of total dots in one horizontal period. Press POINT LEFT/RIGHT and adjust number to match your PC output.



### Horizontal

Adjusts horizontal picture position. Press POINT LEFT/RIGHT to adjust position.



### Vertical

Adjusts vertical picture position. Press POINT LEFT/RIGHT to adjust position.



### Current mode

Press SELECT to show information of computer selected.



### Clamp

Adjusts clamp position. When image has a dark bar(s), try this adjustment.

### PC ADJUST MENU

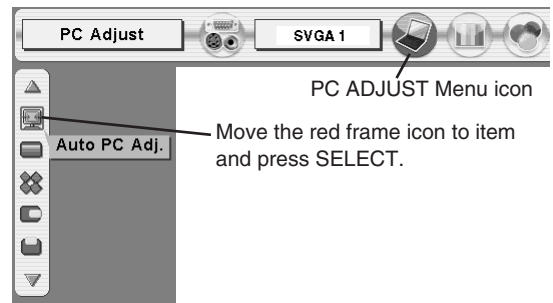

Move the red frame icon to item and press SELECT.

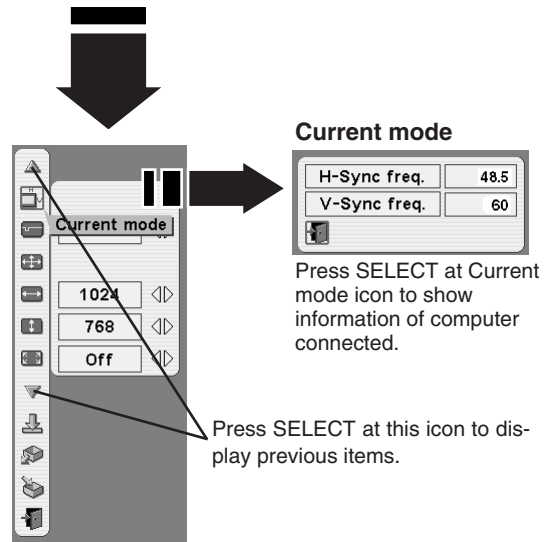
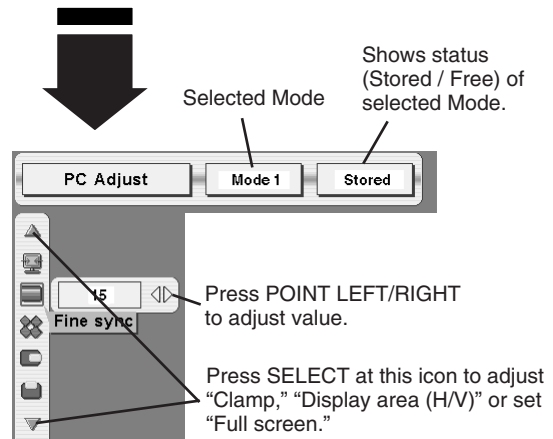

## Display area

Selects area displayed with this projector. Select resolution at Display area dialog box.

## Display area H

Adjustment of horizontal area displayed by the projector. Press POINT LEFT/RIGHT to decrease/increase value and then press SELECT.

## Display area V

Adjustment of vertical area displayed by the projector. Press POINT LEFT/RIGHT to decrease/increase value and then press SELECT.

## Full screen

Press POINT LEFT/RIGHT to switch Full screen function to "On" or "Off." Set "On" to resize image with 4 x 3 aspect ratio to fit screen. This function cannot be adjusted when "ON" is selected on Anamorphic function (P38).

NOTE : Fine sync, Display area, Display area H, Display area V and Full screen cannot be adjusted when "480p", "575p", "480i", "575i", "720p (HDTV)", "1035i (HDTV)" or "1080i (HDTV)" is selected on PC SYSTEM Menu (P24).

## 3 Store

To store adjustment parameters, move the red frame pointer to Store icon and then press SELECT. Move the red arrow pointer to any of Mode 1 to 5 that you want to store and then press SELECT.

## Mode free

To clear adjustment parameters previously set, move the red frame pointer to Mode free icon and then SELECT. Move the red arrow pointer to the Mode that you want to clear and then press SELECT.

Other icons operates as follows.

## Reset

Reset all adjust parameters on adjustment dialog box to previous values.

## Quit

Closes PC ADJUST MENU.

Press SELECT at Display area icon and Display area dialog box appears.

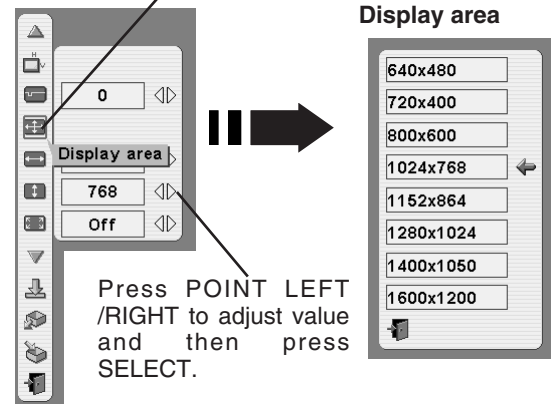

Press POINT LEFT/RIGHT to adjust value and then press SELECT.

### To store adjustment data.

This Mode has parameters being stored.

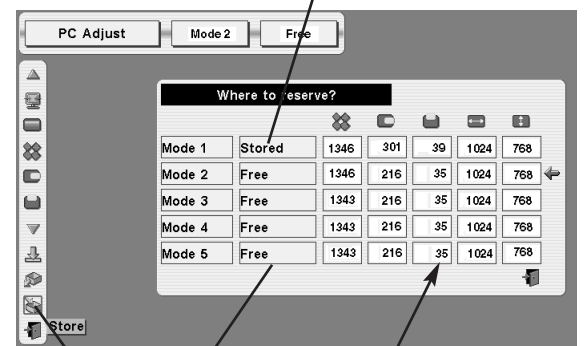

Store icon Vacant Mode Shows values of "Total dots," "Horizontal," "Vertical," "Display area H," and "Display area V."

### To clear adjustment data.

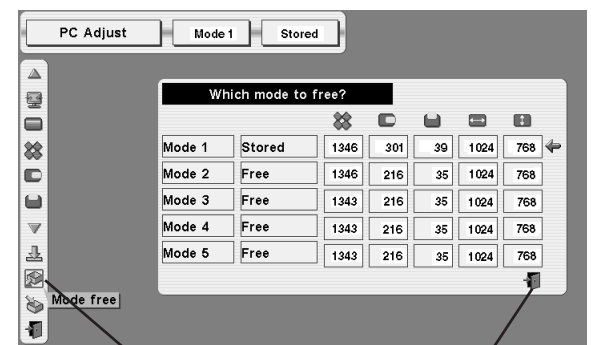

Mode free icon

Close this dialog box.

# PICTURE IMAGE SELECT

## IMAGE LEVEL SELECT (DIRECT)

Select image level from Standard, Real, Image 1, Image 2, Image 3 and Image 4 by pressing IMAGE on Top Control or on Remote Control.

**Standard**

Normal picture level preset on this projector.

**Real**

Picture level with improved halftone for graphics.

**IMAGE 1~4**

User preset picture adjustment in IMAGE ADJUST Menu (P36).

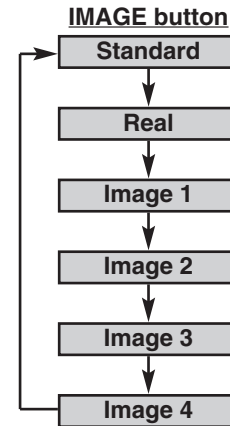

## IMAGE LEVEL SELECT (MENU)

**1** Press MENU and ON-SCREEN MENU will appear. Press POINT LEFT/RIGHT to move the red frame pointer to IMAGE SELECT.

**2** Press POINT UP/DOWN to move the red frame pointer to the level that you want to set and then press SELECT.



**Standard**

Normal picture level preset on this projector.



**Real**

Picture level with improved halftone for graphics.



**IMAGE 1~4**

User preset picture adjustment in IMAGE ADJUST Menu (P36).

### IMAGE SELECT MENU

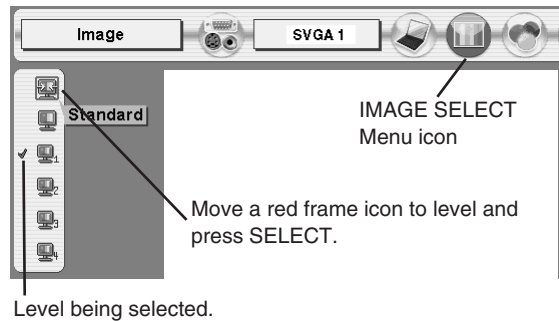

## PICTURE SCREEN ADJUSTMENT

This projector has a picture screen resize function, which enables you to choose how the projector displays computer images.

- 1 Press MENU and ON-SCREEN MENU will appear. Press POINT LEFT/RIGHT to move the red frame pointer to SCREEN.
- 2 Press POINT UP/DOWN and move the red frame pointer to the function that you want to select and then press SELECT.



### Normal

Provides image to fit screen size.



### True

Provides image in its original size. When original image size is larger than screen size (1024 x 768), this projector enters "Digital zoom +" mode automatically.



### Wide

Provides image to fit wide video aspect ratio (16 : 9) by expanding image width uniformly. This function can be used for providing a squeezed video signal at 16 : 9.



### Digital zoom +

When Digital zoom + is selected, ON-SCREEN MENU disappears and message "D. Zoom +" is displayed. Press SELECT to expand image size. And press POINT UP/DOWN/LEFT/RIGHT to pan image. Panning function can work only when image is larger than screen size.

The projected image can also be expanded by pressing D.ZOOM ▲ on Remote Control.



### Digital Zoom -

When Digital zoom - is selected, ON-SCREEN MENU disappears and message "D. Zoom -" is displayed. Press SELECT to compress image size.

The projected image can also be compressed by pressing D.ZOOM ▼ on Remote Control.

To cancel Digital Zoom +/- mode, press any button except D.ZOOM ▲/▼, SELECT, POINT and LASER.

### SCREEN MENU

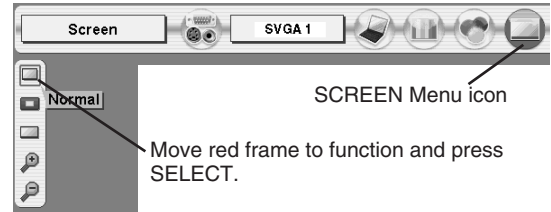

### NOTE

- True and Digital zoom +/- cannot be operated when "480i", "575i", "480p", "575p", "1035i (HDTV)" or "1080i (HDTV)" is selected on PC SYSTEM Menu (P24).
- Wide cannot be selected when "720p (HDTV)", "1035i (HDTV)" or "1080i (HDTV)" is selected on PC SYSTEM Menu (P24).
- This projector cannot display any resolution higher than 1280 X 1024. If your computer's screen resolution is higher than 1280 X 1024, reset resolution to lower before connecting projector.
- Image data in other than XGA (1024 x 768) is modified to fit screen size in initial mode.
- Panning function may not operate properly if computer system prepared on PC ADJUST Menu is used.

## SELECTING INPUT SOURCE

### SELECTING INPUT 2 (5 BNC INPUT JACKS )

When connecting to a video source, select the input source in SOURCE SELECT Menu.

- 1 Press MENU and ON-SCREEN MENU will appear. Press POINT LEFT/RIGHT to move the red frame pointer to INPUT.
- 2 Press POINT UP/DOWN to move the red arrow pointer to Input 2 and then press SELECT. Source Select Menu will appear.
- 3 Move pointer to the source that you want to select and then press SELECT.

**Video** When video input signal is connected to VIDEO jack, select Video.

**Y,Pb/Cb,Pr/Cr** When video input signal is connected to Y-Pb/Cb-Pr/Cr jacks, select Y, Pb/Cb, Pr/Cr.

#### INPUT MENU

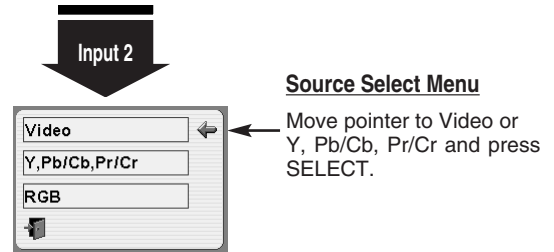
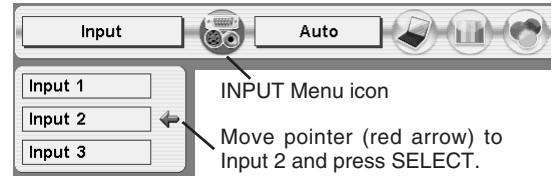

### SELECTING INPUT 3 (AV TERMINALS )

When connecting to a video source, select the input source in SOURCE SELECT (VIDEO) Menu.

- 1 Press MENU and ON-SCREEN MENU will appear. Press POINT LEFT/RIGHT to move the red frame pointer to INPUT.
- 2 Press POINT UP/DOWN to move the red arrow pointer to Input 3 and then press SELECT. Source Select Menu will appear.
- 3 Move pointer to the source that you want to select and then press SELECT.

**Video** When video input signal is connected to VIDEO jack, select Video.

**Y,Pb/Cb,Pr/Cr** When video input signal is connected to Y-Pb/Cb-Pr/Cr jacks, select Y, Pb/Cb, Pr/Cr.

**S-Video** When video input signal is connected to S-VIDEO jack, select S-Video.

#### INPUT MENU

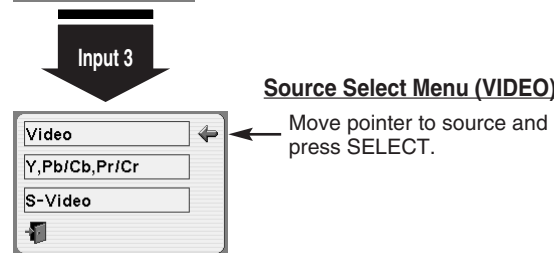
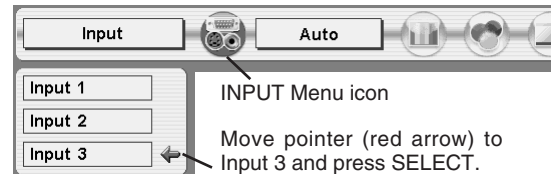

## SELECTING VIDEO SYSTEM

- 1 Press MENU and ON-SCREEN MENU will appear. Press POINT LEFT/RIGHT to move the red frame pointer to AV SYSTEM.
- 2 Press POINT UP/DOWN to move the red arrow pointer to the system that you want to select and then press SELECT.

### VIDEO JACK OR S-VIDEO JACK

#### Auto

Projector automatically detects incoming Video system, and adjusts itself to optimize its performance.

When Video System is PAL-M or PAL-N, select system manually.

#### PAL / SECAM / NTSC / NTSC4.43 / PAL-M / PAL-N

If projector cannot reproduce proper video image, it is necessary to select a specific broadcast signal format from PAL, SECAM, NTSC, NTSC 4.43, PAL-M, and PAL-N.

#### AV SYSTEM MENU (VIDEO OR S-VIDEO)

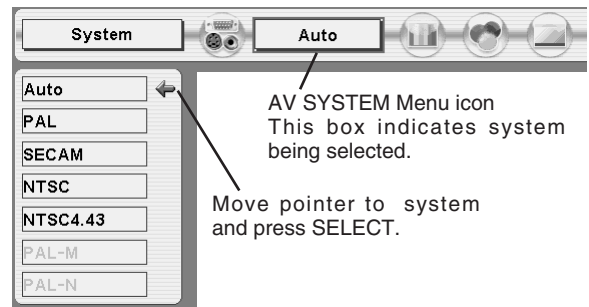

### Y, Pb/Cb, Pr/Cr JACKS

#### Auto

Projector automatically detects incoming Video signal, and adjusts itself to optimize its performance.

When Video System is 1035i or 1080i, select system manually.

#### COMPONENT VIDEO SIGNAL FORMAT

If projector cannot reproduce proper video image, it is necessary to select a specific component video signal format from 480i, 575i, 480p, 575p, 720p, 1035i and 1080i.

#### AV SYSTEM MENU (COMPONENT VIDEO)

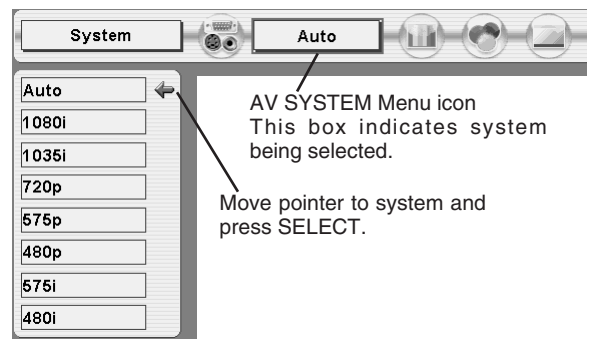



# PICTURE IMAGE SELECT

## IMAGE LEVEL SELECT (DIRECT)

Select image level from Standard, Cinema, Image 1, Image 2, Image 3 and Image 4 by pressing IMAGE on Top Control or on Remote Control.

**Standard**

Normal picture level preset on this projector.

**Cinema**

Picture level adjusted for picture with fine tone.

**IMAGE 1~4**

User preset picture adjustment in IMAGE ADJUST Menu (P36).

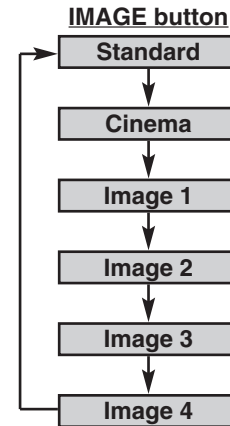

## IMAGE LEVEL SELECT (MENU)

- 1 Press MENU and ON-SCREEN MENU will appear. Press POINT LEFT/RIGHT to move the red frame pointer to IMAGE SELECT.
- 2 Press POINT UP/DOWN to move the red frame pointer to the level that you want to set and then press SELECT.

**IMAGE SELECT MENU**

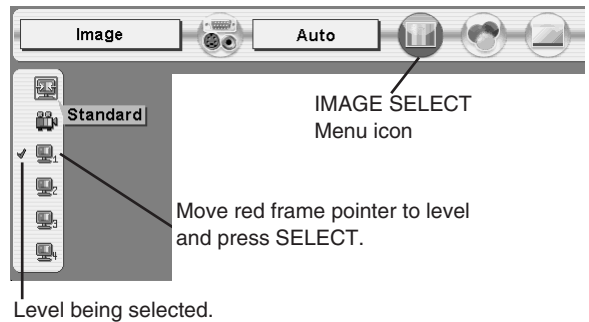

**Standard**

Normal picture level preset on this projector.



**Cinema**

Picture level adjusted for picture with fine tone.



**IMAGE 1~4**

User preset picture adjustment in IMAGE ADJUST Menu (P36).

## PICTURE SCREEN ADJUSTMENT

This projector has a picture screen resize function, which enables you to control how the projector resizes the video image.

- 1 Press MENU and ON-SCREEN MENU will appear. Press POINT LEFT/RIGHT to move the red frame pointer to SCREEN.
- 2 Press POINT UP/DOWN and move the red frame pointer to the function that you want to select and then press SELECT.



**Normal**

Provides image at a normal video aspect ratio of 4 : 3.



**Wide**

Provides image at a wide screen ratio of 16 : 9.

### SCREEN MENU

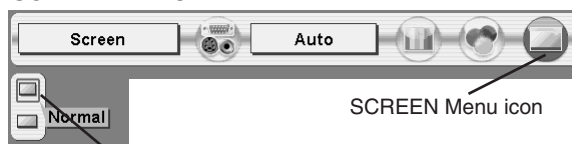

Move red frame to function and press SELECT.

NOTE : SCREEN Menu cannot be operated when "720p," "1035i," or "1080i" is selected on AV SYSTEM Menu (P31).

## PICTURE IMAGE ADJUSTMENTS

- 1 Press MENU and ON-SCREEN MENU will appear. Press POINT LEFT/RIGHT to move the red frame pointer to IMAGE ADJUST.
- 2 Press POINT UP/DOWN to move the red frame pointer to the item that you want to adjust and then press SELECT. Adjust levels by pressing POINT LEFT/RIGHT.



### Contrast

Press POINT LEFT to decrease contrast, and POINT RIGHT to increase contrast. (From 0 to 63.)



### Brightness

Press POINT LEFT to adjust image darker, and POINT RIGHT to adjust brighter. (From 0 to 63.)



### Color

Press POINT LEFT to lighten color, and POINT RIGHT to deeper color. (From 0 to 63.)



### Tint

Press POINT LEFT or POINT RIGHT to obtain proper color. (From 0 to 63.)



### Color Management

The Color management function can be used to adjust the level, phase and gamma of the selected display colors on the screen, and to replace these colors with other colors if required. The projector lets you replace up to eight colors for each image. There are four preset images for VIDEO mode and four preset images for PC, giving a total of eight images.

- 1 Press the POINT UP/DOWN to move the red frame pointer to "COLOR MANAGEMENT", and then press the SELECT. The COLOR MANAGEMENT menu will appear and pointer mode will be enabled. The image that was being projected when the button was pressed will be paused, and the COLOR MANAGEMENT POINTER will appear.
- 2 Use the POINT to move the pointer to a section of the paused image that contains the color that you would like to adjust, and then press the SELECT. The mode will change to COLOR SELECTION mode, and the color in the center of the pointer will be selected and adjustment will be possible.
- 3 Use the POINT to adjust the level and phase of the color, and then press the SELECT to confirm the setting. Next, use the POINT to adjust the gamma correction for the color, and then press the SELECT to accept the setting. When the SELECT is pressed, the mode will change to LIST mode.

### IMAGE ADJUST MENU

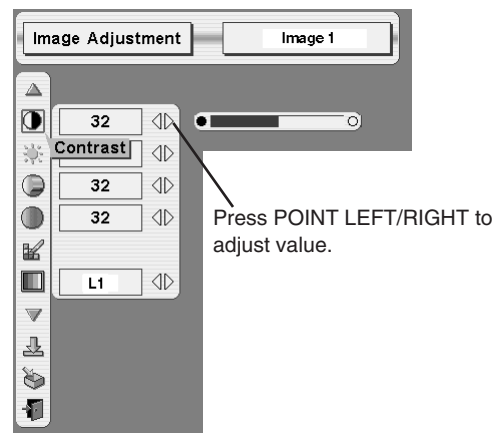
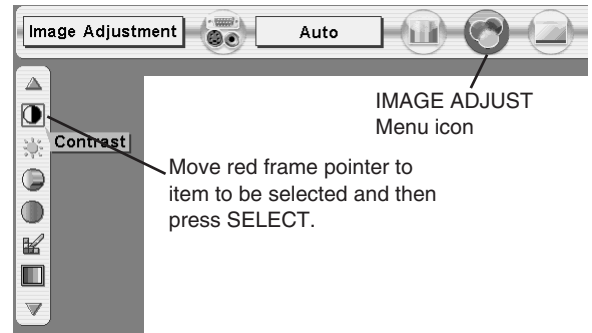

### POINTER MODE

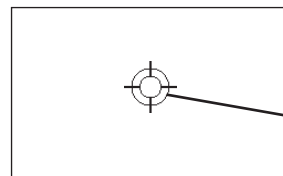

COLOR MANAGEMENT POINTER

### NOTE;

Press the COLOR M. on the remote control to display the COLOR MANAGEMENT menu. If you would like to check or re-adjust a color management setting that has already been made, press the COLOR M. on the remote control once more to change to LIST mode.

- 4 Move the red frame pointer to "MENU", and then press the SELECT. The message "OK"? is displayed. Move the pointer to [Yes] and then press SELECT. The COLOR MANAGEMENT menu will be exited and the display will return to the IMAGE ADJUST menu. (At this time, the image will stop being paused and normal projection will resume.) After changing the COLOR MANAGEMENT settings, use the IMAGE ADJUST menu to store the changed settings.

COLOR SELECTION MODE

**CANCEL**

The mode will return to the pointer mode (even if you press the MENU key on the projector or the remote control). (You will need to reselect and re-adjust the color in this case.)

**QUIT**

The COLOR MANAGEMENT menu will be exited and the display will return to the normal projection screen, but any settings that have been changed will not be stored. To store the changed settings, be sure to select "LIST" using the POINT buttons and change to the next mode (LIST mode).

LIST MODE



Clearing the check box temporarily disables the specific color management effect on that line, allowing you to compare the image without the effect

**COLOR PALETTE**

Returns to COLOR SELECTION mode so that you can re-adjust the setting for the color in that line. This option is not available if the check mark has been cleared by the operation immediately above.

**DEL**

The setting adjustment for the color in that line will be deleted.

**ALL DEL**

The setting adjustment for the colors in all lines will be deleted.

**COLOR M.**

The mode will return to POINTER mode.



**Auto picture control**

Press either POINT LEFT or POINT RIGHT to Auto picture control position that you want to select. (Off, L1 or L2)

- Off ..... Auto picture control OFF position.
- L1 ..... Auto picture control LEVEL 1 position.
- L2 ..... Auto picture control LEVEL 2 position.

COLOR SELECTION MODE

Level and phase adjustment palette.      Gamma adjustment palette.

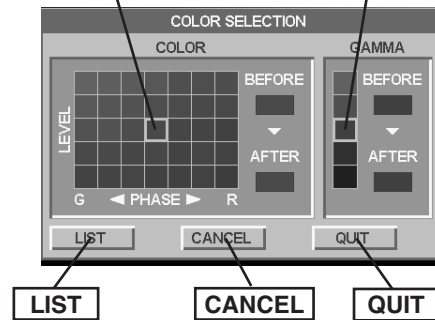

LIST MODE

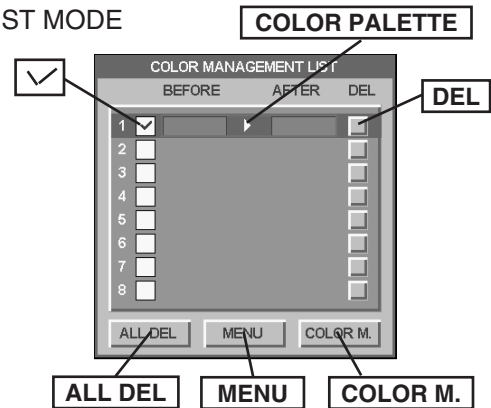

**NOTE;**

If you press the COLOR M. on the remote control, the COLOR MANAGEMENT menu will be exited and the display will return to the normal projection screen, but any settings that have been changed will not be stored. To store the changed settings, be sure to select "MENU" using the POINT buttons and store the settings.

# PICTURE IMAGE



## Color temp.

Press either POINT LEFT or POINT RIGHT to Color temp. level that you want to select. (XLow, Low, Mid or High)



## White balance (Red)

Press POINT LEFT to lighten red tone and POINT RIGHT to deeper tone. (From 0 to 63.)



## White balance (Green)

Press POINT LEFT to lighten green tone and POINT RIGHT to deeper tone. (From 0 to 63.)



## White balance (Blue)

Press POINT LEFT to lighten blue tone and POINT RIGHT to deeper tone. (From 0 to 63.)



## Sharpness

Press POINT LEFT to soften the image, and POINT RIGHT to sharpen the image. (From 0 to 31.)



## Gamma

Press either POINT LEFT or POINT RIGHT to obtain better balance of contrast. (From 0 to 15.)



## Noise reduction

Press POINT LEFT/RIGHT to change noise reduction mode. Dialog box display is changed to "On" to reduce noise (rough parts) of image. Press POINT LEFT/RIGHT again, to change noise reduction mode to off.



## Progressive scan

Press POINT LEFT/RIGHT to change progressive scan mode. Dialog box display is changed to "Off", "L1", "L2".

- Off ... Progressive scan mode to OFF.
- L1 .... Progressive scan mode to ON (for active picture).
- L2 .... Progressive scan mode to ON (for still picture).



## Store

To store manually preset image, move the red frame pointer to Store and press SELECT. Image Level Menu will appear. Move red frame pointer to Image 1 to 4 where you want to set and then press SELECT.

Other icons operates as follows.



## Reset

Reset all adjustment to previous values.



## Quit

Closes IMAGE MENU.

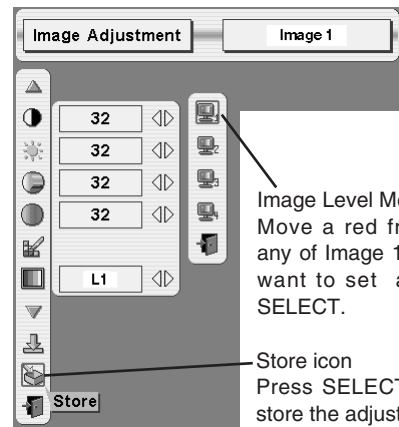
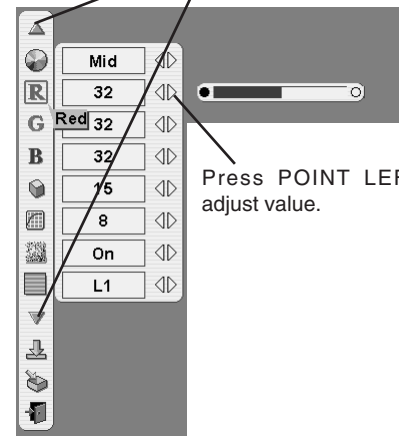
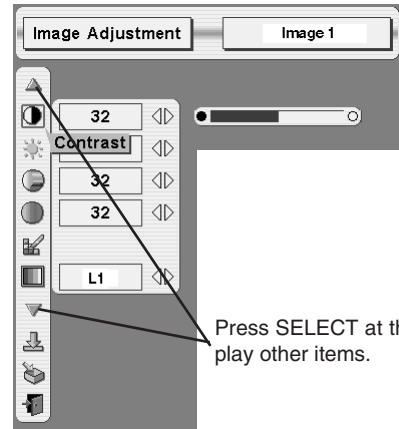

### NOTE :

Tint cannot be adjusted when the video system is PAL, SECAM, PAL-M or PAL-N.

Progressive cannot be operated when "480p", "575p" or "720p" is selected on AV SYSTEM MENU (P31).

## SETTING MENU

- 1 Press MENU and ON-SCREEN MENU will appear. Press POINT LEFT/RIGHT to move the red-frame pointer to SETTING.
- 2 Press POINT DOWN to move the red-frame pointer to the item that you want to set and then press SELECT. Setting dialog box appears.



### Language

Language used in ON-SCREEN MENU is selectable from English, German, French, Italian, Spanish, Portuguese, Dutch, Swedish, Russian, Chinese, Korean and Japanese.



### Lamp mode

Lamp Mode allows you to reduce the brightness of the lamp and the power consumption of the projector.



Normal mode



Auto mode The brightness is adjusted automatically to a level that is suitable for the screen.



Eco mode The brightness is reduced to 80% of Normal mode.



### Keystone

When the image is distorted, select Keystone. ON-SCREEN MENU disappears and Keystone dialog box is displayed.

Store ... Saves the keystone adjustment settings when the projector is shut off.

Reset ... Resets the keystone adjustment settings to "0" when the projector is shut off.

When SELECT is pressed, the mode changes to keystone adjustment mode. Correct keystone distortion by pressing POINT UP/DOWN/LEFT/RIGHT. Refer to KEYSTONE ADJUSTMENT on page 21.



### Aspect V



### Aspect H

These adjust the vertical and horizontal scale and position of the screen. Use the POINT RIGHT/LEFT to select Store or Reset.

Store ... Saves the adjustment settings when the projector is shut off.

Reset ... Resets the adjustment settings when the projector is shut off.

When SELECT is pressed, the mode changes to Scale or Position adjustment mode. Use the POINT LEFT/RIGHT to select whether you wish to adjust Scale or Position, and then use the POINT UP/DOWN to adjust the values.

#### NOTE :

Adjusting the Keystone settings clears the Aspect H/V settings.

To maintain the Aspect H/V adjustment settings, adjust the keystone first, then adjust the Aspect H/V.

### SETTING MENU

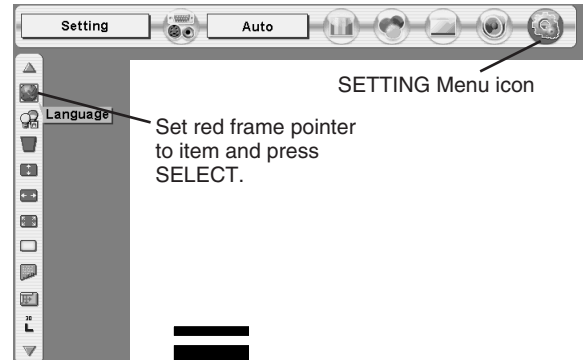

Set red frame pointer to item and press SELECT.

SETTING Menu icon

When pressing SELECT at Language, Language Menu appears.

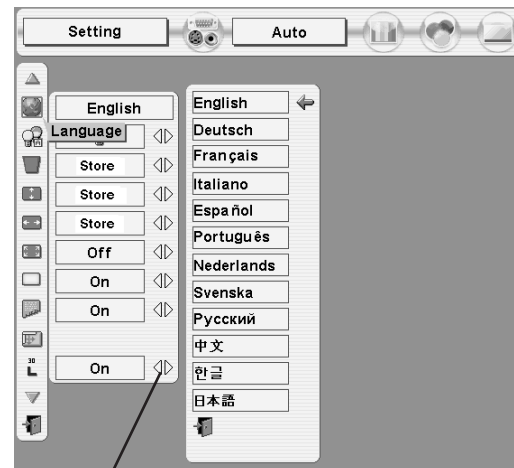

Move pointer to item and then press POINT LEFT/RIGHT.

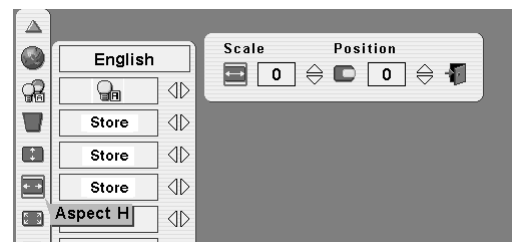
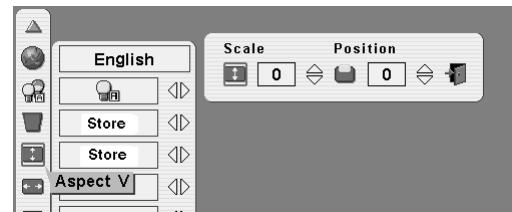



## Anamorphic

When this function is “On,” the screen image is forcibly changed to a 4:3 image, even if the input signal is HDTV.



## Blue back

When this function is “On,” and the projector is not receiving any input a blank, blue screen will be displayed instead of video noise.



## Display

This function decides whether to display On-Screen Displays.

On ... shows all the On-Screen Displays.

Off ... no On-Screen Displays will show except;

- ON-SCREEN MENU
- “Power off?” message
- P-TIMER
- “No signal” message
- “Wait a moment” message



## Menu position

This function is used to adjust the on-screen menu display position. When SELECT is pressed, the adjustment screen is displayed (arrows appear). Use the POINT UP/DOWN/LEFT/RIGHT to adjust the position. After making the adjustment, press SELECT to return to the Menu screen.



## Logo

When this function is “On,” projector displays logo when starting up.



## Ceiling

When this function is “On,” picture is top/bottom and left/right reversed. This function is used when the projector is mounted upside down e.g. hanging from a ceiling mount.

### Ceiling function

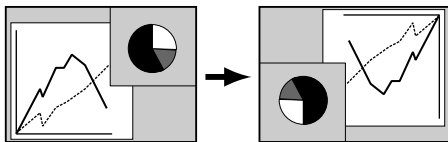

## Rear

When this function is “On,” picture is left/right reversed. This function is used to project the image onto a rear projection screen.

### Rear function

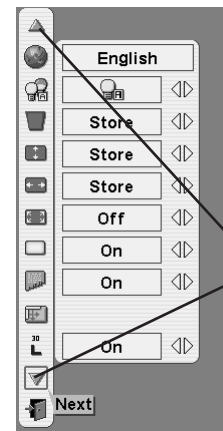
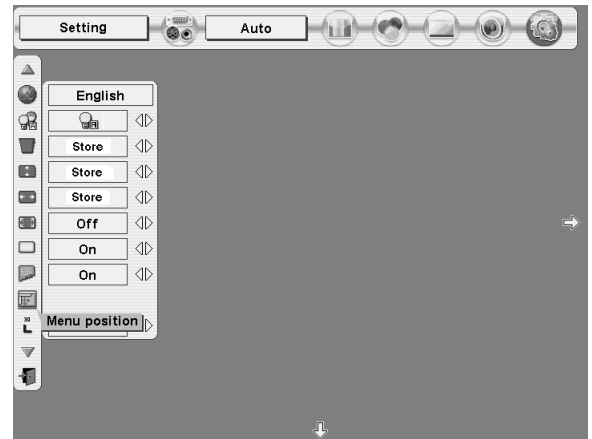
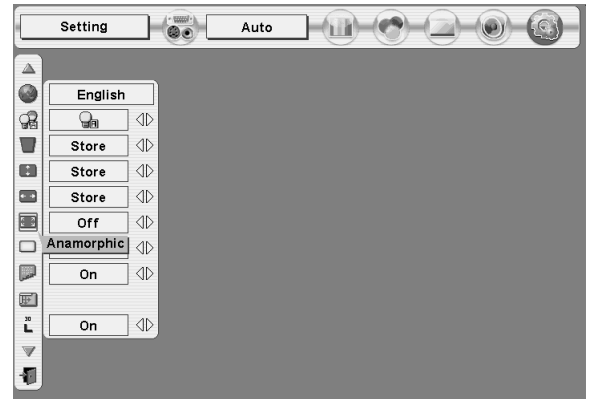
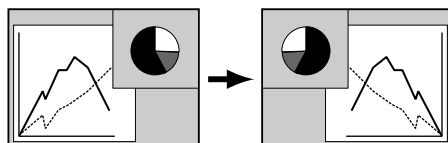

Press SELECT at this icon to display other items.

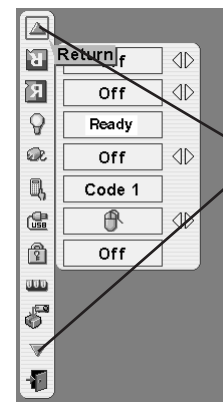

Press SELECT at this icon to display previous items.



## Power management

This projector is equipped with a power management function. When the input signal is interrupted and no buttons are pressed for 30 seconds or more, the power management function turns off the lamp to reduce power consumption and conserve lamp operating time. The factory default settings for power management are "Ready" and "5 Min".

### OPERATION

- 1) If the input signal is interrupted and no buttons are pressed for 30 seconds or more, the message "No signal" and a count-down timer appears on the screen.

#### If "Ready" is selected

- 2) When the count-down is complete, the lamp shuts off and the fans continue to run to cool off the lamp. The READY indicator is off during cool-down, and the projector cannot be operated.
- 3) When the cool-down is complete, the READY indicator starts flashing to notify the operator that power management mode is active. In this condition, the projector will turn on automatically if it detects an input or if the projector is operated.

#### If "Shut down" is selected

- 2) When the count-down is complete, the lamp shuts off and the fans continue to run to cool off the lamp. The READY indicator is off during cool-down, and the projector cannot be operated.
- 3) When the cool-down is complete, the projector shuts down and will not come on automatically.

#### If "Off" is selected

The power management function is canceled.



## On start

When this function is "On," the projector will automatically turn on when power is applied.

Note ; Be sure to turn projector off properly (refer to section "TURNING OFF PROJECTOR" on P20). If projector is turned off in wrong steps, On Start function does not operate properly.



## Remote control

This projector has eight different remote control codes; the factory-set normal code (Code 1) and seven additional codes (Code 2 to Code 8). This switching function allows several projectors in the same area to be controlled via remote control without interfering with each other.

For example, if operating projector in "Code 7," both projector and Remote Control must be switched to "Code 7."

### To change the code of Projector;

To change the Remote control code of the projector use the ON-SCREEN MENU to select from Code 1 to 8.

### To change the code of the Remote Control;

To change the remote control code of the Remote Control, set the DIP switches 1-3 inside the battery compartment box of the Remote Control. (Refer to P15.)

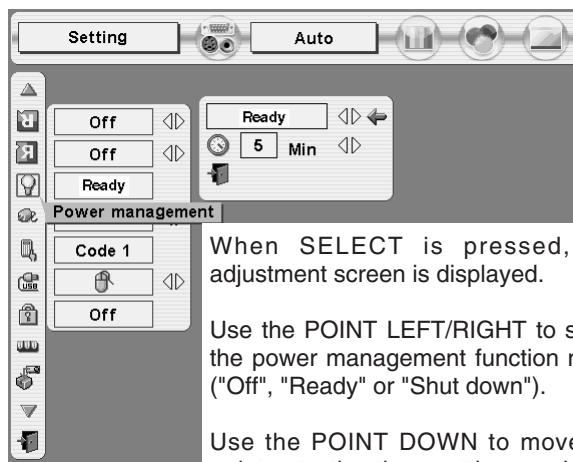

When SELECT is pressed, the adjustment screen is displayed.

Use the POINT LEFT/RIGHT to select the power management function mode ("Off", "Ready" or "Shut down").

Use the POINT DOWN to move the pointer to the time setting, and then use the POINT LEFT/RIGHT to set the time (1 minute to 30 minutes).



Time left until Lamp off.

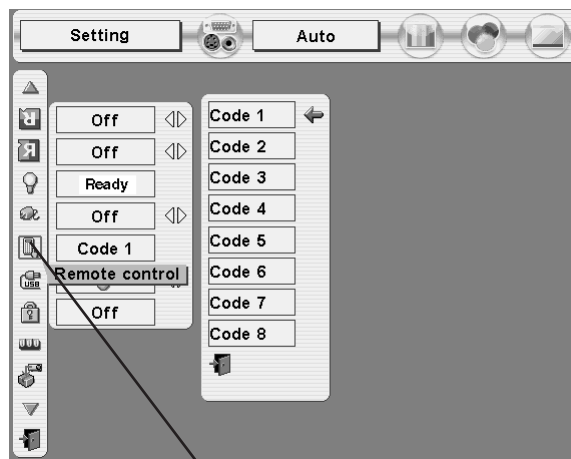

When pressing SELECT at Remote control, Remote control code Menu appears.





## USB

This Projector is equipped with a USB port for either wireless mouse operation or projector control. Set the mode using the steps below.

### Wireless Mouse mode

Select "  " when controlling a computer with Remote Control of this projector.

### Projector mode

Select "  " when controlling a projector with computer.

**NOTE:** Projector Mode is for future use.

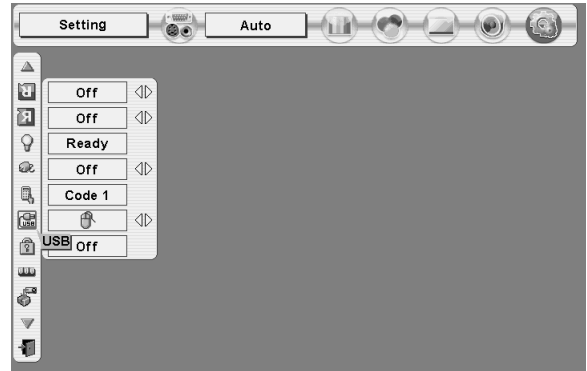

## Key lock

This function locks the operation of the projector's control panel and the remote control.

 This locks operation of the projector's control panel.

 This locks operation of the remote control.

**Off** This cancels the Key lock function.

If the projector's control panel accidentally becomes locked and you do not have the remote control nearby, disconnect the AC cord to turn off the power, and then while pressing the SELECT, reinsert the AC cord. This will cancel the projector's control panel lock.

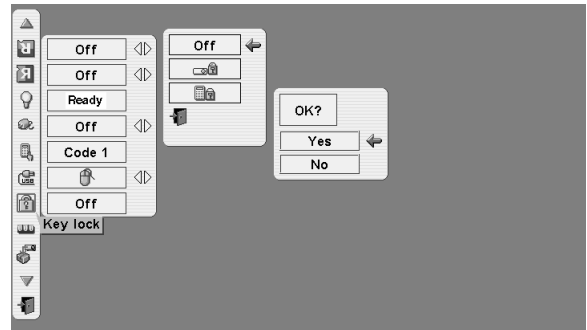

## Lamp counter reset

This function is used to reset Lamp Replace Counter. When replacing Projection Lamp, reset Lamp Replace Counter by using this function. Refer to page 45 for operation.



## Factory default

This function returns all setting values except for the lamp counter to the factory default settings.

Press POINT UP/DOWN to move the red frame pointer to "Factory default" and then press SELECT. The message "Return to Factory default?" is displayed. Move the pointer to [Yes] and then press SELECT.

Another confirmation dialog box appears select [Yes] and then press SELECT.

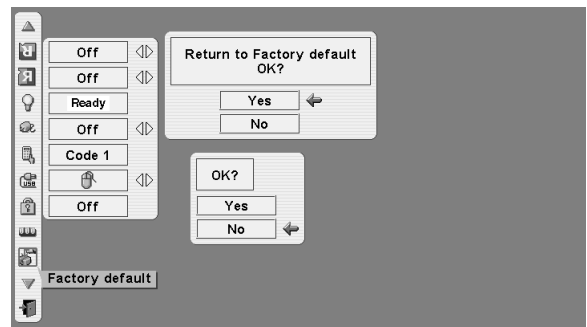

## OPERATING WIRELESS MOUSE

The Wireless Remote Control not only operates the projector but can also function as a wireless mouse for most Personal Computers. The POINT, drag ON/OFF and two CLICK are used for wireless mouse operation.

This Wireless Mouse function is available only when PC mouse pointer is displayed on a projected screen.

### INSTALLATION

To use Wireless Remote Control as Wireless Mouse for a Personal Computer, installation of the mouse driver (not supplied) is required. Make sure that the mouse driver is properly installed in your computer. And make sure that the mouse port (or USB port) of a Personal Computer is activated.

- 1 Connect the mouse port (or USB port) of your computer to Control Port (or USB connector) of this projector with Control Cable (or USB cable). (Refer to page 12, 13 for connection.)
- 2 Turn the projector on first, and then turn on your computer. When the computer is switched on first, Wireless Mouse may not work properly.

Note : When your computer has no mouse port, connect Serial Port of your computer to Control Port of the projector with Control Cable for Serial Port (supplied).

### OPERATING WIRELESS MOUSE

Use the POINT, Drag ON/OFF, LEFT CLICK and RIGHT CLICK on the Remote Control to control the mouse functions on your computer.

#### POINT button

Used to move PC mouse pointer. The pointer is moved corresponding with the direction you are pressing.

#### LEFT CLICK button

This button has the same function as the left button in a PC mouse. Press this button and the POINT button to drag a selected screen object.

#### RIGHT CLICK button

This button has the same function as the right button in a PC mouse.

#### DRAG ON/OFF button

Use this button and the POINT to drag a selected screen object. Press and release the Drag ON/OFF, DRAG ON INDICATOR lights green and the remote control is in Drag mode. Use the POINT in the direction that you want to drag the screen object. Press and release the Drag ON/OFF again or press any other button, to drop the object at the new screen location.

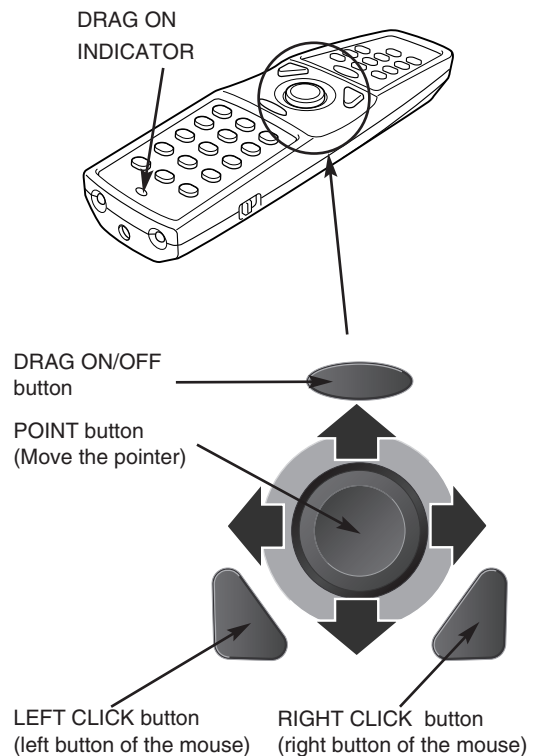

# MAINTENANCE

## WARNING TEMP. INDICATOR

The Warning Temp. Indicator flashes red to let you know the internal temperature of the projector exceeds the normal level. If the temperature goes up further, the projector will be turned off automatically and the Ready indicator will go out. (The Warning Temp. Indicator continues flashing.) After the cooling-off period, the Ready Indicator lights again and the projector can be turned on by pressing the On/Off button on the remote control or on the top control. When you turn on the projector, the Warning Temp. Indicator will go out.

If the Warning Temp. Indicator is still flashing, check the following;

- 1** Ventilation Slots of a projector may be blocked. In such an event, reposition projector so that Ventilation Slots are not obstructed.
- 2** Air Filter may be clogged with dust particles. Clean Air Filter by following section AIR FILTER CARE AND CLEANING on next page.
- 3** If WARNING TEMP. Indicator remains on after performing above checks, Cooling Fans or Internal Circuits may be malfunctioning. Contact your dealer or Boxlight Technical Support.

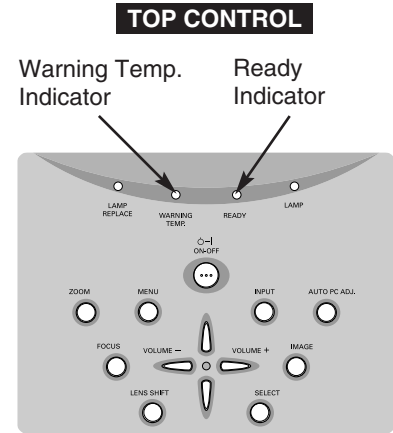

### When both of the Warning Temp. and Ready indicators are flashing:

When the projector detects an internal problem, it will shut down automatically and both the Warning temp. and Ready Indicators flash. In this condition, the projector cannot be turned on even if you press the On/Off on the remote control or on the top control. If this case happens, disconnect and reconnect the AC power cord, and then turn on the projector again to check its operation. If the projector shuts down again or fails to turn on, the projector will need to be repaired. Disconnect the AC power cord and contact your dealer or Boxlight Technical Support.

## AIR FILTER CARE AND CLEANING

The Air Filter prevents dust from accumulating on surface of Projection Lens and Projection Mirror. Should the Air Filter become clogged with dust particles, it will reduce Cooling Fans' effectiveness and may result in internal heat build up and adversely affect the life of the projector. Clean the Air Filter following steps below:

- 1 Turn off the projector, and disconnect the AC power cord.
- 2 Turn the projector upside down and remove the 2 Air Filters by pulling latches upward.
- 3 Clean the Air Filters with a brush or wash out dust and particles.
- 4 Replace the Air Filters. Make sure that the Air Filters are fully inserted.



### CAUTION

Do not operate the projector with the Air Filters removed. Dust may accumulate on the LCD Panels and Projection Mirror degrading picture quality.

Do not put anything into the Air Intake Vents. It may result in a projector malfunction.

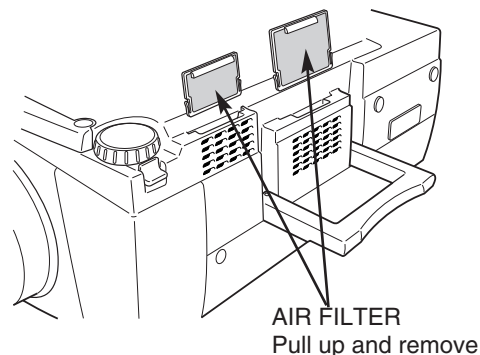

### RECOMMENDATION

**We recommend avoiding dusty/smoky environments when operating the projector. Usage in these environments may cause poor image quality, reduced lamp life, and product malfunctions.**

When using under dusty or smoky conditions, dust may accumulate on the lens, liquid crystal panels, or optical elements inside the projector. This condition may degrade the quality of a projected image.

When above symptoms are noticed, contact a Boxlight Corporation at 1-800-762-5757 or 360-779-7901 for cleaning.

## CLEANING PROJECTION LENS

Follow these steps to clean Projection Lens:

- 1 Apply a non-abrasive camera lens cleaner to a soft, dry cleaning cloth. Avoid using an excessive amount of cleaner. Abrasive cleaners, solvents or other harsh chemicals might scratch the lens.
- 2 Lightly wipe the cleaning cloth over the Projection Lens.
- 3 When the projector is not in use, replace the Lens Cover.

# LAMP REPLACEMENT

## LAMP REPLACE

When the life of the Projection Lamp draws to an end, the LAMP REPLACE indicator lights yellow. If this indicator lights yellow, replace the projection lamp with a new one promptly.

This indicator lights yellow when the life of the projection lamp draws to an end. Replace the Projection Lamp with a new one promptly.

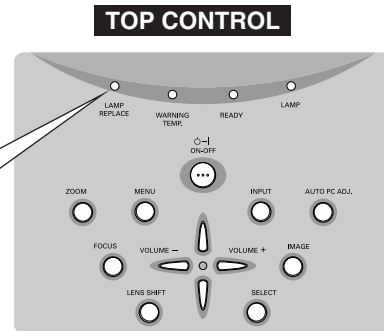

Allow the projector to cool for at least 45 minutes before you open the Lamp Cover. The inside of the projector can become very hot.



## CAUTION

For continued safety, replace with the lamp assembly of the same type. Do not drop the lamp assembly or touch the glass bulb! The glass can shatter and may cause injury.

Follow these steps to replace the lamp assembly.

- 1 Turn off the projector and disconnect AC plug. Allow the projector to cool for at least 45 minutes.
- 2 Loosen 2 screws with a screwdriver and open Lamp Cover.
- 3 Loosen 2 screws with a screwdriver and pull out Lamp Assembly by grasping Handle.
- 4 Replace Lamp Assembly with a new one and tighten screws. Make sure the Lamp Assembly is set properly. Replace Lamp Cover and tighten screws.
- 5 Connect AC Power Cord to projector and turn it on.
- 6 Reset Lamp Replace Counter (refer to next page "Lamp Replace Counter" section).

**NOTE :** Do not reset Lamp Replace Counter when Projection Lamp is not replaced.

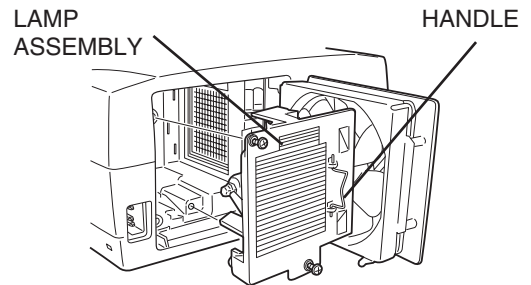
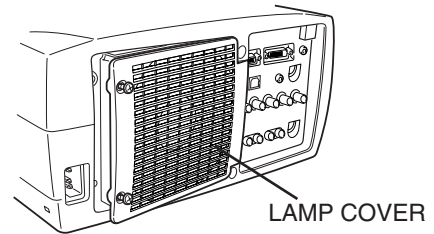

### ORDER REPLACEMENT LAMP

Replacement Lamp can be ordered through Boxlight Corporation at 1-800-762-5757 or 360-779-7901. When ordering Projection Lamp, give following information to dealer.

- **Model No. of your projector** : **BOXLIGHT MP-45t**
- **Replacement Lamp Type No.** : **POA-LMP67**

(Service Parts No. 610 306 5977)

## LAMP REPLACE COUNTER

Be sure to reset the Lamp Replace Counter after the Lamp Assembly is replaced. When the Lamp Replace Counter is reset, the LAMP REPLACE Indicator stops lighting.

- 1 Turn projector on, press MENU and ON-SCREEN MENU will appear. Press POINT LEFT/RIGHT to move the red frame pointer to SETTING (refer to page 40).
- 2 Press POINT UP/DOWN to move the red frame pointer to "Lamp counter reset" and then press SELECT. The message "Lamp replace counter reset?" is displayed. Move the pointer to [Yes] and then press SELECT.
- 3 Another confirmation dialog box appears and select [Yes] to reset Lamp Replace Counter.

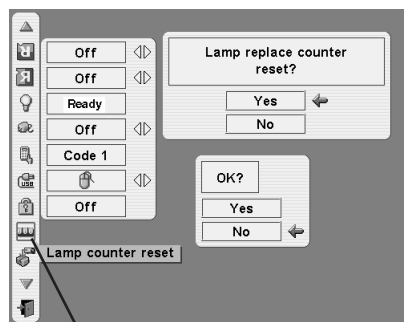

Move the pointer to Lamp counter reset and then press SELECT. The message "Lamp replace counter reset?" is displayed.

**NOTE :** Do not reset the Lamp Replace Counter until after the Projection Lamp is replaced.



## LAMP HANDLING PRECAUTIONS

This projector uses a high-pressure lamp which must be handled carefully and properly. Improper handling may result in accidents, injury, or create a fire hazard.

- Lamp lifetime may differ from lamp to lamp and according to the environment of use. There is no guarantee of the same lifetime for each lamp. Some lamps may fail or terminate their lifetime in a shorter period of time than other similar lamps.
- If the projector indicates that the lamp should be replaced, i.e., if the LAMP REPLACE INDICATOR lights up, replace the lamp with a new one IMMEDIATELY after the projector has cooled down. ( Follow carefully the instructions in the LAMP REPLACEMENT section of this manual. ) Continuous use of the lamp with the LAMP REPLACE INDICATOR lighted may increase the risk of lamp explosion.
- A Lamp may explode as a result of vibration, shock or degradation as a result of hours of use as its lifetime draws to an end. Risk of explosion may differ according to the environment or conditions in which the projector and lamp are being used.

### IF A LAMP EXPLODES, THE FOLLOWING SAFETY PRECAUTIONS SHOULD BE TAKEN.

If a lamp explodes, disconnect the projector's AC plug from the AC outlet immediately. Contact an authorized service station for a checkup of the unit and replacement of the lamp. Additionally, check carefully to ensure that there are no broken shards or pieces of glass around the projector or coming out from the cooling air circulation holes. Any broken shards found should be cleaned up carefully. No one should check the inside of the projector except those who are authorized trained technicians and who are familiar with projector service. Inappropriate attempts to service the unit by anyone, especially those who are not appropriately trained to do so, may result in an accident or injury caused by pieces of broken glass.

# TROUBLESHOOTING

Before calling your dealer or service center for assistance, check the following.

1. Make sure the projector is connected to your computer or video equipment as described in section "CONNECTING PROJECTOR" on pages 12 ~ 14.
2. Check cable connections. Verify that all computer, video and power cords are properly connected.
3. Verify that all power is switched on.
4. If the projector still does not produce an image, re-start your computer.
5. If an image still does not appear, unplug the projector from your computer and check your computer monitor display. Problem may be with your graphics controller rather than with the projector. (When you reconnect the projector, be sure to turn the computer and monitor off before you power up the projector. Power equipment back on in this order: Projector then computer.)
6. If problem still exists, check following chart.

Problem:	Try these Solutions
<b>No power.</b>	<ul style="list-style-type: none"> <li>● Plug the projector into your AC outlet.</li> <li>● Make sure READY Indicator lights.</li> <li>● Wait 90 seconds after the projector is turned OFF before turning a projector back on.</li> </ul> <p>NOTE : After pressing Power ON-OFF button to OFF, make sure a projector works as follows:</p> <ol style="list-style-type: none"> <li>1. LAMP indicator lights bright and READY indicator turns off.</li> <li>2. After 90 seconds, READY indicator lights green again and a projector may be turned on by pressing Power ON-OFF button.</li> </ol> <ul style="list-style-type: none"> <li>● Check WARNING TEMP. and READY indicator. If both WARNING TEMP. and READY indicator are flashing, the projector cannot be turned on. (See "TURNING ON/OFF PROJECTOR" section on page 20.)</li> <li>● Check Projection Lamp. (Refer to page 44.)</li> </ul>
<b>Image is out of focus.</b>	<ul style="list-style-type: none"> <li>● Adjust the focus.</li> <li>● Make sure the projection screen is at least 4.6' (1.4m) from the projector.</li> <li>● Check Projection Lens to see if it needs cleaning.</li> </ul> <p>NOTE : Moving a projector from a cool temperature location to a warm temperature location may result in moisture condensation on Projection Lens. In such an event, leave the projector OFF and wait until condensation disappears.</p>
<b>Picture is Left/Right reversed.</b>	<ul style="list-style-type: none"> <li>● Check Ceiling/Rear feature. (See "SETTING" section on page 38.)</li> </ul>
<b>Picture is Top/Bottom reversed.</b>	<ul style="list-style-type: none"> <li>● Check Ceiling feature. (See "SETTING" section on page 38.)</li> </ul>
<b>Some displays are not seen during Operation.</b>	<ul style="list-style-type: none"> <li>● Check Display feature. (See "SETTING" section on page 38.)</li> </ul>
<b>No image.</b>	<ul style="list-style-type: none"> <li>● Check connection between your computer or video equipment and the projector.</li> <li>● When turning the projector on, it takes about 30 seconds to display an image.</li> <li>● Check that the selected system corresponds with your computer or video equipment.</li> <li>● Make sure temperature is not out of Operating Temperature (5°C ~ 35°C).</li> </ul>
<b>No sound.</b>	<ul style="list-style-type: none"> <li>● Check audio cable connection from audio input source.</li> <li>● Adjust audio source.</li> <li>● Press VOLUME (+) button.</li> <li>● Press MUTE button.</li> </ul>

Problem:	Try these Solutions
<b>Remote Control does not work.</b>	<ul style="list-style-type: none"> <li>● Check batteries.</li> <li>● Check ALL-OFF switch on Remote Control is set to "ON".</li> <li>● Make sure nothing is between Infrared Remote Receiver and Remote Control.</li> <li>● Make sure you are not too far from a projector when using Remote Control. Maximum operating range is 16.4' (5m).</li> <li>● Check transmitted signal mode from Remote Control. (See "SETTING" section on page 39.)</li> </ul>
<b>Wireless Mouse function does not work.</b>	<ul style="list-style-type: none"> <li>● Check cable connection between the projector and your computer.</li> <li>● Check mouse setting on your computer.</li> <li>● Turn the projector on before turning on the computer.</li> </ul>

## SERVICE

**WARNING: High voltages are used to operate this projector. Do not attempt to open the cabinet.**

Boxlight Service is easily obtained. If after following instructions above, you find that service is necessary, contact Boxlight for assistance at 1-800-762-5757 or 360-779-7901.

Give the model number and explain the difficulty. We will advise you how to obtain service.

Please have the following information available:

- Serial Number of Projector.
- Resolution of Computer.
- Refresh rate of Computer.



This symbol on the nameplate means the product is Listed by Underwriters Laboratories Inc. It is designed and manufactured to meet rigid U.L. safety standards against risk of fire, casualty and electrical hazards.



The CE Mark is a Directive conformity mark of the European Community (EC).



INDICATORS AND PROJECTOR CONDITION

Check the Indicators for projector condition.

Indicators				Projector Condition
LAMP REPLACE yellow	WARNING TEMP. red	READY green	LAMP red	
●	●	●	●	The projector is OFF. (The AC Power Cord is unplugged.)
*	●	○	○	The projector is READY to be turned on with the POWER ON-OFF button.
*	●	○	●	The projector is operating normally.
*	○ <sup>⚡</sup>	●	○	The Warning Temp. Indicator flashes red to let you know the internal temperature of the projector exceeds the normal level. If the temperature goes up further, the projector will be turned off automatically and the Ready indicator will go out. When the projector is cooled down enough and the temperature returns to normal, the READY indicator lights green and the projector can be turned on. (The WARNING TEMP. indicator keeps flashing.) Check and clean the Air Filter.
*	○ <sup>⚡</sup>	○	○	The projector is cooled down enough and the temperature returns to normal. When turning on the projector, the WARNING TEMP. indicator stops flashing. Check and clean the Air Filter.
*	●	●	○	The projector is being cooled down. It cannot be turned on until the READY indicator lights green.
*	○ <sup>⚡</sup>	○ <sup>⚡</sup>	○	The projector has detected an abnormal condition and cannot be turned on. Unplug the AC Power Cord and plug it again to turn on the projector. If the projector is turned off again, disconnect the AC Power Cord and contact the dealer or the service center for service and checkup. Do not leave the projector on. It may cause electric shock or a fire hazard.
*	●	○ <sup>⚡</sup>	●	The projector is in the Power management mode.

○ ●●● on    ○<sup>⚡</sup> ●●● flashing    ● ●● dim    ● ●● off

\* When the life of the projection lamp draws to an end, the LAMP REPLACE indicator lights yellow. When this indicator lights yellow, replace the projection lamp with a new one promptly. Reset the Lamp Replace Counter after replacement of the lamp.

## COMPATIBLE COMPUTER SPECIFICATIONS

Basically this projector can accept a signal from all computers with V, H-Frequency mentioned below and less than 180 MHz of Dot Clock.

ON-SCREEN DISPLAY	RESOLUTION	H-Freq. (kHz)	V-Freq. (Hz)	ON-SCREEN DISPLAY	RESOLUTION	H-Freq. (kHz)	V-Freq. (Hz)
VGA 1	640 x 480	31.47	59.88	XGA 10	1024 x 768	62.04	77.07
VGA 2	720 x 400	31.47	70.09	XGA 11	1024 x 768	61.00	75.70
VGA 3	640 x 400	31.47	70.09	XGA 12	1024 x 768 (Interlace)	35.522	43.48
VGA 4	640 x 480	37.86	74.38	XGA 13	1024 x 768	46.90	58.20
VGA 5	640 x 480	37.86	72.81	XGA 14	1024 x 768	47.00	58.30
VGA 6	640 x 480	37.50	75.00	XGA15	1024 x 768	58.03	72.0
VGA 7	640 x 480	43.269	85.00	MAC 19	1024 x 768	60.24	75.08
MAC LC13	640 x 480	34.97	66.60	MAC 21	1152 x 870	68.68	75.06
MAC 13	640 x 480	35.00	66.67	SXGA 1	1152 x 864	64.20	70.40
480p	(Progressive)	31.47	59.88	SXGA 2	1280 x 1024	62.50	58.60
575p	(Progressive)	31.25	50.00	SXGA 3	1280 x 1024	63.90	60.00
480i	(Interlace)	15.734	30.00	SXGA 4	1280 x 1024	63.34	59.98
575i	(Interlace)	15.625	25.00	SXGA 5	1280 x 1024	63.74	60.01
SVGA 1	800 x 600	35.156	56.25	SXGA 6	1280 x 1024	71.69	67.19
SVGA 2	800 x 600	37.88	60.32	SXGA 7	1280 x 1024	81.13	76.107
SVGA 3	800 x 600	46.875	75.00	SXGA 8	1280 x 1024	63.98	60.02
SVGA 4	800 x 600	53.674	85.06	SXGA 9	1280 x 1024	79.976	75.025
SVGA 5	800 x 600	48.08	72.19	SXGA 10	1280 x 960	60.00	60.00
SVGA 6	800 x 600	37.90	61.03	SXGA 11	1152 x 900	61.20	65.20
SVGA 7	800 x 600	34.50	55.38	SXGA 12	1152 x 900	71.40	75.60
SVGA 8	800 x 600	38.00	60.51	SXGA 13	1280 x 1024 (Interlace)	50.00	43.00
SVGA 9	800 x 600	38.60	60.31	SXGA 14	1280 x 1024 (Interlace)	50.00	47.00
SVGA 10	800 x 600	32.70	51.09	SXGA 15	1280 x 1024	63.37	60.01
SVGA 11	800 x 600	38.00	60.51	SXGA 16	1280 x 1024	76.97	72.00
MAC 16	832 x 624	49.72	74.55	SXGA 17	1152 x 900	61.85	66.00
XGA 1	1024 x 768	48.36	60.00	SXGA 18	1280 x 1024 (Interlace)	46.43	43.35
XGA 2	1024 x 768	68.677	84.997	SXGA 19	1280 x 1024	63.79	60.18
XGA 3	1024 x 768	60.023	75.03	SXGA 21	1400 x 1050	63.9	60.00
XGA 4	1024 x 768	56.476	70.07	MAC	1280 x 960	75.00	75.08
XGA 5	1024 x 768	60.31	74.92	MAC	1280 x 1024	80.00	75.08
XGA 6	1024 x 768	48.50	60.02	720p (HDTV)	(Progressive)	45.00	60.00
XGA 7	1024 x 768	44.00	54.58	1035i (HDTV)	(Interlace)	33.75	30.00
XGA 8	1024 x 768	63.48	79.35	1080i (HDTV)	(Interlace)	33.75	30.00
XGA 9	1024 x 768 (Interlace)	36.00	43.59	1080i (HDTV)	(Interlace)	28.125	25.00

When an input signal is digital from DVI terminal, refer to chart below.

ON-SCREEN DISPLAY	RESOLUTION	H-Freq. (kHz)	V-Freq. (Hz)	ON-SCREEN DISPLAY	RESOLUTION	H-Freq. (kHz)	V-Freq. (Hz)
D-VGA	640 x 480	31.47	59.94	D-SXGA2	1280 x 1024	60.276	58.069
D-480p	720 x 480 (Progressive)	31.47	59.94	D-SXGA3	1280 x 1024	31.65	29.8
D-575p	768 x 575 (Progressive)	31.25	50.00	D-720p	1280 x 720 (Progressive)	45.00	60.00
D-SVGA	800 x 600	37.879	60.32	D-1035i	1920 x 1035 (Interlace)	33.75	30.00
D-XGA	1024 x 768	43.363	60.00	D-1080i	1920 x 1080 (Interlace)	33.75	30.00
D-SXGA1	1280 x 1024	63.98	60.02	D-1080i	1920 x 1080 (Interlace)	28.125	25.00

**NOTE :** Specifications are subject to change without notice.

MENU TREE

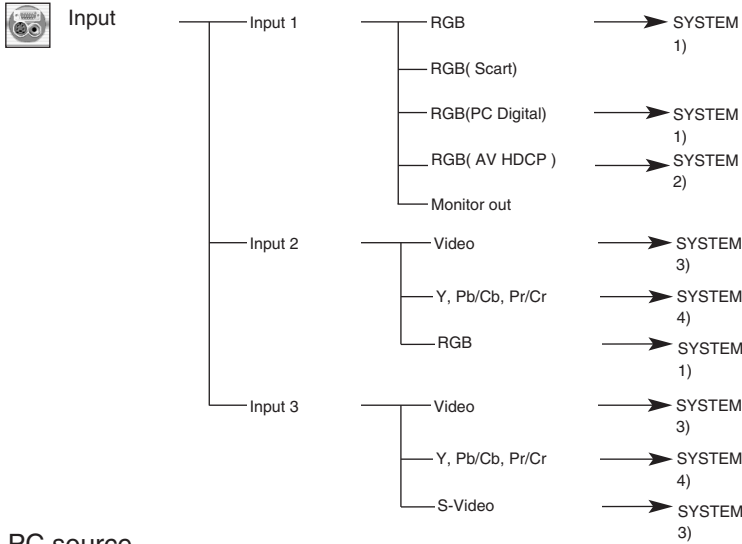

PC source

Video source

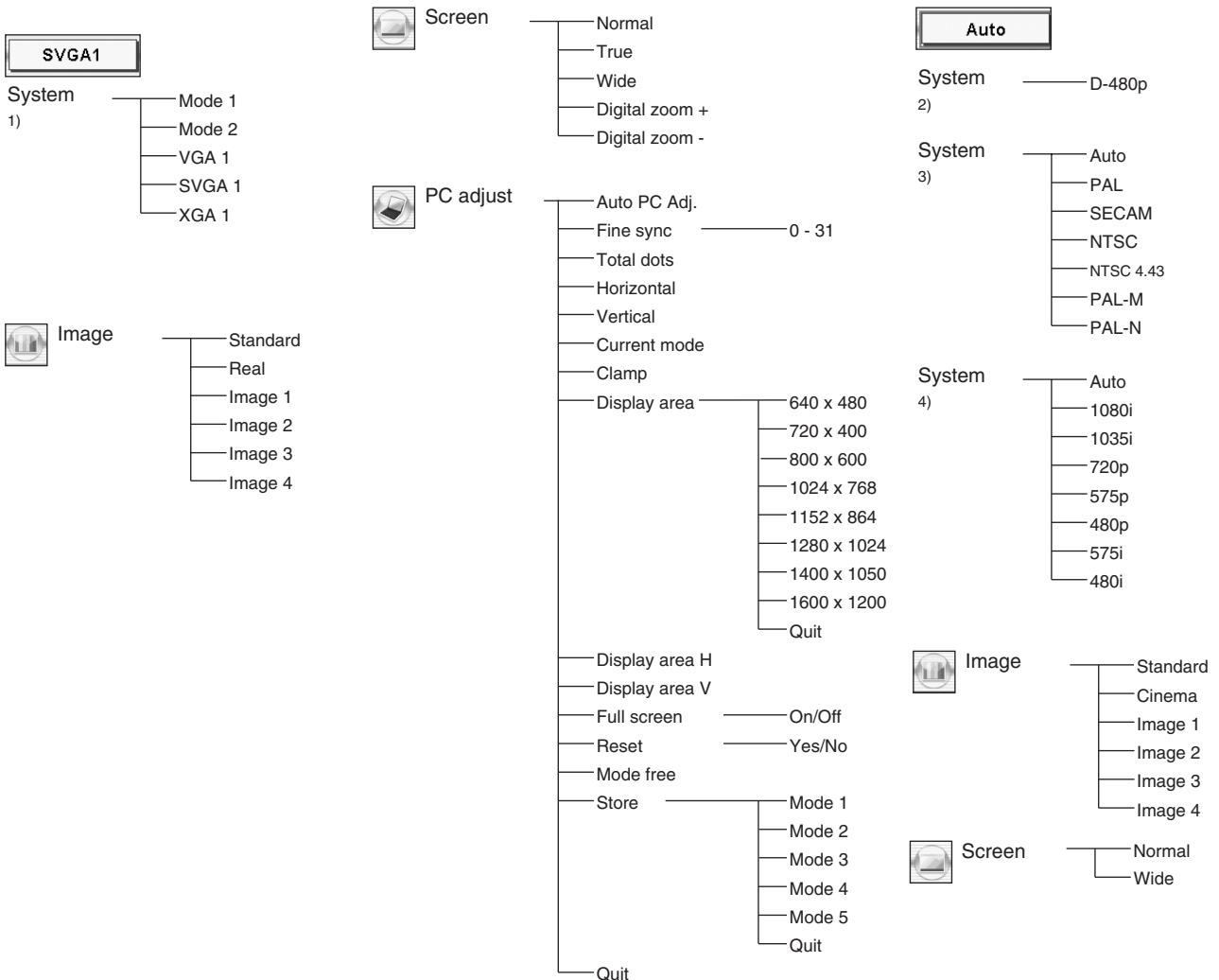



Setting

- Language
  - English
  - German
  - French
  - Italian
  - Spanish
  - Portuguese
  - Dutch
  - Swedish
  - Russian
  - Chinese
  - Korean
  - Japanese
  - Quit
- Lamp mode — Normal/Auto/Eco
- Keystone — Store/Reset
- Aspect V — Store/Reset
- Aspect H — Store/Reset
- Anamorphic — On/Off
- Blue back — On/Off
- Display — On/Off
- Menu position
- Logo — On/Off
- Ceiling — On/Off
- Rear — On/Off
- Power management — Off/Ready/Shut down
- On start — On/Off
- Remote control code
  - Code 1
  - Code 2
  - Code 3
  - Code 4
  - Code 5
  - Code 6
  - Code 7
  - Code 8
  - Quit
- USB
  - Mouse
  - Projector
- Key lock
  - Off
  - Control panel
  - Remote control
- Lamp counter reset — Yes/No
- Factory default — Yes/No

Image adjust

- Contrast — 0 - 63
- Brightness — 0 - 63
- Color — 0 - 63
- Tint — 0 - 63
- Color management — 0 - 63
- Auto picture control — Off/L1/L2
- Color temp. — XLow/Low/Mid/High
- Red — 0 - 63
- Green — 0 - 63
- Blue — 0 - 63
- Sharpness — 0 - 31
- Gamma — 0 - 15
- Noise reduction — On/Off
- Progressive — Off/L1/L2
- Reset — Yes/No
- Store
  - Image 1
  - Image 2
  - Image 3
  - Image 4
  - Quit
- Quit

- Scale
- Position
- Scale
- Position

Sound

- Volume — 0 - 63
- Built-in SP. — On/Off
- Mute — On/Off
- Quit

## TECHNICAL SPECIFICATIONS

<b>Projector Type</b>	Multi-media Projector
<b>Dimensions (W x H x D)</b>	12.6" x 6.6" x 18.5" (319 mm x 168 mm x 470 mm)
<b>Net Weight</b>	20.3 lbs (9.2 kg)
<b>LCD Panel System</b>	1.3" TFT Active Matrix type, 3 panels
<b>Panel Resolution</b>	1024 x 768 dots
<b>Number of Pixels</b>	2,359,296 (1024 x 768 x 3 panels)
<b>Color System</b>	PAL, SECAM, NTSC, NTSC4.43, PAL-M and PAL-N
<b>High Definition TV Signal</b>	480i, 480p, 575i, 575p, 720p, 1035i and 1080i
<b>Scanning Frequency</b>	H-sync. 15 ~ 100 KHz, V-sync. 50 ~ 100 Hz
<b>Projection Lens</b>	F1.7 ~ 2.0 lens with f=48.2 mm ~ 62.6 mm Motor zoom and focus
<b>Throw distance</b>	4.6' (1.4 m) ~ 48.3' (14.7 m)
<b>Motorized Lens Shift</b>	Up and Down
<b>Projection Image Size (Diagonal)</b>	Adjustable from 31" to 400"
<b>Horizontal Resolution</b>	800 TV lines (HDTV)
<b>Projection Lamp</b>	300 watt type
<b>Input 1/Monitor Output Jacks</b>	DVI Terminal (Digital) HDCP Compatible, HDB 15-pin Terminal (Analog) and Stereo Mini Type Jack (Audio)
<b>Input 2 Jacks</b>	BNC Type x 5 (G or VIDEO/Y, B or Cb/Pb, R or Cr/Pr, H and V), Stereo Mini Type Jack (Audio)
<b>Input 3 Jacks</b>	RCA Type x 3 (VIDEO/Y, Cb/Pb and Cr/Pr), RCA Type x 2 (Audio R and L) and DIN 4-pin (S-Video)
<b>Other Jacks</b>	DIN 8-pin (Control port), USB port (Series B receptacle) and Wired Remote Jack
<b>Built-in Speakers</b>	INT. SP. Stereo (R and L), 2 watt RMS (T.H.D. 10%)
<b>Feet Adjustment</b>	0° to 10.5°
<b>Voltage and Power Consumption</b>	AC 100 ~ 120 V (5.0 A Max. Ampere), 50 / 60 Hz (The U.S.A and Canada) AC 200 ~ 240 V (2.5 A Max. Ampere), 50 / 60 Hz (Continental Europe)
<b>Operating Temperature</b>	41 °F ~ 95 °F (5 °C ~ 35 °C)
<b>Storage Temperature</b>	14 °F ~ 140 °F (-10 °C ~ 60 °C)
<b>Remote Control Transmitter</b>	Power Source : AA, UM3 or R06 Type x 2 Operating Range : 16.4' (5m) / ±30° Dimensions : 2.0" x 1.4" x 7.6" (50mm x 36mm x 193mm) Net Weight : 0.35 lbs (160 g) (including batteries) Laser Pointer : Class II Laser (Max. Output : 1mW / Wave length : 650±20nm)
<b>Accessories</b>	User's Guide AC Power Cord Wireless/Wired Remote Control Transmitter and Batteries Remote Control Cable VGA Cable USB Cable Control Cable for Serial port Protective Dust Cover Lens Cover

- Specifications are subject to change without notice.
- LCD panels are manufactured to the highest possible standards. Even though 99.99% of the pixels are effective, a tiny fraction of the pixels (0.01% or less) may be ineffective by the characteristics of the LCD panels.

## CONFIGURATIONS OF TERMINALS

### COMPUTER INPUT-1 and MONITOR OUT TERMINALS (ANALOG)

Terminal : HDB15-PIN

**Pin Configuration**

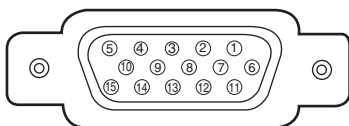

1	Red Input	9	+5V Power
2	Green Input	10	Ground (Vert.sync.)
3	Blue Input	11	Sense 0
4	Sense 2	12	DDC Data
5	Ground (Horiz.sync.)	13	Horiz. sync.
6	Ground (Red)	14	Vert. sync.
7	Ground (Green)	15	DDC Clock
8	Ground (Blue)		

### COMPUTER INPUT-1 TERMINAL (DIGITAL)

Terminal : DVI 24-pin

**Pin Configuration**

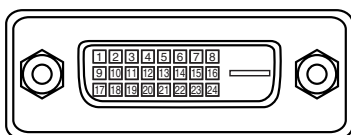

1	T.M.D.S. Data2-	9	T.M.D.S. Data1-	17	T.M.D.S. Data0-
2	T.M.D.S. Data2+	10	T.M.D.S. Data1+	18	T.M.D.S. Data0+
3	T.M.D.S. Data2 Shield	11	T.M.D.S. Data1 Shield	19	T.M.D.S. Data0 Shield
4	No Connect	12	No Connect	20	No Connect
5	No Connect	13	No Connect	21	No Connect
6	DDC Clock	14	+5V Power	22	T.M.D.S. Clock Shield
7	DDC Data	15	Ground (for +5V)	23	T.M.D.S. Clock+
8	No Connect	16	Hot Plug Detect	24	T.M.D.S. Clock-

### CONTROL PORT CONNECTOR

Terminal : Mini DIN 8-PIN

**Pin Configuration**

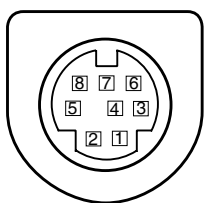

	PS/2	Serial	ADB
1	----	R X D	----
2	CLK	----	ADB
3	DATA	----	----
4	GND	GND	GND
5	----	RTS / CTS	----
6	----	T X D	----
7	GND	GND	----
8	----	GND	GND

### USB CONNECTOR (Series B)

**Pin Configuration**

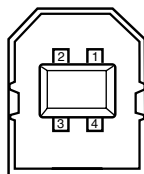

1	Vcc
2	- Data
3	+ Data
4	Ground

## OPTIONAL PARTS

The parts listed below are optionally supplied. When ordering those parts, give the name and Type No. to the sales dealer.

- **Control Cable (PS2 Port)**                      **Type No. : POA-MCPS2**
- **Control Cable (ADB Port)**                    **Type No. : POA-MCMAC**
- **MAC Adapter**                                    **Type No. : POA-MACAP**
- **DVI Cable**                                        **Type No. : KA-DV20**
- **HDB 15 pin-SCART 21 pin Cable**        **Type No. : POA-CA-SCART**
- **Long Zoom Lens**                              **Type No. : LNS-T31A**
- **Ultra Long Zoom Lens**                    **Type No. : LNS-T32**
- **Short Zoom Lens**                              **Type No. : LNS-W31A**
- **Short Fixed Lens**                             **Type No. : LNS-W32**

## LENS REPLACEMENT

The lens of this projector can be replaced with other optional lens which are sold separately. This feature enables you to use the projector for wide variety of uses.

For installation and replacement of the lens, always contact the sales dealer. The projector lens must be installed or replaced by well-trained sales or service engineers. Do not attempt to do by yourself as it may cause injury.

### **To the sales and service engineer;**

Referring to the attached lens replacement and installation manual, replace or install the lens properly.



After installing the lens, attach the lens cap to the lens when setting up the projector.  
Do not hold the lens when carrying or lifting the projector. It may cause serious damage to the projector.





## LIMITED WARRANTY

BOXLIGHT CORPORATION ("BOXLIGHT") warrants that each Boxlight MP-45t ("the Product") sold hereunder will conform to and function in accordance with the written specifications of BOXLIGHT. Said limited warranty shall apply only to the first person or entity that purchases the Product for personal or business use and not for the purpose of distribution or resale. Said warranty shall continue for a period of two (2) years from the date of such purchase. BOXLIGHT does not warrant that the Product will meet the specific requirements of the first person or entity that purchases the Product for personal or business use. Lamp is warranted for 120 days or 500 hours (whichever comes first). Accessories are warranted for 1 year from date of purchase.

BOXLIGHT CORPORATION's liability for the breach of the foregoing limited warranty is limited to the repair or replacement of the Product or refund of the purchase price of the Product, at BOXLIGHT's sole option. To exercise the Purchaser's rights under the foregoing warranty, the Product must be returned at the Purchaser's sole cost and expense, to BOXLIGHT or any authorized service center provided, however, that the Product must be accompanied by a written letter explaining the problem and which includes (i) proof of purchase; (ii) the dealer's name; and (iii) the model and serial number of the Product. **A return authorization number, issued by the BOXLIGHT customer service department, must also be clearly displayed on the outside of the shipping carton containing the Product.**

## WARRANTY LIMITATION AND EXCLUSION

BOXLIGHT CORPORATION shall have no further obligation under the foregoing limited warranty if the Product has been damaged due to abuse, misuse, neglect, accident, unusual physical or electrical stress (unusual physical and electrical stress includes unusually long operation, exposure to smoke and other airborne contaminants), unauthorized modification, tampering, alterations, or service other than by BOXLIGHT or its authorized agents, causes other than from ordinary use or failure to properly use the Product in the application for which said Product is intended.

## DISCLAIMER OR UNSTATED WARRANTIES

The warranty printed above is the only warranty applicable to this purchase.

All other warranties express or implied, including, but not limited to, the implied warranties of merchantability and fitness for a particular purpose are disclaimed. There are no warranties that extend beyond the face hereof and the foregoing warranty shall not be extended, altered or varied except by written instrument signed by BOXLIGHT CORPORATION.

## LIMITATION OF LIABILITY

It is understood and agreed that BOXLIGHT's liability whether in contract, in tort, under any warranty, in negligence or otherwise shall not exceed the return of the amount of the purchase price paid by purchaser and under no circumstances shall BOXLIGHT be liable for special, indirect or consequential damages. The price stated for the Product is a consideration in limiting BOXLIGHT's liability. No action regardless of form, arising out of the agreement to purchase the product may be brought by purchaser more than one year after the cause of action has accrued.



Boxlight  
19332 Powder Hill Place  
Poulsbo, WA 98370-7407 USA  
[www.boxlight.com](http://www.boxlight.com)  
U.S. and Canada 800-762-5757  
International 1-360-779-7901