

***myprojectorlamps.com***

**The most trusted, dependable name  
in projector lamp sales.**



<http://www.myprojectorlamps.com>



<http://www.myprojectorlamps.ca>



<http://www.myprojectorlamps.eu>

The following projector manual has not been modified or altered in any way.



## Declaration of Conformity

Manufacturer: BOXLIGHT, 19332 Powder Hill Place, Poulsbo, Washington USA

We declare under our sole responsibility that the CD-850m projector conforms to the following directives and norms:

EMC Directive 89/336/EEC, Amended by 93/68/EEC

EMC: EN 55022

EN 55024

EN 61000-3-2

EN 61000-3-3

Low Voltage Directive 73/23/EEC, Amended by 93/68/EEC

Safety: EN 60950: 2000

July, 2002

## Trademarks

Apple, Macintosh, and PowerBook are trademarks or registered trademarks of Apple Computer, Inc. IBM is a trademark or registered trademark of International Business Machines, Inc. Microsoft, PowerPoint, and Windows are trademarks or registered trademarks of Microsoft Corporation.

## FCC Warning

This equipment has been tested and found to comply with the limits for a Class A digital device, pursuant to part 15 of the FCC Rules. These limits are designed to provide reasonable protection against harmful interference when the equipment is operated in a commercial environment. This equipment generates, uses, and can radiate radio frequency energy and, if not installed and used in accordance with the instruction manual, may cause harmful interference to radio communications. Operation of this equipment in a residential area is likely to cause harmful interference in which case the user will be required to correct the interference at his own expense.

## Canada

This Class A digital apparatus complies with Canadian ICES-003.

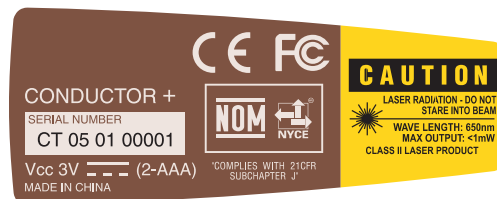
Cet appareil numérique de la classe A est conforme à la norme NMB-003 du Canada.

## Safety Certifications

UL, CUL, TÜV, NOM, IRAM, GOST, CCC

## Remote Control Warning

Laser radiation class II product; wavelength 650nm; maximum output 1mW. Remote control complies with applicable requirements of 21 CFR 1040.10 and 1040.11. Remote control complies with applicable requirements of EN 60 825-1: 1994 +A11.



## Table of Contents

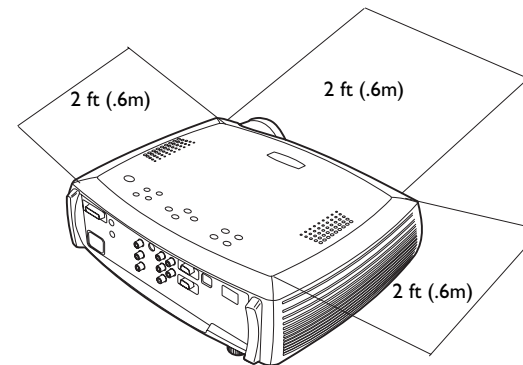
|  |    |
|--|----|
| Introduction                             | 3  |
| Connecting a computer                    | 5  |
| Required computer connections            | 5  |
| Optional computer connections            | 5  |
| Displaying a computer image              | 7  |
| First-time projector use with Windows 98 | 8  |
| Adjusting the image                      | 10 |
| Connecting a video device                | 11 |
| Displaying a video image                 | 12 |
| Shutting down the projector              | 14 |
| Troubleshooting your setup               | 14 |
| Using the keypad buttons                 | 22 |
| Using the remote control                 | 23 |
| Using the audio                          | 24 |
| Optimizing computer images               | 25 |
| Presentation features                    | 25 |
| Optimizing video images                  | 26 |
| Customizing the projector                | 26 |
| Using the menus                          | 27 |
| Picture menu                             | 28 |
| Settings menu                            | 31 |
| Maintenance                              | 34 |
| Cleaning the lens                        | 34 |
| Replacing the projection lamp            | 35 |
| Using the security lock                  | 37 |
| Appendix                                 | 38 |
| Specifications                           | 38 |
| Accessories                              | 38 |
| Projected image size                     | 39 |

If you are experienced in setting up presentation systems, use the *Quick Set Up* card that was included in the carry case. For assistance, call BOXLIGHT at **1-800-762-5757** or **1-360-779-7901**.

### Important Operating Considerations

Do not place the projector on a tablecloth or other soft covering that may block the vents. Vents are placed along the left and right sides of the CD-850m, as well as across the front of the projector. Do not use a non-approved ceiling mount. In the unlikely event of the lamp rupturing, discard any edible items placed in the surrounding area and thoroughly clean the area along the sides and in the front of the projector.

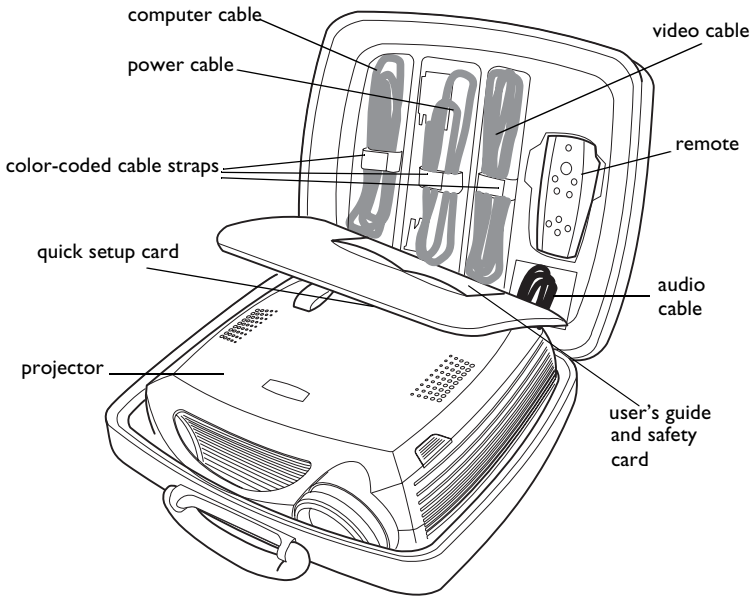
Do not place objects in the areas along the side and in the front of the projector



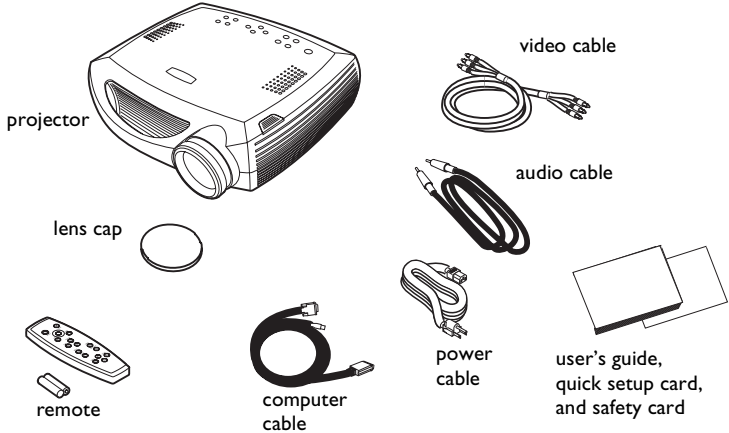
# Introduction

Your new digital projector is easy to connect, easy to use, easy to maintain and has XGA 1024x768 resolution.

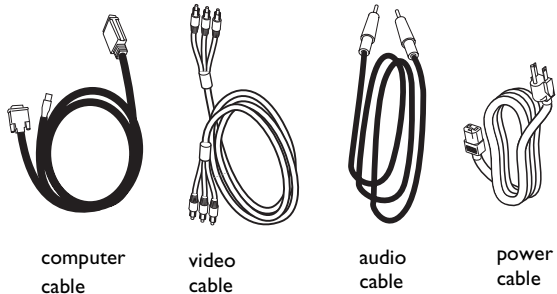
The projector comes in a carry case that offers ample room for BOXLIGHT accessory items such as the projector remote, color-coded cables, and documentation. The color-coded cable straps and cables they contain make your setup experience quick and easy, while the case's design helps you find and put away all items without the fear of anything becoming lost.



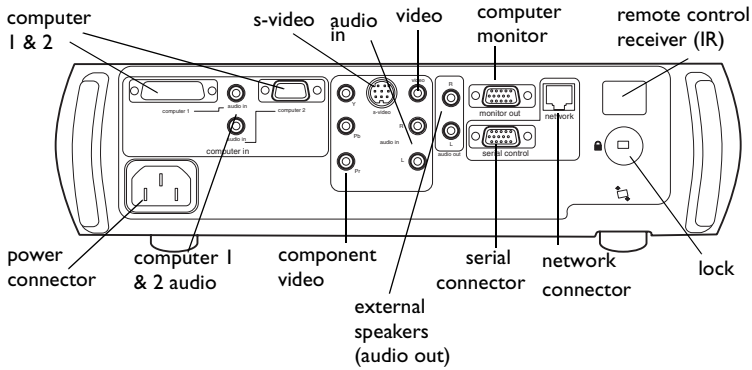
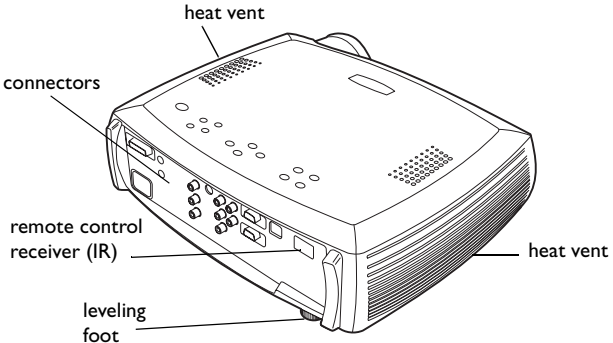
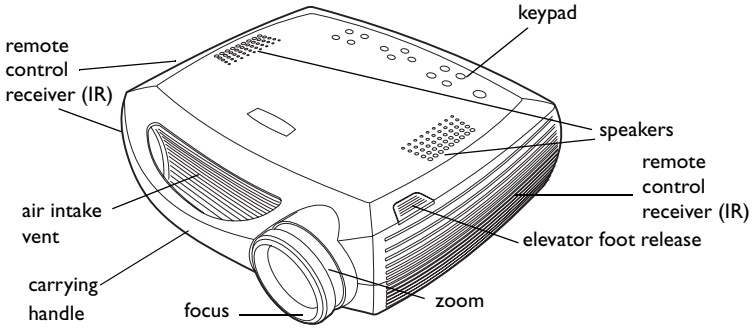
## Included items



## Cables



**Projector components and features**



## Connecting a computer

### Required computer connections

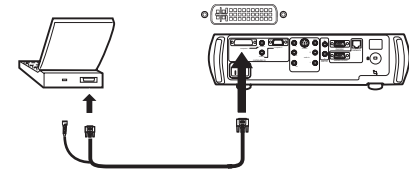
Connect the black end of the computer cable to the **Computer I** connector on the projector. Connect the blue end to the video port on your computer. If you are using a desktop computer, you first need to disconnect the monitor cable from the computer's video port.

Connect the black power cable to the connector on the back of the projector and to your electrical outlet.

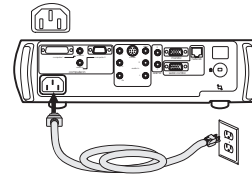
The Power LED on the projector's keypad turns solid green.

**NOTE:** Always use the power cable that shipped with the projector.

connect computer cable



connect power cable

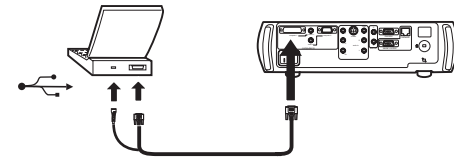


### Optional computer connections

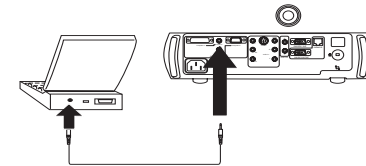
To control your computer's mouse using the projector's remote control, connect the USB connector on the computer cable to the computer. USB drivers must be installed to use the USB feature. For more information, see page 9.

To have sound with your presentation, connect the audio cable to your computer and to the computer **Audio In** connector on the projector.

connect computer cable

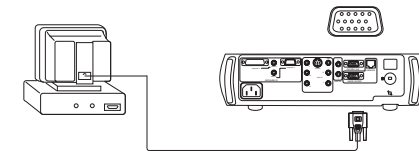


connect audio cable



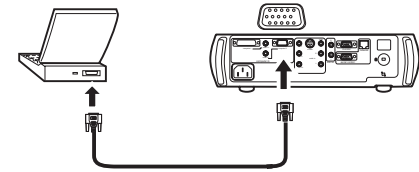
If you are using a desktop computer and want to see the image on your computer screen as well as on the projection screen, plug the monitor cable to the **Monitor out** connector on the projector.

connect monitor cable



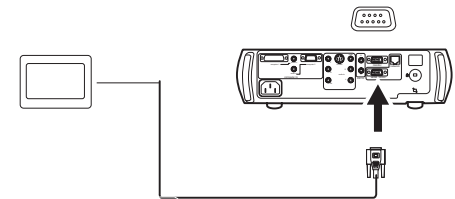
If you prefer connecting your computer to the projector with an optional VESA cable, connect one end of the cable to the VESA port on your computer, and connect the other end of the cable to the blue **Computer 2** connector on the projector.

connect VESA cable



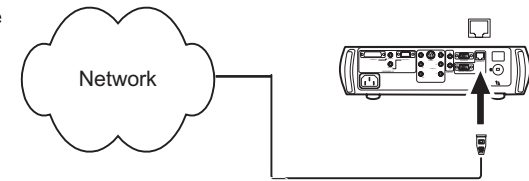
You can control the projector from an LCD control panel or computer by connecting an RS-232 cable to the projector's **Serial** connector.

connect RS-232 cable



The projector can be managed by networking software through its **Network** connector.

connect network cable

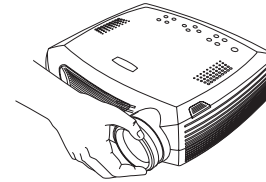




## Displaying a computer image

Remove the lens cap.

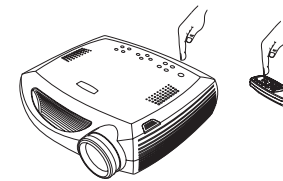
remove lens cap



Press the **Power** button on the top of the projector or the remote.

The LED flashes green and the fans start to run. When the lamp comes on, the startup screen is displayed and the LED is steady green. It can take a minute for the image to achieve full brightness.

press Power



**? No startup screen?** Get help on page 15.

Turn on your computer.

turn on computer

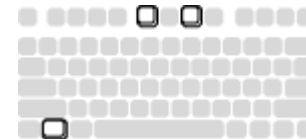


The computer's image should appear on the projection screen. If it doesn't, press the **Computer** button on the projector's keypad.

Make sure your laptop's external video port is active.

Many laptops do not automatically turn on their external video port when a projector is connected. Usually a key combination like FN + F5 is used to turn the external display on and off. Refer to your computer's documentation to learn your computer's key combination.

activate laptop's external port



**? No computer image?** Try pressing the **Auto Image** button on the keypad. Get help on page 15.

## First-time projector use with Windows 98

The first time you connect a computer running Windows 98 to the projector, the computer recognizes the projector as “new hardware” and the Add New Hardware Wizard appears. Follow these instructions to use the Wizard to load the correct driver (which was installed with your Windows operating system).

If you are running Windows 2000, Windows ME, or Window XP, skip these steps and go to “Adjusting the image” on page 10.

**a** Click **Next** to begin searching for the driver.

**b** Make sure “Search for the best driver” is selected, then click **Next**.

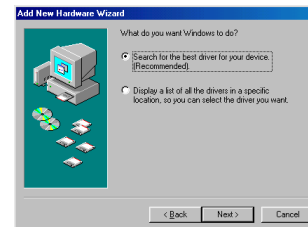
**c** Uncheck any checked boxes, then click **Next**. Windows automatically locates the driver. If this driver has been removed, reload the driver using your Windows operating system CD.

**d** When Windows finds the driver, you are ready to install it. Click **Next**.

**a**



**b**



**c**



**d**



**Skip this page if you did not connect a USB mouse cable**

**For Windows 98:**

- If you connected the USB cable, the Add New Hardware Wizard appears again. Drivers must be installed to use the USB functionality.
- **The Wizard launches three times.**

The first time it detects a USB Composite Device.

The second time a USB Human Interface Device (for the keyboard).

The third time it detects a USB Human Interface Device (for the mouse).

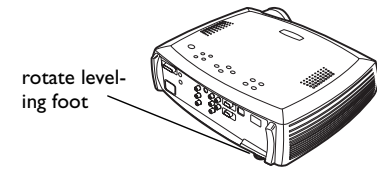
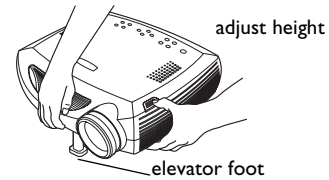
**For Windows 2000, Windows ME, and Windows XP:**

- The USB drivers are automatically installed.

## Adjusting the image

Adjust the height of the projector, if necessary, by pressing the release button to extend the elevator foot.

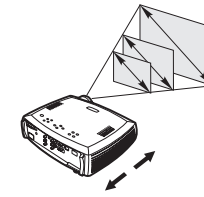
Rotate the leveling foot, if necessary.



Position the projector the desired distance from the screen at a 90 degree angle to the screen.

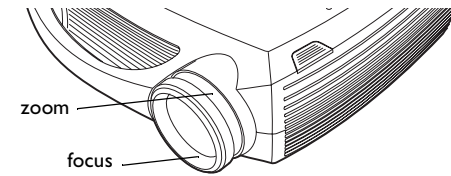
See page 39 for a table listing screen sizes and distances.

adjust distance



Adjust the zoom or focus rings by rotating them until the desired image size and sharpness are produced.

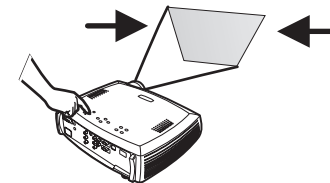
adjust zoom and focus



If the image is not square, adjust the keystone by using the buttons on the keypad.

Press the upper **Keystone** button to reduce the upper part of the image, and press the lower **Keystone** button to reduce the lower part.

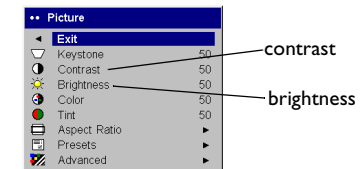
adjust keystone



Adjust the Contrast or Brightness in the Picture menu.

See page 27 for help with the menus.

adjust Contrast or Brightness



## Connecting a video device

### Standard video connections

Plug the video cable's yellow connector into the video-out connector on the video device. Plug the other yellow connector into the yellow **Video** connector on the projector.

Plug a white connector into the left audio out connector on the video device and plug a red connector into the right audio out connector on the video device.

Plug the remaining white connector into the left **audio in** connector on the projector, and plug the red connector into the right **audio in** connector on the projector.

Connect the black power cable to the connector on the back of the projector and to your electrical outlet. The Power LED on the keypad turns solid green.

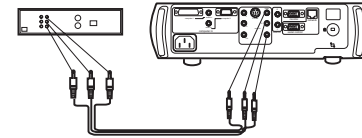
**NOTE:** Always use the power cable that shipped with the projector.

### Optional video connections

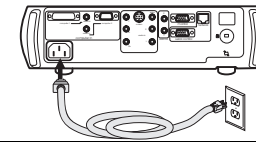
If the video device uses a round, four-prong S-video connector, plug an S-video cable (sold separately) into the S-video connector on the video device and into the **S-video** connector on the projector. Use the video cable's audio connectors as described directly above (the yellow connectors on the video cable are not used).

If the video device uses component cable connectors (sold separately), plug the cable's green connectors into the green component-out connector on the video device and into the green component connector (labeled "**Y**") on the projector. Plug the component cable's blue connectors into the blue component-out connector on the video device and into the blue component connector (labeled "**Pb**") on the projector. Plug the component cable's red connectors into the red component-out connector on the video device and into the red component connector (labeled "**Pr**") on the projector. Use the video cable's audio connectors as described directly above (the yellow connectors on the video cable are not used).

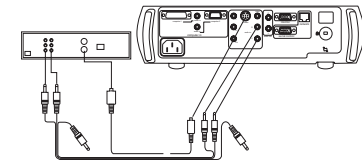
connect video cable



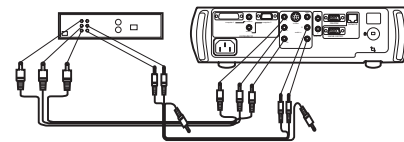
connect power cable



connect S-video and video cables



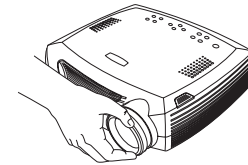
connect component cables  
and video cables



## Displaying a video image

Remove the lens cap.

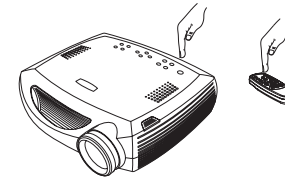
remove lens cap



Press the **Power** button on the top of the projector.

The LED flashes green and the fans start to run. When the lamp comes on, the startup screen is displayed and the LED is steady green. It can take a minute for the image to achieve full brightness.

press Power

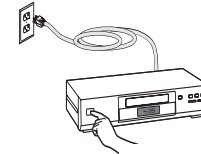


**? No startup screen?** Get help on page 14.

Plug in and turn on the video device.

The video device's image should appear on the projection screen. If it doesn't, press the **Video** button on the keypad.

turn on video device



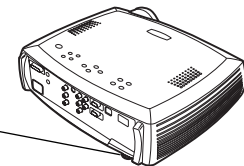
Adjust the height of the projector by pressing the release button to extend the elevator foot. Rotate the leveling foot, if necessary.

adjust height

elevator foot

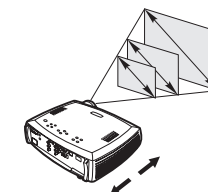


rotate leveling foot



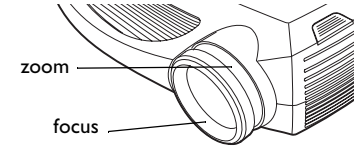
Position the projector the desired distance from the screen at a 90 degree angle to the screen. See page 39 for a table listing screen sizes and distances to the screen.

adjust distance



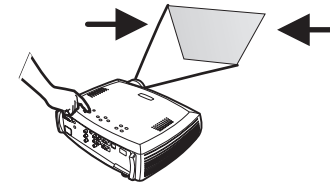
Adjust the zoom or focus rings by rotating them until the desired image size and sharpness are produced.

adjust zoom and focus



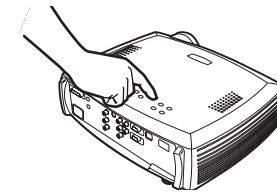
If the image is not square, adjust the keystone using the buttons on the keypad. Press the upper **Keystone** button to reduce the upper part of the image, and press the lower **Keystone** button to reduce the lower part.

adjust keystone



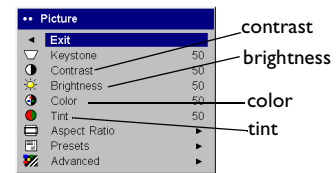
Adjust the volume on the keypad or remote.

adjust volume



Adjust the **Contrast**, **Brightness**, **Color**, or **Tint** in the Picture menu.  
See page 27 for help with the menus.

adjust Picture menu



## Shutting down the projector

The projector automatically displays a black screen after no active source is detected for 30 minutes. This black screen helps preserve the life of the projector. The image returns when an active source is detected or a remote or keypad button is pressed.

### Screen Save

You can make the black screen appear after five minutes by turning on Screen Save in the **Settings>System** menu. See page 32. There are six time options for the Screen Save feature. They range from five minutes to 30 minutes with five minute intervals.

### Power Save

The projector also has a Power Save feature that automatically turns the lamp off after no signals are detected for 20 minutes. After 10 additional minutes with no signal, the projector powers down. If an active signal is received before the projector powers down, the image is displayed. You must press the Power button to display an image after 30 minutes have passed. When Power Save is enabled, Screen Save is disabled. See page 31.

### Turning off the projector

To turn off the projector, press the **power** button and verify that you want to turn the projector off by pressing the power button again within 3 seconds. You can cancel the shutdown by not pressing the **power** button a second time. The lamp turns off and the LED blinks green for 1 minute while the fans continue to run to cool the lamp. When the lamp has cooled, the LED lights green and the fans stop. Unplug the power cable to completely power off the projector.

## Troubleshooting your setup

If your image appears correctly on the screen, skip to the next section (page 23). If it does not, troubleshoot the setup.

The LED on top of the projector's keypad indicates the state of the projector and can help you troubleshoot.

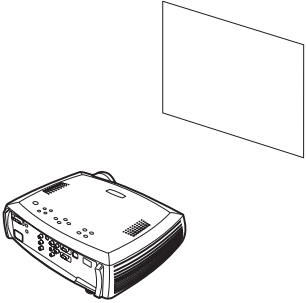
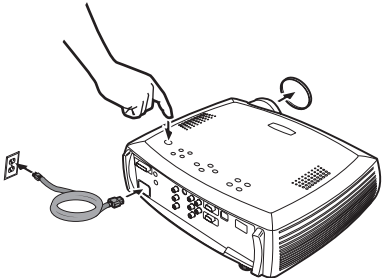
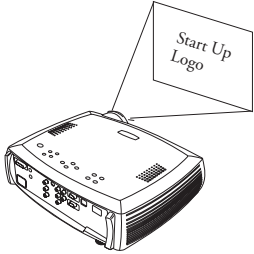
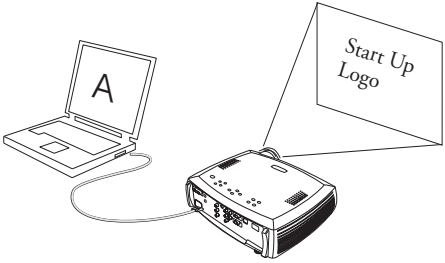

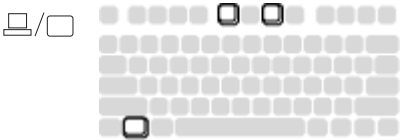
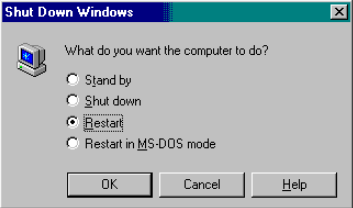
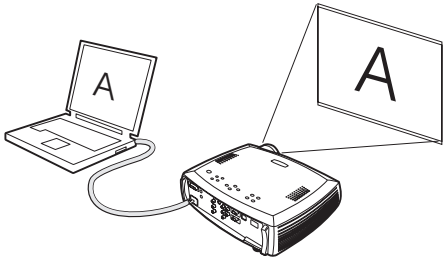
**Table 1: LED behavior and meaning**

| LED color/behavior | Meaning   |
|--------------------|---|
| solid green        | The projector is plugged in, or the projector has been turned on and the software has initialized. The projector has been turned off and the fans have stopped.   |
| blinking green     | The power button has been pressed and the software is initializing, or the projector is powering down and the fans are running to cool the lamp.  |
| blinking red       | A fan or lamp failure has occurred. Turn off the projector and wait one minute, then turn the projector on again. If the projector has been working for 2,000 hours or more, replace the lamp and reset the lamp timer. Also check for a blocked vent or a stopped fan. |
| solid red          | An unidentifiable error: please contact Technical Support.  |

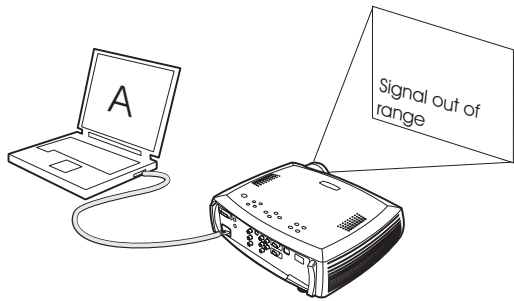
The following tables show common problems. In some cases, more than one possible solution is provided. Try the solutions in the order they are presented. When the problem is solved, you can skip the additional solutions.



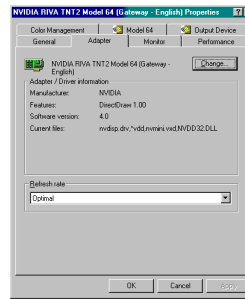
**Source troubleshooting**

| Problem  | Solution   | Result  |
|--|--|---|
| <p><b>No startup screen</b></p>             | <p><b>Plug power cable in and remove lens cap press power button</b></p>   | <p><b>Correct image</b></p>              |
| <p><b>Only startup screen appears</b></p>  | <p><b>Press the Computer button</b> </p> <p><b>Activate laptop's external port</b></p>  <p><b>or restart laptop</b></p>  | <p><b>Computer image projected</b></p>  |

**No computer image, just the words “Signal out of range”**

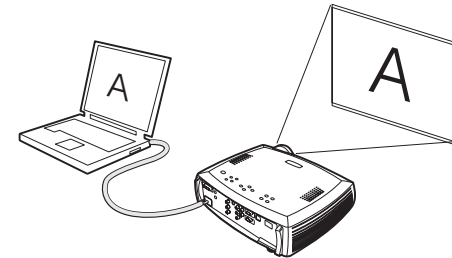


**Adjust computer refresh rate in Control Panel>Display>Settings>Advanced>Adapter (location varies by operating system)**

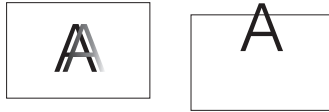


**You may also need to set a different resolution on your computer, as shown in the following Problem, “Image fuzzy or cropped”**

**Computer image projected**

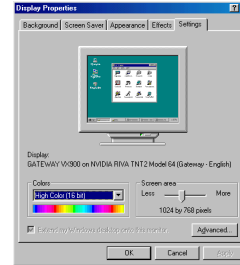


**Image fuzzy or cropped**



**Set your computer's display resolution to the native resolution of the projector (Start>Settings>Control Panel>Display>Settings tab, select 1024x768)**

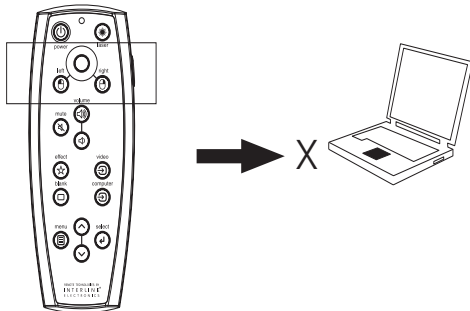
**For a laptop, disable laptop monitor or turn-on dual-display mode**



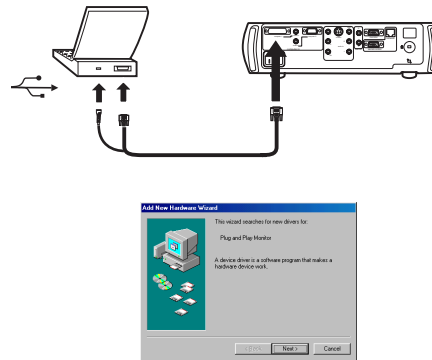
**Image clear and not cropped**



**Remote control not controlling my computer's mouse**

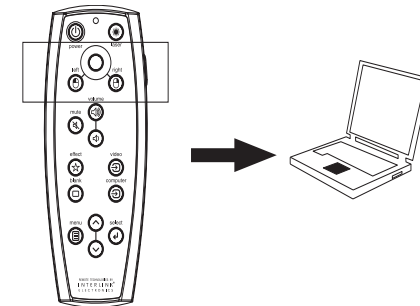


**Connect computer cable (page 5), then, load USB drivers, if needed (page 8)**

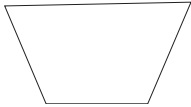
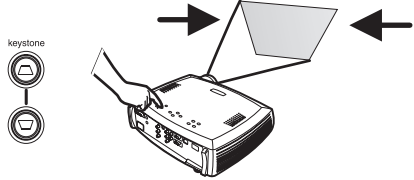

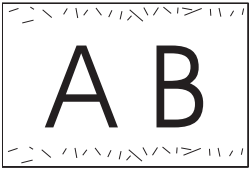
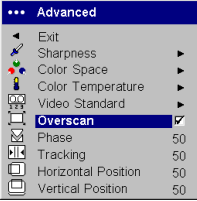


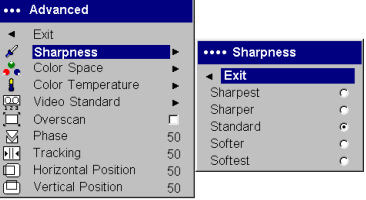




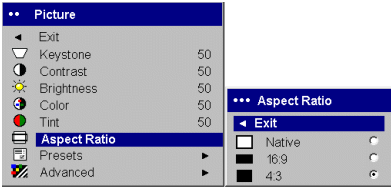


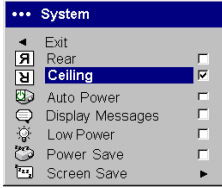


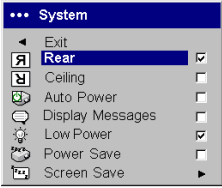

**Remote controls computer cursor. Note that the mouse is not functional in zoom mode (see page 32)**


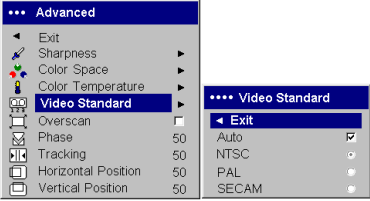


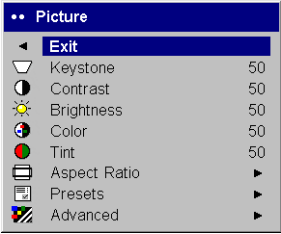

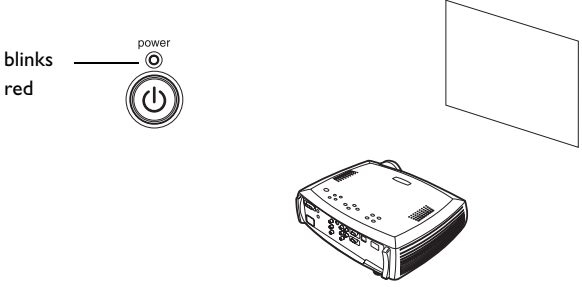
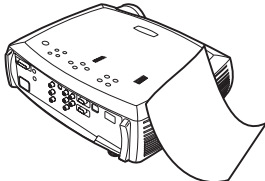
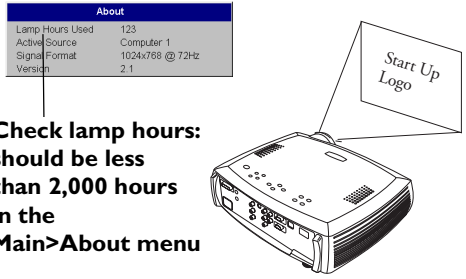
**See page 23 for information on the remote**



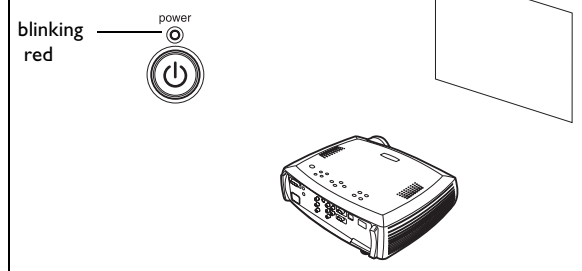
## Projector troubleshooting

| Problem   | Solution   | Result  |
|---|--|---|
| <p data-bbox="241 407 441 435">Image not square</p>          | <p data-bbox="850 399 1150 427">Adjust keystone on keypad</p>                            | <p data-bbox="1365 399 1522 427">Square image</p>      |
| <p data-bbox="241 699 520 727">Edges of image distorted</p>  | <p data-bbox="850 662 1333 716">Turn Overscan on in the Picture&gt;Advanced menu</p>     | <p data-bbox="1365 691 1533 719">Correct image</p>     |
| <p data-bbox="241 992 430 1019">Image not sharp</p>        | <p data-bbox="850 954 1333 1008">Adjust Sharpness in the Picture&gt;Advanced menu</p>  | <p data-bbox="1365 984 1533 1011">Correct image</p>  |

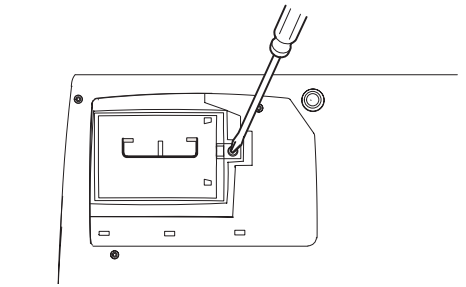
|  |  |  |
|--|--|--|
| <p><b>Image does not fit 16:9 screen</b></p>  | <p><b>Change aspect ratio to 16:9 in Picture&gt;Aspect ratio menu</b></p>  | <p><b>Correct image</b></p>   |
| <p><b>Image upside down</b></p>               | <p><b>Turn off Ceiling in Settings&gt;System menu</b></p>                  | <p><b>Correct image</b></p>   |
| <p><b>Image reversed left to right</b></p>   | <p><b>Turn off Rear in Settings&gt;System menu</b></p>                    | <p><b>Correct image</b></p>  |

|  |   |  |
|--|---|--|
| <p><b>Video image “torn” and fragmented</b></p>                 | <p><b>Change Video Standard in Picture&gt;Advanced menu</b></p>                         | <p><b>Correct image</b></p>   |
| <p><b>Projected colors don't match source</b></p>               | <p><b>Adjust color, tint, color temperature, brightness, contrast in the menus</b></p>  | <p><b>Correct image</b></p>   |
| <p><b>Lamp won't turn on, LED blinking red (page 14)</b></p>  | <p><b>Make sure vents aren't blocked; allow projector to cool for one minute</b></p>  | <p><b>Unplug projector; wait one minute; plug in projector and turn it on: lamp lights</b></p>  <p><b>Check lamp hours: should be less than 2,000 hours in the Main&gt;About menu</b></p> |

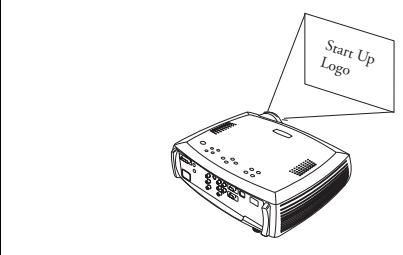
**Lamp won't turn on, LED blinking red (page 14)**



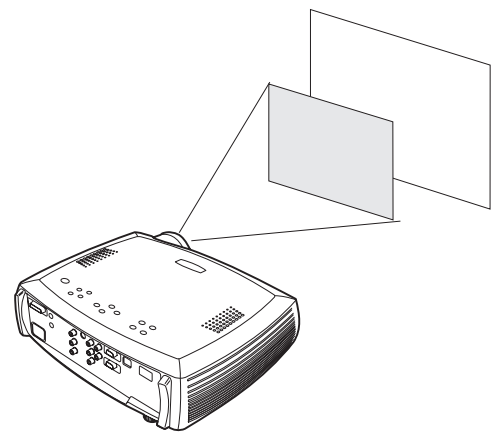
**Lamp must be replaced (page 35)**



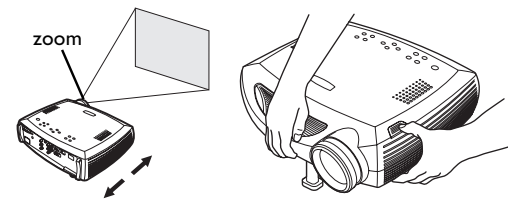
**Lamp turns on**



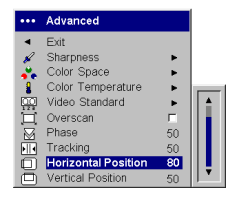
**Image not centered on screen**



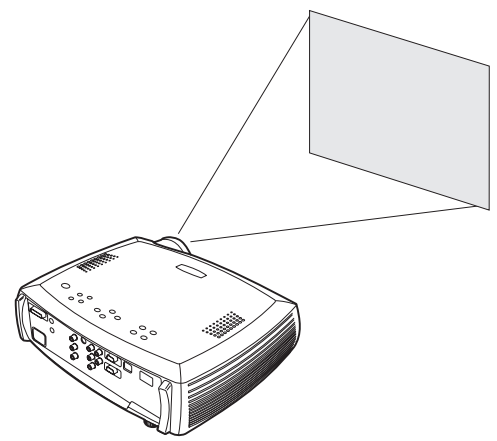
**Move projector, adjust zoom, adjust height**



**adjust horizontal or vertical position in Picture>Advanced menu**



**Correct image**



## Regarding this projector

For assistance, call BOXLIGHT at **1-800-762-5757** or **1-360-779-7901**.

This product is backed by a limited two-year warranty. An extended warranty plan may be purchased from BOXLIGHT.

When sending the projector in for repair, we recommend shipping the unit in the carry case in its original packing material, or having a professional packaging company pack the unit with all accessories for shipping. Please insure your shipment for its full value.

## Using the keypad buttons

Most buttons are described in detail in other sections, but here is an overview of their functions:

**power**—turns the projector on (page 7) and off (page 12).

**menu**—opens the on-screen menus (page 27).

**select**—confirms choices made in the menus (page 27).

**up/down arrows**—navigates to and adjusts settings in the menus (page 27).

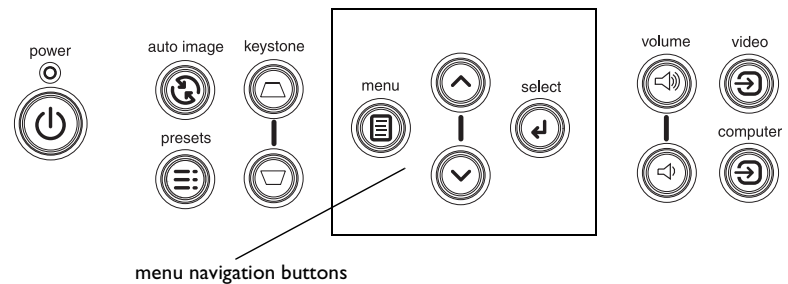
**auto image**—resets the projector to the source.

**presets**—cycles through the available preset settings (page 29).

**keystone**—adjusts squareness of the image (page 10).

**volume**—adjusts sound (page 24).

**video and computer**—changes the active source.





## Using the remote control

The remote uses two (2) provided AAA batteries. They are easily installed by sliding the cover off the remote's back, aligning the + and - ends of the batteries, sliding them into place, and then replacing the cover.

To operate, point the remote at the projection screen or at the projector (not at the computer). The range of optimum operation is about 30 feet (9.14m).

To use the laser pointer, press and hold the **Laser** button. The laser turns off when the button is released, or times out after two (2) minutes of continuous operation.

Left and right remote mouse buttons are used to mimic the actions of the left/right mouse buttons on your computer. Mouse cursor movement is managed via the remote's Cursor control. Connect the USB connector on the computer cable to your computer to use these buttons and control your computer's mouse. When you do this for the first time, the Add New Hardware wizard may appear. See page 8 for details on loading the correct USB drivers.

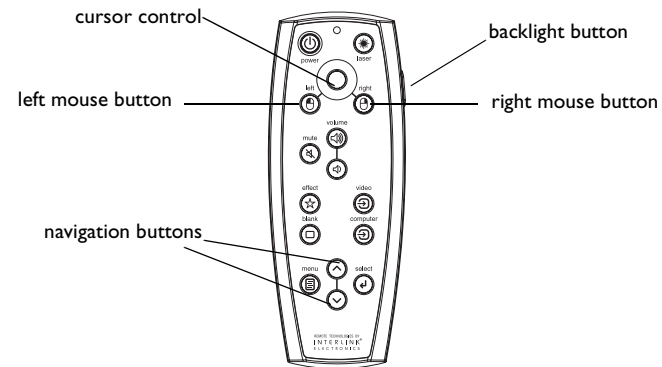
Press the remote's **Menu** button to open the projector's menu system. Use the arrow buttons to navigate, and the Select button to select features and adjust values in the menus. See page 27 for more info on the menus.

The remote also has a power button to turn the projector on and off (see page 14 for shutdown info), volume and mute buttons to control the sound, a backlight button to light the remote's buttons in the dark, and video and computer buttons to switch between sources.

Two presentation-specific features are also provided. Use the blank button to display a blank screen instead of the current slide (you can choose which color is displayed, see page 32); use the effect button to invoke a user-definable action, such as freeze or zoom (see page 32 to learn to program this button).

If you are displaying presentations in Microsoft® PowerPoint®, you can use the remote's mouse buttons to navigate through your presentation while in Slide Show mode. To configure PowerPoint for this, choose Options from

the PowerPoint Tools menu, click the View Tab, de-select the "Popup Menu on Right Mouse Click" option in the Slide Show section, then click OK. Then, when you're in PowerPoint's Slide Show mode, a left click advances to the next slide and a right click returns to the previous slide (other PowerPoint modes are not affected).



### Troubleshooting the remote

- Make sure the batteries are installed in the proper orientation and are not dead.
- Make sure you're pointing the remote at the projector, not the computer, and are within the remote range of 30 feet (9.14m).
- If you are trying to control your computer's mouse, make sure the USB cable is connected. If using a USB cable, make sure the correct drivers are installed.

## Using the audio

To play sound from the projector, connect your source to the Audio In connector on the projector.

To adjust the volume, use the buttons on the keypad or remote.

To mute the sound, press the **Mute** button.

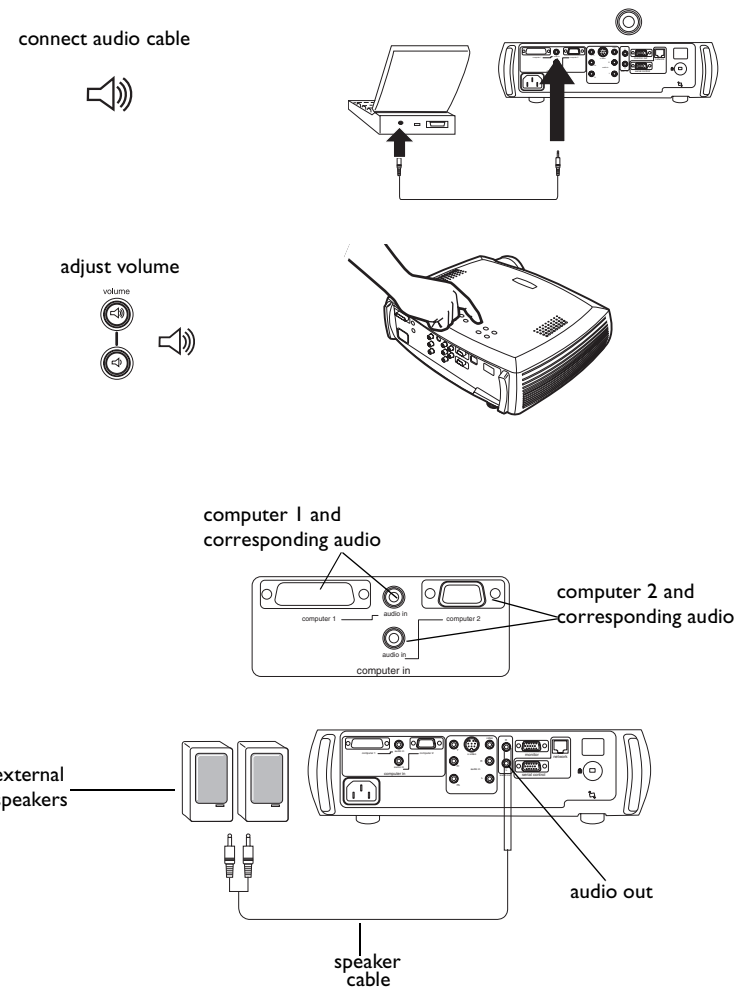
### Troubleshooting audio

If there is no sound, check the following:

- Make sure the audio cable is connected.
- Make sure mute isn't active.
- Make sure the volume is turned up enough. Press the volume button on the keypad or remote.
- Make sure that if you are connected to **Computer 1** on the back of the projector, that you are also connected to the corresponding **audio in**. If you are connected to **Computer 2**, be sure you are connected to its corresponding **audio in**.
- Adjust the audio source.
- If playing a video, make sure the playback has not been paused.

### Connecting external speakers

The projector can be attached to external speakers that have their own power source by plugging speaker cables into the projector's left and right **Audio Out** connectors.



## Optimizing computer images

After your computer is connected properly and the computer's image is on the screen, you can optimize the image using the onscreen menus. For general information on using the menus, see page 27.

- Adjust the Keystone, Contrast, or Brightness in the Picture menu.
- Change the Aspect Ratio. Aspect Ratio is the ratio of the image width to image height. TV screens are usually 1.33:1, also known as 4:3. HDTV and most DVDs are 1.78:1, or 16:9. Choose the option that best fits your input source. See page 28 for details.
- Adjust the Color Space or Color Temperature in the Advanced menu.
- Adjust the Phase, Tracking, or Horizontal or Vertical position in the Advanced menu.
- Once you have optimized the image for a particular source, you can save the settings using Presets. This allows you to quickly recall these settings later. See page 29.

## Presentation features

Several features are provided to make giving presentation easier. The following is an overview, details are found in the menu section on page 27.

- The remote's **Effect** button allows you to assign various features to the key. The default effect is About, which displays information about the projector and current source. You can select from Blank, Mute, Aspect Ratio, Source, Auto Image, Freeze, Zoom, and About. See page 32 for details.
- The Freeze effect allows you to freeze the displayed image. This is useful if you want to make changes on your computer without your audience seeing them.
- The **Blank** button on the remote allows you to display a blank screen instead of the active source. See page 32.
- The Startup Logo menu option lets you change the default startup screen to a black, white, or blue screen. See page 32.
- Two menu options, Power Save and Screen Save, are provided to automatically shut down the projector after several minutes of inactivity or display a black screen. This helps preserve lamp life. See page 31 and page 32.
- A Low Power menu option is also available to help lower the projector's fan sound volume. See page 31.

## Optimizing video images

After the video device is connected properly and the image is on the screen, you can optimize the image using the onscreen menus. For general information on using the menus, see page 27.

- Adjust the Keystone, Contrast, Brightness, Color, or Tint in the Picture menu. See page 28.
- Change the Aspect ratio. Aspect ratio is the ratio of the image width to image height. TV screens are usually 1.33:1, also known as 4:3. HDTV and most DVDs are 1.78:1, or 16:9. Choose the option that best fits your input source. See page 28.
- Select a Sharpness setting. See page 30.
- Adjust the Color Temperature. Select a listed value, or select User and individually adjust the intensity of the red, green, and blue color. See page 30.
- Select a different Video Standard. Auto tries to determine the standard of the incoming video. Select a different standard if necessary. See page 30.
- Turn overscan on to remove noise around the video image. See page 30.

## Customizing the projector

You can customize the projector for your specific setup and needs. See page 31 to page 34 for details on these features.

- For rear projection, turn Rear mode on in the **Settings>System** menu.
- For ceiling mounted projection, turn Ceiling mode on in the **Settings>System** menu.
- Specify which source the projector checks first for active video during power-up.
- Specify the function of the Effect Key on the remote.
- Turn the projector's display messages on and off.
- Turn on power saving features.
- Specify blank screen colors and startup logos.
- Specify the menu language.

## Using the menus

To open the menus, press the menu button on the keypad or remote. (The menus automatically close after 60 seconds if no buttons are pressed.) The Main menu appears. Use the arrow buttons to move up and down to highlight the desired submenu, then press the **Select** button.

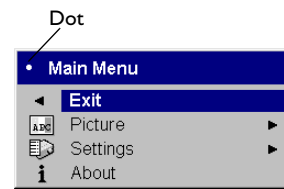
To change a menu setting, highlight it, press **Select**, then use the up and down arrow buttons to adjust the value, select an option using radio buttons, or turn the feature on or off using check boxes. Press **Select** to confirm your changes. Use the arrows to navigate to another setting. When your adjustments are complete, navigate to Exit, then press **Select** to go to the previous menu; press the **Menu** button at any time to close the menus.

Dots appear before the menu name. The number of dots indicate the menu's level, ranging from one (the Main menu) to four (the most nested menus).

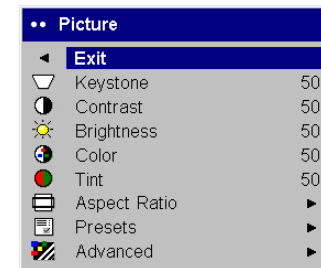
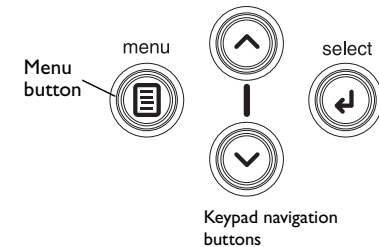
The menus are grouped by usage:

- The Picture menu provides image adjustments.
- The Settings menu provides set-up type adjustments that are not changed often.
- The About menu provides a read-only display of information about the projector and source.

Certain menu items may be hidden until a particular source is connected. For example, Sharpness is only available for video sources and will be hidden when a computer source is active. Other menu items may be grayed out when they are not available. For example, Brightness is grayed out until an image is active.



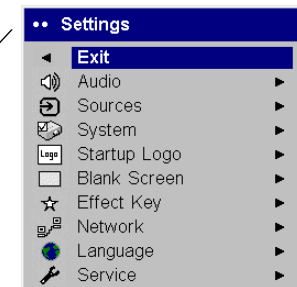
Main menu



Picture menu

Dots

Settings menu



About menu

| About           |                 |
|-----------------|-----------------|
| Lamp Hours Used | 123             |
| Active Source   | Computer 1      |
| Signal Format   | 1024x768 @ 72Hz |
| Version         | 2.1             |

## Picture menu

To adjust the following five settings, highlight the setting, press **Select**, use the up and down arrows to adjust the values, then press select to confirm the changes.

**Keystone:** adjusts the image vertically and makes a squarer image. You can also adjust keystone from the keypad.

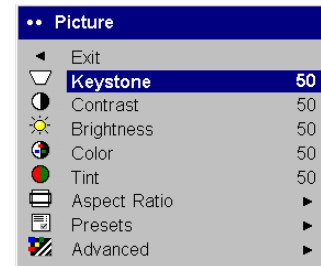
**Contrast:** controls the degree of difference between the lightest and darkest parts of the picture and changes the amount of black and white in the image.

**Brightness:** changes the intensity of the image.

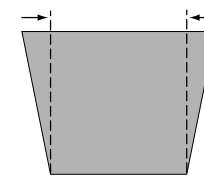
**Color:** (video sources only) adjusts a video image from black and white to fully saturated color.

**Tint:** (NTSC video sources only) adjusts the red-green color balance in the image.

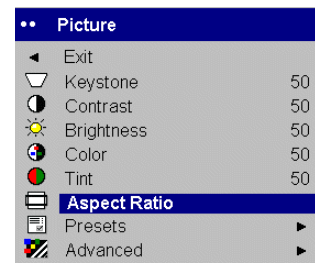
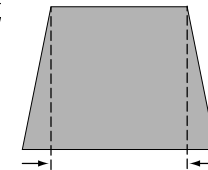
**Aspect Ratio:** Aspect ratio is the ratio of the image width to image height. TV screens are usually 1.33:1, also known as 4:3. HDTV and most DVDs are 1.78:1, or 16:9. The default is 4:3, which displays the input resized up or down to fill the display area.



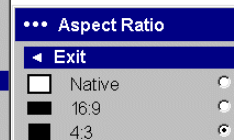
increasing keystone



decreasing keystone

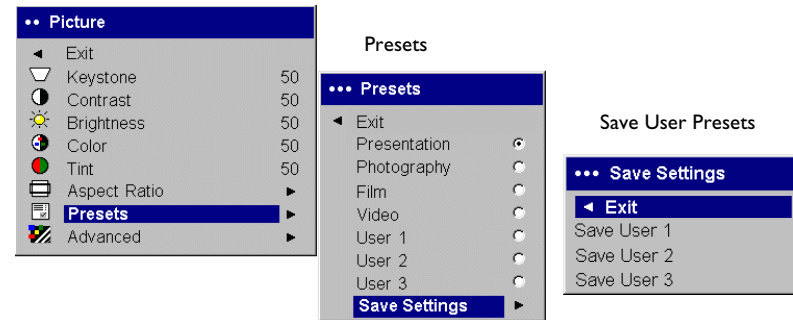


Aspect ratio



**Presets:** The provided Presets optimize the projector for displaying computer presentations, photographs, film images, and video images. (Film input is material originally captured on a film camera, like a movie; video input is material originally captured on a video camera, like a TV show or sporting event.) You can use the preset as a starting point, then further customize the settings for each source. The settings you customize are saved in the preset for each source. To restore the factory default settings, choose Factory Reset in the **Settings>Service** menu.

There are also three user-definable presets. To set a preset for the current source, adjust the image, select **Save Settings** in the Presets menu, then choose Save User 1, 2, or 3. You can recall these settings in the future by selecting the appropriate user presets.



**Advanced settings**

**Sharpness:** (video sources only) changes the clarity of the edges of a video image. Select a sharpness setting.

**Color Space:** This option applies to computer and component video sources (it won't appear in the menu for S-video or composite video sources). It allows you to select a color space that has been specifically tuned for the video input. When Auto is selected, the projector automatically determines the standard. To choose a different setting, turn off Auto, then choose RGB for computer sources, choose either SMPTE240, REC709, or REC601 for component video sources.

**Color Temperature:** changes the intensity of the colors. Select a listed value, or select User and individually adjust the intensity of the red, green, and blue colors.

**Video Standard:** When it is set to Auto, the projector attempts to pick the video standard automatically based on the input signal it receives. (The video standard options may vary depending on your region of the world.) If the projector is unable to detect the correct standard, the colors may not look right or the image may appear "torn." If this happens, manually select a video standard by selecting NTSC, PAL, or SECAM from the Video Standard menu.

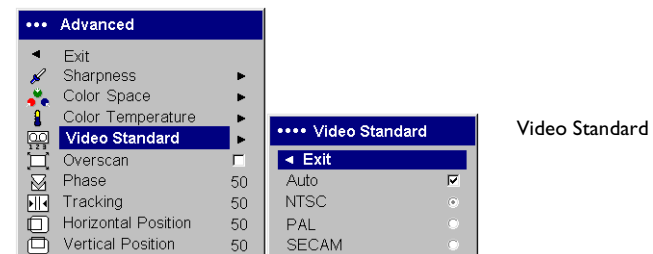
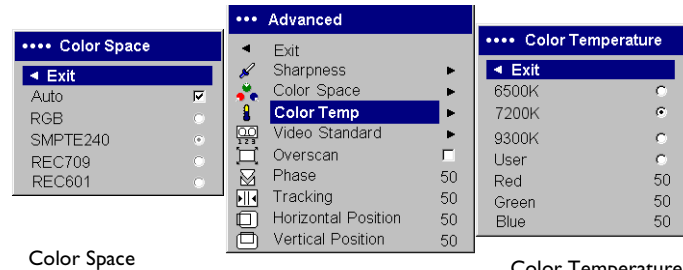
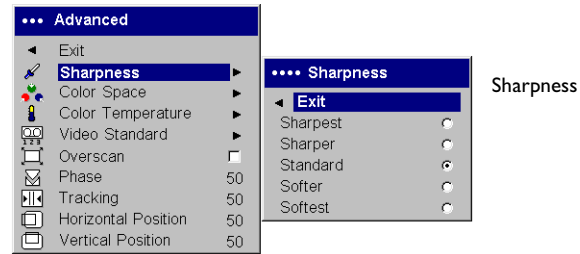
**Overscan:** (video sources only) removes noise around the video image.

The following 4 options are for computer sources only.

**Phase:** adjusts the horizontal phase of a computer source.

**Tracking:** adjusts the vertical scan of a computer source.

**Horizontal/Vertical Position:** adjusts the position of a computer source.





## Settings menu

**Audio:** allows adjustments to the sound Balance between speakers and speaker Volume. The Internal speakers and projector startup Chime can be turned on or off by placing or removing a check in the respective check-boxes.

**Sources>Power-up Source:** this determines which source the projector checks first for active video during power-up.

**Sources:** allows you to assign a particular input to a specific source key as an optional full-featured remote. Also allows selection of a default Power-up Source and enables or disables Autosource. When Autosource is not checked, the projector defaults to the source selected in Power-up Source. If no source is found, a blank screen displays. When Autosource is checked, Power-up Source determines which source the projector defaults to at power-up. If no signal is present, the projector checks the sources in order until a source is found or until power down.

**System>Rear:** reverses the image so you can project from behind a translucent screen.

**Ceiling:** turns the image upside down for ceiling-mounted projection.

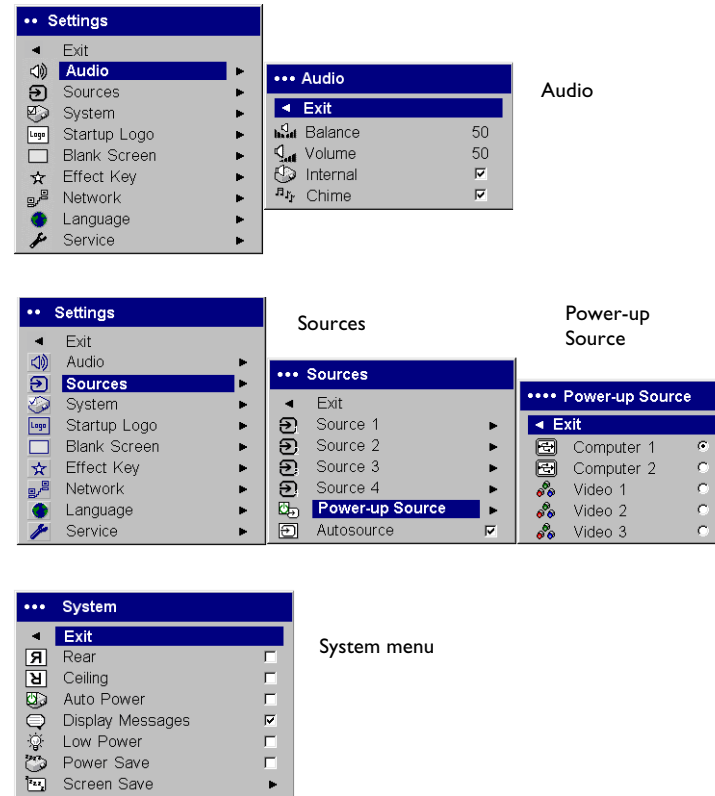
**NOTE:** It is recommended that all final image adjustments in Ceiling mode are made once the unit has fully warmed up.

**Auto Power:** When Auto Power is checked, the projector automatically goes into the startup state after the projector is powered on. This allows control of ceiling mounted projectors with a wall power switch.

**Display Messages:** displays status messages (such as “Searching” or “Mute”) in the lower-left corner of the screen.

**Low Power:** toggles between on and off. Turn it on to lower the light output of the lamp. This also lowers the fan speed, making the projector quieter.

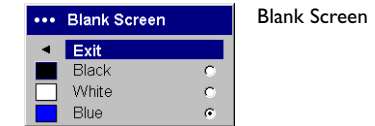
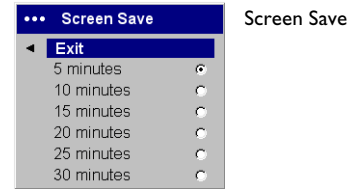
**Power Save:** automatically turns the lamp off after no signals are detected for 20 minutes. After 10 additional minutes with no signal, the projector powers down. If an active signal is received before the projector powers down, the image will be displayed.



**Screen Save:** automatically blanks the screen with a black color after no signals are detected for a preset number of minutes. The image returns when an active source is detected or a remote or keypad button is pressed. Screen Save is disabled when Power Save is enabled.

**Startup Logo:** allows you to display a blank Black, White, or Blue screen instead of the default screen at startup and when no source is detected.

**Blank Screen:** determines what color displays when you press the Blank button on the remote or there is a blank screen when no source is active.



**Effect Key:** allows you to assign a different function to the **Effect** button on the remote to quickly and easily use the effect. Only one effect can be enabled at a time. Highlight an effect and press **Select** to choose a different one.

**Blank:** shows an empty screen.

**Mute:** turns off all sound.

**Aspect Ratio:** sets the ratio of the image width to image height.

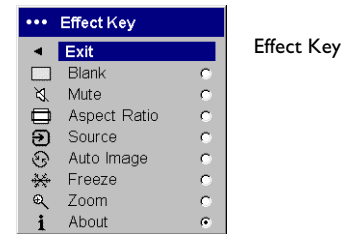
**Source:** cycles through the available sources.

**Auto Image:** causes computer sources to be reacquired.

**Freeze:** pauses the projected image.

**Zoom:** lets you magnify a part of the screen. To use the Zoom effect, press **Effect**, then press the remote's mouse left-click to zoom the image, press the mouse right-click to decrease the magnification. You can use the cursor control to pan the image, displaying different parts of it (only if the image is magnified). To return to the original size and cancel Zoom, press the **Effect** button a second time.

**About:** is the default effect. It displays the About menu.



**Network:** The projector has an RJ45 Ethernet connector that supports network connections and TCP/IP protocols. This will allow for the control and management of the projector over a corporate network. The following fields are accessible when DHCP is not checked and available for manual entry of data.

**IP Address:** Identifies the projector on the network.

**Subnet mask:** Separates the network address part of the IP address.

**Default gateway:** The IP address of the local router.

**DHCP:** Select this to automatically obtain an IP address, Subnet mask, and Default gateway.

**Network Info:** Provides information on the network configuration.

The **Network Info** menu is informational and cannot be edited. It displays the current IP Address, Subnet Mask, Default Gateway, and the projector's MAC Address.

**Language:** allows you to select a language for the onscreen display of menus and messages.

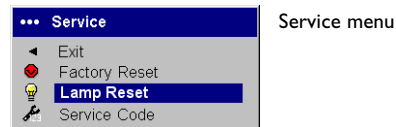
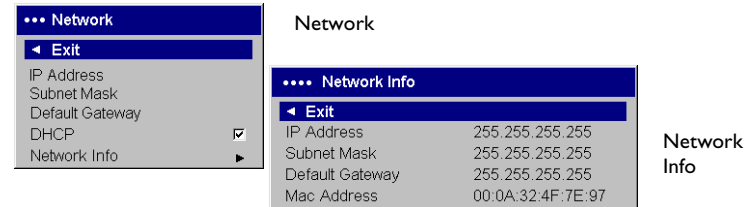
**Service:**

To use these features, highlight them and press **Select**.

**Factory Reset:** restores all settings (except Lamp Hours and Network settings) to their default after displaying a confirmation dialog box.

**Lamp Reset:** resets the lamp hours counter in the About menu to zero. Do this only after changing the lamp. It displays a confirmation dialog box.

**Service Code:** only used by authorized service personnel.



## Maintenance

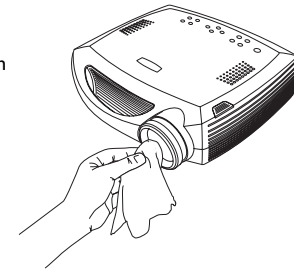
### Cleaning the lens

- 1 Apply a non-abrasive camera lens cleaner to a soft, dry cloth.

Avoid using an excessive amount of cleaner, and don't apply the cleaner directly to the lens. Abrasive cleaners, solvents or other harsh chemicals might scratch the lens.

- 2 Lightly wipe the cleaning cloth over the lens in a circular motion. If you don't intend to use the projector immediately, replace the lens cap.

clean the lens  
with a soft dry cloth  
and non-abrasive  
cleaner



## Replacing the projection lamp

The lamp hour timer in the About menu counts the number of hours the lamp has been in use. After 1,980 hours, the message “Change lamp” briefly appears on the screen at each startup. When the timer reaches 2,000 hours, the lamp will no longer light. You can order new lamp modules from BOX-LIGHT. See “Accessories” on page 38 for information.

- 1 Turn off the projector and unplug the power cable.
- 2 Wait 60 minutes to allow the projector to cool thoroughly.

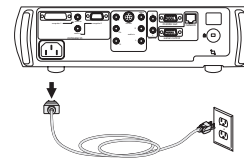
- 3 Turn the projector upside down and remove the lamp door by removing the two screws and sliding the lamp door tabs out of the three tab bays.

**CAUTION:** Never operate the projector with the lamp door removed. This disrupts the air flow and causes the projector to overheat.

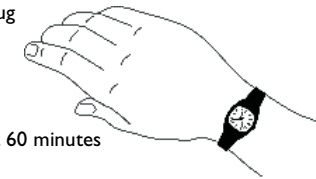
- 4 Loosen the captive screw on the lamp module.

| About           |                 |
|-----------------|-----------------|
| Lamp Hours Used | 123             |
| Active Source   | Computer 1      |
| Signal Format   | 1024x768 @ 72Hz |
| Version         | 2.1             |

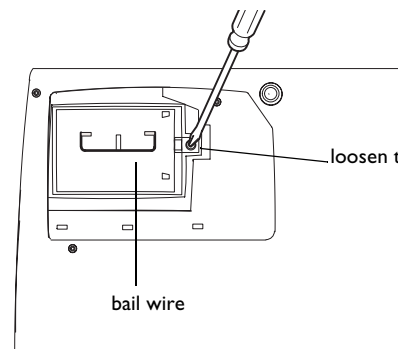
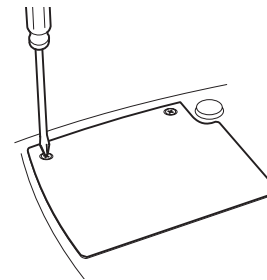
About menu



turn off and unplug the projector



wait 60 minutes



loosen the screw on lamp module

bail wire

## WARNINGS:

- To avoid burns, allow the projector to cool for at least 60 minutes before you replace the lamp.
- Do not drop the lamp module. The glass may shatter and cause injury.
- Do not touch the glass lamp screen. Fingerprints can obscure projection sharpness.
- Be extremely careful when removing the lamp housing. In the unlikely event that the lamp ruptures, small glass fragments may be generated. The lamp module is designed to contain most of these fragments, but use caution when removing it.

**5** Carefully remove the lamp module by grasping and lifting the metal bail wire. Dispose of the lamp in an environmentally proper manner.

**6** Install the new lamp module, making sure that it is properly seated.

**7** Tighten the single screw.

**8** Replace the lamp door by sliding the tabs into the tab bays and tightening the two screws.

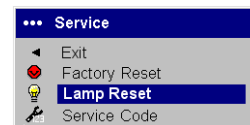
**9** Plug in the power cable, then press the **Power** button to turn the projector back on.

**10** Reset the lamp hour timer.

### Resetting the lamp timer

If the lamp timer has reached the maximum number of hours for the projector lamp (2,000 hours), the LED on the projector's keypad will show a lamp error (see "LED behavior and meaning" on page 14). To reset the lamp age, simultaneously holding down the two **Volume** keys on the projector's keypad for 10 seconds. At that point the LED will turn green and you can power on the projector.

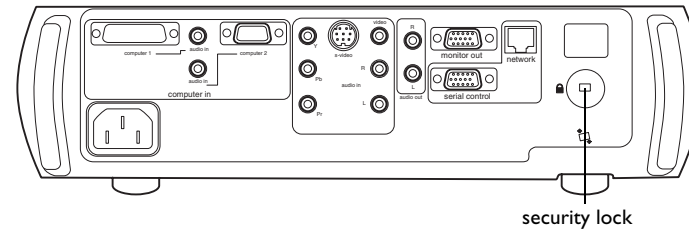
You can also navigate to the **Settings>Service** menu and select **Lamp Reset** to reset the lamp timer.



reset lamp time in Service menu

## Using the security lock

The projector has a security lock for use with a PC Guardian Cable Lock System. See "Accessories" on page 38 for ordering information. Refer to the information that came with the lock for instructions on how to use it.



## Appendix

### Specifications

|                                 |               |   |
|---------------------------------|---------------|---|
| <b>Temperature</b>              | Operating     | 50 to 95° F (10 to 35° C) at 0 - 10,000 feet                              |
|                                 | Non-operating | -4 to 158° F (-20 to 70° C) at 0 -20,000 feet                             |
| <b>Altitude</b>                 | Operating     | 0 to 10,000 feet (3,048 meters)   |
|                                 | Non-operating | 0 to 20,000 feet (6,096 meters)   |
| <b>Humidity</b>                 | Operating     | 10% to 95% relative humidity, non-condensing                              |
|                                 | Non-operating | 10% to 90% relative humidity, non-condensing                              |
| <b>Dimensions</b>               |               | 13.8 x 12.8 x 4.3" (351W x 325L x 110H mm)                                |
| <b>Weight</b>                   |               | 9.3 lbs. (4.24 kg) unpacked   |
| <b>Optics</b>                   | Focus Range   | 5 - 32.8 feet (1.5 - 10 meters)   |
|                                 | Lamp Type     | 250-watt UHP lamp   |
| <b>Input Power Requirements</b> |               | 100V-120V 4A, 50/60 Hz<br>200V-240V 2A 50 Hz                              |
| <b>Ceiling Mount</b>            |               | UL tested/listed ceiling mount with minimum capacity of 46 lbs (20.87 kg) |

### Accessories

#### Standard Accessories (ship with the projector)

---

Carrying Case  
Shipping Box (with packaging)  
Computer Cable 6 ft (1.8 m)  
Audio/Video Cable 6 ft (1.8 m)  
Audio Cable 6 ft (1.8 m)  
Power Cable (country-dependent)  
Conductor Plus Remote  
Projection Lamp Module (included in projector)  
Lens Cap  
Quick Setup card  
User's Guide  
Safety Card  
Color-coded Cable Ties, 3 set



### Optional Accessories

---

- Shipping Case (ATA approved)
- Deluxe Travel Case
- Projector Mount
- False Ceiling Plate for Projector Mount
- Extension Arm for Projector Mount
- PC Guardian Cable Lock System
- 60" Diagonal Screen (portable)
- 80" Diagonal Screen (portable)
- Various Wall/Ceiling Mounted Screens
- Portable Projector Stand
- Replacement Lamp Module
- Various RF Remotes

**NOTE:** Use only approved accessories.

## Projected image size

**Table 2:**  
Range of distance to the screen for a given screen size for CD-850m

| Diagonal<br>Screen Size<br>(inches/m) | Image Width<br>(inches/m) | Distance to screen              |                                 |
|---------------------------------------|---------------------------|---------------------------------|---------------------------------|
|                                       |                           | Maximum<br>distance<br>(feet/m) | Minimum<br>Distance<br>(feet/m) |
| 40/1.0                                | 32/0.8                    | 6.9/2.1                         | 5.0/1.5                         |
| 50/1.3                                | 40/1.0                    | 8.7/2.6                         | 6.2/1.9                         |
| 60/1.5                                | 48/1.2                    | 10.4/3.2                        | 7.5/2.3                         |
| 100/2.5                               | 79/2.0                    | 17.4/5.3                        | 12.4/3.8                        |
| 150/3.8                               | 119/3.0                   | 26.0/7.9                        | 18.7/5.7                        |
| 200/5.1                               | 158/4.0                   | 34.7/10.6                       | 24.9/7.6                        |

## **Numerics**

1024x768 resolution 3

## **A**

About 32

altitude limits 38

Aspect Ratio 32

audio 24

Audio In connector 5, 11

audio volume 13

Auto Image 32

Auto Power 31

## **B**

Blank 32

blinking green 14

blinking red 14

Brightness 10

## **C**

cables

    optional 39

cleaning the lens 34

Color 13

colors are incorrect 20

component cable connector 11

Computer 1 connector 5

Computer 2 connector 6

computer connections

    optional 5

    required 5

computer image

    optimize 25

Contrast 10, 13

## **D**

Declaration of Conformity 1

Default gateway 33

DHCP 33

Display Messages 31

Drivers 8

    USB 9

    Windows 98 9

## **E**

Effect Key 32

elevator foot 10

## **F**

FCC warning 1

first time use

    driver installation 8

focus 10, 13

Freeze 32

fuzzy image 17

## **I**

image

    display video 12

image display

    computer 7

image does not fit screen 19

image edges distorted 18

image not centered 21

image not sharp 18

image not square 18

image reversed 19

image size matrix 39

image torn 20

image upside down 19

Info

    network 33

IP Address 33

## **K**

Keystone 10, 13

## **L**

lamp replacement 35  
lamp won't turn on 20, 21  
Language 33  
laptop  
    external video port 7

## **LED**

    blinking green 14  
    blinking red 20  
    solid green 14  
    solid red 21

LED behavior 14

Lens cleaning 34

leveling foot 10

Low Power 31

## **M**

Main menu 27

menu system 27

Monitor connector 5

mouse, using your 5

Mute 32

## **N**

Network 33

Network connector 6

Network Info 33

no computer image 16

no startup screen 15

## **O**

only startup screen appears 15

optional accessories 39

## **P**

Picture menu 28

Power button 12

power cable 5, 11

Power Save 31

PowerPoint

    remote's mouse buttons 23

presentation features 25

projector

    customizing 26

    optional accessories 39

    shutdown 14

    standard accessories 38

    troubleshooting problems 14

projector height 10, 12

projector positioning 10, 12

projector specifications 38

## **R**

Rear 31

remote control 23

    not working 17

Remote control warning 1

replacing the lamp 35

RS-232 cable 6

## **S**

Safety Certifications 1

security lock 37

Serial connector 6

Settings menu 31

shutdown

    projector 14

solid green 14

solid red 14

Source 32

Source troubleshooting 15

Sources 31

standard accessories

    projector 38

Subnet mask 33

S-video connector 11

**T**

temperature limits 38

Tint 13

Troubleshooting 14, 15

**U**

USB, using your mouse 5

**V**

VESA port 6

Video button 12

video connections

    optional 11

    standard 11

Video connector 11

video images

    optimizing 26

**W**

warranty 22

Windows 2000 9

Windows 98 8

Windows ME 9

Windows XP 9

**X**

XGA 3

**Z**

zoom 10, 13, 32

## LIMITED WARRANTY

BOXLIGHT ("BOXLIGHT") warrants that the CD-850m ("the Product") sold hereunder will conform to and function in accordance with the written specifications of BOXLIGHT. Said limited warranty shall apply only to the first person or entity that purchases the Product for personal or business use and not for the purpose of distribution or resale. Said warranty shall continue for a period of two (2) years from the date of such purchase. The standard limited warranty excludes the lamps in projectors after 120 days and the accessories after one year. BOXLIGHT does not warrant that the Product will meet the specific requirements of the first person or entity that purchases the Product for personal or business use. BOXLIGHT's liability for the breach of the foregoing limited warranty is limited to the repair or replacement of the Product or refund of the purchase price of the Product, at BOXLIGHT's sole option. Replacement Product may be re-furbished in "like-new" condition, at BOXLIGHT's sole discretion. To exercise the Purchaser's rights under the foregoing warranty, the Product must be returned at the Purchaser's sole cost and expense, to BOXLIGHT or to any authorized BOXLIGHT service center provided, and the Product must be accompanied by a written letter explaining the problem and which includes (i) proof of date of purchase; (ii) the dealer's name; and (iii) the model and serial number of the Product. When sending your unit in for repair, please ship your unit in its original packing material or a BOXLIGHT approved ATA Shipping Case, or have a professional packaging company pack the unit. Please insure your shipment for its full value. **A return authorization number, issued by the BOXLIGHT customer service department, must also be clearly displayed on the outside of the shipping carton containing the Product.**

## WARRANTY LIMITATION AND EXCLUSION

BOXLIGHT shall have no further obligation under the foregoing limited warranty if the Product has been damaged due to abuse, misuse, neglect, accident, unusual physical or electrical stress (unusual physical and electrical stress includes unusually long operation, exposure to smoke and other airborne contaminants), unauthorized modifications, tampering, alterations, or service other than by BOXLIGHT or its authorized agents, causes other than from ordinary use or failure to properly use the Product in the application for which said Product is intended.

## DISCLAIMER OF UNSTATED WARRANTIES

THE WARRANTY PRINTED ABOVE IS THE ONLY WARRANTY APPLICABLE TO THIS PURCHASE. ALL OTHER WARRANTIES, EXPRESS OR IMPLIED, INCLUDING, BUT NOT LIMITED TO, THE IMPLIED WARRANTIES OF MERCHANTABILITY AND FITNESS FOR A PARTICULAR PURPOSE ARE DISCLAIMED. THERE ARE NO WARRANTIES THAT EXTEND BEYOND THE FACE HEREOF AND THE FOREGOING WARRANTY SHALL NOT BE EXTENDED, ALTERED OR VARIED EXCEPT BY WRITTEN INSTRUMENT SIGNED BY BOXLIGHT. SOME STATES DO NOT ALLOW LIMITATIONS ON HOW LONG AN IMPLIED WARRANTY MAY LAST, SO SUCH LIMITATIONS MAY NOT APPLY TO YOU.

## LIMITATION OF LIABILITY

IT IS UNDERSTOOD AND AGREED THAT BOXLIGHT'S LIABILITY WHETHER IN CONTRACT, IN TORT, UNDER ANY WARRANTY, IN NEGLIGENCE OR OTHERWISE SHALL NOT EXCEED THE RETURN OF THE AMOUNT OF THE PURCHASE PRICE PAID BY PURCHASER AND UNDER NO CIRCUMSTANCES SHALL BOXLIGHT BE LIABLE FOR SPECIAL, INDIRECT, INCIDENTAL OR CONSEQUENTIAL DAMAGES OR LOST PROFITS, LOST REVENUES OR LOST SAVINGS. THE PRICE STATED FOR THE PRODUCT IS A CONSIDERATION IN LIMITING BOXLIGHT'S LIABILITY. NO ACTION, REGARDLESS OF FORM, ARISING OUT OF THE AGREEMENT TO PURCHASE THE PRODUCT MAY BE BROUGHT BY PURCHASER MORE THAN ONE YEAR AFTER THE CAUSE OF ACTION HAS ACCRUED. SOME STATES DO NOT ALLOW THE EXCLUSION OR LIMITATION OF INCIDENTAL OR CONSEQUENTIAL DAMAGES SO THE ABOVE LIMITATION OR EXCLUSION MAY NOT APPLY TO YOU. THIS LIMITED WARRANTY GIVES YOU SPECIFIC LEGAL RIGHTS, AND YOU MAY ALSO HAVE OTHER RIGHTS WHICH VARY FROM STATE TO STATE.

