

***myprojectorlamps.com***

**The most trusted, dependable name  
in projector lamp sales.**



<http://www.myprojectorlamps.com>



<http://www.myprojectorlamps.ca>



<http://www.myprojectorlamps.eu>

The following projector manual has not been modified or altered in any way.



## **DLP PROJECTOR SL 703S**

### **USER'S GUIDE**

Thank you for purchasing the Benq DLP Projector.

**Please read this user's guide to ensure correct use of the device.** Save this user's guide for future reference.

### **OUTLINE**

This DLP Projector can display various computer signals and NTSC/PAL/SECAM video signals.

## **FEATURES**

---

- 1. High Brightness**
- 2. High Resolution**
- 3. Compact Size, Feather Weight for Portability**
- 4. Durable Magnesium Alloy Body**
- 5. RGB Output Terminal**
- 6. One Touch Auto-Adjustment Function**
- 7. Easy Keystone Adjustment**



## Copyright

---

Copyright © 2002 by Benq Corporation. All rights reserved. No part of this publication may be reproduced, transmitted, transcribed, stored in a retrieval system or translated into any language or computer language, in any form or by any means, electronic, mechanical, magnetic, optical, chemical, manual or otherwise, without the prior written permission of Benq Corporation.

## Disclaimer

---

Benq Corporation makes no representations or warranties, either expressed or implied, with respect to the contents hereof and specifically disclaims any warranties, merchantability or fitness for any particular purpose. Furthermore, Benq Corporation reserves the right to revise this publication and to make changes from time to time in the contents hereof without obligation of Benq Corporation to notify any person of such revision or changes.

### Fill this in!!

For future service convenience, record the following information in the space below. The serial number is on the back of the product.

#### Projector Information

Product Name:	SL 703S
Serial Number:	
Date of Purchase:	

#### Dealer Information

Dealer:	
Telephone Number:	
Address:	



# Table of Contents

<b>Introduction</b> .....	<b>1</b>
<b>Safety Instructions</b> .....	<b>1</b>
<b>Warranty</b> .....	<b>2</b>
Limited Warranty .....	2
<b>Shipping Contents</b> .....	<b>3</b>
Optional Accessories .....	3
<b>Projector Description</b> .....	<b>4</b>
Projector .....	4
External Control Panel .....	5
Adjuster .....	6
Projector Features .....	6
<b>Remote Control Description</b> .....	<b>7</b>
Remote Control Features .....	7
Installing or Replacing Batteries .....	9
<b>Installation</b> .....	<b>10</b>
Screen Size .....	10
Connecting to Various Equipment .....	10
<b>Operation</b> .....	<b>11</b>
Start Up .....	11
Digital Keystone Correction .....	12
Auto Adjustment .....	12
Source Selection .....	13
<b>Menu System</b> .....	<b>13</b>
1. Display Menu .....	14
2. Image Menu .....	15
3. Source Menu .....	16
4. Control Menu .....	17
5. PIP Menu .....	17
Shutdown .....	18
<b>Maintenance</b> .....	<b>19</b>
<b>Lamp Information</b> .....	<b>19</b>
Use and Replacement of Lamp .....	19
LED Status Indicators .....	19
<b>Lamp Replacement</b> .....	<b>19</b>
<b>Resetting Lamp Hours</b> .....	<b>21</b>
<b>Service Information</b> .....	<b>22</b>
Accessories (Included in the standard package) .....	22
Optional Accessories (Not Included in the standard package) .....	22
Ordering Parts or Getting Information .....	22

<b>Troubleshooting</b>	<b>23</b>
<b>Status Messages</b>	<b>24</b>
<b>Specifications</b>	<b>25</b>
<b>Projector Specifications</b>	<b>25</b>
<b>Timing Chart</b>	<b>26</b>
<b>Dimensions</b>	<b>27</b>

---

# INTRODUCTION

---

## Caution

**TO PREVENT SHOCK, DO NOT OPEN THE CABINET. NO USER –SERVICEABLE PARTS INSIDE. REFER SERVICING TO QUALIFIED SERVICE PERSONNEL. PLEASE READ THIS USER’S GUIDE BEFORE YOU OPERATE YOUR PROJECTOR. SAVE THIS USER’S GUIDE FOR FUTURE REFERENCE .**

---

## Safety Instructions

1. Read this user’s guide before you operate your projector and save it for future reference.
2. The lamp becomes extremely hot during operation. Allow the projector to cool for approximately 45 minutes prior to removing the lamp assembly for replacement. Do not operate lamps beyond the rated lamp life. Excessive operation of lamps beyond the rated life could cause them to explode on rare occasions.
3. Never replace lamp assembly or any electronic components unless the projector is unplugged.
4. To reduce the risk of electric shock, do not disassemble this appliance. Take it to a qualified technician when service or repair is required. Incorrect reassembly can cause electric shock when the appliance is subsequently used.
5. Do not place this product on an unstable cart, stand, or table. The product may fall, causing serious damage to the product.
6. This product is capable of displaying inverted images for ceiling mount installation. Please use suitable equipment for mounting the unit and ensure it is securely installed.
7. To prevent lamps from bursting, change the lamp after changing the mounting position of projectors (desktop to ceiling mount or ceiling mount to desktop mount).

---

## Caution

- **Always open the lens shutter or remove the lens cap when the projector lamp is on.**
  - **Do not look straight at the projector lens during operation. The intense light beam may damage your eyesight.**
  - **In some countries, the line voltage is NOT stable. This projector is designed to operate safely within a bandwidth of 110 to 230 volts, but could fail if power cuts or surges of  $\pm 10$  volts occur. In these high-risk areas, it is recommended to install a power stabilizer unit.**
-

**Save this user's guide:** The information contained in this manual will assist you in operating and maintaining your Personal Projector.

## Warranty

### Limited Warranty

Benq warrants this product against any defects in material and workmanship, under normal usage and storage during a period of 1 year from the date of purchase.

**Exclusion to Warranty:** The lamps are considered a consumable item and are warranted for 90 days or 500 hours, whichever occurs first. Proof of purchase date will be required with any warranty claim. In the event this product is found to be defective within the warranty period, Benq's only obligation and your exclusive remedy shall be replacement of any defective parts (labor included). To obtain warranty service, notify the dealer immediately from which you purchased the product of any defects.

**Important:** The above warranty shall be void if the customer fails to operate the product in accordance with Benq's written instructions. This warranty gives you specific legal rights, and you may have other rights which vary from country to country.

**FCC STATEMENT - CLASS A:** This equipment generates, uses and can radiate radio frequency energy, and if not installed and used in accordance with the instruction manual, may cause interference to radio communications. It has been tested and found to comply with the limits for a Class "A" computing device pursuant to Subpart B of Part 15 of the FCC Rules, which are designed to provide reasonable protection against such interference when operated in a commercial environment. Operation of this equipment in a residential area is likely to cause interference, in which case the user at his/her own expense will be required to take whatever measures may be required to correct the interference.

**FCC STATEMENT - CLASS B:** This equipment generates, uses and can radiate radio frequency energy and, if not installed and used in accordance with the instructions, may cause harmful interference to radio communications. However, there is no guarantee that interference will not occur in a particular installation. If this equipment does cause harmful interference to radio or television reception, which can be determined by turning the equipment off and on, the user is encouraged to try to correct the interference by one or more of the following measures:

- Reorient or relocate the receiving antenna.
- Increase the distance between the equipment and receiver.
- Connect the equipment into an outlet on a circuit different from that to which the receiver is connected.
- Consult the dealer or an experienced radio/TV technician for help.

**EEC STATEMENT:** This machine was tested against the 89/336/EEC (European Economic Community) for EMC (Electro Magnetic Compatibility) and fulfills these requirements.



## Shipping Contents

The Projector is shipped with the necessary cables required for standard PC, Macintosh or laptop computer connections. Carefully unpack and verify that you have all the items shown below. If any of these items are missing, please contact your place of purchase.

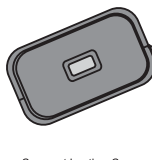
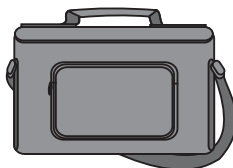
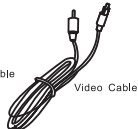
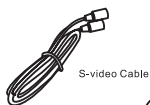
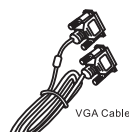
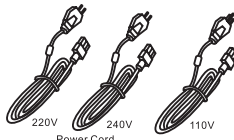
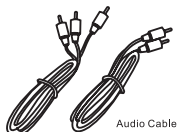
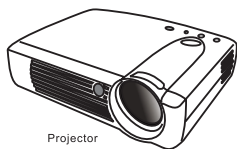

## Optional Accessories

1. Spare lamp kit
2. Macintosh Adaptor

# Projector Description

## Projector

1. External control panel (see next page)	9. Video connector
2. Projection lens	10. D-sub connector (for computer/ HDTV input)
3. Front adjustment feet	11. Audio input
4. IR remote sensor	12. Rear adjustment feet
5. Ventilation grill	13. Lamp access door (underneath unit)
6. Kensington lock	
7. AC power cord input	
8. S-video connector	

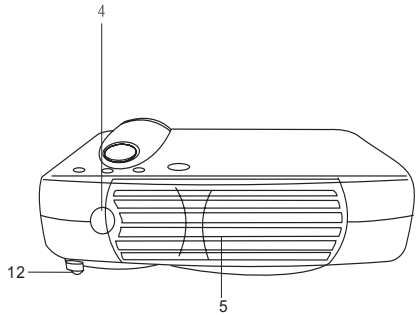
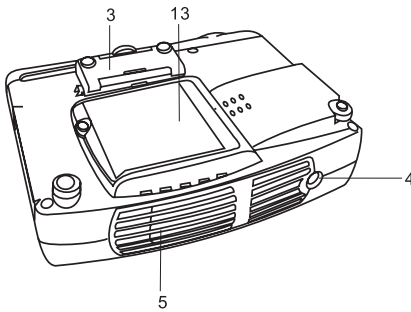
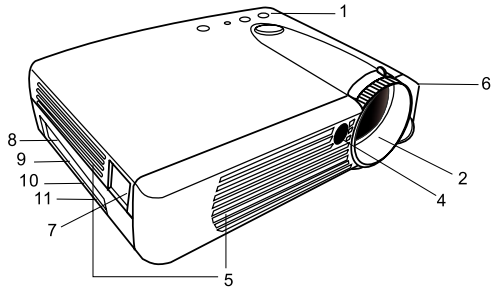

## External Control Panel

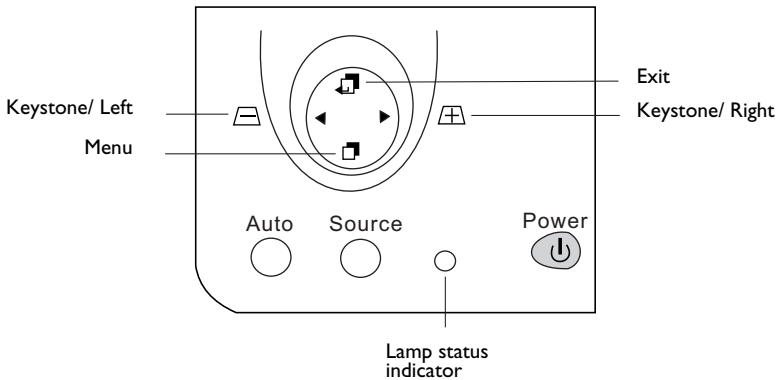

- The **Infrared Remote Receiver (Front and Rear)** allows the projector to accept signals from the remote control. For best results, be sure to aim the control toward the sensor without any obstructions between the two, and at a distance no greater than 6 meters.
- **Menu** will display the menu system on screen. Press **Menu** again to access the sub-menus. **Left** and **Right** help you navigate among choices and settings in the menus and sub-menus. However, when the on screen menu is not activated, the **Left** and **Right** buttons will function as **Keystone +/-** hot keys.
- Press the **Exit** button to go back to the main menu. Press **Exit** again to leave the menu system.
- The **Status Indicator** will blink or light up when the lamp needs service, cooling or replacement. See "Lamp Information" on page 19. for more detailed information.
- When the projector is on, **Back-lit Power** will blink during warm-up and turn to solid green to indicate the projector is ready for use.
- Press **Power** for 1 second to turn the projector on or off.
- **Auto** key: Automatically sense the best picture quality for current received signals.
- **Source** key: Select signal sources, PC, Video, S-video and YPbPr.

## Adjuster

The projector is equipped with a quick-release adjuster foot and button for adjusting its tilt angle.

1. Lift the projector up and press the adjuster button to release the adjuster.
2. The adjuster will drop into position and be locked.

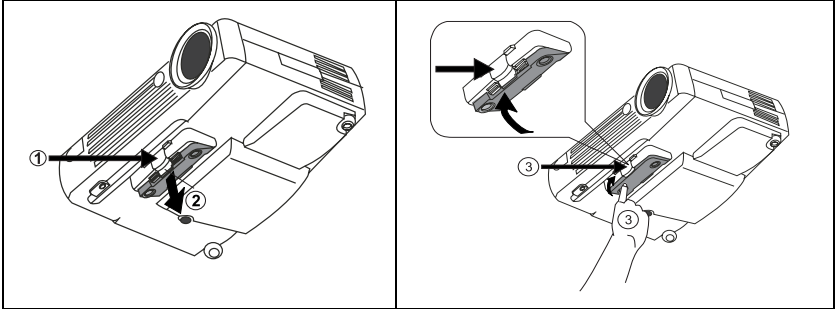

## Projector Features

The Projector integrates high performance optical engine projection and user-friendly design to deliver high reliability and ease of use experience.

The Projector offers the following features:

- Compact and portable unit
- Full-function remote control
- One key auto-adjustment to display the best picture quality
- Easy digital keystone correction through hot keys to correct tilted pictures
- Adjustable color balance control for data/video
- Ultra-high brightness projection lamp
- Ability to display high quality 16.7 million colors
- On screen menus in 7 languages: English, French, German, Italian, Spanish, Simplified Chinese, and Traditional Chinese.
- Powerful AV function to provide high AV picture results.
- HDTV compatibility (YPbPr)

**Note: The brightness of your machine will vary depending on the ambient room conditions and contrast/brightness settings.**

## Remote Control Description

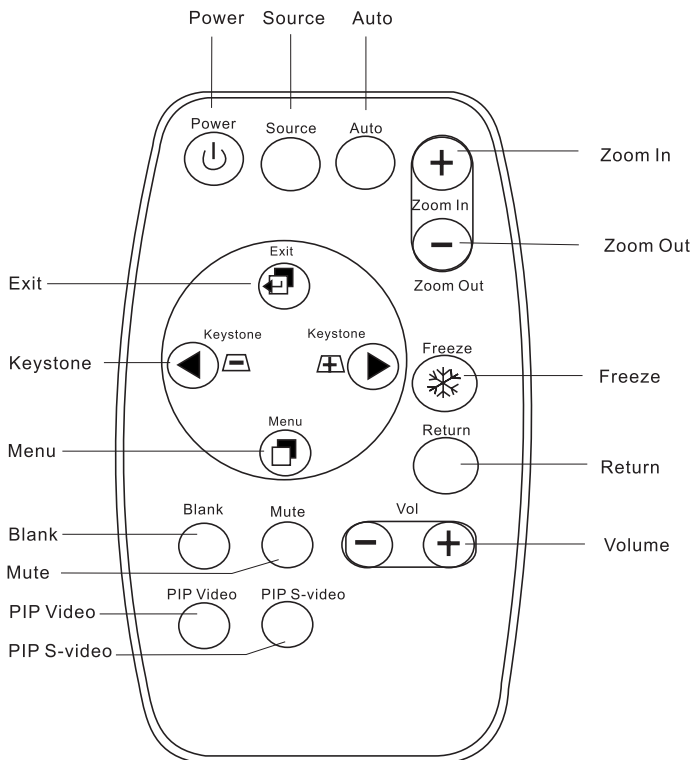

## Remote Control Features

The remote control sensors are located in the front/ back of the projector. The distance between the sensor and the remote control should not exceed 6 meters.

## FREEZE

The image can be frozen when FREEZE is pressed. A “Pause” icon will appear in the lower right corner of the screen for three seconds. To release the freeze function, press the FREEZE button, RETURN button or SOURCE button (when the input source is switched over during display) again. A “Play” icon will appear in the lower right corner of the screen for three seconds when the freeze function is released.

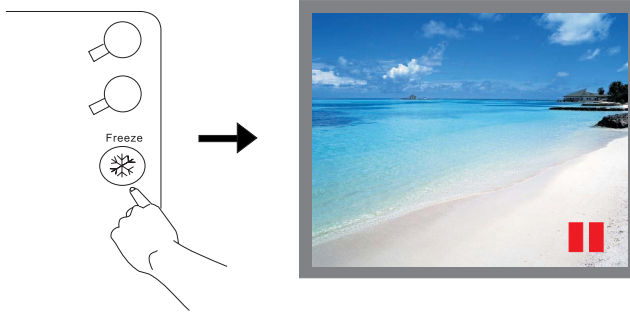

## ZOOM IN/OUT

By pressing ZOOM IN +, the center of the picture will be magnified. When the + button is pressed again, the picture is further magnified, up to four times the original size. By pressing ZOOM OUT -, the size of the image is reduced. When the - button is pressed again, the picture is further reduced until it is restored to its original size. To return to the normal display mode, press the RETURN button. (This function can be used in combination with FREEZE.)

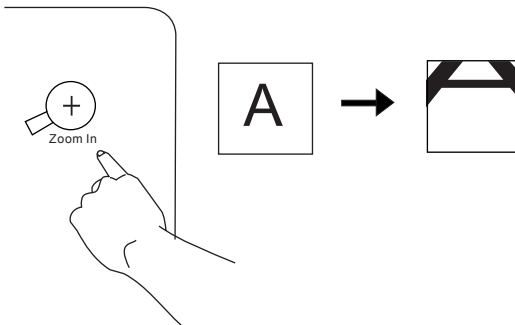

---

## Installing or Replacing Batteries

- Push and slide the battery compartment lid in the direction shown.
- Install a battery as indicated by the diagram inside the compartment.
- Position the lid over the compartment and snap it back into place.

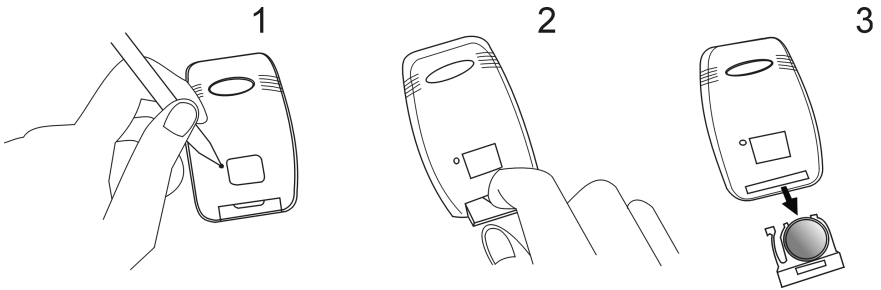

---

### **Caution**

**Avoid excessive heat and humidity. Danger of explosion may happen if a battery is incorrectly replaced. Replace only with the same or equivalent type recommended by the manufacturer. Dispose of used batteries according to the manufacturer's instructions.**

---

# INSTALLATION

## Screen Size

Place the projector at the required distance from the screen according to the desired picture size (see the table below).

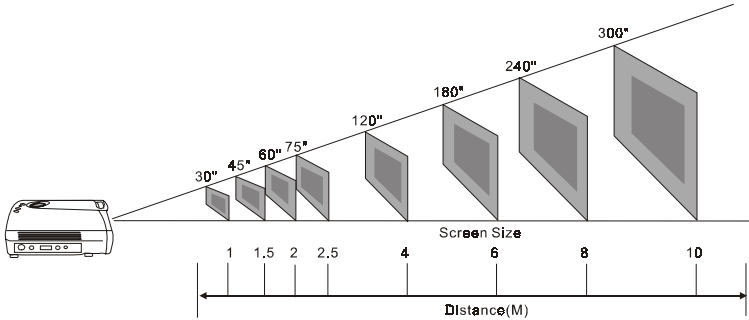

Max.Zoom	30"	45"	60"	75"	90"	120"	150"	180"	210"	240"	270"	300"
Distance(m)	1	1.5	2	2.5	3	4	5	6	7	8	9	10

## Connecting to Various Equipment

It only takes a few seconds to connect your projector to your computer/notebook, VCR or other systems. However, a Mac adapter (an optional accessory) is needed for connection for Macintosh users.

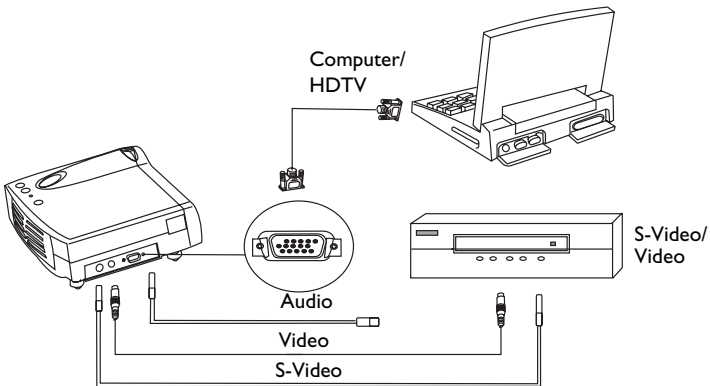



# OPERATION

## Start Up

1. Plug the power cord into a wall socket.
2. Press POWER for 1 second.

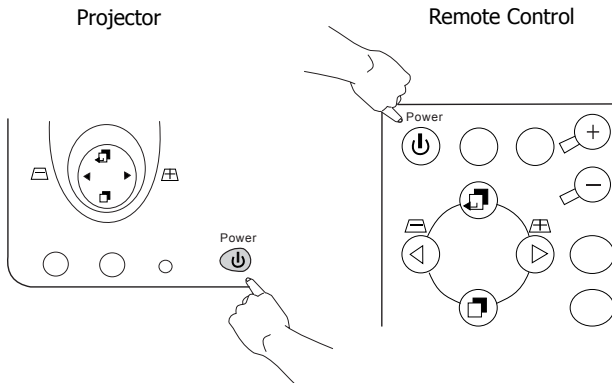
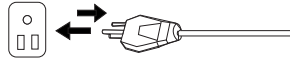

- The back-lit POWER key blinks green and stays green when the power is turned on.  
(When the power is turned off, there is a 60-second cooling period before the projector can be re-started.)
3. Switch on all connected equipment.

## Digital Keystone Correction

Keystoning is when the projected image is noticeably wider on either the top or bottom. To correct this, press **KEYSTONE +/-** (hot key) on the control panel of the projector or on the remote control, then adjust the sliding bar labeled **Keystone**, as needed. Press **+** to correct keystoning at the top of the image. Press **-** to correct keystoning at the bottom of the image.

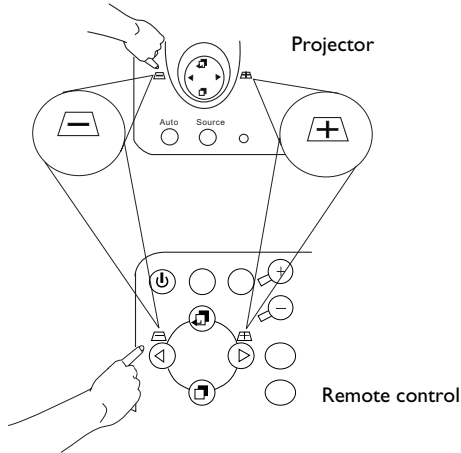

## Auto Adjustment

In some cases, you may have to optimize the picture quality manually. To do this, press the **AUTO** key on the control panel of the projector or on the remote control. Within 3 seconds, the built-in Intelligent Auto Adjustment function will re-adjust to the best picture quality.

Projector

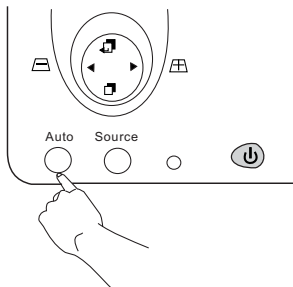

Remote control

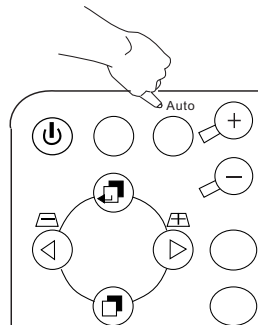

## Source Selection

When several input sources are available, press the **SOURCE** key to make a selection from the control panel of the projector or the remote control.

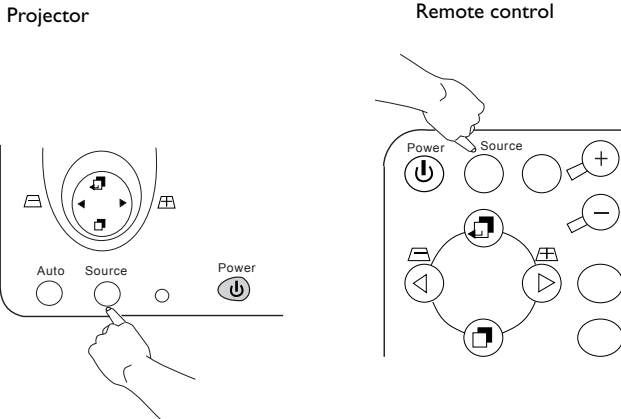



## Menu System

Press **Menu** for the main menu and press ◀ or ▶ to select a sub-menu. Press **Menu** again to select items in the sub-menu.

Menu Bar					
Sub-menu	Display	Image	Source	Control	PIP
<b>PC</b>	Keystone Brightness Contrast Phase H.Size	Auto resize H-position V-position Color Temp Information	Mirror Source Volume Treble Bass Mute	Language OSD OSD Time Auto Off Reset Lamp hour	<b>Main page:</b> PIP Source PIP Size PIP Pos. H. Position V.Position More Options  <b>Sub Page:</b> Brightness Contrast Color Tint Sharpness System
<b>Y/Pb/Pr</b>		Auto resize H-position V-position Color Tint Color Temp			
<b>Video</b>		Keystone Brightness Contrast Color Tint	Ratio System Sharpness Color Temp Information		

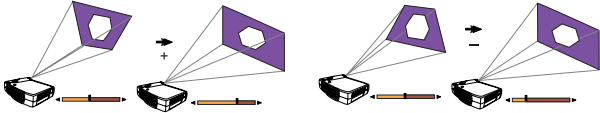
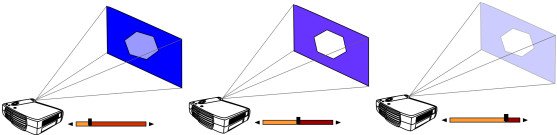
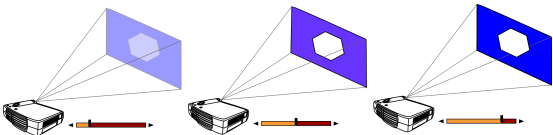
## I. Display Menu





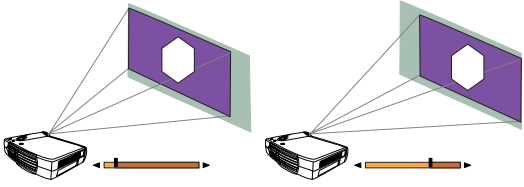
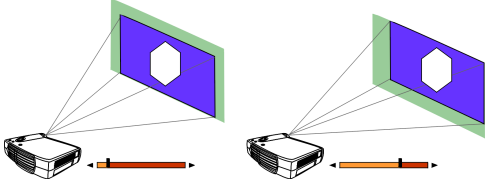

<p><b>Keystone</b></p>	<p>Corrects the keystone of the image.</p> 
<p><b>Brightness</b></p>	<p>Adjusts the brightness of image.</p> 
<p><b>Contrast</b></p>	<p>Adjusts the degree of difference between darkness and lightness of image.</p> 
<p><b>Phase</b></p>	<p>Adjusts to fit in the desired image size.</p>  <p><i>*This function is not available when the input mode are Video, S-video.</i></p>
<p><b>H.Size</b></p>	<p>Adjusts to avoid the occurrence of flicker.</p> <p><i>*This function is not available when the input mode are Video, S-video.</i></p>
<p><b>Color</b></p>	<p>Adjusts to increase or decrease the colors (R, G, B) of image.</p> <p><i>*This function is not available when the input mode is PC.</i></p>
<p><b>Tint</b></p>	<p>Adjusts to make the image look more red or blue.</p> <p><i>*This function is not available when the input mode is PC.</i></p>

## 2. Image Menu

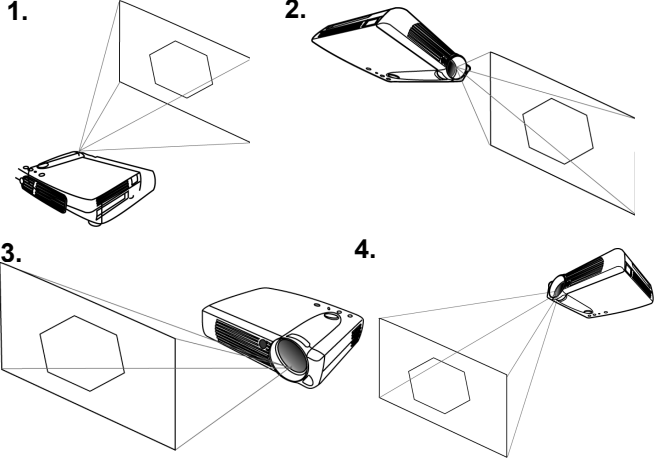
The following functions are available when the input mode is PC.

<b>Auto resize</b>	Makes the best fit of the image to the screen,  <b>OFF ON</b>
<b>H-position</b>	Adjusts the horizontal position of image.  
<b>V-position</b>	Adjusts the vertical position of image.  
<b>Color Temp.</b>	Adjusts the color temperature to fit your preference.
<b>Information</b>	Shows the current resolution.
<b>Ratio</b>	Users have 2 options for the image ratio. 1. 4:3 (Normal) 2. 16:9 (Wide) <b>*This function is not available when the input mode are PC, YPbPr.</b>
<b>System</b>	4 modes can be selected. 1. Auto 2. PAL-M 3. PAL-N 4. SECAM <b>*The default setting of System is Auto.</b> <b>*This function is not available when the input mode are PC, YPbPr.</b>
<b>Sharpness</b>	Adjusts to make the image look sharper or softer. <b>*This function is not available when the input mode are PC, YPbPr.</b>
<b>Color</b>	Adjusts to increase or decrease the colors (R, G, B) of image. <b>*This function is not available when the input mode is PC.</b>
<b>Tint</b>	Adjusts to make the image look more red or blue. <b>*This function is not available when the input mode is PC.</b>

### 3. Source Menu

<p><b>Mirror</b></p> <ol style="list-style-type: none"> <li>1. Default</li> <li>2. Ceiling - mounted projection</li> <li>3. Rear screen projection</li> <li>4. Ceiling - mounted and rear screen projection</li> </ol>	
<p><b>Source</b></p>	<p>Selects sources between PC, Video, S-video, and YPbPr.</p>
<p><b>Volume</b></p>	<p>Adjusts the volume level.</p> 
<p><b>Treble</b></p>	<p>Adjusts the treble level.</p> 
<p><b>Bass</b></p>	<p>Adjusts the bass level.</p> 
<p><b>Mute</b></p>	<p>Off  On </p>

## 4. Control Menu

<b>Language</b>	Language sets the OSD to display in one of 7 languages. Use Left/Right key to select the languages: English, French, German, Italian, Spanish, Simplified Chinese and Traditional Chinese.
<b>OSD</b>	Selects a desired OSD position.
<b>OSD Time</b>	Sets the length of time the OSD will remain active after the last time you pressed the button. The range is from 5 to 60 seconds in 5-second increments.
<b>Auto Off</b>	Sets the length of time to shut off the system when no input is detected.
<b>Reset</b>	Returns all settings the time of manufacturing.
<b>Lamp hour</b>	Shows lamp usage time.

## 5. PIP Menu

These functions are valid only when the input mode is PC and the PIP source is Video or S-video.

<b>PIP Source</b>	Selects the source from which the PIP picture comes.
<b>PIP Size</b>	Uses ◀ / ▶ key to scroll through the 4 alternatives: Off, Small, Medium, Large.
<b>PIP Position</b>	Selects a desired PIP position.
<b>H Position</b>	Adjusts the horizontal position of PIP image.
<b>V Position</b>	Adjusts the vertical position of PIP image.
<b>More Options</b>	Uses ◀ / ▶ key to select more PIP functions including Brightness, Contrast, Color, Tint, Sharpness and System.
<b>Brightness</b>	Adjusts the brightness of PIP image.
<b>Contrast</b>	Adjusts the degree of difference between darkness and lightness of PIP image.
<b>Color</b>	Adjusts to increase or decrease the colors (R, G, B) of image.
<b>Tint</b>	Adjusts to make the image look more red or blue.
<b>Sharpness</b>	Adjusts to make the image look sharper or softer
<b>System</b>	Selects PIP image systems: Auto, NTSC, PAL, SECAM

## Shutdown

1. Press **POWER** and a warning message will prompt up. To turn off the projector, Press **POWER** again.
2. The fan will continue to run for approximately 60 seconds.

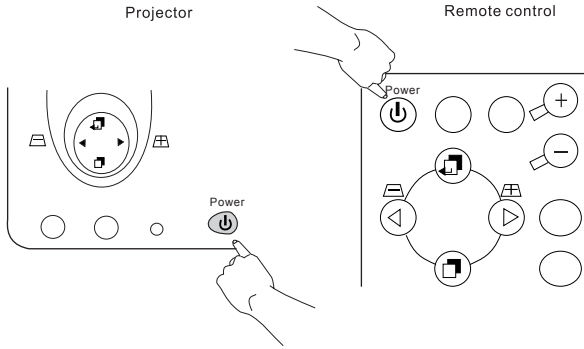

Are You Sure Power Off?  
Press "Power" Again to Power Off.

3. Disconnect the power cord from the wall socket.

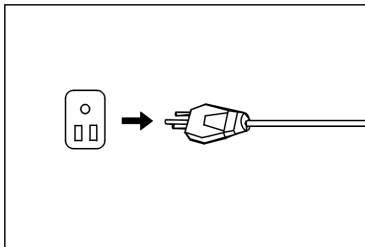

### Caution

Please do not unplug the power cord before **POWER** is shut down or during the 60-second cooling process.



# MAINTENANCE

## Lamp Information

### Use and Replacement of Lamp

When the Lamp Indicator lights up red or a message displays to suggest the time of lamp replacement, please change a new lamp or consult your dealer. An old lamp could cause a malfunction to the projector and may explode.

### LED Status Indicators

<b>Lamp Life Indicators</b>	When this LED shows red continuously, it is warning you that the lamp life has exceeded <b>1500</b> hours. Replace the projection lamp with a new one immediately.
<b>CHANGE THE LAMP, AND RESET THE LAMP TIMER</b>	The lamp has been in operation for 1400 hours. Change a new lamp for optimal performance.
<b>CHANGE THE LAMP. THE POWER WILL TURN OFF AFTER 20 HOURS</b>	The lamp has been in operation for 1480 hours, and the power will turn off after 20 hours.
<b>CHANGE THE LAMP!</b>	The lamp has been in operation for over 1500 hours. The warning message will display for 30 seconds every 5 minutes after you turn on the projector and the power will turn off automatically in 10 minutes.
<b>Lamp is not properly attached</b>	LED blinks rapidly.
<b>Temperature is too high</b>	When the projector's internal temperature is too hot to operate safely, the LED blinks slowly for one minute and the lamp turns off automatically. If the LED light is off, the projector's lamp and temperature are operating under normal conditions.

### Caution

**The LAMP indicator will light up if the lamp becomes too hot. Turn off the power and let the projector cool for 45 minutes. If the LAMP indicator is still red when turning the power on, please contact your dealer.**

## Lamp Replacement

### Caution

**To reduce the risk of electrical shock, always turn off the projector and disconnect the power cord before changing the lamp.**

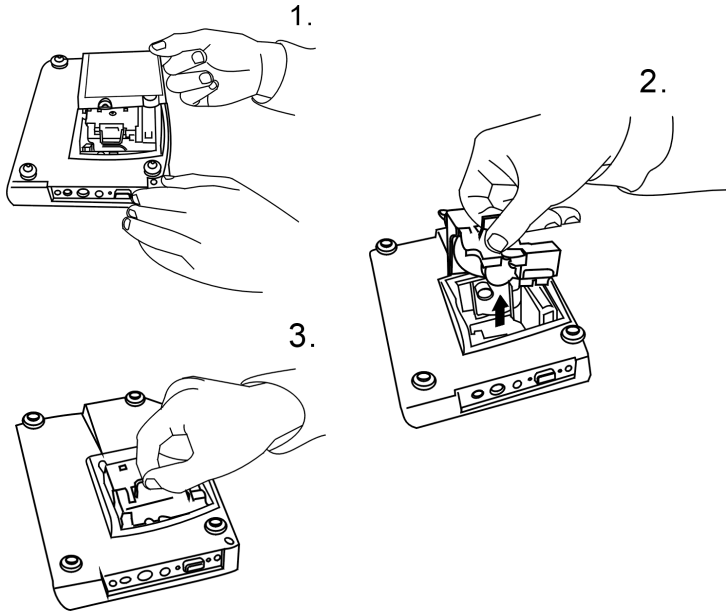

1. Press the **POWER** button to switch off the projector. Disconnect the power cord from the outlet and the projector.
2. Loosen the screw and remove the lamp cover. If the lamp is hot, avoid burns by waiting 45 minutes until the lamp has cooled.
3. Loosen the 3 screws. (It is strongly recommended you use a magnetic-headed screwdriver.) Pull the handle to remove the lamp housing. If the screws are not loosened completely, they could injure your fingers. Do not insert your hand into the box after the lamp is removed. If you touch the optical parts inside, this could cause color unevenness.
4. Replace the lamp with a new one. Insert it into the projector, and tighten the screws firmly. Loose screws may cause a bad connection, which may result in malfunction.
5. Re-install the lamp cover and tighten the screw. **Do not turn on the power with the lamp cover removed.** Whenever the lamp is replaced, reset the total lamp operation time. Do not reset if the lamp is not replaced as this could cause breakage.

## Caution

To reduce the risk of severe burns, allow the projector to cool for at least 45 minutes before replacing the lamp.



To reduce the risk of injuries to fingers and damage to internal components, use caution when removing lamp glass that has shattered into sharp pieces.

To reduce the risk of injuries to fingers and/or decreasing image quality by touching the lens, do not touch the empty lamp compartment when the lamp is removed.

This lamp contains mercury. Consult your local hazardous waste regulations to dispose of this lamp in a proper manner.

## Resetting Lamp Hours

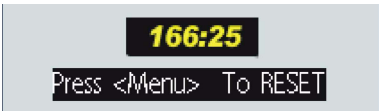
If you replace the lamp after 1500 hours of operation, please proceed as follows within 10 minutes of power on.

OSD	FUNCTION
	Press the Exit button on the projector for 3 seconds to display the total used lamp time.
	<ul style="list-style-type: none"> <li>• Press the MENU button on the projector during the lamp hour message. An adjustment message will appear.</li> <li>• Press ◀ or ▶ to rest lamp hours or press EXIT to leave.</li> </ul>

## Service Information

### Accessories (Included in the standard package)

<b>Description</b> .....	<b>Part Number</b>
Power cord (EU) .....	27.01218.191
Power cord (US) .....	27.01118.131
Power cord (UK) .....	27.02718.201
Signal cable .....	50.J0508.502
Video cable .....	50.J1303.501
S-Video cable .....	50.72920.011
PC - PC Audio cable .....	50.74405.501
Audio - PC Audio cable .....	50.J0705.501
Soft carrying case .....	98.J1302.001
Lens cover .....	60.J1334.001
Remote control .....	98.J2401.001
3-2 converter .....	22.91007.001
Skin case .....	98.J1904.001

### Optional Accessories (Not Included in the standard package)

<b>Description of parts</b> .....	<b>Part number</b>
Mac Adapter (switchable) .....	20.20118.A15
120W Lamp module .....	60.J1322.001
HDTV Cable .....	50.J2401.001

### Ordering Parts or Getting Information

For product information, product assistance, service information, or to order accessories, please contact Benq corporation. at <http://www.benq.com>.

# TROUBLESHOOTING

## Common Problems & Solutions

PROBLEMS	TRY THESE SOLUTIONS
<b>NO POWER</b>	<ul style="list-style-type: none"> <li>• Plug the power cord into the AC inlet.</li> <li>• Plug the power cord into the power inlet.</li> <li>• Wait two minutes after the projector is turned off before turning the projector back on.</li> </ul>
<b>NO PICTURE</b>	<ul style="list-style-type: none"> <li>• Check for the proper input source.</li> <li>• Ensure all cables are connected properly.</li> <li>• Adjust the brightness and contrast.</li> <li>• Remove the lens cap.</li> </ul>
<b>TRAPEZOID IMAGE ON THE SCREEN</b>	<ul style="list-style-type: none"> <li>• Reposition the unit to improve its angle on the screen.</li> <li>• Use the <b>Keystone</b> correction key on the control panel of the projector or the remote control unit.</li> </ul>
<b>POOR COLOR</b>	<ul style="list-style-type: none"> <li>• Select the correct video system.</li> <li>• Adjust brightness, contrast, or saturation.</li> </ul>
<b>BLURRED IMAGE</b>	<ul style="list-style-type: none"> <li>• Press <b>Auto</b> on the control panel of the projector or the remote control unit to get better picture quality.</li> <li>• Adjust the focus.</li> <li>• Reposition the unit to improve its screen angle.</li> <li>• Ensure the distance between the unit and screen is within the adjustment range of the lens.</li> </ul>
<b>REMOTE CONTROL DOES NOT WORK</b>	<ul style="list-style-type: none"> <li>• Replace the batteries with new ones.</li> <li>• Make sure there is no obstacle between the remote control and the unit.</li> <li>• Stand within 4 meters (13 feet) of the unit.</li> <li>• Make sure nothing blocking the front and rear receivers.</li> </ul>

## Status Messages

On Screen Messages	Description
<b>SEARCHING</b>	Projector is searching for input.
<b>INPUT SIGNAL DETECTED, ACTIVATING AUTO IMAGE</b>	Projector has identified the input signal and is running the auto image adjustment function.
<b>SYNC IS OUT OF RANGE</b>	Input signal frequency exceeds the projector's.
<b>CHANGE THE LAMP, AND RESET THE LAMP TIMER</b>	The lamp has been in operation for 1200 hours. Lamp replacement is recommended.
<b>CHANGE THE LAMP, THE POWER WILL TURN OFF AFTER 20 HOURS</b>	The lamp has been in operation for 1480 hours, and the power will turn off after 20 more hours. Replace the lamp as soon as possible.
<b>CHANGE THE LAMP!</b>	The lamp has been in operation for over 1500 hours, and the power will turn off automatically in 10 minutes. Replace the lamp immediately.

# SPECIFICATIONS

## Projector Specifications

### Technical Specifications

**Note: All specifications are subject to change without notice.**

#### General

Product name	Personal Projector	
Model name	SL703S (SVGA)	800X600 SVGA

#### Optical

Display system	I-CHIP DMD
Lens F/Number	F/2.6
Lamp	120W VIP lamp

#### Electrical

Power supply	AC100 ~ 240V, 2.3A, 50/60 Hz (Automatic)
Power consumption	185 W (Max)

#### Mechanical

Dimensions	220 mm (W) x 52 mm (H) x 175 mm (D)
Operating Temperature range	10°C ~ 40°C
Weight	3.4 lbs (1.5 Kg)

#### Input terminal

Computer Input	
RGB/ HDTV Input	D-sub 15-pin (female)
Video Signal Input	
S VIDEO	Mini DIN 4-pin terminal
VIDEO	RCA Jack terminal
Audio Signal Input	
Audio	Mini Jack Stereo Terminal

#### Output

Speaker	1 Watt x 1
---------	------------

## Timing Chart

Resolution	H Sync (kHz)	V Sync (Hz)	Remark
640x350	31.5	70.1	
640x400	37.9	85.1	VESA
720x400	31.5	70.0	
720x400	37.9	85.1	VESA
640x480	31.5	60.0	VESA
640x480	37.9	72.8	VESA
640x480	35.0	66.7	Macintosh
640x480	43.3	85.0	VESA
800x600	35.2	56.3	VESA
800x600	37.9	60.3	VESA
800x600	46.9	75.0	VESA
800x600	48.1	72.2	VESA
800x600	53.7	85.1	VESA
832x624	49.7	74.5	Macintosh
1024x768	48.4	60.0	VESA
1024x768	56.5	70.1	VESA
1024x768	60.0	75.0	VESA
1024x768	68.7	85.0	VESA
1280x1024	64.0	60.0	VESA



# DIMENSIONS

