

myprojectorlamps.com

**The most trusted, dependable name
in projector lamp sales.**



<http://www.myprojectorlamps.com>



<http://www.myprojectorlamps.ca>



<http://www.myprojectorlamps.eu>

The following projector manual has not been modified or altered in any way.

BenQ

PE5120 Digital Projector

Home Entertainment Series

User's Manual

Welcome

Copyright

Copyright © 2004 by BenQ Corporation. All rights reserved. No part of this publication may be reproduced, transmitted, transcribed, stored in a retrieval system or translated into any language or computer language, in any form or by any means, electronic, mechanical, magnetic, optical, chemical, manual or otherwise, without the prior written permission of BenQ Corporation.

Disclaimer

BenQ Corporation makes no representations or warranties, either expressed or implied, with respect to the contents hereof and specifically disclaims any warranties, merchantability or fitness for any particular purpose. Further, BenQ Corporation reserves the right to revise this publication and to make changes from time to time in the contents hereof without obligation of BenQ Corporation to notify any person of such revision or changes.

*DLP, Digital Micromirror Device and DMD are trademarks of Texas Instruments. Others are copyrights of their respective companies or organizations.

Table of Contents

Safety, regulatory and legal information	5
FCC statement (for U.S. users)	5
EEC statement (for European users)	5
MIC statement	5
Safety instructions	5
Moisture condensation	6
Avoid using volatile liquids	6
Disposal	6
Overview	7
Features	7
Accessories	7
Projector exterior view	7
Front / upper side	7
Rear side	8
Bottom side	8
Rear connector panel	8
Controls and functions	9
Projector	9
Remote control	9
Positioning your projector	11
Choosing a location	11
Obtaining a preferred projected image size	12
Ceiling installation for a 16:9 ratio screen	12
Floor installation for a 16:9 ratio screen	12
Ceiling installation for a 4:3 ratio screen	13
Floor installation for a 4:3 ratio screen	13
Connecting various equipment	14
Connecting video inputs	14
Connecting component-video devices	14
Connecting S-video or video device	14
Connecting a computer	14
Using the projector and remote control	15
Preparations	15
Turning the power on	15
Switching input signals	15
Adjusting the image	15
Adjusting the angle height	15
Auto-adjusting the image	16
Correcting Keystone picture distortion	16

Fine-tuning the image size and clarity	16
Optimizing the image	17
Personalizing the projector menu display	17
Turning the power off	18
Using the on-screen display menus	19
Menu structure	19
How to use the on-screen display menus	19
Picture menu	20
Pro-picture menu	21
Setting menu	21
Advance menu	21
Information menu	21
Additional information	22
Care of the projector	22
Cleaning the lens	22
Cleaning the projector case	22
Storing the projector	22
Transporting the projector	22
Replacing the lamp (contact your BenQ dealer for assistance)	22
Indicator lights	24
Service information	24
Troubleshooting	25
Specifications	26
Optical characteristics	26
Electrical characteristics	26
Input terminal	26
Output terminal	26
General characteristics	26
Dimensions	26

1 Safety, regulatory and legal information

Thank you for your purchase of this quality BenQ video projector! It has been designed to provide you with a home theater viewing experience. For the best result, please read this manual carefully as it is your best guide to the control menus and product operation.

FCC statement (for U.S. users)

This equipment has been tested and found to comply with the limits for a Class B digital device, pursuant to Part 15 of the FCC Rules. These limits are designed to provide reasonable protection against harmful interference in a residential installation.

CLASS B: This equipment generates, uses and can radiate radio frequency energy and, if not installed and used in accordance with the instructions, may cause harmful interference to radio communications. However, there is no guarantee that interference will not occur in a particular installation. If this equipment does cause harmful interference to radio or television reception, which can be determined by turning the equipment off and on, the user is encouraged to try to correct the interference by one or more of the following measures:

- Reorient or relocate the receiving antenna.
- Increase the distance between the equipment and receiver.
- Connect the equipment into an outlet on a circuit different from that to which the receiver is connected.
- Consult the dealer or an experienced radio/TV technician for help.

EEC statement (for European users)

This machine was tested against the 89/336/EEC (European Economic Community) for EMC (Electro Magnetic Compatibility) and fulfills these requirements.

MIC statement

B class equipment (Household purpose info/telecommunications equipment)

As this equipment has undergone EMC registration for household purpose, this product can be used in any area including residential areas.

Safety instructions

Your BenQ projector is designed and tested to meet the latest standards for safety of information technology equipment. However, to ensure safe use of this product, it is important that you follow the instructions mentioned in this manual and marked on the product.

1. To reduce the risk of electric shock, do not disassemble this appliance. There are no user serviceable parts inside. Take it to a qualified technician when service or repair is required. Incorrect reassembly can cause malfunction of the projector or electric shock when the appliance is subsequently used.
2. Please read this user's manual before you operate your projector. Save this user's manual for future reference.
3. Refer servicing only to qualified service personnel.
4. Always open the lens shutter or remove the lens cap when the projector lamp is on.
5. Do not look straight at the projector lens during operation. The intense light beam may damage your eyes.
6. In some countries, the line voltage is NOT stable. This projector is designed to operate safely with a mains voltage between 100 and 240 volts AC, but could fail if power cuts or surges of ± 10 volts occur. In areas where the mains voltage may fluctuate or cut out, it is recommended that you connect your projector through a power stabilizer, surge protector or uninterruptible power supply (UPS).
7. The lamp becomes extremely hot during operation. Allow the projector to cool for approximately 45 minutes prior to removing the lamp assembly for replacement.

8. Do not operate lamps beyond the rated lamp life. Excessive operation of lamps beyond the rated life could cause them to explode on rare occasions.
9. Never replace the lamp assembly or any electronic components unless the projector is unplugged.
10. Do not place this product on an unstable cart, stand, or table. The product may fall, sustaining serious damage.
11. This product is capable of displaying inverted images for ceiling mount installation. Please use BenQ's Ceiling Mounting Kit for mounting the projector and ensure it is securely installed.
12. Do not block the ventilation holes.
 - Do not place the projector on a blanket, bedding or any other soft surface.
 - Do not cover the projector with a cloth or any other item.
 - Do not place inflammables near the projector.If the ventilation holes are seriously obstructed, overheating inside the projector may cause damage to the lamp, the projector to fail or result in fire.
13. Do not place the projector in any of the following environments.
 - Space that is poorly ventilated or confined. Allow at least 50 cm clearance from walls and free flow of air around the projector.
 - Locations where temperatures may become excessively high, such as the inside of a car with all windows rolled up.
 - Locations where excessive humidity, dust, or cigarette smoke may contaminate optical components, shortening the projector's lifespan and darkening the screen.
 - Locations near fire alarms
 - Locations with an ambient temperature above 35°C / 95°F
 - Locations where altitude are higher than 10000 feet.
14. Always place the projector on a level, horizontal surface during operation.
 - Do not use if tilted at an angle of more than 10 degrees left to right, nor at angle of more than 15 degrees front to back. Using the projector when it is not fully horizontal may cause a malfunction of, or damage to, the lamp or other components.
15. Do not stand the projector on end vertically. Doing so may cause the projector to fall over, causing injury or resulting in damage to it.
16. Do not step on the projector or place any objects upon it. Besides probable physical damage to the projector, doing so may result in accidents and possible injury.
17. Do not place liquids near or on the projector. Liquids spilled into the projector may cause it to fail. If the projector does become wet, disconnect it from the power supply's wall socket and call BenQ to have the projector serviced.

Moisture condensation

Never operate the projector immediately after moving it from a cold location to a hot location. When the projector is exposed to such a change in temperature, moisture may condense on the crucial internal parts. To prevent the projector from possible damage, do not use the projector for at least 2 hours after a sudden change in temperature.

Avoid using volatile liquids

Do not use volatile liquids, such as insecticide or some types of cleaner, near the projector. Do not leave rubber or plastic products touching the projector for a long time. They will leave marks on the finish. When cleaning, be sure to follow the cleaning product's safety instructions.

Disposal

This product contains the following materials which are harmful to humans and the environment.

- Lead, which is contained in solder.
- Mercury, which is used in the lamp.

To properly dispose of the product or used lamps, consult your local environmental authority for advice.

2 Overview

Features

The projector integrates high-performance optical engine projection and a user-friendly design to deliver high reliability and ease of use.

The projector offers these following features:

- Compact and portable unit
- One-key auto-adjustment to display the best picture quality
- Ultra-high brightness projection lamp
- Ability to display 16.7 million colors
- On-screen menus in 10 languages: English, French, German, Italian, Spanish, Russian, Traditional Chinese, Simplified Chinese, Japanese and Korean.
- 8 sets of preset mode
- 5-segment color wheel
- Powerful AV function
- 26dB Noise Level under Economic Mode
- Native 16:9 aspect ratio
- HDTV compatibility

 **Note:** The apparent brightness of the projected image will vary depending on the ambient lighting conditions and contrast/brightness settings.

Accessories

The standard accessories that came with your projector can be found on the included Quick Start Guide. Optional accessories are listed below. You can purchase these accessories through your projector dealer. Refer to page 24 for a full list of the accessories part numbers which may help you obtain the proper part from your dealer easier.

1. Ceiling mount kit
2. Spare lamp kit
3. DVI cable

Projector exterior view

Front / upper side

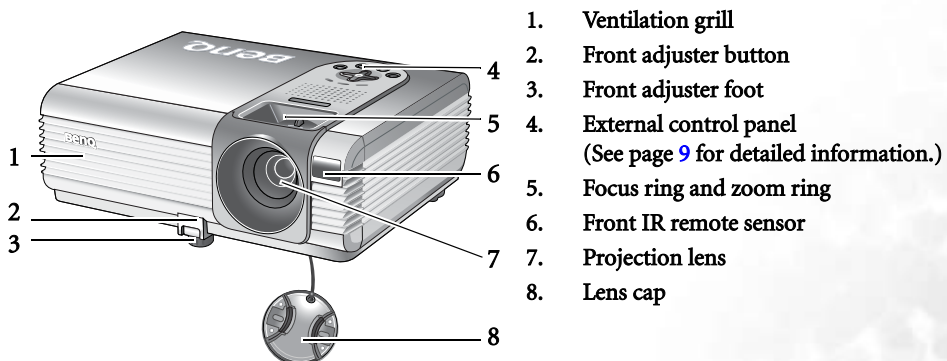

Rear side

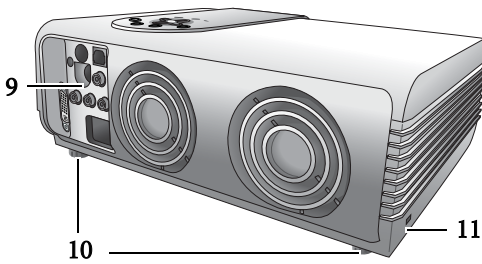

- 9. Connector panel (See below for more information.)
- 10. Rear adjuster feet
- 11. Kensington lock slot

Bottom side

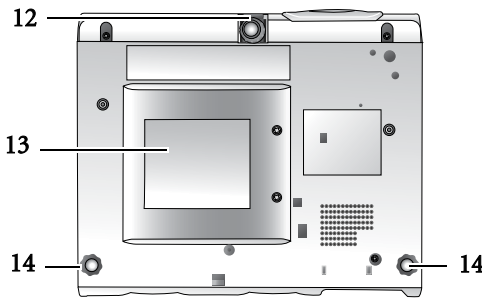

- 12. Front adjuster foot
- 13. Lamp door
- 14. Rear adjuster feet

Rear connector panel

Refer to page 14 for more information on making connections to various equipment.

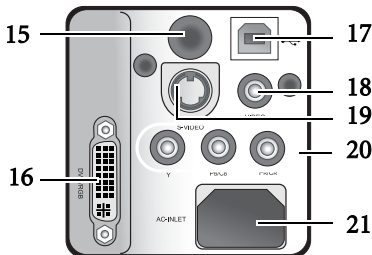

- 15. Rear IR remote sensor
- 16. DVI-I Video digital input
- 17. USB port (for servicing)
- 18. Composite Video analog input
- 19. S-Video input
- 20. Component Video input
- 21. Power cable socket

Controls and functions

Projector

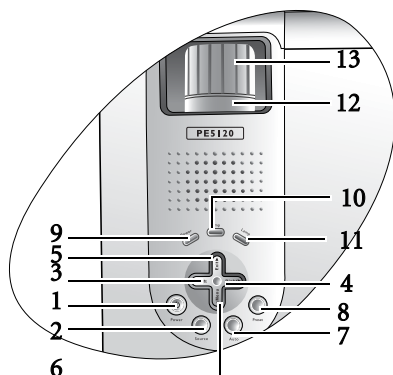

- 1. Power (Refer to pages 15 and 18 for more information.)**
Turns the projector on or off.
- 2. Source (Refer to page 15 for more information.)**
Sequentially selects the input signal Component Video, DVI-D, Video, S-Video or DVI-A.
- 3. ◀ Left**
- 4. Right ▶**
When the on-screen menu is not activated, #3 and #4 function as **Keystone -/+** hot keys.
- 5. ▲ Exit**
Exits and saves the menu settings.
- 6. ▼ Menu**
Turns the on-screen menu on.

When the on-screen menu is activated, the #3 to #6 buttons are used as directional arrows to select the desired menu items and to make adjustments.

Refer to page 19 for more information.
- 7. Auto (Refer to page 16 for more information.)**
Automatically determines the best picture timings for the displayed image.
- 8. Preset (Refer to page 17 for more information.)**
Selects one of the preset modes to suit your program type.
- 9. Power indicator light (Refer to page 24 for more information.)**
Lights up or flashes when the projector is under operation.
- 10. Temperature warning light (Refer to page 24 for more information.)**
Lights up if the projector's temperature becomes too high.
- 11. Lamp indicator light (Refer to page 24 for more information.)**
Indicates the status of the lamp. Lights up when the lamp has developed a problem.
- 12. Zoom ring (Refer to page 16 for more information.)**
Adjusts the size of the image.
- 13. Focus ring (Refer to page 16 for more information.)**
Adjusts the focus of the projected image.

Remote control

Notes on remote control operation

- Make sure that there is nothing between the remote control and the IR sensors on the projector that might obstruct the infrared beam.
- The effective range of the remote control is up to 8 meters from the front of the projector or 8 meters from the rear of the projector. The remote control must be held at an angle within 22.5 degrees of the projector's IR remote control sensor.

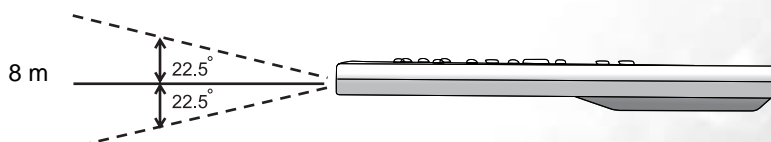

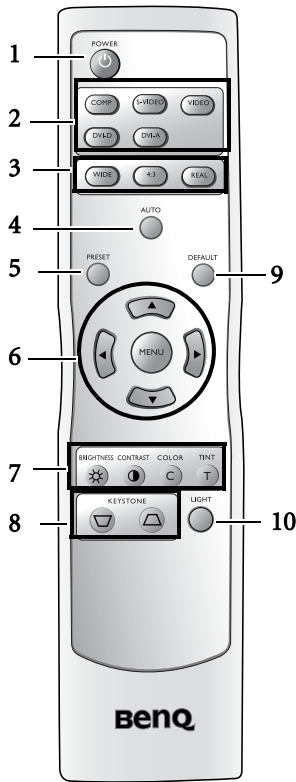

1. **Power** (Refer to pages 15 and 18 for more information.)
Hold this button down for one second to turn the projector on. Press this button twice to turn the projector off.
2. **Source buttons** (Refer to page 15 for more information.)
Selects an input signal to display on the projector.
3. **Aspect buttons**
Selects an image aspect ratio to suit the input signal.
4. **Auto** (Refer to page 16 for more information.)
Automatically determines the best picture timings for the displayed image.
5. **Preset** (Refer to page 17 for more information.)
Selects one of the preset modes to suit your program type.
6. **Menu and directional buttons** (▲/◀/▼/▶) (Refer to page 19 for more information.)
Press **Menu** to turn the on-screen menu on.
Press directional buttons to select the desired menu items and make adjustments.
Exit and saves menu settings by pressing **Menu** again.
7. **Picture quality adjustment buttons** (Refer to 20 for more information.)
8. **Keystone buttons** (Refer to 16 for more information.)
Press ▽ to reduce the upper portion of the image. Press △ to reduce the lower portion of the image.
9. **Default**
Returns all settings to the factory preset values.
10. **Light**
Turns the remote control's backlight on or off.

Replacing the batteries in the remote control

1. Push and open the battery compartment lid in the direction shown.
2. Install batteries as indicated by the diagram inside the compartment.
3. Insert the lid hinge into the compartment end and close the lid.

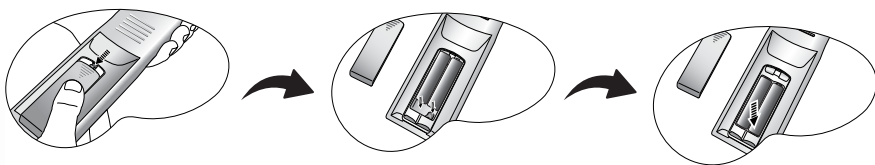

⚠ Caution with batteries

- Avoid leaving the remote control and batteries in an excessive heat or humid environment like the kitchen, bathroom, sauna, sunroom, or in a closed car.
- Take care to align the polarities when installing the batteries. Be aware that there is the possibility of an explosion if the batteries are incorrectly fitted.
- Replace batteries only with the same or equivalent type as recommended by the battery manufacturer.
- Dispose of used batteries according to the battery manufacturer's instructions and local environment regulations for your region.
- If the remote control will not be used for an extended period of time, remove the batteries to avoid damage to the control from possible battery leakage.

3 Positioning your projector

Choosing a location

Your projector is designed to be installed in one of four possible installation locations:

1. Floor in front of screen;
2. Ceiling in front of screen;
3. Floor at rear of screen; or
4. Ceiling at rear of screen.

Your room layout or personal preference will dictate which installation location you select. Take into consideration the size and position of your screen, the location of a suitable power outlet, as well as the location and distance between the projector and the rest of your equipment.

I. Floor front:

Select this location with the projector placed near the floor in front of the screen. This is the most common way to position the projector for quick setup and portability.

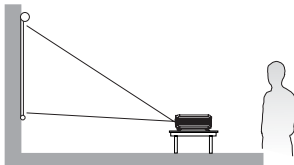

II. Ceiling front:

Select this location with the projector suspended from the ceiling in front of the screen.

Purchase the BenQ Projector Ceiling Mounting Kit from your dealer to mount your projector on the ceiling.

Set in the **Setting > Mirror** menu after you turn the projector on.

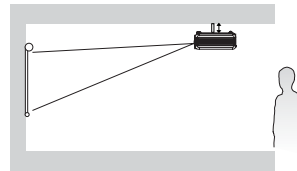

III. Floor rear:

Select this location with the projector placed near the floor behind the screen.

Note that a special rear projection screen is required.

Set in the **Setting > Mirror** menu after you turn the projector on.

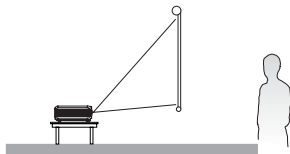

IV. Ceiling rear:

Select this location with the projector suspended from the ceiling behind the screen.

Note that a special rear projection screen and the BenQ Projector Ceiling Mounting Kit are required for this installation location.

Set in the **Setting > Mirror** menu after you turn the projector on.

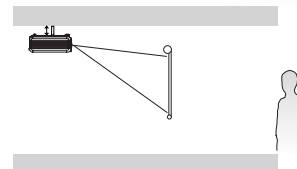

For Setting menu options and descriptions, please refer to page 21.

Obtaining a preferred projected image size

The distance from the projector lens to the screen, the zoom setting, and the video format each factors in the projected image size. BenQ has provided separate tables of dimensions for both 16:9 and 4:3 screen ratios to assist you in determining the ideal location for your projector.

1. Determine the aspect ratio of your screen, (16:9 or 4:3) ?
2. Select the **Screen Size** you desire from the 16:9 ratio screen dimension table or 4:3 ratio screen dimension table below, according to what screen type you have. Install the projector at a distance from the screen corresponding to between the **Min.** and **Max. Projection Distance** values in the table.
3. Decide the exact height of your projector.

For example, if you are using a 16:9 screen with 80 inches diagonal, you are suggested to place your projector within a range between 2.76m to 3.39m from the screen. The exact height of your projector will be 33 to 34cm above or below your screen from the center of the lens.

Ceiling installation for a 16:9 ratio screen

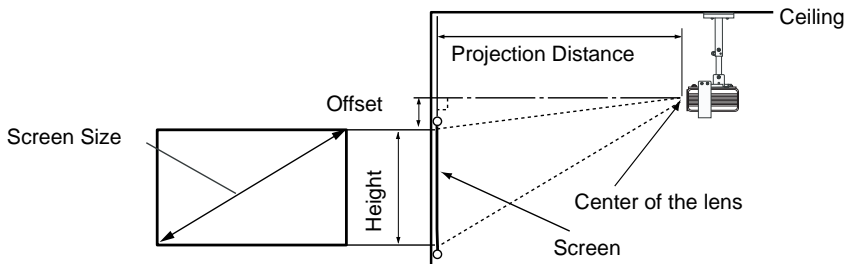

Floor installation for a 16:9 ratio screen

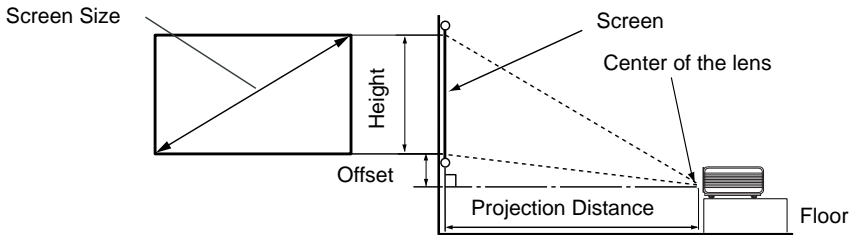

16:9 (widescreen) ratio screen dimension table

Screen Size			Projection Distance		Height Offset	
Type (inch) / (cm)	Height (inch) / (cm)	Width (inch) / (cm)	Min. (inch) / (cm)	Max. (inch) / (cm)	Tele (inch) / (cm)	Wide (inch) / (cm)
50 / 127	24.4 / 62	43.7 / 111	68.1 / 173	83.5 / 212	8.5 / 21	7.9 / 20
60 / 152	29.5 / 75	52.4 / 133	81.5 / 207	100.0 / 254	9.8 / 25	9.8 / 25
70 / 178	34.8 / 87	61.0 / 155	95.3 / 242	116.9 / 297	11.4 / 29	11.4 / 29
80 / 203	39.4 / 100	69.7 / 177	108.7 / 276	133.5 / 339	13.4 / 34	13.0 / 33
90 / 229	44.1 / 112	78.4 / 199	122.4 / 311	150.0 / 381	15.0 / 38	14.6 / 37
100 / 254	49.2 / 125	87.0 / 221	135.8 / 345	167.0 / 424	16.5 / 42	16.1 / 41
110 / 279	54.8 / 137	96.1 / 244	149.6 / 380	183.5 / 466	18.1 / 46	17.7 / 45
120 / 305	58.7 / 149	104.7 / 266	163.0 / 414	200.0 / 508	19.7 / 50	19.3 / 49
130 / 325	63.8 / 162	113.4 / 288	176.8 / 449	216.9 / 551	21.7 / 55	20.9 / 53
140 / 356	68.5 / 174	122.1 / 310	190.1 / 483	233.5 / 593	23.2 / 59	22.4 / 57
150 / 381	73.6 / 187	130.7 / 332	203.9 / 518	250.4 / 636	24.8 / 63	24.0 / 61
160 / 406	78.4 / 199	139.4 / 354	217.7 / 553	266.9 / 678	26.4 / 67	25.6 / 65
170 / 432	83.5 / 212	148.0 / 376	231.1 / 587	283.5 / 720	28.0 / 71	27.6 / 70
180 / 457	88.2 / 224	156.7 / 398	244.5 / 621	300.4 / 763	29.9 / 76	29.1 / 74
190 / 483	93.3 / 237	165.8 / 421	258.3 / 656	316.9 / 805	31.5 / 80	30.7 / 78
200 / 508	98.0 / 249	174.4 / 443	272.1 / 691	333.5 / 847	33.1 / 84	32.3 / 82

An examination of the table reveals that you can place the projector lens in the range from 1.73 to 8.47m distance from the screen, which will give you a projected image from 1.11 x 0.62m to 4.43 x 2.49m full screen.

Ceiling installation for a 4:3 ratio screen

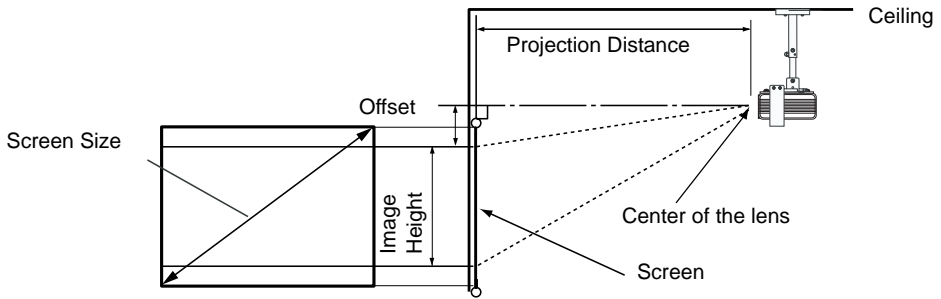

Floor installation for a 4:3 ratio screen

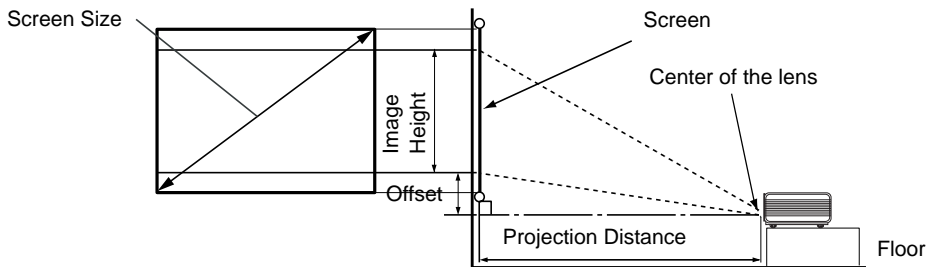

4:3 (standard) ratio screen dimension table:

Screen Size			Projection Distance		Height Offset		Image Height (inch) / (cm)
Type (inch) / (cm)	Height (inch) / (cm)	Width (inch) / (cm)	Min. (inch) / (cm)	Max. (inch) / (cm)	Tele (inch) / (cm)	Wide (inch) / (cm)	
50 / 127	29.9 / 76	40.2 / 102	68.1 / 173	83.5 / 212	8.5 / 21	7.9 / 20	24.4 / 62
60 / 152	35.8 / 91	48.0 / 122	81.5 / 207	100.0 / 254	9.8 / 25	9.5 / 24	29.5 / 75
70 / 178	42.1 / 107	55.9 / 142	95.3 / 242	116.9 / 297	11.4 / 29	11.4 / 29	34.3 / 87
80 / 203	48.0 / 122	64.2 / 163	108.7 / 276	133.5 / 339	13.4 / 34	13.0 / 33	39.4 / 100
90 / 229	53.9 / 137	72.1 / 183	122.4 / 311	150.0 / 381	15.0 / 38	15.4 / 37	44.1 / 112
100 / 254	59.8 / 152	79.9 / 203	135.8 / 345	167.0 / 424	16.5 / 42	16.1 / 41	49.2 / 125
110 / 279	66.1 / 168	88.2 / 224	150.5 / 380	183.5 / 466	18.1 / 46	17.7 / 45	53.9 / 137
120 / 305	72.1 / 183	96.1 / 244	163.0 / 414	200.0 / 508	19.7 / 50	19.3 / 49	58.7 / 149
130 / 325	78.0 / 198	103.9 / 264	178.0 / 449	216.9 / 551	21.7 / 55	20.9 / 53	63.8 / 162
140 / 356	83.9 / 213	111.8 / 284	190.1 / 483	233.5 / 593	23.2 / 59	23.8 / 57	68.5 / 174
150 / 381	90.2 / 229	120.1 / 305	204.0 / 518	250.4 / 636	24.8 / 63	24.0 / 61	73.6 / 187
160 / 406	96.1 / 244	139.4 / 354	217.7 / 553	266.9 / 678	26.4 / 67	25.6 / 65	78.4 / 199
170 / 432	102.0 / 259	148.0 / 376	231.1 / 587	283.5 / 720	28.0 / 71	27.6 / 70	83.5 / 212
180 / 457	107.9 / 274	156.7 / 398	244.9 / 622	300.4 / 763	29.9 / 76	29.1 / 74	88.2 / 224
190 / 483	114.2 / 290	165.8 / 421	258.3 / 656	316.9 / 805	31.5 / 80	30.7 / 78	93.3 / 237
200 / 508	120.1 / 305	174.4 / 443	272.1 / 691	333.5 / 847	33.1 / 84	32.3 / 82	98.0 / 249

 The above numbers are approximate and may be slightly different from the actual measurements.

An examination of the table reveals that you can place the projector lens in the range from 1.73 to 8.47m distance from the screen, which will give you a projected image from 1.02 x 0.62m to 4.43 x 2.49m.

4 Connecting various equipment

When connecting any signal source to the projector, be sure to:

1. Turn off all equipment before making any connections.
2. Use the correct signal cable for each source.
3. Ensure the cables are firmly inserted.
4. Connect all audio signals to external speakers. This projector is not equipped with speakers.

 In the connections shown below, only certain cables are included in the standard package. If you need other cables, please contact your place of purchase or nearby electronics stores.

Connecting video inputs

Connecting component-video devices

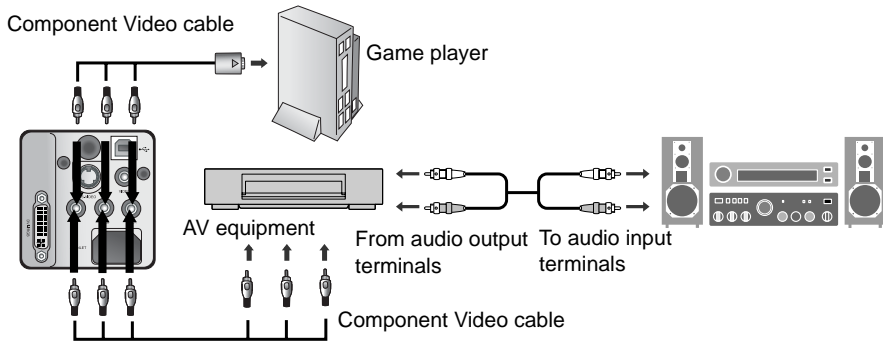

Connecting S-video or video device

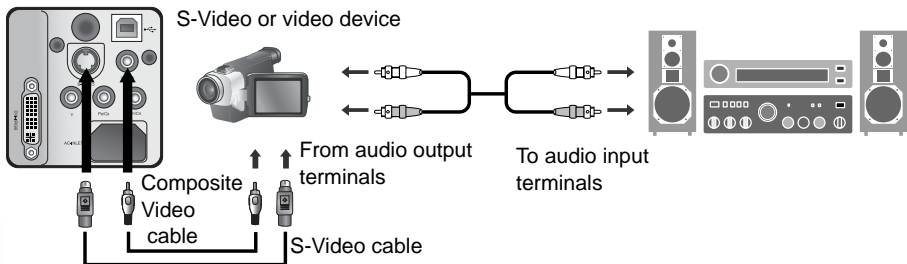

 If the selected video image is not displayed after the projector is turned on and the correct video source has been selected, please check that the video source is turned on and operating correctly. Also check that the signal cables have been connected correctly.

Connecting a computer

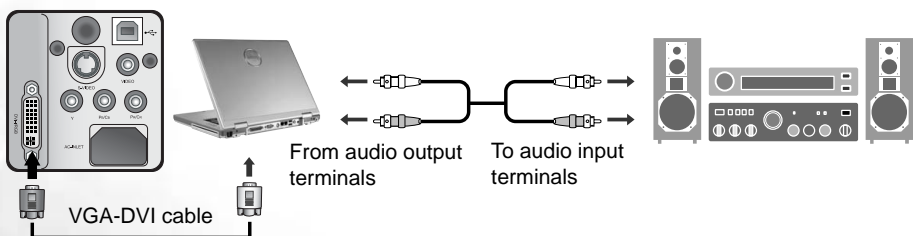

5 Using the projector and remote control

Preparations

1. Turn all of the connected equipment on.
2. Remove the lens cap.
3. Plug the supplied power cord into the AC inlet on the rear of the projector.
4. Plug the power cord into a wall socket and turn the wall switch on.

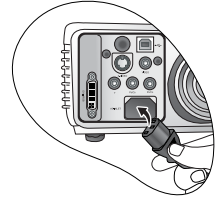
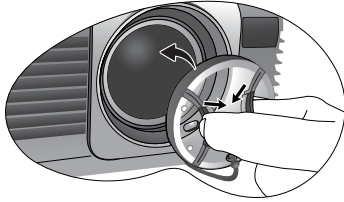

Turning the power on

1. Check that the Power indicator lights orange after power has been applied.
2. Press and hold the **Power** button on the projector or remote control to turn the projector on. The Power indicator light flashes for about 30 seconds during warm up, then remains constantly on (and the projector starts projecting) when ready.
3. Press **Source** on the projector or one of the Source buttons on the remote control to select your desired input signal. A message shows on the screen when the port is being searched. If you would like to change the input signal, please see below.

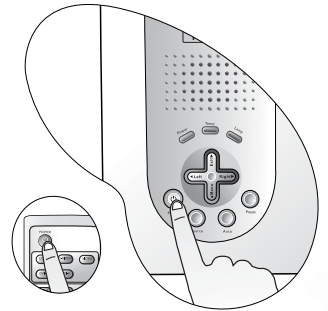

Switching input signals

To sequentially select input signals, press one of the Source buttons on the remote control or **Source** on the projector.

The selected source will be displayed at the bottom right of the screen for 3 seconds.

-  **Activate the Source Scan function in the Advance menu if you want the projector to automatically search input ports. It may take a few seconds for the projector to search for input signals.**

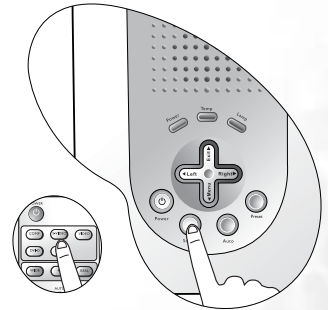

Adjusting the image

Adjusting the angle height

The projector is equipped with 1 front quick-release adjuster foot and 2 rear adjuster feet. These adjusters change the image height and projection angle. To adjust the projector:

1. Lift the projector up and press the adjuster button to release the adjuster. The front adjuster foot will drop into position and lock into place when you release the button. It can lift the projector by up to 15 degrees. Manually screw it up or down for fine height adjustment.
2. Screw the rear adjuster feet to adjust the horizontal angle so that the projector is stable and the projection is level.

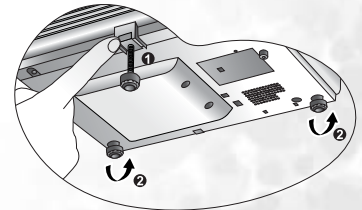

Auto-adjusting the image

With one press of the Auto button on the projector or remote control, the built-in intelligent Auto-adjustment function will re-adjust the values of Frequency and Clock to provide the best image quality.

The current source information will be displayed at the bottom right of the screen for 3 seconds.

 **The screen will be blank while Auto adjustment is functioning.**



Correcting Keystone picture distortion

Keystone picture distortion (keystoning) occurs in situations where the projector is not perpendicular and level with the centre of the screen. It results in the projected image being wider at either the top or bottom of the image, (seen in the shape of a building stone archway keystone ∇).

If you cannot alter the location of the projector, you can manually correct for it by following any one of these steps:

- Press **Left** or **Right** (hot key) on the projector to display the status bar labelled Keystone. Press **Left** to correct keystone at the top of the image. Press **Right** to correct keystone at the bottom of the image.
- Press ∇ or \triangle on the remote control to display the status bar labelled Keystone, then press ∇ to correct keystone at the top of the image or press \triangle to correct keystone at the bottom of the image.

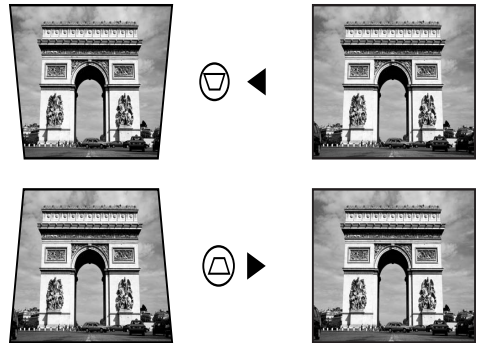
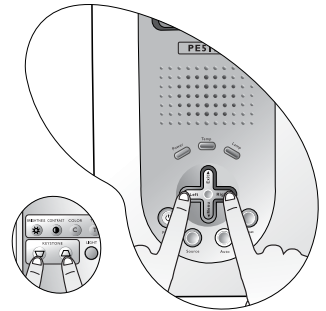

Fine-tuning the image size and clarity

1. Adjust the projected image to the size that you need using the zoom ring.

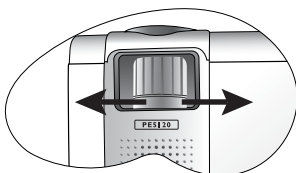
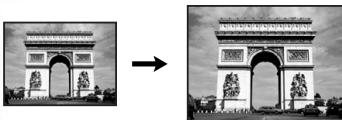

2. Then sharpen the image by rotating the focus ring.

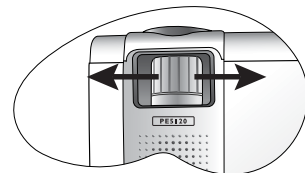

Optimizing the image

Use the remote control or on-screen menus to optimize the image. For the operation of on-screen menus, please refer to page 19.

The following steps are optional. You do not need to follow every step. It depends on the image quality you desire.

1. Select a preset mode on the projector, remote control, or in  **Picture > Preset Mode**.
There are 4 modes available for each input.

DVI-A / DVI-D Video input

- **Presentation Mode:** is designed for presentations. The brightness is emphasized in this mode.
- **Vivid Mode:** is perfect for playing games. The color saturation and brightness are well-balanced.
- **Video Mode:** is suitable for cinematic enjoyment displaying images in their natural color.
- **Economic Mode:** is used to reduce system noise and reduce power consumption by 20%. The lamp life is also extended with lower light output.

Component Video / RCA Analog Video / S-Video input

- **Gaming Mode:** is suitable for playing video games in a bright living room.
- **Video Mode:** with a higher color temperature, it is suitable for enjoying TV movies.
- **Cinema Mode:** with a lower color temperature, it is suitable for enjoying cinematic movies.
- **Economic Mode:** is used to reduce system noise and reduce power consumption by 20%. The lamp life is also extended with lower light output.



2. Change the image ratio using the remote control or in  **Pro-Picture > Aspect Ratio**.

3. You can adjust Brightness and Contrast settings for a DVI-A or DVI-D image using the  **Picture** menu or with the remote control. Alternatively, you can adjust the Brightness, Contrast, Color, and Tint settings whilst viewing a Component Video, Composite Video or S-Video input.

 **Some picture adjustments are available only when certain input ports are in use. Unavailable adjustments are not shown on the screen. Refer to page 19 for functions available for each signal type.**

Personalizing the projector menu display

The On Screen Display (OSD) menus can be set according to your preferences. These settings will not affect the projection settings, operation, or performance.

- **OSD Time** in  **Setting** Menu sets the length of time the OSD will remain active after your last button press.
- **Language** in  **Setting** menu sets your familiar language for the on-screen menus.
- **User Logo** in  **Advance** menu defines which logo screen will appear during projector start-up.

Turning the power off

1. Press **Power** and an on-screen prompt displays. Press **Power** a second time to turn the projector off.
2. The **Power indicator light** flashes and the lamp shuts down, however, the fan continues to run for approximately 110 seconds to cool down the projector.

 **To protect the lamp, the projector will not respond to any commands during the cooling process.**

3. Only after you notice that the fan has stopped, should you disconnect the power cord from the wall socket and the projector.

 **Do not unplug the power cord before the projector shutdown sequence is complete or during the 110-second cooling down process.**



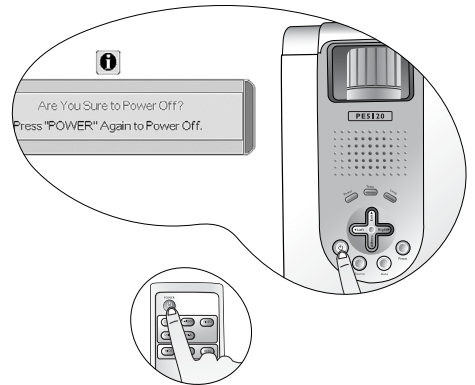

If the projector was not properly shut down, and you attempt to restart it soon thereafter, the fan may run for a few minutes to cool it down properly before you can restart. You will have to wait before you can press **Power again to start the projector after the fans stop.**



6 Using the on-screen display menus

Menu structure

The OSD (On Screen Display) menus vary according to the input signal type selected.

Functions available when receiving different signal types...				
Sub-Menu	DVI-A	DVI-D	Component Video	Composite Video / S-Video
 Picture	Preset Mode Color Temp Brightness Contrast		Preset Mode Color Temp Brightness Contrast Color Tint* Sharpness	
 Pro-Picture	Aspect Ratio H Position V Position Phase H. Size	Aspect Ratio		
 Setting	Language Mirror Keystone OSD Time Reset			
 Advance	Source Scan User Logo			
 Information	Source Resolution Preset Mode Lamp Hour Color Temp			Source System Preset Mode Lamp Hour Color Temp

*When a Composite Video or S-Video signal is connected, the function is only available with NTSC system selected.

How to use the on-screen display menus

The projector is equipped with multilingual on screen display (OSD)

menus for making various adjustments and settings. Select 

Setting > Language to select the OSD language before browsing through the menus.

The following example describes the adjustment of the keystone value.

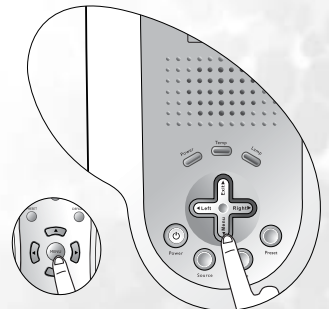

1. Press **Menu** on the projector or remote control to open the on-screen menu.

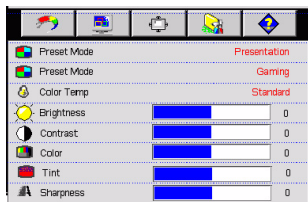

2. Press **Left** or **Right** on the projector or **Left** or **Right** on the remote control to select the  Setting menu.

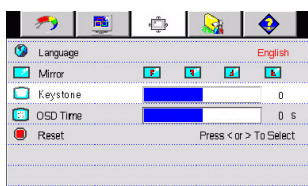

3. Press **Exit** or **Menu** on the projector or **Exit** or **Menu** on the remote control to select **Keystone**.

4. Adjust keystone values by pressing **Left** or **Right** on the projector or **Left** or **Right** on the remote control.

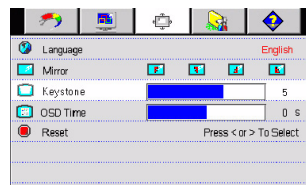

5. Press **Exit** twice* on the projector or press **Menu** on the remote control to leave and save the setting.

*The first press leads you back to the submenu and the second press closes the on-screen menu.

Picture menu

 Some picture adjustments are available only when certain input ports are in use. Unavailable adjustments are not shown on the screen. Refer to page 19 for functions available for each signal type.

1. **Preset Mode:** Preset modes are provided so you can optimize your projector image set-up to suit your program type. See page 17 for more information.
2. **Color Temp:** 3 color temperature settings are available.
 - Standard: Maintains normal colorings for white.
 - High: Makes images appear bluish white.
 - Low: Makes images appear reddish white.

3. **Brightness:** Adjusts the brightness of the image. The higher the value, the brighter the image. And lower the value, the darker the image. Adjust this control so the black areas of the image appear as black and that detail in the dark areas is visible.



-30



50



+70

4. **Contrast:** Adjusts the degree of difference between dark and light in the image. The higher the value, the greater the contrast.



-30



50



+70

5. **Color:** Increases or decreases the color intensity of the image.

6. **Sharpness:** Adjusts the image to make it look sharper or softer.

7. **Tint:** Adjusts the color tones of the image. The higher the value, the more reddish the image becomes. The lower the value, the more greenish the image becomes. When a Video or S-Video signal is connected, the function is only available with NTSC system selected.

 *About color temperatures:

There are many different shades that are considered to be “white” for various purposes. One of the common methods of representing white color is known as the “color temperature”. A white color with a low color temperature appears to be reddish white. A white color with a high color temperature appears to have more blue in it.

Pro-picture menu

 Some picture adjustments are available only when certain input ports are in use. Unavailable adjustments are not shown on the screen. Refer to page 19 for functions available for each signal type.

1. **Aspect Ratio:** There are three aspect ratio settings, 16:9, 4:3 and Real.
2. **H Position:** Adjusts the horizontal position of the projected image.

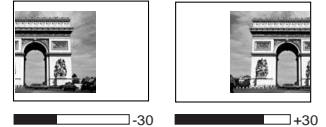

3. **V Position:** Adjusts the vertical position of the projected image.
4. **Phase:** This function allows you to adjust the clock phase to reduce image distortion.

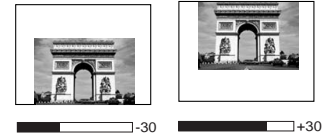

5. **H. Size:** Adjusts the horizontal width of the image.

Setting menu

1. **Language:** Sets the language for the OSD control menus.
2. **Mirror:** The projector can be installed on a ceiling or behind a screen, or with one or more mirrors. Contact your dealer for the ceiling mount bracket (optional accessory) if you need to install the projector on your ceiling. Refer to page 11 for more information.
3. **Keystone:** Corrects any keystone of the image. Refer to page 16 for more information.
4. **OSD Time:** Sets the length of time the OSD will remain active after your last button press. The range is from 5 to 100 seconds.
5. **Reset:** Returns all settings to the factory preset values.

Advance menu

1. **Source Scan:** Sets whether the projector searches automatically for input signals. If the source scan is on, the projector will scan for input signals until it acquires a signal. If the function is not activated, the projector selects the last input signal.
2. **User Logo:** Enables the user to select which logo screen will appear during projector start-up. Three modes are available: Default (BenQ logo), black screen or blue screen.

Information menu

This menu shows you the current operating status of the projector.

1. **Source:** Shows the current signal source.
2. **Resolution:** Shows the native resolution of the input signal.
3. **System:** Shows the Video input system format, NTSC, SECAM or PAL.
4. **Preset Mode:** Shows the selected mode in  **Picture** menu.
5. **Lamp Hour:** Displays the number of hours the lamp has been used.
6. **Color Temp:** Shows the selected color temperature.

Additional information

Care of the projector

Your projector needs little maintenance. The only thing you have to do on a regular basis is keep the lens clean. Never remove any parts of the projector except the lamp. Contact your dealer if other parts need replacing.

Cleaning the lens

Clean the lens whenever you notice dirt or dust on the surface. Before you attempt to clean the lens, turn the projector off, unplug the power cord, and leave it several minutes to cool completely.

- Use a canister of compressed air to remove dust. (Available from building hardware or photographic suppliers.)
- If there is stubborn dirt or smudge marks, use a proper photographic lens brush or moisten a clean soft lens cloth with lens cleaner to gently wipe the lens surface.

 **Never touch the lens with your finger or rub the lens with abrasive materials. Even paper towels can damage the lens coating. Only ever use a proper photographic lens brush, cloth, and cleaning solution. Do not attempt to clean the lens whilst the projector is switched on or is still hot from previous use.**

Cleaning the projector case

Before you attempt to clean the case, turn the projector off, unplug the power cord, and leave it several minutes to cool completely.

- To remove dirt or dust, wipe the case with a soft, dry, lint-free cloth.
- To remove stubborn dirt or stains, moisten a soft cloth with water and a neutral detergent. Then wipe the case.

 **Never use wax, alcohol, benzene, thinner or other chemical detergents. These can damage the case.**

Storing the projector

If you need to store the projector for an extended time, please:

- Make sure the temperature and humidity of the storage area are within the recommended range for the projector. Please refer to the Spec. page in this manual or consult your dealer about the range.
- Retract the adjuster feet.
- Remove the batteries from the remote control.
- Pack the projector in its original packing or equivalent.

Transporting the projector

It is recommended that you ship the projector with its original packing or equivalent. When you carry the projector yourself, please use the provided soft carry case.

Replacing the lamp (contact your BenQ dealer for assistance)

 **The lamp may be very hot. Allow the projector to cool for at least 45 minutes before replacing the lamp.**

This lamp contains mercury. Consult your local hazardous waste regulations to dispose of this lamp in a proper manner.

1. Turn the power off and disconnect the projector from the wall socket. Turn off all connected equipment and disconnect all other cables.
2. After it has cooled down, turn the projector over. Then loosen the screws and remove the lamp cover as indicated in the picture.

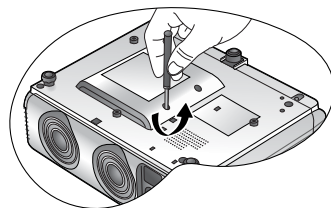

3. Move the latch to another end as shown in the picture.

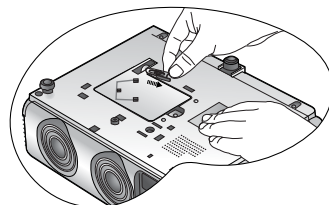

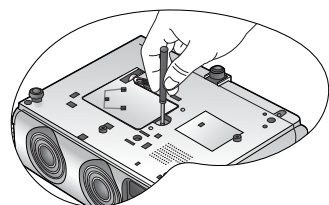

4. Loosen the screw that holds the lamp to the projector. If the screw is not loosened completely, they could injure your fingers. It is strongly recommended that you use a magnetic-head screwdriver to retain the screw should it come loose.



5. Lift the handle so that it stands up. Use the handle to slowly pull the lamp out of the projector.

 **Pulling it too quickly may cause the lamp to break and scatter broken glass in the projector. To reduce the risk of injuries to fingers and damage to internal components, use caution when removing lamp glass that has shattered.**

 **Do not place the lamp in locations where water might splash on it, children can reach it, near or above heat sources, or near flammable materials.**

 **Do not insert your hands into the projector after the lamp is removed. If you touch the optical components inside, it could cause color unevenness and distortion of the projected images.**

6. Insert a new lamp. Make sure the handle is fully locked, move the latch back, and tighten the screw firmly.

 **Loose screw may cause a bad connection, which could result in malfunction.**

 **Do not over tighten the screw.**

7. Re-install the lamp cover and tighten the screw. **Do not turn the power on with the lamp cover removed.** Whenever the lamp is replaced, reset the total lamp operation time. **Do not reset if the lamp is not replaced as this could cause damage.**

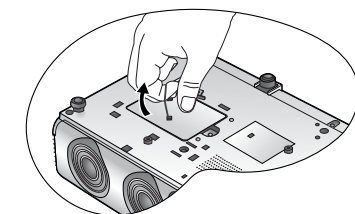

8. **Resetting the lamp counter**

- i. When the projector is next started, press and hold the Exit  button on the projector for 5 seconds to display the total used lamp time.
- ii. Press **Auto** on the projector or on the remote control to reset the lamp hour to "0".
- iii. Wait about 5 seconds to let the OSD close.

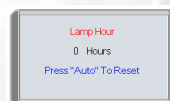
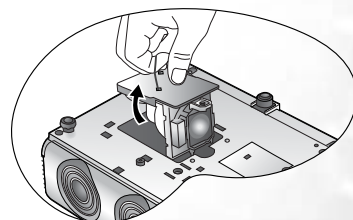

Indicator lights

There are three indicator lights which show the status of the projector. Refer to the following table for description of indicator light operation. If they indicate that something is wrong, note the light status, turn the projector off and contact your dealer.

When the projector is in a normal state ...

POWER	TEMP	LAMP	STATE	REMARK
Orange	Off	Off	Standby mode.	
Flashing Green			The projector is powering up.	Cannot turn the projector off.
Green			The projector is under normal operation.	
Flashing Orange			(1) The projector needs 110 seconds to cool down as it was abnormally shut down without the normal cooling down process. Or (2) The projector needs to cool for 110 seconds after the power is turned off.	Cannot turn the projector on.

When the projector is in an abnormal state ...

POWER	TEMP	LAMP	STATE	REMARK
Off	Off	Red	(1) The projector needs 110 seconds to cool down. Or (2) Please contact your dealer for assistance.	
Off	Red	Off	The projector has shutdown automatically.	If you try to re-start the projector, it will shutdown again. Please contact your dealer for assistance.
Off	Red	Green	The projector has shutdown automatically.	If you try to re-start the projector, it will shutdown again. Please contact your dealer for assistance.
Off	Red	Orange	The projector has shutdown automatically.	If you try to re-start the projector, it will shutdown again. Please contact your dealer for assistance.

Service information

Accessories

Description	Part Number	Description	Part Number
Power cord (US)	27.01818.000	Power cord (Japan).....	27.03518.151
Power cord (EU)	27.82718.281	S-Video cable	50.72920.011
Power cord (UK)	27.01018.000	Video cable	50.J1303.501

Power cord (Switzerland) 27.01218.051
 Power cord (Australia)..... 27.01343.001
 Component Video cable..... 50.J7111.501

Soft carry case..... 47.J9904.001
 Remote control..... 56.26J96.001

Optional accessories

Description of parts	Part number	Description of parts	Part number
200W lamp module	59.J9901.CG1	DVI-D cable	50.J5702.501
Ceiling mount kit.....	60.J7683.001		

Ordering spare parts or getting information

For product information, product assistance, service information, or to order accessories, please visit the BenQ Corporation website at <http://www.BenQ.com>.

Troubleshooting

Problem	Cause	Remedy
The projector does not turn on.	There is no power from the power cable.	Plug the power cord into the AC inlet on the rear of the projector, and plug the power cord into the power outlet. If the power outlet has a switch, make sure that it is switched on.
	Attempting to turn the projector on again during the cooling process.	Wait until the cooling down process has completed.
	The lamp cover is not securely attached.	Correctly attach the lamp cover.
No picture.	The video source is not turned on or connected correctly.	Turn the video source on and check that the signal cable is connected correctly.
	The projector is not correctly connected to the input source device.	Check the connection.
	The input signal has not been correctly selected.	Select the correct input signal with the Input buttons on the remote control or Source on the projector.
	The lens cap is still attached to the lens.	Remove the lens cap.
Image is unstable.	The connection cables are not securely connected to the projector or the signal source.	Correctly connect the cables to the appropriate terminals.
Picture is blurred.	The projection lens is not correctly focused.	Adjust the focus of the lens using the focus ring.
	The projector and the screen are not aligned properly.	Adjust the projection angle and direction as well as the height of the projector if necessary.
	The lens cap is still attached to the lens	Remove the lens cap.
Remote control does not work correctly	The batteries are out of power.	Replace both of the batteries with new ones.
	There is an obstacle between the remote control and the projector.	Remove the obstacle.
	You are too far away from the projector.	Stand within 8 meters (26.2 feet) of the projector.

Specifications

 All specifications are subject to change without notice.

Optical characteristics

Projection system	Single-chip DLP™ system.
DMD chip	0.53" DMD 480P (854 x 480)
Lens	1.22-times zoom ratio, F/# 2.4 - 2.6, f= 24.0 - 29.1 mm
Projection size	31 to 300 inches
Lamp	200W lamp

Electrical characteristics

Color system	NTSC / PAL-M / PAL-N / PAL 60 / SECAM
Resolution	SXGA, XGA, SVGA, VGA, Macintosh®, HDTV (1080i, 720p, 576p, 576i, 480p, 480i)
Max. number of display colors	16,770,000 colors (full color display)

Input terminal

DVI-I (DVI-A / DVI-D) X 1

Component RCA jack x 3

S-Video Mini DIN 4-pin port x 1

Composite Video RCA jack x 1

Output terminal

USB X 1

General characteristics

Dimensions	262 mm x 99 mm x 216 mm (W x H x D)
Weight	6.4 lbs / 2.9 kg
Power	VAC 100 - 240V, 3.2A, 50 / 60 Hz (Automatic)
Power consumption	285 W (Max)
Operating temperature	0°C - 40°C at sea level
Operating humidity	10% - 90% (without condensation)
Operating altitude	6000 feet at 30°C, 6000 - 10000 feet at max. 23°C
Storage temperature	-10°C - 60°C / 14°F - 140°F
Storage humidity	10% - 90%

Dimensions

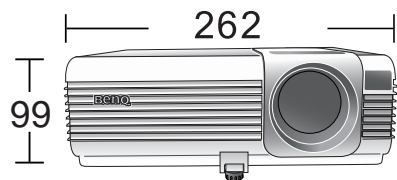

Unit: mm