

myprojectorlamps.com

**The most trusted, dependable name
in projector lamp sales.**



<http://www.myprojectorlamps.com>



<http://www.myprojectorlamps.ca>



<http://www.myprojectorlamps.eu>

The following projector manual has not been modified or altered in any way.

BenQ

PB8140 / PB8240 / PB8250 Digital Projector
Installation Series
User's Manual

Welcome

Copyright

Copyright 2004 by BenQ Corporation. All rights reserved. No part of this publication may be reproduced, transmitted, transcribed, stored in a retrieval system or translated into any language or computer language, in any form or by any means, electronic, mechanical, magnetic, optical, chemical, manual or otherwise, without the prior written permission of this company.

Disclaimer

BenQ Corporation makes no representations or warranties, either expressed or implied, with respect to the contents hereof and specifically disclaims any warranties, merchantability or fitness for any particular purpose. Further, BenQ Corporation reserves the right to revise this publication and to make changes from time to time in the contents hereof without obligation of this company to notify any person of such revision or changes.

*DLP, Digital Micromirror Device and DMD are trademarks of Texas Instruments. Others are copyrights of their respective companies or organizations.

Table of Contents

| | |
|---|----|
| Important Safety Instructions | 1 |
| Introduction | 5 |
| Projector Features | 5 |
| Shipping Contents | 6 |
| Optional Accessories | 7 |
| Projector Exterior View | 7 |
| Front / Upper View | 7 |
| Back View | 7 |
| Bottom View | 7 |
| Connector Panel | 8 |
| Controls and Functions | 9 |
| External Control Panel | 9 |
| Remote Control Description | 10 |
| Remote Control Effective Range | 11 |
| Installing or Replacing the Batteries | 12 |
| Setting Up Your Projector | 13 |
| Choosing a Location | 13 |
| Making Connections | 13 |
| Connecting to a Laptop or Desktop Computer | 14 |
| Connecting Equipment to the Component Video Input | 14 |
| Connecting to Video or S-Video Devices | 15 |
| Connecting to Display Devices | 15 |
| Adjusting the Height | 16 |
| Screen Size | 16 |
| Operation | 18 |
| Start Up | 18 |
| Shutdown | 19 |
| Digital Keystone Correction | 20 |
| Source Selection | 21 |
| Auto Adjustment | 21 |
| Blank | 22 |
| Zoom / Focusing | 22 |

| | |
|---|-----------|
| Laser Pointer Operation | 22 |
| Mouse Function Operation | 23 |
| Zoom In + / Zoom Out - | 23 |
| Volume Adjustment | 23 |
| PIP (Picture In Picture) Operation | 23 |
| Freeze | 24 |
| Preset Mode Selection | 24 |
| Menu Operation | 25 |
| Menu System | 25 |
| Using the menus | 26 |
| 1. Display Menu | 27 |
| 2. Image Menu | 29 |
| 3. Source Menu | 31 |
| 4. Control Menu | 33 |
| 5. PIP (Picture In Picture) Menu | 35 |
| Maintenance | 36 |
| Cleaning the lens | 36 |
| Cleaning the projector case | 36 |
| Cleaning and replacing the air filters | 36 |
| Storing the projector | 37 |
| Transporting the projector | 37 |
| Lamp Information | 38 |
| Use and Replacement of the Lamp | 38 |
| Lamp Replacement | 38 |
| Temp Warning Light | 40 |
| Indicators | 40 |
| Service Information | 43 |
| Accessories (included in the standard package) | 43 |
| Optional Accessories (not included in the standard package) | 43 |
| Ordering Parts or Getting Information | 43 |
| Troubleshooting..... | 44 |
| Common Problems & Solutions | 44 |
| Specifications..... | 45 |
| Projector Specifications | 45 |
| Technical Specifications | 45 |
| Timing Chart | 47 |

| | |
|---|-----------|
| Supported timing for PC (including DVI-I) input | 47 |
| Supported timing for YPbPr input | 47 |
| Supported timing for Video and S-Video inputs | 47 |
| Dimensions..... | 48 |
| Warranty..... | 49 |
| Limited Warranty | 49 |
| Regulation Statements | 50 |
| FCC Statement | 50 |
| EEC Statement | 50 |
| MIC Statement | 50 |



1 Important Safety Instructions

Your BenQ projector is designed and tested to meet the latest standards for safety of information technology equipment. However, to ensure safe use of this product, it is important that you follow the instructions mentioned in this manual and marked on the product.

Caution

- **To prevent shock, do not open the cabinet.** There are no user-serviceable parts inside.



- **Please read this user's manual before you operate your projector.** Save this user's manual for future reference.

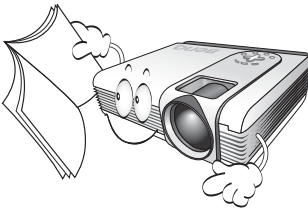

- **Do not look straight at the projector lens during operation.** The intense light beam may damage your eyes.

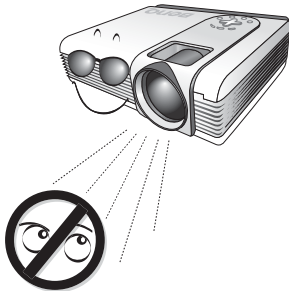

- **Refer servicing to qualified service personnel.**

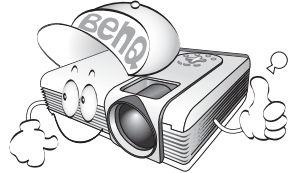

- **Always open the lens shutter or remove the lens cap when the projector lamp is on.**

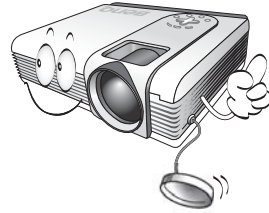

- In some countries, the line voltage is NOT stable. This projector is designed to operate safely within a mains voltage of 100 to 240 volts, but could fail if power cuts or surges of ± 10 volts occur. **In areas where the mains voltage may fluctuate or cut out, it is recommended that you connect your projector through a power stabilizer, surge protector or uninterruptible power supply (UPS).**

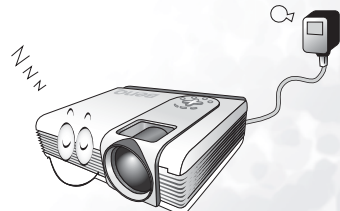

Safety Instructions

1. The lamp becomes extremely hot during operation. Allow the projector to cool for approximately 45 minutes prior to removing the lamp assembly for replacement.

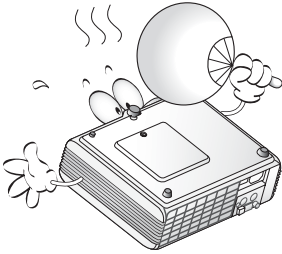

2. Do not operate lamps beyond the rated lamp life. Excessive operation of lamps beyond the rated life could cause them to explode on rare occasions.

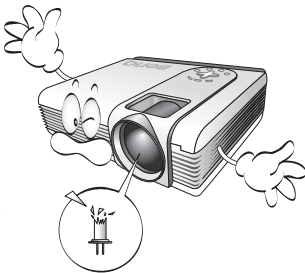

3. Never replace the lamp assembly or any electronic components unless the projector is unplugged.

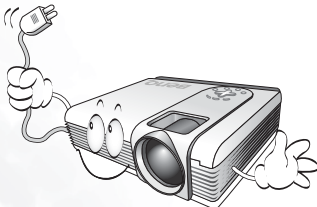

4. Do not place this product on an unstable cart, stand, or table. The product may fall, sustaining serious damage.



5. To reduce the risk of electric shock, do not disassemble this appliance. Take it to a qualified technician when service or repair is required. Incorrect reassembly can cause malfunction of the projector or electric shock when the appliance is subsequently used.

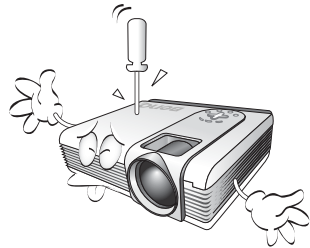

6. This product is capable of displaying inverted images for ceiling mount installation. Please use BenQ's Ceiling Mounting Kit for mounting the unit and ensure it is securely installed.

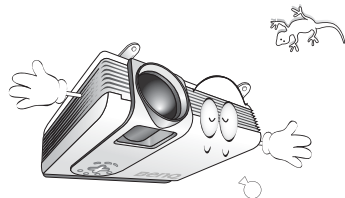

Safety Instructions (Continued)

7. Do not place this projector in any of the following environments.
- Space that is poorly ventilated or confined. Allow at least 50 cm clearance from walls and free flow of air around the projector.
 - Locations where temperatures may become excessively high, such as the inside of a car with all windows rolled up.
 - Locations where excessive humidity, dust, or cigarette smoke may contaminate optical components, shortening the projector's life span and darkening the image.



- Locations near fire alarms
- Locations with an ambient temperature above 35°C / 95°F
- Locations where the altitudes are higher than 10000 feet.

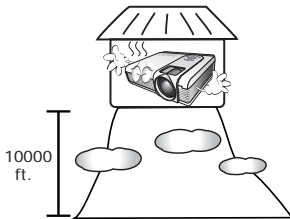

8. Do not block the ventilation holes.
- Do not place this unit on a blanket, bedding or any other soft surface.
 - Do not cover this unit with a cloth or any other item.
 - Do not place inflammables near the projector.



If the ventilation holes are seriously obstructed, overheating inside the unit may result in a fire.

9. Always place the unit on a level, horizontal surface during operation.
- Do not use if tilted at an angle of more than 10 degrees left to right, nor at angle of more than 15 degrees front to back. Using the unit when it is not fully horizontal may cause a malfunction of, or damage to, the lamp.

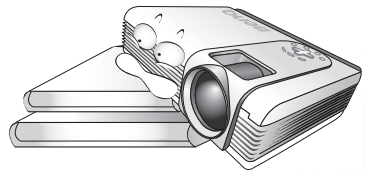

10. Do not stand the unit on end vertically.

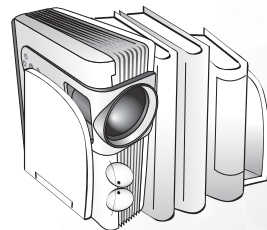

Doing so may cause the unit to fall over, causing injury or resulting in damage to the unit.

Safety Instructions (Continued)

11. Do not step on the projector or place any objects upon it.



Besides probable physical damage to the projector, doing so may result in accidents and possible injury.

12. Do not place liquids near or on the projector. Liquids spilled into the projector may cause it to fail. If the projector does become wet, disconnect it from the power supply's wall socket and call BenQ to have the projector serviced.



2 Introduction

Projector Features

The projector integrates high-performance optical engine projection and a user-friendly design to deliver high reliability and ease of use.

The projector offers the following features:

- Full-function remote control with laser pointer/ remote mouse function
- High quality manual zoom lens
- One-key auto-adjustment to display the best picture quality
- Digital keystone correction to correct distorted images
- Adjustable color balance control for data/video display
- Ultra-high brightness projection lamp
- Ability to display 16.7 million colors
- On-screen menus in 10 languages: English, French, German, Italian, Spanish, Russian, Traditional Chinese, Simplified Chinese, Japanese and Korean.
- Switchable Normal/ Economic mode to reduce the power consumption
- Powerful AV function to provide high quality AV picture
- HDTV compatibility (YPbPr)
- Two PC input terminals and one PC output terminal
- Replaceable air filter

 **Note: The brightness of the projected image will vary depending on the ambient lighting conditions and contrast/brightness settings.**

Shipping Contents

The projector is shipped with the cables required for connection to a PC and to video equipment. Carefully unpack and verify that you have all of the items shown below. If any of these items are missing, please contact your place of purchase.



Projector

Soft Carry Case

User's Manual



Batteries

3-2 Power Converter

User's Manual CD

Quick Start Guide

Warranty Booklet



Remote Control

S-Video Cable

Video Cable

VGA Cable

Audio Cables



US



EU



UK

USB Cable

D-Sub - DVI Cable

Power Cord 110V

Power Cord 220V

Power Cord 240V



Component Video Cable

Optional Accessories

1. Macintosh adapter
2. 250W / 300W lamp module
3. Ceiling mount kit
4. Wireless Pro
5. Presentation Pro
6. DVI-I cable

Projector Exterior View

Front / Upper View

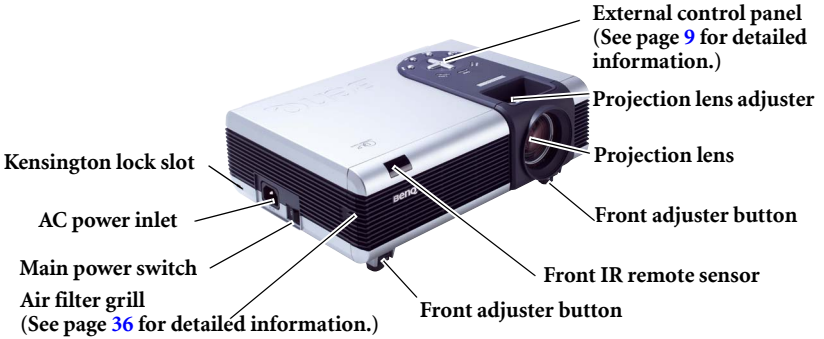

Back View



Bottom View

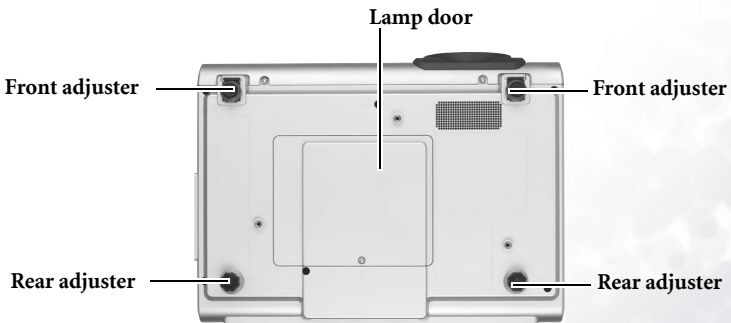

Connector Panel

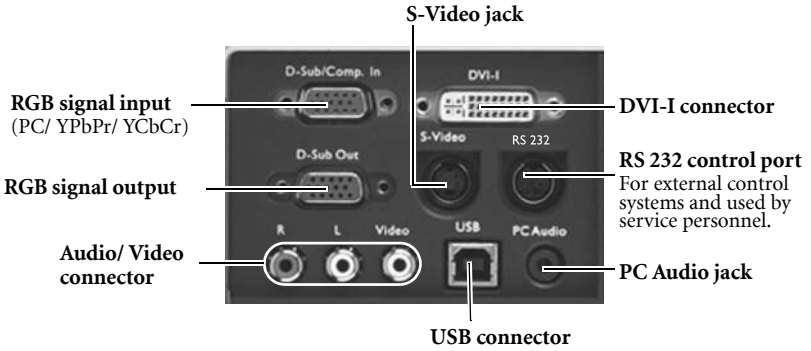

Controls and Functions

External Control Panel

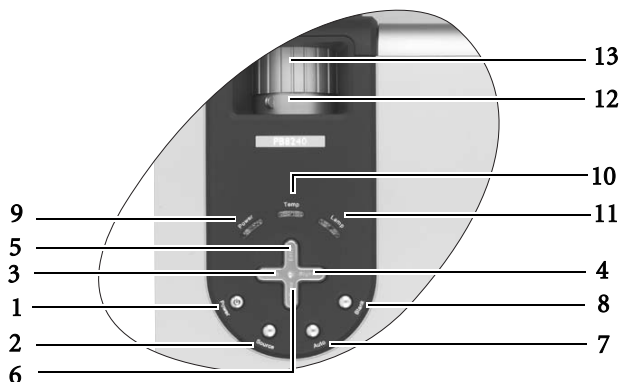

- 1. Power (Refer to page 18 for more information.)**
Turns the projector on or off.
- 2. Source (Refer to page 21 for more information.)**
Sequentially selects the input signal RGB, DVI, YPbPr, S-Video or Video.
- 3. ◀ Left**
- 4. ▶ Right**
When the on-screen menu is not activated, #3 and #4 function as **Keystone -/+** hot keys.
Refer to page 20 for more information.
- 5. ▲ Exit**
Exits and saves the menu settings.
- 6. ▼ Menu**
Turns the on-screen display control menu on.
When the on-screen menu is activated, the #3 to #6 buttons are used as directional arrows to select the desired menu items and to make adjustments.
Refer to page 26 for more information.
- 7. Auto (Refer to page 21 for more information.)**
Automatically determines the best picture timings for the displayed image.
- 8. Blank (Refer to page 22 for more information.)**
Used to hide the screen image. You can press **Blank** again or **Return** to bring the image back.
- 9. Power indicator light**
Lights up or flashes when the projector is under operation.
- 10. Temperature warning light (Refer to page 40 for more information.)**
Flashes red if the projector's temperature becomes too high.
- 11. Lamp indicator light (Refer to page 38 for more information.)**
Indicates the status of the lamp. Lights up or flashes when the lamp has developed a problem.
- 12. Zoom ring**
Adjusts the size of the image.
- 13. Focus ring**
Adjusts the focus of the projected image.

Remote Control Description

Front View

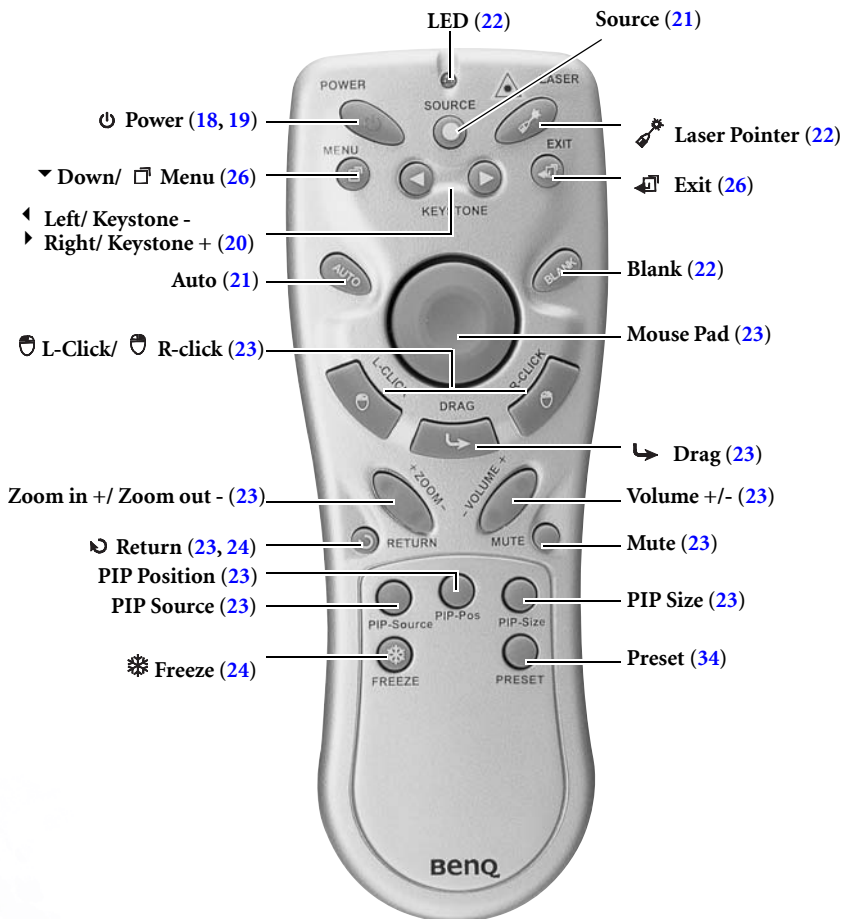

📖 Notes on Remote Control Operation

Make sure that there are no obstacles between the remote control and the IR sensors on the projector that might obstruct the infra-red beam.

Remote Control Effective Range

Infra Red (IR) remote control sensors are located on the front and the back of the projector. The remote control must be held at an angle within 30 degrees of the projector's IR remote control sensors to function correctly. The distance between the remote control and the sensors should not exceed 6 meters (19.5 feet).

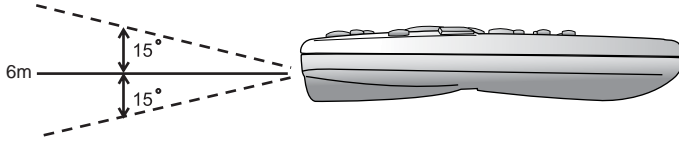

Warning Messages on the Back of the Remote Control

- ⚠ The laser beam is visible. It is necessary to depress the Laser button for continuous output.
- ⚠ The laser pointer is not a toy. Parents should be mindful of the dangers of laser energy and keep this remote control out of the reach of children.

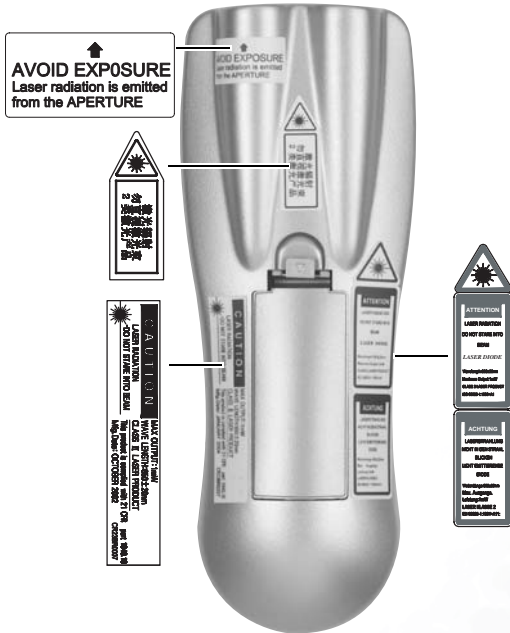

Installing or Replacing the Batteries

- 1** Push and open the battery compartment lid in the direction shown.

- 2** Install batteries as indicated by the diagram inside the compartment.

- 3** Position the lid over the compartment and snap it back into place.

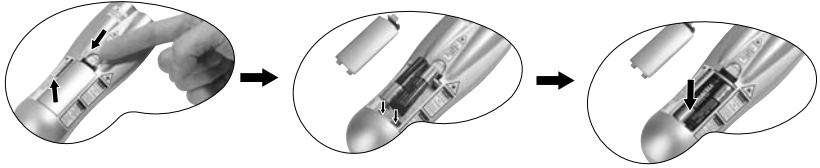

! Avoid excessive heat and humidity. There may be danger of an explosion if the batteries are incorrectly replaced. Replace only with the same or equivalent type recommended by the manufacturer. Dispose of the used batteries according to the manufacturer's instructions.

3 Setting Up Your Projector

Choosing a Location

Your projector is designed to be installed in the four installation configurations shown here: Floor front, Ceiling front, Floor rear, Ceiling rear. Your room layout or personal preference will dictate which installation configuration you use.

I. Floor front

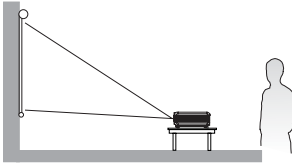

II. Ceiling front

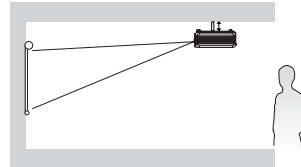

III. Floor rear

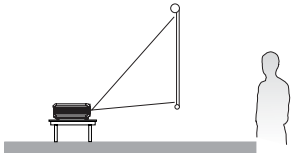

IV. Ceiling rear

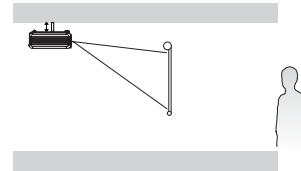

For further information on the four configurations, please refer to page [31](#).

If you place the projector above or below the screen, you have to tilt it down or up to center the image on the screen, in these situations image distortion will occur. Use the Keystone function to correct the distortion. See page [20](#) for keystone correction.

Making Connections

When connecting a signal source to the projector, be sure to:

1. Turn all equipment off before making any connections.
2. Use the correct signal cables for each source.
3. Ensure the cables are firmly inserted.

Connecting to a Laptop or Desktop Computer

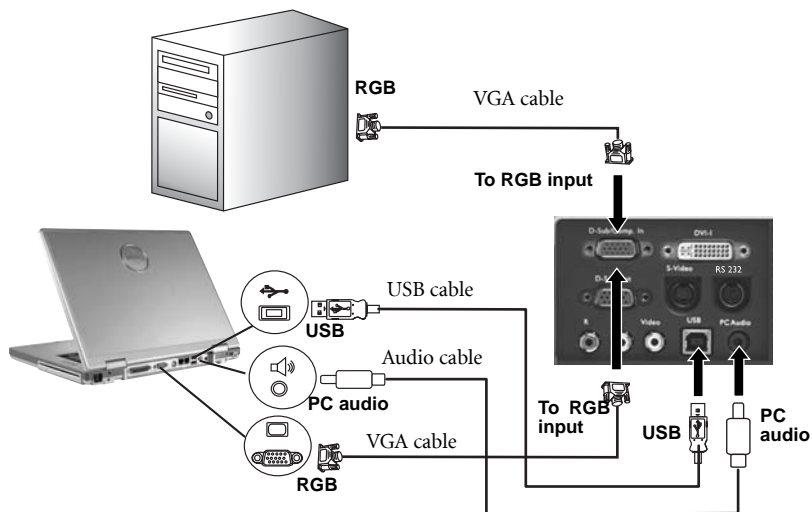

A Mac adapter (an optional accessory) may be necessary if you are connecting to an older Macintosh computers.

The USB cable is required if you intend using mouse functions on the remote control.

Connecting Equipment to the Component Video Input

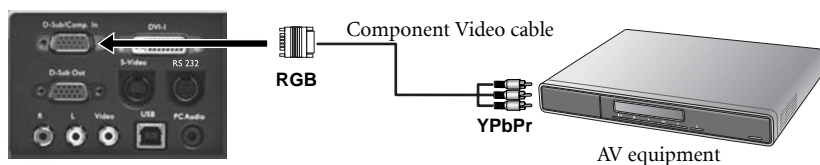

The projector is capable of displaying various High Definition TV display modes. Some of these sources are:

- Digital-VHS (D-VHS) player
- DVD player
- Satellite Dish HDTV receiver
- Digital TV tuners

Most of these sources will provide an analog component video output, a standard VGA output, or a YPbPr (default) format.

The projector is capable of accepting HDTV data through a Component Video connector. Use a Component Video cable that came with your projector to display these images.

The following standards are supported in the HDTV function:

- 480i
- 480p
- 576i
- 576p
- 720p (50/ 60 Hz)
- 1080i (50/ 60 Hz)

Connecting to Video or S-Video Devices

S-Video devices

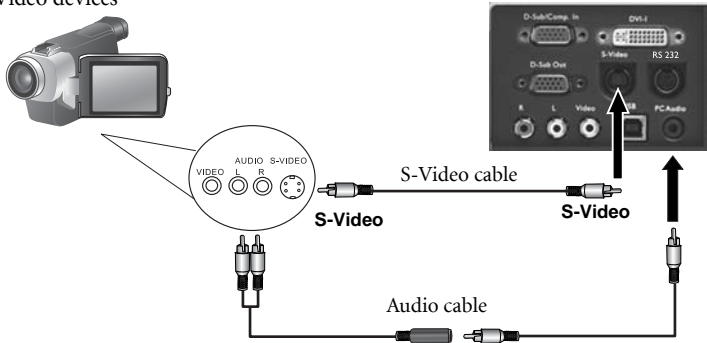

Video devices or VCR

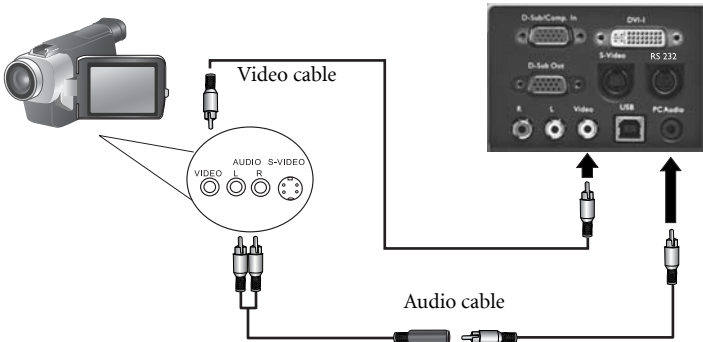

 If the selected video image is not displayed after the projector is turned on and the correct video source has been selected, check that the video source is turned on and operating correctly. Also check that the signal cables have been connected correctly.

Connecting to Display Devices

If you want to monitor your presentation close-up on a monitor as well as on the screen, you can connect the RGB signal output port on the projector to an external monitor with a VGA cable or D-Sub - DVI cable.

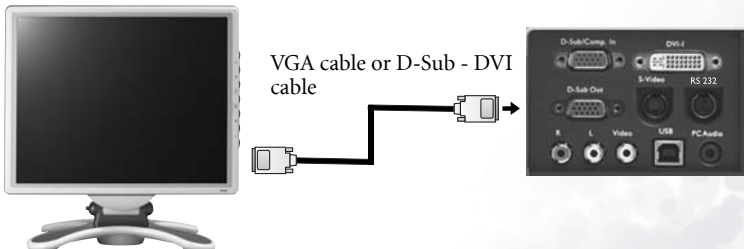

Adjusting the Height

The projector is equipped with 2 quick-release adjuster feet.

1. Lift the projector up and press the adjuster button to release the adjuster. The adjuster will drop into position and be locked.

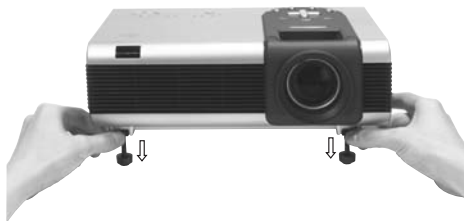

2. Screw the rear adjuster feet to fine-tune the projection angle.

☞ If the screen and the projector are not perpendicular to each other, the projected image becomes vertically trapezoidal. To correct this situation, adjust the value of Keystone in the Display menu, on the projector control panel or on the remote control.



Screen Size

Place the projector at the required distance from the screen according to the required picture size (see the table on the next page).

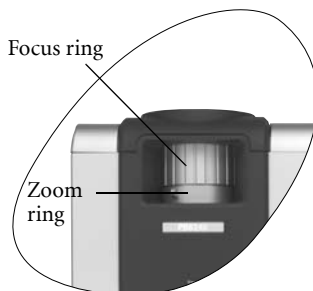
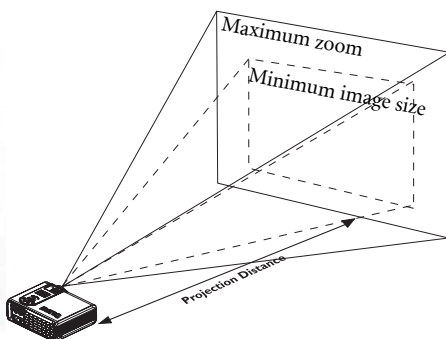

PB8250 (XGA) screen size chart (4:3 aspect ratio)

| Distance from screen | | Diagonal measurement | | | |
|----------------------|------|----------------------|-------|--------------|-------|
| | | Minimum zoom | | Maximum zoom | |
| feet | inch | feet | inch | feet | inch |
| 4 | 48 | 2.49 | 29.9 | 3.05 | 36.6 |
| 6 | 72 | 3.73 | 44.8 | 4.57 | 54.9 |
| 8 | 96 | 4.98 | 59.7 | 6.10 | 73.2 |
| 10 | 120 | 6.22 | 74.7 | 7.62 | 91.4 |
| 12 | 144 | 7.47 | 89.6 | 9.14 | 109.7 |
| 14 | 168 | 8.71 | 104.5 | 10.67 | 128.0 |
| 16 | 192 | 9.96 | 119.5 | 12.19 | 146.3 |
| 18 | 216 | 11.20 | 134.4 | 13.72 | 164.6 |
| 20 | 240 | 12.45 | 149.4 | 15.24 | 182.9 |
| 22 | 264 | 13.69 | 164.3 | 16.76 | 201.2 |
| 24 | 288 | 14.94 | 179.2 | 18.29 | 219.5 |
| 26 | 312 | 16.18 | 194.2 | 19.81 | 237.7 |
| 28 | 336 | 17.42 | 209.1 | 21.34 | 256.0 |
| 30 | 360 | 18.67 | 224.0 | 22.86 | 274.3 |
| 32 | 384 | 19.91 | 239.0 | 24.38 | 292.6 |

| Distance from screen | | Diagonal measurement | | | |
|----------------------|-----|----------------------|-------|--------------|-------|
| | | Minimum zoom | | Maximum zoom | |
| meter | cm | meter | cm | meter | cm |
| 1 | 100 | 0.62 | 62.2 | 0.76 | 76.2 |
| 1.5 | 150 | 0.93 | 93.3 | 1.14 | 114.3 |
| 2 | 200 | 1.24 | 124.5 | 1.52 | 152.4 |
| 2.5 | 250 | 1.56 | 155.6 | 1.91 | 190.5 |
| 3 | 300 | 1.87 | 186.7 | 2.29 | 228.6 |
| 3.5 | 350 | 2.18 | 217.8 | 2.67 | 266.7 |
| 4 | 400 | 2.49 | 248.9 | 3.05 | 304.8 |
| 4.5 | 450 | 2.80 | 280.0 | 3.43 | 342.9 |
| 5 | 500 | 3.11 | 311.2 | 3.81 | 381.0 |
| 5.5 | 550 | 3.42 | 342.3 | 4.19 | 419.1 |
| 6 | 600 | 3.73 | 373.4 | 4.57 | 457.2 |
| 6.5 | 650 | 4.04 | 404.5 | 4.95 | 495.3 |
| 7 | 700 | 4.36 | 435.6 | 5.33 | 533.4 |
| 7.5 | 750 | 4.67 | 466.7 | 5.72 | 571.5 |
| 8 | 800 | 4.98 | 497.8 | 6.10 | 609.6 |

PB8250 (XGA) screen size chart (16:9 aspect ratio)

| Distance from screen | | Diagonal measurement | | | |
|----------------------|------|----------------------|-------|--------------|-------|
| | | Minimum zoom | | Maximum zoom | |
| feet | inch | feet | inch | feet | inch |
| 4 | 48 | 2.29 | 27.5 | 2.80 | 33.6 |
| 6 | 72 | 3.44 | 41.3 | 4.20 | 50.4 |
| 8 | 96 | 4.59 | 55.1 | 5.60 | 67.2 |
| 10 | 120 | 5.74 | 68.8 | 7.00 | 84.0 |
| 12 | 144 | 6.88 | 82.6 | 8.40 | 100.8 |
| 14 | 168 | 8.03 | 96.4 | 9.80 | 117.6 |
| 16 | 192 | 9.18 | 110.1 | 11.20 | 134.4 |
| 18 | 216 | 10.32 | 123.9 | 12.60 | 151.2 |
| 20 | 240 | 11.47 | 137.7 | 14.00 | 167.9 |
| 22 | 264 | 12.62 | 151.4 | 15.39 | 184.7 |
| 24 | 288 | 13.77 | 165.2 | 16.79 | 201.5 |
| 26 | 312 | 14.91 | 179.0 | 18.19 | 218.3 |
| 28 | 336 | 16.06 | 192.7 | 19.59 | 235.1 |
| 30 | 360 | 17.21 | 206.5 | 20.99 | 251.9 |
| 32 | 384 | 18.35 | 220.3 | 22.39 | 268.7 |

| Distance from screen | | Diagonal measurement | | | |
|----------------------|-----|----------------------|-------|--------------|-------|
| | | Minimum zoom | | Maximum zoom | |
| meter | cm | meter | cm | meter | cm |
| 1 | 100 | 0.57 | 57.4 | 0.70 | 70.0 |
| 1.5 | 150 | 0.86 | 86.0 | 1.05 | 105.0 |
| 2 | 200 | 1.15 | 114.7 | 1.40 | 140.0 |
| 2.5 | 250 | 1.43 | 143.4 | 1.75 | 179.4 |
| 3 | 300 | 1.72 | 172.1 | 2.10 | 209.9 |
| 3.5 | 350 | 2.01 | 200.8 | 2.45 | 244.9 |
| 4 | 400 | 2.29 | 229.4 | 2.80 | 279.9 |
| 4.5 | 450 | 2.58 | 258.1 | 3.15 | 314.9 |
| 5 | 500 | 2.87 | 286.8 | 3.50 | 349.9 |
| 5.5 | 550 | 3.15 | 315.5 | 3.85 | 384.9 |
| 6 | 600 | 3.44 | 344.1 | 4.20 | 419.9 |
| 6.5 | 650 | 3.73 | 372.8 | 4.55 | 454.9 |
| 7 | 700 | 4.02 | 401.5 | 4.90 | 489.8 |
| 7.5 | 750 | 4.30 | 430.2 | 5.25 | 524.8 |
| 8 | 800 | 4.59 | 458.9 | 5.60 | 559.8 |

 There is 3% ~ 5% tolerance among these numbers due to optical component variations.

* 1m = 3.28 feet, 1 foot = 0.305m, 1m = 100cm, 1 foot = 12 inches

4 Operation

Start Up

1. Switch all of the connected equipment on.
2. Plug the power cord into the projector and into a wall socket.

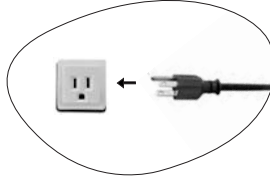

3. Turn on the wall socket switch (where fitted).
4. Turn the main power switch on. The **Power indicator** lights orange.



5. Press and hold **Power** on the remote control or projector to start the unit. The **Power indicator light** flashes green when the power is turned on.



6. The start up procedure takes about 30 seconds after pressing **Power**. In the later stage of start up, a default BenQ logo appears.
7. Next, the projector starts to search input signals. Irrespective of selected input source, the screen shows "**Acquiring Signal**" at the bottom right corner of the screen. If there is no input source detected, one of six messages will be displayed on the screen

continuously: “Analog RGB Searching”, “DVI-A Searching”, “DVI-D Searching”, “Analog YPbPr Searching”, “S-Video Searching”, “Composite Video Searching”.

8. You can also press **Source** on the projector or remote control to select your desired input signal. For more information, refer to page 21.

 If the frequency/ resolution of the input signal exceeds the projector’s operating range, you will see the message “Out of Range” displayed on a blank screen.

Shutdown

1. Press **Power** and a warning message appears. To turn the projector off, press **Power** again.
2. The **Power indicator light** flashes orange and the lamp shuts down, the fans continue to run for approximately 90 seconds to cool down the projector.

 To protect the lamp, the projector will not respond to any commands during the cooling process.

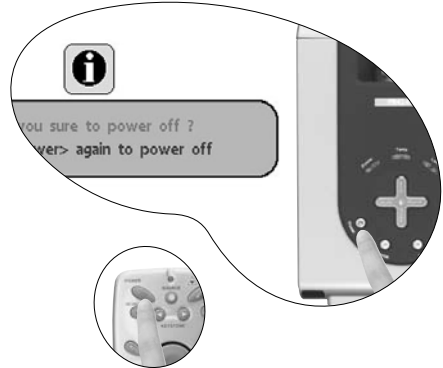

3. Turn the main power switch off.



4. Disconnect the power cord from the wall socket.

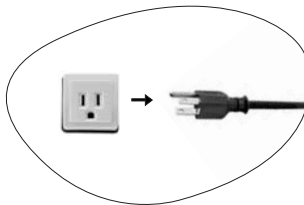

 Do not unplug the power cord before the projector shutdown sequence is complete or during the 90-second cooling down process. If the projector is not properly shut down, to protect the lamp, when you attempt to re-start the projector within hours, the fans will run for a few minutes to cool down. Press Power again to start the projector after the fans stop.

Digital Keystone Correction

Keystoning refers to the situation where the projected image is noticeably wider at either the top or bottom. It occurs when the projector is not perpendicular to the screen.

To correct this, besides adjusting the height of the projector, you will need to manually correct it following ONE of these steps.

1. Press ◀ **Left/ Right** ▶ (hot key) on the control panel of the projector to display the status bar labelled Keystone. Press **Right** ▶ to correct keystoning at the top of the image. Press ◀ **Left** ▶ to correct keystoning at the bottom of the image.

2. Press ◀ **Keystone/ Keystone** ▶ on the remote control to display the status bar labelled Keystone. Press **Keystone** ▶ to correct keystoning at the top of the image. Press ◀ **Keystone** to correct keystoning at the bottom of the image.

3. Press **Menu** key on the projector or the remote control. Go to  **Display** --> **Keystone** and adjust the values by pressing ◀ **Left/ Right** ▶ on the projector or ◀ **Keystone/ Keystone** ▶ on the remote control.

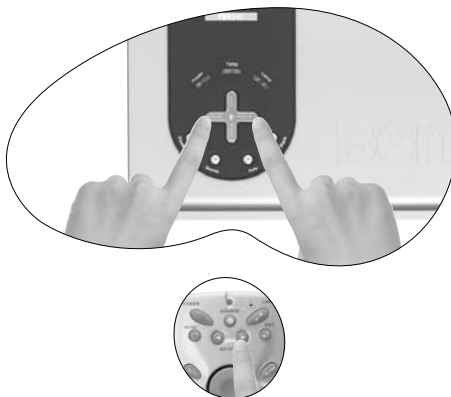

For example,



Keystone  0

1. Press **Right** ▶ on the projector or
2. Press **Keystone** ▶ on the remote control or
3. Press ▶ **Right** on the projector or **Keystone** ▶ on the remote control when you are in **Display** --> **Keystone** menu.



Keystone  -16



Keystone  0

1. Press ◀ **Left** on the projector or
2. Press ◀ **Keystone** on the remote control or
3. Press ◀ **Left** on the projector or ◀ **Keystone** on the remote control when you are in **Picture** --> **Keystone** menu.



Keystone  +16

Source Selection

To sequentially select input sources, press **Source** on the projector control panel or the remote control. It may take you a few seconds when the projector is searching for input signals. The selected source will be displayed at the bottom right of the screen for 3 seconds.

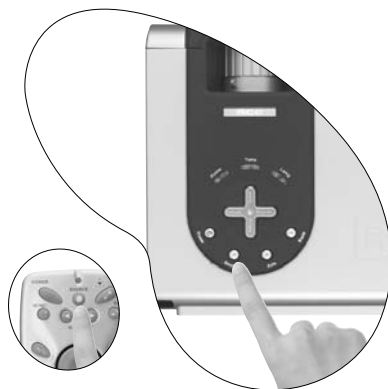

Auto Adjustment

In some cases, you may need to optimize the picture quality. To do this, press **Auto** on the control panel of the projector or on the remote control. Within 3 seconds, the built-in Intelligent Auto Adjustment function will re-adjust the values of Frequency and Clock to provide the best picture quality.

The current source information will be displayed at the bottom right of the screen for 3 seconds, as below.

| |
|-------------------|
| Analog RGB |
| 1280 x 854 / 60Hz |
| Presentation Mode |

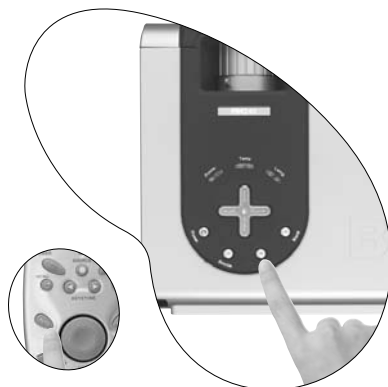

 **The screen will be blank while Auto is functioning.**

Blank

In order to draw the audience's full attention to the presenter, you can use **Blank** to hide the screen image. Press **Blank** to hide the screen image. Press **Blank** again to restore the image. A word "**BLANK**" appear at the bottom right corner of the screen when the image is hidden.



Zoom / Focusing

Adjust the projected image to your desired size using the lens' zoom ring. Then focus the image by rotating the focus ring. Refer to the screen size table on page 16.

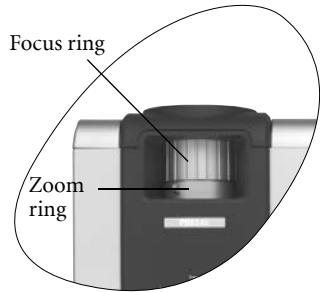

Laser Pointer Operation

The Laser Pointer is a presentation aid for professionals. It emits red colored light when you press it and the LED indicator lights up green. Do not look into the laser light window or shine the laser light beam on yourself or others. Refer to the warning messages on the back of the remote control and the attached "User Information" prior to using it.



Mouse Function Operation

Connect the projector to your PC or notebook with a USB cable prior to using these functions.

The **Mouse Pad** can take over the PC or notebook mouse function. When the displayed image is magnified, use the **Mouse Pad** to move around the display areas.

The L-Click and R-Click act as the Left (L) and Right (R) buttons of a computer mouse.

The Drag toggles between ON and OFF for the drag function of the remote mouse.



Zoom In + / Zoom Out -

By pressing **Zoom +**, the center of the picture will be magnified. When the **+** button is pressed again, the picture is further magnified. Use the Mouse Pad to navigate the image. By pressing **Zoom -**, the size of the image is reduced. When the **-** button is pressed again, the picture is further reduced until it is restored to the original size. You can also restore the actual image size by pressing **Return**.



Volume Adjustment

Adjust the loudness by pressing **Volume + / -**. Or press **Mute** to mute the sound.



PIP (Picture In Picture) Operation

By pressing the PIP-Source, PIP-Pos and PIP-Size hot keys, you can enable the PIP (Picture In Picture) function and choose the position and size of the PIP image.

Refer to page [35](#) for more information.



Freeze

The image is frozen when **Freeze** is pressed. An icon  will appear in the lower right corner of the screen. To release the function, press **Freeze** again, **Return** or **Source** (this will change the input source and release the pause function).



Preset Mode Selection

Press **Preset** to select a operation mode that suits your need. There are several operation modes available for different types of signals.

| PC / DVI Signal Input | | | |
|--------------------------------------|-------|--------|----------|
| Presentation | Vivid | Video | Economic |
| YPbPr / S-Video / Video Signal Input | | | |
| Gaming | Video | Cinema | Economic |

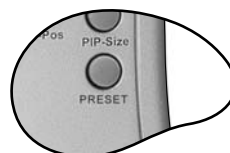





Refer to page [34](#) for more information.

Menu Operation

Menu System

Please note that the OSD menus vary according to the signal type selected.

| Functions available when receiving different signal types... | | | | |
|---|--|--|--|---|
| Sub-Menu | Analog RGB / DVI-A | DVI-D | YPbPr (480p/ 576p/ 720p/ 1080i) | YCbCr (480i/ 576i) / S-Video / Video |
|  Display | Keystone Brightness Contrast Phase H Size | Keystone Brightness Contrast | Keystone Brightness Contrast Phase H Size | Keystone Brightness Contrast Color Tint |
|  Image | Auto Resize H Position V Position Color Temp Information | Auto Resize Color Temp Information | Ratio H Position V Position Color Tint Color Temp | Ratio System Sharpness Color Temp Information |
|  Source | Mirror Source Volume Treble Bass Mute | | | |
|  Control | Language OSD -- OSD Pos., OSD Time Setup -- Source Scan, Keystone Hold, Mirror Hold, Blank Time, Auto Off, User Logo Economic Mode Preset Mode -- (PC/ DVI signal input only) Presentation Mode, Vivid Mode, Video Mode, Economic Mode (YPbPr/ YCbCr/ S-Video/ Video signal input) Gaming Mode, Video Mode, Cinema Mode, Economic Mode Reset Lamp Hour | | | |
|  PIP | Main Page: PIP Source PIP Size PIP Pos. H Position V Position More Options | | Sub Page: Brightness Contrast Color Tint Sharpness System | |

Using the menus

The projector is equipped with on-screen display (OSD) menus for making various adjustments and settings.

There are 10 different menu languages. (Refer to page 33 for more details.)

The following example describes the adjustment of the keystone.

1. Press **Menu** on the projector or remote control to turn the on-screen menu on.

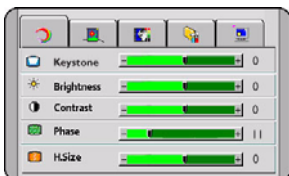

4. Adjust keystone values by pressing ◀ **Left/ Right** ▶ on the projector or ◀ **Keystone/ Keystone** ▶ on the remote control.

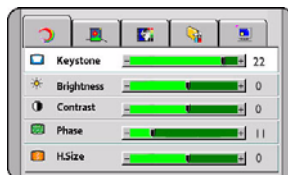

2. Use ◀ **Left/ Right** ▶ on the projector or ◀ **Keystone/ Keystone** ▶ on the remote control to select **Display** menu.
3. Use ▲ **Exit** or ▼ **Menu** on the projector or ▼ **Down/** ◻ **Menu** on the remote control to select **Keystone**.

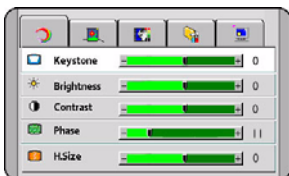

5. Press ▲ **Exit** on the projector or press ◻ **Exit** twice* on the remote control to leave and save the settings.

*The first press leads you back to the submenu and the second press closes the on-screen menu.

1. Display Menu

Analog RGB/ DVI-A/ YPbPr (480p, 576p, 720p, 1080i) signal input

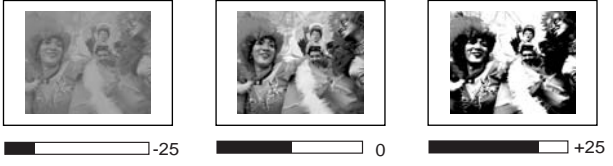
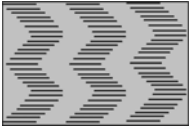
| FUNCTION | DESCRIPTION |
|-------------------|--|
| Keystone | Corrects any keystoneing of the image. Refer to page 20 for more information. |
| Brightness | <p>Adjusts the brightness of the image. The higher the value, the brighter the image. And lower the setting, darker the image. Adjust this control so the black areas of the image appear just as black and that detail in the dark areas is visible.</p>  |
| Contrast | <p>Adjusts the degree of difference between dark and light in the image. The higher the value, the greater the contrast.</p>  |
| Phase | <p>This function allows you to adjust the clock phase to reduce image distortion.</p>  |
| H Size | Adjusts the horizontal width of the image. |

DVI-D signal input



| FUNCTION | DESCRIPTION |
|-------------------|-------------|
| Keystone | As above. |
| Brightness | As above. |
| Contrast | As above. |

YCbCr (480i, 576i)/ S-Video/ Video signal input

| FUNCTION | DESCRIPTION |
|-------------------|--|
| Keystone | As above. |
| Brightness | As above. |
| Contrast | As above. |
| Color | Increases or decreases the color intensity of the image. |
| Tint | Adjusts the color tones of the image. The higher the value, the more red-dish the image becomes. The lower the value, the more greenish the image becomes. |

2. Image Menu

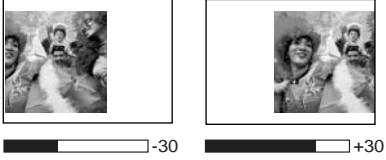
Analog RGB/ DVI-A signal input

| FUNCTION | DESCRIPTION |
|--------------------|---|
| Auto Resize | Makes the best fit of the image to the screen, 1. On 2. Off 3. 16:9 |
| H Position | Adjusts the horizontal position of the projected image.  |
| V Position | Adjusts the vertical position of the projected image.  |
| Color Temp | Adjusts the white color. The higher the value, the more reddish white the image becomes. The lower the value, the more bluish white the image becomes.* |
| Information | Shows the current image resolution. |

*About color temperatures:

There are many different shades that are considered to be “white” for various purposes. One of the common methods of representing white color is known as the “color temperature”. A white color with a low color temperature appears to be reddish white. A white color with a high color temperature appears to have more blue in it.

DVI-D signal input

| FUNCTION | DESCRIPTION |
|--------------------|-------------|
| Auto Resize | As above. |
| Color Temp | As above. |
| Information | As above. |



YPbPr (480p, 576p, 720p, 1080i) signal input



| FUNCTION | DESCRIPTION |
|-------------------|--|
| Ratio | Users have 2 options for the image ratio. 1. 4 : 3 2. 16 : 9 |
| H Position | As above. |
| V Position | As above. |
| Color | Increases or decreases the color intensity of the image. |
| Tint | Adjusts the color tones of the image. The higher the value, the more red-dish the image becomes. The lower the value, the more greenish the image becomes. |
| Color Temp | As above. |

YCbCr (480i, 576i)/ S-Video/ Video signal input

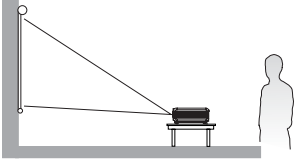
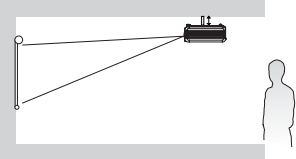
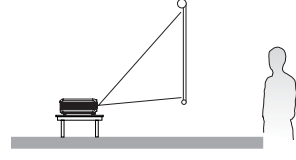
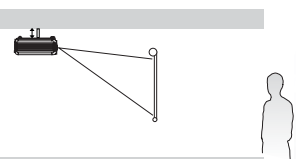
| FUNCTION | DESCRIPTION |
|--------------------|--|
| Ratio | As above. |
| System | Shows the Video input system format, 1.NTSC 2. PAL 3.SECAM 4. YUV. |
| Sharpness | Adjusts the image to make it look sharper or softer. |
| Color Temp | As above. |
| Information | As above. |

3. Source Menu

| FUNCTION | DESCRIPTION |
|----------------------|---|
| <p>Mirror</p> | <p>The projector can be installed on a ceiling or behind a screen, or with one or more mirrors. Contact your dealer for the ceiling mount bracket (optional accessory) if you need to install the projector on your ceiling.</p> <ul style="list-style-type: none"> <p>Floor front: Select this setting with the projector set on the floor and audience viewing the projected images from the front side of the screen. This is the most common setting.</p>  <p>Ceiling front: Select this setting with the projector suspended from the ceiling and audience viewing the projected images from the front side.</p>  <p>Floor rear: Select this setting when the projector is placed near the floor and behind the screen. A special rear projection screen is required.</p>  <p>Ceiling rear: Select this setting when the projector is suspended from the ceiling and placed behind the screen. A special rear projection screen is required.</p>  |
| <p>Source</p> | <p>Shows the current signal source.</p> |
| <p>Volume</p> | <p>Adjusts the volume level.</p>  |
| <p>Treble</p> | <p>Adjusts the treble level. (-5 ~ 5)</p>  |

| | |
|-------------|---|
| Bass | Adjusts the bass level. (-5 ~ 5)  |
| Mute | Off On   |

4. Control Menu

| FUNCTION | DESCRIPTION |
|-----------------|--|
| Language | <p>Language sets the language for the OSD control menus.</p> <p>Use the ◀ / ▶ key to select the desired language from among English, French, German, Italian, Spanish, Russian, Traditional Chinese, Simplified Chinese, Japanese and Korean.</p> |
| OSD | <p>OSD Pos. Selects a desired OSD position.</p> <hr/> <p>OSD Time Sets the length of time the OSD will remain active after your last button press. The range is from 5 to 60 seconds.</p> |
| Setup | <p>Source Scan Sets whether the projector searches automatically for input signals. If the source scan is on, the projector will search for input signals in the following order: Analog RGB --> DVI-A --> DVI-D --> Analog YPbPr --> S-Video --> Composite Video until it acquires a signal. If the function is not activated, the projector selects the last input signal.</p> <hr/> <p>Keystone Hold When selected, preserves the last keystone correction value even when the projector is restarted.</p> <hr/> <p>Mirror Hold When selected, preserves the last mirror correction value even when the projector is restarted.</p> <hr/> <p>Blank Time Determines the length of time before the projector will automatically shutdown when Blank is activated.</p> <hr/> <p>Auto Off Sets the length of time before the projector will automatically shutdown when there is no input signal detected.</p> <hr/> <p>User Logo Enables the user to select which logo screen will appear during projector start-up. Three modes are available: Default (BenQ logo), black screen or blue screen.</p> |

| | |
|--------------------|---|
| Preset Mode | <p>Preset modes are provided so you can optimize your projector image set-up to suit your program type.</p> <p>PC/ DVI Signal input</p> <ol style="list-style-type: none"> 1. Presentation Mode: Is designed for presentations. The brightness is emphasized in this mode. 2. Vivid Mode: Is perfect for playing games. The color saturation and brightness are well-balanced. 3. Video Mode: Is suitable for cinematic enjoyment displaying images in their natural color. 4. Economic Mode: Use this mode to reduce the system noise and reduce the power consumption by 20%. The lamp life is also extended with lower light output. <p>YPbPr/ YCbCr/ S-Video/ Video Signal Input</p> <ol style="list-style-type: none"> 1. Gaming Mode: Is suitable for playing video games in a bright living room. 2. Video Mode: With a higher color temperature, it is suitable for enjoying TV movies. 3. Cinema Mode: With a lower color temperature, it is suitable for enjoying cinematic movies. 4. Economic Mode: Use this mode to reduce the system noise and reduce the power consumption by 20%. The lamp life is also extended with lower light output. |
| Reset | Returns all settings to the factory preset values. |
| Lamp Hour | Displays the number of hours the lamp has been used. |

5. PIP (Picture In Picture) Menu

Your projector is capable of displaying images simultaneously from two input sources, which enhances your presentation in a more effective way.

These functions are available only when the input source is PC and the PIP source is Video or S-Video.

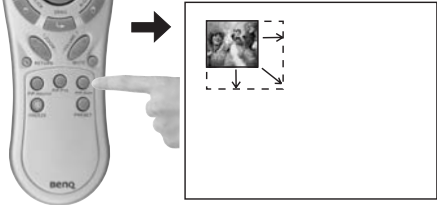
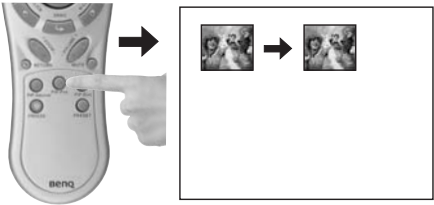
| FUNCTION | DESCRIPTION |
|---------------------|--|
| PIP Source | Selects the source for the PIP. |
| PIP Size | <p>Press the ◀ / ▶ keys to scroll through the four alternatives: Off, Small, Medium, Large.</p>  <p>ⓘ When the resolution of the PC signal is 1280 x 1024 (SXGA), the selected Large PIP size will be reduced to the Medium size.</p> |
| PIP Position | <p>Selects a desired position for the PIP.</p>  |
| H Position | Adjusts the horizontal position of the PIP image. |
| V Position | Adjusts the vertical position of the PIP image. |
| More Options | Press the ◀ / ▶ keys to select more PIP functions including Brightness, Contrast, Color, Tint, Sharpness and System. |
| Brightness | Adjusts the brightness of the PIP image. |
| Contrast | Adjusts the degree of difference between dark and light in the PIP image. The higher the value, the greater the contrast. |
| Color | Increases or decreases the color intensity of the PIP image. |
| Tint | Adjusts the color tones of the PIP image. The higher the value, the more reddish the image becomes. The lower the value, the more greenish the image becomes. |
| Sharpness | Adjusts the image to make it appear sharper or softer |
| System | Shows Video input system format, NTSC, PAL, SECAM or YUV. |

5 Maintenance

Your projector needs little maintenance. Things you have to do on a regular basis are keep the lens clean and clean the air filter to prevent overheating.

Never remove any parts of the projector except the lamp and air filter. Contact your dealer if other parts need replacing.

Cleaning the lens

Clean the lens whenever you notice dirt or dust on the surface.

- Use a canister of compressed air to remove dust.
- If there is dirt or smears, use lens-cleaning paper or moisten a soft cloth with lens cleaner to gently wipe the lens surface.

☞ **Never rub the lens with abrasive materials.**

Cleaning the projector case

Before you clean the case, turn the projector off and unplug the power cord.

- To remove dirt or dust, wipe the case with a soft, dry, lint-free cloth.
- To remove stubborn dirt or stains, moisten a soft cloth with water and a neutral detergent. Then wipe the case.

☞ **Never use wax, alcohol, benzene, thinner or other chemical detergents. These can damage the case.**

Cleaning and replacing the air filters

It is necessary to clean the air filters periodically. If the filters are not cleaned, they can become clogged with dust and prevent proper ventilation. This can cause overheating and a malfunction of the projector.

A warning message like the one pictured to the right will be displayed for 10 seconds every 300 hours to remind you to clean the filters.

1. Turn the projector off and wait until the fans stop running.
2. Disconnect the projector from any cables.
3. Open one air filter cover from the left and draw another one from the front sides of the projector.



Please check if the filter is clean. Please clean the filter by using a small vacuum or brush if filter is dirty. Press "Exit" to confirm

From the front side:

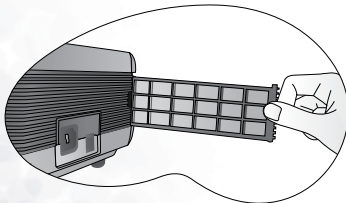

From the left side:

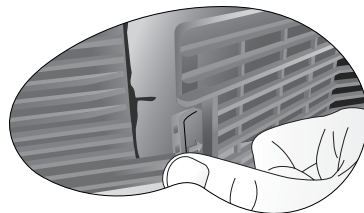

4. Use a small vacuum cleaner designed for computers and other office equipment to clean the filters. Or use a soft brush (such as a clean artist's paintbrush) to gently sweep the dust away.

If the dirt is difficult to remove or the filters are broken, contact your place of purchase to replace them.

5. Replace the filters then press the covers back until they click into place.

If the covers are not correctly seated in place, you will be reminded by a message displayed on the screen every three minutes. The projector will automatically shut down after 10th minutes if there has been no further action taken. Re-install the filters securely, then turn on the power again.

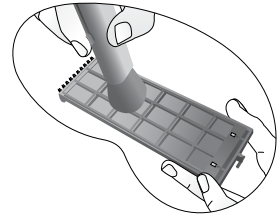

Please check
Filter not well attached

Storing the projector

If you need to store the projector for an extended time, please follow the instructions below.

- Make sure the temperature and humidity of the storage area are within the recommended range for the projector. Please refer to the Spec. page in the manual or consult your dealer about the range.
- Retract the adjuster feet.
- Remove the batteries from the remote control.
- Pack the projector in its original packing or equivalent.

Transporting the projector

It is recommended that you ship the projector with its original packing or equivalent. When you carry the projector yourself, please use the provided soft carry case.

Lamp Information



Use and Replacement of the Lamp

When the **Lamp Indicator** lights up red or a message appears suggesting it is time to replace the lamp, please install a new lamp or consult your dealer. An old lamp may cause a malfunction in the projector and in some instances the lamp may explode.

For more detailed information on the warning indicators, please refer to page 40.

 **The Lamp indicator light and Temperature warning light will light up if the lamp becomes too hot. Turn the power off, allow the projector to cool down before checking that the Air Filters are not clogged (page 36). If the Lamp or Temp indicator still lights up after turning the power back on, please contact your dealer.**

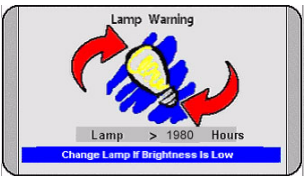
The following Lamp warning displays will remind you of the lamp condition.

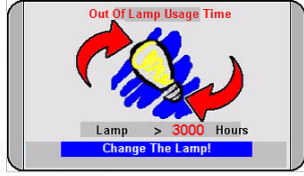
| Message | Status |
|---|---|
|  | <p>The lamp has been in operation for 1980 hours. Install a new lamp for optimal performance. If the projector is normally run with Preset "Economic Mode" selected (page 34), you may continue to operate the projector until the 2980 hour lamp warning appears.</p> |
|  | <p>The lamp has been in operation for 2980 hours, the power will shutdown in 20 hours time. A new lamp should be fitted to avoid the inconvenience when the projector runs out of lamp time.</p> |
|  | <p>The lamp has been in operation for over 3000 hours. This message will flash in the center of the screen together with the Lamp indicator lighting up red for 40 seconds. The projector will shutdown after 40 seconds. The lamp MUST be replaced before the projector will operate normally.</p> |

Lamp Replacement

 **To reduce the risk of electrical shock, always turn the projector off and disconnect the power cord before changing the lamp.**

To reduce the risk of severe burns, allow the projector to cool for at least 45 minutes before replacing the lamp.

To reduce the risk of injuries to fingers and damage to internal components, use caution when removing lamp glass that has shattered into sharp pieces.

To reduce the risk of injuries to fingers and/or compromising image quality by touching the lens, do not touch the empty lamp compartment when the lamp is removed.

This lamp contains mercury. Consult your local hazardous waste regulations and dispose of this lamp in the proper manner.

Step 1. Turn the power off and disconnect the projector from the wall socket.

Step 2. Turn the projector over. Then loosen the screws and remove the lamp cover. If the lamp is hot, avoid burns by waiting for 45 minutes until the lamp has cooled.

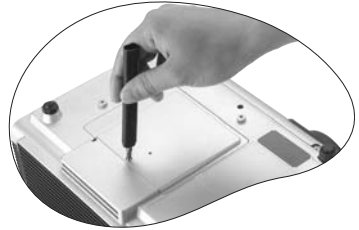

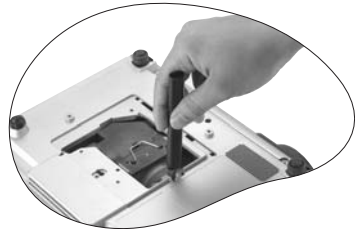

Step 3. Loosen the screw that fixes the lamp to the projector. If the screw is not loosened completely, you could injure your fingers. It is strongly recommended that you use a magnetic-head screwdriver.



Step 4. Lift the handle so that it stands up. Use the handle to slowly pull the lamp out of the projector.

 Pulling too quickly may cause the lamp to break and scatter broken glass in the projector.

 Do not place the lamp in locations where water might splash on it, children can reach it, or near flammable materials.

 Do not insert your hands into the projector after the lamp is removed. If you touch the optical components inside, it could cause color unevenness and distortion of the projected images.

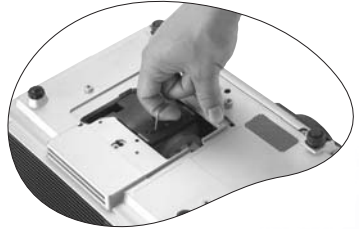

Step 5. Insert the new lamp. Make sure the handle is fully locked and tighten the screw firmly.

 A Loose screw may cause a bad connection, which could result in malfunction.

 Do not over tighten the screw.

Step 6. Re-install the lamp cover and tighten the screw. **Do not turn the power on with the lamp cover removed.** Whenever the lamp is replaced, reset the total lamp operation timer. **Do not reset if the lamp is not replaced as this could cause damage.**

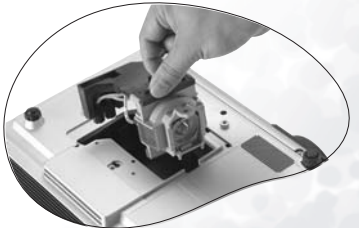

Step 7. Reset the lamp counter

i. Press and hold **Exit** on the projector for 3 seconds to display the total used lamp time.



ii. Press **Menu** on the projector or on the remote control to access the lamp hour timer. An adjustment message will appear.



iii. Press ◀ or ▶ to reset lamp hours and press **EXIT** to leave.

Temp Warning Light

When the Temperature warning light is on, it is warning you of the following possible problems:



1. The internal temperature is too high.
2. Air Filters are clogged.
3. The fans are not working.

















Turn the projector off, check that the air filters are clean. If the problem persists, contact qualified service personnel for further help.

















For more detailed information, please refer to the following section.

Indicators

Illustration - table legend.

1. Blank - : Light OFF
2.  : Light flashing
3.  : Light ON
4. **O** : Orange light
5. **R** : Red light
6. **G** : Green light

| LED | | | Status & Description |
|---|---|---|--|
| Power | Temp | Lamp | |
| Power events | | | |
|  |  |  | The projector has just been connected to a power outlet. |
|  | - | - | Stand-by mode. |
|  | - | - | (1) The projector needs 90 seconds to cool down as it was abnormally shut down without the normal cooling down process. Or (2) The projector needs to cool for 90 seconds after the power is turned off. |
|  | - | - | The Power indicator light is flashing during powering up. |
|  | - | - | The projector is under normal operation. |
| Lamp events | | | |
| - | - | - | The lamp counter has developed a problem. |
| - | - |  | It is warning you that lamp usage has exceeded 3000 hours. Replace the projection lamp with a new one immediately. |
| - | - |  | The lamp is not properly attached or the lamp is damaged. Please contact your dealer for assistance. |
| Thermal events | | | |
| - |  | - | The projector has shutdown automatically. If you try to restart the projector, it will shutdown again. Please contact your dealer for assistance. |
| - |  |  | The projector has shutdown automatically. If you try to restart the projector, it will shutdown again. Please contact your dealer for assistance. |
| - |  |  | The projector has shutdown automatically. If you try to restart the projector, it will shutdown again. Please contact your dealer for assistance. |
|  |  | - | The projector has shutdown automatically. If you try to restart the projector, it will shutdown again. Please contact your dealer for assistance. |

| | | | |
|---|---|---|---|
|  |  |  | The projector has shutdown automatically. If you try to restart the projector, it will shutdown again. Please contact your dealer for assistance. |
|  |  |  | The projector has shutdown automatically. If you try to restart the projector, it will shutdown again. Please contact your dealer for assistance. |
|  |  | - | The projector has shutdown automatically. If you try to restart the projector, it will shutdown again. Please contact your dealer for assistance. |
|  |  |  | The projector has shutdown automatically. If you try to restart the projector, it will shutdown again. Please contact your dealer for assistance. |
|  |  |  | The projector has shutdown automatically. If you try to restart the projector, it will shutdown again. Please contact your dealer for assistance. |
|  |  |  | The projector has shutdown automatically. If you try to restart the projector, it will shutdown again. Please contact your dealer for assistance. |

Service Information

Accessories (included in the standard package)

| Description | Part Number |
|-----------------------|--------------------|
| Power cord (US) | 27.01818.000 |
| Power cord (EU) | 27.82718.281 |
| Power cord (UK) | 27.01018.000 |
| VGA cable | 50.J0508.503 |
| Video cable | 50.J1303.501 |
| S-Video cable | 50.72920.011 |
| RCA R/W audio cable | 50.J1311.001 |
| PC - PC audio cable | 50.L4302.501 |
| Soft carry case | 47.J8104.001 |
| Component Video cable | 50.J2401.001 |
| USB mouse cable | 50.73213.501 |
| Remote control | 56.26J95.001 |
| 3-2 power converter | 22.91008.001 |
| D-Sub - DVI cable | 50.J2103.501 |

Optional Accessories (not included in the standard package)

| Description of parts | Part number |
|-----------------------------|--------------------|
| Mac adapter (switchable) | 20.20118.A15 |
| 300W lamp module | 60.J8106.001 |
| 250W lamp module | 59.J9421.CG1 |
| Ceiling mount kit | 60.J7683.001 |
| Wireless Pro (EU) | 59.J8201.001 |
| Wireless Pro (US) | 59.J8201.002 |
| Presentation Pro | 60.J2278.001 |
| DVI-I cable | 50.J2508.501 |

Ordering Parts or Getting Information

For product information, product assistance, service information, or to order accessories, please visit the BenQ Corporation website at <http://www.BenQ.com>.

6 Troubleshooting

Common Problems & Solutions

? THE PROJECTOR DOES NOT TURN ON.

| Cause | Remedy |
|---|--|
| There is no power from the power cable. | Plug the power cord into the AC inlet on the projector, and plug the power cord into the power outlet. If the power outlet has a switch, make sure that it is switched on. |
| Attempting to turn the projector on again during the cooling process. | Wait until the cooling down process has completed. |

? NO PICTURE

| Cause | Remedy |
|--|--|
| The video source is not turned on or connected correctly. | Turn the video source on and check that the signal cable is connected correctly. |
| The projector is not correctly connected to the input source device. | Check the connection. |
| The input signal has not been correctly selected. | Select the correct input signal with the Source key on the projector or remote control. |
| The lens cap is still attached to the lens. | Remove the lens cap. |

? BLURRED IMAGE

| Cause | Remedy |
|--|---|
| The projection lens is not correctly focused. | Adjust the focus of the lens using the focus ring. |
| The projector and the screen are not aligned properly. | Adjust the projection angle and direction as well as the height of the unit if necessary. |
| The lens cap is still attached to the lens | Remove the lens cap. |

? REMOTE CONTROL DOES NOT WORK

| Cause | Remedy |
|--|---|
| The batteries are out of power. | Replace both of the batteries with new ones. |
| There is an obstacle between the remote control and the projector. | Remove the obstacle. |
| You are too far away from the projector. | Stand within 6 meters (19.5 feet) of the projector. |

7 Specifications

Projector Specifications

Technical Specifications

 All specifications are subject to change without notice.

General

| | |
|--------------|-----------------------|
| Product name | Digital Projector |
| Model name | PB8240 1024 x 768 XGA |
| | PB8140 800 x 600 SVGA |
| | PB8250 1024 x 768 XGA |

Optical

| | |
|----------------|---------------------------|
| Display system | 1-CHIP DMD |
| Lens F/Number | F/2.4 |
| Lamp | PB8140 / PB8240 250W lamp |
| | PB8250 300W lamp |

Electrical

| | |
|-------------------|--|
| Power supply | AC100 ~ 240V, 4.5A, 50/60 Hz (Automatic) |
| Power consumption | PB8140 / PB8240 330W (Max) |
| | PB8250 395W (Max) |

Mechanical

| | |
|------------|--------------------------------------|
| Dimensions | 320 mm (W) x 106 mm (H) x 236 mm (D) |
| Weight | 7.7 lbs (3.5 Kg) |

Input terminal

| | |
|--------------------|--|
| Computer input | |
| RGB input | D-sub 15-pin (female) |
| DVI-I input | |
| Video signal input | |
| S-VIDEO | Mini DIN 4-pin port x1 |
| VIDEO | RCA jack x1 |
| HDTV signal input | D-sub <--> YPbPr RCA jack x 3, through RGB input |
| Audio signal input | |
| Audio 1 | Mini jack stereo port |

Output

| | |
|---------------------|----------------|
| USB mouse connector | A/B series x 1 |
| Speaker | 1 watt x 2 |
| RGB | |
| Audio L/R | |

Timing Chart

Supported timing for PC (including DVI-I) input

| Resolution | Horizontal Frequency (kHz) | Vertical Frequency (Hz) | Pixel Frequency (MHz) | Mode |
|-------------|----------------------------|-------------------------|-----------------------|--------------|
| 720 x 400 | 37.927 | 85.039 | 35.500 | 720 x 400_85 |
| 640 x 480 | 31.469 | 59.940 | 25.175 | VGA_60 |
| | 37.861 | 72.809 | 31.500 | VGA_72 |
| | 37.500 | 75.000 | 31.500 | VGA_75 |
| | 43.269 | 85.008 | 36.000 | VGA_85 |
| 800 x 600 | 37.879 | 60.317 | 40.000 | SVGA_60 |
| | 48.077 | 72.188 | 50.000 | SVGA_72 |
| | 46.875 | 75.000 | 49.500 | SVGA_75 |
| | 53.674 | 85.061 | 56.250 | SVGA_85 |
| 1024 x 768 | 48.363 | 60.004 | 65.000 | XGA_60 |
| | 56.476 | 70.069 | 75.000 | XGA_70 |
| | 60.023 | 75.029 | 78.750 | XGA_75 |
| | 68.667 | 84.997 | 94.500 | XGA_85 |
| 1280 x 1024 | 63.981 | 60.020 | 108.000 | SXGA3_60 |

Supported timing for YPbPr input

| Signal Format | Horizontal Frequency (kHz) | Vertical Frequency (Hz) |
|-------------------|----------------------------|-------------------------|
| 480i(525i)@60Hz | 15.73 | 59.94 |
| 480p(525p)@60Hz | 31.47 | 59.94 |
| 576i(625i)@50Hz | 15.63 | 50.00 |
| 576p(625p)@50Hz | 31.25 | 50.00 |
| 720p(750p)@60Hz | 45.00 | 60.00 |
| 720p(750p)@50Hz | 37.50 | 50.00 |
| 1080i(1125i)@60Hz | 33.75 | 60.00 |
| 1080i(1125i)@50Hz | 28.13 | 50.00 |

Supported timing for Video and S-Video inputs

| Video mode | Horizontal Frequency (kHz) | Vertical Frequency (Hz) | Color Sub-carrier Frequency (MHz) |
|------------|----------------------------|-------------------------|-----------------------------------|
| NTSC | 15.73 | 60 | 3.58 |
| PAL | 15.63 | 50 | 4.43 |
| SECAM | 15.63 | 50 | 4.25 or 4.41 |
| PAL-M | 15.73 | 60 | 3.58 |
| PAL-N | 15.63 | 50 | 3.58 |
| PAL-60 | 15.73 | 60 | 4.43 |
| NTSC4.43 | 15.73 | 60 | 4.43 |

8 Dimensions

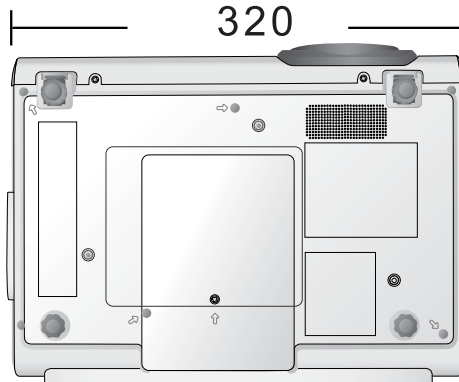
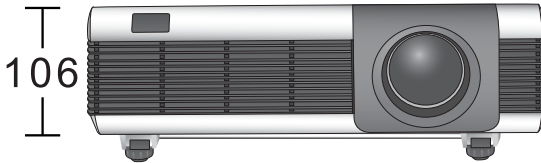
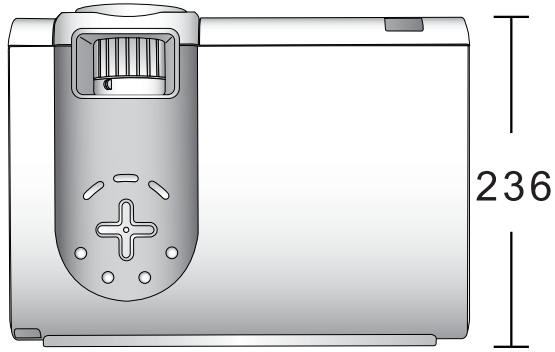

Unit: mm

Warranty

Limited Warranty

BenQ warrants this product against any defects in material and workmanship, under normal usage and storage.

Proof of purchase date will be required with any warranty claim. In the event this product is found to be defective within the warranty period, BenQ's only obligation and your exclusive remedy shall be replacement of any defective parts (labor included). To obtain warranty service, immediately notify the dealer from which you purchased the product of any defects.

Important: The above warranty shall be void if the customer fails to operate the product in accordance with BenQ's written instructions, especially the ambient humidity must be in-between 10% and 90%, temperature in-between 0°C and 35, altitude lower than 10000 feet, and avoiding to operate the projector in a dusty environment. This warranty gives you specific legal rights, and you may have other rights which vary from country to country.

For other information, please refer to BenQ Warranty Information Book.

10 Regulation Statements

FCC Statement

CLASS B: This equipment generates, uses and can radiate radio frequency energy and, if not installed and used in accordance with the instructions, may cause harmful interference to radio communications. However, there is no guarantee that interference will not occur in a particular installation. If this equipment does cause harmful interference to radio or television reception, which can be determined by turning the equipment off and on, the user is encouraged to try to correct the interference by one or more of the following measures:

- Reorient or relocate the receiving antenna.
- Increase the distance between the equipment and receiver.
- Connect the equipment into an outlet on a circuit different from that to which the receiver is connected.
- Consult the dealer or an experienced radio/TV technician for help.

EEC Statement

This machine was tested against the 89/336/EEC (European Economic Community) for EMC (Electric Magnetic Compatibility) and fulfills these requirements.

MIC Statement

B class equipment (Household purpose info/telecommunications equipment)

As this equipment has undergone EMC registration for household purpose, this product can be used in any area including residential area.