

myprojectorlamps.com

**The most trusted, dependable name
in projector lamp sales.**



<http://www.myprojectorlamps.com>



<http://www.myprojectorlamps.ca>



<http://www.myprojectorlamps.eu>

The following projector manual has not been modified or altered in any way.

BenQ PB7210/ PB7230/ PB7110
Digital Projector
User's Manual

Welcome

Copyright

Copyright 2004 by BenQ Corporation. All rights reserved. No part of this publication may be reproduced, transmitted, transcribed, stored in a retrieval system or translated into any language or computer language, in any form or by any means, electronic, mechanical, magnetic, optical, chemical, manual or otherwise, without the prior written permission of this company.

Disclaimer

BenQ Corporation makes no representations or warranties, either expressed or implied, with respect to the contents hereof and specifically disclaims any warranties, merchantability or fitness for any particular purpose. Further, BenQ Corporation reserves the right to revise this publication and to make changes from time to time in the contents hereof without obligation of this company to notify any person of such revision or changes.

*Windows, Internet Explorer and Outlook Express are trademarks of Microsoft Corporation. DLP, Digital Micromirror Device and DMD are trademarks of Texas Instruments. Others are copyrights of their respective companies or organizations.

Table of Contents

Important Safety Instructions	1
Introduction	4
Projector Features	4
Shipping Contents	5
Optional Accessories	5
Projector Description	6
You Projector at a Glance	6
External Control Panel	7
Adjuster	8
Remote Control Description	9
Remote Control Effective Range	10
Installing or Replacing Batteries	10
Installation	11
Screen Size	11
Connecting to Various Equipment	13
HDTV Equipment	13
Connecting to Various Equipment	14
Operation	16
Start Up	16
Digital Keystone Correction	17
Source Selection	17
Auto Adjustment	18
Blank	18
Menu System	19
1. Display Menu	20
2. Image Menu	21
3. Source Menu	22
4. Control Menu	23
5. PIP Menu	25
Shutdown	26
Maintenance	27
Lamp Information	27
Use and Replacement of the Lamp	27

Lamp Replacement	27
Resetting Lamp Hours	29
Temp Information	29
LED Indicator Status & Illustration	29
Service Information	32
Accessories (included in the standard package)	32
Optional Accessories (not included in the standard package)	32
Ordering Parts or Getting Information	32
Troubleshooting	33
Common Problems & Solutions	33
Status Messages	34
Specifications	35
Projector Specifications	35
Technical Specifications	35
Timing Chart	36
Supported timing for PC input	36
Supported timing for YPbPr input	36
Supported timing for Video and S-Video inputs	37
Dimensions	38
Warranty	39
Limited Warranty	39
Safety Regulations	40
FCC Statement	40
EEC Statement	40
MIC Statement	40

1 Important Safety Instructions

Your BenQ projector is designed and tested to meet the latest standards for safety of information technology equipment. However, to ensure safe use of this product, it is important that you follow the instructions mentioned in this manual and marked on the product.

Caution

- **To prevent shock, do not open the cabinet.** There are no user-serviceable parts inside.



- **Please read this user's manual before you operate your projector.** Save this user's manual for future reference.

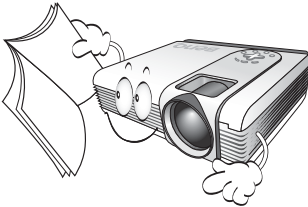

- **Do not look straight at the projector lens during operation.** The intense light beam may damage your eyes.

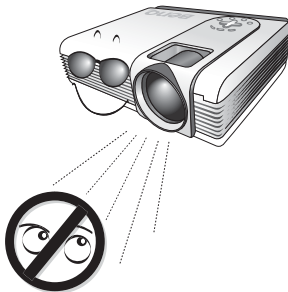

- **Refer servicing to qualified service personnel.**



- **Always open the lens shutter or remove the lens cap when the projector lamp is on.**



- In some countries, the line voltage is NOT stable. This projector is designed to operate safely within a mains voltage of 100 to 240 volts, but could fail if power cuts or surges of ± 10 volts occur. **In areas where the mains voltage may fluctuate or cut out, it is recommended that you connect your projector through a power stabilizer, surge protector or uninterruptible power supply (UPS).**

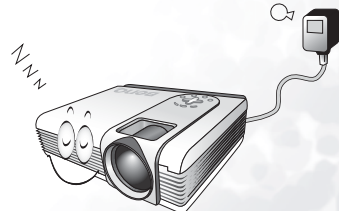

Safety Instructions

1. The lamp becomes extremely hot during operation. Allow the projector to cool for approximately 45 minutes prior to removing the lamp assembly for replacement.

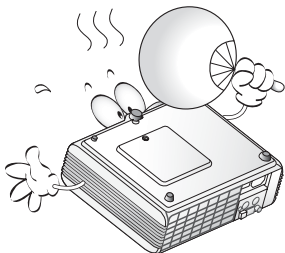

2. Do not operate lamps beyond the rated lamp life. Excessive operation of lamps beyond the rated life could cause them to explode on rare occasions.

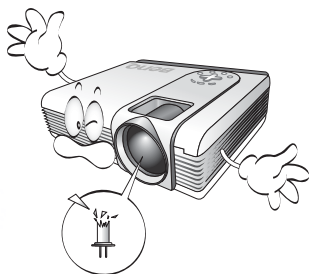

3. Never replace the lamp assembly or any electronic components unless the projector is unplugged.

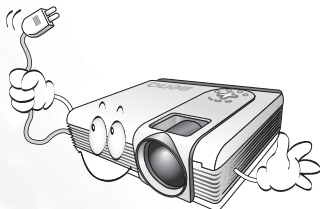

4. Do not place this product on an unstable cart, stand, or table. The product may fall, sustaining serious damage.

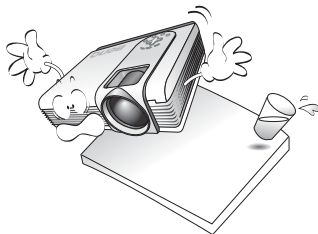

5. To reduce the risk of electric shock, do not disassemble this appliance. Take it to a qualified technician when service or repair is required. Incorrect reassembly can cause malfunction of the projector or electric shock when the appliance is subsequently used.

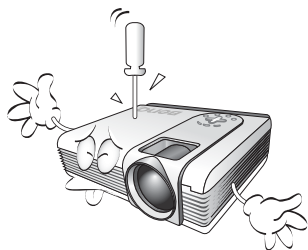

6. This product is capable of displaying inverted images for ceiling mount installation. Please use BenQ's Ceiling Mounting Kit for mounting the unit and ensure it is securely installed.

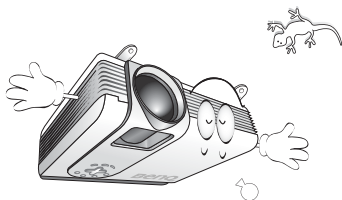

Safety Instructions (Continued)

7. Do not block the ventilation holes.
- Do not place this unit on a blanket, bedding or any other soft surface.
 - Do not cover this unit with a cloth or any other item.
 - Do not place inflammables near the projector.



If the ventilation holes are seriously obstructed, overheating inside the unit may result in a fire.

8. Do not place this unit in any of the following environments.
- Space that is poorly ventilated or confined. Allow at least 50 cm clearance from walls and free flow of air around the projector.
 - Locations where temperatures may become excessively high, such as the inside of a car with all windows rolled up.
 - Locations where excessive humidity, dust, or cigarette smoke may contaminate optical components, shortening the projector's lifespan and darkening the image.
 - Locations near fire alarms
 - Locations with an ambient temperature above 35°C / 95°F

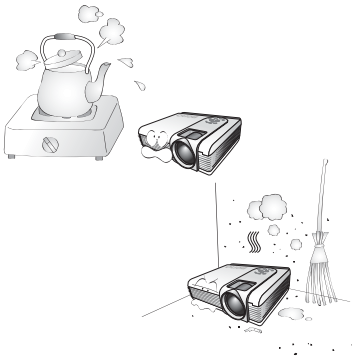

9. Always place the unit on a level, horizontal surface during operation.
- Do not use if tilted at an angle of more than 10 degrees left to right, nor at an angle of more than 15 degrees front to back. Using the unit when it is not fully horizontal may cause a malfunction of, or damage to, the lamp.

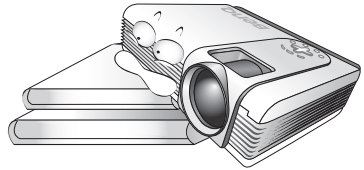

10. Do not stand the unit on end vertically.

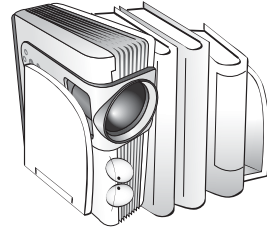

Doing so may cause the unit to fall over, causing injury or resulting in damage to the unit.

11. Do not step on this unit or place any objects upon it.



Besides probable physical damage to the unit, doing so may result in accidents and possible injury.

Introduction

Projector Features

The projector integrates high-performance optical engine projection and a user-friendly design to deliver high reliability and ease of use.

The projector offers the following features:

- Small and light for portability
- Full-function remote control with laser pointer/ remote mouse function
- High quality manual zoom lens
- One-key auto-adjustment to display the best picture quality
- Digital keystone correction to correct distorted images
- Adjustable color balance control for data/video display
- Ultra-high brightness projection lamp
- Ability to display 16.7 million colors
- On-screen menus in 9 languages: English, French, German, Italian, Spanish, Korean, Traditional Chinese, Simplified Chinese and Japanese.
- Switchable Normal/ Preset mode to reduce the power consumption
- Powerful AV function to provide high quality AV picture
- HDTV compatibility (YPbPr)
- Two PC input terminals



Note: The brightness of the projected image will vary depending on the ambient lighting conditions and contrast/brightness settings.

Shipping Contents

The projector is shipped with the cables required for connection to a PC and to video equipment. Carefully unpack and verify that you have all of the items shown below. If any of these items are missing, please contact your place of purchase.



Projector



Soft Carry Case



User's Manual



Batteries



3-2 Power Converter



User's Manual CD



Quick Start Guide



Warranty Booklet



Remote Control



S-Video Cable



Video Cable



VGA Cable



Audio Cable



USB Cable



Component Video Cable



Power Cord 110V

US



Power Cord 220V

EU



Power Cord 240V

UK

Optional Accessories

1. Macintosh adapter
2. 250W lamp module
3. Ceiling mount kit
4. Wireless Pro
5. Presentation Pro

Projector Description

You Projector at a Glance

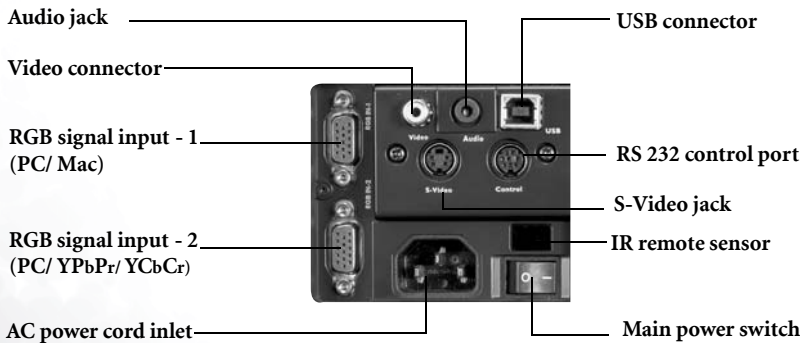
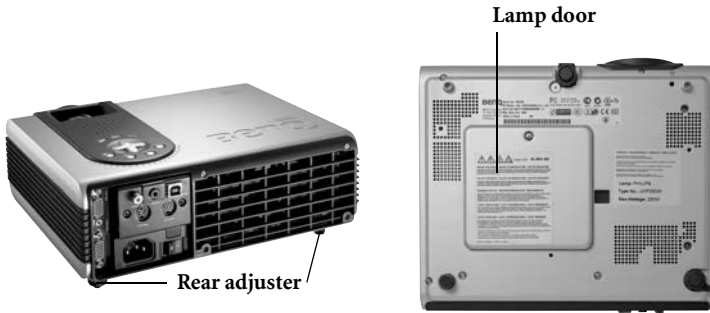
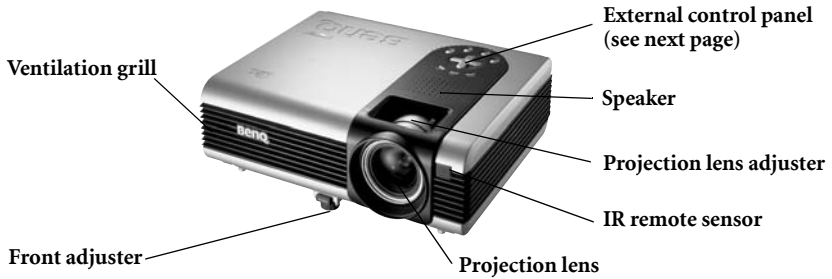

External Control Panel

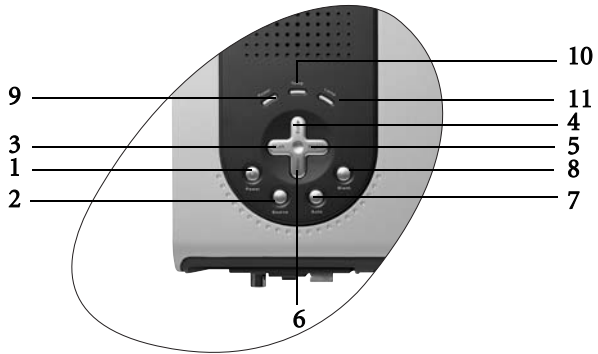

❶ Power

Press the **Power** key to turn the projector on or off.

❷ Source

Sequentially select the signal sources RGB-1, RGB-2, YPbPr, S-Video and Video.

❸ Left ❹ Exit ❺ Right ❻ Menu

Menu will display the menu system on screen. Press **Menu** again to access the sub-menu. **Left** and **Right** help you navigate among choices and settings in the menus and sub-menus. However, when the on-screen menu is not activated, the **Left** and **Right** buttons will function as **Keystone +/-** hot keys.

Press the **Exit** button to go back to the main menu. Press **Exit** again to leave the menu system.

❼ Auto

Automatically determines the best picture timings for the displayed image.

❽ Blank

Used to hide the screen image. You can press **Blank** again or **Return** to bring the image back.

❾ Power indicator light

It will light up or flash when the projector is under operation.

❿ Temperature warning light

The Temp indicator will flash when the system temperature is too high, which may occur if the projector is operated improperly. See "Temp Information" on page 29 for more detailed information.

⓫ Lamp indicator light

The Lamp Indicator will light up when the lamp needs service or replacement. See "Lamp Information" on page 27 for more detailed information.

Adjuster

The projector is equipped with 1 quick-release adjuster foot. Push the button to adjust its tilt angle.

1. Lift the projector up and press the adjuster button to release the adjuster.
2. The adjuster will drop into position and be locked.

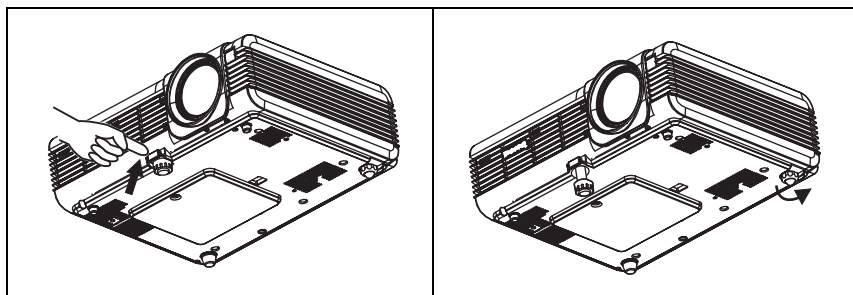

Remote Control Description

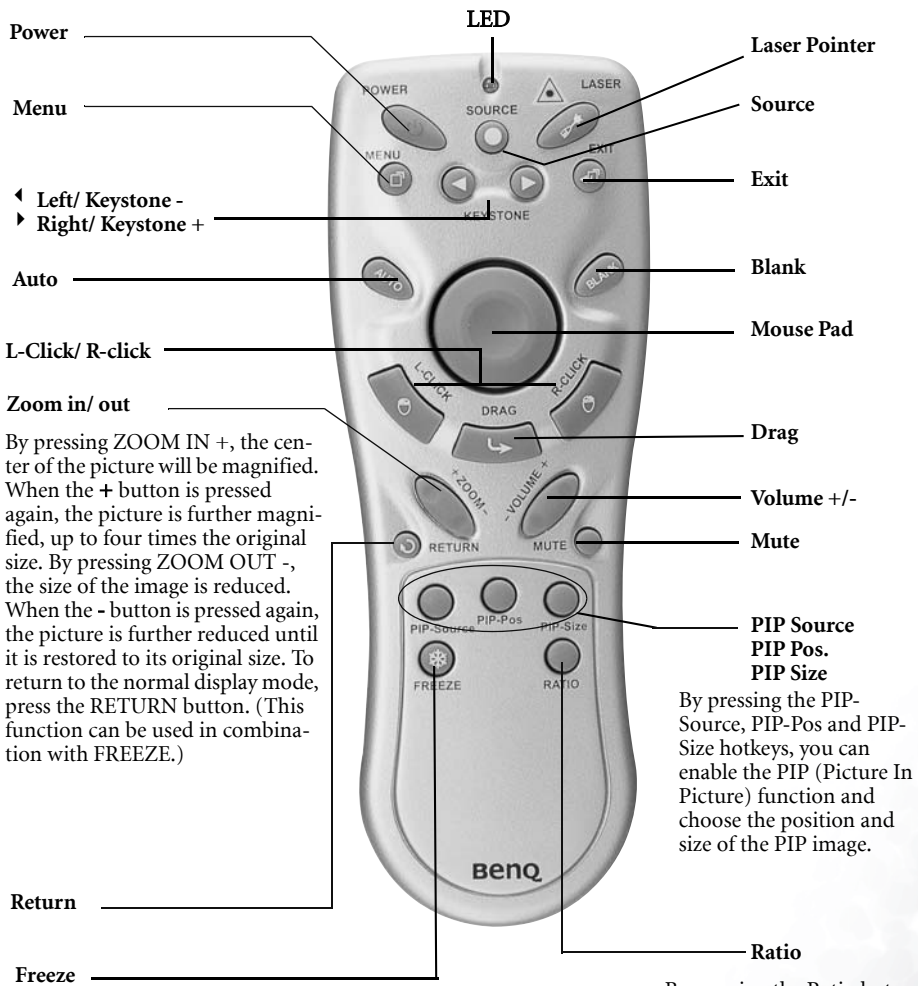

Zoom in/ out
 By pressing ZOOM IN +, the center of the picture will be magnified. When the + button is pressed again, the picture is further magnified, up to four times the original size. By pressing ZOOM OUT -, the size of the image is reduced. When the - button is pressed again, the picture is further reduced until it is restored to its original size. To return to the normal display mode, press the RETURN button. (This function can be used in combination with FREEZE.)

**PIP Source
 PIP Pos.
 PIP Size**
 By pressing the PIP-Source, PIP-Pos and PIP-Size hotkeys, you can enable the PIP (Picture In Picture) function and choose the position and size of the PIP image.

Return
Freeze
 The image is frozen when FREEZE is pressed. A "Pause" icon will appear in the lower right corner of the screen. To release the freeze function, press the FREEZE button, RETURN button or SOURCE button (when the input source is switched over during display) again.

Ratio
 By pressing the Ratio hotkey, you can select the screen aspect ratio you prefer: 4:3, 16:9 or 1:1 (native picture size).

Remote Control Effective Range

Infra Red (IR) remote control sensors are located on the front and the back of the projector. It can function in a range of 30 degrees horizontally and 30 degrees vertically relative to a line that is a right angle to the remote sensors to function correctly. The distance between the remote control and the remote sensors should not exceed 6 meters (19.5 feet).

Installing or Replacing Batteries

- 1** Push and open the battery compartment lid in the direction shown.
- 2** Install batteries as indicated by the diagram inside the compartment.
- 3** Position the lid over the compartment and snap it back into place.



⚠ Avoid excessive heat and humidity. There may be danger of an explosion if batteries are incorrectly replaced. Replace only with the same or equivalent type recommended by the manufacturer. Dispose of the used batteries according to the manufacturer's instructions.

3 Installation

Screen Size

Place the projector at the required distance from the screen according to the desired picture size (see the table below).

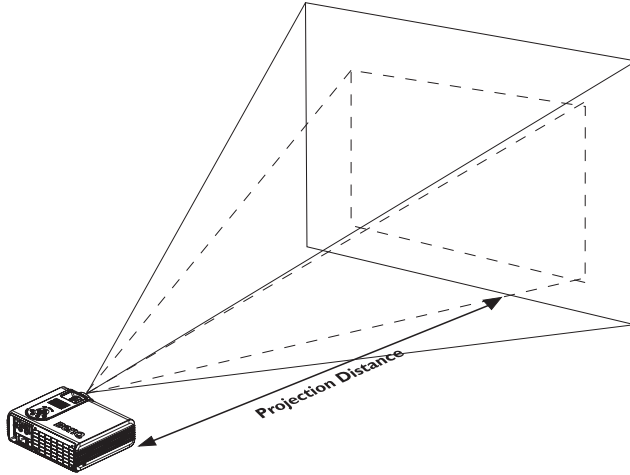

PB7210/ PB7230 (XGA) screen size chart (4:3 aspect ratio)

Distance from screen		Diagonal measurement			
		Minimum zoom		Maximum zoom	
feet	inches	feet	inches	feet	inches
4	48	2.49	29.9	3.05	36.6
6	72	3.73	44.8	4.57	54.9
8	96	4.98	59.7	6.10	73.2
10	120	6.22	74.7	7.62	91.4
12	144	7.47	89.6	9.14	109.7
14	168	8.71	104.5	10.67	128.0
16	192	9.96	119.5	12.19	146.3
18	216	11.20	134.4	13.72	164.6
20	240	12.45	149.4	15.24	182.9
22	264	13.69	164.3	16.76	201.2
24	288	14.94	179.2	18.29	219.5
26	312	16.18	194.2	19.81	237.7
28	336	17.42	209.1	21.34	256.0
30	360	18.67	224.0	22.86	274.3
32	384	19.91	239.0	24.38	292.6

Distance from screen		Diagonal measurement			
		Minimum zoom		Maximum zoom	
meters	cm	meters	cm	meters	cm
1	100	0.62	62.2	0.76	76.2
1.5	150	0.93	93.3	1.14	114.3
2	200	1.24	124.5	1.52	152.4
2.5	250	1.56	155.6	1.91	190.5
3	300	1.87	186.7	2.29	228.6
3.5	350	2.18	217.8	2.67	266.7
4	400	2.49	248.9	3.05	304.8
4.5	450	2.80	280.0	3.43	342.9
5	500	3.11	311.2	3.81	381.0
5.5	550	3.42	342.3	4.19	419.1
6	600	3.73	373.4	4.57	457.2
6.5	650	4.04	404.5	4.95	495.3
7	700	4.36	435.6	5.33	533.4
7.5	750	4.67	466.7	5.72	571.5
8	800	4.98	497.8	6.10	609.6

PB7210/ PB7230 (XGA) screen size chart (16:9 aspect ratio)

Distance from screen		Diagonal measurement			
		Minimum zoom		Maximum zoom	
feet	inches	feet	inches	feet	inches
4	48	2.29	27.5	2.80	33.6
6	72	3.44	41.3	4.20	50.4
8	96	4.59	55.1	5.60	67.2
10	120	5.74	68.8	7.00	84.0
12	144	6.88	82.6	8.40	100.8
14	168	8.03	96.4	9.80	117.6
16	192	9.18	110.1	11.20	134.4
18	216	10.32	123.9	12.60	151.2
20	240	11.47	137.7	14.00	167.9
22	264	12.62	151.4	15.39	184.7
24	288	13.77	165.2	16.79	201.5
26	312	14.91	179.0	18.19	218.3
28	336	16.06	192.7	19.59	235.1
30	360	17.21	206.5	20.99	251.9
32	384	18.35	220.3	22.39	268.7

Distance from screen		Diagonal measurement			
		Minimum zoom		Maximum zoom	
meters	cm	meters	cm	meters	cm
1	100	0.57	57.4	0.70	70.0
1.5	150	0.86	86.0	1.05	105.0
2	200	1.15	114.7	1.40	140.0
2.5	250	1.43	143.4	1.75	179.4
3	300	1.72	172.1	2.10	209.9
3.5	350	2.01	200.8	2.45	244.9
4	400	2.29	229.4	2.80	279.9
4.5	450	2.58	258.1	3.15	314.9
5	500	2.87	286.8	3.50	349.9
5.5	550	3.15	315.5	3.85	384.9
6	600	3.44	344.1	4.20	419.9
6.5	650	3.73	372.8	4.55	454.9
7	700	4.02	401.5	4.90	489.8
7.5	750	4.30	430.2	5.25	524.8
8	800	4.59	458.9	5.60	559.8

PB7110 (SVGA) screen size chart (4:3 aspect ratio)

Distance from screen		Diagonal measurement			
		Minimum zoom		Maximum zoom	
feet	inches	feet	inches	feet	inches
4	48	1.96	23.5	2.40	28.7
6	72	2.93	35.2	3.59	43.1
8	96	3.91	47.0	4.79	57.5
10	120	4.89	58.7	5.99	71.9
12	144	5.87	70.4	7.19	86.2
14	168	6.85	82.2	8.39	100.6
16	192	7.83	93.9	9.58	115.0
18	216	8.80	105.7	10.78	129.4
20	240	9.78	117.4	11.98	143.7
22	264	10.76	129.1	13.18	158.1
24	288	11.74	140.9	14.37	172.5
26	312	12.72	152.6	15.57	186.9
28	336	13.70	164.3	16.77	201.2
30	360	14.67	176.1	17.97	215.6
32	384	15.65	187.8	19.17	230.0

Distance from screen		Diagonal measurement			
		Minimum zoom		Maximum zoom	
meters	cm	meters	cm	meters	cm
1	100	0.49	48.9	0.60	59.9
1.5	150	0.73	73.4	0.90	89.8
2	200	0.98	97.8	1.20	119.8
2.5	250	1.22	122.3	1.50	149.7
3	300	1.47	146.7	1.80	179.7
3.5	350	1.71	171.2	2.10	209.6
4	400	1.96	195.7	2.40	239.6
4.5	450	2.20	220.1	2.70	269.5
5	500	2.45	244.6	2.99	299.5
5.5	550	2.69	269.0	3.29	329.4
6	600	2.93	293.5	3.59	359.4
6.5	650	3.18	317.9	3.89	389.3
7	700	3.42	342.4	4.19	419.3
7.5	750	3.67	366.8	4.49	449.2
8	800	3.91	391.3	4.79	479.1

PB7110 (SVGA) screen size chart (16:9 aspect ratio)

Distance from screen		Diagonal measurement				Distance from screen		Diagonal measurement			
		Minimum zoom		Maximum zoom				Minimum zoom		Maximum zoom	
feet	inches	feet	inches	feet	inches	meters	cm	meters	cm	meters	cm
4	48	1.80	21.6	2.20	26.4	1	100	0.45	45.1	0.55	55.0
6	72	2.70	32.4	4.20	50.4	1.5	150	0.68	67.6	0.82	82.5
8	96	3.61	43.3	5.60	67.2	2	200	0.90	90.1	1.10	110.0
10	120	4.51	54.1	7.00	84.0	2.5	250	1.13	112.7	1.37	137.5
12	144	5.41	64.9	8.40	100.8	3	300	1.35	135.2	1.65	164.9
14	168	6.31	75.7	9.80	117.6	3.5	350	1.58	157.7	1.92	192.4
16	192	7.21	86.5	11.20	134.4	4	400	1.80	180.3	2.20	219.9
18	216	8.11	97.3	12.60	151.2	4.5	450	2.03	202.8	2.47	247.4
20	240	9.01	108.2	14.00	167.9	5	500	2.25	225.3	2.75	274.9
22	264	9.91	119.0	15.39	184.7	5.5	550	2.48	247.9	3.02	302.4
24	288	10.82	129.8	16.79	201.5	6	600	2.70	270.4	3.30	329.9
26	312	11.72	140.6	18.19	218.3	6.5	650	2.93	292.9	3.57	357.4
28	336	12.62	151.4	19.59	235.1	7	700	3.15	315.5	3.85	384.9
30	360	13.52	162.2	20.99	251.9	7.5	750	3.38	338.0	4.12	412.4
32	384	14.42	173.1	22.39	268.7	8	800	3.61	360.5	4.40	439.8

 There is 3% ~ 5% tolerance among these numbers due to optical component limits.

* 1m = 3.28 feet, 1 feet = 0.305m, 1m = 100cm, 1 feet = 12 inches

Connecting to Various Equipment

HDTV Equipment

The projector is capable of displaying various High Definition TV display modes. Some of these sources are:

- Digital-VHS (D-VHS) player
- DVD player
- Satellite Dish HDTV receiver
- Digital TV tuners

Most of these sources will provide an analog component video output, a standard VGA output, or a YPbPr (default) format.

The projector is capable of accepting HDTV data through a Component Video connector. Use a Component Video cable that came with your projector to display these images.

The following standards are supported in the HDTV function:

- 480i
- 480p
- 720p
- 1080i

Please refer to "Menu System" on page 19 for information on the HDTV OSD selections.

Connecting to Various Equipment

It only takes a few seconds to connect your projector to your desktop or notebook computer, VCR, or other systems. However, a Mac adapter (an optional accessory) may be necessary for connection to an older Macintosh computer.

1. Notebook/ Computer (Macintosh computer or SOG signal is only supported with RGB IN-1.)

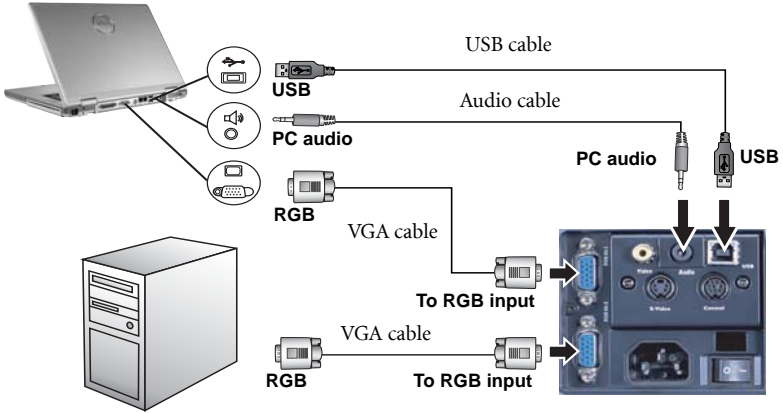

The USB cable is required if you intend using the mouse functions on the remote control.

2. DVD player or HDTV signal can only support with RGB IN-2.

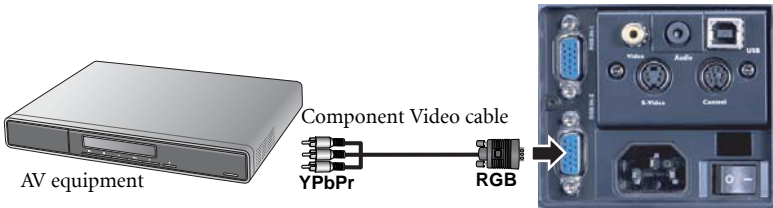

3. S-video device

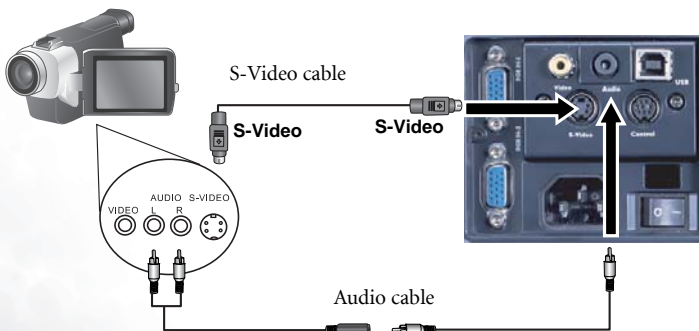

4. Video device or VCR

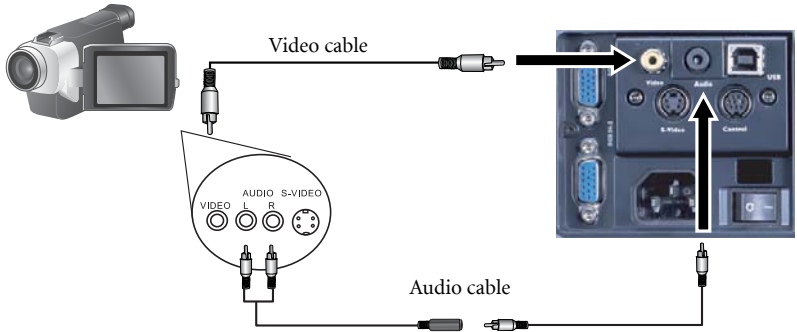

4 Operation

Start Up

1. Plug the power cord into the projector and into a wall socket.

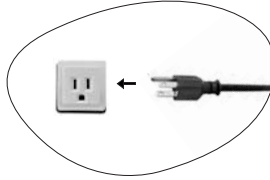

2. Turn the main power switch on.

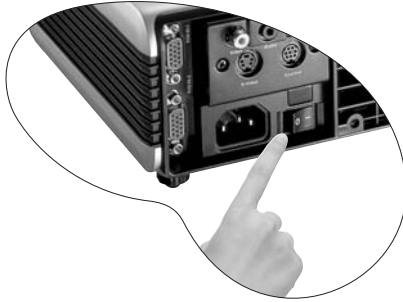

3. Press and hold POWER to start the unit. The back-lit POWER key flashes green and stays green when the power is turned on.



(When the power is turned off, there is a 90-second cooling period before the projector can be re-started.)

4. Switch on all connected equipment.

Digital Keystone Correction

Keystoning refers to the situation where the projected image is noticeably wider at either the top or bottom. To correct this, press **Left/ Right** (hot key) on the control panel of the projector or KEYSTONE **Left/ Right** on the remote control, and then adjust the sliding bar labeled Keystone, as needed. Press **+** to correct keystoning at the top of the image. Press **-** to correct keystoning at the bottom of the image.



Source Selection

To sequentially select the input sources, press SOURCE on the control panel of the projector or the remote control.

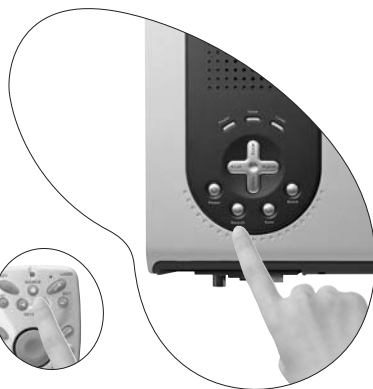

Auto Adjustment

In some cases, you may need to optimize the picture quality. To do this, press the **AUTO** key on the control panel of the projector or on the remote control. Within 3 seconds, the built-in Intelligent Auto Adjustment function will re-adjust settings to provide the best picture quality.

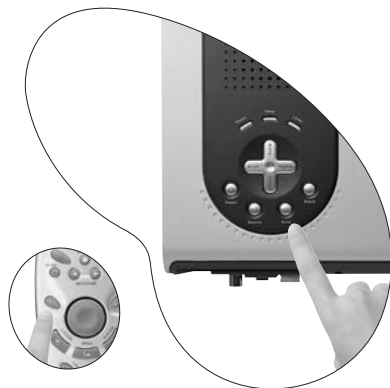





Blank

Use **Blank** to hide the screen image. You can press **Blank** again or **Return** to restore the image.









Menu System

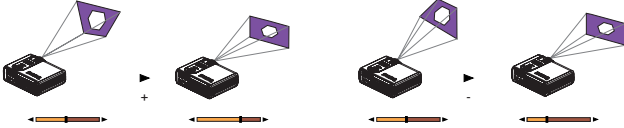
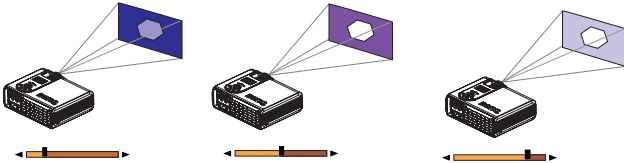
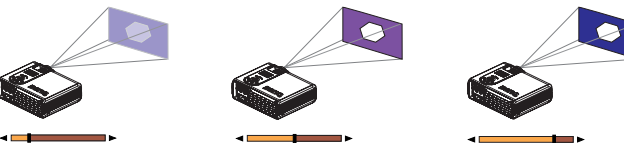







Press **Menu** for the main menu, and then press ◀ or ▶ to select a sub-menu. Press **Menu** again to select items in the sub-menu.

Menu Bar					
Sub-menu	Display	Image	Source	Control	PIP
PC	Keystone Brightness Contrast Phase H Size	Auto Resize H Position V Position Color Temp Information	Mirror Source Volume Mute	Language OSD Setup Preset Mode Reset Lamp Hour	Main page: PIP Source PIP Size PIP Pos. H Position V Position More Options Sub Page: Brightness Contrast Color Tint Sharpness System
Y/Pb/Pr		Ratio Color Tint Color Temp			
Video / S-Video		Ratio System Sharpness Color Temp Information			

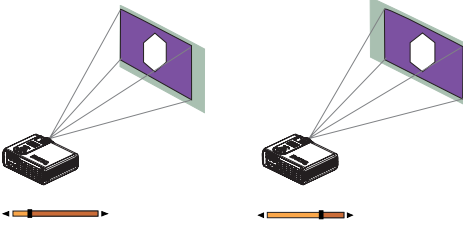

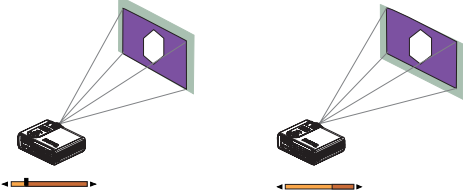

1. Display Menu

FUNCTION	DESCRIPTION
Keystone	<p>Corrects any keystoneing of the image.</p> 
Brightness	<p>Adjusts the brightness of the image.</p> 
Contrast	<p>Adjusts the degree of difference between dark and light in the image.</p> 
Phase	<p>Adjusts to avoid the occurrence of flicker.</p>  <p> This function is not available when the input source is Video or S-Video.</p>
H Size	<p>Adjusts the horizontal width of the image.</p> <p> This function is not available when the input source is Video or S-Video.</p>
Color	<p>Increases or decreases the color range (R, G, B) of the image.</p> <p> This function is not available when a PC input is selected.</p>
Tint	<p>Adjusts the image to make it appear more red or blue.</p> <p> This function is not available when a PC input is selected.</p>

2. Image Menu

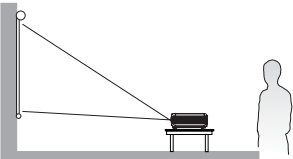
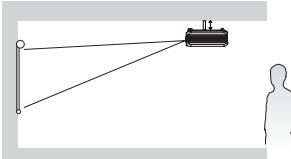
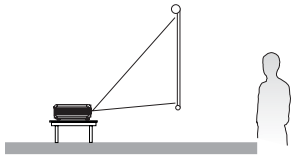
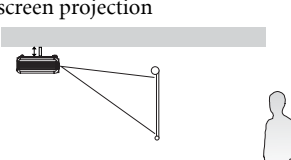
FUNCTION	DESCRIPTION
Auto Resize	Makes the best fit of the image to the screen, 1. On 2. Off 3. 16:9  This function is available only when a PC input is selected .
Ratio	Users have 2 options for the image ratio. 1. 4 : 3 2. 16 : 9  This function is available when the input source is YPbPr, Video or S-Video.
H Position	Adjusts the horizontal position of the projected image.   This function is available only when a PC input is selected.
V Position	Adjusts the vertical position of the projected image.   This function is available only when a PC input is selected.
Color Temp	Adjusts the color temperature to fit your preference.
Information	Shows the current resolution.
System	System information will be shown: 1.NTSC 2. PAL 3.SECAM 4. YUV
Sharpness	Adjusts the image to make it look sharper or softer.  This function is not available when the input selected is PC or YPbPr.
Color	Increases or decreases the color intensity of the image.  This function is not available when a PC input is selected.
Tint	Adjusts the image to make it appear more red or blue.  This function is available only when the input System is NTSC.

3. Source Menu

FUNCTION	DESCRIPTION
Mirror	<div style="display: flex; justify-content: space-around;"> <div style="text-align: center;"> <p>1. Default</p>  </div> <div style="text-align: center;"> <p>2. Ceiling mounted projection</p>  </div> </div> <div style="display: flex; justify-content: space-around; margin-top: 20px;"> <div style="text-align: center;"> <p>3. Rear screen projection</p>  </div> <div style="text-align: center;"> <p>4. Ceiling mounted and rear-screen projection</p>  </div> </div>
Source	<p>Shows the input source from among RGB-1, RGB-2, YPbPr, S-Video and Video when several sources are available.</p>
Volume	<p>Adjusts the volume level.</p> 
Mute	<div style="display: flex; justify-content: space-around; align-items: center;"> <div style="text-align: center;"> <p>Off</p>  </div> <div style="text-align: center;"> <p>On</p>  </div> </div>

4. Control Menu

FUNCTION	DESCRIPTION
Language	<p>Language sets the language for the OSD control menus.</p> <p>Use the ◀ / ▶ key to select your desired language from among English, French, German, Italian, Spanish, Korean, Traditional Chinese, Simplified Chinese and Japanese.</p>
OSD	<p>OSD Pos. Selects a desired OSD position.</p>
	<p>OSD Time Sets the length of time the OSD will remain active after your last button press. The range is from 5 to 60 seconds in 5-second increments.</p>
Setup	<p>Source Scan When selected, activates the Source scan function.</p>
	<p>Keystone Hold When selected, preserves the last keystone correction value even when the projector is restarted.</p>
	<p>Mirror Hold When selected, preserves the last mirror correction value even when the projector is restarted.</p>
	<p>Blank Time Determines the length of time before the projector will automatically shutdown when Blank is activated.</p>
	<p>Auto Off Sets the length of time before the system is shut off when no input is detected.</p>
	<p>User Logo Enables the user to select which logo screen will appear during the start-up. Three modes are available: Default (BenQ logo), black screen or blue screen.</p>

<p>Preset Mode</p>	<p>Preset modes are provided so you can optimize your projector image set-up to suit your program type</p> <p>PC Signal Input</p> <ol style="list-style-type: none"> 1. Presentation Mode: Is designed for presentations. The brightness is emphasized in this mode. 2. Vivid Mode: Is perfect for playing games. The color saturation and brightness are well-balanced. 3. Video Mode: Is suitable for cinematic enjoyment displaying images in their natural color. 4. Economic Mode: Use this mode to reduce system noise and reduce power consumption by 20%. The lamp life is also extended with lower light output. <p>YPbPr/ S-Video/ Video Signal Input</p> <ol style="list-style-type: none"> 1. Gaming Mode: Is suitable for playing video games in a bright living room. 2. Video Mode: With a higher color temperature, it is suitable for enjoying TV movies. 3. Cinema Mode: With a lower color temperature, it is suitable for enjoying cinematic movies. 4. Economic Mode: Use this mode to reduce system noise and reduce power consumption by 20%. The lamp life is also extended with lower light output.
<p>Reset</p>	<p>Returns all settings to the factory preset values.</p>
<p>Lamp Hour</p>	<p>Displays the number of hours the lamp has been used.</p>

5. PIP Menu

These functions are available only when the input mode is PC and the PIP source is Video or S-Video.

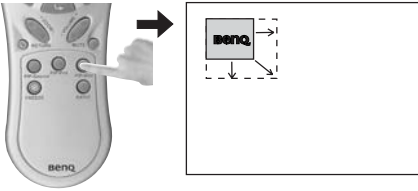
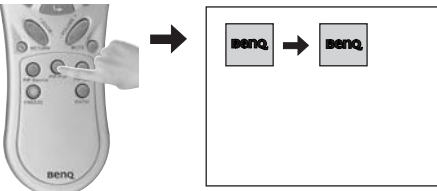
FUNCTION	DESCRIPTION
PIP Source	Selects the source for the PIP.
PIP Size	<p>Press the ◀ / ▶ keys to scroll through the four alternatives: Off, Small, Medium, Large.</p>  <p>☞ When the resolution of the PC signal is 1280x1024 (SXGA), the selected Large PIP size will be reduced to the Medium size.</p>
PIP Position	<p>Selects a desired position for the PIP.</p> 
H Position	Adjusts the horizontal position of the PIP image.
V Position	Adjusts the vertical position of the PIP image.
More Options	Press the ◀ / ▶ keys to select more PIP functions including Brightness, Contrast, Color, Tint, Sharpness and System.
Brightness	Adjusts the brightness of the PIP image.
Contrast	Adjusts the degree of difference between dark and light for the PIP image.
Color	Increases or decreases the color range (R, G, B) of the image.
Tint	Adjusts the image to make it appear more red or blue.
Sharpness	Adjusts the image to make it appear sharper or softer
System	Shows PIP image systems: NTSC, PAL, SECAM and YUV.

Shutdown

1. Press and hold **POWER** and a warning message will appear. To turn the projector off, press and hold **POWER** again.

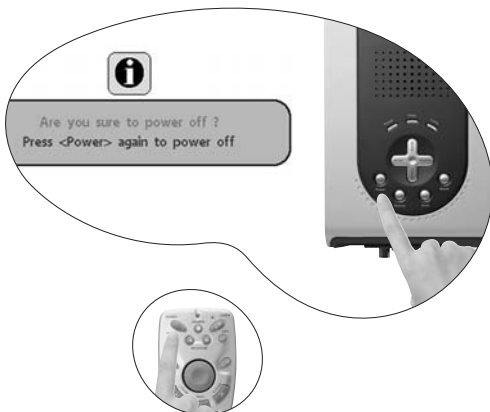

2. The fan will continue to run for approximately 90 seconds.
3. Turn the main power switch off.

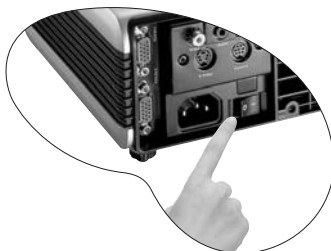

4. Disconnect the power cord from the wall socket.

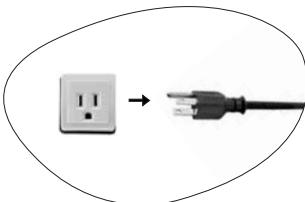

 **Do not unplug the power cord before the projector shutdown sequence is complete or during the 90-second cooling down process.**
If the projector is not properly shut down, to protect the lamp, the system will detect this and cool the lamp for 90 seconds automatically before turning on again.

5 Maintenance

Lamp Information

Use and Replacement of the Lamp

When the Lamp Indicator lights up red or a message appears suggesting it is time to replace the lamp, please install a new lamp or consult your dealer. An old lamp could cause a malfunction in the projector and in some instances the projector may break.

For more detailed information, please refer to "LED Indicator Status & Illustration" on page 29.

- ⚠ **The Lamp and Temp indicators will light up if the lamp becomes too hot. Turn the power off and let the projector cool for 45 minutes. If the Lamp or Temp indicator still lights up when turning the power on, please contact your dealer.**

Lamp Replacement

- ⚠ **To reduce the risk of electrical shock, always turn the projector off and disconnect the power cord before changing the lamp.**

To reduce the risk of severe burns, allow the projector to cool for at least 45 minutes before replacing the lamp.

To reduce the risk of injuries to fingers and damage to internal components, use caution when removing lamp glass that has shattered into sharp pieces.

To reduce the risk of injuries to fingers and/or compromising image quality by touching the lens, do not touch the empty lamp compartment when the lamp is removed.

This lamp contains mercury. Consult your local hazardous waste regulations to dispose of this lamp in a proper manner.

- Step 1. Turn the projector off. Disconnect the power cord from the outlet and the projector.
- Step 2. Loosen the screw and remove the lamp cover. If the lamp is hot, avoid burns by waiting 45 minutes until the lamp has cooled.

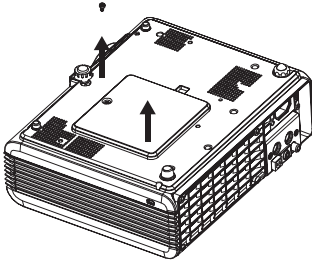

- Step 3. Loosen the 3 screws. (It is strongly recommended that you use a magnetic-head screwdriver.) Pull the handle to remove the lamp housing. If the screws are not loosened completely, you could injure your fingers. Do not insert your hand into the projector after the lamp is removed. If you touch the optical components inside, this could cause color unevenness in projected images.

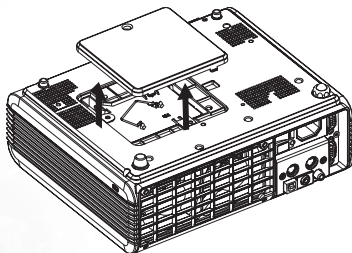

- Step 4. Replace the lamp with the new one. Insert it into the projector, and tighten the screws firmly. Loose screws may cause a bad connection, which may result in malfunction.

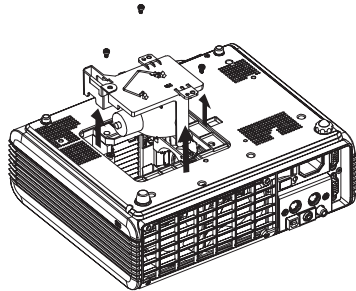

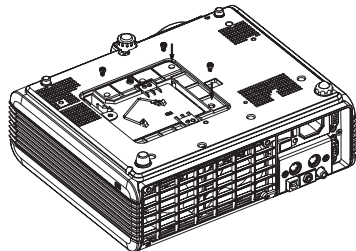

- Step 5. Re-install the lamp cover and tighten the screw. **Do not turn the power on with the lamp cover removed.** Whenever the lamp is replaced, reset the total lamp operation time. **Do not reset if the lamp is not replaced as this could cause damage.**



Resetting Lamp Hours

If you replace the lamp after 2000 hours of operation, please follow the instructions below within 10 minutes of powering on.

OSD	FUNCTION
	<p>Press and hold the Exit button on the projector for 3 seconds to display the total used lamp time.</p>
	<ul style="list-style-type: none"> • Press the MENU button on the projector during the lamp hour message. An adjustment message will appear. • Press ◀ or ▶ to reset lamp hours or press EXIT to leave.

Temp Information

When the LED lights up, it is warning you of the following possible problems:



1. The internal temperature is too high.
2. The fans are not working.



















Turn the projector off and contact qualified service personnel for further help.













For more detailed information, please refer to "LED Indicator Status & Illustration" on page 29.

LED Indicator Status & Illustration

Illustration

1. -: LED OFF
2.  : LED blinking
3.  : LED solid ON
4. **O** : LED lights up orange.
5. **R** : LED lights up red.
6. **G** : LED lights up green.

LED			Status & Description
Power	Temp	Lamp	
Power events			
			Power switch on
	-	-	Power-up cooling. The projector needs 90 seconds to cool down as it was abnormally shutdown without the normal cooling down sequence.
	-	-	Stand-by mode.
	-	-	Lamp LED is blinking during powering up.
	-	-	Power-down cooling for 90 seconds after power has been turned off.
	-	-	Normal operation
Lamp events			
-	-		It is warning you that lamp usage has exceeded 2000 hours. Replace the projection lamp with a new one immediately.
-	-		The lamp is not properly attached or the lamp is damaged. Please contact your dealer for assistance.
Thermal events			
		-	The projector will shutdown automatically. If you re-turn on the power, the projector will shutdown again. Please contact your dealer for assistance.
			The projector will shutdown automatically. If you re-turn on the power, the projector will shutdown again. Please contact your dealer for assistance.
			The projector will shutdown automatically. If you try to restart the projector, it will shutdown again. Please contact your dealer for assistance.

		-	Thermal sensor 1 over-temperature. The projector will shutdown automatically. If you try to restart the projector, it will shutdown again. Please contact your dealer for assistance.
			Thermal sensor 2 over-temperature. The projector will shutdown automatically. If you try to restart the projector, it will shutdown again. Please contact your dealer for assistance.
			Thermal sensor 3 over-temperature. The projector will shutdown automatically. If you try to restart the projector, it will shutdown again. Please contact your dealer for assistance.
-		-	Thermal sensor 1 doesn't work. The projector will shutdown automatically. If you try to restart the projector, it will shutdown again. Please contact your dealer for assistance.
-			Thermal sensor 2 doesn't work. The projector will shutdown automatically. If you try to restart the projector, it will shutdown again. Please contact your dealer for assistance.
-			Thermal sensor 3 doesn't work. The projector will shutdown automatically. If you try to restart the projector, it will shutdown again. Please contact your dealer for assistance.

Service Information

Accessories (included in the standard package)

Description	Part Number
Power cord (US)	27.01818.000
Power cord (EU)	27.82718.281
Power cord (UK)	27.01018.000
Signal cable.....	50.J0508.502
Video cable.....	50.J1303.501
S-Video cable	50.72920.011
RCA R/W audio cable.....	50.J1311.001
PC - PC audio cable	50.74405.501
Soft carry case	98.J7601.001
Component Video cable	50.J2401.001
USB mouse cable.....	50.73213.501
Remote control	98.J3401.011
3-2 power converter	22.91007.001

Optional Accessories (not included in the standard package)

Description of parts	Partnumber
Mac adapter (switchable)	20.20118.A15
250W lamp module (UHP)	60.J7693.CG1
250W lamp module (P-VIP)	59.J8401.CG1
Ceiling mount kit.....	60.J7683.001
Wireless Pro (EU)	59.J8201.001
Wireless Pro (US).....	59.J8201.002
Presentation Pro.....	60.J2278.001

Ordering Parts or Getting Information

For product information, product assistance, service information, or to order accessories, please visit the BenQ Corporation website at <http://www.BenQ.com>.

6 Troubleshooting

Common Problems & Solutions

? NO POWER

☞ Try these solutions:

- Make sure the power cord is inserted snugged into the AC adapter socket.
- Make sure the power cord is inserted snugged into the power outlet.
- Toggle the power switch to the position “I”.
- Wait 90 seconds after the projector is turned off before turning the projector back on.

? NO PICTURE

☞ Try these solutions:

- Check for the proper input source.
- Ensure all cables are connected properly.
- Adjust the brightness and contrast.
- Remove the lens cap.

? TRAPEZOID IMAGE ON THE SCREEN

☞ Try these solutions:

- Reposition the unit to improve its angle on the screen.
- Use the **Keystone** correction key on the control panel of the projector or the remote control unit.

? POOR COLOR

☞ Try these solutions:

- Select the correct video system.
- Adjust brightness, contrast, or saturation.

? BLURRED IMAGE

☞ Try these solutions:

- Press **Auto** on the control panel of the projector or the remote control unit to get better picture quality.
- Adjust the focus.
- Reposition the unit to improve its projection angle.
- Ensure the distance between the unit and screen is within the adjustment range of the lens.

? REMOTE CONTROL DOES NOT WORK

☞ Try these solutions:

- Replace the batteries with new ones.
- Make sure there is no obstacle between the remote control and the projector.
- Stand within 6 meters (19.5 feet) of the projector.
- Make sure nothing is blocking the front and rear receivers.

Status Messages

On-Screen Messages	Description
SEARCHING	Projector is searching for input.
ACQUIRING SIGNAL	Projector has identified the input signal and is running the auto image adjustment function.
OUT OF RANGE	Input signal frequency exceeds the projector's range.
LAMP WARNING - CHANGE LAMP AND RESET LAMP TIMER!	The lamp has been in operation for 1900 hours. Install a new lamp for optimal performance.
OUT OF LAMP USAGE TIME. YOU HAVE TO CHANGE THE LAMP!	The lamp has been in operation for 1980 hours, and the power will turn off after 20 hours.
OUT OF LAMP USAGE TIME. CHANGE THE LAMP!	The lamp has been in operation for over 2000 hours. The warning message will display for 30 seconds every 5 minutes after you turn on the projector and the power will turn off automatically after 10 minutes.

Specifications

Projector Specifications

Technical Specifications

 All specifications are subject to change without notice.

General

Product name	Digital Projector
Model name	PB7210 1024 x 768 XGA
	PB7230 1024 x 768 XGA
	PB7110 800 x 600 SVGA

Optical

Display system	1-CHIP DMD
Lens F/Number	F/2.6
Lamp	250W lamp

Electrical

Power supply	AC100 ~ 240V, 4.0A, 50/60 Hz (Automatic)
Power consumption	330W (Max)

Mechanical

Dimensions	258 mm (W) x 80 mm (H) x 211.5 mm (D)
Operating temperature range	0°C ~ 40°C
Weight	5.9 lbs (2.7 Kg)

Input terminal

Computer input	
RGB input - 1	D-sub 15-pin (female)
RGB input - 2	D-sub 15-pin (female)
Video signal input	
S-VIDEO	Mini DIN 4-pin port x 1
VIDEO	RCA jack x1
HDTV signal input	D-sub <--> YPbPr RCA jack x 3, through RGB IN-2
Audio signal input	
Audio 1	Mini jack stereo port

Output

USB mouse connector	A/B series x 1
Speaker	2 watt x 1

Control

RS-232C	9-pin x 1
---------	-----------

Timing Chart

Supported timing for PC input

Resolution	Horizontal Frequency (kHz)	Vertical Frequency (Hz)	Pixel Frequency (MHz)	Mode
720 x 400	37.927	85.039	35.500	720 x 400_85
640 x 480	31.469	59.940	25.175	VGA_60
	37.861	72.809	31.500	VGA_72
	37.500	75.000	31.500	VGA_75
	43.269	85.008	36.000	VGA_85
800 x 600	35.156	56.250	36.000	SVGA_56
	37.879	60.317	40.000	SVGA_60
	48.077	72.188	50.000	SVGA_72
	46.875	75.000	49.500	SVGA_75
832 x 624	53.674	85.061	56.250	SVGA_85
	49.725	74.550	57.283	MAC16 ⁹
1024 x 768	35.522	86.957	44.900	XGA_43i
	48.363	60.004	65.000	XGA_60
	56.476	70.069	75.000	XGA_70
	60.023	75.029	78.750	XGA_75
	68.667	84.997	94.500	XGA_85
	60.134	74.700	79.857	MAC19 ⁹
1152 x 864	67.500	75.000	108.000	SXGA1_75
1280 x 960	60.000	60.000	108.000	QuadVGA_60
1280 x 1024	63.981	60.020	108.000	SXGA3_60

Supported timing for YPbPr input

Signal Format	Horizontal Frequency (kHz)	Vertical Frequency (Hz)
480i(525i)@60Hz	15.73	59.94
480p(525p)@60Hz	31.47	59.94
576i(625i)@50Hz	15.63	50.00
576p(625p)@50Hz	31.25	50.00
720p(750p)@60Hz	45.00	60.00
720p(750p)@50Hz	37.50	50.00
1080i(1125i)@60Hz	33.75	60.00
1080i(1125i)@50Hz	28.13	50.00

Supported timing for Video and S-Video inputs

Video mode	Horizontal Frequency (kHz)	Vertical Frequency (Hz)	Pixel Frequency (MHz)
NTSC	15.73	60	3.58
PAL	15.63	50	4.43
SECAM	15.63	50	4.25 or 4.41
PAL-M	15.73	60	3.58
PAL-N	15.63	50	3.58
PAL-60	15.73	60	4.43
NTSC4.43	15.73	60	4.43

8 Dimensions

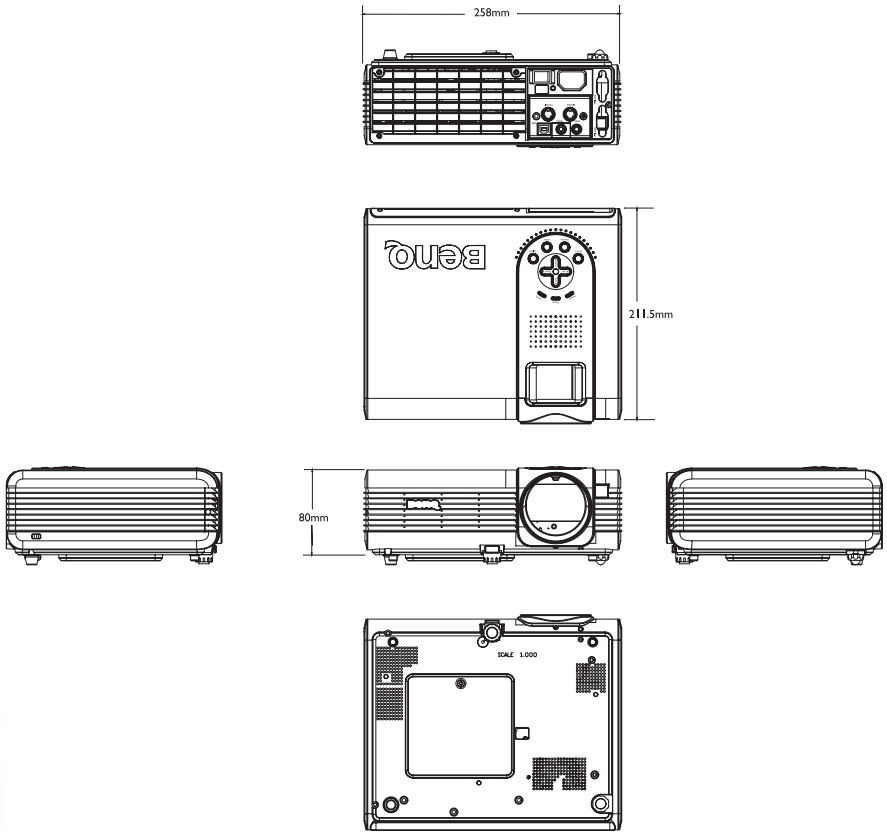

Unit: mm

Warranty

Limited Warranty

BenQ warrants this product against any defects in material and workmanship, under normal usage and storage.

Exclusion to Warranty: The lamps are considered as consumable items and are warranted for 90 days or 500 hours, whichever occurs first. Proof of purchase date will be required with any warranty claim. In the event this product is found to be defective within the warranty period, BenQ's only obligation and your exclusive remedy shall be replacement of any defective parts (labor included). To obtain warranty service, immediately notify the dealer from which you purchased the product of any defects.

Important: The above warranty shall be void if the customer fails to operate the product in accordance with BenQ's written instructions. This warranty gives you specific legal rights, and you may have other rights which vary from country to country. For other information, please refer to BenQ Warranty Information Book.

10 Safety Regulations

FCC Statement

CLASS A: This equipment generates, uses and can radiate radio frequency energy, and if not installed and used in accordance with the instruction manual, may cause interference to radio communications. It has been tested and found to comply with the limits for a Class “A” computing device pursuant to Subpart B of Part 15 of the FCC Rules, which are designed to provide reasonable protection against such interference when operated in a commercial environment. Operation of this equipment in a residential area is likely to cause interference, in which case the user at his/her own expense will be required to take whatever measures may be required to correct the interference.

CLASS B: This equipment generates, uses and can radiate radio frequency energy and, if not installed and used in accordance with the instructions, may cause harmful interference to radio communications. However, there is no guarantee that interference will not occur in a particular installation. If this equipment does cause harmful interference to radio or television reception, which can be determined by turning the equipment off and on, the user is encouraged to try to correct the interference by one or more of the following measures:

- Reorient or relocate the receiving antenna.
- Increase the distance between the equipment and receiver.
- Connect the equipment into an outlet on a circuit different from that to which the receiver is connected.
- Consult the dealer or an experienced radio/TV technician for help.

EEC Statement

This machine was tested against the 89/336/EEC (European Economic Community) for EMC (Electro Magnetic Compatibility) and fulfills these requirements.

MIC Statement

A class equipment (Business purpose info/telecommunications equipment)

As this equipment has undergone EMC registration for business purpose, the seller and/or the buyer is asked to beware of this point and in case a wrongful sale or purchase has been made, it is asked that a change to household use be made.

B class equipment (Household purpose info/telecommunications equipment)

As this equipment has undergone EMC registration for household purpose, this product can be used in any area including residential area.