

***myprojectorlamps.com***

**The most trusted, dependable name  
in projector lamp sales.**



<http://www.myprojectorlamps.com>



<http://www.myprojectorlamps.ca>



<http://www.myprojectorlamps.eu>

The following projector manual has not been modified or altered in any way.

**BenQ**

MP776/MP777

Digital Projector

User Manual

Welcome

# Table of contents

## Important safety

**instructions .....3**

**Introduction.....7**

Projector features ..... 7

Shipping contents..... 8

Projector exterior view ..... 9

Controls and functions ..... 10

**Positioning your projector 14**

Choosing a location..... 14

Obtaining a preferred projected image size ..... 15

**Connection ..... 18**

Connecting a computer or monitor... 19

Connecting video source devices..... 20

**Operation .....23**

Starting up the projector ..... 23

Adjusting the projected image..... 24

Using the menus..... 25

Securing the projector ..... 26

Switching input signal ..... 29

Magnifying and searching for details . 30

Selecting the aspect ratio ..... 30

Optimizing the image..... 32

Setting the presentation timer ..... 35

Freezing the image..... 37

Hiding the image ..... 37

Utilizing FAQ function ..... 37

Locking control keys ..... 38

Operating in a high altitude environment ..... 38

Adjusting the sound ..... 39

Personalizing the projector menu display .....39

Controlling the projector through a Lan environment.....40

Shutting down the projector .....43

Menu operation .....44

**Maintenance.....52**

Care of the projector.....52

Lamp information.....53

**Troubleshooting .....59**

**Specifications .....60**

Projector specifications.....60

Dimensions.....61

Ceiling mount installation.....61

Timing chart.....62

**Warranty and Copyright**

**information .....65**

**Regulation statements .....66**

# Important safety instructions

Your projector is designed and tested to meet the latest standards for safety of information technology equipment. However, to ensure safe use of this product, it is important that you follow the instructions mentioned in this manual and marked on the product.

## Safety Instructions

1. **Please read this manual before you operate your projector.** Save it for future reference.

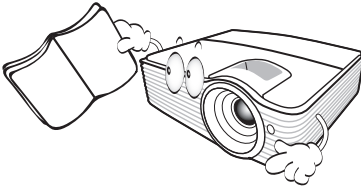

2. **Do not look straight at the projector lens during operation.** The intense light beam may damage your eyes.

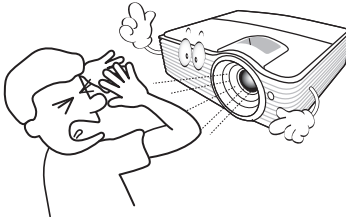

3. **Refer servicing to qualified service personnel.**

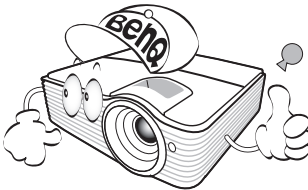

4. **Always open the lens shutter or remove the lens cap when the projector lamp is on.**

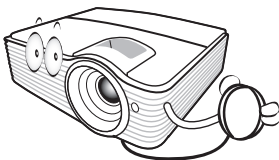

5. In some countries, the line voltage is NOT stable. This projector is designed to operate safely within a mains voltage between 100 to 240 volts AC, but could fail if power cuts or surges of  $\pm 10$  volts occur. **In areas where the mains voltage may fluctuate or cut out, it is recommended that you connect your projector through a power stabilizer, surge protector or uninterruptible power supply (UPS).**

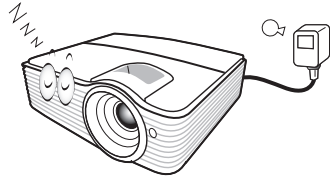

6. Do not block the projection lens with any objects when the projector is under operation as this could cause the objects to become heated and deformed or even cause a fire. To temporarily turn off the lamp, press **BLANK** on the projector or remote control.



## Safety Instructions (Continued)

7. The lamp becomes extremely hot during operation. Allow the projector to cool for approximately 45 minutes prior to removing the lamp assembly for replacement.

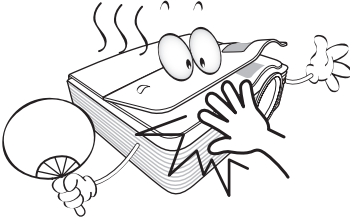

8. Do not operate lamps beyond the rated lamp life. Excessive operation of lamps beyond the rated life could cause them to break on rare occasions.

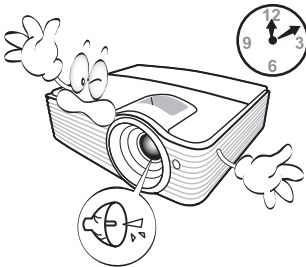

9. Never replace the lamp assembly or any electronic components unless the projector is unplugged.

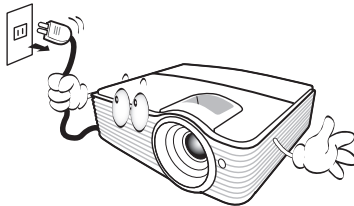

10. Do not place this product on an unstable cart, stand, or table. The product may fall, sustaining serious damage.

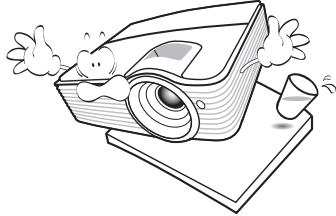

11. Do not attempt to disassemble this projector. There are dangerous high voltages inside which may cause death if you should come into contact with live parts. The only user serviceable part is the lamp which has its own removable cover.

Under no circumstances should you ever undo or remove any other covers. Refer servicing only to suitably qualified professional service personnel.

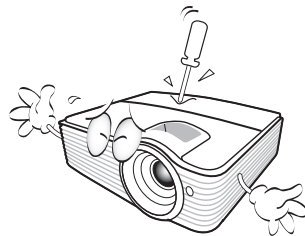

12. When the projector is under operation, you may sense some heated air and odor from its ventilation grill. It is a normal phenomenon and not a product defect.

## Safety Instructions (Continued)

13. Do not place this projector in any of the following environments.

- Space that is poorly ventilated or confined. Allow at least 50 cm clearance from walls and free flow of air around the projector.
- Locations where temperatures may become excessively high, such as the inside of a car with all windows rolled up.
- Locations where excessive humidity, dust, or cigarette smoke may contaminate optical components, shorten the projector's life span and darken the image.

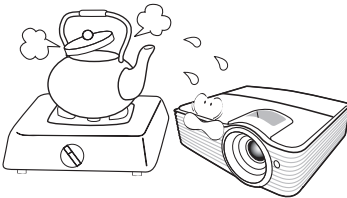

- Locations near fire alarms
- Locations with an ambient temperature above 40°C / 104°F
- Locations where the altitudes are higher than 3000 m (10000 feet).

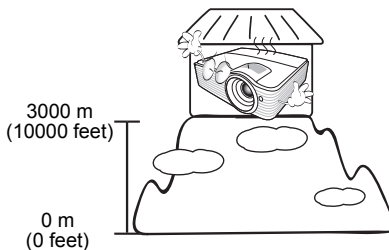

14. Do not block the ventilation holes.
- Do not place this projector on a blanket, bedding or any other soft surface.
  - Do not cover this projector with a cloth or any other item.
  - Do not place inflammables near the projector.

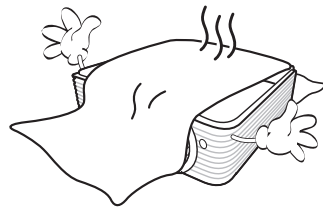

If the ventilation holes are seriously obstructed, overheating inside the projector may result in a fire.

15. Always place the projector on a level, horizontal surface during operation.
- Do not use if tilted at an angle of more than 10 degrees left to right, nor at angle of more than 15 degrees front to back. Using the projector when it is not fully horizontal may cause a malfunction of, or damage to, the lamp.

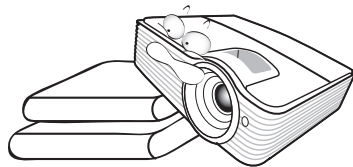

16. Do not stand the projector on end vertically. Doing so may cause the projector to fall over, causing injury or resulting in damage to the projector.

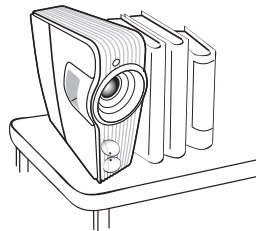

## Safety Instructions (Continued)

17. Do not step on the projector or place any objects upon it. Besides probable physical damage to the projector, doing so may result in accidents and possible injury.

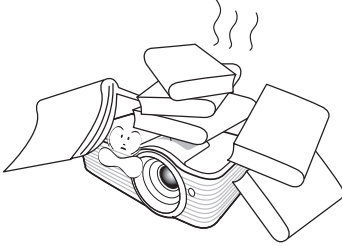

18. Do not place liquids near or on the projector. Liquids spilled into the projector may cause it to fail. If the projector does become wet, disconnect it from the power supply's power outlet and call BenQ to have the projector serviced.

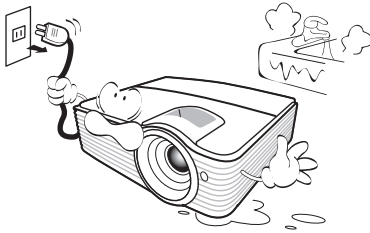

19. This product is capable of displaying inverted images for ceiling mount installation.



**Use only BenQ's Ceiling Mount Kit for mounting the projector and ensure it is securely installed.**

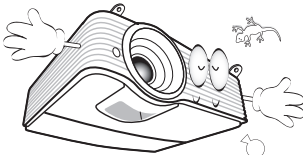

20. This apparatus must be earthed.



### **Ceiling mounting the projector**

We want you to have a pleasant experience using your BenQ projector, so we need to bring this safety matter to your attention to prevent possible damage to person and property.

If you intend to mount your projector on the ceiling, we strongly recommend that you use a proper fitting BenQ projector ceiling mount kit and that you ensure it is securely and safely installed.

If you use a non-BenQ brand projector ceiling mount kit, there is a safety risk that the projector may fall from the ceiling due to an improper attachment through the use of the wrong gauge or length screws.

You can purchase a BenQ projector ceiling mount kit from the place you purchased your BenQ projector. BenQ recommends that you also purchase a separate Kensington lock compatible security cable and attach it securely to both the Kensington lock slot on the projector and the base of the ceiling mount bracket. This will perform the secondary role of restraining the projector should its attachment to the mounting bracket become loose.



**Hg - Lamp contains mercury. Manage in accordance with local disposal laws. See [www.lamprecycle.org](http://www.lamprecycle.org).**

# Introduction

## Projector features

The projector integrates high-performance optical engine projection and a user-friendly design to deliver high reliability and ease of use.

The projector offers the following features.

- LAN Settings allowing management of projector status from a computer using a web browser
  - Filter free design to lower maintenance and operating costs
  - Auto keystone function to correct image keystone automatically
  - Brilliant color / VID1 to provide truer, more vibrant colors in picture
  - Closed captioning to display the dialogue, narration, and sound effects of TV programs and videos
  - Variable audio output
  - Wall color correction allowing projection on surfaces of several predefined colors
  - Quick auto search speeding up the signal detecting process
  - Selectable password protected function
  - 3D color management allowing color adjustments to your liking
  - Selectable quick cooling function making the projector cool in a shorter time
  - FAQ to troubleshoot operational problems with one quick key press
  - Presentation timer for better control of time during presentations
  - High quality manual zoom lens
  - One-key auto-adjustment to display the best picture quality
  - Digital keystone correction to correct distorted images
  - Adjustable color balance control for data/video display
  - Ability to display 16.7 million colors
  - Multi-language On-Screen Display (OSD) menus
  - Switchable normal and economic modes to reduce the power consumption
  - Built-in speakers providing mixed mono audio when an audio input is connected
  - Component HDTV compatibility (YPbPr)
-  • **The apparent brightness of the projected image will vary depending on the ambient lighting conditions, selected input signal contrast/brightness settings, and is directly proportional to projection distance.**
- **The lamp brightness will decline over time and may vary within the lamp manufacturers specifications. This is normal and expected behavior.**



# Shipping contents

Carefully unpack and verify that you have all of the items shown below. If any of these items are missing, please contact your place of purchase.

## Standard accessories

 The supplied accessories will be suitable for your region, and may differ from those illustrated.

\*The warranty card is only supplied in some specific regions. Please consult your dealer for detailed information.

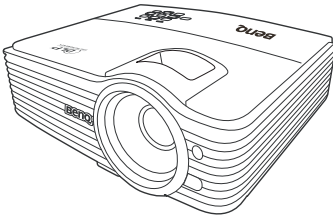

Projector

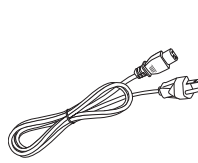

Power cord

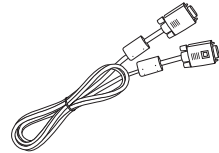

VGA cable



Quick start guide



User manual CD



Warranty card\*

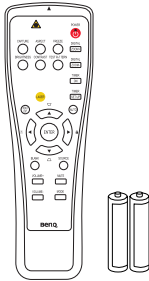

Remote control with batteries



Soft carry case

## Optional accessories

1. Spare lamp kit
2. Ceiling mount kit
3. RS232 cable

# Projector exterior view

## Front/upper side

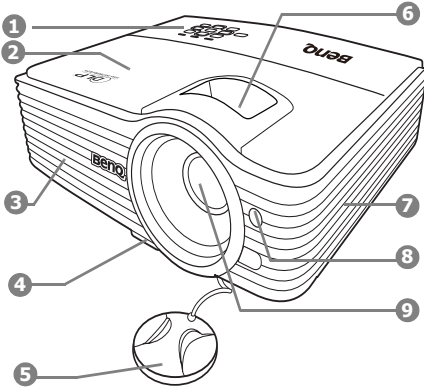

## Rear/lower side

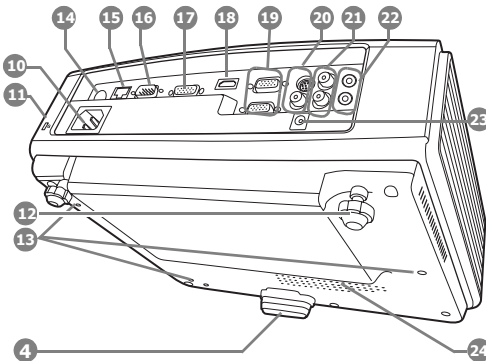

1. External control panel  
(See "[Controls and functions](#)" on [page 10](#) for details.)
2. Lamp cover
3. Vent (heated air exhaust)
4. Quick-release button
5. Lens cover
6. Focus ring and Zoom ring
7. Vent (cool air intake)
8. Front IR remote sensor
9. Projection lens
10. AC power jack
11. Kensington anti-theft lock slot
12. Rear adjuster foot
13. Ceiling mount holes
14. Rear IR remote sensor
15. RJ45 LAN input jack
16. RS232 control port
17. RGB signal output jack
18. HDMI-input port
19. RGB (PC)/Component Video (YPbPr/ YCbCr) signal input jack
20. S-Video input jack
21. Video input jack
22. Audio (L/R) input jacks
23. Audio input jack
24. Audio output jack
25. 12V DC output terminal  
Used to trigger external devices such as an electric screen or light control, etc. Consult your dealer for how to connect these devices.
26. Speaker grill

# Controls and functions

## Projector

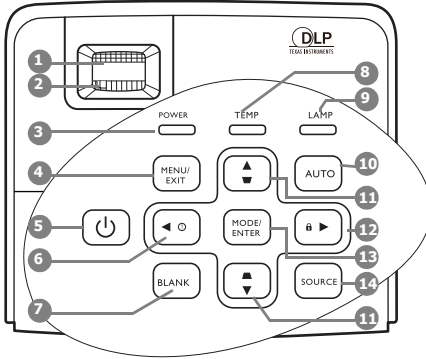

For details, see the info provided behind the hand sign .

- 1. Focus ring**

Adjusts the focus of the projected image.  ["Auto-adjusting the image" on page 24](#)

 ["Fine-tuning the image size and clarity" on page 24](#)
- 2. Zoom ring**

Adjusts the size of the image.

 ["Fine-tuning the image size and clarity" on page 24](#)
- 3. POWER indicator light**

Lights up or flashes when the projector is under operation.

 ["Indicators" on page 58](#)
- 4. MENU/EXIT**

Turns on the On-Screen Display (OSD) menu. Goes back to previous OSD menu, exits and saves menu settings.

 ["Using the menus" on page 25](#)
- 5. Power**

Toggles the projector between standby mode and on.

 ["Starting up the projector" on page 23,](#)  
["Shutting down the projector" on page 43](#)
- 6. Left/ ?**

Starts the FAQ function.

 ["Utilizing FAQ function" on page 37](#)
- 7. BLANK**

Used to hide the screen picture.

 ["Hiding the image" on page 37](#)
- 8. TEMPerature warning light**

Lights up red if the projector's temperature becomes too high.
- 9. LAMP indicator light**

Indicates the status of the lamp. Lights up or flashes when the lamp has developed a problem.

 ["Indicators" on page 58](#)
- 10. AUTO**

Automatically determines the best picture timings for the displayed image.

 ["Auto-adjusting the image" on page 24](#)
- 11. Keystone/Arrow keys ( □ / ▲ Up, △ / ▼ Down)**

Manually corrects distorted images resulting from an angled projection.

 ["Correcting keystone" on page 28](#)
- 12. Right/ Lock**

Activates panel key lock.

When the On-Screen Display (OSD) menu is activated, the #6, #11, and #12 keys are used as directional arrows to select the desired menu items and to make adjustments.

 ["Locking control keys" on page 38,](#)  
["Using the menus" on page 25](#)
- 13. MODE/ENTER**

Selects an available picture setup mode.

Activates the selected On-Screen Display (OSD) menu item.

 ["Selecting a picture mode" on page 32](#)
- 14. SOURCE**

Displays the source selection bar.

 ["Switching input signal" on page 29](#)

# Remote control

For details, see the info. provided behind the hand sign .

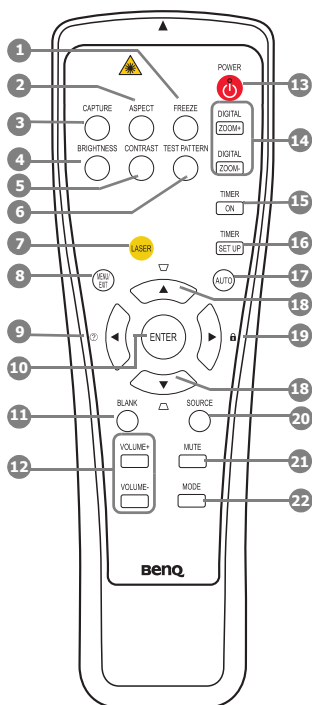

## 1. FREEZE

Freezes the projected image.

 ["Freezing the image" on page 37](#)

## 2. ASPECT

Selects the display aspect ratio.

 ["Selecting the aspect ratio" on page 30](#)

## 3. CAPTURE (This function is not available with the MP7 series models)

## 4. BRIGHTNESS

Adjusts brightness.

 ["Adjusting Brightness" on page 33](#)

## 5. CONTRAST

Adjusts contrast.

 ["Adjusting Contrast" on page 33](#)

## 6. TEST PATTERN

Displays the test pattern.

 ["Test Pattern" on page 50](#)

## 7. LASER

Emits visible laser pointer light for presentation purposes.

 ["Operating the LASER pointer" on page 12](#)

## 8. MENU/EXIT

Turns on the On-Screen Display (OSD) menu. Goes back to previous OSD menu, exits and saves menu settings.

 ["Using the menus" on page 25](#)

## 9. ◀ Left/ ?

Starts the FAQ function.

 ["Utilizing FAQ function" on page 37](#)

## 10. ENTER

Activates the selected On-Screen Display (OSD) menu item.

## 11. BLANK

Used to hide the screen image.

 ["Hiding the image" on page 37](#)

## 12. VOLUME+/VOLUME-

Adjusts the sound level.

 ["Adjusting the sound" on page 39](#)

## 13. ⏻ POWER

Toggles the projector between standby mode and on.

 ["Starting up the projector" on page 23,](#)  
["Shutting down the projector" on page 43](#)

## 14. DIGITAL ZOOM+/DIGITAL ZOOM-

Magnifies or reduces the projected image size.

 ["Magnifying and searching for details" on page 30](#)

## 15. TIMER ON

Activates or displays an on-screen timer based on your own timer setting.

 ["Setting the presentation timer" on page 35](#)

## 16. TIMER SET UP

Enters presentation timer setting directly.

 ["Setting the presentation timer" on page 35](#)

## 17. AUTO

Automatically determines the best picture timings for the displayed image.

 ["Auto-adjusting the image" on page 24](#)

## 18. Keystone/Arrow buttons ( ◻ / ▲ Up, ◻ / ▼ Down)

Manually corrects distorted images resulting from an angled projection.

 ["Correcting keystone" on page 28](#)

## 19. ► Right/🔒

Locks the buttons on the projector.

 ["Locking control keys" on page 38](#)

When the On-Screen Display (OSD) menu is activated, the #18, #9 and #19 buttons are used as directional arrows to select the desired menu items and to make adjustments.

 ["Using the menus" on page 25](#)

## 20. SOURCE

Displays the source selection bar.

 ["Switching input signal" on page 29](#)

## 21. MUTE

Toggles projector audio between on and off.

 ["Muting the sound" on page 39](#)

## 22. MODE

Depending upon the input signal in use, selects an available picture mode.

 ["Selecting a picture mode" on page 32](#)

## Operating the LASER pointer

The Laser Pointer is a presentation aid for professionals. It emits red colored light when you press it and the indicator lights up red.

The laser beam is visible. It is necessary to press and hold **LASER** for continuous output.



**Do not look into the laser light window or shine the laser light beam on yourself or others. See the warning messages on the back of the remote control prior to using it.**

The laser pointer is not a toy. Parents should be mindful of the dangers of laser energy and keep this remote control out of the reach of children.

## Remote control effective range

Infra-Red (IR) remote control sensors are located on the front and the back of the projector. The remote control must be held at an angle within 30 degrees perpendicular to the projector's IR remote control sensors to function correctly. The distance between the remote control and the sensors should not exceed 8 meters (~ 26 feet).

Make sure that there are no obstacles between the remote control and the IR sensors on the projector that might obstruct the infra-red beam.

- **Operating the projector from the front**
- **Operating the projector from the rear**

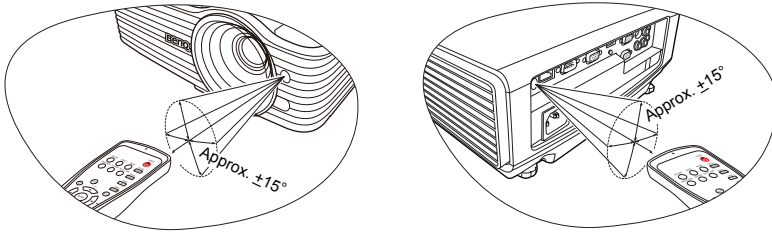

## Replacing the remote control batteries

1. To open the battery cover, turn the remote control over to view its back, push on the finger grip on the cover and slide it in the direction of the arrow as illustrated. The cover will slide off.
2. Remove any existing batteries (if necessary) and install two AAA batteries observing the battery polarities as indicated in the base of the battery compartment. Positive (+) goes to positive and negative (-) goes to negative.
3. Refit the cover by aligning it with the base and sliding it back down into position. Stop when it clicks into place.

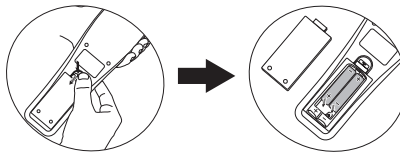

- ! • **Avoid leaving the remote control and batteries in an excessive heat or humid environment like the kitchen, bathroom, sauna, sunroom or in a closed car.**
- **Replace only with the same or equivalent type recommended by the battery manufacturer.**
- **Dispose of the used batteries according to the manufacturer's instructions and local environment regulations for your region.**
- **Never throw the batteries into a fire. There may be danger of an explosion.**
- **If the batteries are dead or if you will not be using the remote control for an extended period of time, remove the batteries to avoid damage to the remote control from possible battery leakage.**

# Positioning your projector

## Choosing a location

Your projector is designed to be installed in one of four possible installation locations:

### 1. Front Table

Select this location with the projector placed on the table in front of the screen. This is the most common way to position the projector for quick setup and portability.

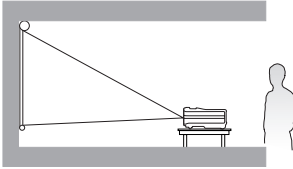

### 2. Front Ceiling

Select this location with the projector suspended upside-down from the ceiling in front of the screen.

Purchase the BenQ Projector Ceiling Mount Kit from your dealer to mount your projector on the ceiling.

Set **Front Ceiling** in the **SYSTEM SETUP: Basic > Projector Position** menu after you turn the projector on.

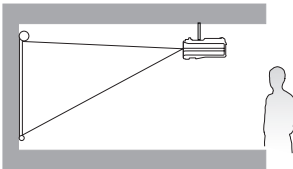

### 3. Rear Ceiling

Select this location with the projector suspended upside-down from the ceiling behind the screen.

Note that a special rear projection screen and the BenQ Projector Ceiling Mount Kit are required for this installation location.

Set **Rear Ceiling** in the **SYSTEM SETUP: Basic > Projector Position** menu after you turn the projector on.

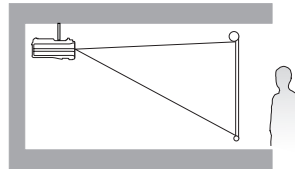

### 4. Rear Table

Select this location with the projector placed on the table behind the screen.

Note that a special rear projection screen is required.

Set **Rear Table** in the **SYSTEM SETUP: Basic > Projector Position** menu after you turn the projector on.

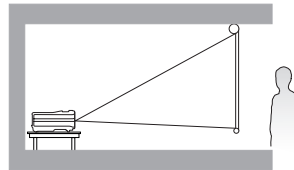

Your room layout or personal preference will dictate which installation location you select. Take into consideration the size and position of your screen, the location of a suitable power outlet, as well as the location and distance between the projector and the rest of your equipment.

# Obtaining a preferred projected image size

The distance from the projector lens to the screen, the zoom setting, and the video format each factors in the projected image size.

4:3 is the native aspect ratio of this projector. To be able to project a complete 16:9 (widescreen) aspect ratio image, the projector can resize and scale a widescreen image to the projector's native aspect width. This will result in a proportionally smaller height equivalent to 75% of the projector's native aspect height.

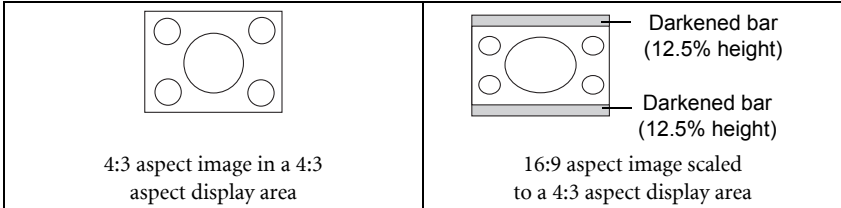

The projector should always be placed horizontally level (like flat on a table), and positioned directly perpendicular (90° right-angle square) to the horizontal center of the screen. This prevents image distortion caused by angled projections (or projecting onto angled surfaces).

If the projector is mounted on a ceiling, it must be mounted upside-down so that it projects at a slightly downward angle.

You can see from the diagrams on page 17, that this type of projection causes the bottom edge of the projected image to be vertically offset from the horizontal plane of the projector. When ceiling mounted, this refers to the top edge of the projected image.

If the projector is positioned further away from the screen, the projected image size increases, and the vertical offset also increases proportionately.

When determining the position of the screen and projector, you will need to account for both the projected image size and the vertical offset dimension, which are directly proportional to the projection distance.

BenQ has provided a table of 4:3-aspect-ratio screen sizes to assist you in determining the ideal location for your projector. There are two dimensions to consider, the perpendicular horizontal distance from the center of the screen (projection distance), and the vertical offset height of the projector from the horizontal edge of the screen (offset).

## How to determine the position of the projector for a given screen size

1. Select your screen size.
2. Refer to the table on page 17 and find the closest match to your screen size in the left columns labelled "Screen size". Using this value, look across this row to the right to find the corresponding average distance from screen value in the column labelled "Distance from screen (mm)". This is the projection distance.
3. On that same row, look across to the right column and make note of the "Vertical offset (mm)" value. This will determine the final vertical offset placement of the projector in relation to the edge of the screen.
4. The recommended position for the projector is aligned perpendicular to the horizontal center of the screen, at the distance from the screen determined in step 2 above, and offset by the value determined in step 3 above.



For example, if you are using an 120-inch screen, the recommended projection distance is 4246 mm and the vertical offset is 137 mm.

## How to determine the recommended screen size for a given distance

This method can be used for situations where you have purchased this projector and would like to know what screen size will fit in your room.

The maximum screen size is limited by the physical space available in your room.

1. Measure the distance between the projector and where you want to position the screen. This is the projection distance.
2. Refer to the table on page 17 and find the closest match to your measurement in the average distance from screen column labelled "[Distance from screen \(mm\)](#)". This is the projection distance.
3. Using this value, look across that row to the left to find the corresponding "[Screen size](#)" listed in that row. That is the projected image size of the projector at that projection distance.
4. On that same row, look across to the right column and make note of the "[Vertical offset \(mm\)](#)" value. This will determine the final placement of the screen in relation to the horizontal plane of the projector.

For example, if your measured projection distance is 4.5 m (4500 mm), the closest match in the "[Distance from screen \(mm\)](#)" column is 4246 mm. Looking across this row shows that a 120" (about 3.0 m) screen is required.

If you place the projector in a different position (to that recommended), you will have to tilt it down or up to center the image on the screen. In these situations, some image distortion will occur. Use the Keystone function to correct the distortion. See "[Correcting keystone](#)" on page 28 for details.

# Projection dimensions

Refer to "Dimensions" on page 61 for the center of lens dimensions of this projector before calculating the appropriate position.

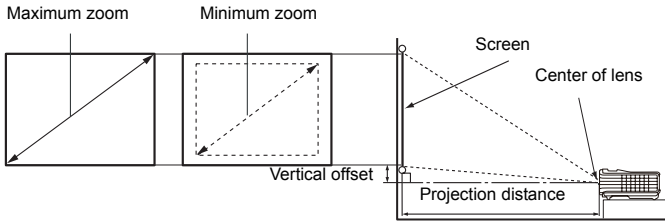

Screen size				Distance from screen (mm)			Vertical offset (mm)
Diagonal		W (mm)	H (mm)	Min length	Average	Max length	
Inch	mm			(max. zoom)		(min. zoom)	
30	762	610	457	923	1062	1200	34
40	1016	813	610	1231	1415	1600	46
50	1270	1016	762	1538	1769	2000	57
60	1524	1219	914	1846	2123	2400	69
80	2032	1626	1219	2462	2831	3200	91
100	2540	2032	1524	3077	3538	4000	114
120	3048	2438	1829	3692	4246	4800	137
150	3810	3048	2286	4615	5308	6000	171
200	5080	4064	3048	6154	7077	8000	229
220	5588	4470	3353	6769	7785	8800	251
250	6350	5080	3810	7692	8846	10000	286
300	7620	6096	4572	9231	10615	12000	343

There is 3% tolerance among these numbers due to optical component variations. BenQ recommends that if you intend to permanently install the projector, you should physically test the projection size and distance using the actual projector in situ before you permanently install it, so as to make allowance for this projector's optical characteristics. This will help you determine the exact mounting position so that it best suits your installation location.

# Connection

When connecting a signal source to the projector, be sure to:

1. Turn all equipment off before making any connections.
2. Use the correct signal cables for each source.
3. Ensure the cables are firmly inserted.

- ☞ In the connections shown below, some cables may not be included with the projector (see **"Shipping contents" on page 8**). They are commercially available from electronics stores.
- For detailed connection methods, see pages **19-22**.

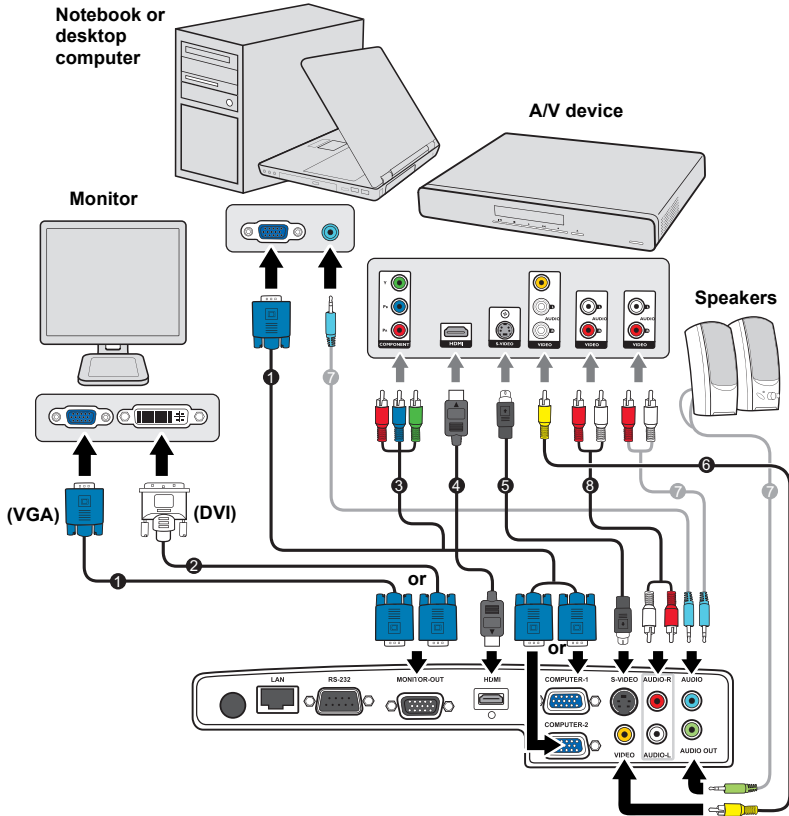

1. VGA cable	5. S-Video cable
2. VGA to DVI-A cable	6. Video cable
3. Component Video to VGA (D-Sub) adapter cable	7. Audio cable
4. HDMI cable	8. Audio L/R cable

# Connecting a computer or monitor

## Connecting a computer

The projector can connect to both IBM® compatibles and Macintosh® computers. A Mac adapter (an optional accessory) is needed if you are connecting legacy version Macintosh computers.

### To connect the projector to a notebook or desktop computer:

1. Take the supplied VGA cable and connect one end to the D-Sub output jack of the computer.
2. Connect the other end of the VGA cable to the **COMPUTER 1** or **COMPUTER 2** signal input jack on the projector.
3. If you wish to make use of the projector (mixed mono) speakers in your presentations, take a suitable audio cable and connect one end of the cable to the audio output jack of the computer, and the other end to the **AUDIO** or **AUDIO (L/R)** jack of the projector.
4. If you wish and the **AUDIO OUT** jack is available on your projector, you can use another suitable audio cable and connect one end of the cable to the **AUDIO OUT** jack of the projector, and the other end to your external speakers (not supplied).

Once connected, the audio can be controlled by the projector On-Screen Display (OSD) menus. See "[Audio Settings](#)" on [page 49](#) for details.

 **Many notebooks do not turn on their external video ports when connected to a projector. Usually a key combo like FN + F3 or CRT/LCD key turns the external display on/off. Locate a function key labeled CRT/LCD or a function key with a monitor symbol on the notebook. Press FN and the labeled function key simultaneously. Refer to your notebook's documentation to find your notebook's key combination.**

## Connecting a monitor

If you want to view your presentation close-up on a monitor as well as on the screen and the **MONITOR OUT** jack is available on your projector, you can connect the **MONITOR OUT** signal output jack on the projector to an external monitor following the instructions below:

### To connect the projector to a monitor:









1. Connect the projector to a computer as described in "[Connecting a computer](#)" on [page 19](#).
2. Take a suitable VGA cable (only one supplied) and connect one end of the cable to the D-Sub input jack of the video monitor.  
Or if your monitor is equipped with a DVI input jack, take a VGA to DVI-A cable and connect the DVI end of the cable to the DVI input jack of the video monitor.
3. Connect the other end of the cable to the **MONITOR OUT** jack on the projector.

 **The D-Sub output only works when an appropriate D-Sub input is made to the **COMPUTER 1** jack.**

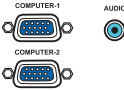
- **If you wish to use this connection method when the projector is in standby mode, make sure the Standby Monitor Out function is turned on in the SYSTEM SETUP: Advanced menu. See "[Standby Monitor Out](#)" on [page 50](#) for details.**

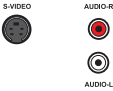
# Connecting video source devices

You need only connect the projector to a video source device using just one of the connecting methods, however each provides a different level of video quality. The method you choose will most likely depend upon the availability of matching terminals on both the projector and the video source device as described below:

Terminal name	Terminal appearance	Reference	Picture quality
<b>HDMI</b>		"Connecting an HDMI device" on page 21	 Best
<b>Component Video</b>		"Connecting a Component Video source device" on page 21	 Better
<b>S-Video</b>		"Connecting an S-Video/ Composite Video source device" on page 22	 Good
<b>Video</b>			 Normal

## Connecting audio

The projector has two built-in mono speakers which are designed to provide basic audio functionality accompanying data presentations for business purposes only. They are not designed for, nor intended for stereo audio reproduction use as might be expected in home theater or home cinema applications. Any stereo audio input (if provided), is mixed into a common mono audio output through the projector speakers.

If you have a separate sound system, you will most likely want to connect the audio output of your video source device to that sound system, instead of to the mono audio projector. The audio connections illustrated on page 18 are provided for informational purposes only. You need not connect audio to the projector if there is an alternate sound system available, or if audio is not required.

## Connecting an HDMI device

You should use an HDMI cable when making connection between the projector and HDMI devices.

### To connect the projector to an HDMI device:

1. Take an HDMI cable and connect one end to the HDMI-output port of the video device.
2. Connect the other end of the cable to the **HDMI**-input port on the projector.



- **In the unlikely event that you connect the projector to a DVD player via the projector's HDMI input and the projected picture displays wrong colors, please change the color space to YUV. See "Changing Color Space" on page 29 for details.**
- **The projector is only capable of playing mixed mono audio, even if a stereo audio input is connected. See "Connecting audio" on page 20 for details.**

## Connecting a Component Video source device

Examine your video source device to determine if it has a set of unused Component Video output jacks available:

- If so, you can continue with this procedure.
- If not, you will need to reassess which method you can use to connect to the device.

### To connect the projector to a Component Video source device:

1. Take a Component Video to VGA (D-Sub) adapter cable or Component Video cable and connect the end with 3 RCA type connectors to the Component Video output jacks of the video source device. Match the color of the plugs to the color of the jacks; green to green, blue to blue, and red to red.
2. Connect the other end of the Component Video to VGA (D-Sub) adapter cable (with a D-Sub type connector) to the **COMPUTER 1**, or **COMPUTER 2** jack on the projector.
3. If you wish to make use of the projector (mixed mono) speakers in your presentations, take a suitable audio cable and connect one end of the cable to the audio output jack of the device, and the other end to the **AUDIO** or **AUDIO (L/R)** jack of the projector.
4. If you wish and the **AUDIO OUT** jack is available on your projector, you can use another suitable audio cable and connect one end of the cable to the **AUDIO OUT** jack of the projector, and the other end to your external speakers (not supplied).

Once connected, the audio can be controlled by the projector On-Screen Display (OSD) menus. See "Audio Settings" on page 49 for details.



- **The projector is only capable of playing mixed mono audio, even if a stereo audio input is connected. See "Connecting audio" on page 20 for details.**
- **If the selected video image is not displayed after the projector is turned on and the correct video source has been selected, check that the video source device is turned on and operating correctly. Also check that the signal cables have been connected correctly.**

## Connecting an S-Video/Composite Video source device

Examine your video source device to determine if it has an unused S-Video/Video output jack available:

- If it has both jacks, use the S-Video output jack for connection as the S-Video terminal provides better picture quality than the Video terminal.
- If it has either of the output jacks, you can also continue with this procedure.
- If not, you will need to reassess which method you can use to connect to the device.

### To connect the projector to an S-Video/Video source device:

1. Take an S-Video/Video cable and connect one end to the S-Video/Video output jack of the Video source device.
2. Connect the other end of the S-Video/Video cable to the **S-VIDEO/VIDEO** jack on the projector.
3. If you wish to make use of the projector (mixed mono) speakers in your presentations, take a suitable audio cable and connect one end of the cable to the audio output jack of the device, and the other end to the **AUDIO** or **AUDIO (L/R)** jack of the projector.
4. If you wish and the **AUDIO OUT** jack is available on your projector, you can use another suitable audio cable and connect one end of the cable to the **AUDIO OUT** jack of the projector, and the other end to your external speakers (not supplied).

Once connected, the audio can be controlled by the projector On-Screen Display (OSD) menus. See "[Audio Settings](#)" on [page 49](#) for details.



- **The projector is only capable of playing mixed mono audio, even if a stereo audio input is connected. See "[Connecting audio](#)" on [page 20](#) for details.**
- **If the selected video image is not displayed after the projector is turned on and the correct video source has been selected, check that the video source device is turned on and operating correctly. Also check that the signal cables have been connected correctly.**

# Operation

## Starting up the projector

1. Plug the power cord into the projector and into a power outlet. Turn on the power outlet switch (where fitted). Check that the **POWER indicator light** on the projector lights orange after power has been applied.
2. Open the lens cover. If it is closed, it could become deformed due to the heat produced by the projection lamp.

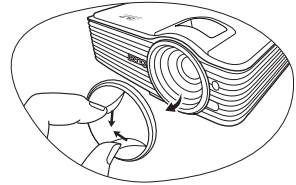
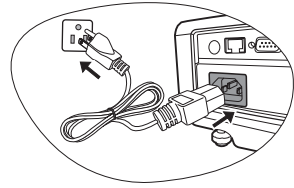

3. Press **Power** on the projector or remote control to start the projector. As soon as the lamp lights up, a "Power On Tone" will be heard. The **POWER indicator light** flashes green and stays green when the projector is on.

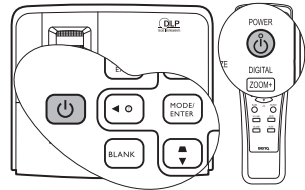

The start up procedure takes about 30 seconds. In the later stage of start up, a startup logo is projected.

(If necessary) Rotate the focus ring to adjust the image clearness.

To turn of the ring tone, see ["Turning off the Power on/off ring tone" on page 39](#) for details.

4. If the projector is activated for the first time, select your OSD language following the on-screen instructions.
5. If you are prompted for a password, press the arrow keys to enter a six-digit password. See ["Utilizing the password function" on page 26](#) for details.
6. Switch all of the connected equipment on.
7. The projector will start to search for input signals. The current input signal being scanned displays in the upper left corner of the screen. If the projector doesn't detect a valid signal, the message "No Signal" will continue displaying until an input signal is found.

You can also press **SOURCE** on the projector or remote control to select your desired input signal. See ["Switching input signal" on page 29](#) for details.

**If the frequency/resolution of the input signal exceeds the projector's operating range, you will see the message "Out of Range" displayed on a blank screen. Please change to an input**

**If the projector is still hot from previous activity, it will run the cooling fan for approximately 90 seconds before energizing the lamp.**

Please select language		
English	한국어	Hrvatski
Français	Svenska	Română
Deutsch	Nederlands	Norsk
Italiano	Türkçe	Dansk
Español	Čestina	Български
Русский	Português	suomi
繁體中文	ไทย	
简体中文	Polski	
日本語	Magyar	

Press Enter to Confirm, Exit to leave



signal which is compatible with the projector's resolution or set the input signal to a lower setting. See "Timing chart" on page 62 for details.

## Adjusting the projected image

### Adjusting the projection angle

The projector is equipped with 1 quick-release adjuster foot and 1 rear adjuster foot. These adjusters change the image height and projection angle. To adjust the projector:

1. Press the quick-release button and lift the front of the projector. Once the image is positioned where you want it, release the quick-release button to lock the foot in position.
2. Screw the rear adjuster foot to fine-tune the horizontal angle.

To retract the foot, hold up the projector while pressing the quick-release button, then slowly lower the projector. Screw the rear adjuster foot in a reverse direction.

If the projector is not placed on a flat surface or the screen and the projector are not perpendicular to each other, the projected image becomes trapezoidal. To correct this situation, see "Correcting keystone" on page 28 for details.

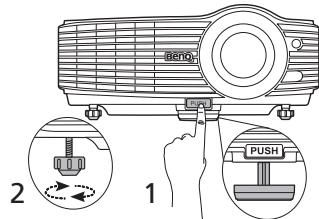

**!** Do not look into the lens while the lamp is on. The strong light from the lamp may cause damage to your eyes.

Be careful when you press the quick-release button as it is close to the exhaust vent where hot air comes from.

### Auto-adjusting the image

In some cases, you may need to optimize the picture quality. To do this, press **AUTO** on the projector or remote control. Within 3 seconds, the built-in Intelligent Auto Adjustment function will re-adjust the values of Frequency and Clock to provide the best picture quality.

The current source information will be displayed in the corner of the screen for 3 seconds.

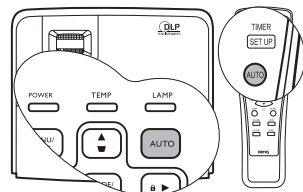

- The screen will be blank while AUTO is functioning.
- This function is only available when a PC signal (analog RGB) is selected.

### Fine-tuning the image size and clarity

1. Adjust the projected image to the size that you need using the zoom ring.
2. Sharpen the image by rotating the focus ring.

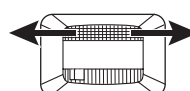
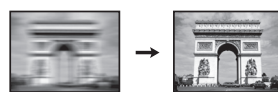
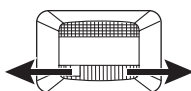

# Using the menus

The projector is equipped with On-Screen Display (OSD) menus for making various adjustments and settings.

Below is the overview of the OSD menu.



The following example describes how to set the OSD language.

1. Press **MENU/EXIT** on the projector or remote control to turn the OSD menu on.



3. Press **▼** to highlight **Language** and press **◀/▶** to select a preferred language.



2. Use **◀/▶** to highlight the **SYSTEM SETUP: Basic** menu.



4. Press **MENU/EXIT** twice\* on the projector or remote control to leave and save the settings.

\*The first press leads you back to the main menu and the second press closes the OSD menu.

# Securing the projector

## Using a security cable lock

The projector has to be installed in a safe place to prevent theft. Otherwise, purchase a lock, such as the Kensington lock, to secure the projector. You can locate a Kensington lock slot on the rear side of the projector. See item 11 on page 9 for details.

A Kensington security cable lock is usually a combination of key(s) and the lock. Refer to the lock's documentation for finding out how to use it.

## Utilizing the password function

For security purposes and to help prevent unauthorized use, the projector includes an option for setting up password security. The password can be set through the On-Screen Display (OSD) menu.

**WARNING:** You will be inconvenienced if you activate the password functionality and subsequently forget the password. Print out this manual (if necessary) and write the password you used in this manual, and keep the manual in a safe place for later recall.

### Setting a password

Once a password has been set and the power on lock is activated, the projector cannot be used unless the correct password is entered every time the projector is started.

1. Open the OSD menu and go to the **SYSTEM SETUP: Advanced > Security Settings** menu. Press **MODE/ENTER**. The **Security Settings** page displays.
2. Highlight **Power On Lock** and select press **On** by pressing **◀/▶**.
3. As pictured to the right, the four arrow keys (**▲**, **▶**, **▼**, **◀**) respectively represent 4 digits (1, 2, 3, 4). According to the password you desire to set, press the arrow keys to enter six digits for the password.
4. Confirm the new password by re-entering the new password.

Once the password is set, the OSD menu returns to the **Security Settings** page.

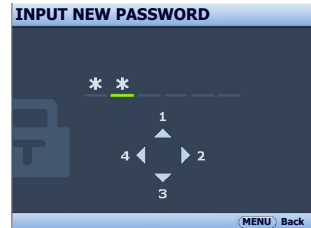

**IMPORTANT:** The digits being input will display as asterisks on-screen. Write your selected password down here in this manual in advance or right after the password is entered so that it is available to you should you ever forget it.

Password: \_ \_ \_ \_ \_

Keep this manual in a safe place.

5. To leave the OSD menu, press **MENU/EXIT**.

## If you forget the password

If the password function is activated, you will be asked to enter the six-digit password every time you turn on the projector. If you enter the wrong password, the password error message as pictured to the right displays lasting for 3 seconds, and the **INPUT PASSWORD** message follows. You can retry by entering another six-digit password, or if you did not record the password in this manual, and you absolutely do not remember it, you can use the password recall procedure. See "[Entering the password recall procedure](#)" on page 27 for details.

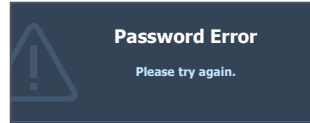

If you enter an incorrect password 5 times in succession, the projector will automatically shut down in a short time.

## Entering the password recall procedure

1. Press and hold **AUTO** on the projector or remote control for 3 seconds. The projector will display a coded number on the screen.
2. Write down the number and turn off your projector.
3. Seek help from the local BenQ service center to decode the number. You may be required to provide proof of purchase documentation to verify that you are an authorized user of the projector.

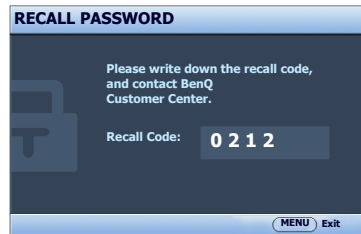

## Changing the password

1. Open the OSD menu and go to the **SYSTEM SETUP: Advanced > Security Settings > Change Password** menu.
2. Press **MODE/ENTER**. The message "**INPUT CURRENT PASSWORD**" displays.
3. Enter the old password.
  - i. If the password is correct, another message "**INPUT NEW PASSWORD**" displays.
  - ii. If the password is incorrect, the password error message displays lasting for three seconds, and the message "**INPUT CURRENT PASSWORD**" displays for your retry. You can press **MENU/EXIT** to cancel the change or try another password.
4. Enter a new password.

 **IMPORTANT:** The digits being input will display as asterisks on-screen. Write your selected password down here in this manual in advance or right after the password is entered so that it is available to you should you ever forget it.

**Password:** \_ \_ \_ \_ \_

**Keep this manual in a safe place.**

5. Confirm the new password by re-entering the new password.
6. You have successfully assigned a new password to the projector. Remember to enter the new password next time the projector is started.
7. To leave the OSD menu, press **MENU/EXIT**.

## Disabling the password function

To disable password protection, go back to the **SYSTEM SETUP: Advanced > Security Settings > Power On Lock** menu after opening the OSD menu system. Press **MODE/ENTER**. The message “**INPUT PASSWORD**” displays. Enter the current password.

- i. If the password is correct, the OSD menu returns to the **Security Settings** page. Press **▼** to highlight **Power On Lock** and press **◀/▶** to select **Off**. You will not have to enter the password next time when turning on the projector.
- ii. If the password is incorrect, the password error message displays lasting for three seconds, and the message “**INPUT PASSWORD**” displays for your retry. You can press **MENU/EXIT** to cancel the change or try another password.

 **Though the password function is disabled, you need to keep the old password in hand should you ever need to re-activate the password function by entering the old password.**

## Correcting keystone

Keystoning refers to the situation where the projected image is noticeably wider at either the top or bottom. It occurs when the projector is not perpendicular to the screen.

To correct this, besides adjusting the height of the projector, if you want the projector to automatically correct image keystone, be sure the **Auto Keystone** function in the **DISPLAY** menu is **On**.

Or you will need to manually correct it following ONE of these steps.

- Using the remote control

Press **△** / **▽** on the projector or remote control to display the Keystone correction page. Press **△** to correct keystone at the top of the image. Press **▽** to correct keystone at the bottom of the image.

- Using the OSD menu

1. Press **MENU/EXIT** and then press **◀/▶** until the **DISPLAY** menu is highlighted.
2. Press **▼** to highlight **Keystone** and press **MODE/ENTER**. The **Keystone** correction page displays.
3. Press **△** to correct keystone at the top of the image. Press **▽** to correct keystone at the bottom of the image.

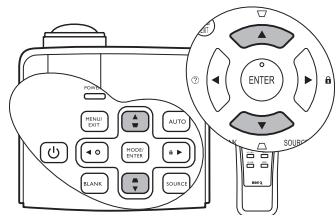

Press **△** / **▼**.

Press **▽** / **▲**.

# Switching input signal

The projector can be connected to multiple devices at the same time. However, it can only display one full screen at a time. When starting up, the projector automatically search for the available signals.

Be sure the **Quick Auto Search** function in the **SOURCE** menu is **On** (which is the default of this projector) if you want the projector to automatically search for the signals.

You can also manually cycle through the available input signals.

1. Press **SOURCE** on the projector or remote control. A source selection bar displays.
2. Press **▲** / **▼** until your desired signal is selected and press **MODE/ENTER**.

Once detected, the selected source information will display at the corner of the screen for seconds. If there is multiple equipment connected to the projector, repeat steps 1-2 to search for another signal.

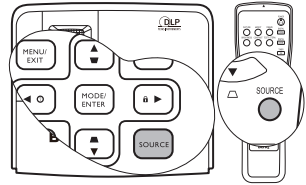

- **The brightness level of the projected image will change accordingly when you switch between different input signals. Data (graphic) "PC" presentations using mostly static images are generally brighter than "Video" using mostly moving images (movies).**
- **The native display resolution of this projector is in a 4:3 aspect ratio. For best display picture results, you should select and use an input signal which outputs at this resolution. Any other resolutions will be scaled by the projector depending upon the "aspect ratio" setting, which may cause some image distortion or loss of picture clarity. See ["Selecting the aspect ratio"](#) on page 30 for details.**



## Changing Color Space

In the unlikely event that you connect the projector to a DVD player via the projector's **HDMI** input and the projected picture displays wrong colors, please change the color space to **YUV**.

To do this:

1. Press **MENU/EXIT** and then press **◀/▶** until the **SOURCE** menu is highlighted.
2. Press **▼** to highlight **Color Space Conversion** and press **◀/▶** to select a suitable color space.

**This function is only available when the HDMI-input port is in use.**

# Magnifying and searching for details

If you need to find the details on the projected picture, magnify the picture. Use the direction arrow keys for navigating the picture.

- Using the remote control

1. Press **Digital Zoom+/-** to display the Zoom bar. Press **Digital Zoom+** to magnify the center of the picture. Press the key repeatedly until the picture size is suitable for your need.
2. Use the directional arrows (**▲**, **▼**, **◀**, **▶**) on the projector or remote control to navigate the picture.
3. To restore the picture to its original size, press **AUTO**. You can also press **Digital Zoom-**. When the key is pressed again, the picture is further reduced until it is restored to the original size.

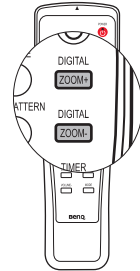

 The picture can only be navigated after it is magnified. You can further magnify the picture while searching for details.

- Using the OSD menu

1. Press **MENU/EXIT** and then press **◀/▶** until the **DISPLAY** menu is highlighted.
2. Press **▼** to highlight **Digital Zoom** and press **MODE/ENTER**. The Zoom bar displays.
3. Press **▲** repeatedly to magnify the picture to a desired size.
4. To navigate the picture, press **MODE/ENTER** to switch to the panning mode and press the directional arrows (**▲**, **▼**, **◀**, **▶**) on the projector or remote control to navigate the picture.
5. To reduce size of the picture, press **MODE/ENTER** to switch back to the zoom in/out function, and press **AUTO** to restore the picture to its original size. You can also press **▼** repeatedly until it is restored to the original size.

# Selecting the aspect ratio

The “aspect ratio” is the ratio of the image width to the image height. Most analog TV and some computers are in 4:3 ratio, and digital TV and DVDs are usually in 16:9 ratio.

With the advent of digital signal processing, digital display devices like this projector can dynamically stretch and scale the image output to a different aspect than that of the image input signal.

To change the projected picture ratio (no matter what aspect the source is):

- Using the remote control

1. Press **ASPECT** to show the current setting.
2. Press **ASPECT** repeatedly to select an aspect ratio to suit the format of the video signal and your display requirements.

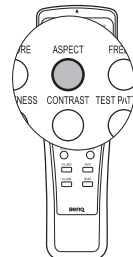

- Using the OSD menu

1. Press **MENU/EXIT** and then press **◀/▶** until the **DISPLAY** menu is highlighted.

2. Press ▼ to highlight **Aspect Ratio**.
3. Press ◀/▶ to select an aspect ratio to suit the format of the video signal and your display requirements.

## About the aspect ratio

☞ • In the pictures below, the black portions are inactive areas and the white portions are active areas.

- OSD menus can be displayed on those unused black areas.

1. **Auto:** Scales an image proportionally to fit the projector's native resolution in its horizontal or vertical width. This is suitable for the incoming image which is neither in 4:3 nor 16:9 and you want to make most use of the screen without altering the image's aspect ratio.

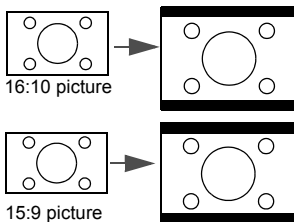

3. **4:3:** Scales an image so that it is displayed in the center of the screen with a 4:3 aspect ratio. This is most suitable for 4:3 images like some computer monitors, standard definition TV and 4:3 aspect DVD movies, as it displays them without aspect alteration.

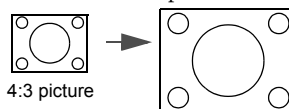

2. **Real:** The image is projected as its original resolution, and resized to fit within the display area. For input signals with lower resolutions, the projected image will display smaller than if resized to full screen. You could adjust the zoom setting or move the projector towards the screen to increase the image size if necessary. You may also need to refocus the projector after making these adjustments.

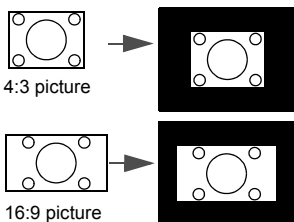

4. **16:9:** Scales an image so that it is displayed in the center of the screen with a 16:9 aspect ratio. This is most suitable for images which are already in a 16:9 aspect, like high definition TV, as it displays them without aspect alteration.

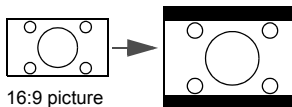



# Optimizing the image

## Using Wall Color

In the situation where you are projecting onto a colored surface such as a painted wall which may not be white, the Wall Color feature can help correct the projected picture's colors to prevent possible color difference between the source and projected pictures.

To use this function, go to the **DISPLAY > Wall Color** menu and press ◀/▶ to select a color which is closest to the color of the projection surface. There are several precalibrated colors to choose from: **Light Yellow, Pink, Light Green, Blue, and Blackboard**.

## Selecting a picture mode

The projector is preset with several predefined picture modes so that you can choose one to suit your operating environment and input signal picture type.

To select an operation mode that suits your need, you can follow one of the following steps.

- Press **MODE/ENTER** on the projector or remote control repeatedly until your desired mode is selected.
- Go to the **PICTURE > Picture Mode** menu and press ◀/▶ to select a desired mode.

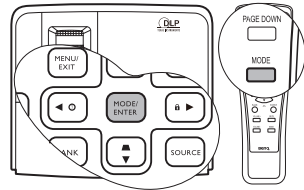

The picture modes are listed below.

1. **Dynamic mode:** Maximizes the brightness of the projected image. This mode is suitable for environments where extra-high brightness is required, such as using the projector in well lit rooms.
2. **Presentation mode (Default):** Is designed for presentations. The brightness is emphasized in this mode to match PC and notebook coloring.
3. **sRGB mode:** Maximizes the purity of RGB colors to provide true-to-life images regardless of brightness setting. It is most suitable for viewing photos taken with an sRGB compatible and properly calibrated camera, and for viewing PC graphic and drawing applications such as AutoCAD.
4. **Cinema mode:** Is appropriate for playing colorful movies, video clips from digital cameras or DVs through the PC input for best viewing in a blackened (little light) environment.
5. **User 1/User 2 mode:** Recalls the settings customized based on the current available picture modes. See "[Setting the User 1/User 2 mode](#)" on page 32 for details.

## Setting the User 1/User 2 mode

There are two user-definable modes if the current available picture modes are not suitable for your need. You can use one of the picture modes (except the **User 1/2**) as a starting point and customize the settings.

1. Press **MENU/EXIT** to open the On-Screen Display (OSD) menu.
2. Go to the **PICTURE > Picture Mode** menu.
3. Press ◀/▶ to select **User 1** or **User 2**.
4. Press ▼ to highlight **Reference Mode**.

 This function is only available when **User 1** or **User 2** mode is selected up in the **Picture Mode** sub-menu item.

5. Press ◀/▶ to select a picture mode that is closest to your need.
6. Press ▼ to select a menu item to be changed and adjust the value with ◀/▶ . See ["Fine-tuning the image quality in user modes"](#) below for details.
7. When all settings have been done, highlight **Save Settings** and press **MODE/ENTER** to store the settings.
8. The confirmation message "**Setting Saved**" displays.

## Fine-tuning the image quality in user modes

According to the detected signal type, there are some user-definable functions available when **User 1** or **User 2** is selected. Based on your needs, you can make adjustments to these functions by highlighting them and pressing ◀/▶ on the projector or remote control.

### Adjusting Brightness

The higher the value, the brighter the image. And the lower the setting, the darker the image. Adjust this control so the black areas of the image appear just as black and that detail in the dark areas is visible.



### Adjusting Contrast

The higher the value, the greater the contrast. Use this to set the peak white level after you have previously adjusted the Brightness setting to suit your selected input and viewing environment.



### Adjusting Color

Lower setting produces less saturated colors. If the setting is too high, colors on the image will be overpowering, which makes the image unrealistic.

### Adjusting Tint

The higher the value, the more reddish the picture becomes. The lower the value, the more greenish the picture becomes.

### Adjusting Sharpness

The higher the value, the sharper the picture becomes. The lower the value, the softer the picture becomes.

## Adjusting Brilliant Color

This feature utilizes a new color-processing algorithm and system level enhancements to enable higher brightness while providing truer, more vibrant colors in picture. It enables a greater than 50% brightness increase in mid-tone images, which are common in video and natural scenes, so the projector reproduces images in realistic and true colors. If you prefer images with that quality, select **On**. If you don't need it, select **Off**.

**On** is the default and recommended selection for this projector. When **Off** is selected, the **Color Temperature** function is not available.

## Selecting a color temperature

The options available for color temperature\* settings vary according to the signal type selected.

1. **T1:** With the highest color temperature, T1 makes the image appear the most bluish white than other settings.
2. **T2:** Makes images appear bluish white.
3. **T3:** Maintains normal colorings for white.
4. **T4:** Makes images appear reddish white.

### \*About color temperatures:

There are many different shades that are considered to be "white" for various purposes. One of the common methods of representing white color is known as the "color temperature". A white color with a low color temperature appears to be reddish white. A white color with a high color temperature appears to have more blue in it.

## 3D Color Management

In most installation situations, color management will not be necessary, such as in classroom, meeting room, or lounge room situations where lights remain on, or where building external windows allow daylight into the room.

Only in permanent installations with controlled lighting levels such as boardrooms, lecture theaters, or home theaters, should color management be considered. Color management provides fine color control adjustment to allow for more accurate color reproduction, should you require it.

Proper color management can only be achieved under controlled and reproducible viewing conditions. You will need to use a colorimeter (color light meter), and provide a set of suitable source images to measure color reproduction. These tools are not provided with the projector, however, your projector supplier should be able to provide you with suitable guidance, or even an experienced professional installer.

The Color Management provides six sets (RGBCMY) of colors to be adjusted. When you select each color, you can independently adjust its range and saturation according to your preference.

If you have purchased a test disc which contains various color test patterns and can be used to test the color presentation on monitors, TVs, projectors, etc, you can project any image from the disc on the screen and enter the **3D Color Management** menu to make adjustments.

To adjust the settings:

1. Go to the **PICTURE** menu and highlight **3D Color Management**.
2. Press **MODE/ENTER** on the projector or remote control and the **3D Color Management** page displays.
3. Highlight **Primary Color** and press **◀/▶** to select a color from among Red, Yellow, Green, Cyan, Blue, or Magenta.

- Press ▼ to highlight **Hue** and press ◀/▶ to select its range. Increase in the range will include colors consisted of more proportions of its two adjacent colors.

Please refer to the illustration to the right for how the colors relate to each other.

For example, if you select Red and set its range at 0, only pure red in the projected picture will be selected. Increasing its range will include red close to yellow and red close to magenta.

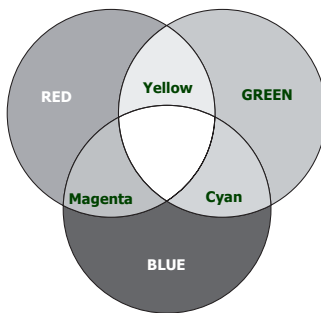

- Press ▼ to highlight **Saturation** and adjust its values to your preference by pressing ◀/▶. Every adjustment made will reflect to the image immediately.

For example, if you select Red and set its value at 0, only the saturation of pure red will be affected.

☞ **Saturation is the amount of that color in a video picture. Lower settings produce less saturated colors; a setting of “0” removes that color from the image entirely. If the saturation is too high, that color will be overpowering and unrealistic.**

- Press ▼ to highlight **Gain** and adjust its values to your preference by pressing ◀/▶. The contrast level of the primary color you select will be affected. Every adjustment made will reflect to the image immediately.
- Repeat steps 3 to 6 for other color adjustments.
- Make sure you have made all of the desired adjustments.
- Press **MENU/EXIT** to exit and save the settings.

## Setting the presentation timer

Presentation timer can indicate the presentation time on the screen to help you achieve better time management when giving presentations. Follow these steps to utilize this function:

- Press **Timer Set up** on the remote control or go to the **SYSTEM SETUP: Basic > Presentation Timer** menu and press **MODE/ENTER** to display the **Presentation Timer** page.
- Highlight **Timer Period** and decide the time period by pressing ◀/▶. The length of time can be set from 1 to 5 minutes in 1-minute increments and 5 to 240 minutes in 5-minute increments.

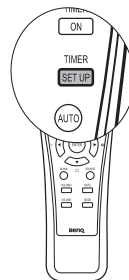

☞ **If the timer is already on, the timer will restart whenever the Timer Period is reset.**

- Press ▼ to highlight **Timer Display** and choose if you want the timer to show up on the screen by pressing ◀/▶.

Selection	Description
Always	Displays the timer on screen throughout the presentation time.
1 min/2 min/3 min	Displays the timer on screen in the last 1/2/3 minute(s).
Never	Hides the timer throughout the presentation time.

- Press ▼ to highlight **Timer Position** and set the timer position by pressing ◀/▶.

Top-Left → Bottom-Left → Top-Right → Bottom-Right

- Press ▼ to highlight **Timer Counting Direction** and select your desired counting direction by pressing ◀/▶.

Selection	Description
Count Up	Increases from 0 to the preset time.
Count Down	Decreases from the preset time to 0.

- Press ▼ to highlight **Sound Reminder** and decide if you want to activate sound reminder by pressing ◀/▶. If you select **On**, a double beep sound will be heard at the last 30 seconds of counting down/up, and a triple beep sound will be produced when the timer is up.
- To activate the presentation timer, press ▼ and press ◀/▶ to highlight **On** and press **MODE/ENTER**.
- A confirmation message displays. Highlight **Yes** and press **MODE/ENTER** on the projector or remote control to confirm. You will see the message “**Timer is On**” displaying on the screen. The timer starts counting when the timer is on.

### To cancel the timer, perform the following steps:

- **Using the remote control**

Press **Timer On** and press ◀/▶ to highlight **Off** and press **MODE/ENTER**.

- **Using the OSD menu**

- Go to the **SYSTEM SETUP: Basic > Presentation Timer** menu and highlight **Off**. Press **MODE/ENTER**. A confirmation message displays.
- Highlight **Yes** and press **MODE/ENTER** to confirm. You will see the message “**Timer is Off**” displaying on the screen.

### How to use the Timer On key?

**Timer On** is a multi-functional key.

- If the presentation timer is off, pressing this key displays a confirmation message. You can decide whether to activate the timer or not by following the on-screen instruction.
- If the timer is already on, pressing this key displays a confirmation message. You can decide whether to restart, continue or turn off the timer by following the on-screen instruction.

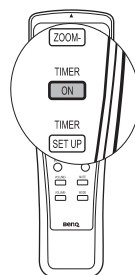

# Freezing the image

Press **FREEZE** on the remote control to freeze the image. The word “**FREEZE**” will display in the upper left corner of the screen. To release the function, press any key on the projector or remote control.

Even if an image is frozen on the screen, the pictures are running on the video or other device. If the connected devices have active audio output, you will still hear the audio even though the image is frozen onscreen.

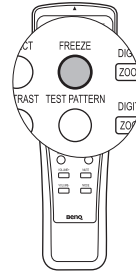

# Hiding the image

In order to draw the audience's full attention to the presenter, you can use **BLANK** on the projector or remote control to hide the screen image. The word “**BLANK**” appears in the corner of the screen while the image is hidden. When this function is activated with an audio input connected, the audio can still be heard.

You can set the blank time in the **SYSTEM SETUP: Basic > Blank Timer** menu to let the projector return the image automatically after a period of time when there is no action taken on the blank screen. The length of time can be set from 5 to 30 minutes in 5-minute increments.

If the preset time spans are not suitable for your personation, select **Disable**.

No matter **Blank Timer** is activated or not, you can press most of the keys on the projector or remote control to restore the picture.

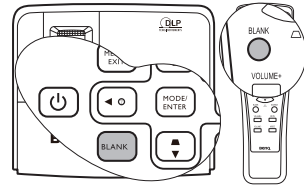

 **Do not block the projection lens from projecting as this could cause the blocking object to become heated and deformed or even cause a fire.**

# Utilizing FAQ function

The **INFORMATION** menu contains possible solutions to problems regarding image quality, installation, special feature operation and service information.

To get the FAQ information:

1. Press **◀ / (?)** on the projector or remote control or press **MENU/EXIT** to open the OSD menu and press **◀ / ▶** to highlight the **INFORMATION** menu.
2. Press **▼** to select **FAQ-Image and Installation** or **FAQ-Features and Service**.
3. Press **MODE/ENTER**.
4. Press **▲ / ▼** to select a problem and press **MODE/ENTER** for possible solutions.
5. To exit the OSD menu, press **MENU/EXIT**.

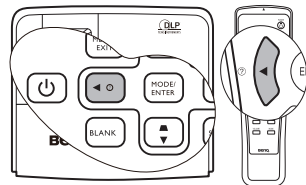

# Locking control keys

With the control keys on the projector locked, you can prevent your projector settings from being changed accidentally (by children, for example). When the **Panel Key Lock** is on, no control keys on the projector will operate except **Power**.

1. Press **▶/🔒** on the projector or remote control or go to the **SYSTEM SETUP: Basic > Panel Key Lock** menu, and select **On** by pressing **◀/▶** on the projector or remote control. A confirmation message displays.
2. Highlight **Yes** and press **MODE/ENTER** to confirm.

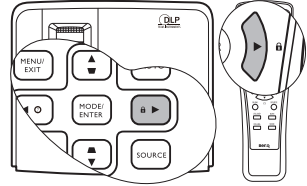

To release panel key lock, press and hold **▶/🔒** on the remote control or projector for 3 seconds.

You can also use the remote control to enter the **SYSTEM SETUP: Basic > Panel Key Lock** menu and press **◀/▶** to select **Off**.

- **Keys on the remote control are still active when panel key lock is enabled.**
- **If you press **Power** to turn off the projector without disabling panel key lock, the projector will still be in locked status the next time it is turned on.**

# Operating in a high altitude environment

We recommend you use the **High Altitude Mode** when your environment is between 1500 m –3000 m above sea level, and ambient temperature is between 0°C–35°C.

**⚠ Do not use the High Altitude Mode if your altitude is between 0 m and 1500 m and ambient temperature is between 0°C and 35°C. The projector will be over cooled, if you turn the mode on under such a condition.**

To activate the **High Altitude Mode**:

1. Press **MENU/EXIT** and then press **◀/▶** until the **SYSTEM SETUP: Advanced** menu is highlighted.
2. Press **▼** to highlight **High Altitude Mode** and press **◀/▶** select **On**. A confirmation message displays.
3. Highlight **Yes** and press **MODE/ENTER**.

Operation under "**High Altitude Mode**" may cause a higher decibel operating noise level because of increased fan speed necessary to improve overall system cooling and performance.

If you use this projector under other extreme conditions excluding the above, it may display auto shut-down symptoms, which is designed to protect your projector from over-heating. In cases like this, you should switch to High Altitude mode to solve these symptoms. However, this is not to state that this projector can operate under any and all harsh or extreme conditions.

# Adjusting the sound

The sound adjustments made as below will have an effect on the projector speakers. Be sure you have made a correct connection to the projector audio input. See "[Connection](#)" on page 18 for how the audio input is connected.

## Muting the sound

To temporarily turn off the sound:

1. Press **MENU/EXIT** and then press ◀/▶ until the **SYSTEM SETUP: Advanced** menu is highlighted.
2. Press ▼ to highlight **Audio Settings** and press **MODE/ENTER**. The **Audio Settings** page displays.
3. Highlight **Mute** and press ◀/▶ to select **On**.

## Adjusting the sound level

To adjust the sound level, press **Volume +/-** on the remote control, or:

1. Repeat steps 1-2 above.
2. Press ▼ to highlight **Volume** and press ◀/▶ to select a desired sound level.

## Turning off the Power on/off ring tone

To turn off the ring tone:

1. Repeat steps 1-2 above.
2. Press ▼ to highlight **Power on/off ring tone** and press ◀/▶ to select **Off**.

 The only way to change Power on/off ring tone is setting On or Off here. Setting the sound mute or changing the sound level will not affect the Power on/off ring tone.

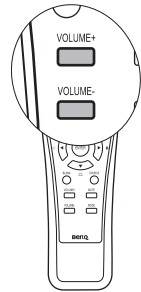

# Personalizing the projector menu display

The On-Screen Display (OSD) menus can be set according to your preferences. The following settings do not affect the projection settings, operation, or performance.

- **Menu Display Time** in the **SYSTEM SETUP: Basic > Menu Settings** menu sets the length of time the OSD will remain active after your last key press. The time length ranges from 5 to 30 seconds in 5-second increments. Use ◀/▶ to select a suitable time.
- **Menu Position** in the **SYSTEM SETUP: Basic > Menu Settings** menu sets the OSD position in five locations. Use ◀/▶ to select a preferred position.
- **Language** in the **SYSTEM SETUP: Basic** menu sets your familiar language for the On-Screen (OSD) Menus. Use ◀/▶ to select your language.
- **Splash Screen** in the **SYSTEM SETUP: Basic** menu sets a preferred logo screen to be displayed during projector start-up. Use ◀/▶ to select a screen.



# Controlling the projector through a Lan environment

**Lan Control Settings** allow you to manage the projector from a computer using a web browser when the computer and the projector are properly connected to the same local area network.

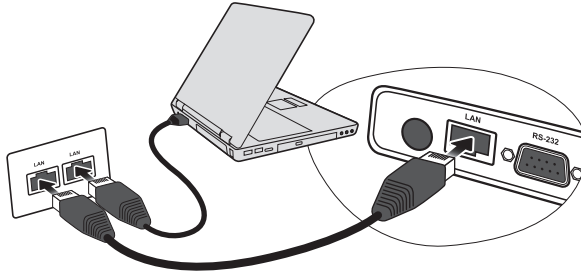

## Configuring the Lan Control Settings

### If you are in a DHCP environment:

1. Take a RJ45 cable and connect one end to the RJ45 LAN input jack of the projector and the other end to the RJ45 port.
2. Press **MENU/EXIT** and then press **◀/▶** until the **SYSTEM SETUP: Advanced** menu is highlighted.
3. Press **▼** to highlight **Lan Control Settings** and press **MODE/ENTER**. The **Lan Control Settings** page displays.
4. Press **▼** to highlight **Control By** and press **◀/▶** to select **RJ45**.
5. Press **▼** to highlight **DHCP** and press **◀/▶** to select **On**.
6. Press **▼** to highlight **Apply** and press **MODE/ENTER**.
7. Re-enter the **Lan Control Settings** page. The **Projector IP Address**, **Subnet Mask**, **Default Gateway**, and **DNS Server** settings will display. Note down the IP address displayed in the **Projector IP Address** row.

 If the **Projector IP Address** still does not display, contact your ITS administrator.

### If you are in a non-DHCP environment:

1. Repeat steps 1-4 above.
2. Press **▼** to highlight **DHCP** and press **◀/▶** to select **Off**.
3. Contact your ITS administrator for information on the **Projector IP Address**, **Subnet Mask**, **Default Gateway**, and **DNS Server** settings.
4. Press **▼** to select the item you want to modify and press **Mode/Enter**.
5. Press **◀/▶** to move the cursor and the press **▲/▼** to enter the value.
6. To save the settings, press **Mode/Enter**. If you do not want to save the settings, press **Menu/Exit**.
7. Press **▼** to highlight **Apply** and press **MODE/ENTER**.

## Controlling the projector remotely through a web browser

Once you have the correct IP address for the projector and the projector is on or in standby mode, you can use any computer that is on the same local area network to control the projector.

1. Enter the address of the projector in the address bar of your browser and click **GO**.

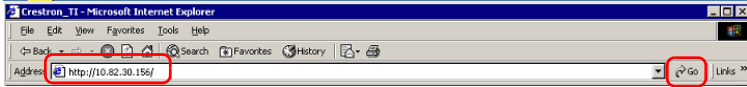

2. The remote network operation page opens. This page allows you to operate the projector as if you were using the remote control or control panel on the projector.



- i. These buttons function the same as the ones on the OSD menus or remote control. See "[2. PICTURE menu](#)" on page 47 and "[Remote control](#)" on page 11 for details.

 **The Menu button can also be used to go back to previous OSD menu, exit and save menu settings.**

- ii. To switch input source, click on your desired signal.

 **The source list varies according to the connectors available on the projector. "HDMI 1" stands for the HDMI signal; "Video 1" stands for the Video signal; "S-Video 1" stands for the S-Video signal.**

The tools page allows you to manage the projector, configure the Lan control settings and secure access of remote network operation on this projector.

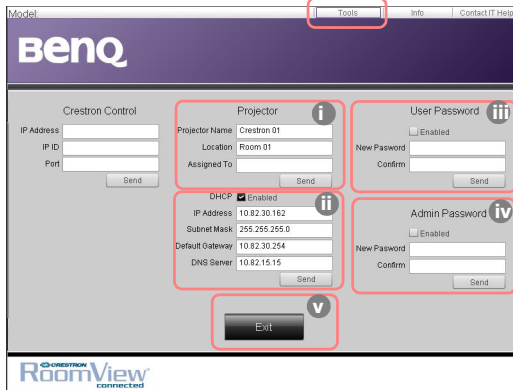

- i. You can name the projector, keep track of its location and the person in charge of it.
- ii. You can adjust the Lan Control Settings.
- iii. Once set, access to the remote network operation on this projector has been password-protected.
- iv. Once set, access to the tools page has been password-protected.

 **After making the adjustments, press the Send button and the data will be saved in the projector.**

- v. Press **Exit** to go back to the remote network operation page.

The info page displays the information and status of this projector.

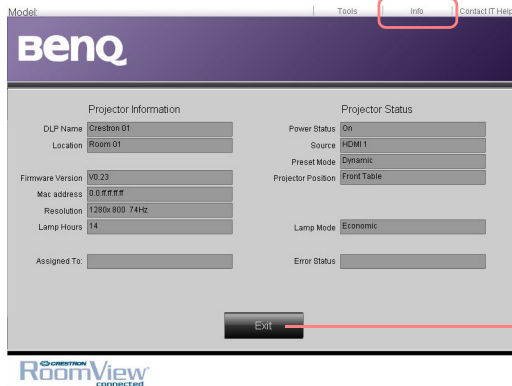



Press **Exit** to go back to the remote network operation page.

For more information, visit <http://www.crestron.com>. If you are an IT administrator and would like to manage multiple devices through one interface, you can download Crestron Roomview at [www.crestron.com/getroomview](http://www.crestron.com/getroomview).

# Shutting down the projector

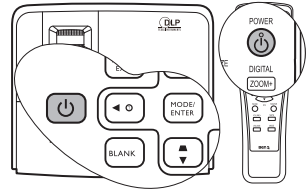
1. Press **Power** and a confirmation message will display prompting you.  
If you don't respond in a few seconds, the message will disappear.
2. Press **Power** a second time. The **POWER indicator light** flashes orange, the projection lamp shuts down, and the fans will continue to run for approximately 90 seconds to cool down the projector.



 **To protect the lamp, the projector will not respond to any commands during the cooling process.**

**To shorten the cooling time, you can also activate the Quick cooling function. See "Quick Cooling" on page 49 for details.**

3. Once the cooling process finishes, a "Power Off Ring Tone" will be heard. The **POWER indicator light** is a steady orange and fans stop. Disconnect the power cord from the power outlet.

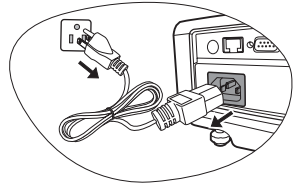

-  **To turn off the power ring tone, see "Turning off the Power on/off ring tone" on page 39 for details.**
- If the projector is not properly shut down, to protect the lamp, when you attempt to re-start the projector, the fans will run for a few minutes to cool down. Press **Power** again to start the projector after the fans stop and the **POWER indicator light** turns orange.**

# Menu operation

## Menu system

Please note that the on-screen display (OSD) menus vary according to the signal type selected and the projector model you are using.

Main menu	Sub-menu	Options	
1. DISPLAY	Wall Color	Off/Light Yellow/Pink/Light Green/Blue/Blackboard	
	Aspect Ratio	Auto/Real/4:3/16:9	
	Auto Keystone		
	Keystone		
	Position		
	Phase		
	H. Size		
	Digital Zoom		
2. PICTURE	Picture Mode	Dynamic/Presentation/sRGB/Cinema/User 1/User 2	
	Reference Mode	Dynamic/Presentation/sRGB/Cinema	
	Brightness		
	Contrast		
	Color		
	Tint		
	Sharpness		
	Brilliant Color	On/Off	
	Color Temperature	T1/T2/T3/T4	
	3D Color Management	Primary Color	R/G/B/C/M/Y
		Hue	
		Saturation	
		Gain	
	Save Settings		
3. SOURCE	Quick Auto Search	On/Off	
	Color Space Conversion	Auto/RGB/YUV	
4. SYSTEM SETUP: Basic	Presentation Timer	Timer Period	1~240 minutes
		Timer Display	Always/1 min/2 min/3 min/Never
		Timer Position	Top-Left/Bottom-Left/Top-Right/Bottom-Right
		Timer Counting Direction	Count Down/Count Up
		Sound Reminder	On/Off
			On/Off





Main menu	Sub-menu	Options	
<b>4. SYSTEM SETUP: Basic</b>	<b>Language</b>	English / Français / Deutsch Italiano / Español / Русский 繁體中文 / 简体中文 / 日本語 / 한국어 / Svenska / Nederlands / Türkçe / Čeština / Português / हिन्दी / Polski Magyar / Български / Hrvatski / Română / Suomi / Norsk / Dansk	
	<b>Projector Position</b>	<b>Front Table/Rear Table/Rear Ceiling/Front Ceiling</b>	
	<b>Menu Settings</b>	<b>Menu Display Time</b>	5 sec/10 sec/15 sec/20 sec/25 sec/30 sec
		<b>Menu Position</b>	Center/Top-Left/Top-Right/ Bottom-Right/Bottom-Left
	<b>Auto Power Off</b>	<b>Disable</b> /5 min/10 min/15 min/20 min/25 min/30 min	
	<b>Blank Timer</b>	<b>Disable</b> /5 min/10 min/15 min/20 min/25 min/30 min	
	<b>Panel Key Lock</b>	On/Off	
	<b>Sleep Timer</b>	<b>Disable</b> /30 min/1 hr/2 hr/3 hr/4 hr/8 hr/12 hr	
	<b>Splash Screen</b>	Black/Blue/BenQ	
	<b>5. SYSTEM SETUP: Advanced</b>	<b>Quick Cooling</b>	<b>On/Off</b>
<b>High Altitude Mode</b>		<b>On/Off</b>	
<b>Audio Settings</b>		<b>Mute</b>	<b>On/Off</b>
		<b>Volume</b>	
		<b>Power on/off ring tone</b>	<b>On/Off</b>
<b>Standby Monitor Out</b>		<b>On/Off</b>	
<b>Lamp Settings</b>		<b>Lamp Mode</b>	<b>Normal/Economic</b>
		<b>Reset lamp timer</b>	
		<b>Equivalent Lamp Hour</b>	
<b>Security Settings</b>		<b>Change Password</b>	
		<b>Power On Lock</b>	
<b>Baud Rate</b>		2400/4800/9600/14400/19200/ 38400/57600/115200	
<b>Test Pattern</b>	<b>On/Off</b>		

Main menu	Sub-menu	Options
<b>5. SYSTEM SETUP: Advanced</b>	<b>Closed Caption</b>	<b>Closed Caption Enable</b> <b>On/Off</b>
		<b>Caption Version</b> CC1/CC2/CC3/CC4
	<b>Lan Control Settings</b>	<b>Control By</b> <b>RJ45/RS232</b>
		<b>DHCP</b> <b>On/Off</b>
		<b>Projector IP Address</b>
		<b>Subnet Mask</b>
		<b>Default Gateway</b>
		<b>DNS Server</b>
		<b>Apply</b>
	<b>Reset All Settings</b>	
	<b>6. INFORMATION</b>	<b>FAQ-Image and Installation</b>
<b>FAQ-Features and Service</b>		
<b>Current System Status</b>		<ul style="list-style-type: none"> <li>• <b>Source</b></li> <li>• <b>Picture Mode</b></li> <li>• <b>Resolution</b></li> <li>• <b>Color System</b></li> <li>• <b>Equivalent Lamp Hour</b></li> <li>• <b>Firmware Version</b></li> </ul>



Note that the menu items are available when the projector detects at least one valid signal. If there is no equipment connected to the projector or no signal detected, limited menu items are accessible.

The default values listed in this manual, especially on pages 47-51, are for reference only. They may vary between the projectors due to the continuous improvement to the products.



# Description of each menu

Function (Default setting/value)	Description
<b>1. DISPLAY menu</b>	<b>Wall Color</b> (Off) Corrects the projected picture's color when the projection surface is not white. See <a href="#">"Using Wall Color" on page 32</a> for details.
	<b>Aspect Ratio</b> (Auto) There are four options to set the image's aspect ratio depending on your input signal source. See <a href="#">"Selecting the aspect ratio" on page 30</a> for details.
	<b>Auto Keystone</b> (On) Automatically corrects any keystone of the image. See <a href="#">"Correcting keystone" on page 28</a> for details.
	<b>Keystone</b> (0) Corrects any keystone of the image. See <a href="#">"Correcting keystone" on page 28</a> for details.
	<b>Position</b> (0) Displays the position adjustment page. To move the projected image, use the directional arrow keys. The values shown on the lower position of the page change with every key press you made until they reach their maximum or minimum.  <b>This function is only available when a PC signal (analog RGB) is selected.</b>
	<b>Phase</b> (depends on the selected input signal) Adjusts the clock phase to reduce image distortion.  <b>This function is only available when a PC signal (analog RGB) is selected.</b> 
	<b>H. Size</b> (0)  <b>This function is only available when a PC signal (analog RGB) is selected.</b>
<b>2. PICTURE menu</b>	<b>Digital Zoom</b> (1.0X) Magnifies or reduces the projected image. See <a href="#">"Magnifying and searching for details" on page 30</a> for details.
	<b>Picture Mode</b> (Presentation) Pre-defined picture modes are provided so you can optimize your projector image set-up to suit your program type. See <a href="#">"Selecting a picture mode" on page 32</a> for details.
	<b>Reference Mode</b> (Dynamic) Selects a picture mode that best suits your need for the image quality and further fine-tune the image based on the selections listed on the same page below. See <a href="#">"Setting the User 1/User 2 mode" on page 32</a> for details.
	<b>Brightness</b> (50) Adjusts the brightness of the image. See <a href="#">"Adjusting Brightness" on page 33</a> for details.
<b>Contrast</b> (0) Adjusts the degree of difference between dark and light in the image. See <a href="#">"Adjusting Contrast" on page 33</a> for details.	



<b>Function</b> (default setting/value)		<b>Description</b>
<b>2. PICTURE menu</b>	<b>Color</b> (0)	Adjusts the color saturation level -- the amount of each color in a video image. See " <a href="#">Adjusting Color</a> " on page 33 for details.  <b>This function is only available when a Video or S-Video signal is selected and the system format is NTSC or PAL.</b>
	<b>Tint</b> (0)	Adjusts the red and green color tones of the image. See " <a href="#">Adjusting Tint</a> " on page 33 for details.  <b>This function is only available when a Video or S-Video signal is selected and the system format is NTSC.</b>
	<b>Sharpness</b> (15)	Adjusts the image to make it look sharper or softer. See " <a href="#">Adjusting Sharpness</a> " on page 33 for details.  <b>This function is only available when a Video or S-Video signal is selected and the system format is NTSC or PAL.</b>
	<b>Brilliant Color</b> (On)	See " <a href="#">Adjusting Brilliant Color</a> " on page 34 for details.
	<b>Color Temperature</b> (depends on the selected input signal)	There are four color temperature settings available. See " <a href="#">Selecting a color temperature</a> " on page 34 for details.
	<b>3D Color Management</b>	See " <a href="#">3D Color Management</a> " on page 34 for details.
	<b>Save Settings</b>	Saves the settings made for <b>User 1</b> or <b>User 2</b> mode.
<b>3. SOURCE menu</b>	<b>Quick Auto Search</b> (On)	See " <a href="#">Switching input signal</a> " on page 29 for details.
	<b>Color Space Conversion</b> (depends on the selected input signal)	See " <a href="#">Changing Color Space</a> " on page 29 for details.
<b>4. SYSTEM SETUP:</b> Basic menu	<b>Presentation Timer</b> (Off)	Reminds the presenter to finish the presentation within a certain time frame. See " <a href="#">Setting the presentation timer</a> " on page 35 for details.
	<b>Language</b> (English)	Sets the language for the On-Screen Display (OSD) menus. See " <a href="#">Using the menus</a> " on page 25 for details.

<b>Function</b> (default setting / value)	<b>Description</b>
<b>4. SYSTEM SETUP: Basic menu</b>	<b>Projector Position</b> (Front Table) The projector can be installed on a ceiling or behind a screen, or with one or more mirrors. See <a href="#">"Choosing a location"</a> on page 14 for details.
	<b>Menu Settings</b> <b>Menu Display Time</b> (15 sec) Sets the length of time the OSD will remain active after your last key press. The range is from 5 to 30 seconds in 5-second increments. <b>Menu Position</b> (Center) Sets the On-Screen Display (OSD) menu position.
	<b>Auto Power Off</b> (Disable) Allows the projector to turn off automatically if no input signal is detected after a set period of time. See <a href="#">"Setting Auto Power Off"</a> on page 53 for details.
	<b>Blank Timer</b> (Disable) Sets the image blank time when the Blank feature is activated, once elapsed the image will return to the screen. See <a href="#">"Hiding the image"</a> on page 37 for details.
	<b>Panel Key Lock</b> (Off) Disables or enables all panel key functions except  <b>Power</b> on the projector and keys on the remote control. See <a href="#">"Locking control keys"</a> on page 38 for details.
	<b>Sleep Timer</b> (Disable) Sets the auto-shutdown timer. The timer can be set to a value between 30 minutes and 12 hours.
	<b>Splash Screen</b> (BenQ logo) Allows you to select which logo screen will display during projector start-up. The following options are available: BenQ logo, Black screen, Blue screen.
<b>5. SYSTEM SETUP: Advanced menu</b>	<b>Quick Cooling</b> (On) Enables or disables the Quick Cooling function. Selecting <b>On</b> enables the function and projector cooling time will be shortened from a normal 90-second duration to approximately 30 seconds.
	<b>High Altitude Mode</b> (Off) A mode for operation in high altitude areas. See <a href="#">"Operating in a high altitude environment"</a> on page 38 for details.
	<b>Audio Settings</b> <b>Mute</b> (Off) <b>Volume</b> (5) <b>Power on/off ring tone</b> (On) See <a href="#">"Adjusting the sound"</a> on page 39 for details.

Function (default setting / value)	Description
5. SYSTEM SETUP: Advanced menu	<p>Selecting <b>On</b> enables the function. The projector can output a VGA signal when it is in standby mode and the <b>COMPUTER 1</b> jack is correctly connected to devices. See "<a href="#">Connecting a monitor</a>" on page 19 for how to make the connection.</p> <p> <b>Enabling this function slightly increases the standby power consumption.</b></p>
	<p><b>Lamp Mode (Normal)</b> See "<a href="#">Setting Lamp Mode as Economic</a>" on page 53 for details.</p> <p><b>Reset lamp timer</b> See "<a href="#">Resetting the lamp timer</a>" on page 57 for details.</p> <p><b>Equivalent Lamp Hour</b> See "<a href="#">Getting to know the lamp hour</a>" on page 53 for details on how the total lamp hour is calculated.</p>
	<p><b>Change Password</b> You will be asked to enter the current password before changing to a new one. See "<a href="#">Utilizing the password function</a>" on page 26 for details.</p> <p><b>Power On Lock (Off)</b> See "<a href="#">Utilizing the password function</a>" on page 26 for details.</p>
	<p><b>Baud Rate (115200)</b> Selects a baud rate that is identical with your computer's so that you can connect the projector using a suitable RS-232 cable and update or download the projector's firmware. This function is intended for qualified service personnel.</p>
	<p><b>Test Pattern (Off)</b> Selecting <b>On</b> enables the function and the projector displays the grid test pattern. It helps you adjust the image size and focus and check that the projected image is free from distortion.</p>
	<p><b>Closed Caption Enable (Off)</b> Activates the function by selecting <b>On</b> when the selected input signal carries closed captions.</p> <ul style="list-style-type: none"> <li>• Captions: An on-screen display of the dialogue, narration, and sound effects of TV programs and videos that are closed captioned (usually marked as "CC" in TV listings).</li> </ul> <p> <b>Set your screen aspect ratio to 4:3. This function is not available when the aspect ratio is "16:9" or "Real".</b></p> <p><b>Caption Version (CC1)</b> Selects a preferred closed captioning mode. To view captions, select CC1, CC2, CC3, or CC4 (CC1 displays captions in the primary language in your area).</p>

<b>Function</b> (default setting / value)	<b>Description</b>	
<b>5. SYSTEM SETUP : Advanced menu</b>	<b>Lan Control Settings</b>	<b>Control By (RS232)</b> <b>DHCP (On)</b> <b>Projector IP Address</b> <b>Subnet Mask</b> <b>Default Gateway</b> <b>DNS Server</b> <b>Apply</b> See " <a href="#">Controlling the projector through a Lan environment</a> " on page 40 for details.
	<b>Reset All Settings</b>	Returns all settings to the factory preset values.   The following settings will still remain: <b>Position, Phase, H. Size, User 1, User 2, Color Space Conversion, Language, Projector Position, High Altitude Mode, Security Settings and Baud Rate.</b>
<b>6. INFORMATION menu</b>	<b>FAQ-Image and Installation</b>	Displays possible solutions to problems you may encounter.
	<b>FAQ-Features and Service</b>	
	<b>Current System Status</b>	<b>Source</b> Shows the current signal source.  <b>Picture Mode</b> Shows the selected mode in the <b>PICTURE</b> menu.  <b>Resolution</b> Shows the native resolution of the input signal.  <b>Color System</b> Shows input system format: NTSC, PAL, SECAM, or RGB.  <b>Equivalent Lamp Hour</b> Displays the number of hours the lamp has been used.  <b>Firmware Version</b> Shows the firmware version of your projector.

# Maintenance

## Care of the projector

Your projector needs little maintenance. The only thing you need to do on a regular basis is to keep the lens and case clean.

Never remove any parts of the projector except the lamp. Contact your dealer if other parts need replacing.

### Cleaning the lens

Clean the lens whenever you notice dirt or dust on the surface.

- Use a canister of compressed air to remove dust.
- If there is dirt or smears, use lens-cleaning paper or moisten a soft cloth with lens cleaner and gently wipe the lens surface.
- Never use any type of abrasive pad, alkaline/acid cleaner, scouring powder, or volatile solvent, such as alcohol, benzene, thinner or insecticide. Using such materials or maintaining prolonged contact with rubber or vinyl materials may result in damage to the projector surface and cabinet material.

### Cleaning the projector case

Before you clean the case, turn the projector off using the proper shutdown procedure as described in "[Shutting down the projector](#)" on page 43 and unplug the power cord.

- To remove dirt or dust, wipe the case with a soft, lint-free cloth.
- To remove stubborn dirt or stains, moisten a soft cloth with water and a neutral pH detergent. Then wipe the case.

 **Never use wax, alcohol, benzene, thinner or other chemical detergents. These can damage the case.**

### Storing the projector

If you need to store the projector for an extended time, please follow the instructions below:

- Make sure the temperature and humidity of the storage area are within the recommended range for the projector. Please refer to "[Specifications](#)" on page 60 or consult your dealer about the range.
- Retract the adjuster feet.
- Remove the batteries from the remote control.
- Pack the projector in its original packing or equivalent.

### Transporting the projector

It is recommended that you ship the projector with its original packing or equivalent. When you carry the projector yourself, please use the original box or provided soft carry case.

# Lamp information

## Getting to know the lamp hour

When the projector is in operation, the duration (in hours) of lamp usage is automatically calculated by the built-in timer. The method of calculating the equivalent lamp hour is as follows:

Total (equivalent) lamp hour  
= 1 (hours used in Economic mode) + 3/2 (hours used in normal mode)

 See "**Setting Lamp Mode as Economic**" below for more information on **Economic mode**.

To obtain the lamp hour information:

1. Press **MENU/EXIT** and then press **◀/▶** to highlight the **SYSTEM SETUP: Advanced** menu.
2. Press **▼** to highlight **Lamp Settings** and press **MODE/ENTER**. The **Lamp Settings** page displays.
3. You will see the **Equivalent Lamp Hour** information displaying on the menu.
4. To leave the menu, press **MENU/EXIT**.

You can also get the lamp hour information on the **INFORMATION** menu.

## Extending lamp life

The projection lamp is a consumable item that normally can last up to 2000-3000 hours with proper usage. To keep the lamp life as long as possible, you can do the following settings via the OSD menu.

- **Setting Lamp Mode as Economic**

Using **Economic** mode reduces system noise and power consumption by 20%. If the **Economic** mode is selected, the light output will be reduced and result in darker projected pictures.

Setting the projector in **Economic** mode also extends the lamp operation life. To set **Economic** mode, go into the **SYSTEM SETUP: Advanced > Lamp Settings > Lamp Mode** menu and press **◀/▶**.

- **Setting Auto Power Off**

This function allows the projector to turn off automatically if no input signal is detected after a set period of time to prevent unnecessary waste of lamp life.

To set **Auto Power Off**, go into the **SYSTEM SETUP: Basic > Auto Power Off** menu and press **◀/▶**. The time period can be set from 5 to 30 minutes in 5-minute increments. If the preset time lengths are not suitable for your presentation, select **Disable**. The projector will not automatically shut down in a certain time period.

## Timing of replacing the lamp



When the **Lamp indicator** lights up red or a message appears suggesting it is time to replace the lamp, please install a new lamp or consult your dealer. An old lamp may cause a malfunction in the projector and in some instances the lamp may explode.

Go to <http://lamp.benq.com> for a replacement lamp.

 **The LAMP indicator light and TEMPERATURE warning light will light up if the lamp becomes too hot. Turn the power off and let the projector cool for 45 minutes. If the Lamp or Temp indicator still lights up after turning the power back on, please contact your dealer. See "Indicators" on page 58 for details.**

The following Lamp warning displays will remind you to change the lamp.

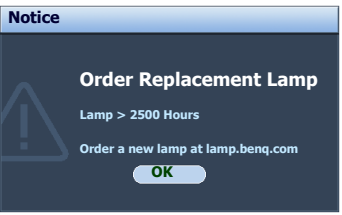
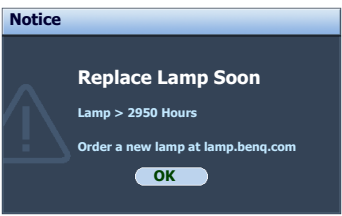
 **The warning messages below are for reference only. Please follow the actual on-screen instructions to prepare and replace the lamp.**

Status	Message
<p>The lamp has been in operation equivalent to 2500 hours. Install a new lamp for optimal performance. If the projector is normally run with "Economic Mode" selected (See "<a href="#">Lamp Mode (Normal)</a>" on page 50), you may continue to operate the projector until the 2950 hour lamp warning appears.</p>	 <p><b>Notice</b></p> <p><b>Order Replacement Lamp</b></p> <p>Lamp &gt; 2500 Hours</p> <p>Order a new lamp at <a href="http://lamp.benq.com">lamp.benq.com</a></p> <p><b>OK</b></p>
<p>The lamp has been in operation equivalent to 2950 hours. A new lamp should be fitted to avoid the inconvenience when the projector runs out of lamp time.</p>	 <p><b>Notice</b></p> <p><b>Replace Lamp Soon</b></p> <p>Lamp &gt; 2950 Hours</p> <p>Order a new lamp at <a href="http://lamp.benq.com">lamp.benq.com</a></p> <p><b>OK</b></p>
<p>The lamp has been in operation equivalent to 3000 hours.</p> <p>It is strongly recommended that you replace the lamp at this age. The lamp is a consumable item. The lamp brightness diminishes with use. This is normal lamp behavior. You can replace the lamp whenever you notice that the brightness level has significantly diminished. If the lamp is not replaced beforehand, it must be replaced after 3000 hours usage.</p>	 <p><b>Notice</b></p> <p><b>Replace Lamp Now</b></p> <p>Lamp &gt; 3000 Hours Lamp usage time exceeded</p> <p>Order a new lamp at <a href="http://lamp.benq.com">lamp.benq.com</a></p> <p><b>OK</b></p>
<p>The lamp <b>MUST</b> be replaced before the projector will operate normally.</p>	 <p><b>Notice</b></p> <p><b>Out of Lamp Usage Time</b></p> <p>Replace lamp (refer to User manual) Then reset lamp timer</p> <p>Order a new lamp at <a href="http://lamp.benq.com">lamp.benq.com</a></p> <p><b>OK</b></p>

# Replacing the lamp



- To reduce the risk of electrical shock, always turn the projector off and disconnect the power cord before changing the lamp.
- To reduce the risk of severe burns, allow the projector to cool for at least 45 minutes before replacing the lamp.
- To reduce the risk of injuries to fingers and damage to internal components, use caution when removing lamp glass that has shattered into sharp pieces.
- To reduce the risk of injuries to fingers and/or compromising image quality by touching the lens, do not touch the empty lamp compartment when the lamp is removed.
- This lamp contains mercury. Consult your local hazardous waste regulations to dispose of this lamp in a proper manner.
- To assure optimal performance from the projector, it is recommended that you purchase a qualified projector lamp for lamp replacement.
- If lamp replacement is performed while the projector is suspended upside-down from the ceiling, make sure that no one is underneath the lamp socket to avoid any possible injury or damage to the human eyes caused by fractured lamp.

1. Turn the power off and disconnect the projector from the power outlet. If the lamp is hot, avoid burns by waiting for approximately 45 minutes until the lamp has cooled.
2. Loosen the screws that secure the lamp cover on the both sides of the projector until the lamp cover loosens.

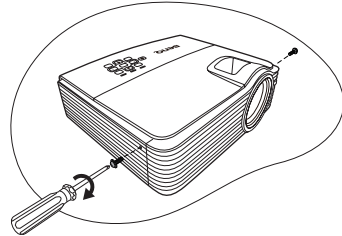

3. Remove the lamp cover from the projector.



- Do not turn the power on with the lamp cover removed.
- Do not insert your fingers between the lamp and the projector. The sharp edges inside the projector may cause injuries.

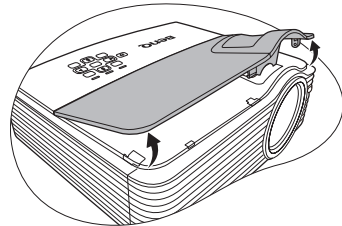

4. Remove and dispose the protection film.
5. Disconnect the lamp connector from the projector as illustrated.
6. Loosen the screw that secures the lamp.

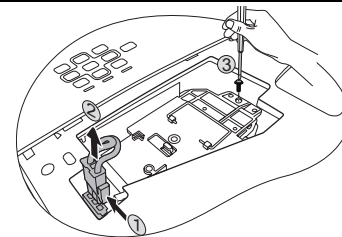



- 
7. Lift the handle so that it stands up. Use the handle to slowly pull the lamp out of the projector.



- **Pulling it too quickly may cause the lamp to break and scatter broken glass in the projector.**
- **Do not place the lamp in locations where water might splash on it, children can reach it, or near flammable materials.**
- **Do not insert your hands into the projector after the lamp is removed. If you touch the optical components inside, it could cause color unevenness and distortion of the projected images.**

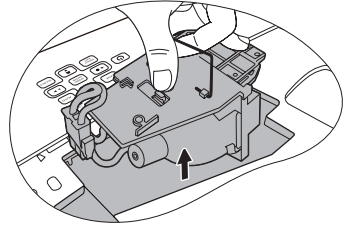

- 
8. As shown in the figure, lower the new lamp first into the connector on the projector and reconnect the lamp connector.

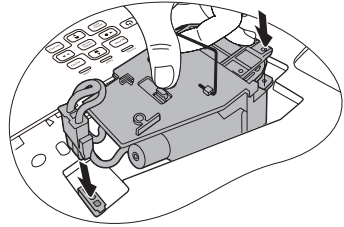

- 
9. Tighten the screw that secures the lamp.



- **Loose screw may cause a bad connection, which could result in malfunction.**
- **Do not over tighten the screw.**

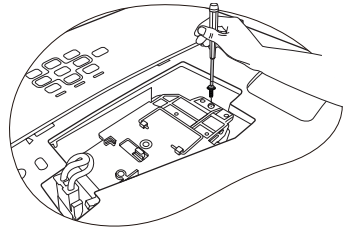

- 
10. Ensure the handle is fully laid flat and locked in place.

11. Replace the new protection film that comes with the new lamp.

12. Replace the lamp cover on the projector.

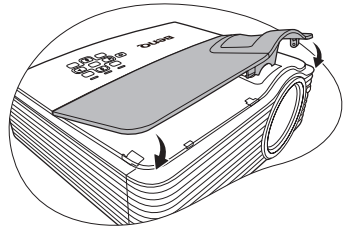

---

13. Tighten the screws that secure the lamp cover.



- **Loose screw may cause a bad connection, which could result in malfunction.**

- **Do not over tighten the screw.**

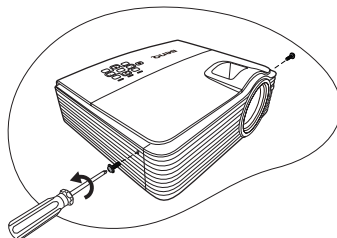

14. Connect the power and restart the projector.



**Do not turn the power on with the lamp cover removed.**



#### **Resetting the lamp timer**

15. After the startup logo, open the On-Screen Display (OSD) menu. Go to the **SYSTEM SETUP: Advanced > Lamp Settings** menu. Press **MODE/ENTER**. The **Lamp Settings** page displays. Highlight **Reset lamp timer**. A warning message displays asking if you want to reset the lamp timer. Highlight **Reset** and press **MODE/ENTER**. The lamp time will be reset to “0”.



**Do not reset if the lamp is not new or replaced as this could cause damage.**

# Indicators

Light			Status & Description
POWER 	TEMP 	LAMP 	
Power events			
<b>Orange</b>	<b>Off</b>	<b>Off</b>	Stand-by mode.
<b>Green Flashing</b>	<b>Off</b>	<b>Off</b>	Powering up.
<b>Green</b>	<b>Off</b>	<b>Off</b>	Normal operation.
<b>Orange Flashing</b>	<b>Off</b>	<b>Off</b>	<ul style="list-style-type: none"> <li>The projector needs 90 seconds to cool down as it was abnormally shut down without the normal cooling down process.</li> <li>The projector needs to cool for 90 seconds after the power is turned off.</li> <li>The projector has shutdown automatically. If you try to re-start the projector, it will shutdown again. Please contact your dealer for assistance.</li> </ul>
Lamp events			
<b>Orange Flashing</b>	<b>Off</b>	<b>Red</b>	The projector has shutdown automatically. If you try to re-start the projector, it will shut down again. Please contact your dealer for assistance.
<b>Off</b>	<b>Off</b>	<b>Red</b>	<ol style="list-style-type: none"> <li>The projector needs 90 seconds to cool down. <b>Or</b></li> <li>Please contact your dealer for assistance.</li> </ol>
Thermal events			
<b>Off</b>	<b>Red</b>	<b>Off</b>	The projector has shut down automatically. If you try to re-start the projector, it will shutdown again. Please contact your dealer for assistance.
<b>Off</b>	<b>Red</b>	<b>Red</b>	
<b>Off</b>	<b>Red</b>	<b>Green</b>	
<b>Off</b>	<b>Red</b>	<b>Orange</b>	
<b>Red</b>	<b>Red</b>	<b>Red</b>	
<b>Red</b>	<b>Red</b>	<b>Green</b>	
<b>Red</b>	<b>Red</b>	<b>Orange</b>	
<b>Green</b>	<b>Red</b>	<b>Red</b>	
<b>Green</b>	<b>Red</b>	<b>Green</b>	
<b>Green</b>	<b>Red</b>	<b>Orange</b>	
<b>Orange</b>	<b>Red</b>	<b>Red</b>	
<b>Orange</b>	<b>Red</b>	<b>Green</b>	
<b>Orange</b>	<b>Red</b>	<b>Orange</b>	
<b>Off</b>	<b>Green</b>	<b>Red</b>	
<b>Off</b>	<b>Green</b>	<b>Green</b>	

# Troubleshooting

## ① The projector does not turn on.

Cause	Remedy
There is no power from the power cord.	Plug the power cord into the AC power jack on the projector, and plug the power cord into the power outlet. If the power outlet has a switch, make sure that it is switched on.
Attempting to turn the projector on again during the cooling process.	Wait until the cooling down process has completed.

## ① No picture

Cause	Remedy
The video source is not turned on or connected correctly.	Turn the video source on and check that the signal cable is connected correctly.
The projector is not correctly connected to the input signal device.	Check the connection.
The input signal has not been correctly selected.	Select the correct input signal with the <b>SOURCE</b> key on the projector or remote control.
The lens cover is still closed.	Open the lens cover.

## ① Blurred image

Cause	Remedy
The projection lens is not correctly focused.	Adjust the focus of the lens using the focus ring.
The projector and the screen are not aligned properly.	Adjust the projection angle and direction as well as the height of the projector if necessary.
The lens cover is still closed.	Open the lens cover.

## ① Remote control does not work

Cause	Remedy
The batteries are out of power.	Replace the batteries with new ones.
There is an obstacle between the remote control and the projector.	Remove the obstacle.
You are too far away from the projector.	Stand within 8 meters (26 feet) of the projector.

## ① The password is incorrect

Cause	Remedy
You do not remember the password.	Please see <a href="#">"Entering the password recall procedure"</a> on page 27 for details.

# Specifications

## Projector specifications

 All specifications are subject to change without notice.

### Optical

Resolution  
1024 x 768 XGA

Display system  
1-CHIP DMD

Lens F/Number  
F = 2.59-2.92

Lamp  
280 W lamp

### Electrical

Power supply  
AC100–240V, 4.2 A, 50-60 Hz (Automatic)

Power consumption  
425 W (Max); < 1 W (Standby)

### Mechanical

Weight  
6.9 lbs (3.1 Kg)

### Output terminals

RGB output  
D-Sub 15-pin (female) x 1

Speaker  
(Stereo) 5 watt x 2

### Control

RS-232 serial control  
9 pin x 1

Lan control  
RJ45 x 1

IR receiver x 2

12V trigger x 1 (Max. 1A)

### Input terminals

Computer input  
RGB input  
D-Sub 15-pin (female) x 2

Video signal input  
S-VIDEO  
Mini DIN 4-pin port x 1

VIDEO  
RCA jack x 1

SD/HDTV signal input  
Analog - Component RCA jack x 3  
(through RGB input)

Digital - HDMI V1.3 x 1

Audio signal input  
Audio in  
PC audio jack x 1  
RCA audio jack (L/R) x 2

### Environmental Requirements

Operating temperature  
0°C–40°C at sea level

Operating relative humidity  
10%–90% (without condensation)

Operating altitude  
0–1499 m at 0°C–35°C  
1500–3000 m at 0°C–30°C (with  
High Altitude Mode on)

# Dimensions

290 mm (W) x 94 mm (H) x 252 mm (D)

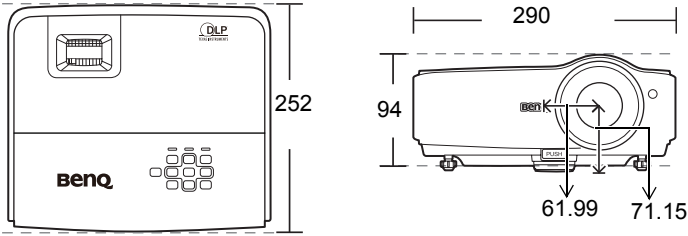

# Ceiling mount installation

- ◎ Ceiling mount screw: M4 x 8 (Max. L = 8 mm)

Unit: mm

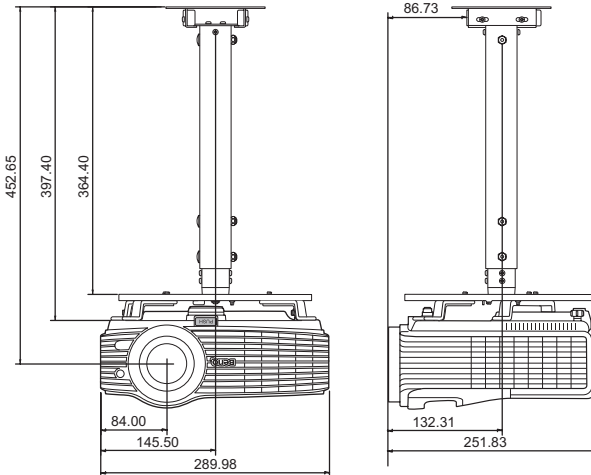
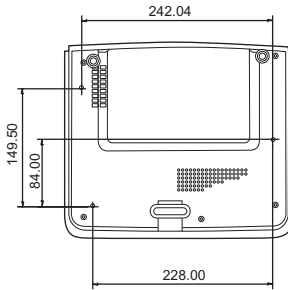

# Timing chart

## Supported timing for PC input

Resolution	Mode	Vertical Frequency (Hz)	Horizontal Frequency (kHz)	Pixel Frequency (MHz)
720 x 400	720 x 400_70	70.087	31.469	28.3221
640 x 480	VGA_60	59.940	31.469	25.175
	VGA_72	72.809	37.861	31.500
	VGA_75	75.000	37.500	31.500
	VGA_85	85.008	43.269	36.000
800 x 600	SVGA_60	60.317	37.879	40.000
	SVGA_72	72.188	48.077	50.000
	SVGA_75	75.000	46.875	49.500
	SVGA_85	85.061	53.674	56.250
1024 x 768	XGA_60	60.004	48.363	65.000
	XGA_70	70.069	56.476	75.000
	XGA_75	75.029	60.023	78.750
1280 x 800	WXGA_60	59.810	49.702	83.500
	WXGA_75	74.934	62.795	106.5
	WXGA_85	84.88	71.554	122.5
1280 x 1024	SXGA_60	60.020	63.981	108.000
	SXGA_75	75.025	79.976	135.000
1280 x 960	1280 x 960_60	60.000	60.000	108.000
1440 x 900	WXGA+_75	74.984	70.635	136.750
1600 x 1200	UXGA	60.000	75.000	162.000
640 x 480@67Hz	MAC13	66.667	35.000	30.240
832 x 624@75Hz	MAC16	74.546	49.722	57.280
1024 x 768@75Hz	MAC19	75.020	60.241	80.000
1152 x 870@75Hz	MAC21	75.060	68.680	100.000
1024 x 576@60Hz	Netbook_timing	60.000	35.820	46.996
1024 x 600@65Hz	Netbook_timing	64.995	41.467	51.419
640 x 480	640 x 480 120Hz	119.518	61.91	52.5
800 x 600	VESA DMT0D 120Hz	119.972	76.302	73.25
	800X600 120Hz	119.854	77.425	83
1024 x 768	VESA DMT14 120Hz	119.989	97.551	115.5

## Supported timing for HDMI (HDCP) input - MP776

Resolution	Mode	Vertical Frequency (Hz)	Horizontal Frequency (kHz)	Pixel Frequency (MHz)
720 x 400	720 x 400_70	70.087	31.469	28.3221
640 x 480	VGA_60	59.940	31.469	25.175
	VGA_72	72.809	37.861	31.500
	VGA_75	75.000	37.500	31.500
	VGA_85	85.008	43.269	36.000
800 x 600	SVGA_60	60.317	37.879	40.000
	SVGA_72	72.188	48.077	50.000
	SVGA_75	75.000	46.875	49.500
	SVGA_85	85.061	53.674	56.250
1024 x 768	XGA_60	60.004	48.363	65.000
	XGA_70	70.069	56.476	75.000
	XGA_75	75.029	60.023	78.750
	XGA_85	84.997	68.667	94.500
1024 x 576	Netbook_timing	60.0	35.820	46.996
1024 x 600	Netbook_timing	64.995	41.467	51.419
1280 x 800	WXGA_60	59.810	49.702	83.500
	WXGA_75	84.880	71.554	122.500
	WXGA_85	74.934	62.795	106.500
1280 x 1024	SXGA_60	60.020	63.981	108.000
	SXGA_75	75.025	79.976	135.000
	SXGA_85	85.024	91.146	157.500
1280 x 960	1280 x 960_60	60.000	60.000	108.000
	1280 x 960_85	85.002	85.938	148.500
1440 x 900	WXGA+_60	59.887	55.935	106.500
	WXGA+_75	74.984	70.635	136.750
1400 x 1050	SXGA+_60	59.978	65.317	121.750
1600 x 1200	UXGA	60.000	75.000	162.000
640 x 480@67Hz	MAC13	66.667	35.000	30.240
832 x 624@75	MAC16	74.546	49.722	57.280
1024 x 768@75Hz	MAC19	75.020	60.241	80.000
1152 x 870@75Hz	MAC21	75.060	68.680	100.000
Video (HDCP)	480p	60.000	31.470	27.000
	576p	50.000	31.250	27.000
	720p_60	60.000	45.000	74.250
	720p_50	50.000	37.500	74.250
	1080i_60	60.000	33.750	74.250
	1080i_50	50.000	28.130	74.250
	1080p	60.000	67.500	148.500
	1080P	50.000	56.260	148.500

 Displaying a 1080i(1125i)@60Hz or 1080i(1125i)@50Hz signal may result in slight image vibration.



## Supported timing for Component-YPbPr input

Signal Format	Horizontal Frequency (kHz)	Vertical Frequency (Hz)
480i(525i)@60Hz	15.73	59.94
480p(525p)@60Hz	31.47	59.94
576i(625i)@50Hz	15.63	50.00
576p(625p)@50Hz	31.25	50.00
720p(750p)@60Hz	45.00	60.00
720p(750p)@50Hz	37.50	50.00
1080i(1125i)@60Hz	33.75	60.00
1080i(1125i)@50Hz	28.13	50.00
1080p@60Hz	67.50	60.00
1080p@50Hz	56.26	50.00

ⓘ Displaying a 1080i(1125i)@60Hz or 1080i(1125i)@50Hz signal may result in slight image vibration.

## Supported timing for Video and S-Video inputs

Video mode	Horizontal Frequency (kHz)	Vertical Frequency (Hz)	Color sub-carrier Frequency (MHz)
NTSC	15.73	60	3.58
PAL	15.63	50	4.43
SECAM	15.63	50	4.25 or 4.41
PAL-M	15.73	60	3.58
PAL-N	15.63	50	3.58
PAL-60	15.73	60	4.43
NTSC4.43	15.73	60	4.43

# Warranty and Copyright information

## Limited warranty

BenQ warrants this product against any defects in material and workmanship, under normal usage and storage.

Proof of purchase date will be required with any warranty claim. In the event this product is found to be defective within the warranty period, BenQ's only obligation and your exclusive remedy shall be replacement of any defective parts (labor included). To obtain warranty service, immediately notify the dealer from which you purchased the product of any defects.

Important: The above warranty shall be void if the customer fails to operate the product in accordance with BenQ's written instructions, especially the ambient humidity must be in-between 10% and 90%, temperature in-between 0°C and 35°C, altitude lower than 4920 feet, and avoiding to operate the projector in a dusty environment. This warranty gives you specific legal rights, and you may have other rights which vary from country to country.

For other information, please visit [www.BenQ.com](http://www.BenQ.com).

## Copyright

Copyright 2009 by BenQ Corporation. All rights reserved. No part of this publication may be reproduced, transmitted, transcribed, stored in a retrieval system or translated into any language or computer language, in any form or by any means, electronic, mechanical, magnetic, optical, chemical, manual or otherwise, without the prior written permission of BenQ Corporation.

## Disclaimer

BenQ Corporation makes no representations or warranties, either expressed or implied, with respect to the contents hereof and specifically disclaims any warranties, merchantability or fitness for any particular purpose. Further, BenQ Corporation reserves the right to revise this publication and to make changes from time to time in the contents hereof without obligation to notify any person of such revision or changes.

\*DLP, Digital Micromirror Device and DMD are trademarks of Texas Instruments. Others are copyrights of their respective companies or organizations.

# Regulation statements

## FCC statement

**CLASS B:** This equipment generates, uses and can radiate radio frequency energy and, if not installed and used in accordance with the instructions, may cause harmful interference to radio communications. However, there is no guarantee that interference will not occur in a particular installation. If this equipment does cause harmful interference to radio or television reception, which can be determined by turning the equipment off and on, the user is encouraged to try to correct the interference by one or more of the following measures:

- Reorient or relocate the receiving antenna.
- Increase the distance between the equipment and receiver.
- Connect the equipment into an outlet on a circuit different from that to which the receiver is connected.
- Consult the dealer or an experienced radio/TV technician for help.

## EEC statement

This machine was tested against the 89/336/EEC (European Economic Community) for EMC (Electronic Magnetic Compatibility) and fulfills these requirements.

## WEEE directive

**Disposal of Waste Electrical and Electronic Equipment by users in private households in the European Union.**

This symbol on the product or on the packaging indicates that this can not be disposed of as household waste. You must dispose of your waste equipment by handing it over to the applicable take-back scheme for the recycling of electrical and electronic equipment. For more information about recycling of this equipment, please contact your city office, the shop where you purchased the equipment or your household waste disposal service. The recycling of materials will help to conserve natural resources and ensure that it is recycled in a manner that protects human health and environment.



## Accessibility Requirements for Rehabilitation Act of 1973, Section 508

BenQ's commitment to accessible products allows us to support government in making accessible technology choices BenQ's LCD monitors and projectors are compliant with Section 508 guidelines by including the assistive features as below:

- BenQ's monitors have colored "Power" indicators. While the indicator shows green, it means that the monitor is using the full power. While the indicator shows yellow or amber, it means that the monitor is in suspend or sleep mode and is using less than 2 watts of electricity.
- BenQ's monitors have a variety of settings of pre-programmed flicker-free timing to make the screen shown on the monitor readily accessible. The default timing setting is automatically turned on every time the monitor is powered up, and thus reduces the hassle of user intervention.
- BenQ's monitors and projectors have options for brightness and contrast adjustments that text and images could be displayed differently to meet the demands of the visually impaired. Other similar adjustments are also available by using the On-Screen Display (OSD) controls on the products.
- BenQ's monitors and projectors include user-selectable color controls, such as color temperature selections (Monitor: 5800K, 6500K and 9300K, Projector: 5500K, 6500K, 7500K and 9300K), with a wide range of contrast levels.
- BenQ's multimedia monitors and projectors usually have one or two speakers for audio performance which allow users (including hearing impaired) to interact with the computer systems connected. Speaker controls are typically located on the front-panel.
- Firmware of BenQ's monitors and projectors contain unique product information that helps computer systems to identify BenQ products and activate their Plug-and-Play function when connected.
- All BenQ's monitors and projectors are compatible with the PC99 standard. For example, connectors are color-coded to help users easily connecting products to computer systems correctly.
- Some models of BenQ's monitors and projectors contain additional USB and DVI ports for connection to more devices such as a special headphone to assist the hearing impaired.
- All BenQ monitors and projectors come with user manuals on compact discs which could be easily read by commercial software such as Adobe Reader via a connected computer system. These documents are also available on the BenQ's web site ([www.BenQ.com](http://www.BenQ.com)). Other types of documents may be available upon requests.
- BenQ's customer service provides answers and assistance to all our customers through phone calls, facsimiles, e-mails, or web sites.