

myprojectorlamps.com

**The most trusted, dependable name
in projector lamp sales.**



<http://www.myprojectorlamps.com>



<http://www.myprojectorlamps.ca>



<http://www.myprojectorlamps.eu>

The following projector manual has not been modified or altered in any way.

BenQ

MP770 Digital Projector

Mainstream Series

User's Manual

Welcome

Copyright

Copyright 2006 by BenQ Corporation. All rights reserved. No part of this publication may be reproduced, transmitted, transcribed, stored in a retrieval system or translated into any language or computer language, in any form or by any means, electronic, mechanical, magnetic, optical, chemical, manual or otherwise, without the prior written permission of BenQ Corporation.

Disclaimer

BenQ Corporation makes no representations or warranties, either expressed or implied, with respect to the contents hereof and specifically disclaims any warranties, merchantability or fitness for any particular purpose. Further, BenQ Corporation reserves the right to revise this publication and to make changes from time to time in the contents hereof without obligation to notify any person of such revision or changes.

*DLP, Digital Micromirror Device and DMD are trademarks of Texas Instruments. Others are copyrights of their respective companies or organizations.

Table of contents

Important safety instructions	5
Introduction	9
Projector features	9
Shipping contents	10
Projector exterior view	11
Controls and functions	12
Positioning your projector	17
Choosing a location	17
Safety instructions for ceiling mounting of the projector	18
Obtaining a preferred projected image size	19
Connection	22
Wireless connection (optional)	22
Cable connection	22
Operation	31
Start up	31
Utilizing the password function	32
Switching input signal	34
Adjusting the projected image	34
Selecting the aspect ratio	37
Optimizing the image.....	38
Operating in a high altitude environment	40
Hiding the image	40
PIP (Picture In Picture) operation	41
Remote paging operations	42
Freezing the image	42
Creating your own startup screen	42
Personalizing the projector menu display.....	43
Shutting down the projector	43
Menu operation	44
Maintenance	53
Care of the projector	53

Lamp information.....	56
Troubleshooting.....	62
Specifications.....	64
Projector specifications	64
Timing chart.....	65
Dimensions.....	66
Warranty.....	67
Limited warranty	67
Regulation statements.....	68
FCC statement	68
EEC statement	68
MIC statement	68
WEEE directive	68

1 Important safety instructions

Your BenQ projector is designed and tested to meet the latest standards for safety of information technology equipment. However, to ensure safe use of this product, it is important that you follow the instructions mentioned in this manual and marked on the product.

Safety Instructions

1. **Please read this manual before you operate your projector.** Save it for future reference.

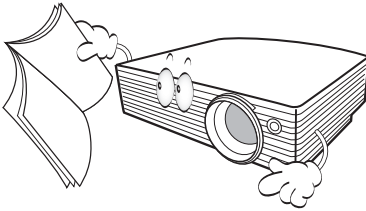

2. **Do not look straight at the projector lens during operation.** The intense light beam may damage your eyes.

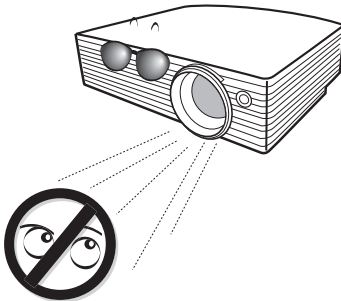

3. **Refer servicing to qualified service personnel.**

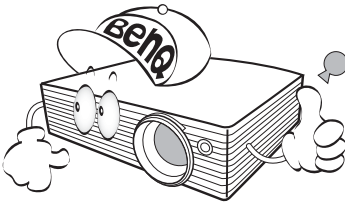

4. **Always open the lens shutter or remove the lens cap when the projector lamp is on.**

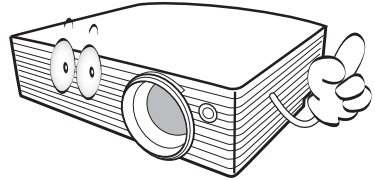

5. In some countries, the line voltage is NOT stable. This projector is designed to operate safely within a mains voltage between 100 to 240 volts AC, but could fail if power cuts or surges of ± 10 volts occur. **In areas where the mains voltage may fluctuate or cut out, it is recommended that you connect your projector through a power stabilizer, surge protector or uninterruptible power supply (UPS).**

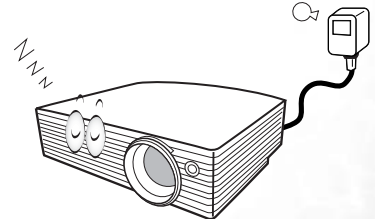

6. Do not block the projection lens with any objects when the projector is under operation as this could cause the objects to become heated and deformed or even cause a fire. To temporarily turn off the lamp, press **BLANK** on the projector or remote control.

Safety Instructions (Continued)

7. The lamp becomes extremely hot during operation. Allow the projector to cool for approximately 45 minutes prior to removing the lamp assembly for replacement.

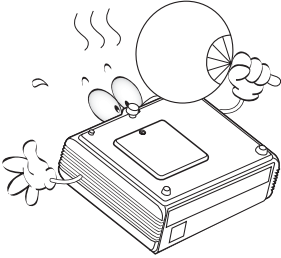

8. Do not operate lamps beyond the rated lamp life. Excessive operation of lamps beyond the rated life could cause them to break on rare occasions.

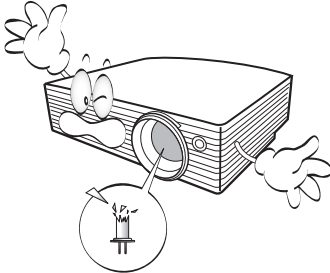

9. Never replace the lamp assembly or any electronic components unless the projector is unplugged.

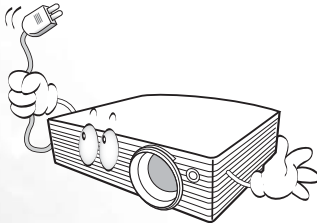

10. Do not place this product on an unstable cart, stand, or table. The product may fall, sustaining serious damage.

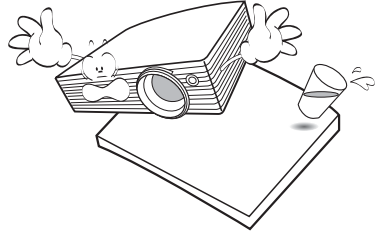

11. Do not attempt to disassemble this projector. There are dangerous high voltages inside which may cause death if you should come into contact with live parts. The only user serviceable part is the lamp which has its own removable cover. Under no circumstances should you ever undo or remove any other covers. Refer servicing only to suitably qualified professional service personnel.

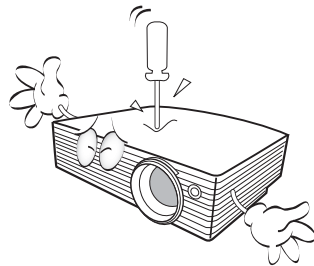

Safety Instructions (Continued)

12. Do not place this projector in any of the following environments.

- Space that is poorly ventilated or confined. Allow at least 50 cm clearance from walls and free flow of air around the projector.
- Locations where temperatures may become excessively high, such as the inside of a car with all windows rolled up.
- Locations where excessive humidity, dust, or cigarette smoke may contaminate optical components, shortening the projector's life span and darkening the image.

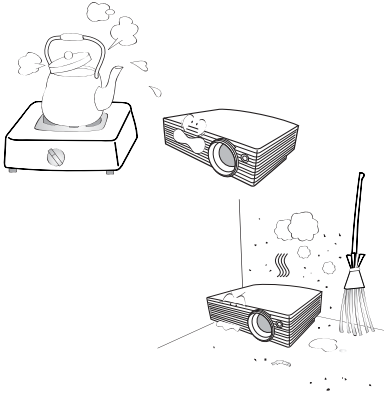

- Locations near fire alarms
- Locations with an ambient temperature above 40°C / 104°F
- Locations where the altitudes are higher than 10000 feet.

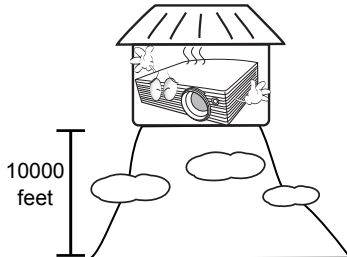

13. Do not block the ventilation holes.

- Do not place this projector on a blanket, bedding or any other soft surface.
- Do not cover this projector with a cloth or any other item.
- Do not place inflammables near the projector.

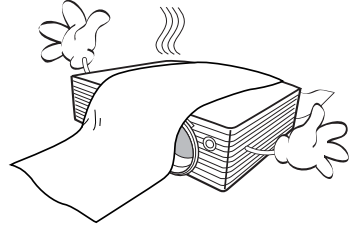

If the ventilation holes are seriously obstructed, overheating inside the projector may result in a fire.

14. Always place the projector on a level, horizontal surface during operation.

- Do not use if tilted at an angle of more than 10 degrees left to right, nor at angle of more than 15 degrees front to back. Using the projector when it is not fully horizontal may cause a malfunction of, or damage to, the lamp.

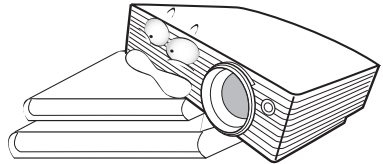

15. Do not stand the projector on end vertically. Doing so may cause the projector to fall over, causing injury or resulting in damage to the projector.

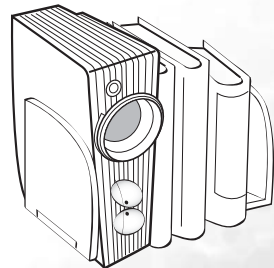

Safety Instructions (Continued)

16. Do not step on the projector or place any objects upon it. Besides probable physical damage to the projector, doing so may result in accidents and possible injury.

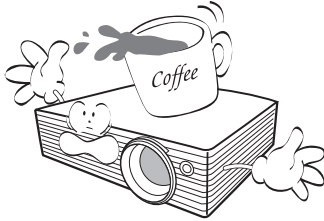

17. Do not place liquids near or on the projector. Liquids spilled into the projector may cause it to fail. If the projector does become wet, disconnect it from the power supply's wall socket and call BenQ to have the projector serviced.

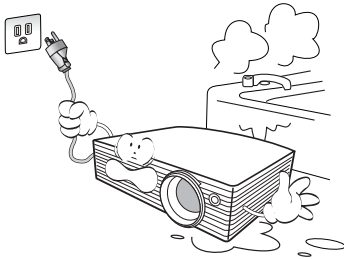

18. This product is capable of displaying inverted images for ceiling mount installation.



Use only BenQ's Ceiling Mount Kit for mounting the projector and ensure it is securely installed.

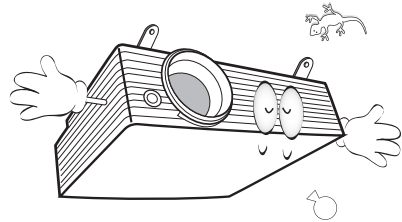

19. When the projector is under operation, you may sense some heated air and odor from its ventilation grill. It is a normal phenomenon and not a product defect.

2 Introduction

Projector features

The projector integrates high-performance optical engine projection and a user-friendly design to deliver high reliability and ease of use.

The projector offers the following features.

- Selectable password protected function
- Off and Go function allowing presenters to unplug the projector right after the projector is turned off
- Up to 11 sets of application modes providing multiple choices for different projection purposes
- Optional wireless module allowing more computers to share one projector through cable or wireless connection
- High quality manual zoom lens
- One-key auto-adjustment to display the best picture quality
- Two-way digital keystone correction to correct distorted images
- Adjustable color balance control for data/video display
- Ultra-high brightness projection lamp
- Ability to display 16.7 million colors
- Multi-language On-Screen Display (OSD) menus
- Switchable normal and Economic modes to reduce the power consumption
- Built-in speaker provides mixed mono audio when an audio input is connected
- Powerful AV function to provide high quality video image
- Component HDTV compatibility (YPbPr)
- Replaceable dust filter



- **The apparent brightness of the projected image will vary depending on the ambient lighting conditions, selected input source contrast/brightness settings, and is directly proportional to projection distance.**
- **The lamp brightness will decline over time and may vary within the lamp manufacturers specifications. This is normal and expected behavior.**

Shipping contents

The projector is shipped with the cables required for connection to a PC or video equipment. Carefully unpack and verify that you have all of the items shown below. If any of these items are missing, please contact your place of purchase.

Standard accessories

 **The supplied accessories will be suitable for your region, and may differ from those illustrated.**

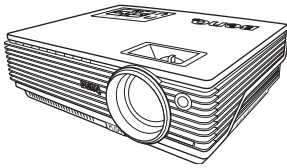

Projector



Soft carry case

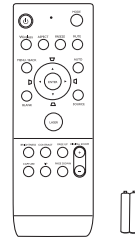

Remote control with batteries



Quick start
guide



User's manual
CD



User's manual

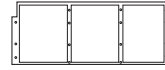

Replacement filter

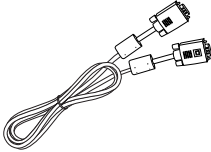

VGA cable

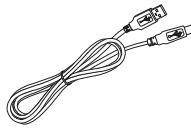

USB cable

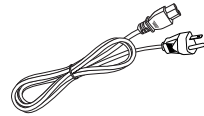

Power cord



PC audio cable

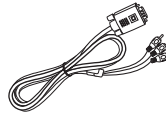

Component Video to VGA (D-Sub)
adaptor cable

Optional accessories

1. Macintosh adapter
2. Spare lamp kit
3. Ceiling mount kit
4. RS232 connector
5. Wireless module

Projector exterior view

Front/upper side

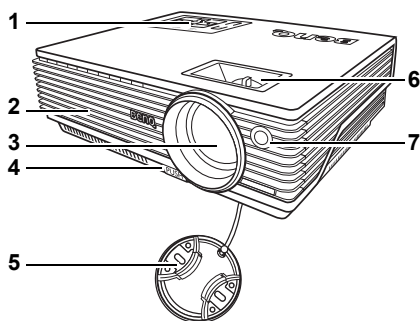

1. External control panel
(See "Projector" on page 12 for details.)
2. Vent (heated air exhaust)
3. Projection lens
4. Quick-release button
5. Lens cap
6. Focus ring and Zoom ring
7. Front IR remote sensor

Rear side

See "Connection" on page 22 for details.

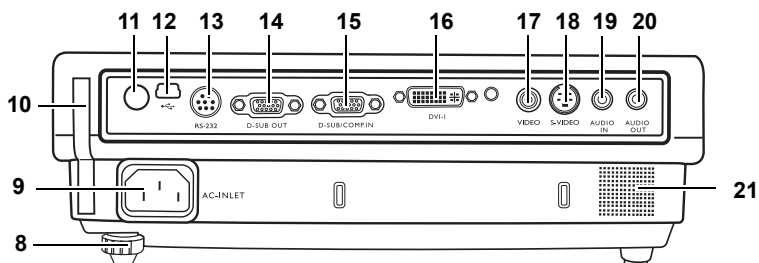

- | | |
|---|---|
| <ol style="list-style-type: none"> 8. Rear adjuster foot 9. AC power cord inlet 10. Filter case 11. Rear IR remote sensor 12. USB socket 13. RS232 control port 14. RGB signal output socket | <ol style="list-style-type: none"> 15. RGB (PC)/Component video (YPbPr/YCbCr) signal input socket 16. DVI-I signal input socket 17. Video input socket 18. S-Video input socket 19. Audio input socket 20. Audio output socket 21. Speaker grill |
|---|---|

Lower/side view

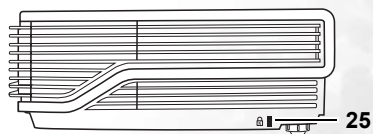
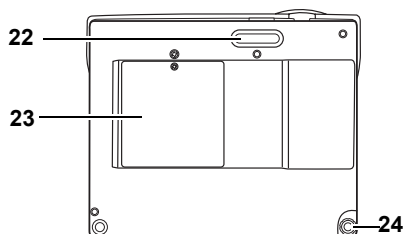

22. Quick-release foot
23. Lamp cover
24. Rear adjuster foot
25. Kensington anti-theft lock slot

Controls and functions

Projector

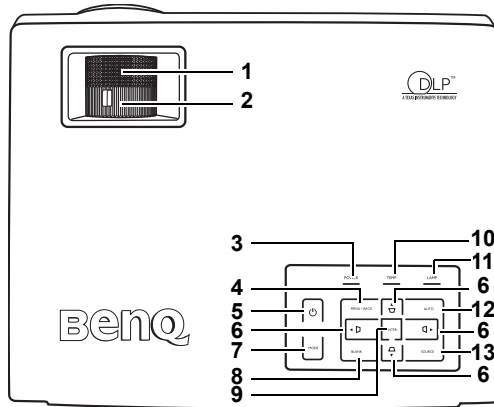

- 1. Focus ring**

Adjusts the focus of the projected image. See "[Fine-tuning the image size and clarity](#)" on page 35 for details.
- 2. Zoom ring**

Adjusts the size of the image. See "[Fine-tuning the image size and clarity](#)" on page 35 for details.
- 3. Power indicator light**

Lights up or flashes when the projector is under operation. See "[Indicators](#)" on page 60 for details.
- 4. MENU/BACK**

Turns on the On-Screen Display (OSD) menu.
Goes back to previous OSD menu, exits and saves menu settings.
See "[Using the menus](#)" on page 46 for details.
- 5. Power**

Toggles the projector between standby mode and on.
When the projector is in standby mode, press once to turn the projector on.
When the projector is on, press twice to turn the projector to standby.
See "[Start up](#)" on page 31 and "[Shutting down the projector](#)" on page 43 for details.
- 6. Keystone/Arrow buttons (◀ / ▲ Up, □ / ▼ Down, ▶ / ▼ Right)**

Manually corrects distorted images resulting from an angled projection.
When the On-Screen Display (OSD) menu is activated, the buttons are used as directional arrows to select the desired menu items and to make adjustments.
See "[Correcting keystone](#)" on page 35 and "[Using the menus](#)" on page 46 for details.

7. **MODE**

Depending upon which input signal is selected, selects an available picture setup mode. See "[Application Mode](#)" on page 48 for details.

When a wireless module is installed and the Wireless Connection menu is displayed, press this button to change among LAN, IEEE 802.11 a, and IEEE 802.11 b/g. (The wireless module is available through BenQ retailers.)
8. **BLANK**

Used to hide the screen image. To restore the image, press any button (except **LASER**) on the projector or remote control. See "[Hiding the image](#)" on page 40 for details.
9. **ENTER**

Enacts the selected On-Screen Display (OSD) menu item. See "[Using the menus](#)" on page 46 for details.
10. **Temperature warning light**

Lights up red if the projector's temperature becomes too high. See "[Indicators](#)" on page 60 for details.
11. **Lamp indicator light**

Indicates the status of the lamp. Lights up or flashes when the lamp has developed a problem. See "[Indicators](#)" on page 60 for details.
12. **AUTO**

Automatically determines the best picture timings for the displayed image. See "[Auto-adjusting the image](#)" on page 35 for details.

When a wireless module is installed, the Wireless Connection menu is displayed and the IEEE 802.11 a is selected, press this button to search for a reliable channel. (The wireless module is available through BenQ retailers.)
13. **SOURCE**

Sequentially selects the input signal D-Sub (Analog RGB), Comp. (YPbPr), DVI-A, DVI-D, Video, or S-Video. See "[Switching input signal](#)" on page 34 for details.

Remote control

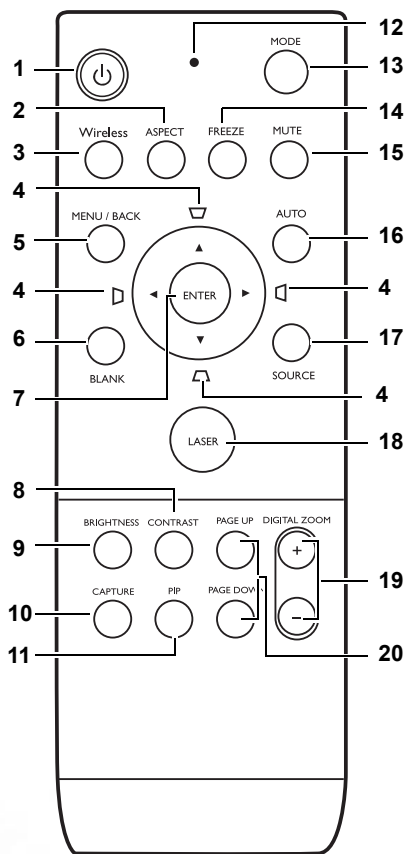

1. **Power**
Toggles the projector between standby mode and on.
When the projector is in standby mode, press once to turn the projector on.
When the projector is on, press twice to turn the projector to standby.
See ["Start up" on page 31](#) and ["Shutting down the projector" on page 43](#) for details.
2. **ASPECT**
Selects the display aspect ratio. See ["Selecting the aspect ratio" on page 37](#) for details.
3. **WIRELESS**
Turns on or off the wireless connection menu. See ["Wireless connection \(optional\)" on page 22](#) for details.
4. **Keystone/ Arrow buttons** (◀ / ▲ Up, □ / ▶ Right, ▼ Down, ◀ / ◻ / ▶ Right)
Manually corrects distorted images resulting from an angled projection. When the On-Screen Display (OSD) menu is activated, the buttons are used as directional arrows to select the desired menu items and to make adjustments. See ["Correcting keystone" on page 35](#) and ["Using the menus" on page 46](#) for details.
5. **MENU/BACK**
Turns on the On-Screen Display (OSD) menu.
Goes back to previous OSD menu, exits and saves menu settings.
See ["Using the menus" on page 46](#) for details.
6. **BLANK**
Used to hide the screen image. To restore the image, press any button (except **LASER**) on the projector or remote control. See ["Hiding the image" on page 40](#) for details.
7. **ENTER**
Enacts the selected On-Screen Display (OSD) menu item. See ["Using the menus" on page 46](#) for details.
8. **CONTRAST**
Displays the Contrast adjustment bar. To adjust the value, press the directional arrow buttons on the projector or remote control.

9. BRIGHTNESS

Displays the Brightness adjustment bar. To adjust the value, press the directional arrow buttons on the projector or remote control.

10. CAPTURE

Captures the projected image and save it as your startup screen. See "[Creating your own startup screen](#)" on page 42 for details.

11. PIP

Turns the Picture In Picture (PIP) window on or off. See "[PIP \(Picture In Picture\) operation](#)" on page 41 for details.

12. LED indicator light

Lights red when any button on the remote control is pressed.

13. MODE

Depending upon which input signal is selected, selects an available picture setup mode. See "[Application Mode](#)" on page 48 for details.

When a wireless module is installed and the Wireless Connection menu is displayed, press this button to change among LAN, IEEE 802.11 a, and IEEE 802.11 b/g. (The wireless module is available through BenQ retailers.)

14. FREEZE

The image is frozen when **FREEZE** is pressed. To release the function, press any button (except **LASER**) on the projector or remote control. See "[Freezing the image](#)" on page 42 for details.

15. MUTE

Toggles projector audio between on and off.

16. AUTO

Automatically determines the best picture timings for the displayed image. See "[Auto-adjusting the image](#)" on page 35 for details.

When a wireless module is installed, the Wireless Connection menu is displayed and the IEEE 802.11 a is selected, press this button to search for a reliable channel. (The wireless module is available through BenQ retailers.)

17. SOURCE

Sequentially selects the input signal D-Sub (Analog RGB), Comp. (YPbPr), DVI-A, DVI-D, Video, or S-Video. See "[Switching input signal](#)" on page 34 for details.

18. LASER

Emits visible laser pointer light for presentation purposes.

The Laser Pointer is a presentation aid for professionals. It emits red colored light when you press it and the LED indicator lights up red.

 **WARNING: Do not look into the laser light window or shine the laser light beam on yourself or others. See the warning messages on the back of the remote control and the attached "User Information" prior to using it.**

19. DIGITAL ZOOM buttons (+, -)

Magnifies or reduces the projected image size.

20. PAGE UP and PAGE DOWN

Operate your display software program (on a connected PC) which responds to page up/down commands (like Microsoft PowerPoint). See "[Remote paging operations](#)" on page 42 for details.

Warning messages on the back of the remote control

The laser beam is visible. It is necessary to press and hold **LASER** for continuous output.

The laser pointer is not a toy. Parents should be mindful of the dangers of laser energy and keep this remote control out of the reach of children.

Refer to the warning labels on the back of your remote control for safe operation on the laser pointer.

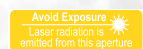

Remote control effective range

Infra-Red (IR) remote control sensors are located on the front and the back of the projector. The remote control must be held at an angle within 30 degrees perpendicular to the projector's IR remote control sensors to function correctly. The distance between the remote control and the sensors should not exceed 6 meters (~ 20 feet).

Make sure that there are no obstacles between the remote control and the IR sensors on the projector that might obstruct the infra-red beam.

- **Operating the projector from the front**

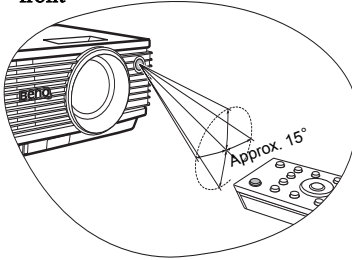

- **Operating the projector from the rear**

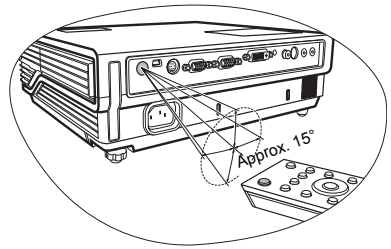

Remote control batteries

1. To open the battery cover, turn the remote control over to view its back, push on the finger grip on the cover and slide it up in the direction of the arrow as illustrated. The cover will slide off.
2. Remove any existing batteries (if necessary) and install two AAA batteries observing the battery polarities as indicated in the base of the battery compartment. Positive (+) goes to positive and negative (-) goes to negative.
3. Refit the cover by aligning it with the base and sliding it back down into position. Stop when it clicks into place.

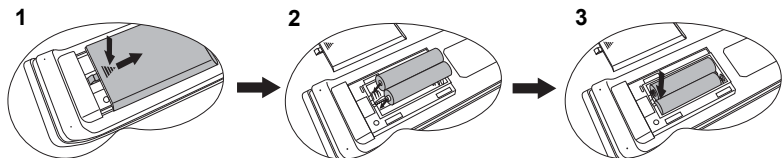

- ⚠ • **Avoid leaving the remote control and batteries in an excessive heat or humid environment like the kitchen, bathroom, sauna, sunroom or in a closed car.**
- **Replace only with the same or equivalent type recommended by the battery manufacturer.**
- **Dispose of the used batteries according to the manufacturer's instructions and local environment regulations for your region.**
- **Never throw the batteries into a fire. There may be danger of an explosion.**
- **If the batteries are dead or if you will not be using the remote control for an extended period of time, remove the batteries to avoid damage to the remote control from possible battery leakage.**

3 Positioning your projector

Choosing a location

Your projector is designed to be installed in one of four possible installation locations:

1. Table in front of screen;
2. Ceiling in front of screen;
3. Table at rear of screen;
4. Ceiling at rear of screen.

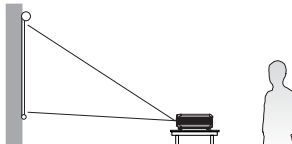
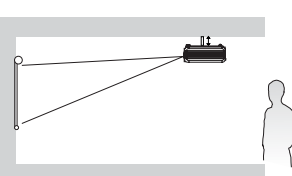
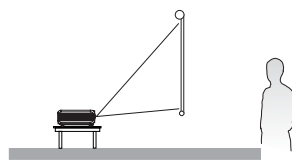
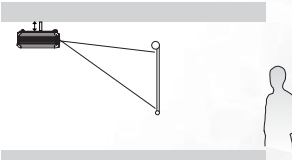
<p>1. Front Table Select this location with the projector placed near the floor in front of the screen. This is the most common way to position the projector for quick setup and portability.</p>	 A diagram showing a projector on a small table in front of a screen. A person is standing to the right, looking at the screen. Lines from the projector's lens show the projection area on the screen.
<p>2. Front Ceiling Select this location with the projector suspended upside-down from the ceiling in front of the screen. Purchase the BenQ Projector Ceiling Mounting Kit from your dealer to mount your projector on the ceiling. Set Front Ceiling in the System Setup: Basic > Projector Position menu after you turn the projector on.</p>	 A diagram showing a projector mounted upside-down on the ceiling in front of a screen. A person is standing to the right, looking at the screen. Lines from the projector's lens show the projection area on the screen.
<p>3. Rear Table Select this location with the projector placed near the floor behind the screen. Note that a special rear projection screen is required. Set Rear Table in the System Setup: Basic > Projector Position menu after you turn the projector on.</p>	 A diagram showing a projector on a small table behind a screen. A person is standing to the right, looking at the screen. Lines from the projector's lens show the projection area on the screen.
<p>4. Rear Ceiling Select this location with the projector suspended upside-down from the ceiling behind the screen. Note that a special rear projection screen and the BenQ Projector Ceiling Mounting Kit are required for this installation location. Set Rear Ceiling in the System Setup: Basic > Projector Position menu after you turn the projector on.</p>	 A diagram showing a projector mounted upside-down on the ceiling behind a screen. A person is standing to the right, looking at the screen. Lines from the projector's lens show the projection area on the screen.

Your room layout or personal preference will dictate which installation location you select. Take into consideration the size and position of your screen, the location of a suitable power outlet, as well as the location and distance between the projector and the rest of your equipment.

If you use the projector with wireless function, there's no need to worry about data cable connections. This gives you the flexibility to site the projector anywhere in the room up to a range of 20m away from your notebook, and switch between presentations on different notebooks instantly without fiddling with cables

To use the wireless function, you need to install a BenQ wireless module to the projector and enable your notebook/desktop PC with wireless connection. For more information, refer to "[Wireless connection \(optional\)](#)" on page 22.

Safety instructions for ceiling mounting of the projector

We want you to have a pleasant experience using your BenQ projector, so we need to bring this safety matter to your attention to prevent damage to person and property.

If you intend to mount your projector on the ceiling, we strongly recommend that you use a proper fitting BenQ projector ceiling mount kit and that you ensure it is securely and safely installed.

If you use a non-BenQ brand projector ceiling mount kit, there is a safety risk that the projector may fall from the ceiling due to an improper attachment through the use of the wrong gauge or length screws.

You can purchase a BenQ projector ceiling mount kit from the place you purchased your BenQ projector. BenQ recommends that you also purchase a separate Kensington lock compatible security cable and attach it securely to both the Kensington lock slot on the projector and the base of the ceiling mount bracket. This will perform the secondary role of restraining the projector should its attachment to the mounting bracket become loose.

Obtaining a preferred projected image size

The distance from the projector lens to the screen, the zoom setting, and the video format each factors in the projected image size.

The maximum (native) resolution of the projector is 1024 x 768 pixels, which is a 4 to 3 aspect ratio (expressed as 4:3). To be able to project a complete 16:9 (widescreen) aspect ratio image, the projector can resize and scale a widescreen image to the projector's native aspect width. This will result in a proportionally smaller height equivalent to 75% of the projector's native aspect height.

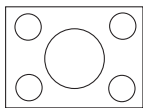

4:3 aspect image in a 4:3 aspect display area

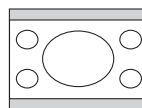

16:9 aspect image scaled to a 4:3 aspect display area

Thus, a 16:9 aspect image will not utilize 25% of the height of a 4:3 aspect image displayed by this projector. This will be seen as darkened (unlit) bars along the top and bottom (vertical 12.5% height respectively) of the 4:3 projection display area whenever displaying a scaled 16:9 aspect image in the vertical center of the 4:3 projection display area.

When determining the position of your projector, you should consider its intended use and input signal aspect ratios. All inputs (other than composite Video being fed a 16:9 aspect signal) will display in a 4:3 aspect ratio (and will require an additional 33% display height than that of the scaled 16:9 aspect image projection area).

IMPORTANT: Do not select a permanent projector position based upon a 16:9 projection if you will ever need to select an input (other than composite Video being fed a 16:9 aspect signal).

The projector should always be placed horizontally level (like flat on a table), and positioned directly perpendicular (90° right-angle square) to the horizontal center of the screen. This prevents image distortion caused by angled projections (or projecting onto angled surfaces).

The modern digital projector does not project directly forward (like older style reel-to-reel film projectors did). Instead, digital projectors are designed to project at a slightly upward angle above the horizontal plane of the projector. This is so that they can be readily placed on a table and will project forward and upwards onto a screen positioned so that the bottom edge of the screen is above the level of the table (and everyone in the room can see the screen).

If the projector is mounted on a ceiling, it must be mounted upside-down so that it projects at a slightly downward angle.

You can see from the diagram on page 21, that this type of projection causes the bottom edge of the projected image to be vertically offset from the horizontal plane of the projector. When ceiling mounted, this refers to the top edge of the projected image.

If the projector is positioned further away from the screen, the projected image size increases, and the vertical offset also increases proportionately.

When determining the position of the screen and projector, you will need to account for both the projected image size and the vertical offset dimension, which are directly proportional to the projection distance.

BenQ has provided a table of 4:3-aspect-ratio screen sizes to assist you in determining the ideal location for your projector. There are two dimensions to consider, the perpendicular horizontal distance from the center of the screen (projection distance), and the vertical offset height of the projector from the horizontal edge of the screen (offset).

How to determine the position of the projector for a given screen size

1. Select your screen size.
2. Refer to the table and find the closest match to your screen size in the left columns labelled '4:3 Screen Diagonal'. Using this value, look across this row to the right to find the corresponding average distance from screen value in the column labelled 'Average'. This is the projection distance.
3. On that same row, look across to the right column and make note of the vertical Offset value. This will determine the final vertical offset placement of the projector in relation to the edge of the screen.
4. The recommended position for the projector is aligned perpendicular to the horizontal center of the screen, at the distance from the screen determined in step 2 above, and offset by the value determined in step 3 above.

For example, if you are using a 120 inch screen, the average projection distance is 4432 mm and with a vertical offset of 302 mm.

If you place the projector in a different position (to that recommended), you will have to tilt it down or up to center the image on the screen. In these situations, some image distortion will occur. Use the Keystone function to correct the distortion. See "[Correcting keystone](#)" on [page 35](#) for details.

How to determine the recommended screen size for a given distance

This method can be used for situations where you have purchased this projector and would like to know what screen size will fit in your room.

The maximum screen size is limited by the physical space available in your room.

1. Measure the distance between the projector and where you want to position the screen. This is the projection distance.
2. Refer to the table and find the closest match to your measurement in the average distance from screen column labelled 'Average'. Check that your measured distance is between the min and max distances listed on either side of the average distance value.
3. Using this value, look across that row to the left to find the corresponding screen diagonal listed in that row. That is the projected image size of the projector at that projection distance.
4. On that same row, look across to the right column and make note of the vertical Offset value. This will determine the final placement of the screen in relation to the horizontal plane of the projector.

For example, if your measured projection distance was 4.8m (4800mm), the closest match in the Average column is 5089 mm. Looking across this row shows that a 3500 mm (3.5 m) screen is required. If you can only obtain imperial sized screens, the listed screen sizes on either side of the 3.5 m screen are the 10' and 12' screens.

Checking the min and max projection distance values for these screen sizes, indicates that the 4.8 m measured projection distance will need to be reduced to fit the 10' size screen, or increased to fit the 12' size screen. The projector can be adjusted (using the zoom control) to display on these different screen sizes at those projection distances. Be aware that these different screens have different vertical offset values.

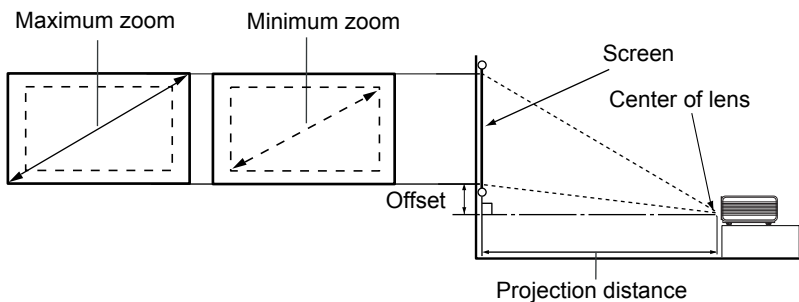

4:3 Screen Diagonal			Distance from Screen in mm			Vertical Offset in mm
Feet	Inches	mm	Min length (with max. zoom)	Average	Max length (with min. zoom)	
4	48	1219	1652	1773	1893	121
		1500	2033	2181	2329	149
5	60	1524	2065	2216	2367	151
		1829	2479	2659	2840	181
6	72	2000	2710	2908	3106	198
		2134	2892	3102	3313	211
8	96	2438	3305	3546	3787	241
		2500	3389	3635	3882	248
9	108	2743	3718	3989	4260	272
		3000	4066	4362	4659	297
10	120	3048	4131	4432	4733	302
		3500	4743	5089	5435	347
12	144	3658	4957	5318	5680	362
		4000	5421	5816	6212	396
15	180	4572	6196	6648	7100	453
		5000	6776	7270	7765	495
18	216	5486	7436	7978	8520	543
		6000	8132	8725	9317	594
25	300	7620	10327	11080	11833	754

☞ There is 3% tolerance among these numbers due to optical component variations. BenQ recommends that if you intend to permanently install the projector, you should physically test the projection size and distance using the actual projector in situ before you permanently install it, so as to make allowance for this projector's optical characteristics. This will help you determine the exact mounting position so that it best suits your installation location.

4 Connection

When connecting a signal source to the projector, be sure to:

1. Turn all equipment off before making any connections.
2. Use the correct signal cables for each source.
3. Ensure the cables are firmly inserted.

 In the connections shown below, some cables may not be included with the projector (see ["Shipping contents" on page 10](#)). They are commercially available from electronics stores.

Wireless connection (optional)

The Wireless module allows for simultaneous wireless connectivity to multiple computers which are wireless enabled. This saves you from having to swap data cables between the projector and different computers during a presentation. Wireless connectivity is most suitable for situations where multiple presenters with separate notebooks are required to seamlessly present individual presentations, like in meetings, conferences, lectures and, classrooms.

The Wireless module connects and attaches to the rear of the projector through the DVI-I socket.

 While the Wireless module is attached to the projector, you cannot use the DVI-I socket for DVI cable connections.

Even though the projector may be using a wireless data connection, it still requires physical connection to a power outlet using its power cable.

You can purchase a BenQ wireless module from BenQ retailers. You should attach the wireless module to the projector before you connect any other cables. Refer to the user's manual enclosed with the wireless module for connection and operation details.

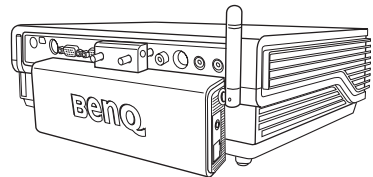

Projector with the wireless module

Cable connection

Connecting a computer or monitor

Connecting a computer

The projector provides a VGA and DVI input sockets that allow you to connect it to both IBM® compatibles and Macintosh® computers. A Mac adapter (an optional accessory) is needed if you are connecting legacy version Macintosh computers.

Additionally, you can also connect the projector to a computer via the USB cable so you can perform paging operations of the application on the PC or notebook. (see ["Remote paging operations" on page 42](#)).

To connect the projector to a notebook or desktop computer (either through a VGA cable or VGA to DVI-A cable):

<ul style="list-style-type: none"> • With a VGA cable: 	<ul style="list-style-type: none"> • With a VGA to DVI-A cable:
<ol style="list-style-type: none"> 1. Take the supplied VGA cable and connect one end to the D-Sub output socket of the computer. 2. Connect the other end of the VGA cable to the D-SUB/COMP. IN signal input socket on the projector. 	<ol style="list-style-type: none"> 1. Take a VGA to DVI-A cable and connect the VGA end to the D-Sub output socket of the computer. 2. Connect the DVI end of the VGA to DVI-A cable to the DVI-I signal input socket on the projector.
<ol style="list-style-type: none"> 3. If you wish to use the remote paging function (see "Remote paging operations" on page 42), take the supplied USB cable and connect the larger end to the USB port of the computer, and the smaller end to the USB socket on the projector. 4. If you wish to make use of the projector (mixed mono) speaker in your presentations, take a suitable audio cable and connect one end of the cable to the audio output socket of the computer, and the other end to the AUDIO IN socket of the projector. 5. If you wish, you can use another suitable audio cable and connect one end of the cable to the AUDIO OUT socket of the projector, and the other end to your external speakers (not supplied). <p>The audio output is a mixed mono signal. Once connected, the audio can be controlled by the remote control (MUTE) or projector On-Screen Display (OSD) menus. See "Audio Settings" on page 50 for details.</p>	

The final connection path should be like that shown in the following diagram:

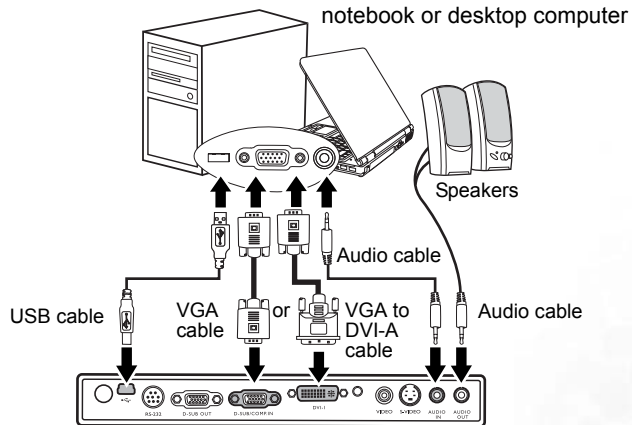

• Many notebooks do not turn on their external video ports when connected to a projector. Usually a key combo like FN + F3 or CRT/LCD key turns the external display on/off. Locate a function key labeled CRT/LCD or a function key with a monitor symbol on the notebook. Press FN and the labeled function key simultaneously. Refer to your notebook's documentation to find your notebook's key combination.

Connecting a monitor

If you want to view your presentation close-up on a monitor as well as on the screen, you can connect the D-SUB OUT signal output socket on the projector to an external monitor with a VGA or VGA to DVI-A cable by following the instructions below.

To connect the projector to a monitor (either through a VGA cable or VGA to DVI-A cable):

<ul style="list-style-type: none"> With a VGA cable: 	<ul style="list-style-type: none"> With a VGA to DVI-A cable: <p>Note: Your monitor must be equipped with a DVI input socket.</p>
<ol style="list-style-type: none"> Connect the projector to a computer as described in "Connecting a computer" on page 22. The D-SUB output only works when an appropriate D-SUB input is made to the projector. Be sure the projector is connecting with the computer using the D-SUB IN socket, not the DVI-I socket. 	
<ol style="list-style-type: none"> Take a suitable VGA cable (only one supplied) and connect one end of the cable to the D-Sub input socket of the video monitor. Connect the other end of the cable to the D-SUB OUT socket on the projector. 	<ol style="list-style-type: none"> Take a VGA to DVI-A cable and connect the DVI end of the cable to the DVI input socket of the video monitor. Connect the VGA end of the cable to the D-SUB OUT socket on the projector.

The final connection path should be like that shown in the following diagram:

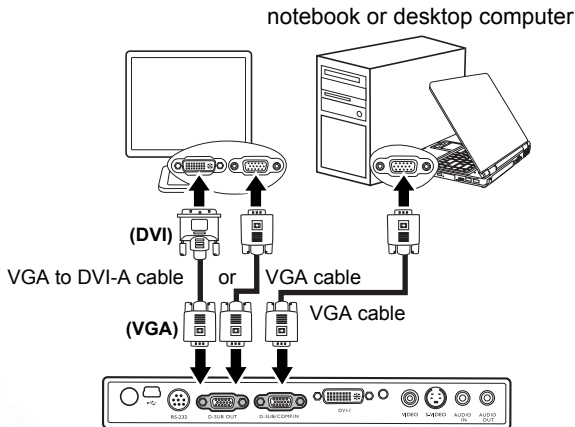

Connecting Video source devices

This section describes how to connect the projector to Video source devices using video cables. Video cable connections are recommended for Video presentations.

 **This projector also supports data (graphic) "PC" connection using wireless function. Wireless connection is not recommended for Video presentations. See ["Wireless connection \(optional\)" on page 22](#).**

You can connect your projector to various Video source devices that provide any one of the following output sockets:

- DVI
- Component Video
- S-Video
- Video (composite)

You need only connect the projector to a Video source device using just one of the above connecting methods, however each provides a different level of video quality. The method you choose will most likely depend upon the availability of matching terminals on both the projector and the Video source device as described below:

Best video quality

The best available video connection method is DVI. If your source device is equipped with a DVI socket, based on the type of DVI connector you have, you can enjoy digital or high-end analog video quality.

See ["Connecting a DVI source device" on page 26](#) for how to connect the projector to a DVI source device and other details.

If no DVI source is available, the next best video signal is Component Video (not to be confused with composite Video). Digital TV tuners and DVD players output Component Video natively, so if available on your devices, they should be your connection method of choice in preference to S-Video or (composite) Video.

See ["Connecting a Component Video source device" on page 27](#) for how to connect the projector to a component video device.

Better video quality

The S-Video method provides a better quality analog video than standard composite Video. If you have both composite Video and S-Video output terminals on your Video source device, you should elect to use the S-Video option.

See ["Connecting an S-Video source device" on page 29](#) for how to connect the projector to an S-Video device.

Least video quality

Composite Video is an analog video and will result in a perfectly acceptable, but less than optimal result from your projector, being the least video quality of the available methods described here.

See ["Connecting a composite Video source device" on page 30](#) for how to connect the projector to a composite Video device.

Connecting Audio

The projector has a built-in mono speaker which is designed to provide basic audio functionality accompanying data presentations for business purposes only. It is not designed for, nor intended for stereo audio reproduction use as might be expected in home theatre or home cinema applications. Any stereo audio input (if provided), is mixed into a common mono audio output through the projector speaker.

If you wish, you can make use of the projector (mixed mono) speaker in your presentations, and also connect separate amplified speakers to the Audio Out socket of the projector. The audio output is a mixed mono signal and controlled by the projector Volume and Mute settings.

If you have a separate sound system, you will most likely want to connect the audio output of your Video source device to that sound system, instead of to the mono audio projector.

The audio connections illustrated in the following sections are provided for informational purposes only. You need not connect audio to the projector if there is an alternate sound system available, or if audio is not required.

Connecting a DVI source device

The projector provides a DVI-I input socket that allows you to connect it to a DVI source device like a DVD player, or a VGA output device like a notebook or desktop computer.

There are three types of DVI connectors: DVI-A, DVI-D, and DVI-I. The DVI-I socket is an integrated connector which supports both formats: DVI-A, and DVI-D.

DVI-A format is used to carry a DVI signal to an analog (VGA) display, or vice-versa. Although some signal quality is lost from the signal conversion, it still transmits higher picture quality than a standard VGA connection.

DVI-D format is used to directly carry a digital signal to a digital display without signal conversion. The pure digital connection provides faster and higher image quality than an analog connection, due to the nature of the digital format.

DVI-A and DVI-D formats are non-interchangeable. You cannot connect a DVI-A format connector to DVI-D equipment and visa-versa. Make sure you know which kind of format your equipment is fitted with before you purchase any cables. Or you can purchase a DVI-I cable which will be more useful in any type of DVI connection situation.

Examine your source device to determine if it has an unused DVI or VGA (D-Sub) output socket available:

- If so, you can continue with this procedure.
- If not, you will need to reassess which method you can use to connect to the device.

To connect the projector to a DVI source device or a computer:

 For information on connecting a DVI source device to a computer through a VGA to DVI-A cable, see ["Connecting a computer" on page 22](#).

1. Take the DVI (DVI-D or DVI-I) cable and connect one end to the DVI output socket of the DVI source device.
2. Connect the other end of the cable to the DVI-I signal input socket on the projector.
3. If you wish to make use the projector (mixed mono) speaker, take a suitable audio cable and connect one end of the cable to the audio output sockets of the video device, and the other end to the AUDIO IN socket of the projector.
4. If you wish, you can use another suitable audio cable and connect one end of the cable to the AUDIO OUT socket of the projector, and the other end to your external speakers (not supplied).

The audio output is a mixed mono signal. Once connected, the audio can be controlled by the remote control (**MUTE**) or projector On-Screen Display (OSD) menus. See ["Audio Settings" on page 50](#) for details.

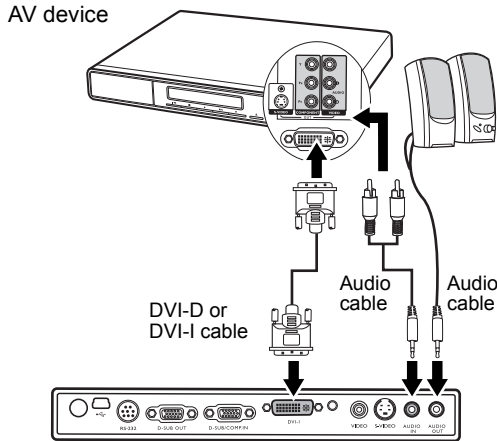

Connecting a Component Video source device

Examine your Video source device to determine if it has a set of unused Component Video output sockets available:

- If so, you can continue with this procedure.
- If not, you will need to reassess which method you can use to connect to the device.

To connect the projector to a Component Video source device through a Component Video to VGA (D-Sub) adaptor cable:

1. Take the Component Video to VGA (D-Sub) adaptor cable and connect the end with 3 RCA type connectors to the Component Video output sockets of the Video source device. Match the color of the plugs to the color of the sockets; green to green, blue to blue; and red to red.
2. Connect the other end of the Component Video to VGA (D-Sub) adaptor cable (with a D-Sub type connector) to the D-SUB/COMP. IN socket on the projector.

3. If you wish to make use the projector (mixed mono) speaker, take a suitable audio cable and connect one end of the cable to the audio output sockets of the video device, and the other end to the AUDIO IN socket of the projector.
4. If you wish, you can use another suitable audio cable and connect one end of the cable to the Audio OUT socket of the projector, and the other end to your external speakers (not supplied).

The audio output is a mixed mono signal. Once connected, the audio can be controlled by the remote control (**MUTE**) or projector On-Screen Display (OSD) menus. See "[Audio Settings](#)" on [page 50](#) for details.

The final connection path should be like that shown in the following diagram:

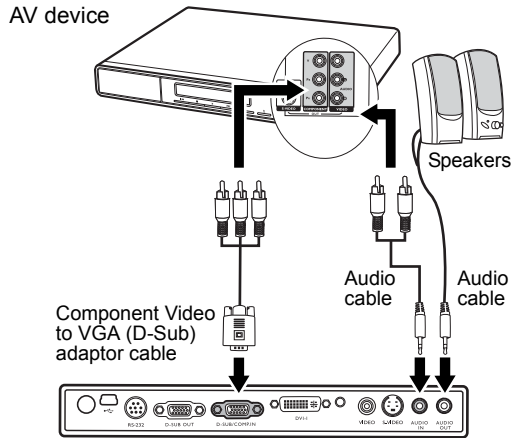

If you connect the projector to a Digital TV (DTV) tuner, the following standards are supported:

- 480i
- 576i
- 720p (50/ 60 Hz)
- 480p
- 576p
- 1080i (50/ 60 Hz)

- ☞ **The projector is only capable of playing mixed mono audio, even if a stereo audio input is connected. See "[Connecting Audio](#)" on [page 26](#) for details.**
- **Component Video is the only video input that delivers native 16:9 aspect ratio picture.**
- **If the selected video image is not displayed after the projector is turned on and the correct video source has been selected, check that the Video source device is turned on and operating correctly. Also check that the signal cables have been connected correctly.**

Connecting an S-Video source device

Examine your Video source device to determine if it has an unused S-Video output socket available:

- If so, you can continue with this procedure.
- If not, you will need to reassess which method you can use to connect to the device.

To connect the projector to an S-Video source device:

1. Take a S-Video cable and connect one end to the S-Video output socket of the Video source device.
2. Connect the other end of the S-Video cable to the S-VIDEO socket on the projector.
3. If you wish to make use of the projector (mixed mono) speaker, take a suitable audio cable and connect one end of the cable to the audio output sockets of the video device, and the other end to the AUDIO IN socket of the projector.
4. If you wish, you can use another suitable audio cable and connect one end of the cable to the Audio OUT socket of the projector, and the other end to your external speakers (not supplied).

The audio output is a mixed mono signal. Once connected, the audio can be controlled by the remote control (**MUTE**) or projector On-Screen Display (OSD) menus. See "[Audio Settings](#)" on [page 50](#) for details.

The final connection path should be like that shown in the following diagram:

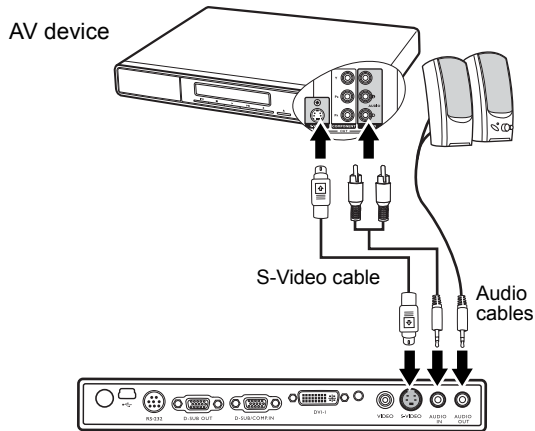

- ☞ • The projector is only capable of playing mixed mono audio, even if a stereo audio input is connected. See "[Connecting Audio](#)" on [page 26](#) for details.
- If the selected video image is not displayed after the projector is turned on and the correct video source has been selected, check that the Video source device is turned on and operating correctly. Also check that the signal cables have been connected correctly.
- If you have already made a Component Video connection between the projector and this S-Video source device using Component Video connections, you need not connect to this device using an S-Video connection as this makes an unnecessary second connection of poorer picture quality. See "[Connecting Video source devices](#)" on [page 25](#) for details.

Connecting a composite Video source device

Examine your Video source device to determine if it has a set of unused composite Video output sockets available:

- If so, you can continue with this procedure.
- If not, you will need to reassess which method you can use to connect to the device.

To connect the projector to an composite Video source device:

1. Take the Video cable and connect one end to the composite Video output socket of the Video source device.
2. Connect the other end of the Video cable to the VIDEO socket on the projector.
3. If you wish to make use the projector (mixed mono) speaker, take a suitable audio cable and connect one end of the cable to the audio output sockets of the video device, and the other end to the AUDIO IN socket of the projector.
4. If you wish, you can use another suitable audio cable and connect one end of the cable to the Audio OUT socket of the projector, and the other end to your external speakers (not supplied).

The audio output is a mixed mono signal. Once connected, the audio can be controlled by the remote control (**MUTE**) or projector On-Screen Display (OSD) menus. See "[Audio Settings](#)" on [page 50](#) for details.

The final connection path should be like that shown in the following diagram:

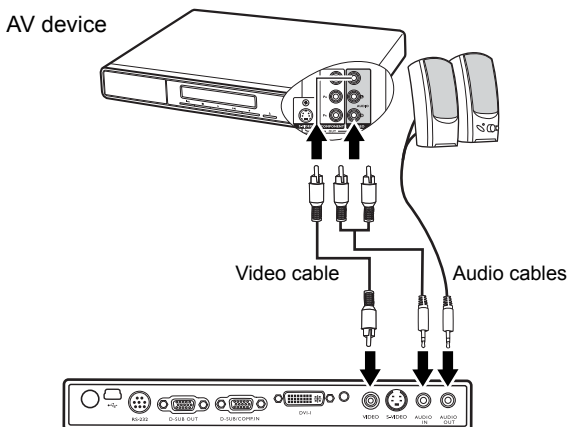

- ☞ • The projector is only capable of playing mixed mono audio, even if a stereo audio input is connected. See "[Connecting Audio](#)" on [page 26](#) for details.
- If the selected video image is not displayed after the projector is turned on and the correct video source has been selected, check that the Video source device is turned on and operating correctly. Also check that the signal cables have been connected correctly.
- You need only connect to this device using a composite Video connection if Component Video and S-Video inputs are unavailable for use. See "[Connecting Video source devices](#)" on [page 25](#) for details.

5 Operation

Start up

1. Plug the power cord into the projector and into a wall socket. Turn on the wall socket switch (where fitted). Check that the **Power indicator** on the projector lights orange after power has been applied.
2. Remove the lens cap. If it is left on, it could become deformed due to the heat produced by the projection lamp.

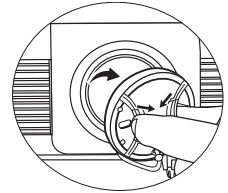
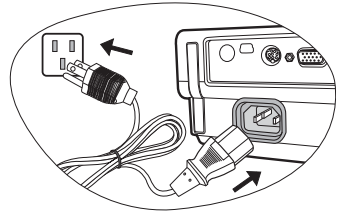

3. Press and hold (for 2 seconds) **Power** on the projector or remote control to start the projector. The **Power indicator light** flashes green and stays green when the projector is on. The start up procedure takes about 30 seconds after pressing **Power**. In the later stage of start up, a default BenQ logo is projected. (If necessary) Rotate the focus ring to adjust the image clearness.

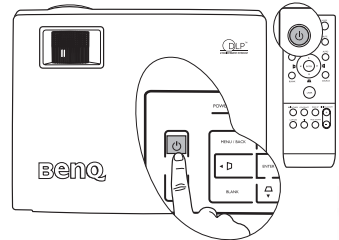

If the projector is still hot from previous activity, it will run the cooling fan for approximately 90 seconds before energizing the lamp.

4. If you are prompted for a password, press the arrow buttons to enter a six digit password. See "[Utilizing the password function](#)" on page 32 for details.
5. Switch all of the connected equipment on.
6. The projector will start to search for input signals. The current input source being scanned displays in the upper left corner of the screen. If the projector doesn't detect a valid signal, the searching message will continue displaying until an input source signal is found.

You can also press **SOURCE** on the projector or remote control to select your desired input signal. See "[Switching input signal](#)" on page 34 for details.

If the frequency/resolution of the input signal exceeds the projector's operating range, you will see the message 'Out of Range' displayed on a blank screen. Please change to an input signal which is compatible with the projector's resolution or set the input signal to a lower setting. See "[Timing chart](#)" on page 65 for details.

Utilizing the password function

For security purposes and to help prevent unauthorized use, the projector includes an option for setting up password security. The password can be set through the On-Screen Display (OSD) menu. For details of the OSD menu operation, please refer to "Using the menus" on page 46.

WARNING: You will be inconvenienced if you activate the password functionality and subsequently forget the password. Print out this manual (if necessary) and write the password you used in this manual, and keep the manual in a safe place for later recall.

Setting a password

Once a password has been set, the projector cannot be used unless the correct password is entered every time the projector is started.

1. Open the OSD menu and go to **SYSTEM SETUP: Advanced > Security Settings**. Press **ENTER**. Highlight **Password** and select **On** by pressing **◀ Left** or **▶ Right**.
2. A prompt will display on the screen.
3. As pictured to the right, the four arrow buttons (**▲ Up**, **▶ Right**, **▼ Down**, **◀ Left**) respectively represent 4 digits (1, 2, 3, 4). According to the password you desire to set, press the arrow buttons to enter six digits for the password. Once the password is set, the OSD menu returns to the Security Settings page.



IMPORTANT: The digits being input will display as asterisks on-screen. Write your selected password down here in this manual in advance or right after the password is entered so that it is available to you should you ever forget it.

Password: _____

Keep this manual in a safe place.

4. To leave the OSD menu, press **MENU/BACK** twice.

If you forget the password

If the password function is activated, you will be asked to enter the six digit password every time you turn on the projector. If you enter the wrong password, the password error message as pictured to the right displays lasting for three seconds, and the INPUT PASSWORD message follows. You can retry by entering another six-digit password, or if you did not record the password in this manual, and you absolutely do not remember it, you can use the password recall procedure. See "Entering the password recall procedure" on page 33 for details.

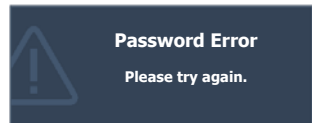

If you enter an incorrect password 5 times in succession, the projector will automatically shut down in a short time.

Entering the password recall procedure

Press and hold **AUTO** on the projector or remote control for 3 seconds. The projector will display a coded number on the screen. Write down the number and turn off your projector. Seek help from the local BenQ service center to decode the number. You may be required to provide proof of purchase documentation to verify that you are an authorized user of the projector.

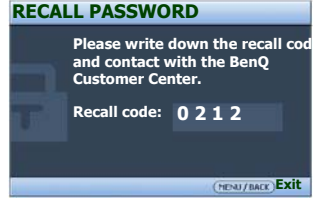

Changing the password

1. Open the OSD menu and go to the **SYSTEM SETUP: Advanced > Security Settings > Change Password** menu.
2. Press **ENTER**, the message 'INPUT CURRENT PASSWORD' displays.
3. Enter the old password.
 - i. If the password is correct, another message 'INPUT NEW PASSWORD' displays.
 - ii. If the password is incorrect, the password error message displays lasting for three seconds, and the message 'INPUT CURRENT PASSWORD' displays for your retry. You can either press **MENU/BACK** to cancel the change or try another password.

3. Enter a new password.

IMPORTANT: The digits being input will display as asterisks on-screen. Write your selected password down here in this manual in advance or right after the password is entered so that it is available to you should you ever forget it.

Password: _ _ _ _ _

Keep this manual in a safe place.

4. Confirm the new password by re-entering the new password.
5. You have successfully assigned a new password to the projector. Remember to enter the new password next time the projector is started.
6. To leave the OSD menu, press **MENU/BACK** twice.

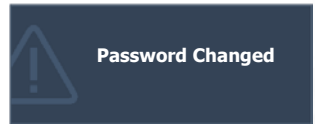

Disabling the password function

To disable password protection, go back to the **SYSTEM SETUP: Advanced > Security Settings > Password** menu after opening the OSD menu system. Select **Off** by pressing **◀ Left** or **▶ Right**. The message 'INPUT PASSWORD' displays. Enter the current password.

- i. If the password is correct, the OSD menu returns to the Security Settings page with 'Off' shown in the row of Password. You will not have to enter the password next time when turning on the projector.
- ii. If the password is incorrect, the password error message displays lasting for three seconds, and the message 'INPUT PASSWORD' displays for your retry. You can either press **MENU/BACK** to cancel the change or try another password.

Note that though the password function is disabled, you need to keep the old password in hand should you ever need to re-activate the password function by entering the old password.

Switching input signal

The projector can be connected to multiple devices at the same time. However, it can only display one full screen at a time. To cycle through the available input sources, press **SOURCE** on the projector or remote control. A source selection bar displays. You can manually press **SOURCE** repeatedly until your desired signal is selected or let the projector automatically search for the available signal. Once detected, the selected source information will display at the upper left corner of the screen for 3 seconds. If there is multiple equipment connected to the projector, you can press the button again to search for another signal.

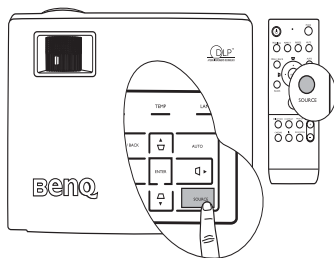

Be sure the **Auto Source Detection** function in the **SOURCE** menu is activated if you want the projector to automatically search the signals. See "[Auto Source Detection](#)" on page 49 for details.

The projector features PIP function which allows 2 different signals to be displayed at the same time. See "[PIP \(Picture In Picture\) operation](#)" on page 41 for details.

The brightness level of the projected image will change accordingly when you switch between different input signals. Data (graphic) "PC" presentations using mostly static images are generally brighter than "Video" using mostly moving images (movies).

The input signal type effects the options available for the Application Mode. See "[Selecting an application mode](#)" on page 38 for details.

Adjusting the projected image

Adjusting the projection angle

The projector is equipped with 1 quick-release adjuster foot and 1 rear adjuster foot. These adjusters change the image height and projection angle. To adjust the projector:

1. Press the quick-release button and lift the front of the projector. Once the image is positioned where you want it, release the quick-release button to lock the foot in position.

 **Do not look into the lens while the lamp is on. The strong light from the lamp may cause damage to your eyes.**

Be careful when you press the adjuster button as it is close to the exhaust vent where hot air comes from.

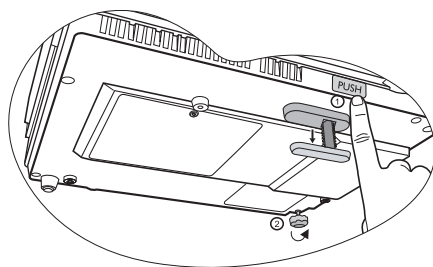

2. Screw the rear adjuster foot to fine tune the horizontal angle. To retract the foot, hold up the projector while pressing the quick-release button, then slowly lower the projector. Screw the rear adjuster foot in a reverse direction.

If the projector is not placed on a flat surface or the screen and the projector are not perpendicular to each other, the projected image becomes trapezoidal. To correct this situation, adjust the value of Keystone in the **DISPLAY** menu, on the projector control panel, or remote control. See "[Correcting keystone](#)" on page 35 for details.

Auto-adjusting the image

In some cases, you may need to optimize the picture quality. To do this, press **AUTO** on the projector or remote control. Within 3 seconds, the built-in Intelligent Auto Adjustment function will re-adjust the values of Frequency and Clock to provide the best picture quality.

The current source information will be displayed in the upper left corner of the screen for 3 seconds.

 **The screen will be blank while AUTO is functioning.**

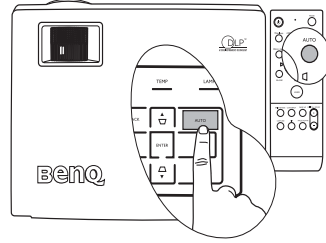

Fine-tuning the image size and clarity

1. Adjust the projected image to the size that you need using the zoom ring.
2. Then sharpen the image by rotating the focus ring.

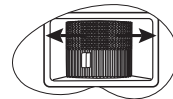
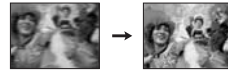
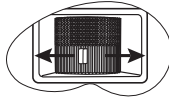

Searching for details on the projected image

If you need to find the details on the projected image, press **D. ZOOM +** on the remote control, the center of the image will be magnified. When the **+** button is pressed again, the image is further magnified. Use the directional arrows (**▲**, **▼**, **◀**, **▶**) on the projector or remote control to navigate the image. Pressing **D. ZOOM -** reduces the size of the image. When the **-** button is pressed again, the image is further reduced until it is restored to the original size.

The **Digital Zoom** and **Pan** functions are also accessible in the **DISPLAY** menu.

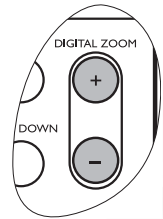

Correcting keystone

Keystoning occurs when the projector is not perpendicular to the screen and is where the projected image displays visible as a trapezoid shape like either of the following:

- Two parallel sides (left and right, or top and bottom) but is noticeably wider on either side.
- No parallel sides.

To correct the image's shape, you can perform the following steps.

1. Adjust the projection angle. Move the projector to be in front of the center of the screen with the base of the lens level with the top or bottom edge of the screen.
2. If the image is still distorted, or the projector is unable to be positioned as described above, you will need to manually correct the image following ONE of these steps.
 - Press one of the Keystone/Arrow buttons (**◻** / **▲**, **◻** / **◀**, **◻** / **▼**, **◻** / **▶**) on the projector or remote control to display the Keystone correction page. Press

the button whose keystone icon is similar to the shape of the projected image. Continue pressing the same button or press the other buttons until you are satisfied with the shape.

- Press **MENU/BACK** on the projector or remote control. Go to the **DISPLAY > Keystone** menu and press **ENTER** to display the Keystone correction page. Press one of the Keystone/Arrow buttons (◁ / ▲, ▷ / ▼, ▽ / ▾, ◂ / ▸) on the projector or remote control whose Keystone icon is similar to the shape of the projected image. Continue pressing the same button or press the other buttons until you are satisfied with the shape.



The values on the lower portion of the page change while pressing. When the values reach their maximum or minimum with repeated button presses, the image's shape will stop changing. You will not be able to change the image further in that direction.

- Two parallel sides (left and right, or top and bottom) but is noticeably wider on either side

- Press ◁ / ▲ or
- Go to the **DISPLAY > Keystone** menu. Enter the Keystone correction page and press ◁ / ▲ repeatedly until the image's shape becomes square.

- Press ▽ / ▾ or
- Go to the **Display > Keystone** menu. Enter the Keystone correction page and press ▽ / ▾ repeatedly until the image's shape becomes square.

- No parallel sides

1. Press ◂ / ▸ or
2. Go to the **Display > Keystone** menu. Enter the keystone correction page and press ◂ / ▸ .

3. Press ▽ / ▲ repeatedly until the image is square.

4. Press **MENU/BACK** to exit and save the settings.

Selecting the aspect ratio

The 'aspect ratio' is the ratio of the image width to the image height. Most analog TV and computers are in 4:3 ratio, which is the default for this projector, and digital TV and DVDs are usually in 16:9 ratio.

With the advent of digital signal processing, digital display devices like this projector can dynamically stretch and scale the image output to a different aspect than that of the image input source.

You can change the projected image ratio (no matter what aspect the source is) by pressing **ASPECT** on the remote control or in the **DISPLAY > Aspect Ratio** menu. Select an aspect ratio to suit the format of the video signal and your display requirements. There are four aspect ratios available:

 **In the pictures below, the black portions are inactive areas and the white portions are active areas.**

1. **Auto:** Scales an image proportionally to fit the projector's native resolution in its horizontal width. This is suitable for the incoming image which is either in 4:3 nor 16:9 and you want to make most use of the screen without altering the image's aspect ratio.
2. **Actual Size:** The image is projected as its original resolution, with no pixel conversion. For input signals with lower resolutions, the projected image will display smaller than if resized to full screen. You could adjust the zoom setting or move the projector towards the screen to increase the image size if necessary. You may also need to refocus the projector after making these adjustments.
3. **4:3:** Scales an image so that it is displayed in the center of the screen with a 4:3 aspect ratio. This is most suitable for 4:3 images like computer monitors, standard definition TV and 4:3 aspect DVD movies, as it displays them without aspect alteration.
4. **16:9:** Scales an image so that it is displayed in the center of the screen with a 16:9 aspect ratio. This is most suitable for images which are already in a 16:9 aspect, like high definition TV, as it displays them without aspect alteration.

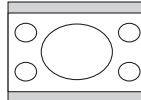
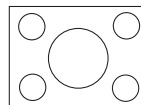
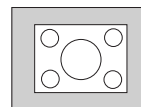
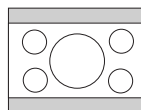

 **16:9 aspect ratio is only sourced through the Component Video input when being fed an appropriate 16:9 aspect signal. See ["Connecting a Component Video source device"](#) on page 27 and ["Obtaining a preferred projected image size"](#) on page 19 for details.**

Optimizing the image

Selecting an application mode

The projector is preset with several predefined application modes so that you can choose one to suit your operating environment and input source picture type. To select a operation mode that suits your need, press **MODE** repeatedly until your desired mode is selected. The picture modes available for different types of signals are listed below.

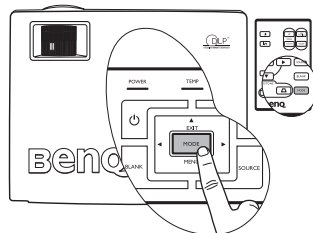

PC/DVI-A Signal Input

1. **Presentation Mode (Default):** Is designed for presentations. The brightness is emphasized in this mode to match PC and notebook coloring.
2. **Brightest Mode:** Maximizes the brightness of the projected image. This mode is suitable for environments where extra-high brightness is required, such as using the projector in well lit rooms.
3. **sRGB/Photo Mode:** Maximizes the purity of RGB colors to provide true-to-life images regardless of brightness setting. It is most suitable for viewing photos taken with an sRGB compatible and properly calibrated camera, and for viewing PC graphic and drawing applications such as AutoCAD.
4. **Gaming Mode:** Is suitable for playing PC-based games in a bright living room.
5. **Video Mode:** Is appropriate for playing movies, video clips from digital cameras or DVs through the PC input for best viewing in a blackened (little light) environment.
6. **User 1/User 2 Mode:** Recalls the settings customized based on the current available application modes. See "[Setting the User 1/User 2 mode](#)" on page 38 for details.
7. **Memory Mode:** Recalls settings made through the BRIGHTNESS and CONTRAST buttons on the remote control. Any adjustments made by the BRIGHTNESS and CONTRAST buttons will change the current application mode to Memory mode.

DVI-D/YPbPr/S-Video/Video Signal Input

1. **Cinema Mode (Default):** Is suitable for enjoying DVD movies best viewed in a blackened (little light) home cinema or lounge room environment.
2. **Movie Mode:** Is suitable for enjoying colorful movies and TV in a home darkened (not bright) lounge room lighting level environment.
3. **Gaming Mode:** Is suitable for playing gamebox-based video games in a normal living room lighting level environment.
4. **Photo Mode:** Is perfect for viewing digital photos taken in daylight with an sRGB compatible and properly calibrated camera, and for viewing Photo CDs. The color saturation and brightness are well-balanced.
5. **User 1/User 2 Mode:** Recalls the settings customized based on the current available application modes. See "[Setting the User 1/User 2 mode](#)" on page 38 for details.

Setting the User 1/User 2 mode

There are two user-definable modes if the current available application modes are not suitable for your need. You can use one of the application modes (except the User 1/2) as a starting point and customize the settings.

1. Press **MENU/BACK** to open the On-Screen Display (OSD) menu.
2. Go to the **PICTURE > Application Mode** menu.

3. Press ◀ **Left** / ▶ **Right** to select **User 1 Mode** to **User 2 Mode**.
4. Press ▼ **Down** to highlight **Reference**.
5. Press ◀ **Left** / ▶ **Right** to select an application mode that is closest to your need.
6. Press ▼ **Down** to select a menu item to be changed and adjust the value with ◀ **Left** / ▶ **Right**. See "[Fine-tuning the image quality in user modes](#)" below for details.
7. When all settings have been done, highlight **Save Settings** and press **ENTER** to store the settings.
8. The confirmation message '**Setting Saved**' displays.

Fine-tuning the image quality in user modes

According to the detected signal type, there are some user-definable functions available when User 1 or 2 mode is selected. You can make adjustments to these functions based on your needs.

Adjusting brightness

Adjust the values by pressing ◀ **Left** / ▶ **Right** on the projector or remote control.

The higher the value, the brighter the image. And lower the setting, darker the image. Adjust this control so the black areas of the image appear just as black and that detail in the dark areas is visible.



Adjusting contrast

Adjust the values by pressing ◀ **Left** / ▶ **Right** on the projector or remote control.

The higher the value, the greater the contrast. Use this to set the peak white level after you have previously adjusted the Brightness setting to suit your selected input and viewing environment.



Selecting a color temperature

Adjust the values by pressing ◀ **Left** / ▶ **Right** on the projector or remote control.

There are four color temperature* settings available.

1. **T1:** With the highest color temperature, T1 makes the image appear the most bluish white than other settings.
2. **T2:** Makes images appear bluish white.
3. **T3:** Maintains normal colorings for white.
4. **T4:** Makes images appear reddish white.

*About color temperatures:

There are many different shades that are considered to be "white" for various purposes. One of the common methods of representing white color is known as the "color temperature". A

white color with a low color temperature appears to be reddish white. A white color with a high color temperature appears to have more blue in it.

4. Other adjustments

You can find other image quality fine-tune selections in the **PICTURE** menu as well. See "[Picture menu](#)" on page 48 for details.

Operating in a high altitude environment

We recommend you use the High Altitude Mode when your environment is higher than 3200 feet above sea level, or is hotter than 40°C, or whenever the projector will be used for extended periods of time (>10 hours) without shutdown.

To activate the High Altitude Mode, go to **SYSTEM SETUP: Advanced > High Altitude Mode**, select **On** by pressing ◀ **Left** / ▶ **Right** on the projector or remote control. A confirmation message displays. Highlight **Yes** and press **ENTER**.

Operation under "High Altitude Mode" may cause a higher decibel operating noise level because of increased fan speed necessary to improve overall system cooling and performance.

If you use this projector under other extreme conditions excluding the above, it may display auto shut-down symptoms, which is designed to protect your projector from over-heating. In cases like this, you should switch to High Altitude mode to solve these symptoms. However, this is not to state that this projector can operate under any and all harsh or extreme conditions.

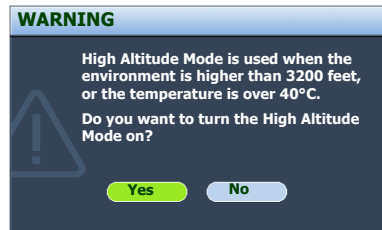

Hiding the image

In order to draw the audience's full attention to the presenter, you can use **BLANK** on the projector and remote control to hide the screen image. Press any button (except **LASER**) on the projector and remote control to restore the image. The word '**BLANK**' appears at the lower right corner of the screen while the image is hidden. When this function is activated with an audio input connected, the audio can still be heard.

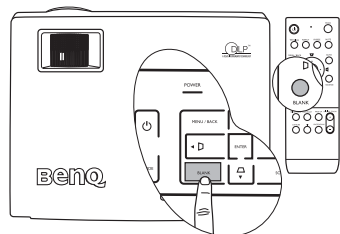

You can set a time length in the **SYSTEM SETUP: Basic > Blank Timer** menu to let the projector return the image automatically after a period of time when there is no action taken on the projector or remote control. The length of time can be set from 5 to 30 minutes in 5-minute increments.

If the preset time spans are not suitable for your personation, select **Disable**. No matter **Blank Timer** is activated or disabled, you can press any button (except **LASER**) anytime you want to restore the image.



Do not block the projection lens from projecting as this could cause the blocking object to become heated and deformed or even cause a fire.

PIP (Picture In Picture) operation

Your projector is capable of displaying images simultaneously from two input sources, which can be used to enhance your presentation in an interesting way.

The PIP functions are available only when the input source is PC and the PIP source is Video or S-Video.

1. Ensure both the PC, and Video or S-Video signals are correctly connected to the projector.
2. Display the PC image (Analog RGB) on the screen.
3. To display the PIP window, press **PIP** on the remote control or go to the **DISPLAY > PIP settings > PIP** menu, select **On** by pressing **◀ Left/ ▶ Right**.
4. To select a **PIP-Source** to be displayed, in the **DISPLAY > PIP settings > Source** menu, press **◀ Left/ ▶ Right**.
5. To change the position of the PIP image, press **◀ Left/ ▶ Right** repeatedly in the **DISPLAY > PIP settings > Position** menu until a suitable position is selected.

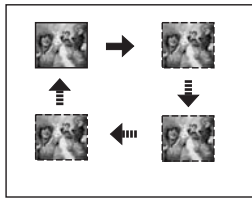

6. To resize the PIP image, press **◀ Left/ ▶ Right** once or twice in the **DISPLAY > PIP settings > Size** menu to set the PIP size as small or large.

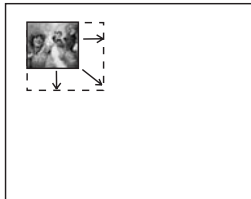

7. To adjust the PIP image quality, you can press **◀ Left/ ▶ Right** in the **DISPLAY > PIP settings > Saturation** or **Hue** menu.
8. To leave the OSD menu, press **MENU/BACK** twice.

Remote paging operations

Connect the projector to your PC or notebook with a USB cable prior to using the paging function.

You can operate your display software program (on a connected PC) which responds to page up/down commands (like Microsoft PowerPoint) by pressing **Page Up** and **Page Down** on the remote control. See "Connecting a computer" on page 22 for details.

If remote paging function doesn't work, check if the USB connection is correctly made and the mouse driver on your computer is updated to the latest version.

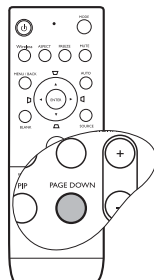

Freezing the image

Press the **FREEZE** button on the remote control to freeze the image. An icon ■■ will display in the lower right corner of the screen. To release the function, press any button (except **LASER**) on the projector or remote control.

Even if an image is frozen on the screen, the pictures are running on the video or other device. If the connected devices have active audio output, you will still hear the audio even though the image is frozen onscreen.

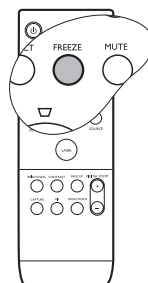

Creating your own startup screen

In addition to selecting the projector preset startup screen from among BenQ logo, Black or Blue screen, you can make your own startup screen that is an image projected from your computer or video source.

1. Project the image you want to use as your startup screen from either a computer or video source.
2. Press **CAPTURE** on the remote control or go to the **SYSTEM SETUP: Basic > My Screen** menu, press **ENTER**.
3. A confirmation message displays. Press **CAPTURE** or **ENTER** again.
4. The message '**Screen Capturing...**' displays while the projector is processing the image. Please wait.
5. If the action is successful, you see the message '**Captured Succeeded**' on the screen. The captured image is saved as My Screen.
6. To view the captured image displayed as the startup screen, set **My Screen** in the **SYSTEM SETUP: Advanced > Splash Screen** menu and restart the projector.

In the unlikely event, the capturing action failed. If so, change your target image.

Personalizing the projector menu display

The On-Screen Display (OSD) menus can be set according to your preferences. The following settings do not affect the projection settings, operation, or performance.

- **Menu Display Time** in the **SYSTEM SETUP: Basic > Menu Settings** menu sets the length of time the OSD will remain active after your last button press. The time length ranges from 5 to 30 seconds in 5-second increments. Use ◀ **Left**/ ▶ **Right** to select a suitable time.
- **Menu Position** in the **SYSTEM SETUP: Basic > Menu Settings** menu sets the OSD position in five locations. Use ◀ **Left**/ ▶ **Right** to select a preferred position.
- **Language** in the **SYSTEM SETUP: Basic** menu sets your familiar language for the On-Screen (OSD) Menus. Use ◀ **Left**/ ▶ **Right** to select your language.
- **Splash Screen** in the **SYSTEM SETUP: Basic** menu sets a preferred logo screen to be displayed during projector start-up. Use ◀ **Left**/ ▶ **Right** to select a screen.

Shutting down the projector

1. Press **Power** and a confirmation message will display prompting you. If you don't respond in a few seconds, the message will disappear.
2. Press **Power** a second time. The **Power indicator light** flashes orange, the projection lamp shuts down, and the fans will continue to run for approximately 90 seconds to cool down the projector.

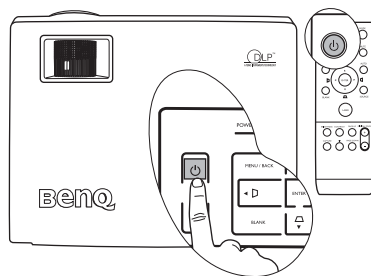

⚠ To protect the lamp, the projector will not respond to any commands during the cooling process.

3. The Power indicator light is a steady orange once the cooling process has finished and fans stop.
4. Disconnect the power cord from the wall socket.

👉 To save your time, you can unplug the projector as soon as it is turned off without waiting for the cooling time. The projector will continue cooling down even if it is unplugged so that you can pack up the projector and go. During the projector's off-line cooling, you cannot restart it.

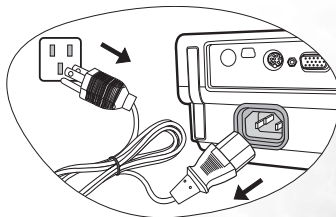

Menu operation

Menu system

Please note that the on-screen display (OSD) menus vary according to the signal type selected.

Main menu	Sub-menu	Options	
DISPLAY	Aspect Ratio	Auto/Actual Size/4:3/16:9	
	Keystone		
	Position		
	Phase		
	H. Size		
	Digital Zoom		
	Pan		
	PIP Settings	PIP	On/Off
		Source	S-Video/Video
		Position	Bottom-Right/Bottom-Left/Top-Left/Top-Right
		Size	Small/Large
		Saturation	
		Hue	
PICTURE	Application Mode	PC source: Brightest/ Presentation/sRGB/Photo/ Gaming/Video/User 1/User 2/ Memory Video source: Cinema/Movie/ Gaming/Photo/User 1/User 2	
	Reference	PC source: Brightest/ Presentation/sRGB/Photo/ Gaming/Video Video source: Cinema/Movie/ Gaming/Photo	
	Brightness		
	Contrast		
	Saturation		
	Hue		
	Sharpness		
	White Peak		
	Color Temperature	T1/T2/T3/T4	
	Gamma	Gamma 1/Gamma 2/Gamma 3/ Gamma 4/Gamma 5/Gamma 6/ Gamma 7/Gamma 8/Gamma 9	
	Save Settings		

SOURCE	Auto Source Detection	On/Off	
	Network		
SYSTEM SETUP: Basic	Language	English, French, German, Italian, Spanish, Russian, Traditional Chinese, Simplified Chinese, Japanese, Korean, Swedish, Dutch, Turkish, Czech, Portuguese, Thai, Polish	
	Projector Position	Front Table/Rear Table/Rear Ceiling/Front Ceiling	
	Auto Power Off	Disable/5 min/10 min/15 min/20 min/25 min/30 min	
	Blank Timer	Disable/5 min/10 min/15 min/20 min/25 min/30 min	
	Splash Screen	BenQ/My Screen/Black/Blue	
	My Screen		
	Audio Settings	Mute	On/Off
		Volume	
	Menu Settings	Menu Display Time	5 sec/10 sec/15 sec/20 sec/30 sec
		Menu Position	Center/Top-Left/Top-Right/Bottom-Right/Bottom-Left
SYSTEM SETUP: Advanced	Quick Cooling	On/Off	
	High Altitude Mode	On/Off	
	Lamp Settings	Lamp Mode	Normal/Economic
		Reset Lamp Timer	Reset/Cancel
		Lamp Timer	
	Security Settings	Password	On/Off
		Change Password	
	Reset All Settings		
	Information	Source	
		Application Mode	
Resolution			
Color System			
Lamp Timer			

Note that the menu items are available when the projector detects at least one valid signal. If there is no equipment connected to the projector or no signal detected, limited menu items are accessible.

Using the menus

The projector is equipped with On-Screen Display (OSD) menus for making various adjustments and settings.

There are 17 different OSD menu languages. See "[System setup: Basic menu](#)" on page 50 for details.

Below is the overview of the English OSD menu.



The following example describes the adjustment of Keystone with the English OSD menus. The adjustment methods mentioned below can also be applied when using different OSD language other than English.

1. Press **MENU/BACK** on the projector or remote control to turn the OSD menu on.
4. Press **ENTER** to display the keystone correction page.



2. Use **◀ Left / ▶ Right** to select the **DISPLAY** menu.
3. Press **▲ Up / ▼ Down** to select **Keystone**.
5. Based on the image shape displayed on the screen, press the keystone buttons (**□ / ▲ Up**, **□ / ◀ Left**, **△ / ▼ Down**, **□ / ▶ Right**) to adjust the image to a rectangular or square one.
6. Press **MENU/BANCK** on the projector or remote control twice* to leave and save the settings.



*The first press leads you back to the main menu and the second press closes the OSD menu.

Display menu

FUNCTION (default setting/ value)	DESCRIPTION (default setting/value)
Aspect Ratio (Auto)	There are four options to set the image's aspect ratio depending on your input signal source. See " Selecting the aspect ratio " on page 37 for details.
Keystone (0)	Corrects any keystone of the image. See " Correcting keystone " on page 35 for details.
Position (0)	Displays the position adjustment page. To move the projected image, use the directional arrow buttons. The values shown on the lower position of the page change with every button press you made until they reach their maximum or minimum.
Phase (depends on the selected input source)	Adjusts the clock phase to reduce image distortion. 
H. Size (depends on the selected input source)	Adjusts the horizontal width of the image.
Digital Zoom (100%)	Magnifies or reduces the projected image. See " Searching for details on the projected image " on page 35 for details.
Pan	Displays the Pan page for searching the details of the projected image by using the directional arrow buttons on the projector or remote control after the image is magnified.
PIP Settings	<p>PIP (Off) Turns the PIP window on or off</p> <p>Source (Video) Selects the source for the PIP.</p> <p>Position (Top-Left) Selects a desired position for the PIP.</p> <p>Size (Large) Selects a suitable size for the PIP.</p> <p>Saturation (0) Adjusts the color saturation level.</p> <p>Hue (0) Adjusts the red and green color tones of the image.</p> <p>See "Saturation" on page 48, "Hue" on page 48, "PIP (Picture In Picture) operation" on page 41 for details.</p>

Picture menu

 Some picture adjustments are available only when certain input sources are in use. Unavailable adjustments are not shown on the screen.

FUNCTION (default setting / value)	DESCRIPTION
Application Mode (PC: Presentation; YPbPr/ S-Video/ Video: Movie)	Pre-defined application modes are provided so you can optimize your projector image set-up to suit your program type. See "Selecting an application mode" on page 38 for details.
Reference	Selects an application mode that most suits your need for the image quality and further fine-tune the image based on the selections listed on the same page below.
Brightness (50)	Adjusts the brightness of the image. See "Adjusting brightness" on page 39 for details.
Contrast (0)	Adjusts the degree of difference between dark and light in the image. See "Adjusting contrast" on page 39 for details.
Saturation (0)	Adjusts the color saturation level -- the amount of each color in a video image. Lower setting produces less saturated colors; setting to the minimum value makes the image black and white. If the setting is too high, colors on the image will be overpowering, which makes the image unrealistic.
Hue (0)	Adjusts the red and green color tones of the image. The higher the value, the more greenish the image becomes. The lower the value, the more reddish the image becomes.
Sharpness (16)	Adjusts the image to make it look sharper or softer.
White Peak (10)	Adjusts white peaking.
Color Temperature (T3)	There are four color temperature settings are available. See "Selecting a color temperature" on page 39 for details.
Gamma (Gamma 2)	Sets how gray shades are displayed between minimum input (black) and maximum input (white) for all signals.
Save Settings	Saves the settings made for User 1 or 2 mode.



Source menu

FUNCTION (default setting / value)	DESCRIPTION
Auto Source Detection (On)	Sets whether the projector searches automatically for input signals. If the source scan is On , the projector will scan for input signals until it acquires a signal. If the function is not activated, the projector selects the last used input signal. The default value is 'RGB'.
Network	Displays the wireless connection menu.

System setup: Basic menu

FUNCTION (default setting / value)	DESCRIPTION
Language (English)	Sets the language for the On-Screen Display (OSD) menus. Use ◀ Left / ▶ Right on the projector or remote control to select your desired language. There are 17 languages for your choice: English (default), French, German, Italian, Spanish, Russian, Traditional Chinese, Simplified Chinese, Japanese, Korean, Swedish, Dutch, Turkish, Czech, Portuguese, Thai, and Polish.
Projector Position (Front Table)	The projector can be installed on a ceiling or behind a screen, or with one or more mirrors. Contact your dealer for the ceiling mount bracket (optional accessory) if you need to install the projector on your ceiling. See " Choosing a location " on page 17 for details.
Auto Power Off (Disable)	This function allows the projector to turn off automatically if no input signal is detected after a set period of time. Press ◀ Left / ▶ Right on the projector or remote control to set the duration before the projector is turned off. The time period can be set from 5 to 30 minutes in 5-minute increments. If the preset time lengths are not suitable for your presentation, select Disable . The projector will not automatically shut down in a certain time period.
Blank Timer (Disable)	Sets the image blank time when the Blank feature is activated, once elapsed the image will return to the screen. See " Hiding the image " on page 40 for details.
Splash Screen (BenQ logo)	Allows you to select which logo screen will display during projector start-up. Four options are available: BenQ logo, My Screen, Black screen, or Blue screen.
My Screen	Captures and stores the projected image as My Screen. See " Creating your own startup screen " on page 42 for details.
Audio Settings	Mute (Off) Toggles the projector audio between on and off. Volume (5) Adjusts audio volume level.
Menu Settings	Menu Display Time (15 sec) Sets the length of time the OSD will remain active after your last button press. The range is from 5 to 30 seconds in 5-second increments. Menu Position (Center) Sets the On-Screen Display (OSD) menu position.

System setup: Advanced menu

FUNCTION (default setting / value)	DESCRIPTION
Quick Cooling (Off)	Enables or disables the Quick Cooling function. Selecting On enables the function and projector cooling time will be shortened from a normal 90-second duration to approximately 30 seconds.
High Altitude Mode (Off)	A mode for operation in areas like high altitude or high temperature. See " Operating in a high altitude environment " on page 40 for details.
Lamp Settings	<p>Lamp Mode (Normal) Toggles the projector lamp between Normal and Economic modes. Using Economic mode reduces system noise and power consumption by 20%. If the Economic mode is selected, the light output will be reduced and result in darker projected images.</p> <p>Setting the projector in Economic mode also extends the lamp timer automatic shutdown feature. See "Calculation of lamp hour" on page 56 for details on how the total lamp hour is calculated.</p> <p>Reset Lamp Timer Once the lamp is renewed, select Reset to return the lamp timer to '0'.</p>
Security Settings	<p>Password (Off) Limits use of the projector to only those who know the correct password. When the function is activated for the first time, you have to set a password for it. See "Utilizing the password function" on page 32 for details. Once the password is set and this function is selected, the projector is password-protected. Users who do not know the correct password can not use the projector.</p> <p>The password can be entered by using either the buttons on the projector or the remote control.</p> <p> You will be inconvenienced if you activate the password functionality and subsequently forget the password.</p> <p>Print out this manual (if necessary) and write the password you used in this manual, and keep the manual in a safe place for later recall.</p> <p>The password will display as asterisks on-screen when being input.</p> <p>Change Password You will be asked to enter the current password before changing to a new one. See "Utilizing the password function" on page 32 for details.</p>
Reset All Settings	<p>Returns all settings to the factory preset values.</p> <p> The following settings will still remain: Keystone, Position, Phase, Projector Position, High Altitude Mode, Lamp Settings, and Security Settings.</p>

Information menu

This menu shows you the current operating status of the projector.

 **Some picture adjustments are available only when certain input sources are in use. Unavailable adjustments are not shown on the screen.**

FUNCTION	DESCRIPTION
Source	Shows the current signal source.
Application Mode	Shows the selected mode in the PICTURE menu.
Resolution	Shows the native resolution of the input signal.
Color System	Shows input system format, NTSC, PAL, SECAM, or RGB.
Lamp Timer	Displays the number of hours the lamp has been used.

6 Maintenance

Care of the projector

Your projector needs little maintenance. The only thing you need to do on a regular basis is to keep the lens clean and to clean the dust filter to prevent overheating.

See "[Cleaning the lens](#)" and "[Cleaning and replacing the dust filter](#)" below for details.

Never remove any parts of the projector except the lamp and dust filter. Contact your dealer if other parts need replacing.

Cleaning the lens

Clean the lens whenever you notice dirt or dust on the surface.

- Use a canister of compressed air to remove dust.
- If there is dirt or smears, use lens-cleaning paper or moisten a soft cloth with lens cleaner and gently wipe the lens surface.

 **Never rub the lens with abrasive materials.**

Cleaning the projector case

Before you clean the case, turn the projector off using the proper shutdown procedure as described in "[Shutting down the projector](#)" on page 43 and unplug the power cord.

- To remove dirt or dust, wipe the case with the supplied cleaning cloth.
- To remove stubborn dirt or stains, moisten a soft cloth with water and a neutral pH detergent. Then wipe the case.

 **Never use wax, alcohol, benzene, thinner or other chemical detergents. These can damage the case.**

Storing the projector

If you need to store the projector for an extended time, please follow the instructions below:

- Make sure the temperature and humidity of the storage area are within the recommended range for the projector. Please refer to "[Specifications](#)" on page 64 or consult your dealer about the range.
- Retract the adjuster feet.
- Remove the batteries from the remote control.
- Pack the projector in its original packing or equivalent.

Transporting the projector

It is recommended that you ship the projector with its original packing or equivalent. When you carry the projector yourself, please use the original box or provided soft carry case.

Cleaning and replacing the dust filter

It is necessary to clean the dust filter periodically. If the filter is not cleaned, it can become clogged with dust and prevent proper ventilation. This can cause overheating and a malfunction of the projector.

A warning message like the one pictured to the right will be displayed for 10 seconds every 500 hours of use to remind you to clean the filter. To leave the message, press **ENTER** on the projector or remote control.



To clean the filter

1. Turn the projector off and wait until the fans stop running.
2. Locate the filter case on the back of the projector.
3. Release the filter case from the projector by pressing the filter case into the slot slightly. The filter case springs out of the slot.
4. Pull out the filter case.
5. Use a small vacuum cleaner designed for computers and other office equipment to clean the filter sponge. Or use a soft brush (such as a clean artist's paintbrush) to gently sweep the dust on the filter away.
If the dirt is difficult to remove or the filter is broken, replace it with the supplied spare filter sponge. See "[Replacing the filter sponge](#)" next page.

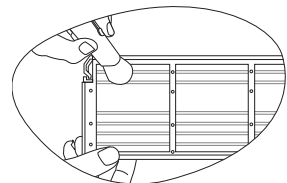
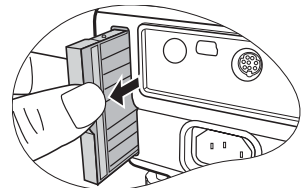
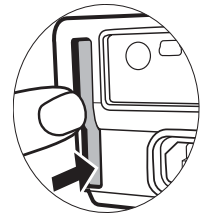
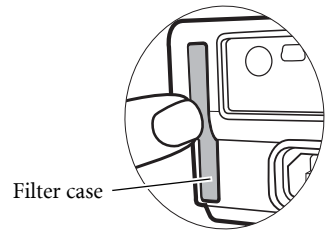

6. Refit the filter case by aligning and inserting it into the projector slot.
7. Press the case back until it clicks into place.
8. Turn the projector back on.

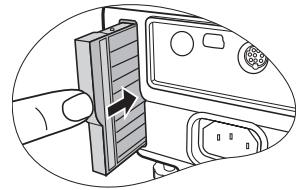

If the case is not correctly seated in place, the projector will display an on-screen message as pictured to the right every three minutes.

The message will display 3 times for a 10-second duration each, if no further action is taken.

Then a second message as pictured to the right displays to warn of shutdown in 1 minute.

You can re-attach the case correctly anytime before the projector shuts down. That means you have 10-11 minutes to get the re-attachment done from the time the first warning message was displayed. The projector will return to normal operation.

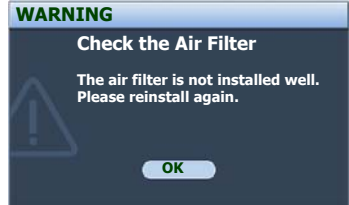

Replacing the filter sponge

If you find the dirt is hard to remove from the filter sponge or the sponge is broken, replace it.

1. Carefully peel the filter sponge away from the filter case. See that there are small plastic pins along the edges to position and retain the sponge into place. Lift the sponge up off these pins taking care to prevent them from breaking off.
2. Attach the supplied new filter sponge to the filter case. Make sure that the tiny holes securely fit onto the case's pins.

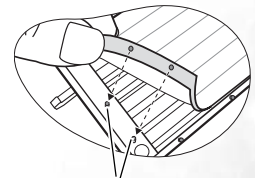
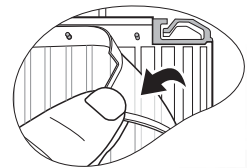

Plastic pins

Lamp information

Calculation of lamp hour

When the projector is in operation, the duration (in hours) of lamp usage is automatically calculated by the built-in timer. The method of calculating the equivalent lamp hour is as follows:

Total (equivalent) lamp hour

= 3/4 (hours used in Economic mode) + 1 (hours used in normal mode)

 See "[Lamp Mode \(Normal\)](#)" on page 51 for more information on Economic mode.



The lamp hour in Economic mode is calculated as 3/4 of that in normal mode. That is, using the projector in Economic mode helps to extend the lamp hour by 1/3.

Warning message

When the **Lamp indicator** lights up red or a message appears suggesting it is time to replace the lamp, please install a new lamp or consult your dealer. An old lamp may cause a malfunction in the projector and in some instances the lamp may explode.

The Lamp indicator light and Temperature warning light will light up if the lamp becomes too hot. Turn the power off and let the projector cool for 45 minutes. If the Lamp or Temp indicator still lights up after turning the power back on, please contact your dealer. See "[Indicators](#)" on page 60 for details.

The following Lamp warning displays will remind you to change the lamp.

Message	Status
	The lamp has been in operation for 2800 hours. Install a new lamp for optimal performance. If the projector is normally run with "Economic Mode" selected (See " Lamp Mode (Normal) " on page 51), you may continue to operate the projector until the 2950 hour lamp warning appears.
	The lamp has been in operation for 2950 hours. A new lamp should be fitted to avoid the inconvenience of shutdown when the projector runs out of lamp time. It is strongly recommended that you replace the lamp at this age. The lamp is a consumable item. The lamp brightness diminishes with use. This is normal lamp behavior. You can replace the lamp whenever you notice that the brightness level has significantly diminished. If the lamp is not replaced beforehand, it must be replaced after 2950 hours usage.

 <p>Out of Lamp Usage Time</p> <p>The projector will be shut down automatically for safety issue. Please replace the lamp as soon as possible.</p>	<p>If this warning message displays, the projector will shut down in 40 seconds. The lamp MUST be replaced before the projector will operate normally.</p>
--	---

Replacing the lamp

- ⚠ • **To reduce the risk of electrical shock, always turn the projector off and disconnect the power cord before changing the lamp.**
 - **To reduce the risk of severe burns, allow the projector to cool for at least 45 minutes before replacing the lamp.**
 - **To reduce the risk of injuries to fingers and damage to internal components, use caution when removing lamp glass that has shattered into sharp pieces.**
 - **To reduce the risk of injuries to fingers and/or compromising image quality by touching the lens, do not touch the empty lamp compartment when the lamp is removed.**
 - **This lamp contains mercury. Consult your local hazardous waste regulations to dispose of this lamp in a proper manner.**
1. Turn the power off and disconnect the projector from the wall socket. If the lamp is hot, avoid burns by waiting for approximately 45 minutes until the lamp has cooled.
 2. Turn the projector over. Then loosen the screw on the lamp cover.

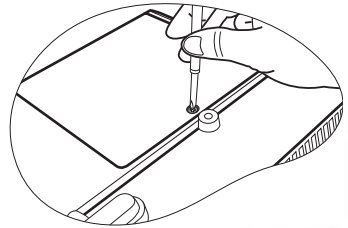

3. Remove the lamp cover from the projector.
- ⚠ **Do not turn the power on with the lamp cover removed.**

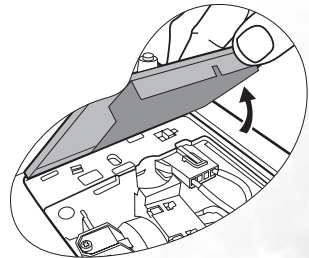

4. Disconnect the lamp connector from the projector.

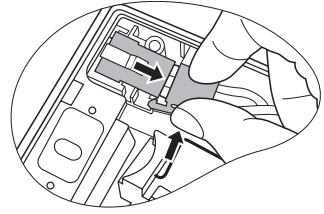

5. Loosen the screw that secures the lamp.

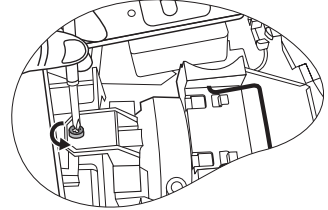

6. Lift the handle so that it stands up. Use the handle to slowly pull the lamp out of the projector.



- **Pulling it too quickly may cause the lamp to break and scatter broken glass in the projector.**

- **Do not place the lamp in locations where water might splash on it, children can reach it, or near flammable materials.**

- **Do not insert your hands into the projector after the lamp is removed. If you touch the optical components inside, it could cause color unevenness and distortion of the projected images.**

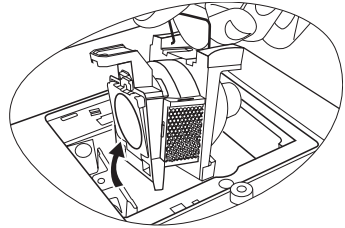

7. As shown in the figure, hold the new lamp and align the two locators on the lamp with the holes on the projector, and then insert the lamp all the way into the projector.

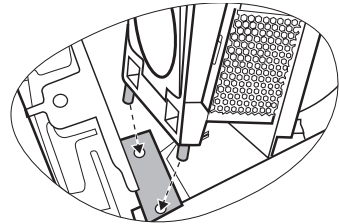

8. Connect the lamp connector to the projector.

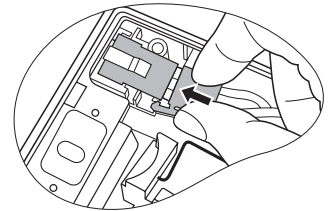

9. Tighten the screw that secures the lamp.

- ☞ **Loose screw may cause a bad connection, which could result in malfunction.**
- **Do not over tighten the screw.**

10. Ensure the handle is fully laid flat and locked in place.

11. Replace the lamp cover on the projector.

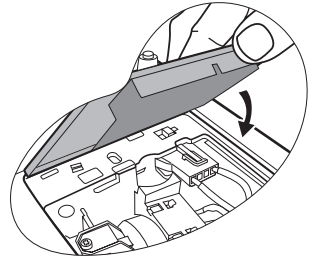
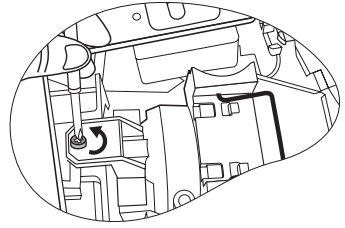

12. Tighten the screw that secures the lamp cover.

- ☞ **Loose screw may cause a bad connection, which could result in malfunction.**
- **Do not over tighten the screw.**

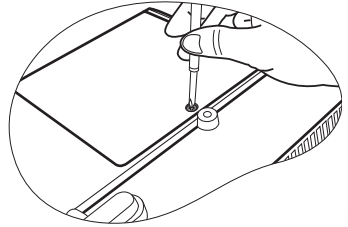

13. Restart the projector.

- ☞ **Do not turn the power on with the lamp cover removed.**

14. After the startup logo, open the On-Screen Display (OSD) menu. Go to the **SYSTEM SETUP: Advanced > Lamp Settings** menu. Press **ENTER**. The **Lamp Settings** page displays. Highlight **Reset Lamp Timer**. A warning message displays asking if you want to reset the lamp timer. Highlight **Reset** and press **ENTER**. The lamp time will be reset to '0'.

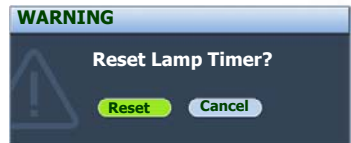

- ☞ **Do not reset if the lamp is not new or replaced as this could cause damage.**

Temperature information



When the Temperature warning light is on, it is warning you of the following possible problems:











1. The internal temperature is too high.
2. The fans are not working.

Turn the projector off and contact qualified service personnel for further help. For more detailed information, please refer to "[Indicators](#)" on page 60.

Indicators

Illustration

- **Blank** -: Light OFF
- : Light flashing
- : Light ON
- **O**: Orange light
- **R**: Red light
- **G**: Green light

Light			Status & Description
Power	Temp	Lamp	
Power events			
			The projector has just been connected to a power outlet.
	-	-	Stand-by mode.
	-	-	Powering up.
	-	-	Normal operation.
	-	-	1. The projector needs 90 seconds to cool down as it was abnormally shut down without the normal cooling down process. Or 2. The projector needs to cool for 90 seconds after the power is turned off.
	-	-	The projector has shutdown automatically. If you try to re-start the projector, it will shutdown again. Please contact your dealer for assistance.
Lamp events			
	-		The projector has shutdown automatically. If you try to re-start the projector, it will shutdown again. Please contact your dealer for assistance.
-	-		1. The projector needs 90 seconds to cool down. Or 2. Please contact your dealer for assistance.

Light			Status & Description
Power	Temp	Lamp	
Thermal events			
-	R	-	
-	R	R	
-	R	G	
	R	O	
R	R	R	
R	R	G	
R	R	O	
G	R	R	The projector has shutdown automatically. If you try to re-start the projector, it will shutdown again. Please contact your dealer for assistance.
G	R	G	
G	R	O	
O	R	R	
O	R	G	
O	R	O	
-	G	R	
-	G	O	

7 Troubleshooting

? The projector does not turn on.

Cause	Remedy
There is no power from the power cable.	Plug the power cord into the AC inlet on the projector, and plug the power cord into the power outlet. If the power outlet has a switch, make sure that it is switched on.
Attempting to turn the projector on again during the cooling process.	Wait until the cooling down process has completed.

? No picture

Cause	Remedy
The video source is not turned on or connected correctly.	Turn the video source on and check that the signal cable is connected correctly.
The projector is not correctly connected to the input source device.	Check the connection.
The input signal has not been correctly selected.	Select the correct input signal with the Source key on the projector or remote control.
The lens cap is still attached to the lens.	Remove the lens cap.

? Blurred image

Cause	Remedy
The projection lens is not correctly focused.	Adjust the focus of the lens using the focus ring.
The projector and the screen are not aligned properly.	Adjust the projection angle and direction as well as the height of the unit if necessary.
The lens cap is still attached to the lens.	Remove the lens cap.

? Remote control does not work

Cause	Remedy
The batteries are out of power.	Replace the batteries with new ones.
There is an obstacle between the remote control and the projector.	Remove the obstacle.
You are too far away from the projector.	Stand within 6 meters (19.5 feet) of the projector.

② **The computer projected image is too big for the screen or appeared to be cut-off**

Cause	Remedy
The computer's resolution does not match the projector's resolution.	<ol style="list-style-type: none"> 1. Make sure the H Position and V Position settings are correct in the Image menu. 2. Configure the computer's external display resolution to the projector's native resolution (1024 x 768 for MP770). If this option is not available, select one of the compatible listed in "Supported timing for PC (including DVI-I) input" on page 65. 3. Check if your presentation files are created for a different resolution.
The computer's external monitor setting is locked in 640 x 480.	

② **My Window Media Player program works great on my computer, but the movie window is dark on my projector, while the Media Player tools display OK.**

Cause	Remedy
The computer external display is set as a secondary display.	Change the Display settings. Click Start > Control Panel > Display > Settings > Advanced > Display. See your computer documentation for details, if you cannot find the Display settings by following the instructions above. Set the Monitor to Primary, and the Panel to Secondary. You will see the movie window on the projector image, while the Panel movie window will be dark.

② **The remote mouse function does not work.**

Cause	Remedy
The USB cable is not correctly connected to the projector or computer.	Check the connection. See " Connecting a computer " on page 22 for details. If it still doesn't work, check the mouse driver. See the mouse documentation for details.

8 Specifications

Projector specifications

 All specifications are subject to change without notice.

Optical

Resolution	1024 x 768 XGA
Display system	1-CHIP DMD
Lens F/Number	F=2.6 to 2.77, f= 20.4 to 23.5 mm
Lamp	220 W lamp

Electrical

Power supply	AC100–240V, 1.5A–3.2A, 50/60 Hz (Automatic)
Power consumption	320 W (Max); 15 W (Standby)

Mechanical

Weight	6.6 lbs (2.99 Kg)
--------	-------------------

Input terminals

Computer input	
RGB input	D-Sub 15-pin (female) x 1
DVI-I input	(Using DVI-A signal)
Video signal input	
S-VIDEO	Mini DIN 4-pin port x 1
VIDEO	RCA jack x1
SD/HDTV signal input	Analog - D-Sub to Component RCA jack x 3 (using RGB input)
	Digital - DVI (HDTV only)
Audio signal input	
Audio in	Stereo mini-jack x 1

Output terminals

RGB output	D-sub 15-pin (female) x 1
Audio output	Stereo mini-jack (mixed mono)
Speaker	(mixed mono) 2 watt x 1

Control

USB mouse control	A/B series x 1
RS-232 serial control	Mini Din 9 pin x 1

Environmental Requirements

Operating temperature	0°C ~ 40°C at sea level
Operating relative humidity	10% ~ 90% (without condensation)
Operating altitude	0–3000 feet at 0°C–40°C
	3000–6000 feet at 0°C–30°C
	6000–10000 feet at 0°C–23°C

Timing chart

Supported timing for PC (including DVI-I) input

Resolution	Horizontal Frequency (kHz)	Vertical Frequency (Hz)	Pixel Frequency (MHz)	Mode
640 x 400	31.47	70.089	25.176	640 x 400_70
640 x 480	31.469	59.940	25.175	VGA_60
	37.861	72.809	31.500	VGA_72
	37.500	75.000	31.500	VGA_75
	43.269	85.008	36.000	VGA_85
800 x 600	37.879	60.317	40.000	SVGA_60
	48.077	72.188	50.000	SVGA_72
	46.875	75.000	49.500	SVGA_75
	53.674	85.061	56.250	SVGA_85
1024 x 768	48.363	60.004	65.000	XGA_60
	56.476	70.069	75.000	XGA_70
	60.023	75.029	78.750	XGA_75
	68.667	84.997	94.500	XGA_85
1280 x 1024	63.981	60.020	108.000	SXGA_60

Supported timing for Component-YPbPr input

Signal Format	Horizontal Frequency (kHz)	Vertical Frequency (Hz)
480i(525i)@60Hz	15.73	59.94
480p(525p)@60Hz	31.47	59.94
576i(625i)@50Hz	15.63	50.00
576p(625p)@50Hz	31.25	50.00
720p(750p)@60Hz	45.00	60.00
720p(750p)@50Hz	37.50	50.00
1080i(1125i)@60Hz	33.75	60.00
1080i(1125i)@50Hz	28.13	50.00

Supported timing for Video and S-Video inputs

Video mode	Horizontal Frequency (kHz)	Vertical Frequency (Hz)	Color sub-carrier Frequency (MHz)
NTSC	15.73	60	3.58
PAL	15.63	50	4.43
SECAM	15.63	50	4.25 or 4.41
PAL-M	15.73	60	3.58
PAL-N	15.63	50	3.58
PAL-60	15.73	60	4.43
NTSC4.43	15.73	60	4.43

Dimensions

291 mm (W) x 94 mm (H) x 238 mm (D)

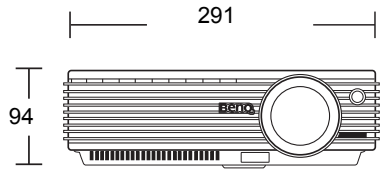
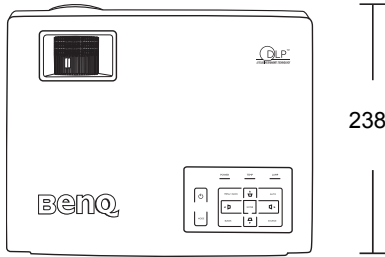

Unit: mm

Warranty

Limited warranty

BenQ warrants this product against any defects in material and workmanship, under normal usage and storage.

Proof of purchase date will be required with any warranty claim. In the event this product is found to be defective within the warranty period, BenQ's only obligation and your exclusive remedy shall be replacement of any defective parts (labor included). To obtain warranty service, immediately notify the dealer from which you purchased the product of any defects.

Important: The above warranty shall be void if the customer fails to operate the product in accordance with BenQ's written instructions, especially the ambient humidity must be in-between 10% and 90%, temperature in-between 0°C and 40°C, altitude lower than 10000 feet, and avoiding to operate the projector in a dusty environment. This warranty gives you specific legal rights, and you may have other rights which vary from country to country.

For other information, please visit support.BenQ.com.

10 Regulation statements

FCC statement

CLASS B: This equipment generates, uses and can radiate radio frequency energy and, if not installed and used in accordance with the instructions, may cause harmful interference to radio communications. However, there is no guarantee that interference will not occur in a particular installation. If this equipment does cause harmful interference to radio or television reception, which can be determined by turning the equipment off and on, the user is encouraged to try to correct the interference by one or more of the following measures:

- Reorient or relocate the receiving antenna.
- Increase the distance between the equipment and receiver.
- Connect the equipment into an outlet on a circuit different from that to which the receiver is connected.
- Consult the dealer or an experienced radio/TV technician for help.

EEC statement

This machine was tested against the 89/336/EEC (European Economic Community) for EMC (Electronic Magnetic Compatibility) and fulfills these requirements.

MIC statement

B class equipment (Household purpose info/telecommunications equipment)

This equipment has undergone EMC registration for household purpose, and can be used in any area including residential area.

WEEE directive

Disposal of Waste Electrical and Electronic Equipment by users in private households in the European Union.

This symbol on the product or on the packaging indicates that this can not be disposed of as household waste. You must dispose of your waste equipment by handing it over to the applicable take-back scheme for the recycling of electrical and electronic equipment. For more information about recycling of this equipment, please contact your city office, the shop where you purchased the equipment or your household waste disposal service. The recycling of materials will help to conserve natural resources and ensure that it is recycled in a manner that protects human health and environment.

