

***myprojectorlamps.com***

**The most trusted, dependable name  
in projector lamp sales.**



<http://www.myprojectorlamps.com>



<http://www.myprojectorlamps.ca>



<http://www.myprojectorlamps.eu>

The following projector manual has not been modified or altered in any way.

**BenQ**

MP730 Digital Projector

User Manual

Welcome

# Table of contents

## Important safety

**instructions .....3**

**Introduction.....7**

Projector features ..... 7

Shipping contents ..... 8

Projector exterior view ..... 9

Controls and functions ..... 10

**Positioning your projector 14**

Choosing a location..... 14

Obtaining a preferred projected image  
size ..... 15

**Connection .....21**

Connecting a computer or monitor... 21

Connecting Video source devices..... 22

**Operation .....27**

Starting up the projector ..... 27

Using the menus..... 28

Securing the projector ..... 29

Switching input signal ..... 32

Adjusting the projected image ..... 33

Magnifying and searching for details on  
the projected picture ..... 34

Selecting the aspect ratio ..... 35

Optimizing the image..... 37

Setting the presentation timer ..... 41

Remote paging operations ..... 42

Hiding the image ..... 43

Freezing the image..... 43

Utilizing FAQ function ..... 44

Locking control keys ..... 44

Operating in a high altitude  
environment ..... 45

Creating your own startup screen .....45

Adjusting the sound .....46

Personalizing the projector menu  
display .....46

Shutting down the projector .....47

Menu operation .....48

**Maintenance.....55**

Care of the projector .....55

Lamp information.....56

**Troubleshooting .....62**

**Specifications .....63**

Projector specifications.....63

Dimensions.....64

Timing chart.....65

**Warranty and Copyright  
information .....67**

**Regulation statements .....68**

# Important safety instructions

Your projector is designed and tested to meet the latest standards for safety of information technology equipment. However, to ensure safe use of this product, it is important that you follow the instructions mentioned in this manual and marked on the product.

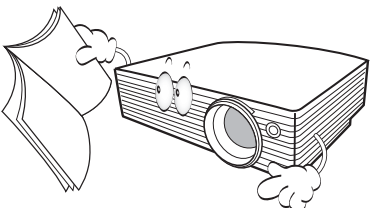
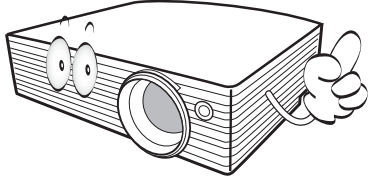
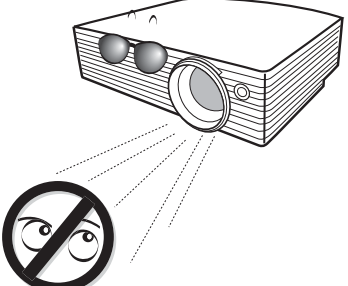
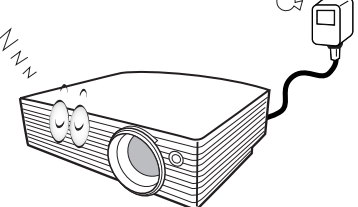
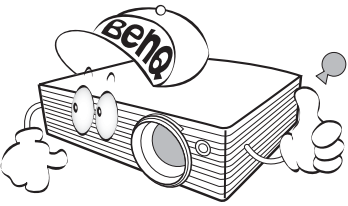
Safety Instructions	
<p>1. <b>Please read this manual before you operate your projector.</b> Save it for future reference.</p>	<p>4. <b>Always open the lens shutter or remove the lens cap when the projector lamp is on.</b></p>
	
<p>2. <b>Do not look straight at the projector lens during operation.</b> The intense light beam may damage your eyes.</p>	<p>5. In some countries, the line voltage is NOT stable. This projector is designed to operate safely within a mains voltage between 100 to 240 volts AC, but could fail if power cuts or surges of <math>\pm 10</math> volts occur. <b>In areas where the mains voltage may fluctuate or cut out, it is recommended that you connect your projector through a power stabilizer, surge protector or uninterruptible power supply (UPS).</b></p>
	
<p>3. <b>Refer servicing to qualified service personnel.</b></p>	<p>6. Do not block the projection lens with any objects when the projector is under operation as this could cause the objects to become heated and deformed or even cause a fire. To temporarily turn off the lamp, press <b>BLANK</b> on the projector or remote control.</p>
	

## Safety Instructions (Continued)

7. The lamp becomes extremely hot during operation. Allow the projector to cool for approximately 45 minutes prior to removing the lamp assembly for replacement.

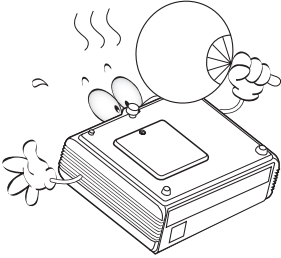

8. Do not operate lamps beyond the rated lamp life. Excessive operation of lamps beyond the rated life could cause them to break on rare occasions.

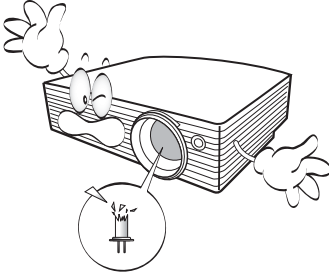

9. Never replace the lamp assembly or any electronic components unless the projector is unplugged.

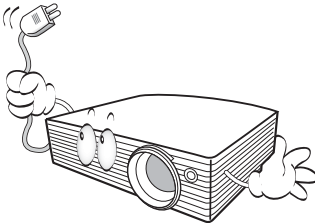

10. Do not place this product on an unstable cart, stand, or table. The product may fall, sustaining serious damage.

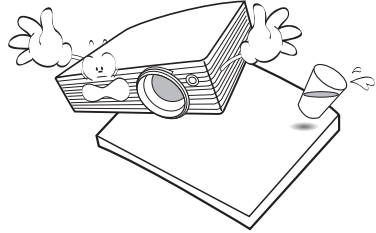

11. Do not attempt to disassemble this projector. There are dangerous high voltages inside which may cause death if you should come into contact with live parts. The only user serviceable part is the lamp which has its own removable cover. Under no circumstances should you ever undo or remove any other covers. Refer servicing only to suitably qualified professional service personnel.

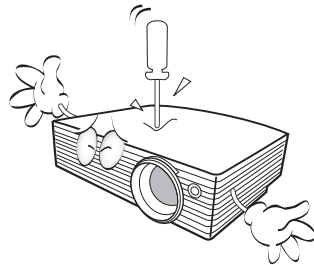

12. When the projector is under operation, you may sense some heated air and odor from its ventilation grill. It is a normal phenomenon and not a product defect.

## Safety Instructions (Continued)

13. Do not place this projector in any of the following environments.

- Space that is poorly ventilated or confined. Allow at least 50 cm clearance from walls and free flow of air around the projector.
- Locations where temperatures may become excessively high, such as the inside of a car with all windows rolled up.
- Locations where excessive humidity, dust, or cigarette smoke may contaminate optical components, shortening the projector's life span and darkening the image.

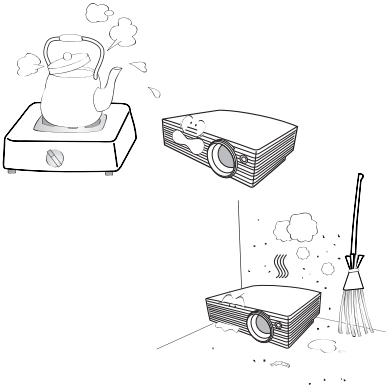

- Locations near fire alarms
- Locations with an ambient temperature above 40°C / 104°F
- Locations where the altitudes are higher than 3000 m (10000 feet).

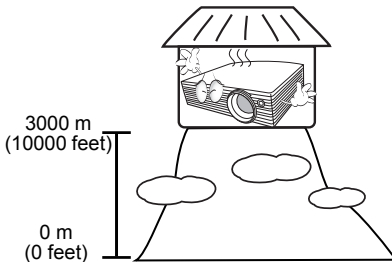

14. Do not block the ventilation holes.

- Do not place this projector on a blanket, bedding or any other soft surface.
- Do not cover this projector with a cloth or any other item.
- Do not place inflammables near the projector.

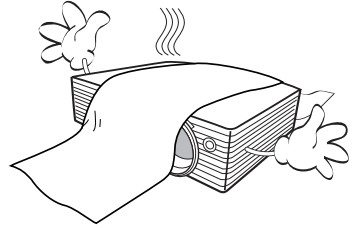

If the ventilation holes are seriously obstructed, overheating inside the projector may result in a fire.

15. Always place the projector on a level, horizontal surface during operation.

- Do not use if tilted at an angle of more than 10 degrees left to right, nor at angle of more than 15 degrees front to back. Using the projector when it is not fully horizontal may cause a malfunction of, or damage to, the lamp.

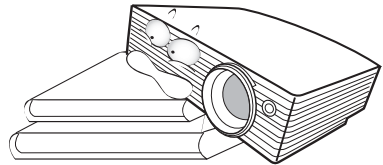

16. Do not stand the projector on end vertically. Doing so may cause the projector to fall over, causing injury or resulting in damage to the projector.

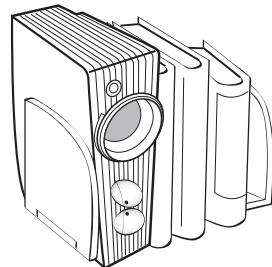

## Safety Instructions (Continued)

17. Do not step on the projector or place any objects upon it. Besides probable physical damage to the projector, doing so may result in accidents and possible injury.



18. Do not place liquids near or on the projector. Liquids spilled into the projector may cause it to fail. If the projector does become wet, disconnect it from the power supply's wall socket and call BenQ to have the projector serviced.

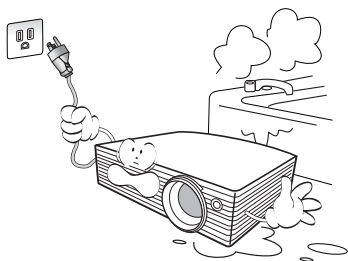

19. This product is capable of displaying inverted images for ceiling mount installation.

 **Use only BenQ's Ceiling Mount Kit for mounting the projector and ensure it is securely installed.**

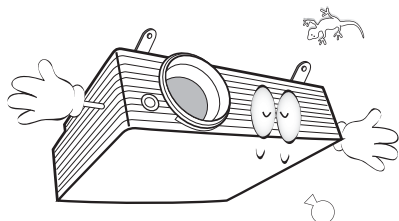

### **Ceiling mounting the projector**

We want you to have a pleasant experience using your BenQ projector, so we need to bring this safety matter to your attention to prevent possible damage to person and property.

If you intend to mount your projector on the ceiling, we strongly recommend that you use a proper fitting BenQ projector ceiling mount kit and that you ensure it is securely and safely installed.

If you use a non-BenQ brand projector ceiling mount kit, there is a safety risk that the projector may fall from the ceiling due to an improper attachment through the use of the wrong gauge or length screws.

You can purchase a BenQ projector ceiling mount kit from the place you purchased your BenQ projector. BenQ recommends that you also purchase a separate Kensington lock compatible security cable and attach it securely to both the Kensington lock slot on the projector and the base of the ceiling mount bracket. This will perform the secondary role of restraining the projector should its attachment to the mounting bracket become loose.

# Introduction

## Projector features

The projector integrates high-performance optical engine projection and a user-friendly design to deliver high reliability and ease of use.

The projector offers the following features.

- Wall color correction allowing projection on surfaces of several predefined colors
- Quick auto search speeding up the signal detecting process
- Selectable password protected function
- Up to 11 sets of picture modes providing multiple choices for different projection purposes
- 3D color management allowing color adjustments to your liking
- Detachable keypad on the projector to prevent stealing
- Splash Screen lock to prevent unauthorized use
- Selectable quick cooling function makes the projector cool in a shorter time
- FAQ to troubleshoot operational problems with one quick button press
- Presentation timer for a better control of time during presentations
- High quality manual zoom lens
- One-key auto-adjustment to display the best picture quality
- Digital keystone correction to correct distorted images
- Adjustable color balance control for data/video display
- High brightness projection lamp
- Ability to display 16.7 million colors
- Multi-language On-Screen Display (OSD) menus
- Switchable normal and Economic modes to reduce the power consumption
- Built-in speaker provides mixed mono audio when an audio input is connected
- Powerful AV function to provide high quality video image
- Component HDTV compatibility (YPbPr)
- HDCP compatibility



- **The apparent brightness of the projected image will vary depending on the ambient lighting conditions, selected input source contrast/brightness settings, and is directly proportional to projection distance.**
- **The lamp brightness will decline over time and may vary within the lamp manufacturers specifications. This is normal and expected behavior.**



# Shipping contents

The projector is shipped with the cables required for connection to a PC or video equipment. Carefully unpack and verify that you have all of the items shown below. If any of these items are missing, please contact your place of purchase.

## Standard accessories

 The supplied accessories will be suitable for your region, and may differ from those illustrated.

\*The warranty card and safety manual are only supplied in some specific regions. Please consult your dealer for detailed information.

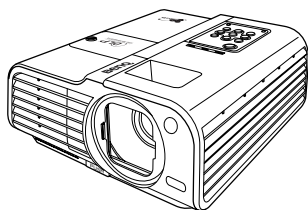

Projector



Soft carry case

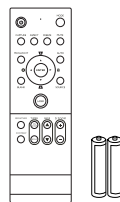

Remote control  
with batteries



Quick start guide



User manual CD



Soft cover



Warranty card\*



Safety manual\*



(UK)



(US)



(EU)



(AU)



(KOREA)



(CHINA)

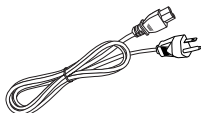

Power cord



(3-2  
power  
adaptor)

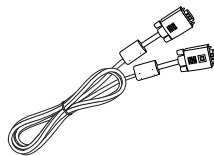

VGA cable

## Optional accessories

1. Spare lamp kit
2. Ceiling mount kit
3. Presentation Plus
4. RS232 cable

# Projector exterior view

## Front/upper side

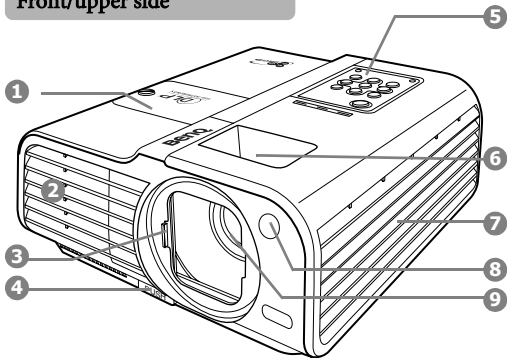

## Rear/lower side

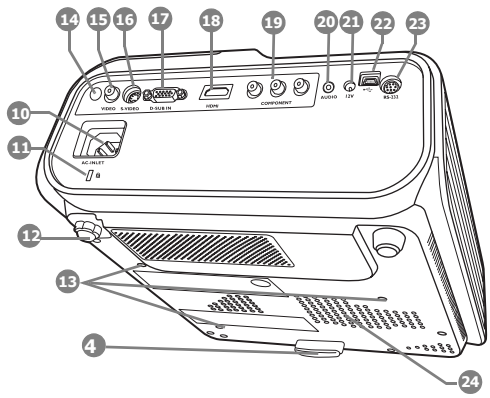

1. Lamp cover
2. Vent (heated air exhaust)
3. Lens sliding door
4. Quick-release button
5. External control panel  
(See "Projector" on page 10 for details.)
6. Focus ring and Zoom ring
7. Vent (cool air intake)
8. Front IR remote sensor
9. Projection lens
10. AC power cord inlet
11. Kensington anti-theft lock slot
12. Rear adjuster foot
13. Ceiling mounting holes
14. Rear IR remote sensor
15. Video input socket
16. S-Video input socket
17. RGB (PC)/Component Video (YPbPr/ YCbCr) signal input socket
18. HDMI input socket
19. Component Video signal input sockets
20. Audio socket
21. 12VDC output terminal  
Used to trigger external devices such as an electric screen or light control, etc.  
Consult your dealer for how to connect these devices.
22. USB socket
23. RS232 control port
24. Speaker grill

# Controls and functions

## Projector

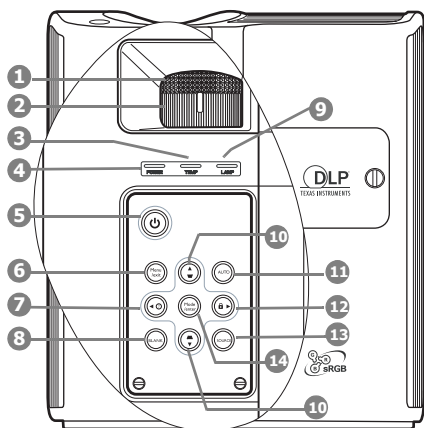

- 1. Focus ring**  
Adjusts the focus of the projected image. See ["Fine-tuning the image size and clarity" on page 33](#) for details.
- 2. Zoom ring**  
Adjusts the size of the image. See ["Fine-tuning the image size and clarity" on page 33](#) for details.
- 3. TEMPERATURE warning light**  
Lights up red if the projector's temperature becomes too high. See ["Indicators" on page 61](#) for details.
- 4. POWER indicator light**  
Lights up or flashes when the projector is under operation. See ["Indicators" on page 61](#) for details.
- 5. Power**  
Toggles the projector on or off. See ["Starting up the projector" on page 27](#) and ["Shutting down the projector" on page 47](#) for details.
- 6. MENU/EXIT**  
Turns on the On-Screen Display (OSD) menu. Goes back to previous OSD menu, exits and saves menu settings. See ["Using the menus" on page 28](#) for details.

- 7. Left/ ?**  
Starts the FAQ function. See ["Utilizing FAQ function" on page 44](#) for details.
- 8. BLANK**  
Used to hide the screen image. See ["Hiding the image" on page 43](#) for details.
- 9. LAMP indicator light**  
Indicates the status of the lamp. Lights up or flashes when the lamp has developed a problem. See ["Indicators" on page 61](#) for details.
- 10. Keystone/Arrow buttons ( ▽ / ▲ Up, ▽ / ▼ Down)**  
Manually corrects distorted images resulting from an angled projection. See ["Correcting keystone" on page 34](#) for details.
- 11. AUTO**  
Automatically determines the best picture timings for the displayed image. See ["Auto-adjusting the image" on page 33](#) for details.
- 12. Right/ Lock**  
Activates panel key lock. See ["Panel Key Lock" on page 52](#) for details.  
When the On-Screen Display (OSD) menu is activated, the #7, #10, and #12 buttons are used as directional arrows to select the desired menu items and to make adjustments. See ["Using the menus" on page 28](#) for details.
- 13. SOURCE**  
Displays the source selection bar. See ["Switching input signal" on page 32](#) for details.
- 14. Mode/enter**  
Selects an available picture setup mode. See ["Selecting a picture mode" on page 37](#) for details.  
Enacts the selected On-Screen Display (OSD) menu item. See ["Using the menus" on page 28](#) for details.

# Remote control

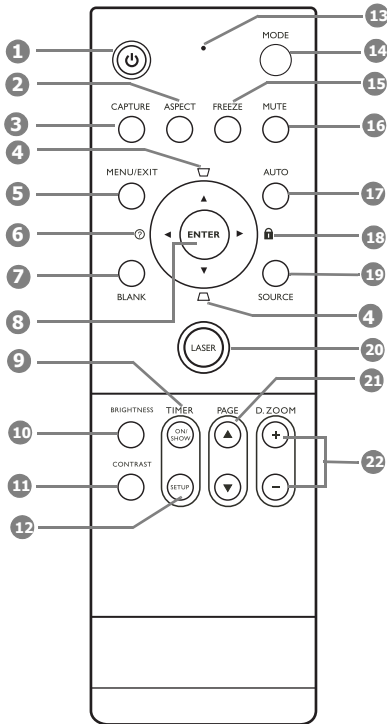

**1. Power**

Toggles the projector on or off. See ["Starting up the projector"](#) on page 27 and ["Shutting down the projector"](#) on page 47 for details.

**2. ASPECT**

Selects the display aspect ratio. See ["Selecting the aspect ratio"](#) on page 35 for details.

**3. CAPTURE**

Captures the projected picture and save it as your startup screen. See ["Creating your own startup screen"](#) on page 45 for details.

**4. Keystone/Arrow buttons ( ▽ / ▲ Up, ▢ / ▼ Down)**

Manually corrects distorted images resulting from an angled projection. See ["Correcting keystone"](#) on page 34 for details.

**5. MENU/EXIT**

Turns on the On-Screen Display (OSD) menu. Goes back to previous OSD menu, exits and saves menu settings. See ["Using the menus"](#) on page 28 for details.

**6. ◀ Left/ (?)**

Starts the FAQ function. See ["Utilizing FAQ function"](#) on page 44 for details.

**7. BLANK**

Used to hide the screen image. See ["Hiding the image"](#) on page 43 for details.

**8. ENTER**

Enacts the selected On-Screen Display (OSD) menu item. See ["Using the menus"](#) on page 28 for details.

**9. TIMER ON/SHOW**

Activates or displays an on-screen timer based on your own timer setting. See ["Setting the presentation timer"](#) on page 41 for details.

**10. BRIGHTNESS**

Adjusts brightness. See ["Adjusting Brightness"](#) on page 38 for details.

**11. CONTRAST**

Adjusts contrast. See ["Adjusting Contrast"](#) on page 38 for details.

**12. TIMER SETUP**

Enters presentation timer setting directly. See ["Setting the presentation timer"](#) on page 41 for details.

13. **Indicator light**  
Flashes or lights red when any key on the remote control is pressed.
14. **MODE**  
Depending upon which input signal is selected, selects an available picture mode. See "[Selecting a picture mode](#)" on page 37 for details.
15. **FREEZE**  
Freezes the projected image. See "[Freezing the image](#)" on page 43 for details.
16. **MUTE**  
Toggles projector audio between on and off.
17. **AUTO**  
Automatically determines the best picture timings for the displayed image. See "[Auto-adjusting the image](#)" on page 33 for details.
18. **▶ Right/🔒**  
Locks the buttons on the projector. See "[Locking control keys](#)" on page 44 for details.  
  
When the On-Screen Display (OSD) menu is activated, the #4, #6 and #18 buttons are used as directional arrows to select the desired menu items and to make adjustments. See "[Using the menus](#)" on page 28 for details.
19. **SOURCE**  
Displays the source selection bar. See "[Switching input signal](#)" on page 32 for details.
20. **LASER**  
Emits visible laser pointer light for presentation purposes. See "[Operating the LASER pointer](#)" on the right for details.
21. **PAGE ▲/▼**  
Operates your display software program (on a connected PC) which responds to page up/down commands (like Microsoft PowerPoint). See "[Remote paging operations](#)" on page 42 for details.

22. **D. ZOOM (+, -)**  
Magnifies or reduces the projected image size. See "[Magnifying and searching for details on the projected picture](#)" on page 34 for details.

## Operating the LASER pointer

The **LASER** Pointer is a presentation aid for professionals. It emits red colored light when you press it and the indicator lights up red.

The laser beam is visible. It is necessary to press and hold **LASER** for continuous output.

Avoid Exposure  
Laser radiation is emitted from this aperture

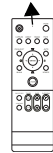

 **Do not look into the laser light window or shine the laser light beam on yourself or others. See the warning messages on the back of the remote control and the enclosed "User Information" prior to using it.**

The laser pointer is not a toy. Parents should be mindful of the dangers of laser energy and keep this remote control out of the reach of children.

## Remote control effective range

Infra-Red (IR) remote control sensors are located on the front and the back of the projector. The remote control must be held at an angle within 30 degrees perpendicular to the projector's IR remote control sensors to function correctly. The distance between the remote control and the sensors should not exceed 8 meters (~ 26 feet).

Make sure that there are no obstacles between the remote control and the IR sensors on the projector that might obstruct the infra-red beam.

- **Operating the projector from the front**

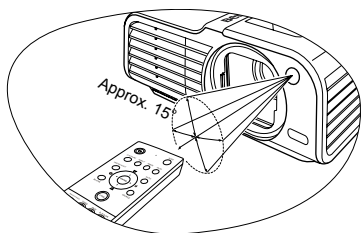

- **Operating the projector from the rear**

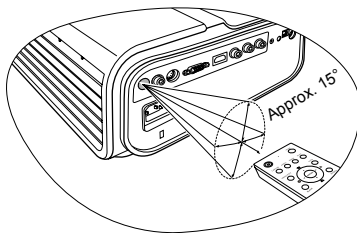

## Replacing the remote control batteries

1. To open the battery cover, turn the remote control over to view its back, push on the finger grip on the cover and slide it up in the direction of the arrow as illustrated. The cover will slide off.
2. Remove any existing batteries (if necessary) and install two AAA batteries observing the battery polarities as indicated in the base of the battery compartment. Positive (+) goes to positive and negative (-) goes to negative.
3. Refit the cover by aligning it with the base and sliding it back down into position. Stop when it clicks into place.

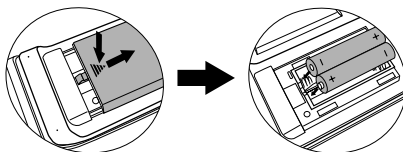

**!** Avoid leaving the remote control and batteries in an excessive heat or humid environment like the kitchen, bathroom, sauna, sunroom or in a closed car.

Replace only with the same or equivalent type recommended by the battery manufacturer.

Dispose of the used batteries according to the manufacturer's instructions and local environment regulations for your region.

Never throw the batteries into a fire. There may be danger of an explosion.

If the batteries are dead or if you will not be using the remote control for an extended period of time, remove the batteries to avoid damage to the remote control from possible battery leakage.

# Positioning your projector

## Choosing a location

Your projector is designed to be installed in one of four possible installation locations:

### 1. Front Table

Select this location with the projector placed near the floor in front of the screen. This is the most common way to position the projector for quick setup and portability.

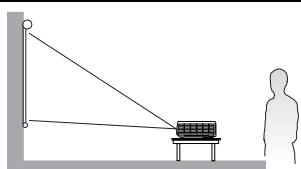

### 2. Front Ceiling

Select this location with the projector suspended upside-down from the ceiling in front of the screen.

Purchase the BenQ Projector Ceiling Mounting Kit from your dealer to mount your projector on the ceiling.

Set **Front Ceiling** in the **SYSTEM SETUP: Basic > Projector Position** menu after you turn the projector on.

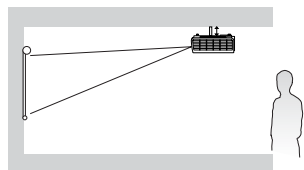

### 3. Rear Table

Select this location with the projector placed near the floor behind the screen.

Note that a special rear projection screen is required.

Set **Rear Table** in the **SYSTEM SETUP: Basic > Projector Position** menu after you turn the projector on.

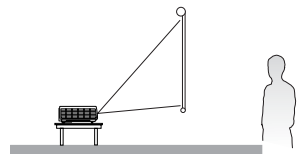

### 4. Rear Ceiling

Select this location with the projector suspended upside-down from the ceiling behind the screen.

Note that a special rear projection screen and the BenQ Projector Ceiling Mounting Kit are required for this installation location.

Set **Rear Ceiling** in the **SYSTEM SETUP: Basic > Projector Position** menu after you turn the projector on.

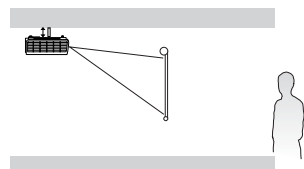

Your room layout or personal preference will dictate which installation location you select. Take into consideration the size and position of your screen, the location of a suitable power outlet, as well as the location and distance between the projector and the rest of your equipment.

# Obtaining a preferred projected image size

The distance from the projector lens to the screen, the zoom setting, and the video format each factors in the projected image size.

The projector should always be placed horizontally level (like flat on a table), and positioned directly perpendicular (90° right-angle square) to the horizontal center of the screen. This prevents image distortion caused by angled projections (or projecting onto angled surfaces).

The modern digital projector does not project directly forward (like older style reel-to-reel film projectors did). Instead, digital projectors are designed to project at a slightly upward angle above the horizontal plane of the projector. This is so that they can be readily placed on a table and will project forward and upwards onto a screen positioned so that the bottom edge of the screen is above the level of the table (and everyone in the room can see the screen).

If the projector is mounted on a ceiling, it must be mounted upside-down so that it projects at a slightly downward angle.

You can see from the diagrams on pages 17-20, that this type of projection causes the bottom edge of the projected image to be vertically offset from the horizontal plane of the projector. When ceiling mounted, this refers to the top edge of the projected image.

If the projector is positioned further away from the screen, the projected image size increases, and the vertical offset also increases proportionately.

When determining the position of the screen and projector, you will need to account for both the projected image size and the vertical offset dimension, which are directly proportional to the projection distance.

BenQ has provided tables of 16:9-aspect-ratio and 4:3-aspect-ratio screen sizes to assist you in determining the ideal location for your projector. There are two dimensions to consider, the perpendicular horizontal distance from the center of the screen (projection distance), and the vertical offset height of the projector from the horizontal edge of the screen (offset).

## How to determine the position of the projector for a given screen size

1. Determine the aspect ratio of your screen, 16:9 or 4:3? If you have a 16:9 screen, refer to page 17 or 18. If you have a 4:3 screen, refer to page 19 or 20 depending on the projected picture aspect ratio you've got.
2. Select your screen size.
3. Refer to the table and find the closest match to your screen size in the left columns labelled "Screen Dimensions". Using this value, look across this row to the right to find the corresponding average distance from screen value in the column labelled "Average". This is the projection distance.
4. On that same row, look across to the right column and make note of the "Vertical Offset" value. This will determine the final vertical offset placement of the projector in relation to the edge of the screen.
5. The recommended position for the projector is aligned perpendicular to the horizontal center of the screen, at the distance from the screen determined in step 3 above, and offset by the value determined in step 4 above.

For example, if you are using an 120-inch, 4:3-aspect-ratio screen and the projected picture is 16:10, please refer to [Table B2](#) on page 20. The average projection distance is 4180 mm and with a vertical offset of 61 mm.



# How to determine the recommended screen size for a given distance

This method can be used for situations where you have purchased this projector and would like to know what screen size will fit in your room.

The maximum screen size is limited by the physical space available in your room.

1. Determine the aspect ratio of the screen you need, 16:9 or 4:3? If you need a 16:9 screen, refer to [Table A1](#) (page 17) or [Table A2](#) (page 18). If you need a 4:3 screen, refer to [Table B1](#) (page 19) or [Table B2](#) (page 20) depending on the projected picture aspect ratio you've got.
2. Measure the distance between the projector and where you want to position the screen. This is the projection distance.
3. Refer to the table and find the closest match to your measurement in the average distance from screen column labelled "[Average](#)". Check that your measured distance is between the min and max distances listed on either side of the average distance value.
4. Using this value, look across that row to the left to find the corresponding "[Screen Dimensions](#)" listed in that row. That is the projected image size of the projector at that projection distance.
5. On that same row, look across to the right column and make note of the "[Vertical Offset](#)" value. This will determine the final placement of the screen in relation to the horizontal plane of the projector.

For example, if you need a 16:9 screen to project a 16:9 picture and your measured projection distance was 4.8 m (4800 mm), please refer to [Table A1](#) on page 17. The closest match in the "[Average](#)" column is 4554 mm. Looking across this row shows that a 120" (about 3.0 m) screen is required.

If you place the projector in a different position (to that recommended), you will have to tilt it down or up to center the image on the screen. In these situations, some image distortion will occur. Use the Keystone function to correct the distortion. See "[Correcting keystone](#)" on [page 34](#) for details.

# Projection dimensions

Refer to "Dimensions" on page 64 for the center of lens dimensions of this projector before calculating the appropriate position.

**When the screen aspect ratio is 16:9 and the projected picture is 16:9**

### Floor Installation

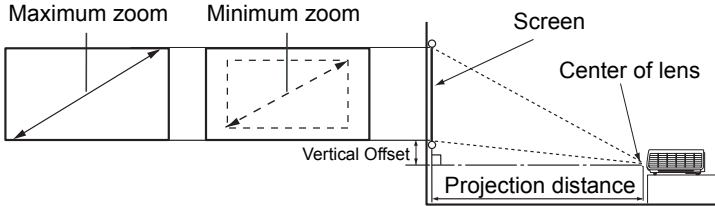

### Ceiling Installation

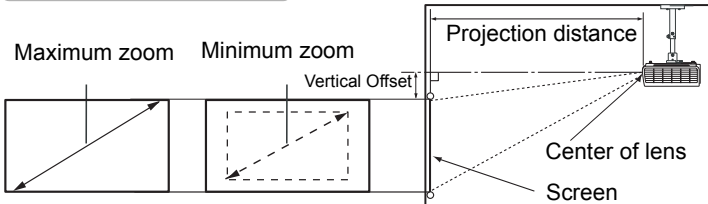
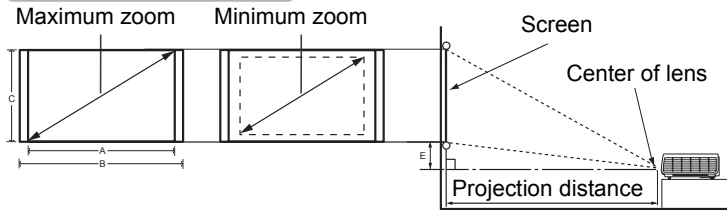

Table A1: The screen aspect ratio is 16:9 and the projected picture is 16:9

Screen Dimensions					Projected Picture size		Distance from Screen in mm			Vertical Offset
Diagonal			Height	Width	Height	Width	Min	Average	Max	
Feet	Inches	mm	mm	mm	mm	mm	(Max zoom)		(Min zoom)	mm
2.5	30	762	374	664	374	664	1054	1138	1223	37
4.2	50	1270	623	1107	623	1107	1757	1897	2038	62
6.7	80	2032	996	1771	996	1771	2811	3036	3261	100
8.3	100	2540	1245	2214	1245	2214	3514	3795	4076	125
10.0	120	3048	1494	2656	1494	2656	4217	4554	4891	149
12.5	150	3810	1868	3320	1868	3320	5271	5692	6114	187
15.0	180	4572	2241	3984	2241	3984	6325	6831	7337	224
16.7	200	5080	2490	4427	2490	4427	7028	7590	8152	249
18.3	220	5588	2739	4870	2739	4870	7730	8349	8967	274
20.0	240	6096	2988	5312	2988	5312	8433	9108	9783	299
22.5	270	6858	3362	5976	3362	5976	9487	10246	11005	336
25.0	300	7620	3735	6641	3735	6641	10542	11385	12228	374

## When the screen aspect ratio is 16:9 and the projected picture is 16:10

### Floor Installation



### Ceiling Installation

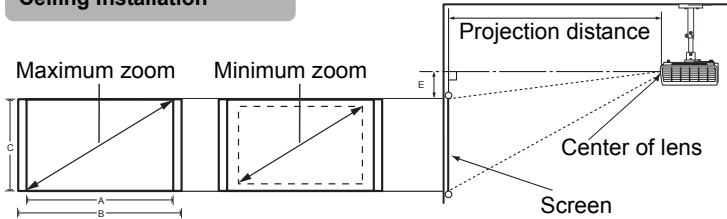
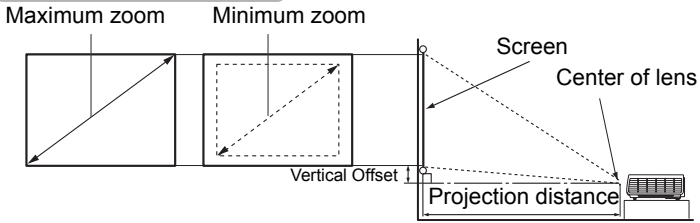

Table A2: The screen aspect ratio is 16:9 and the projected picture is 16:10

Screen Dimensions					Projected picture size		Distance from Screen in mm			Vertical Offset (E)
Diagonal			Height (C)	Width (B)	Height (C)	Width (A)	Min (Max zoom)	Average	Max (Min zoom)	
Feet	Inches	mm	mm	mm	mm	mm				mm
2.5	30	762	374	664	374	598	949	1025	1100	29
4.2	50	1270	623	1107	623	996	1581	1708	1834	49
6.7	80	2032	996	1771	996	1594	2530	2732	2934	78
8.3	100	2540	1245	2214	1245	1992	3162	3415	3668	98
10.0	120	3048	1494	2656	1494	2391	3794	4098	4402	117
12.5	150	3810	1868	3320	1868	2988	4743	5123	5502	147
15.0	180	4572	2241	3984	2241	3586	5692	6147	6602	176
16.7	200	5080	2490	4427	2490	3984	6324	6830	7336	195
18.3	220	5588	2739	4870	2739	4383	6957	7513	8070	215
20.0	240	6096	2988	5312	2988	4781	7589	8196	8803	235
22.5	270	6858	3362	5976	3362	5379	8538	9221	9904	264
25.0	300	7620	3735	6641	3735	5976	9486	10245	11004	293

## When the screen aspect ratio is 4:3 and the projected picture is 4:3

### Floor Installation



### Ceiling Installation

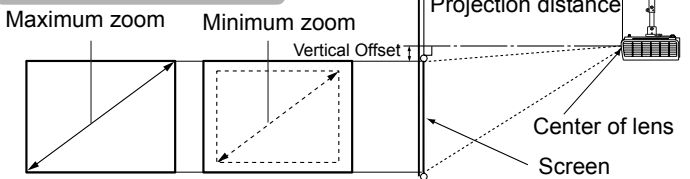

Table B1: The screen aspect ratio is 4:3 and the projected picture is 4:3

Screen Dimensions					Projected picture size		Distance from Screen in mm			Vertical Offset
Diagonal			Height	Width	Height	Width	Min	Average	Max	mm
Feet	Inches	mm	mm	mm	mm	mm	(Max zoom)		(Min zoom)	
2.5	30	762	457	610	457	610	1161	1254	1347	18
4.2	50	1270	762	1016	762	1016	1935	2090	2245	30
6.7	80	2032	1219	1626	1219	1626	3097	3344	3592	49
8.3	100	2540	1524	2032	1524	2032	3871	4180	4490	61
10.0	120	3048	1829	2438	1829	2438	4645	5017	5388	73
12.5	150	3810	2286	3048	2286	3048	5806	6271	6735	91
15.0	180	4572	2743	3658	2743	3658	6967	7525	8082	110
16.7	200	5080	3048	4064	3048	4064	7742	8361	8980	122
18.3	220	5588	3353	4470	3353	4470	8516	9197	9878	134
20.0	240	6096	3658	4877	3658	4877	9290	10033	10776	146
22.5	270	6858	4115	5486	4115	5486	10451	11287	12123	165
25.0	300	7620	4572	6096	4572	6096	11612	12541	13470	183

## When the screen aspect ratio is 4:3 and the projected picture is 16:10

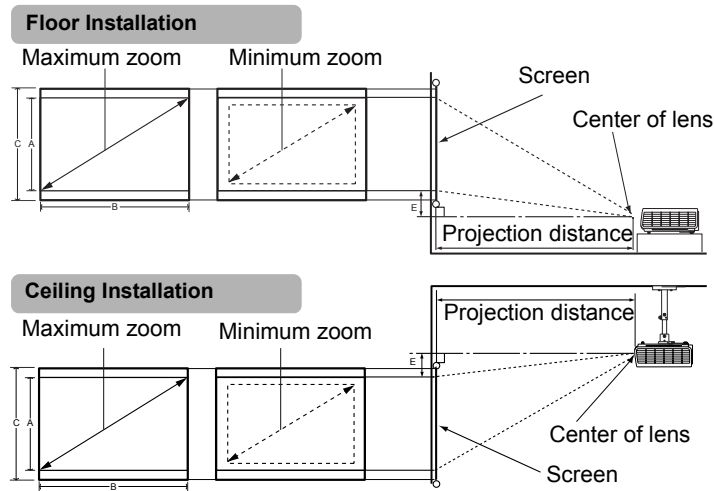

Table B2: The screen aspect ratio is 4:3 and the projected picture is 16:10

Screen Dimensions					Projected picture size		Distance from Screen in mm			Vertical Offset (E)
Diagonal			Height C	Width B	Height A	Width B	Min (Max zoom)	Average	Max (Min zoom)	
Feet	Inches	mm	mm	mm	mm	mm				mm
2.5	30	762	457	610	381	610	968	1045	1122	15
4.2	50	1270	762	1016	635	1016	1613	1742	1871	25
6.7	80	2032	1219	1626	1016	1626	2580	2787	2993	41
8.3	100	2540	1524	2032	1270	2032	3225	3483	3741	51
10.0	120	3048	1829	2438	1524	2438	3870	4180	4490	61
12.5	150	3810	2286	3048	1905	3048	4838	5225	5612	76
15.0	180	4572	2743	3658	2286	3658	5806	6270	6734	91
16.7	200	5080	3048	4064	2540	4064	6451	6967	7483	102
18.3	220	5588	3353	4470	2794	4470	7096	7663	8231	112
20.0	240	6096	3658	4877	3048	4877	7741	8360	8979	122
22.5	270	6858	4115	5486	3429	5486	8708	9405	10102	137
25.0	300	7620	4572	6096	3810	6096	9676	10450	11224	152

There is 3% tolerance among these numbers in Table A1, Table A2, Table B1, and Table B2 due to optical component variations.

BenQ recommends that if you intend to permanently install the projector, you should physically test the projection size and distance using the actual projector in situ before you permanently install it, so as to make allowance for this projector's optical characteristics. This will help you determine the exact mounting position so that it best suits your installation location.

# Connection

When connecting a signal source to the projector, be sure to:

1. Turn all equipment off before making any connections.
2. Use the correct signal cables for each source.
3. Ensure the cables are firmly inserted.

 In the connections shown below, some cables may not be included with the projector (see "Shipping contents" on page 8). They are commercially available from electronics stores.

## Connecting a computer or monitor

### Connecting a computer

The projector provides a VGA socket that allow you to connect it to both IBM® compatibles and Macintosh® computers. A Mac adapter (an optional accessory) is needed if you are connecting legacy version Macintosh computers.

Additionally, you can also connect the projector to a computer via the USB cable so you can perform paging operations of the application on the PC or notebook.

#### To connect the projector to a notebook or desktop computer

1. Take the supplied VGA cable and connect one end to the D-Sub output socket of the computer.
2. Connect the other end of the VGA cable to the D-SUB IN signal input socket on the projector.
3. If you wish to use the remote paging function, take a USB cable and connect the larger end to the USB port of the computer, and the smaller end to the USB socket on the projector. See "Remote paging operations" on page 42 for details.
4. If you wish to make use of the projector (mixed mono) speaker in your presentations, take a suitable audio cable and connect one end of the cable to the audio output socket of the computer, and the other end to the AUDIO socket of the projector.

Once connected, the audio can be controlled by the projector On-Screen Display (OSD) menus. See "Audio Settings" on page 53 for details.

The final connection path should be like that shown in the following diagram:

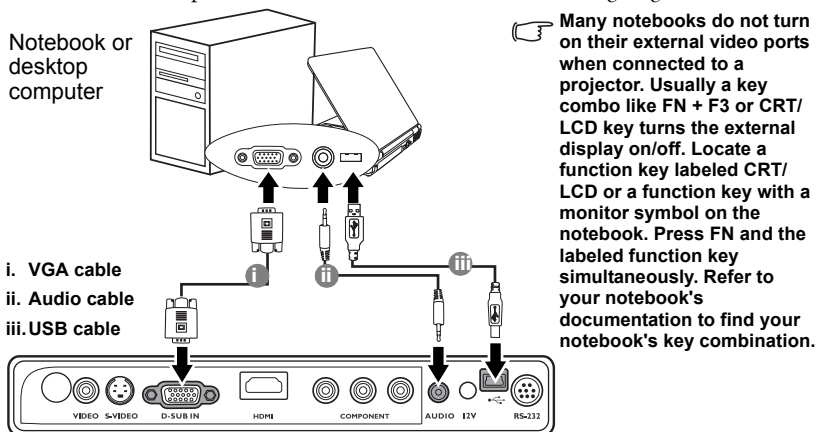

# Connecting Video source devices

This section describes how to connect the projector to Video source devices using video cables. Video cable connections are recommended for Video presentations.

You can connect your projector to various Video source devices that provide any one of the following output sockets:

- HDMI
- Component Video
- S-Video
- Video (composite)

You need only connect the projector to a Video source device using just one of the above connecting methods, however each provides a different level of video quality. The method you choose will most likely depend upon the availability of matching terminals on both the projector and the Video source device as described below:

## Best video quality

The best available video connection method is HDMI. HDMI (High-Definition Multimedia Interface) supports uncompressed video data transmission between compatible devices like DTV tuners, DVD players and displays over a single cable. It provides pure digital viewing experience.

See ["Connecting an HDMI device" on page 23](#) for how to connect the projector to a HDMI device.

If no HDMI source is available, the next best video signal is Component Video (not to be confused with composite Video). Digital TV tuners and DVD players output Component Video natively, so if available on your devices, they should be your connection method of choice in preference to S-Video or (composite) Video.

See ["Connecting a Component Video source device" on page 24](#) for how to connect the projector to a component video device.

## Better video quality

The S-Video method provides a better quality analog video than standard composite Video. If you have both composite Video and S-Video output terminals on your Video source device, you should elect to use the S-Video option.

See ["Connecting an S-Video source device" on page 25](#) for how to connect the projector to an S-Video device.

## Least video quality

Composite Video is an analog video and will result in a perfectly acceptable, but less than optimal result from your projector, being the least video quality of the available methods described here.

See ["Connecting a composite Video source device" on page 26](#) for how to connect the projector to a composite Video device.

## Connecting Audio

The projector has a built-in mono speaker which is designed to provide basic audio functionality accompanying data presentations for business purposes only. It is not designed for, nor intended for stereo audio reproduction use as might be expected in home theater or home cinema applications. Any stereo audio input (if provided), is mixed into a common mono audio output through the projector speaker.

## Connecting an HDMI device

You should use an HDMI cable when making connection between the projector and HDMI devices.

### To connect the projector to an HDMI device:

1. Take an HDMI cable and connect one end to the HDMI output socket of the video device.
2. Connect the other end of the cable to the HDMI input socket on the projector.
3. If you wish to make use the projector (mixed mono) speaker, take a suitable audio cable and connect one end of the cable to the audio output sockets of the video device, and the other end to the AUDIO socket of the projector.

Once connected, the audio can be controlled by the projector On-Screen Display (OSD) menus. See ["Audio Settings" on page 53](#) for details.

A/V device

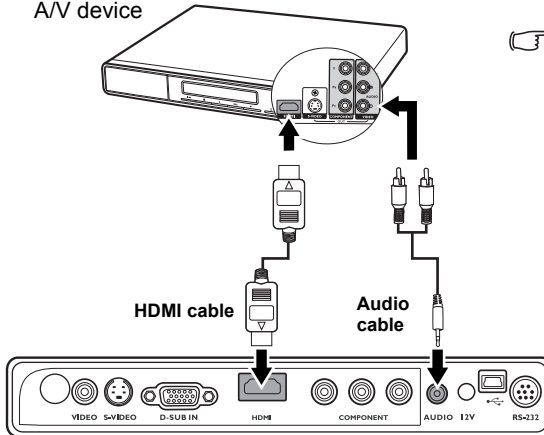

In the unlikely event that you connect the projector to a DVD player via the projector's HDMI input and the projected picture displays wrong colors, please change the color space to YUV. See ["Changing Color Space" on page 32](#) for details.



## Connecting a Component Video source device

Examine your Video source device to determine if it has a set of unused Component Video output sockets available:

- If so, you can continue with this procedure.
- If not, you will need to reassess which method you can use to connect to the device.

### To connect the projector to a Component Video source device (either through a Component Video to VGA (D-Sub) adaptor cable or Component cable):

<ul style="list-style-type: none"> <li>• With a Component Video to VGA (D-Sub) adaptor cable:</li> </ul>	<ul style="list-style-type: none"> <li>• With a Component Video cable:</li> </ul>
<ol style="list-style-type: none"> <li>1. Take a Component Video to VGA (D-Sub) adaptor cable and connect the end with 3 RCA type connectors to the Component Video output sockets of the Video source device. Match the color of the plugs to the color of the sockets; green to green, blue to blue; and red to red.</li> </ol>	
<ol style="list-style-type: none"> <li>2. Connect the other end of the Component Video to VGA (D-Sub) adaptor cable (with a D-Sub type connector) to the D-SUB IN socket on the projector.</li> </ol>	<ol style="list-style-type: none"> <li>2. Connect the other end with 3 RCA type connectors to the COMPONENT sockets of the projector. Match the color of the plugs to the color of the sockets; green to green, blue to blue, and red to red.</li> </ol>
<ol style="list-style-type: none"> <li>3. If you wish to make use of the projector (mixed mono) speaker in your presentations, take a suitable audio cable and connect one end of the cable to the audio output socket of the device, and the other end to the AUDIO socket of the projector. Once connected, the audio can be controlled by the projector On-Screen Display (OSD) menus. See "<a href="#">Audio Settings</a>" on page 53 for details.</li> </ol>	

The final connection path should be like that shown in the following diagram:

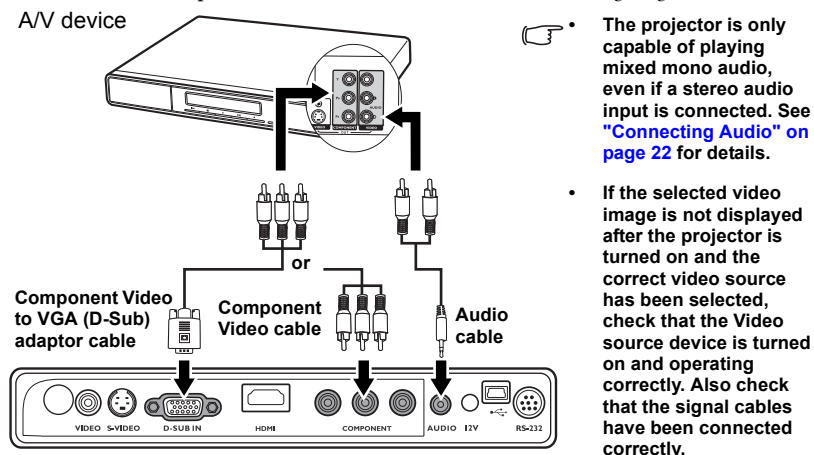

# Connecting an S-Video source device

Examine your Video source device to determine if it has an unused S-Video output socket available:

- If so, you can continue with this procedure.
- If not, you will need to reassess which method you can use to connect to the device.

## To connect the projector to an S-Video source device:

1. Take an S-Video cable and connect one end to the S-Video output socket of the Video source device.
2. Connect the other end of the S-Video cable to the S-VIDEO socket on the projector.
3. If you wish to make use of the projector (mixed mono) speaker in your presentations, take a suitable audio cable and connect one end of the cable to the audio output socket of the device, and the other end to the AUDIO socket of the projector.

Once connected, the audio can be controlled by the projector On-Screen Display (OSD) menus. See ["Audio Settings" on page 53](#) for details.

The final connection path should be like that shown in the following diagram:

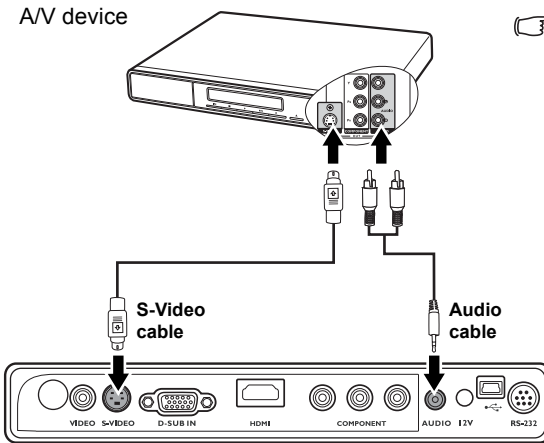

- **The projector is only capable of playing mixed mono audio, even if a stereo audio input is connected. See ["Connecting Audio" on page 22](#) for details.**
- **If the selected video image is not displayed after the projector is turned on and the correct video source has been selected, check that the Video source device is turned on and operating correctly. Also check that the signal cables have been connected correctly.**
- **If you have already made a Component Video connection between the projector and this S-Video source device using Component Video connections, you need not connect to this device using an S-Video connection as this makes an unnecessary second connection of poorer picture quality. See ["Connecting Video source devices" on page 22](#) for details.**

## Connecting a composite Video source device

Examine your Video source device to determine if it has a set of unused composite Video output sockets available:

- If so, you can continue with this procedure.
- If not, you will need to reassess which method you can use to connect to the device.

### To connect the projector to a composite Video source device:

1. Take a Video cable and connect one end to the composite Video output socket of the Video source device.
2. Connect the other end of the Video cable to the VIDEO socket on the projector.

The final connection path should be like that shown in the following diagram:

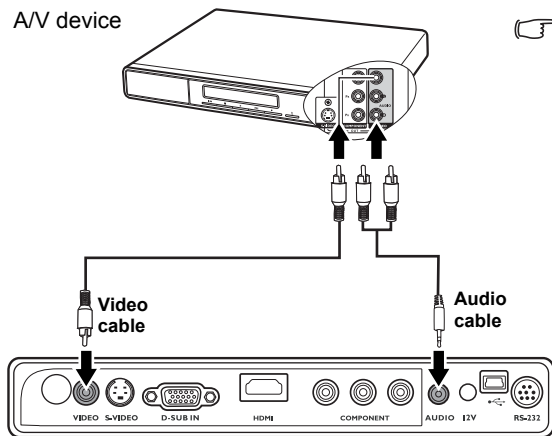

- The projector is only capable of playing mixed mono audio, even if a stereo audio input is connected. See ["Connecting Audio" on page 22](#) for details.
- If the selected video image is not displayed after the projector is turned on and the correct video source has been selected, check that the Video source device is turned on and operating correctly. Also check that the signal cables have been connected correctly.
- You need only connect to this device using a composite Video connection if Component Video and S-Video inputs are unavailable for use. See ["Connecting Video source devices" on page 22](#) for details.

# Operation

## Starting up the projector

1. Plug the power cord into the projector and into a wall socket. Turn on the wall socket switch (where fitted). Check that the **Power indicator** on the projector lights orange after power has been applied.

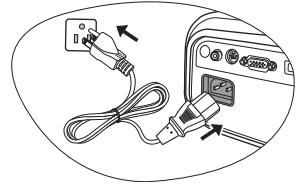

2. Slide the lens cover open. If it is closed, it could become deformed due to the heat produced by the projection lamp.

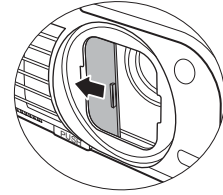

3. Press **Power** on the projector or remote control to start the projector. As soon as the lamp lights up, a "Power On Tone" will be heard. The **Power indicator light** flashes green and stays green when the projector is on.

The start up procedure takes about 30 seconds. In the later stage of start up, a startup logo is projected.

(If necessary) Rotate the focus ring to adjust the image clearness.

To turn of the ring tone, see "[Turning off the Power on/off ring tone](#)" on page 46 for details.

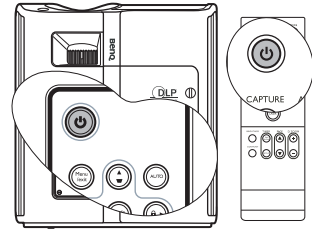

**If the projector is still hot from previous activity, it will run the cooling fan for approximately 90 seconds before energizing the lamp.**

4. If you are prompted for a password, press the arrow buttons to enter a six digit password. See "[Utilizing the password function](#)" on page 29 for details.
5. Switch all of the connected equipment on.
6. The projector will start to search for input signals. The current input source being scanned displays in the upper left corner of the screen. If the projector doesn't detect a valid signal, the 'No Signal' message will continue displaying until an input source signal is found.

You can also press **SOURCE** on the projector or remote control to select your desired input signal. See "[Switching input signal](#)" on page 32 for details.

**If the frequency/resolution of the input signal exceeds the projector's operating range, you will see the message 'Out of Range' displayed on a blank screen. Please change to an input signal which is compatible with the projector's resolution or set the input signal to a lower setting. See "[Timing chart](#)" on page 65 for details.**

# Using the menus

The projector is equipped with On-Screen Display (OSD) menus for making various adjustments and settings.

Below is the overview of the OSD menu.



To use the OSD menus, please set the OSD menu to your familiar language first.

1. Press **MENU/EXIT** on the projector or remote control to turn the OSD menu on.
3. Press **▼** to highlight **Language** and press **◀/▶** to select a preferred language.



2. Use **◀/▶** to highlight the **SYSTEM SETUP: Basic** menu.
4. Press **MENU/EXIT** twice\* on the projector or remote control to leave and save the settings.



\*The first press leads you back to the main menu and the second press closes the OSD menu.

# Securing the projector

## Using a security cable lock

The projector has to be installed in a safe place to prevent stealing. If not, purchase a lock, like Kensington lock, to secure the projector. You can locate a Kensington lock slot on the rear side of the projector. See item 11 on page 9 for details.

A Kensington security cable lock is usually the combination of key(s) and lock. Refer to the lock's documentation about how to use it.

## Removing the control keypad on the projector

The control key pad on the projector is detachable. Once the key pad is removed from the projector, it is not possible to operate the projector without the control keypad or remote control. We would suggest that you keep the control key pad and remote control away from the projector in case they are taken together with the projector.

To remove the control keypad:

1. Locate the screw locations on the lower corner of the control keypad.
2. Completely loosen the screws.
3. Lift the control key pad by pulling the screws.
4. Remove the control key pad from the projector.
5. After removing the control keypad from the projector, you can use the soft cover supplied to cover the keypad socket if necessary.

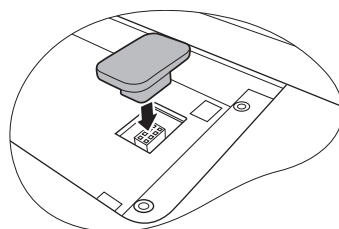
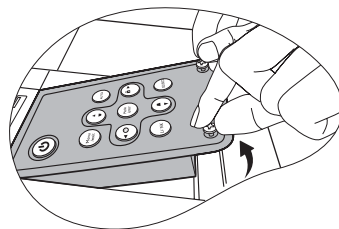
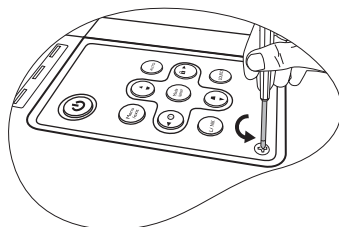

## Utilizing the password function

For security purposes and to help prevent unauthorized use, the projector includes an option for setting up password security. The password can be set through the On-Screen Display (OSD) menu.

**!** **WARNING: You will be inconvenienced if you activate the password functionality and subsequently forget the password. Print out this manual (if necessary) and write the password you used in this manual, and keep the manual in a safe place for later recall.**

## Setting a password

Once a password has been set and the power on lock is activated, the projector cannot be used unless the correct password is entered every time the projector is started.

Once a password has been set and the splash screen lock is activated, you cannot change the splash screen that displays at projector startup unless the correct password is entered.

1. Open the OSD menu and go to the **SYSTEM SETUP: Advanced > Security Settings** menu. Press **Mode/enter** on the projector or **ENTER** on the remote control. The Security Settings page displays.
2. Highlight **Change Security Settings** and press **Mode/enter** on the projector or **ENTER** on the remote control.
3. As pictured to the right, the four arrow buttons (**▲**, **▶**, **▼**, **◀**) respectively represent 4 digits (1, 2, 3, 4). According to the password you desire to set, press the arrow buttons to enter six digits for the password.
4. Confirm the new password by re-entering the new password.  
Once the password is set, the OSD menu returns to the **Security Settings** page.



5. To activate the **Power On Lock** function, press **▲/▼** to highlight **Power On Lock** and press **◀/▶** to select **On**.
6. To activate the **Splash Screen Lock** function, press **▲/▼** to highlight **Splash Screen Lock** and press **◀/▶** to select **On**.  
When the **Splash Screen Lock** is activated, the **My Screen** function in the **SYSTEM SETUP: Basic** menu will be password-protected.

**IMPORTANT:** The digits being input will display as asterisks on-screen. Write your selected password down here in this manual in advance or right after the password is entered so that it is available to you should you ever forget it.

Password: \_ \_ \_ \_ \_

Keep this manual in a safe place.

7. To leave the OSD menu, press **MENU/EXIT**.

## If you forget the password

If the password function is activated, you will be asked to enter the six digit password every time you turn on the projector. If you enter the wrong password, the password error message as pictured to the right displays lasting for three seconds, and the **INPUT PASSWORD** message follows. You can retry by entering another six-digit password, or if you did not record the password in this manual, and you absolutely do not remember it, you can use the password recall procedure. See "[Entering the password recall procedure](#)" on page 31 for details.

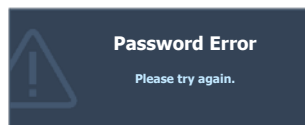

If you enter an incorrect password 5 times in succession, the projector will automatically shut down in a short time.

## Entering the password recall procedure

Press and hold **AUTO** on the projector or remote control for 3 seconds. The projector will display a coded number on the screen. Write down the number and turn off your projector. Seek help from the local BenQ service center to decode the number. You may be required to provide proof of purchase documentation to verify that you are an authorized user of the projector.

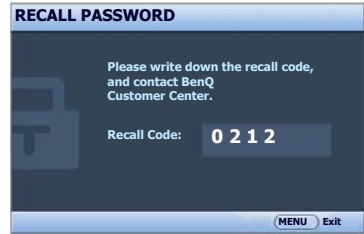

## Changing the password

1. Open the OSD menu and go to the **SYSTEM SETUP: Advanced > Security Settings > Change Password** menu.
2. Press **Mode/enter** on the projector or **ENTER** on the remote control. The message '**INPUT CURRENT PASSWORD**' displays.
3. Enter the old password.
  - i. If the password is correct, another message '**INPUT NEW PASSWORD**' displays.
  - ii. If the password is incorrect, the password error message displays lasting for three seconds, and the message '**INPUT CURRENT PASSWORD**' displays for your retry. You can press **MENU/EXIT** to cancel the change or try another password.
4. Enter a new password.

 **IMPORTANT:** The digits being input will display as asterisks on-screen. Write your selected password down here in this manual in advance or right after the password is entered so that it is available to you should you ever forget it.

Password: \_ \_ \_ \_ \_

Keep this manual in a safe place.

5. Confirm the new password by re-entering the new password.
6. You have successfully assigned a new password to the projector. Remember to enter the new password next time the projector is started.
7. To leave the OSD menu, press **MENU/EXIT**.



## Disabling the password function

To disable password protection, go back to the **SYSTEM SETUP: Advanced > Security Settings > Change Security Settings** menu after opening the OSD menu system. Press **Mode/enter**. The message '**INPUT PASSWORD**' displays. Enter the current password.

- i. If the password is correct, the OSD menu returns to the **Security Settings** page. Press **▼** to highlight **Power On Lock** and press **◀/▶** to select **Off**. You will not have to enter the password next time when turning on the projector. Press **▼** to highlight **Splash Screen Lock** and press **◀/▶** to select **Off**. The **Splash Screen** function in the **SYSTEM SETUP: Basic** menu will be available for your change.
- ii. If the password is incorrect, the password error message displays lasting for three seconds, and the message '**INPUT PASSWORD**' displays for your retry. You can press **MENU/EXIT** to cancel the change or try another password.



☞ Though the password function is disabled, you need to keep the old password in hand should you ever need to re-activate the password function by entering the old password.

## Switching input signal

The projector can be connected to multiple devices at the same time. However, it can only display one full screen at a time. When starting up, the projector automatically search for the available signals.

Be sure the **Quick Auto Search** function in the **SOURCE** menu is **On** (which is the default of this projector) if you want the projector to automatically search for the signals.

You can also manually cycle through the available input sources.

1. Press **SOURCE** on the projector or remote control. A source selection bar displays.
2. Press **▲/▼** until your desired signal is selected and press **Mode/enter** on the projector or **ENTER** on the remote control.

Once detected, the selected source information will display at the corner of the screen for seconds. If there is multiple equipment connected to the projector, repeat steps 1-2 to search for another signal.

- ☞ • The brightness level of the projected image will change accordingly when you switch between different input signals. Data (graphic) "PC" presentations using mostly static images are generally brighter than "Video" using mostly moving images (movies).

The input signal type effects the options available for the Picture Mode. See "[Selecting a picture mode](#)" on page 37 for details.

- The native display resolution of this projector is in a 4:3 aspect ratio. For best display picture results, you should select and use an input source which outputs at this resolution. Any other resolutions will be scaled by the projector depending upon the 'aspect ratio' setting, which may cause some image distortion or loss of picture clarity. See "[Selecting the aspect ratio](#)" on page 35 for details.

### Changing Color Space

In the unlikely event that you connect the projector to a DVD player via the projector's **HDMI** input and the projected picture displays wrong colors, please change the color space to **YUV**.

To do this:

1. Press **MENU/EXIT** and then press **◀/▶** until the **SOURCE** menu is highlighted.
2. Press **▼** to highlight **Color Space Conversion** and press **◀/▶** to select **YUV**.

☞ This function is only available when the HDMI input socket is in use.

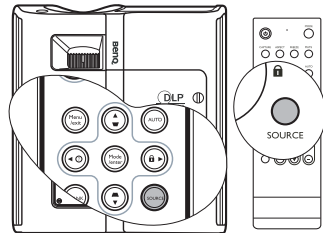

# Adjusting the projected image

## Adjusting the projection angle

The projector is equipped with 1 quick-release adjuster foot and 1 rear adjuster foot. These adjusters change the image height and projection angle. To adjust the projector:

1. Press the quick-release button and lift the front of the projector. Once the image is positioned where you want it, release the quick-release button to lock the foot in position.
2. Screw the rear adjuster foot to fine tune the horizontal angle.

To retract the foot, hold up the projector while pressing the quick-release button, then slowly lower the projector. Screw the rear adjuster foot in a reverse direction.

If the projector is not placed on a flat surface or the screen and the projector are not perpendicular to each other, the projected image becomes trapezoidal. To correct this situation, see "[Correcting keystone](#)" on [page 34](#) for details.

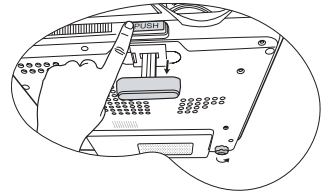

**Do not look into the lens while the lamp is on. The strong light from the lamp may cause damage to your eyes.**

**Be careful when you press the adjuster button as it is close to the exhaust vent where hot air comes from.**

## Auto-adjusting the image

In some cases, you may need to optimize the picture quality. To do this, press **AUTO** on the projector or remote control. Within 3 seconds, the built-in Intelligent Auto Adjustment function will re-adjust the values of Frequency and Clock to provide the best picture quality.

The current source information will be displayed in the corner of the screen for 3 seconds.

 **The screen will be blank while AUTO is functioning.**

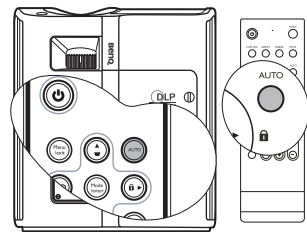

## Fine-tuning the image size and clarity

1. Adjust the projected image to the size that you need using the zoom ring.
2. Then sharpen the image by rotating the focus ring.

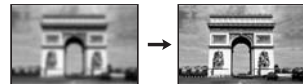

## Correcting keystone

Keystoning refers to the situation where the projected image is noticeably wider at either the top or bottom. It occurs when the projector is not perpendicular to the screen.

To correct this, besides adjusting the height of the projector, you will need to manually correct it following ONE of these steps.

- Press  $\nabla$  /  $\triangle$  on the control panel of the projector or remote control to display the Keystone correction page. Press  $\nabla$  to correct keystoning at the top of the image. Press  $\triangle$  to correct keystoning at the bottom of the image.
- Press **MENU/EXIT** on the projector or remote control. Go to the **DISPLAY > Keystone** and adjust the values by pressing  $\nabla$  or  $\triangle$  on the projector or remote control.

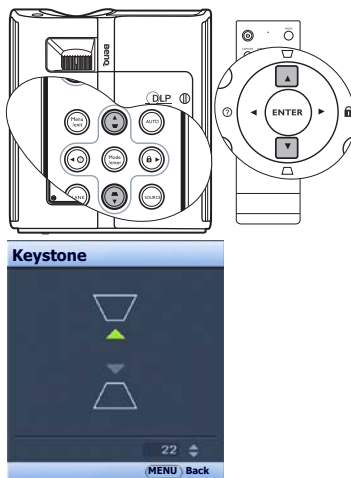

## Magnifying and searching for details on the projected picture

If you need to find the details on the projected picture, magnify the picture. Use the direction arrow keys for navigating the picture.

- Using the remote control
  1. Press **D. ZOOM +/-** to display the Zoom bar. Press **D. ZOOM +** to magnify the center of the picture. Press the key repeatedly until the picture size is suitable for your need.
  2. Use the directional arrows ( $\blacktriangle$ ,  $\blacktriangledown$ ,  $\blacktriangleleft$ ,  $\blacktriangleright$ ) on the projector or remote control to navigate the picture.
  3. To restore the picture to its original size, press **AUTO**. You can also press **D. ZOOM -**. When the key is pressed again, the picture is further reduced until it is restored to the original size.
- Using the OSD menu
  1. Press **MENU/EXIT** and then press  $\blacktriangleleft$  /  $\blacktriangleright$  until the **DISPLAY** menu is highlighted.
  2. Press  $\blacktriangledown$  to highlight **Digital Zoom** and press **Mode/enter**. The Zoom bar displays.

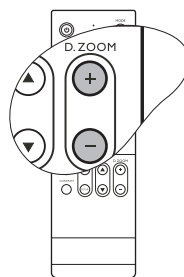

**The picture can only be navigated after the picture is magnified. You can further magnify the picture while searching for details.**

3. Press **▲** repeatedly to magnify the picture to a desired size.
4. To navigate the picture, press **Mode/enter** to switch to the panning mode and press the directional arrows (**▲**, **▼**, **◀**, **▶**) on the projector or remote control to navigate the picture.
5. To reduce size of the picture, press **Mode/enter** to switch back to the zoom in/out function, and press **AUTO** to restore the picture to its original size. You can also press **▼** repeatedly until it is restored to the original size.

## Selecting the aspect ratio

The 'aspect ratio' is the ratio of the image width to the image height. Most analog TV and computers are in 4:3 ratio, and digital TV and DVDs are usually in 16:9 ratio.

With the advent of digital signal processing, digital display devices like this projector can dynamically stretch and scale the image output to a different aspect than that of the image input source.

To change the projected picture ratio (no matter what aspect the source is):

- Using the remote control
  1. Press **ASPECT** to show the current setting.
  2. Press **ASPECT** repeatedly to select an aspect ratio to suit the format of the video signal and your display requirements.
- Using the OSD menu
  1. Press **MENU/EXIT** and then press **◀/▶** until the **DISPLAY** menu is highlighted.
  2. Press **▼** to highlight **Aspect Ratio**.
  3. Press **◀/▶** to select an aspect ratio to suit the format of the video signal and your display requirements.

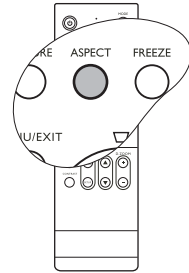

## About the aspect ratio

 In the pictures below, the black portions are inactive areas and the white portions are active areas.

1. **4:3:** Scales an image so that it is displayed in the center of the screen with a 4:3 aspect ratio. This is most suitable for 4:3 images like computer monitors, standard definition TV and 4:3 aspect DVD movies, as it displays them without aspect alteration.

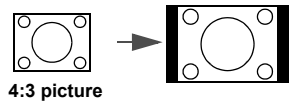

2. **16:9:** Scales an image so that it is displayed in the center of the screen with a 16:9 aspect ratio. This is most suitable for images which are already in a 16:9 aspect, like high definition TV, as it displays them without aspect alteration.

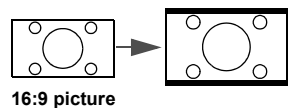

3. **Auto:** Scales an image proportionally to fit the projector's native resolution in its horizontal or vertical width. This is suitable for the incoming image which is in 4:3, 16:9, or 16:10 and you want to make most use of the screen without altering the image's aspect ratio.

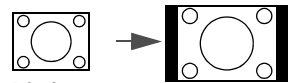

4:3 picture

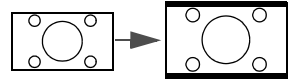

16:9 picture

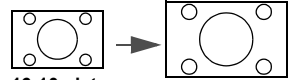

16:10 picture

4. **Real:** The image is projected as its original resolution, and resized to fit within the display area. For input signals with lower resolutions, the projected image will display smaller than if resized to full screen. You could adjust the zoom setting or move the projector towards the screen to increase the image size if necessary. You may also need to refocus the projector after making these adjustments.



4:3 picture



OSD menus can be displayed on those unused black areas.

# Optimizing the image

## Using Wall Color

In the situation where you are projecting onto a colored surface such as a painted wall which may not be white, the Wall Color feature can help correct the projected picture's color to prevent possible color difference between the source and projected pictures.

To use this function, go to the **DISPLAY > Wall Color** menu and press ◀/▶ to select a color which is the closest to the color of the projection surface. There are several precalibrated colors to choose from: **Light Yellow, Pink, Light Green, Blue,** and **Blackboard**

## Selecting a picture mode

The projector is preset with several predefined picture modes so that you can choose one to suit your operating environment and input source picture type.

To select a operation mode that suits your need, you can follow one of the following steps.

- Press **Mode/enter** on the projector or **MODE** on the remote control repeatedly until your desired mode is selected.
- Go to the **PICTURE > Picture Mode** menu and press ◀/▶ to select a desired mode.

The picture modes available for different types of signals are listed below.

### PC Signal Input

1. **Dynamic mode (Default):** Maximizes the brightness of the projected image. This mode is suitable for environments where extra-high brightness is required, such as using the projector in well lit rooms.
2. **Presentation mode:** Is designed for presentations. The brightness is emphasized in this mode to match PC and notebook coloring.
3. **sRGB mode:** Maximizes the purity of RGB colors to provide true-to-life images regardless of brightness setting. It is most suitable for viewing photos taken with an sRGB compatible and properly calibrated camera, and for viewing PC graphic and drawing applications such as AutoCAD.
4. **Cinema mode:** Is appropriate for playing colorful movies, video clips from digital cameras or DVs through the PC input for best viewing in a blackened (little light) environment.
5. **User 1/User 2 mode:** Recalls the settings customized based on the current available picture modes. See "[Setting the User 1/User 2 mode](#)" on page 38 for details.

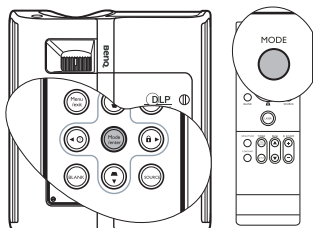

**NOTE: A slight variation in the picture brightness and colors may be observed during the very short time of switching picture modes.**

## YPbPr/S-Video/Video/HDMI Signal Input

1. **Dynamic mode:** Is suitable for playing gamebox-based video games in a normal living room lighting level environment.
2. **Standard mode (Default):** Is appropriate for viewing colorful movies, video clips from digital cameras or DVs.
3. **Cinema mode:** Is suitable for enjoying dark movies or DVD movies best viewed in a blackened (little light) home cinema or lounge room environment.
4. **User 1/User 2 mode:** Recalls the settings customized based on the current available picture modes. See "[Setting the User 1/User 2 mode](#)" on page 38 for details.

## Setting the User 1/User 2 mode

There are two user-definable modes if the current available picture modes are not suitable for your need. You can use one of the picture modes (except the **User 1/2**) as a starting point and customize the settings.

1. Press **MENU/EXIT** to open the On-Screen Display (OSD) menu.
2. In the **PICTURE** menu, highlight **Picture Mode** and press **◀/▶** to select **User 1** or **User 2**.
3. Press **▼** to highlight **Reference Mode**.

 **This function is only available when User 1, or User 2 mode is selected up in the Picture Mode sub-menu item.**

4. Press **◀/▶** to select an picture mode that is closest to your need.
5. Press **▼** to select a menu item to be changed and adjust the value with **◀/▶**. See "[Fine-tuning the image quality in user modes](#)" below for details.
6. When all settings have been done, highlight **Save Settings** and press **Mode/enter** on the projector or **ENTER** on the remote control to store the settings.
7. The confirmation message '**Setting Saved**' displays.

## Fine-tuning the image quality in user modes

According to the detected signal type, there are some user-definable functions available when **User 1** or **User 2** is selected. You can make adjustments to these functions based on your needs.

### Adjusting Brightness

Press **BRIGHTNESS** on the remote control or highlight **Brightness** in the **PICTURE** menu and adjust the values by pressing **◀/▶** on the projector or remote control.



The higher the value, the brighter the image. And lower the setting, darker the image. Adjust this control so the black areas of the image appear just as black and that detail in the dark areas is visible.

### Adjusting Contrast

Press **CONTRAST** on the remote control or highlight **Contrast** in the **PICTURE** menu and adjust the values by pressing **◀/▶** on the projector or remote control.



The higher the value, the greater the contrast. Use this to set the peak white level after you have previously adjusted the Brightness setting to suit your selected input and viewing environment.

## Adjusting Color

Highlight **Color** in the **PICTURE** menu and adjust the values by pressing ◀/▶ on the projector or remote control.

Lower setting produces less saturated colors; setting to the minimum value makes the image black and white. If the setting is too high, colors on the image will be overpowering, which makes the image unrealistic.

## Adjusting Tint

Highlight **Tint** in the **PICTURE** menu and adjust the values by pressing ◀/▶ on the projector or remote control.

The higher the value, the more reddish the picture becomes. The lower the value, the more greenish the picture becomes.

## Adjusting Sharpness

Highlight **Sharpness** in the **PICTURE** menu and adjust the values by pressing ◀/▶ on the projector or remote control.

The higher the value, the sharper the picture becomes. The lower the value, the softer the picture becomes.

## Adjusting Brilliant Color

Highlight **Brilliant Color** in the **PICTURE** menu and select by pressing ◀/▶ on the projector or remote control.

This feature utilizes a new color-processing algorithm and system level enhancements to enable higher brightness while providing truer, more vibrant colors in picture. It enables a greater than 50% brightness increase in mid-tone images, which are common in video and natural scenes, so the projector reproduces images in realistic and true colors. If you prefer images with that quality, select **On**. If you don't need it, select **Off**.

**On** is the default and recommended selection for this projector. When **Off** is selected, the **Color Temperature** function is not available.

## Selecting a color temperature

Highlight **Color Temperature** in the **PICTURE** menu and adjust the values by pressing ◀/▶ on the projector or remote control.

There are four color temperature\* settings available.

1. **T1:** With the highest color temperature, T1 makes the image appear the most bluish white than other settings.
2. **T2:** Makes images appear bluish white.
3. **T3:** Maintains normal colorings for white.
4. **T4:** Makes images appear reddish white.

### \*About color temperatures:

There are many different shades that are considered to be "white" for various purposes. One of the common methods of representing white color is known as the "color temperature". A white color with a low color temperature appears to be reddish white. A white color with a high color temperature appears to have more blue in it.



## 3D Color Management

In most installation situations, color management will not be necessary, such as in classroom, meeting room, or lounge room situations where lights remain on, or where building external windows allow daylight into the room.

Only in permanent installations with controlled lighting levels such as boardrooms, lecture theaters, or home theaters, should color management be considered. Color management provides fine color control adjustment to allow for more accurate color reproduction, should you require it.

Proper color management can only be achieved under controlled and reproducible viewing conditions. You will need to use a colorimeter (color light meter), and provide a set of suitable source images to measure color reproduction. These tools are not provided with the projector, however, your projector supplier should be able to provide you with suitable guidance, or even an experienced professional installer.

The Color Management provides six sets (RGBCMY) of colors to be adjusted. When you select each color, you can independently adjust its range and saturation according to your preference.

If you have purchased a test disc which contains various color test patterns and can be used to test the color presentation on monitors, TVs, projectors, etc. You can project any image from the disc on the screen and enter the **3D Color Management** menu to make adjustments.

To adjust the settings:

1. Go to the **PICTURE** menu and highlight **3D Color Management**.
2. Press **Mode/enter** on the projector or **ENTER** on the remote control and the **3D Color Management** page displays.
3. Highlight **Primary Color** and press **◀/▶** to select a color from among Red, Yellow, Green, Cyan, Blue, or Magenta.
4. Press **▼** to highlight **Hue** and press **◀/▶** to select its range. Increase in the range will include colors consisted of more proportions of its two adjacent colors.

Please refer to the illustration to the right for how the colors relate to each other.

For example, if you select Red and set its range at 0, only pure red in the projected picture will be selected. Increasing its range will include red close to yellow and red close to magenta.

5. Press **▼** to highlight **Saturation** and adjust its values to your preference by pressing **◀/▶**. Every adjustment made will reflect to the image immediately.  
For example, if you select Red and set its value at 0, only the saturation of pure red will be affected.

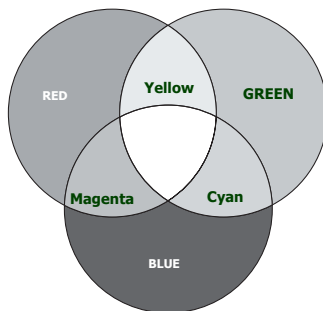

**☞ Saturation is the amount of that color in a video picture. Lower settings produce less saturated colors; a setting of “0” removes that color from the image entirely. If the saturation is too high, that color will be overpowering and unrealistic.**

- Press ▼ to highlight **Gain** and adjust its values to your preference by pressing ◀/▶ . The contrast level of the primary color you select will be affected. Every adjustment made will reflect to the image immediately.
- Repeat steps 3 to 6 for other color adjustments.
- Make sure you have made all of the desired adjustments.
- Press **MENU/EXIT** to exit and save the settings.

## Setting the presentation timer

Presentation timer can indicate the presentation time on the screen to help you achieve better time management when giving presentations. Follow these steps to utilize this function:

- Press **TIMER SETUP** on the remote control or go to the **SYSTEM SETUP: Basic > Presentation Timer** menu and press **Mode/enter** to display the **Presentation Timer** page.
- Highlight **Timer Period** and decide the time period by pressing ◀/▶ . The length of time can be set from 1 to 5 minutes in 1-minute increments and 5 to 240 minutes in 5-minute increments.

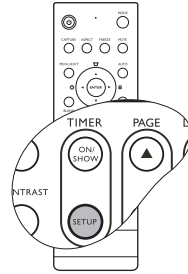

 **If the timer is already on, the timer will restart whenever the Timer Period is reset.**



- Press ▼ to highlight **Timer Display** and choose if you want the timer to show up on the screen by pressing ◀/▶ .

Selection	Description
Always	Displays the timer on screen throughout the presentation time.
1 min/2 min/3 min	Displays the timer on screen in the last 1/2/3 minute(s).
Never	Hides the timer throughout the presentation time.

- Press ▼ to highlight **Timer Position** and set the timer position by pressing ◀/▶ .  
**Top-Left → Bottom-Left → Top-Right → Bottom-Right**

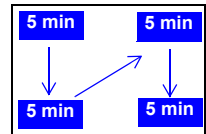

- Press ▼ to highlight **Timer Counting Direction** and select your desired counting direction by pressing ◀/▶ .

Selection	Description
Count Up	Increases from 0 to the preset time.
Count down	Decreases from the preset time to 0.

- Press ▼ to highlight **Timer Audible Reminder** and decide if you want to activate sound reminder by pressing ◀/▶ . If you select **On**, a double beep sound will be heard at the last 30 seconds of counting down/up, and a triple beep sound will be produced when the timer is up.

7. To activate the presentation timer, press ▼ and press ◀/▶ to highlight **On** and press **Mode/enter**.
8. A confirmation message displays. Highlight **Yes** and press **Mode/enter** on the projector or **ENTER** on the remote control to confirm. You will see the message “**Timer is On**” displaying on the screen. The timer start counting at the time the timer is on.

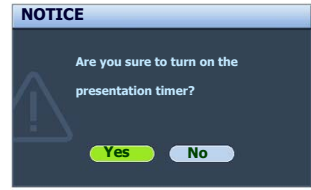

**To cancel the timer, perform the following steps.**

- Using the remote control

Press **TIMER ON/SHOW** and press ◀/▶ to highlight **Off** and press **ENTER**.

- Using the OSD menu

1. Enter the **SYSTEM SETUP: Basic > Presentation Timer** menu and highlight **Off**. Press **Mode/enter**. A confirmation message displays.
2. Highlight **Yes** and press **Mode/enter** to confirm. You will see the message “**Timer is Off**” displaying on the screen.

**How to use the TIMER ON/SHOW button?**

The button is a multi-functional key.

- If the presentation timer is off, pressing this button displays a confirmation message. You can decide whether to activate the timer or not by following the on-screen instruction.
- If the timer is already on, pressing this button displays a confirmation message. You can decide whether to restart, continue or turn off the timer by following the on-screen instruction.

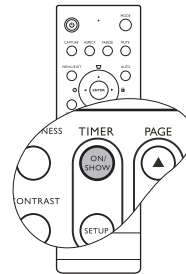



## Remote paging operations

Connect the projector to your PC or notebook with a USB cable prior to using the paging function. See “[Connecting a computer](#)” on page 21 for details.

You can operate your display software program (on a connected PC) which responds to page up/down commands (like Microsoft PowerPoint) by pressing **PAGE ▲/▼** on the remote control.

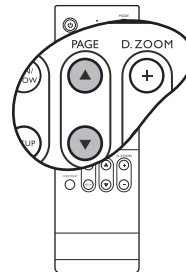
If remote paging function doesn't work, check if the USB connection is correctly made and the mouse driver on your computer is updated to the latest version.



 **The remote paging function cannot work with Microsoft® Windows®98 operating system. Windows®XP or higher operating systems are recommended.**

## Hiding the image

In order to draw the audience's full attention to the presenter, you can use **BLANK** on the projector or remote control to hide the screen image. The word '**BLANK**' appears in the corner of the screen while the image is hidden. When this function is activated with an audio input connected, the audio can still be heard.

You can set the blank time in the **SYSTEM SETUP: Basic > Blank Timer** menu to let the projector return the image automatically after a period of time when there is no action taken on the blank screen. The length of time can be set from 5 to 30 minutes in 5-minute increments.

If the preset time spans are not suitable for your personation, select **Disable**.

No matter **Blank Timer** is activated or disabled, you can press any key except **PAGE ▲/▼** and **LASER** on the remote control to restore the picture.

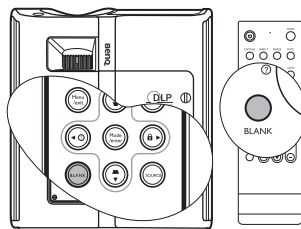

Once **BLANK** is pressed, the projector lamp enters **Economic mode** automatically.

⚠ **Do not block the projection lens from projecting as this could cause the blocking object to become heated and deformed or even cause a fire.**

## Freezing the image

Press **FREEZE** on the remote control to freeze the image. The word '**FREEZE**' will display in the upper left corner of the screen. To release the function, press any button on the projector or remote control.

Even if an image is frozen on the screen, the pictures are running on the video or other device. If the connected devices have active audio output, you will still hear the audio even though the image is frozen onscreen.

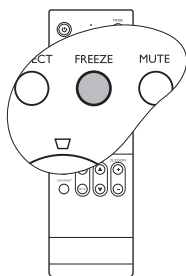

# Utilizing FAQ function

The **INFORMATION** menu contains possible solutions to problems encountered by users regarding image quality, installation, special feature operation and service information.

To get the FAQ information:

1. Press **◀ / ?** on the projector or remote control or press **MENU/EXIT** to open the OSD menu and press **◀ / ▶** to highlight the **INFORMATION** menu.
2. Press **▼** to select **FAQ-Image and Installation** or **FAQ-Features and Service** based on the information you want to know.
3. Press **Mode/enter** on the projector or **ENTER** on the remote control.
4. Press **▲ / ▼** to select the a problem and press **Mode/enter** on the projector or **ENTER** on the remote control for possible solutions.

To exit the OSD menu, press **MENU/EXIT**.

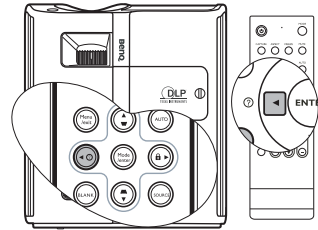

# Locking control keys

With the control keys on the projector locked, you can prevent your projector settings from being changed accidentally (by children, for example). When the **Panel Key Lock** is on, no control keys on the projector will operate except **Power** and **LASER**.

1. Press **▶ / 🔒** on the projector or remote control or go to the **SYSTEM SETUP: Basic > Panel Key Lock** menu, and select **On** by pressing **◀ / ▶** on the projector or remote control. A confirmation message displays.
2. Highlight **Yes** and press **Mode/enter** on the projector or **ENTER** on the remote control to confirm.

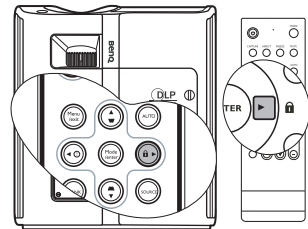

To release panel key lock, press and hold **▶ / 🔓** on the remote control or projector for 3 seconds.

You can also use the remote control to enter the **SYSTEM SETUP: Basic > Panel Key Lock** menu and press **◀ / ▶** to select **Off**.

- **Buttons on the remote control are still in use when panel key lock is enabled.**
- **If you press Power to turn off the projector without disabling panel key lock, the projector will still be in locked status the next time it is turned on.**

# Operating in a high altitude environment

We recommend you use the High Altitude Mode when your environment is between 1500 m –3000 m above sea level, and temperature is between 0°C–35°C.

 **Do not use the High Altitude Mode if your altitude is between 0 m and 1500 m and temperature is between 0°C and 35°C. The projector will be over cooled, if you turn the mode on under such condition.**

To activate the High Altitude Mode, go to the **SYSTEM SETUP: Advanced > High Altitude Mode**, select **On** by pressing **◀/▶** on the projector or remote control. A confirmation message displays. Highlight **Yes** and press **Mode/enter** on the projector or **ENTER** on the remote control.

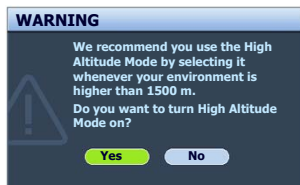

Operation under "**High Altitude Mode**" may cause a higher decibel operating noise level because of increased fan speed necessary to improve overall system cooling and performance.

If you use this projector under other extreme conditions excluding the above, it may display auto shut-down symptoms, which is designed to protect your projector from over-heating. In cases like this, you should switch to High Altitude mode to solve these symptoms. However, this is not to state that this projector can operate under any and all harsh or extreme conditions.

## Creating your own startup screen

In addition to selecting the projector preset startup screen from among BenQ logo, Black or Blue screen, you can make your own startup screen that is a picture projected from your computer or video source.

To create your own startup screen, project the picture you want to use as your startup screen from either a computer or video source. The rest steps are as follows.

- Using the remote control
  1. Press **CAPTURE** on the remote control.
  2. A confirmation message displays. Press **CAPTURE** or **ENTER** again.
  3. The message '**Screen Capturing...**' displays while the projector is processing the picture. Please wait.
  4. If the action is successful, you see the message '**Captured Succeeded**' on the screen. The captured picture is saved as **My Screen**.
  5. To view the captured picture displayed as the startup screen, set **My Screen** in the **SYSTEM SETUP: Basic > Splash Screen** menu and restart the projector.

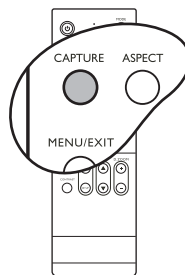

- Using the OSD menu
  1. Press **MENU/EXIT** and then press **◀/▶** until the **SYSTEM SETUP: Basic** menu is highlighted.
  2. Press **▼** to highlight **My Screen** and press **Mode/enter**.
  3. Repeat steps 2-5 in the "Using the remote control" section to capture and view the captured picture.

In the unlikely event that the capturing action fails, change your target picture.

## Adjusting the sound

The sound adjustments made as below will have an effect on the projector speaker. Be sure you have made a correct connection to the projector audio input. See ["Connection" on page 21](#) for how the audio input is connected.

### Muting the sound

To temporarily turn off the sound,

1. Press **MENU/EXIT** and then press **◀/▶** until the **SYSTEM SETUP: Advanced** menu is highlighted.
2. Press **▼** to highlight **Audio Settings** and press **Mode/enter** on the projector or **ENTER** on the remote control. The **Audio Settings** page displays.
3. Highlight **Mute** and press **◀/▶** to select **On**.

### Adjusting the sound level

To adjust the sound level,

1. Repeat steps 1-2 above.
2. Press **▼** to highlight **Volume** and press **◀/▶** to select a desired sound level.

### Turning off the Power on/off ring tone

To turn off the ring tone,

1. Repeat steps 1-2 above.
2. Press **▼** to highlight **Power on/off ring tone** and press **◀/▶** to select **Off**.

 **The only way to change Power on/off ring tone is setting On or Off here. Setting the sound mute or changing the sound level will not affect the Power on/off ring tone.**

## Personalizing the projector menu display

The On-Screen Display (OSD) menus can be set according to your preferences. The following settings do not affect the projection settings, operation, or performance.

- **Menu Display Time** in the **SYSTEM SETUP: Advanced > Menu Settings** menu sets the length of time the OSD will remain active after your last button press. The time length ranges from 5 to 30 seconds in 5-second increments. Use **◀/▶** to select a suitable time.
- **Menu Position** in the **SYSTEM SETUP: Advanced > Menu Settings** menu sets the OSD position in five locations. Use **◀/▶** to select a preferred position.
- **Language** in the **SYSTEM SETUP: Basic** menu sets your familiar language for the On-Screen (OSD) Menus. Use **◀/▶** to select your language.
- **Splash Screen** in the **SYSTEM SETUP: Basic** menu sets a preferred logo screen to be displayed during projector start-up. Use **◀/▶** to select a screen.

# Shutting down the projector

1. Press **Power** and a confirmation message will display prompting you.  
If you don't respond in a few seconds, the message will disappear.
2. Press **Power** a second time. The **Power indicator light** flashes orange, the projection lamp shuts down, and the fans will continue to run for approximately 90 seconds to cool down the projector.

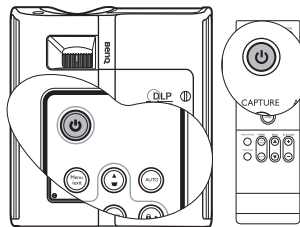

**⚠** To protect the lamp, the projector will not respond to any commands during the cooling process.

To shorten the cooling time, you can also activate the Quick cooling function. See "[Quick Cooling](#)" on page 53 for details.

3. Once the cooling process finishes, a "**Power Off Ring Tone**" will be heard. The Power indicator light is a steady orange and fans stop. Disconnect the power cord from the wall socket.

- **☞** To turn off the power ring tone, see "[Turning off the Power on/off ring tone](#)" on page 46 for details.
- If the projector is not properly shut down, to protect the lamp, when you attempt to re-start the projector, the fans will run for a few minutes to cool down. Press Power again to start the projector after the fans stop and the Power indicator light turns orange.

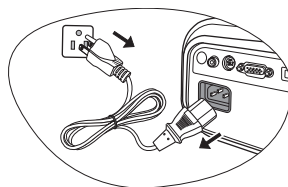



# Menu operation

## Menu system

Please note that the on-screen display (OSD) menus vary according to the signal type selected.

Main menu	Sub-menu	Options	
<b>1. DISPLAY</b>	Wall Color	Off/Light Yellow/Pink/Light Green/Blue/Blackboard	
	Aspect Ratio	4:3/16:9/Auto/Real	
	Keystone		
	Position		
	Phase		
	H. Size		
	Digital Zoom		
<b>2. PICTURE</b>	Picture Mode	PC source: Dynamic/Presentation/sRGB/Cinema/User 1/User 2 Video source: Dynamic/Standard/Cinema/User 1/User 2	
	Reference Mode	PC source: Dynamic/Presentation/sRGB/Cinema Video source: Dynamic/Standard/Cinema	
	Brightness		
	Contrast		
	Color		
	Tint		
	Sharpness		
	Brilliant Color	On/Off	
	Color Temperature	T1/T2/T3/T4	
	3D Color Management	Primary Color	R/G/B/Y/C/M/
		Hue	
	3D Color Management	Saturation	
		Gain	
	Save Settings		
<b>3. SOURCE</b>	Quick Auto Search	On/Off	
	Color Space Conversion	RGB/YUV	
<b>6. INFORMATION</b>	FAQ-Image and Installation		
	FAQ-Features and Service		
	Current System Status	<ul style="list-style-type: none"> <li>• Source</li> <li>• Picture Mode</li> <li>• Resolution</li> <li>• Color System</li> <li>• Equivalent Lamp Hour</li> </ul>	

<b>4. SYSTEM SETUP: Basic</b>	<b>Presentation Timer</b>	<b>Timer Period</b>	1~240 minutes
		<b>Timer Display</b>	Always/1 min/2 min/3 min/Never
		<b>Timer Position</b>	Bottom-Right/Top-Right/Bottom-Left/Top-Left
		<b>Timer Counting Direction</b>	Count Down/Count Up
		<b>Timer Audible Reminder</b>	<b>On/Off</b>
		<b>On/Off</b>	
	<b>Language</b>	English / Français / Deutsch Italiano / Español / Русский 繁體中文 / 简体中文 / 日本語 / 한국어 / Svenska / Nederlands / Türkçe / Čeština / Português / ភាសាខ្មែរ / Polski	
	<b>Projector Position</b>	Front Table/Rear Table/Rear Ceiling/Front Ceiling	
	<b>Auto Power Off</b>	Disable/5 min/10 min/15 min/20 min/25 min/30 min	
	<b>Blank Timer</b>	Disable/5 min/10 min/15 min/20 min/25 min/30 min	
<b>Panel Key Lock</b>	On/Off		
<b>Timer Controller</b>	Disable/30 min/1 hr/2 hr/3 hr/4 hr/8 hr/12 hr		
<b>Splash Screen My Screen</b>	BenQ/Black/Blue/My Screen		
<b>5. SYSTEM SETUP: Advanced</b>	<b>Quick Cooling</b>	<b>On/Off</b>	
	<b>High Altitude Mode</b>	<b>On/Off</b>	
	<b>Audio Settings</b>	<b>Mute</b>	<b>On/Off</b>
		<b>Volume</b>	
		<b>Power on/off ring tone</b>	<b>On/Off</b>
		<b>Menu Display Time</b>	5 sec/10 sec/15 sec/20 sec/25 sec/30 sec
	<b>Menu Settings</b>	<b>Menu Position</b>	Center/Top-Left/Top-Right/ Bottom-Right/Bottom-Left
		<b>Lamp Mode</b>	<b>Normal/Economic</b>
	<b>Lamp Settings</b>	<b>Reset Lamp Timer</b>	
		<b>Equivalent Lamp Hour</b>	
		<b>Change Password</b>	
	<b>Security Settings</b>	<b>Change Security Settings</b>	
		<b>• Power On Lock</b>	
		<b>• Splash Screen Lock</b>	
	<b>Reset All Settings</b>		

Note that the menu items are available when the projector detects at least one valid signal. If there is no equipment connected to the projector or no signal detected, limited menu items are accessible.

## DISPLAY menu

FUNCTION (default setting/ value)	DESCRIPTION
<b>Wall Color</b> (Off)	Correct the projected picture's color when the projection surface is not white. See <a href="#">"Using Wall Color" on page 37</a> for details.
<b>Aspect Ratio</b> (Auto)	There are four options to set the image's aspect ratio depending on your input signal source. See <a href="#">"Selecting the aspect ratio" on page 35</a> for details.
<b>Keystone</b> (0)	Corrects any keystoneing of the image. See <a href="#">"Correcting keystone" on page 34</a> for details.
<b>Position</b> (0)	Displays the position adjustment page. To move the projected image, use the directional arrow buttons. The values shown on the lower position of the page change with every button press you made until they reach their maximum or minimum.
<b>Phase</b> (depends on the selected input source)	Adjusts the clock phase to reduce image distortion. 
<b>H. Size</b> (depends on the selected input source)	Adjusts the horizontal width of the image.
<b>Digital Zoom</b> (100%)	Magnifies or reduces the projected image. See <a href="#">"Magnifying and searching for details on the projected picture" on page 34</a> for details.

## SOURCE menu

FUNCTION (default setting / value)	DESCRIPTION
<b>Quick Auto Search</b> (On)	See <a href="#">"Switching input signal" on page 32</a> for details.
<b>Color Space Conversion</b> (RGB)	See <a href="#">"Changing Color Space" on page 32</a> for details.

# PICTURE menu

 Some picture adjustments are available only when certain input sources are in use. Unavailable adjustments are not shown on the screen.

FUNCTION (default setting / value)	DESCRIPTION
<b>Picture Mode</b> (PC: <b>Dynamic</b> ; YPbPr/ S-Video/ Video/HDMI: <b>Standard</b> )	Pre-defined picture modes are provided so you can optimize your projector image set-up to suit your program type. See <a href="#">"Selecting a picture mode" on page 37</a> for details.
<b>Reference Mode</b>	Selects an picture mode that most suits your need for the image quality and further fine-tune the image based on the selections listed on the same page below. See <a href="#">"Setting the User 1/User 2 mode" on page 38</a> for details.
<b>Brightness</b>	Adjusts the brightness of the image. See <a href="#">"Adjusting Brightness" on page 38</a> for details.
<b>Contrast</b>	Adjusts the degree of difference between dark and light in the image. See <a href="#">"Adjusting Contrast" on page 38</a> for details.
<b>Color</b> (0)	Adjusts the color saturation level -- the amount of each color in a video image. See <a href="#">"Adjusting Color" on page 39</a> for details.
<b>Tint</b> (0)	Adjusts the red and green color tones of the image. See <a href="#">"Adjusting Tint" on page 39</a> for details.
<b>Sharpness</b> (15)	Adjusts the image to make it look sharper or softer. See <a href="#">"Adjusting Sharpness" on page 39</a> for details.
<b>Brilliant Color</b> (On)	See <a href="#">"Adjusting Brilliant Color" on page 39</a> for details.
<b>Color Temperature</b> (T3)	There are four color temperature settings are available. See <a href="#">"Selecting a color temperature" on page 39</a> for details.
<b>3D Color Management</b>	See <a href="#">"3D Color Management" on page 40</a> for details.
<b>Save Settings</b>	Saves the settings made for <b>User 1</b> or <b>User 2</b> mode.

## SYSTEM SETUP: Basic menu

FUNCTION (default setting / value)	DESCRIPTION
<b>Presentation Timer</b>	Reminds the presenter to finish the presentation within a certain time frame. See " <a href="#">Setting the presentation timer</a> " on page 41 for details.
<b>Language</b>	Sets the language for the On-Screen Display (OSD) menus. See " <a href="#">Using the menus</a> " on page 28 for details.
<b>Projector Position</b> (Front Table)	The projector can be installed on a ceiling or behind a screen, or with one or more mirrors. See " <a href="#">Choosing a location</a> " on page 14 for details.
<b>Auto Power Off</b> (Disable)	This function allows the projector to turn off automatically if no input signal is detected after a set period of time. See " <a href="#">Setting Auto Power Off</a> " on page 56 for details.
<b>Blank Timer</b> (Disable)	Sets the image blank time when the Blank feature is activated, once elapsed the image will return to the screen. See " <a href="#">Hiding the image</a> " on page 43 for details.
<b>Panel Key Lock</b> (Off)	Disables or enables all panel key functions except <b>Power</b> on the projector and buttons on the remote control. See " <a href="#">Locking control keys</a> " on page 44 for details.
<b>Timer Controller</b> (Disable)	Sets the auto-shutdown timer. The timer can be set to a value between 30 minutes and 12 hours.
<b>Splash Screen</b> (BenQ logo)	Allows you to select which logo screen will display during projector start-up. Four options are available: BenQ logo, Black screen, Blue screen or My Screen.
<b>My Screen</b>	Captures and stores the projected picture as My Screen. See " <a href="#">Creating your own startup screen</a> " on page 45 for details.

# SYSTEM SETUP: Advanced menu

FUNCTION (default setting / value)	DESCRIPTION
<b>Quick Cooling (On)</b>	Enables or disables the Quick Cooling function. Selecting <b>On</b> enables the function and projector cooling time will be shortened from a normal 90-second duration to approximately 30 seconds.
<b>High Altitude Mode (Off)</b>	A mode for operation in high altitude areas. See <a href="#">"Operating in a high altitude environment" on page 45</a> for details.
<b>Audio Settings</b>	<b>Mute (Off)</b> <b>Volume (5)</b> <b>Power on/off ring tone (On)</b> See <a href="#">"Adjusting the sound" on page 46</a> for details.
<b>Menu Settings</b>	<b>Menu Display Time (5 sec)</b> Sets the length of time the OSD will remain active after your last button press. The range is from 5 to 30 seconds in 5-second increments. <b>Menu Position (Center)</b> Sets the On-Screen Display (OSD) menu position.
<b>Lamp Settings</b>	<b>Lamp Mode (Normal)</b> Setting the projector in Economic mode also extends the lamp timer automatic shutdown feature. See <a href="#">"Setting Lamp Mode as Economic" on page 56</a> for details. <b>Reset Lamp Timer</b> Once the lamp is renewed, select <b>Reset</b> to return the lamp timer to '0'. See <a href="#">"Resetting the lamp timer" on page 60</a> for details. <b>Equivalent Lamp Hour</b> Displays the number of hours the lamp has been used. See <a href="#">"Getting to know the lamp hour" on page 56</a> for details on how the total lamp hour is calculated.
<b>Security Settings</b>	<b>Change Password</b> You will be asked to enter the current password before changing to a new one. See <a href="#">"Utilizing the password function" on page 29</a> for details. <b>Change Security Settings</b> <b>Power On Lock (Off)</b> <b>Splash Screen Lock (Off)</b> See <a href="#">"Utilizing the password function" on page 29</a> for details.
<b>Reset All Settings</b>	Returns all settings to the factory preset values.  <b>The following settings will still remain: Position, Phase, H. Size, User 1, User 2, Language, Projector Position, High Altitude Mode.</b>

# INFORMATION menu

This menu shows you the current operating status of the projector.

 Some picture adjustments are available only when certain input sources are in use. Unavailable adjustments are not shown on the screen.

FUNCTION	DESCRIPTION
<b>FAQ-Image and Installation</b>	Displays possible solutions to problems you may encounter.
<b>FAQ-Features and Service</b>	
<b>Current System Status</b>	<b>Source</b> Shows the current signal source. <b>Picture mode</b> Shows the selected mode in the <b>PICTURE</b> menu. <b>Resolution</b> Shows the native resolution of the input signal. <b>Color system</b> Shows input system format, NTSC, PAL, SECAM, or RGB. <b>Equivalent Lamp Hour</b> Displays the number of hours the lamp has been used.

# Maintenance

## Care of the projector

Your projector needs little maintenance. The only thing you need to do on a regular basis is to keep the lens clean.

Never remove any parts of the projector except the lamp. Contact your dealer if other parts need replacing.

### Cleaning the lens

Clean the lens whenever you notice dirt or dust on the surface.

- Use a canister of compressed air to remove dust.
- If there is dirt or smears, use lens-cleaning paper or moisten a soft cloth with lens cleaner and gently wipe the lens surface.

 **Never rub the lens with abrasive materials.**

### Cleaning the projector case

Before you clean the case, turn the projector off using the proper shutdown procedure as described in "[Shutting down the projector](#)" on page 47 and unplug the power cord.

- To remove dirt or dust, wipe the case with a soft, lint-free cloth.
- To remove stubborn dirt or stains, moisten a soft cloth with water and a neutral pH detergent. Then wipe the case.

 **Never use wax, alcohol, benzene, thinner or other chemical detergents. These can damage the case.**

### Storing the projector

If you need to store the projector for an extended time, please follow the instructions below:

- Make sure the temperature and humidity of the storage area are within the recommended range for the projector. Please refer to "[Specifications](#)" on page 63 or consult your dealer about the range.
- Retract the adjuster feet.
- Remove the batteries from the remote control.
- Pack the projector in its original packing or equivalent.

### Transporting the projector

It is recommended that you ship the projector with its original packing or equivalent. When you carry the projector yourself, please use the original box or provided soft carry case.



# Lamp information

## Getting to know the lamp hour

When the projector is in operation, the duration (in hours) of lamp usage is automatically calculated by the built-in timer. The method of calculating the equivalent lamp hour is as follows:

Total (equivalent) lamp hour  
= 1 (hours used in Economic mode) + 4/3 (hours used in normal mode)

 See "**Setting Lamp Mode as Economic**" below for more information on **Economic mode**.

The lamp hour in Economic mode is calculated as 3/4 of that in normal mode. That is, using the projector in Economic mode helps to extend the lamp hour by 1/3.

To obtain the lamp hour information:

1. Press **MENU/EXIT** and then press ◀/▶ until the **SYSTEM SETUP: Advanced** menu is highlighted.
2. Press ▼ to highlight **Lamp Settings** and press **Mode/enter**. The **Lamp Settings** page displays.
4. You will see the **Equivalent Lamp Hour** information displaying on the menu.
5. To leave the menu, press **MENU/EXIT**.

You can also get the lamp hour information on the **INFORMATION** menu.

## Extending lamp life

The projection lamp is a consumable item that normally can last up to 3000-4000 hours with proper usage. To keep the lamp life as long as possible, you can do the following settings via the OSD menu.

- **Setting Lamp Mode as Economic**

Using **Economic** mode reduces system noise and power consumption by 20%. If the **Economic** mode is selected, the light output will be reduced and result in darker projected pictures.

Setting the projector in **Economic** mode also extends the lamp operation life. To set **Economic** mode, go into the **SYSTEM SETUP: Advanced > Lamp Settings > Lamp Mode** menu and press ◀/▶.

- **Setting Auto Power Off**

This function allows the projector to turn off automatically if no input source is detected after a set period of time to prevent unnecessary waste of lamp life.

To set **Auto Power Off**, go into the **SYSTEM SETUP: Basic > Auto Power Off** menu and press ◀/▶. The time period can be set from 5 to 30 minutes in 5-minute increments. If the preset time lengths are not suitable for your presentation, select **Disable**. The projector will not automatically shut down in a certain time period.

## Timing of replacing the lamp

When the **Lamp indicator** lights up red or a message appears suggesting it is time to replace the lamp, please install a new lamp or consult your dealer. An old lamp may cause a malfunction in the projector and in some instances the lamp may explode.

 **The Lamp indicator light and Temperature warning light will light up if the lamp becomes too hot. Turn the power off and let the projector cool for 45 minutes. If the Lamp or Temp indicator still lights up after turning the power back on, please contact your dealer. See "Indicators" on page 61 for details.**

The following Lamp warning displays will remind you to change the lamp.

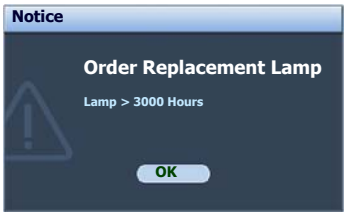
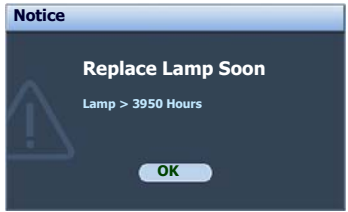
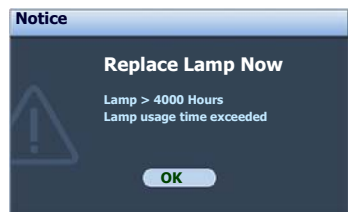
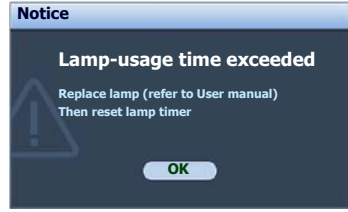
Status	Message
<p>The lamp has been in operation for 3000 hours. Install a new lamp for optimal performance. If the projector is normally run with "Economic Mode" selected (See "<a href="#">Lamp Mode (Normal)</a>" on page 53), you may continue to operate the projector until the 3950 hour lamp warning appears.</p>	
<p>The lamp has been in operation for 3950 hours. A new lamp should be fitted to avoid the inconvenience when the projector runs out of lamp time.</p>	
<p>The lamp has been in operation for 4000 hours. It is strongly recommended that you replace the lamp at this age. The lamp is a consumable item. The lamp brightness diminishes with use. This is normal lamp behavior. You can replace the lamp whenever you notice that the brightness level has significantly diminished. If the lamp is not replaced beforehand, it must be replaced after 3000 hours usage.</p>	
<p>The lamp <b>MUST</b> be replaced before the projector will operate normally.</p>	

## Replacing the lamp



- To reduce the risk of electrical shock, always turn the projector off and disconnect the power cord before changing the lamp.
  - To reduce the risk of severe burns, allow the projector to cool for at least 45 minutes before replacing the lamp.
  - To reduce the risk of injuries to fingers and damage to internal components, use caution when removing lamp glass that has shattered into sharp pieces.
  - To reduce the risk of injuries to fingers and/or compromising image quality by touching the lens, do not touch the empty lamp compartment when the lamp is removed.
  - This lamp contains mercury. Consult your local hazardous waste regulations to dispose of this lamp in a proper manner.
  - To assure optimal performance from the projector, it is recommended that you purchase a BenQ projector lamp for lamp replacement.
  - If lamp replacement is performed while the projector is suspended upside-down from the ceiling, make sure that no one is underneath the lamp socket to avoid any possible injury or damage to the human eyes caused by fractured lamp.
1. Turn the power off and disconnect the projector from the wall socket. If the lamp is hot, avoid burns by waiting for approximately 45 minutes until the lamp has cooled.
  2. Use a coin to turn the screw counterclockwise until the lamp cover loosens.

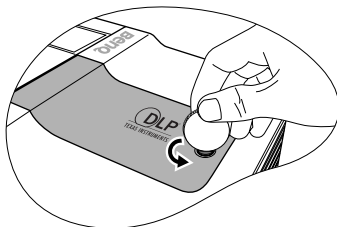

3. Remove the lamp cover from the projector.



- Do not turn the power on with the lamp cover removed.
- Do not insert your fingers between the lamp and the projector. The sharp edges inside the projector may cause injuries.

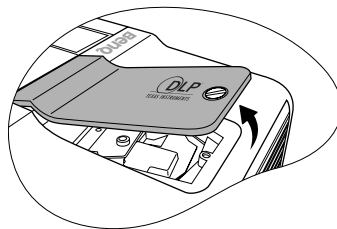

4. Loosen the screw that secures the lamp.

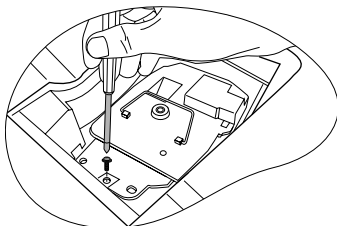

5. Lift the handle so that it stands up. Use the handle to slowly pull the lamp out of the projector.



- **Pulling it too quickly may cause the lamp to break and scatter broken glass in the projector.**
- **Do not place the lamp in locations where water might splash on it, children can reach it, or near flammable materials.**
- **Do not insert your hands into the projector after the lamp is removed. If you touch the optical components inside, it could cause color unevenness and distortion of the projected images.**

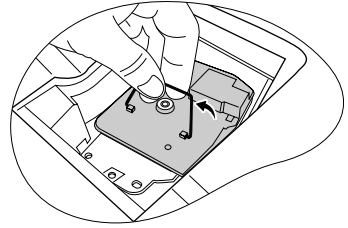

6. As shown in the figure, lower the new lamp first into the connector on the projector and align the two holes on the projector.

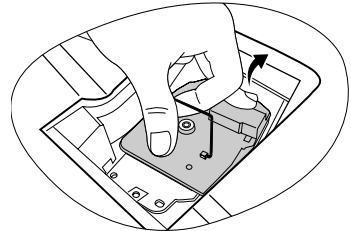

7. Tighten the screw that secures the lamp.



- **Loose screw may cause a bad connection, which could result in malfunction.**
- **Do not over tighten the screw.**

8. Ensure the handle is fully laid flat and locked in place.

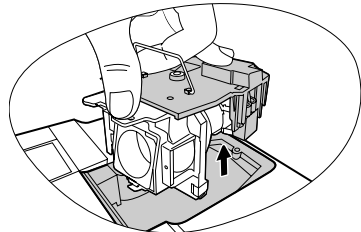

9. Replace the lamp cover on the projector.

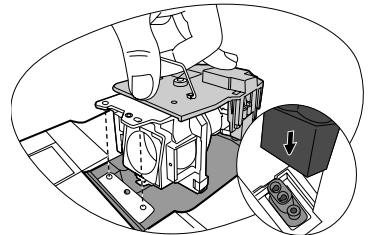

10. Use a coin to turn the screw clockwise until the lamp cover is secured.



- **Loose screw may cause a bad connection, which could result in malfunction.**
- **Do not over tighten the screw.**

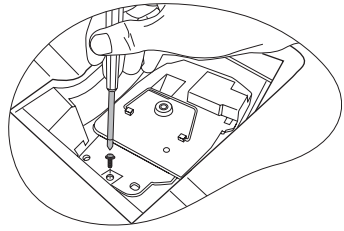

11. Restart the projector.



- **Do not turn the power on with the lamp cover removed.**

### Resetting the lamp timer

12. After the startup logo, open the On-Screen Display (OSD) menu. Go to the **SYSTEM SETUP: Advanced > Lamp Settings** menu. Press **Mode/enter** on the projector or **ENTER** on the remote control. The **Lamp Settings** page displays. Highlight **Reset Lamp Timer**. A warning message displays asking if you want to reset the lamp timer. Highlight **Reset** and press **Mode/enter** on the projector or **ENTER** on the remote control. The lamp time will be reset to '0'.

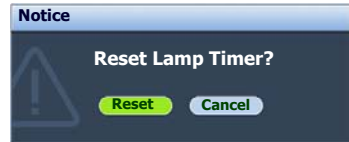

- **Do not reset if the lamp is not new or replaced as this could cause damage.**

# Indicators

Light			Status & Description
Power	Temp	Lamp	
<b>Power events</b>			
<b>Orange</b>	<b>Orange</b>	<b>Orange</b>	The projector has just been connected to a power outlet or the lamp door is open.
<b>Orange</b>	<b>Off</b>	<b>Off</b>	Stand-by mode.
<b>Green Flashing</b>	<b>Off</b>	<b>Off</b>	Powering up.
<b>Green</b>	<b>Off</b>	<b>Off</b>	Normal operation.
<b>Orange Flashing</b>	<b>Off</b>	<b>Off</b>	<ol style="list-style-type: none"> <li>The projector needs 90 seconds to cool down as it was abnormally shut down without the normal cooling down process. <b>Or</b></li> <li>The projector needs to cool for 90 seconds after the power is turned off.</li> </ol>
<b>Orange Flashing</b>	<b>Off</b>	<b>Off</b>	The projector has shutdown automatically. If you try to re-start the projector, it will shutdown again. Please contact your dealer for assistance.
<b>Lamp events</b>			
<b>Orange Flashing</b>	<b>Off</b>	<b>Red</b>	The projector has shutdown automatically. If you try to re-start the projector, it will shutdown again. Please contact your dealer for assistance.
<b>Off</b>	<b>Off</b>	<b>Red</b>	<ol style="list-style-type: none"> <li>The projector needs 90 seconds to cool down. <b>Or</b></li> <li>Please contact your dealer for assistance.</li> </ol>
<b>Thermal events</b>			
<b>Off</b>	<b>Red</b>	<b>Off</b>	The projector has shutdown automatically. If you try to re-start the projector, it will shutdown again. Please contact your dealer for assistance.
<b>Off</b>	<b>Red</b>	<b>Red</b>	
<b>Off</b>	<b>Red</b>	<b>Green</b>	
<b>Off</b>	<b>Red</b>	<b>Orange</b>	
<b>Red</b>	<b>Red</b>	<b>Red</b>	
<b>Red</b>	<b>Red</b>	<b>Green</b>	
<b>Red</b>	<b>Red</b>	<b>Orange</b>	
<b>Green</b>	<b>Red</b>	<b>Red</b>	
<b>Green</b>	<b>Red</b>	<b>Green</b>	
<b>Green</b>	<b>Red</b>	<b>Orange</b>	
<b>Orange</b>	<b>Red</b>	<b>Red</b>	
<b>Orange</b>	<b>Red</b>	<b>Green</b>	
<b>Orange</b>	<b>Red</b>	<b>Orange</b>	
<b>Off</b>	<b>Green</b>	<b>Red</b>	
<b>Off</b>	<b>Green</b>	<b>Green</b>	

# Troubleshooting

## ① The projector does not turn on.

Cause	Remedy
There is no power from the power cable.	Plug the power cord into the AC inlet on the projector, and plug the power cord into the power outlet. If the power outlet has a switch, make sure that it is switched on.
Attempting to turn the projector on again during the cooling process.	Wait until the cooling down process has completed.

## ① No picture

Cause	Remedy
The video source is not turned on or connected correctly.	Turn the video source on and check that the signal cable is connected correctly.
The projector is not correctly connected to the input source device.	Check the connection.
The input signal has not been correctly selected.	Select the correct input signal with the <b>SOURCE</b> key on the projector or remote control.
The lens cover is still closed.	Open the lens cover.

## ① Blurred image

Cause	Remedy
The projection lens is not correctly focused.	Adjust the focus of the lens using the focus ring.
The projector and the screen are not aligned properly.	Adjust the projection angle and direction as well as the height of the unit if necessary.
The lens cover is still closed.	Open the lens cover.

## ① Remote control does not work

Cause	Remedy
The batteries are out of power.	Replace the batteries with new ones.
There is an obstacle between the remote control and the projector.	Remove the obstacle.
You are too far away from the projector.	Stand within 8 meters (26 feet) of the projector.

## ① The password is incorrect

Cause	Remedy
You do not remember the password.	Please see " <a href="#">Entering the password recall procedure</a> " on page 31 for details.

# Specifications

## Projector specifications

 All specifications are subject to change without notice.

### Optical

Resolution  
1280 x 800 WSGA

Display system  
1-CHIP DMD

Lens F/Number  
F=2.4 to 2.58, f= 22.3 to 26.06 mm

Lamp  
200 W lamp

### Electrical

Power supply  
AC100–240V, 3.2A, 50-60 Hz (Automatic)

Power consumption  
285 W (Max); 5 W (Standby)

### Mechanical

Weight  
7.7 lbs (3.5 Kg)

### Output terminals

Speaker  
(Stereo) 2 watt x 1

12VDC (Max. 1A)

### Control

USB serial control  
Type mini B

RS-232 serial control  
Mini Din 8 pin x 1

### Input terminals

Computer input  
RGB input  
D-Sub 15-pin (female) x 1

Video signal input  
S-VIDEO  
Mini DIN 4-pin port x 1

VIDEO  
RCA jack x 1

SD/HDTV signal input  
Analog - Component RCA jack x 3  
(through RGB input)

Analog - Component RCA jack x 3  
Digital - HDMI V1.2 x 1

Audio signal input  
Audio in  
PC audio jack

### Environmental Requirements

Operating temperature  
0°C–40°C at sea level

Operating relative humidity  
10%–90% (without condensation)

Operating altitude  
0–1499 m at 0°C–35°C  
1500–3000 m at 0°C–30°C (with  
High Altitude Mode on)



# Dimensions

274.87 mm (W) x 131.30 mm (H) x 304.99 mm (D)

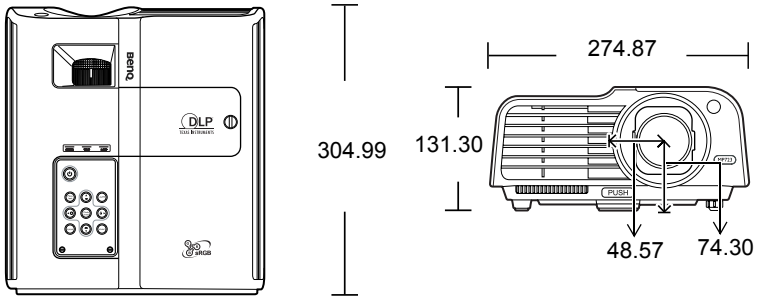

# Timing chart

## Supported timing for PC input

Resolution	Horizontal Frequency (kHz)	Vertical Frequency (Hz)	Pixel Frequency (MHz)	Mode
640 x 480	31.469	59.940	25.175	VGA_60
	37.861	72.809	31.500	VGA_72
	37.500	75.000	31.500	VGA_75
	43.269	85.008	36.000	VGA_85
720 x 400	31.469	70.087	28.3221	720 x 400_70
800 x 600	37.879	60.317	40.000	SVGA_60
	48.077	72.188	50.000	SVGA_72
	46.875	75.000	49.500	SVGA_75
	53.674	85.061	56.250	SVGA_85
1024 x 768	48.363	60.004	65.000	XGA_60
	56.476	70.069	75.000	XGA_70
	60.023	75.029	78.750	XGA_75
	68.667	84.997	94.500	XGA_85
1280 x 768	47.77	60.09	80.768	WXGA_1
1280 x 800	49.65	59.96	83.458	WXGA_2
1280 x 1024	63.981	60.020	108.000	SXGA3_60
	63.981	60.020	108.000	SXGA_60
	79.976	75.025	135.000	SXGA_75
1280 x 960	60.000	60.000	108	1280 x 960_60
	85.938	85.002	148.50	1280 x 960_85
640 x 480@67Hz	35.000	66.667	30.240	MAC13
832 x 624@75Hz	49.722	74.546	57.280	MAC16
1024 x 768@75Hz	60.241	75.020	80.000	MAC19
1152 x 870@75Hz	68.587	74.959	100.00	MAC21
1440 x 900	55.935	59.887	106.50	WXGA+_60
	70.635	74.984	136.75	WXGA+_75
1400 x 1050	65.317	59.978	121.75	SXGA+_60

## Supported timing for Component-YPbPr input

Signal Format	Horizontal Frequency (kHz)	Vertical Frequency (Hz)
480i(525i)@60Hz	15.73	59.94
480p(525p)@60Hz	31.47	59.94
576i(625i)@50Hz	15.63	50.00
576p(625p)@50Hz	31.25	50.00
720p(750p)@60Hz	45.00	60.00
720p(750p)@50Hz	37.50	50.00
1080i(1125i)@60Hz	33.75	60.00
1080i(1125i)@50Hz	28.13	50.00

## Supported timing for Video and S-Video inputs

Video mode	Horizontal Frequency (kHz)	Vertical Frequency (Hz)	Color sub-carrier Frequency (MHz)
NTSC	15.73	60	3.58
PAL	15.63	50	4.43
SECAM	15.63	50	4.25 or 4.41
PAL-M	15.73	60	3.58
PAL-N	15.63	50	3.58
PAL-60	15.73	60	4.43
NTSC4.43	15.73	60	4.43

## Supported timing for HDMI (HDCP) input

Resolution	Horizontal Frequency (kHz)	Vertical Frequency (Hz)	Pixel Frequency (MHz)	Mode
720 x 400	31.469	70.087	28.3221	720 x 400_70
640 x 480	31.469	59.940	25.175	VGA_60
	37.861	72.809	31.500	VGA_72
	37.500	75.000	31.500	VGA_75
	43.269	85.008	36.000	VGA_85
800 x 600	37.879	60.317	40.000	SVGA_60
	48.077	72.188	50.000	SVGA_72
	46.875	75.000	49.500	SVGA_75
	53.674	85.061	56.250	SVGA_85
1024 x 768	48.363	60.004	65.000	XGA_60
	56.476	70.069	75.000	XGA_70
	60.023	75.029	78.750	XGA_75
	68.667	84.997	94.500	XGA_85
1280 x 768	47.77	60.09	79.500	WXGA_1
1280 x 800	49.65	59.96	83.500	WXGA_2
1280 x 1024	63.981	60.020	108.000	SXGA_60
	79.976	75.025	135.000	SXGA_75
640 x 480@67Hz	35.000	66.667	30.240	MAC13
832 x 624@75	49.722	74.546	57.280	MAC16
1024 x 768@75Hz	60.241	75.020	80.000	MAC19
1152 x 870@75Hz	68.587	74.959	100.000	MAC21
1440 x 900	55.935	59.887	106.50	WXGA+_60
	70.635	74.984	136.75	WXGA+_75
1400 x 1050	65.317	59.978	121.75	SXGA+_60
Video (HDCP)	31.47	60	27	480p
	31.25	50	27.000	576p
	37.50	50	74.25	720p_50
	45.00	60	74.25	720P_60
	33.75	60	74.25	1035i
	67.5	60	148.5	1035p
	28.13	50	74.25	1080i_50
	33.75	60	74.25	1080i_60
67.5	60	148.5	1080p	

# Warranty and Copyright information

## Limited warranty

BenQ warrants this product against any defects in material and workmanship, under normal usage and storage.

Proof of purchase date will be required with any warranty claim. In the event this product is found to be defective within the warranty period, BenQ's only obligation and your exclusive remedy shall be replacement of any defective parts (labor included). To obtain warranty service, immediately notify the dealer from which you purchased the product of any defects.

Important: The above warranty shall be void if the customer fails to operate the product in accordance with BenQ's written instructions, especially the ambient humidity must be in-between 10% and 90%, temperature in-between 0°C and 35°C, altitude lower than 4920 feet, and avoiding to operate the projector in a dusty environment. This warranty gives you specific legal rights, and you may have other rights which vary from country to country.

For other information, please visit [www.BenQ.com](http://www.BenQ.com).

## Copyright

Copyright 2007 by BenQ Corporation. All rights reserved. No part of this publication may be reproduced, transmitted, transcribed, stored in a retrieval system or translated into any language or computer language, in any form or by any means, electronic, mechanical, magnetic, optical, chemical, manual or otherwise, without the prior written permission of BenQ Corporation.

## Disclaimer

BenQ Corporation makes no representations or warranties, either expressed or implied, with respect to the contents hereof and specifically disclaims any warranties, merchantability or fitness for any particular purpose. Further, BenQ Corporation reserves the right to revise this publication and to make changes from time to time in the contents hereof without obligation to notify any person of such revision or changes.

\*DLP, Digital Micromirror Device and DMD are trademarks of Texas Instruments. Others are copyrights of their respective companies or organizations.

# Regulation statements

## FCC statement

**CLASS B:** This equipment generates, uses and can radiate radio frequency energy and, if not installed and used in accordance with the instructions, may cause harmful interference to radio communications. However, there is no guarantee that interference will not occur in a particular installation. If this equipment does cause harmful interference to radio or television reception, which can be determined by turning the equipment off and on, the user is encouraged to try to correct the interference by one or more of the following measures:

- Reorient or relocate the receiving antenna.
- Increase the distance between the equipment and receiver.
- Connect the equipment into an outlet on a circuit different from that to which the receiver is connected.
- Consult the dealer or an experienced radio/TV technician for help.

## EEC statement

This machine was tested against the 89/336/EEC (European Economic Community) for EMC (Electronic Magnetic Compatibility) and fulfills these requirements.

## WEEE directive

**Disposal of Waste Electrical and Electronic Equipment by users in private households in the European Union.**

This symbol on the product or on the packaging indicates that this can not be disposed of as household waste. You must dispose of your waste equipment by handing it over to the applicable take-back scheme for the recycling of electrical and electronic equipment. For more information about recycling of this equipment, please contact your city office, the shop where you purchased the equipment or your household waste disposal service. The recycling of materials will help to conserve natural resources and ensure that it is recycled in a manner that protects human health and environment.

